

## SmartLog V5™ Installation, Operation and Maintenance



Made in the  
United States of America



Figure 1. EMIT SmartLog V5™

### Description

The patented\* EMIT SmartLog V5™ system is designed for fast, frequent, and accurate testing of ESD personnel grounding items. Its unique design embeds an ESD tester, time clock, keypad, barcode scanner, Ethernet module and proximity badge reader (optional) into a compact stainless steel enclosure.

By touching the solid-state switch once, the SmartLog V5™ independently tests the resistance path limits of the worn wrist strap and both worn ESD footwear in less than 2 seconds. It may also test a worn ESD garment if it is used as part of personnel grounding path. Test results are electronically stored in the SmartLog V5™ and easily downloaded to a PC for logging records and evaluation. This product can be used as one of the tools to fulfill the ANSI/ESD S20.20 section 7.3 "Compliance Verification Plan."

Paperless data can enhance operator accountability, immediately identifying problems while reducing logging and auditing costs. There is no need to dedicate a computer for each test station. The SmartLog V5™ is a complete system including all required components. Operator identification can be accomplished using the keypad, scanning a barcode badge or waving a proximity badge (verify compatibility with the factory).

The SmartLog V5™ can test either single or dual-wire wrist straps and its split footplate design provides individual footwear testing all in a single test. With the use of TEAM5 Software, the SmartLog V5™ can be programmed to assign unique test requirements to personnel. An individual can be required to test either wrist strap only, footwear only or a combination of the two.

If a resistance path is below or exceeds the set limits, the SmartLog will indicate failure via audio and visual alarms. Use the included relay terminal to promote access control for passed tests.

The SmartLog V5™ can also be networked to a company's Intranet using its embedded Ethernet module. The SmartLog V5™ is calibrated to NIST traceable standards.

### ESD Association Information

"Compliance verification should be performed prior to each use (daily, shift change, etc.). The accumulation of insulative materials may increase the foot grounder system resistance. If foot grounders are worn outside the ESD protected area testing for functionality before reentry to the ESD protected area should be considered." ESD SP9.2 APPENDIX B - Foot Grounder Usage Guidance

"Process monitoring (measurements) shall be conducted in accordance with a Compliance Verification Plan that identifies the technical requirements to be verified, the measurements limits and the frequency at which those verifications shall occur...Compliance verification records shall be established and maintained to provide evidence of conformity to the technical requirements.

The test equipment selected shall be capable of making the measurements defined in the Compliance Verification Plan." (ANSI/ESD S20.20-2007) section 7.3

ANSI/ESD S20.20 Table 1 Flooring-Footwear Systems Technical Requirements Recommended Range "less than 3.5 x 10E7 ohms measured per ANSI/ESD STM 97.1."

"Typical test programs recommend that wrist straps that are used daily should be tested daily. However, if the products that are being produced are of such value that knowledge of a continuous, reliable ground is needed, and then continuous monitoring should be considered or even required." (ESD Handbook ESD TR 20.20 section 5.3.2.4.4)

\*US Patents 6,078,875 and 6,809,522

# Contents

3	<b>System Overview</b>
4	<b>Item and Accessories</b>
4	<b>Packaging</b>
5	<b>Features and Components</b>
6	<b>Installation</b>
6	Clock Configuration
6	Tester Configuration
7	Hardware Setup
8	50771 Turnstile Bracket
10	Relay Terminal
10	Ethernet Setup
11	Direct Connection to PC
11	<b>TEAM5 Software</b>
12	<b>Operation</b>
12	<b>Calibration</b>
13	<b>Specifications</b>
13	<b>Limited Warranty</b>

## System Overview

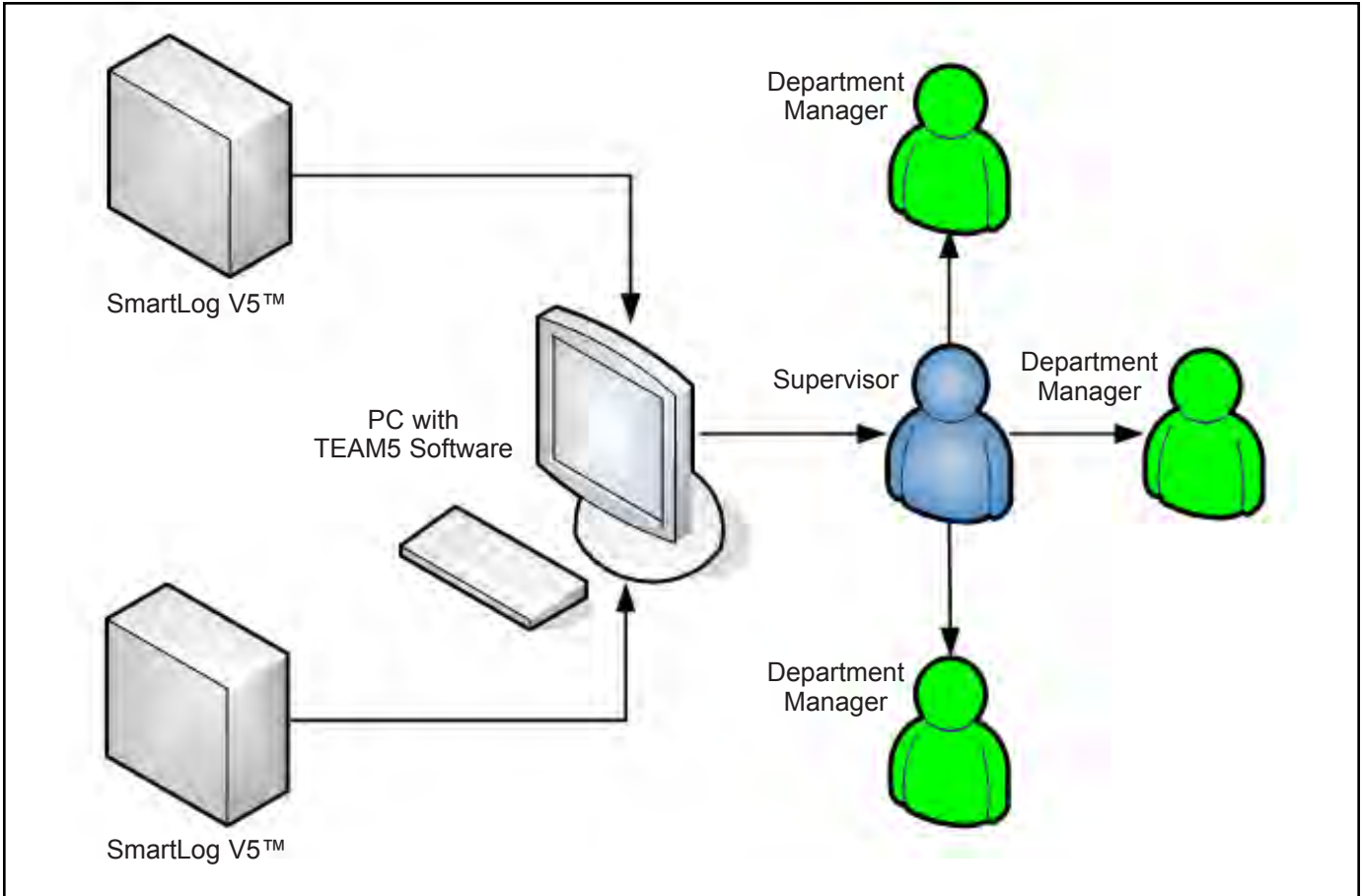

*Illustration of the SmartLog V5™ System collecting and transferring ESD data to a central PC where it is distributed to supervisors and department managers.*

## Items and Accessories

The EMIT SmartLog V5™ is available in four models:

Item	Description
50766	SmartLog V5™, North America
50767	SmartLog V5™, Asia
50768	SmartLog V5™, Europe
50769	SmartLog V5™, Europe, 10mm Adapter

EMIT offers the following accessories for the SmartLog V5™:

Item	Description
50764	Reader, HID ProxPoint Plus 6005
50765	Reader, HID iClass R10
50415	Stand, SmartLog
50773	SmartLog V5™ Turnstile, 120VAC
50772	SmartLog V5™ Turnstile, 220VAC
50771	Turnstile Bracket, SmartLog V5™**
50424	Limit Comparator for Testers

\*\*See page 8 for installation instructions.

Use the SmartLog V5™ along with the TEAM5 Software to automate the collection of employee ESD testing. This software is offered in two tiers: TEAM5 and TEAM5 Enterprise. [Click here](#) to view the TEAM5 Comparison Chart.

Item	Description
50491	TEAM5 Enterprise Software
50493	TEAM5 Software

## Packaging - SmartLog V5™ Test System

- 1 SmartLog V5™
- 1 Mounting Bracket
- 1 Dual Independent Foot Plate
- 1 Foot Plate Cable, 6'
- 1 Power Adapter, 12VDC 1.25A center pos.
- 1 Right Angle Ground Cord
- 1 DB9 Serial Adapter
- 2 Mounting Anchors
- 2 Mounting Screws
- 1 Thumb Screw
- 1 10mm Wrist Cord Adapter (50769 only)
- 1 Certificate of Calibration

# Features and Components

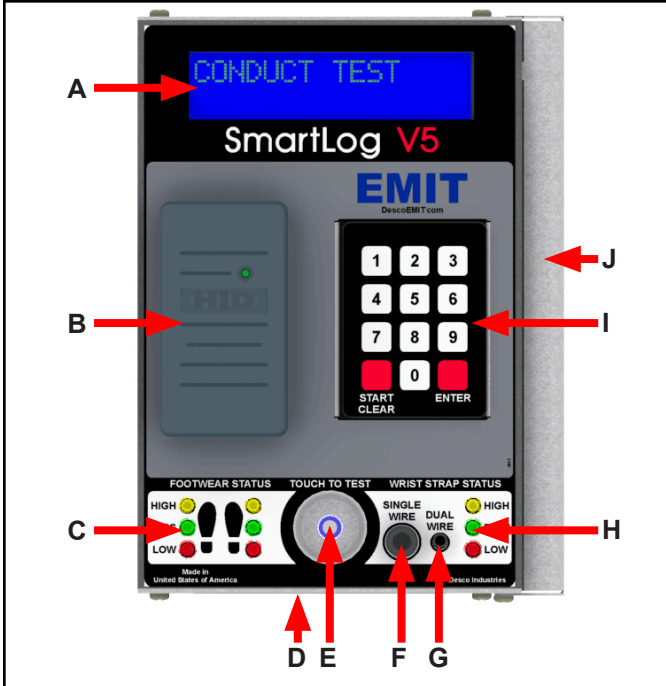

Figure 2. SmartLog V5™ with 50764 proximity reader features and components (front view)

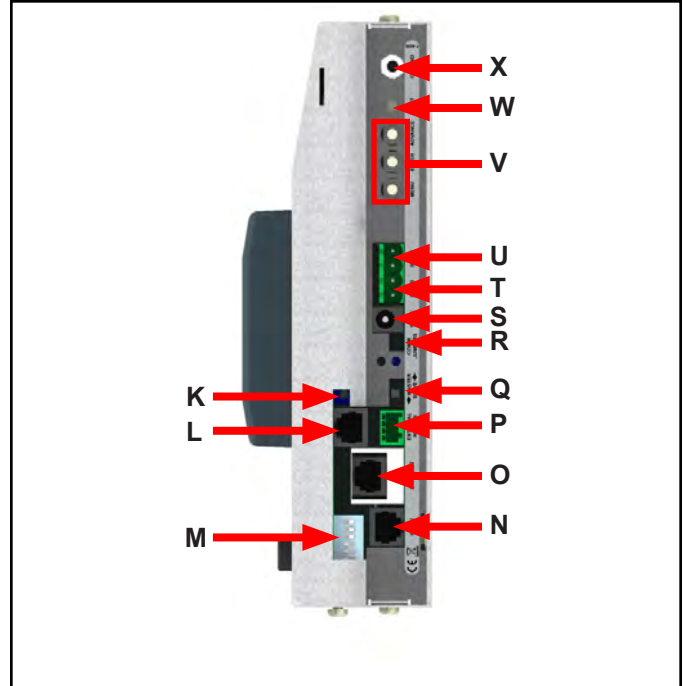

Figure 3. SmartLog V5™ features and components (right view, cover off)

**A. LCD Display:** Displays the time, date, command prompts and test results.

**B. Proximity Reader (Optional):** When equipped with the 50764 or 50765 proximity reader, users can begin their test by waving their proximity badge in front of this reader.

Custom proximity reader interfacing available. Contact EMIT Customer Service for more information.

**C. Footwear Status LEDs:** Displays the footwear test results. The LEDs will blink and warn the operator when the foot plate becomes disconnected from the tester.

**D. CCD Barcode Scanner:** Activate the scanner by placing a badge below the tester. Reads Code 39 and 128 barcode symbologies by default. Other barcode symbologies are available upon request.

**E. Steady-State Test Switch:** Place and hold your finger here to begin the test.

**F. Single-Wire Wrist Strap Jack:** Insert your single-wire wrist cord here to test your wrist strap.

**G. Dual-Wire Wrist Strap Jack:** Insert your dual-wire wrist cord here to test your wrist strap.

**H. Wrist Strap Status LEDs:** Displays the wrist strap test results.

**I. Keypad:** Use the keypad to manually enter your numeric test ID and test type (user choice).

**J. Connections Cover:** Remove the screw at the bottom to un-latch the cover from the tester.

**K. Buzzer Volume Adjustment:** Turn the trimpot clockwise to increase the buzzer volume and counter-clockwise to decrease the volume.

**L. Foot Plate Jack:** Connect one end of the foot plate cable here and the other end to the dual foot plate.

**M. Test Limit DIP Switch:** Use this DIP switch to configure the resistance limits of the tester. See “Tester Configuration” on page 6 for more information.

**N. RS-232 Communication Jack:** Allows for direct connection to a PC.

**O. Ethernet Jack:** Provides communication to the SmartLog V5™ over a network. See “Ethernet Setup” on page 8 for more information.

**P. External Reader Port:** Used for connecting various accessories. Contact manufacturer for more information.

**Q. Slave / Master Switch:** Ensure that this is set to the MASTER position. This is used when connecting a series of SmartLogs in an RS-485 daisy chain. Contact the manufacturer for more information.

**R. Communication Jumpers:** Shunt the jumper pins on the left side when using the Ethernet module. Shunt the jumper pins on the right side when configuring the SmartLog V5™ in a RS-485 daisy chain.

**S. 12VDC Power Jack:** Connect the included power adapter here to power the SmartLog V5™.

**T. RS-485 Communication Terminal:** Used when connecting a series of SmartLogs in an RS-485 daisy chain. Contact the manufacturer for more information.

**U. Relay Terminal:** Can be integrated with electronic door locks, lights, buzzers, etc. Capable of switching up to 120VAC or DC at no more than 2 amps of current. See "Relay Terminal" on page 8 for more information.

**V. Clock Configuration Buttons:** See "Configuration" in the following section for more information.

**W. Reset Button:** Press this button to reset the power on the SmartLog V5™.

**X. Ground Jack:** Insert the banana plug end of the included ground cord to this jack. Connect the ring terminal end of the cord to equipment ground. This connection will remove any static charge from the user before the test.

**NOTE:** Failure to correctly ground the SmartLog V5™ may result in damage not covered under warranty.

## Installation

The following procedures will walk you through the setup and installation of your SmartLog V5™.

### Clock Configuration

NOTE: The Clock Configuration procedure only needs to be followed when installing multiple SmartLogs.

1. Unscrew the right-hand connection cover, and power the SmartLog V5™ using the included power supply.
2. The SmartLog will cycle through a self diagnostic program. The time and date will appear on the screen when the diagnostics are complete.
3. Press the MENU button six times to enter setup mode. If the MENU button is not pressed within 20 seconds after power up, the SmartLog will lockout from setup mode and require a power reset for another attempt to be made.
4. Use setup mode to cycle through various settings. Use the ADVANCE button to change any value and the ENTER button to move to the next setting.

Ensure that your SmartLog has the following configurations:

BAUD	9600
PARITY	ODD
SMART LOG ID	00

The SmartLog ID is a two digit field that ranges from 00-63. Each SmartLog must have a unique ID number should you have several units configured to your system.

DAYLIGHT	DISABLE
PORT EXPAND	YES
DECODE	NO
READER	MAGSTRIPE

5. Press the MENU button to save and exit setup mode.

### Tester Configuration

The resistance limits for footwear and wrist strap tests are controlled by the DIP switches located on the right side of the SmartLog V5™. Use the following tables for the DIP switch settings and their corresponding test values.

#### Footwear Resistance

DIP switches 1 and 2 control the HIGH test limit.

Switch 1	Switch 2	HIGH Limit Resistance
ON	ON	10 Megohms ( $1 \times 10^7$ )
OFF	OFF	35 Megohms ( $3.5 \times 10^7$ )
ON	OFF	100 Megohms ( $1 \times 10^8$ )
OFF	ON	1 Gigohm ( $1 \times 10^9$ )

DIP switches 3 and 4 control the LOW test limit.

Switch 3	Switch 4	LOW Limit Resistance
OFF	OFF	footwear test disabled***
ON	OFF	100 Kilohms ( $1 \times 10^5$ )
OFF	ON	750 Kilohms ( $7.5 \times 10^5$ )

default setting

NOTE: At 1 Gigohm high limit resistance, a dirty foot plate could result in a false pass. Be sure to keep the foot plate clean particularly when using this setting. This setting is not suitable for relative humidity greater than 50%.

#### Wrist Strap Resistance

DIP switches 5 and 6 control the HIGH test limit.

Switch 5	Switch 6	HIGH Limit Resistance
OFF	OFF	wrist strap test disabled***
ON	ON	10 Megohms ( $1 \times 10^7$ )
ON	OFF	35 Megohms ( $3.5 \times 10^7$ )

default USA setting

default Europe & Asia setting

DIP switch 5 must be ON (default setting) for the wrist strap test to be active. The wrist strap test will be disabled if DIP switch 5 is set to OFF.

The LOW limit for the wrist strap test is set to 750 Kilohms and cannot be modified by the user.

\*\*\*EMIT recommends using the TEAM5 Software to disable wrist strap and footwear tests. TEAM5 can assign test protocols unique to the operator.

## Hardware Setup

1. Use the included screws and anchors to secure the mounting bracket to the desired location. The screws may be used in any of the four holes shown below. Be sure to locate the bracket where users can read the display and use the tester.

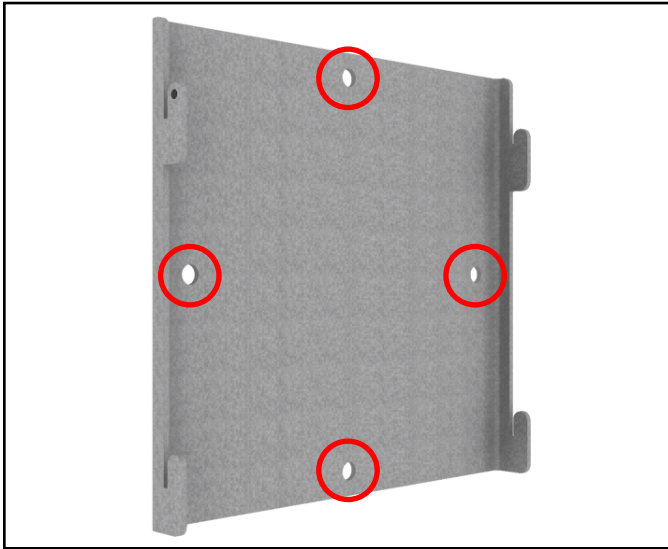

Figure 4. Installing the SmartLog V5™ mounting bracket

2. Connect the SmartLog V5™ to the bracket. Use the included thumbscrew to secure the SmartLog as shown below.



Figure 5. Connecting the SmartLog V5™ to the bracket

3. Connect the ground cord, foot plate cable, Ethernet cable (or RS-232 communication cable) and power adapter to the SmartLog V5™.
4. Route all cables through the openings located at the bottom and backside of the cover. Secure the cover to the SmartLog with the included thumb screw. All cables should exit the SmartLog as shown below.



Figure 6. Routing the cables out of the SmartLog V5™

5. Connect the ground cord's ring terminal to a known ground point. Connect the foot plate cable to the foot plate. Verify that the Ethernet cable is connected to your network (or use the serial port adapter to connect the RS-232 cable to your PC).
6. Power the SmartLog V5™. The display will turn on and the tester LEDs will blink then turn off. If the footwear status LEDs continue to blink, inspect the foot plate cable and verify that it is securely connected at both terminals.



Figure 7. Use the EMIT 50415 stand as a mounting alternative

## 50771 Turnstile Bracket

The relay terminal featured on the SmartLog V5™ makes the tester ideal for turnstile integration. EMIT offers the 50772 and 50773 SmartLog V5™ Turnstile as a complete access control solution. These items include both a SmartLog V5™ and stainless steel turnstile. Should you already own a turnstile, use the EMIT 50771 Turnstile Bracket to mount your SmartLog V5™ to the top of the turnstile. The bracket has a footprint size of 6.6" x 5.5" and can be fitted to most turnstiles.



Figure 8. EMIT 50771 Turnstile Bracket, SmartLog V5™

### Packaging

- 1 Stainless Steel Turnstile Bracket with Nylon Feet
- 1 Screw, 4-40 thread
- 3 Screws, 10-32 thread
- 3 Nuts, 10-32 thread
- 3 Washers
- 1 Nylon Bushing

### Installation

1. The 50771 Turnstile Bracket provides a way to route the SmartLog's cables through the turnstile's enclosure in order to eliminate tampering of the connections. Use the drill pattern in Figure 9 to mill the top cover of your turnstile and clear space to mount the bracket.

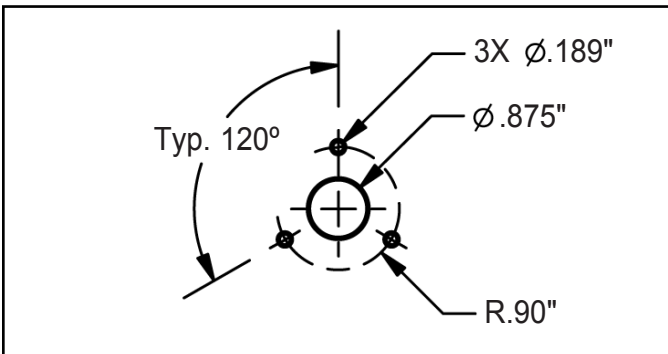

Figure 9. Drill pattern for mounting the bracket to a turnstile's cover

2. Install the nylon bushing into the .875" hole located on the turnstile's cover.

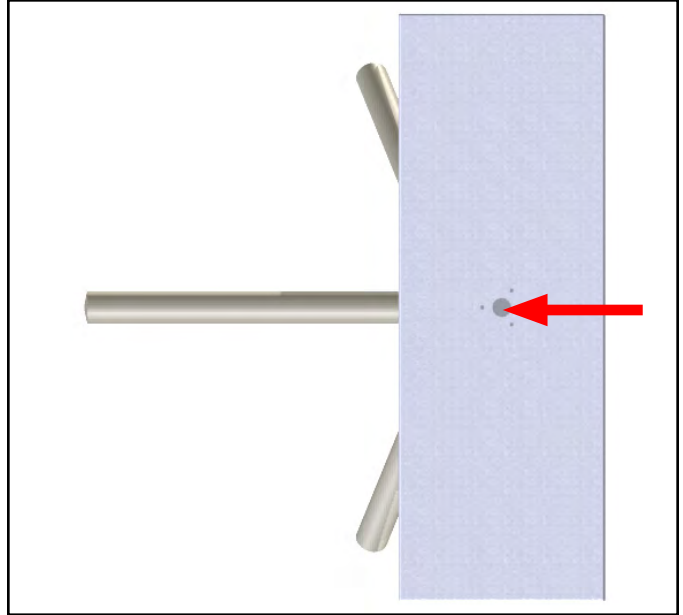

Figure 10. Installing the nylon bushing into the turnstile

3. Open the turnstile's cover. Install the mounting bracket onto the turnstile's cover using the three 10-32 screws, washers and nuts. From top to bottom, the installation order is: screw, washer, mounting bracket, turnstile cover, nut.

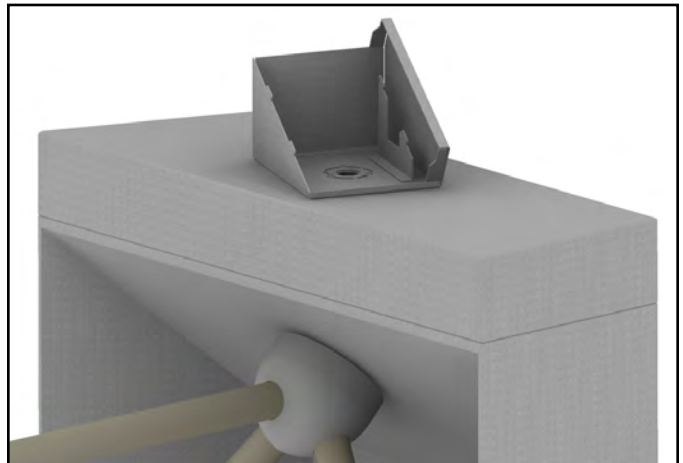

Figure 11. The bracket installed to a turnstile

4. Route the SmartLog's foot plate cable, power adapter, ground cord, relay wires and Ethernet cable through the turnstile and bracket. Use an opening at the base of the turnstile to route the foot plate cable to the foot plate.



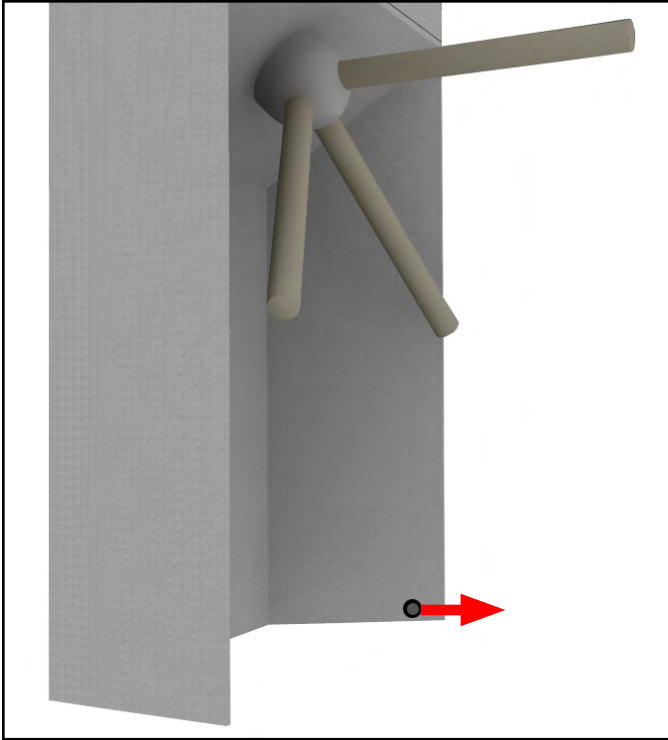

Figure 12. Routing the foot plate cable through a turnstile's base

5. Make all of the cable connections to the SmartLog V5™ as outlined in page 5. Be sure to connect the relay wires to the proper N/O and ground terminals inside your turnstile.
6. Align the slots on the back of the SmartLog V5™ with the hooks on the turnstile bracket.

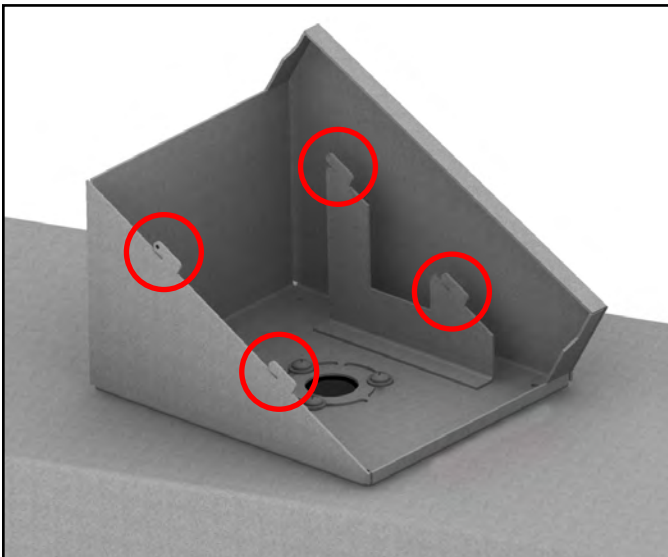

Figure 13. Locating the mounting hooks on the bracket

7. Slide the SmartLog V5™ into the bracket from top to bottom. Secure the SmartLog V5™ to the bracket by fastening the included 4-40 screw on the left-side of the tester.



Figure 14. Sliding the SmartLog V5™ into the bracket and securing it into place with the 4-40 screw



Figure 15. EMIT 50771 Turnstile Bracket in-use with the SmartLog V5™

## Relay Terminal

The SmartLog V5™ features a relay terminal that can be integrated with electronic door locks, lights, buzzers, etc. It is capable of switching up to 1A @ 30VDC or .5A @ 125VAC.

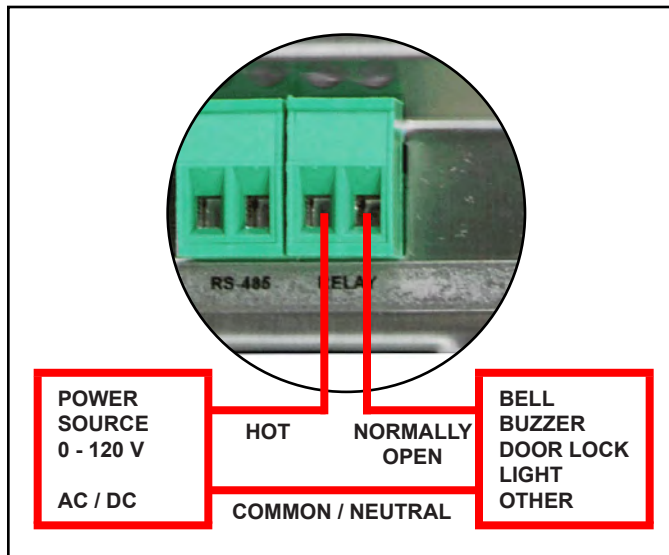

Figure 16. Relay installation

The relay close (activation) time may be modified using the TEAM5 Software. See the [TEAM5 User Manual](#) for more information.

## Ethernet Setup

The SmartLog V5™ provides the option to connect to a PC either directly or remotely via a LAN setup. The following procedure will outline how to connect your SmartLog V5™ to a network using its embedded Ethernet communication module. This is the recommended method of installation.

Should this method not be ideal for your setup, see “Direct Connection to a PC” in the following section for an alternate way to establish communication to your SmartLog V5™.

1. Take note of the MAC address of your SmartLog V5™. This can be found on a label located at the bottom and right-hand side of the unit
2. Verify that the Ethernet cable is securely connected to your network and SmartLog V5™. The SmartLog V5™ must be powered during Ethernet setup. The LEDs on the Ethernet port will illuminate when a connection to the network is established.
3. Use the following link to download the necessary drivers for the Ethernet module. It is compatible with Windows Server 2003, Server 2008, XP, Vista and 7.

[http://ftp1.digi.com/support/driver/40002549\\_E.zip](http://ftp1.digi.com/support/driver/40002549_E.zip)

4. Unzip the downloaded file and open the folder. Run “Setup32.exe” if using a 32-bit machine or “Setup64.exe” if using a 64-bit machine.

5. The Digi RealPort Setup Wizard window will open. Select the proper MAC address and click the Next button.

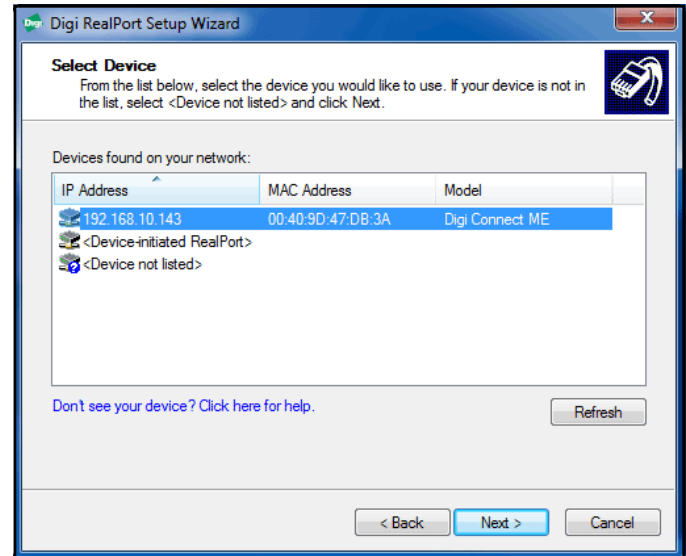

Figure 17. Selecting the MAC address

6. You will next be prompted to enter the device settings. You may choose to simply accept the default settings. Take note of the assigned COM Port number. This value will be needed when building the communication settings in the TEAM5 Software. Click the Finish button when complete.

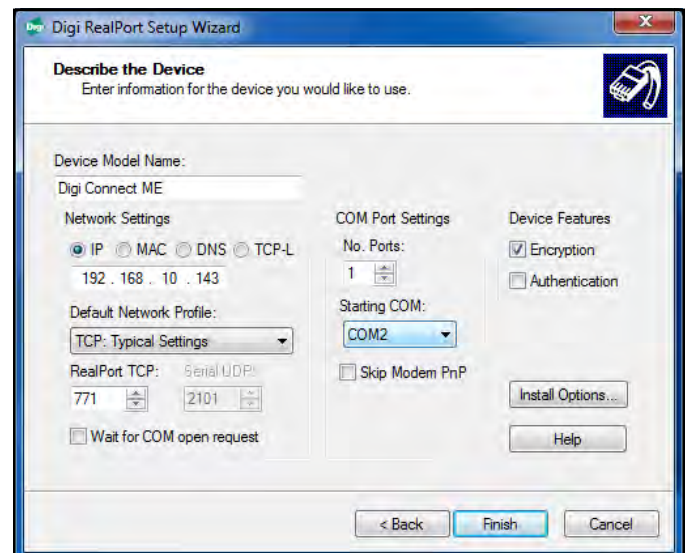

Figure 18. Ethernet device settings

- The setup wizard will then begin to install the necessary drivers to your PC.

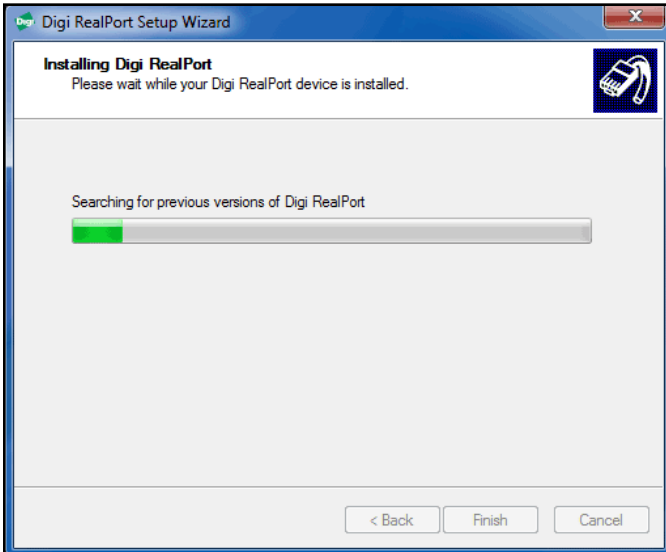

Figure 19. Driver installation

- Click the Finish button when complete.

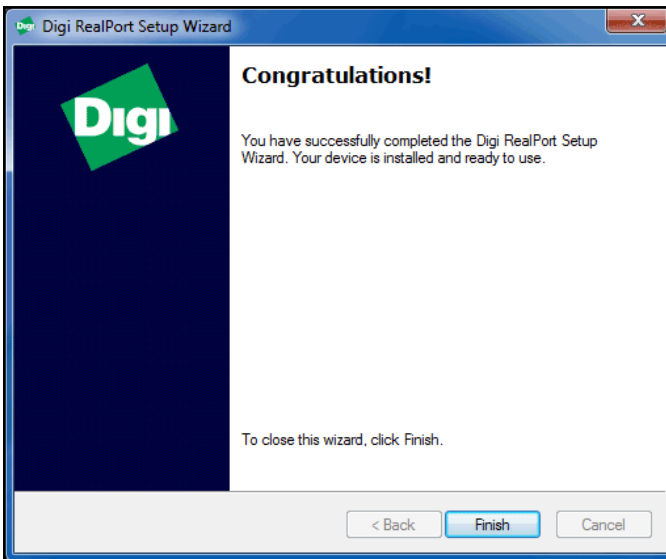

Figure 20. Completing the setup wizard

## Direct Connection to PC

The following procedure will outline how to connect your SmartLog V5™ directly to a PC using RS-232 (telephone) cable and the included DB9 serial adapter. This installation method can be used when an Ethernet setup is not ideal.

- Build non-inverted RS-232 (telephone) cable with RJ11 plugs at each end.
- Connect one end of the cable to the jack labeled “RS-232” on the SmartLog V5™.
- Connect the other terminal to the included DB9 serial adapter.
- Connect the serial adapter to an available serial port on your PC. The designated COM Port number will be used when building the communication settings in the TEAM5 Software.

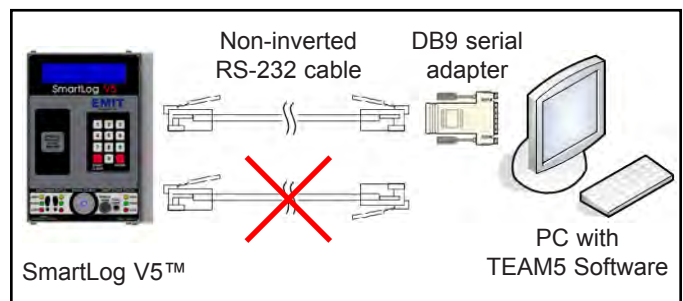

Figure 21. Directly connecting the SmartLog V5™ to a PC

## TEAM5 Software

TEAM5 is the most powerful and accurate ESD Test Acquisition Software on the market. When used with the EMIT SmartLog, TEAM5 allows manufacturers and assemblers to automate the collection of employee ESD testing. It has a set of robust employee management functions that allow automated tracking of employee leave time, shift and department assignments and ESD training. TEAM5 connects your ESD test data to the rest of your manufacturing environment with automated electronic data interchange in a variety of formats.

TEAM5 Software is required for every SmartLog system installation. TEAM5 is compatible with the SmartLog V4 and SmartLog V5™ systems.

See the [TEAM5 User Manual](#) for more information.

The software may be downloaded using the following link:  
<http://emit.descoindustries.com/team5.aspx>

NOTE: A license dongle is required to run the software. Contact EMIT Customer Service to schedule an installation session.

## Operation

NOTE: The SmartLog V5™ must first be programmed with the user ID table using the TEAM5 Software before being deployed for employee use, or the default test settings will be applied.

See the [TEAM5 User Manual](#) for more information.

1. Initiate the test procedure by identifying yourself to the SmartLog. This may be done using the keypad, barcode badge scanner or proximity badge reader (if supplied).
2. Follow the prompt on the SmartLog's display.
3. When performing a footwear test, be sure to place both feet on the dual foot plate (one foot per plate).

When performing a wrist strap test, be sure to completely plug in the wrist cord into the tester's jack.

4. Press and hold the metal touch plate on the tester to perform the test. Hold your finger on the touch plate until the results of the test are displayed.

If performing a wrist strap test, and the wrist strap status LEDs do not illuminate, verify that the wrist cord is correctly inserted into the tester.

5. The relay terminal will activate if the defined tests are passed (if applicable).



Figure 22. Using the SmartLog V5™

## Calibration

Frequency of recalibration should be based on the critical nature of those ESD sensitive items handled and the risk of failure for the ESD protective equipment and materials. In general, EMIT recommends that calibration be performed annually.

Use the EMIT 50424 Limit Comparator to perform periodic testing (once every 6-12 months) of the SmartLog V5™. The Limit Comparator can be used on the shop floor within a few minutes virtually eliminating downtime, verifying that the tester is operating within tolerances.

See [TB-6581](#) for more information.



Figure 23. EMIT 50424 Limit Comparator

## Specifications

### SMARTLOG V5™

Operating Voltage	100-240 VAC, 50/60 Hz
Operating Temperature	32°F - 104°F (0 - 40°C)
Dimensions	7.9" x 5.8" x 1.9" (20.1 cm x 14.7 cm x 4.8 cm)
Weight	2.0 lbs (0.9 kg)
Test Accuracy	±20% for 1 gigohm footwear test limit ±10% for all other test limits
Test Switch Voltage	5 VDC @ open circuit
Wrist Strap and Footwear Test Voltage	30 VDC @ open circuit
Test current is limited by resistors and varies on the test range setting (100 kilohms - 1 gigohm)	
Memory Capacity***	

Test ID Length	Test Transactions
4	16,100
5	15,300
6	14,600
7	14,000
8	13,400
9	12,900
10	12,400
11	11,900
12	11,500
13	11,100
14	10,700
15	10,400
16	10,100

\*\*\*This only applies should the SmartLog V5 lose communication with the TEAM5 Software. Test transactions are automatically polled from the SmartLog's memory when connected to TEAM5.

### DUAL INDEPENDENT FOOT PLATE

Dimensions	14.0" x 16.0" x 0.9" (35.6 cm x 40.1 cm x 2.3 cm)
Weight	7.5 lbs (3.4 kg)

## Limited Warranty

### Limited Warranty

EMIT expressly warrants that for a period of five (5) years from the date of purchase EMIT SmartLog V5™'s will be free of defects in material (parts) and workmanship (labor). Within the warranty period, a credit for purchase of replacement EMIT products, or, at EMIT's option, the product will be repaired or replaced free of charge. If product credit is issued, the amount will be calculated by multiplying the unused portion of the expected five year life times the original unit purchase price. Call our Customer Service Department at 909-664-9980 (Chino, CA) for a Return Material Authorization (RMA) and proper shipping instructions and address. Please include a copy of your original packing slip, invoice, or other proof of date of purchase. Any unit under warranty should be shipped prepaid to the EMIT factory. Warranty replacements will take approximately two weeks.

If your unit is out of warranty, call our Customer Service Department at 909-664-9980 (Chino, CA) for a Return Material Authorization (RMA) and proper shipping instructions and address. EMIT will quote repair charges necessary to bring your unit up to factory standards.

### Warranty Exclusions

THE FOREGOING EXPRESS WARRANTY IS MADE IN LIEU OF ALL OTHER PRODUCT WARRANTIES, EXPRESSED AND IMPLIED, INCLUDING MERCHANTABILITY AND FITNESS FOR A PARTICULAR PURPOSE WHICH ARE SPECIFICALLY DISCLAIMED. The express warranty will not apply to defects or damage due to accidents, neglect, misuse, alterations, operator error, or failure to properly maintain, clean or repair products.

### Limit of Liability

In no event will EMIT or any seller be responsible or liable for any injury, loss or damage, direct or consequential, arising out of the use of or the inability to use the product. Before using, users shall determine the suitability of the product for their intended use, and users assume all risk and liability whatsoever in connection therewith.