

COLORado™ 3

COLORADO 3

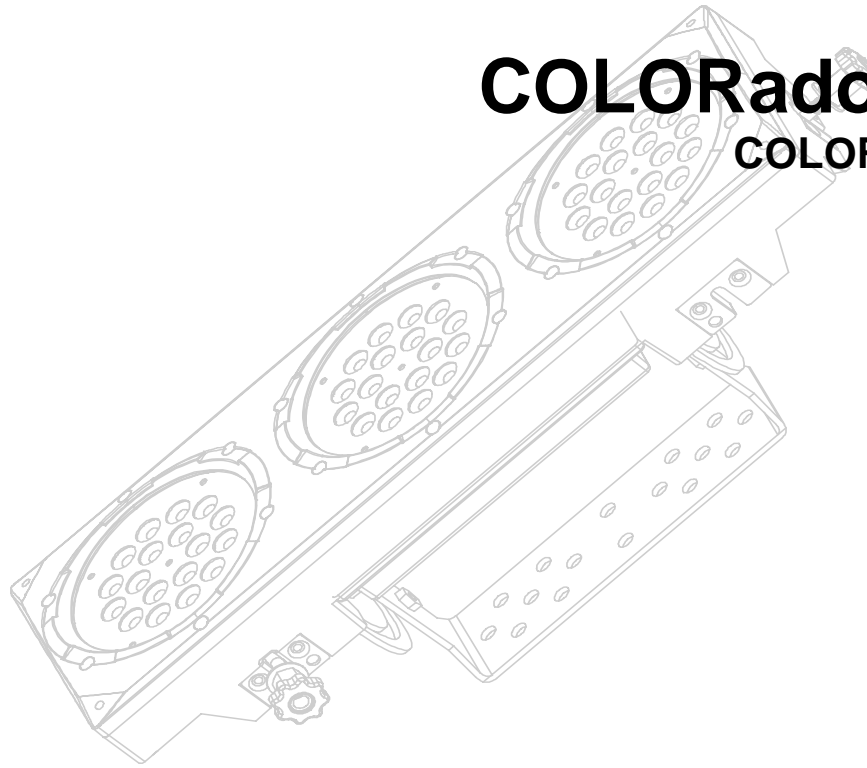

USER MANUAL

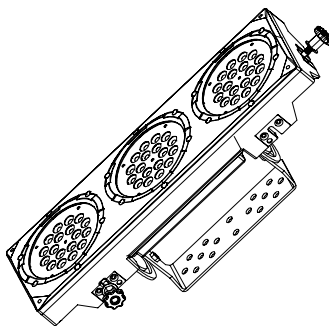

CHAUVET, 3000 N 29th Ct, Hollywood, FL 33020 U.S.A
(800) 762-1084 – (954) 929-1115
FAX (954) 929-5560
www.chauvetlighting.com

Table of Contents

1. BEFORE YOU BEGIN.....	4
UNPACKING INSTRUCTIONS.....	4
CONTACT US.....	4
SAFETY INSTRUCTIONS.....	5
LED EXPECTED LIFESPAN.....	5
2. INTRODUCTION	6
FEATURES.....	6
DMX CHANNEL SUMMARY.....	6
PRODUCT OVERVIEW.....	7
3. SETUP	8
AC POWER.....	8
MOUNTING.....	8
STACKING.....	9
FIXTURE LINKING.....	9
Data Cabling.....	10
DMX Data Cable.....	10
Cable Connectors.....	10
3-Pin to 5-Pin Conversion Chart.....	10
SETTING UP A DMX SERIAL DATA LINK.....	11
4. OPERATING INSTRUCTIONS.....	12
CONTROL OPTIONS.....	12
ADAS OVERVIEW.....	12
COLORADO™ CONTROL QUICK SETUP.....	12
DMX-512 control without "ID" address.....	12
DMX-512 addressing with ID address.....	13
ADAS with ID address.....	13
COLORcon™ setup.....	14
Setting the DMX address.....	15
CONTROL PANEL FUNCTIONS.....	15
Menu Map.....	16
Manual Power ON/OFF.....	16
DMX512 CHANNEL VALUES.....	17
DMX CONTROL MODE 1.....	17
Important Notes about DMX Mode 1.....	19
Red, Green and Blue Selection.....	19
Yellow, Cyan, Purple and White.....	19
Strobe.....	19
Mode Selection.....	19
ID address selection.....	19
Module selection.....	19
Effect macro.....	19
DMX CONTROL MODE 2.....	20
Important Notes about DMX Mode 2.....	20
Module selection.....	20
Strobe.....	20
Mode selection.....	20
ID address selection.....	20
5. COLORADO™ CONTROLLER	21
OVERVIEW.....	21
SETUP.....	21
MENU MAP.....	22
Wash Program.....	22
Effect Program.....	22
Custom Program.....	23
Play Schedule.....	23
Clock.....	23
Schedule.....	23

Settings	23
Activating password mode.....	24
Control via external DMX.....	24
6. APPENDIX.....	26
DMX PRIMER.....	26
RETURNS PROCEDURE	26
CLAIMS	26
MAINTENANCE	26
PHOTOMETRIC.....	27
TECHNICAL SPECIFICATIONS.....	28
TECHNICAL SUPPORT	28

©CHAUVET, 2006, All Rights Reserved

Information and specifications in this User Manual are subject to change without notice. CHAUVET assumes no responsibility or liability for any errors or inaccuracies that may appear in this manual.

1. Before You Begin

Unpacking Instructions

Immediately upon receiving a product, carefully unpack the carton, check the contents to ensure that all parts are present, and have been received in good condition. Notify the shipper immediately and retain packing material for inspection if any parts appear damaged from shipping or the carton itself shows signs of mishandling. **Save the carton and all packing materials.** In the event that a fixture must be returned to the factory, it is important that the fixture be returned in the original factory box and packing.

Note: If you should require sending any items back to CHAUVET, call CHAUVET for a (RMA) Return Merchandise Authorization number. The factory will not allow any shipments without an RMA.

Your shipment includes the following:

- 1 x COLORado™ 3
- 1 x Power cable with plug
- 1 x IP65 power extension cable
- 1 x IP65 signal extension cable
- 1 x DMX input cable
- 1 x DMX output cable
- Warranty Card
- Users Manual

Contact Us

World Wide

General Information Chauvet Lighting
3000 North 29th Court
Hollywood, FL 33020
voice: 954.929.1115
fax: 954.929.5560
toll free: 800.762.1084

Technical Support Chauvet Lighting
3000 North 29th Court
Hollywood, FL 33020
voice: 954.929.1115 (**Press 4**)
fax: 954.929.5560 (**Attention: Service**)

World Wide Web www.chauvetlighting.com

Safety Instructions



Please read these instructions carefully, which includes important information about the installation, usage and maintenance of this product.

- Please keep this User Guide for future consultation. If you sell the unit to another user, be sure that they also receive this instruction booklet.
- Always make sure that you are connecting to the proper voltage, and that the line voltage you are connecting to is not higher than that stated on the decal or rear panel of the fixture.
- Make sure there are no flammable materials close to the unit while operating.
- Always disconnect from power source before servicing or replacing fuse and be sure to replace with same fuse source.
- Secure fixture to fastening device using a safety chain.
- Maximum ambient temperature (Ta) is 95°F (35°C). Do not operate fixture at temperatures higher than this.
- In the event of a serious operating problem, stop using the unit immediately. Never try to repair the unit by yourself. Repairs carried out by unskilled people can lead to damage or malfunction. Please contact the nearest authorized technical assistance center. Always use the same type spare parts.
- Don't connect the device to a dimmer pack.
- Make sure the power cord is never crimped or damaged.
- Never disconnect the power cord by pulling or tugging on the cord.
- Avoid direct eye exposure to the light source while it is on.
- Do not daisy chain power to more than 15 units.

Caution!

There are no user serviceable parts inside the unit. Do not open the housing or attempt any repairs yourself. In the unlikely event your unit may require service, please contact CHAUVET at: 954-929-1115.

LED Expected Lifespan

LEDs gradually decline in brightness over time. HEAT is the dominant factor that leads to the acceleration of this decline. Packaged in clusters, LEDs exhibit higher operating temperatures than in ideal or singular optimum conditions. For this reason when all color LEDs are used at their fullest intensity, life of the LEDs is significantly reduced. It is estimated that a viable lifespan of 40,000 to 50,000 hours will be achieved under normal operational conditions. If improving on this lifespan expectancy is of a higher priority, place care in providing for lower operational temperatures. This may include climatic-environmental and the reduction of overall projection intensity.

2. Introduction

Features

- 12-channel DMX-512 LED bank system (with ID addressing)
- Separate DMX channels for red, green, blue, cyan, magenta, yellow and white
- Blackout/static/dimmer/strobe
- Separate RGB control over each individual pod
- RGB color mixing with or without DMX controller
- Durable and weather resistant IP65 rated
- Flip-down knobs for interlocking multiple units together which can create blinder, wall and strip light effects (flush mounted)
- Automatic DMX-512 addressing (ADAS)
- Built-in automated programs via COLORcon controller or DMX
- LED display with lock-out feature
- Black anti-UV plastic cover
- Low power consumption

DMX Channel Summary

DMX MODE 1	CHANNEL	DESCRIPTION
	1	Red
	2	Green
	3	Blue
	4	Yellow
	5	Cyan
	6	Purple
	7	White
	8	Strobe
	9	Mode Selection Color-cycle Mode 245 <> 255 : DMX Mode 2
	10	ID Address Selection
	11	Module Selection
	12	Effect Macro

DMX MODE 2	CHANNEL	DESCRIPTION
	1	Module #1
	2	Module #2
	3	Module #3
	4	
	5	No Function
	6	
	7	
	8	Strobe
	9	Mode Selection 0 <> 244 : DMX Mode 1
	10	ID Address Selection
	11	No Function
	12	

Product Overview

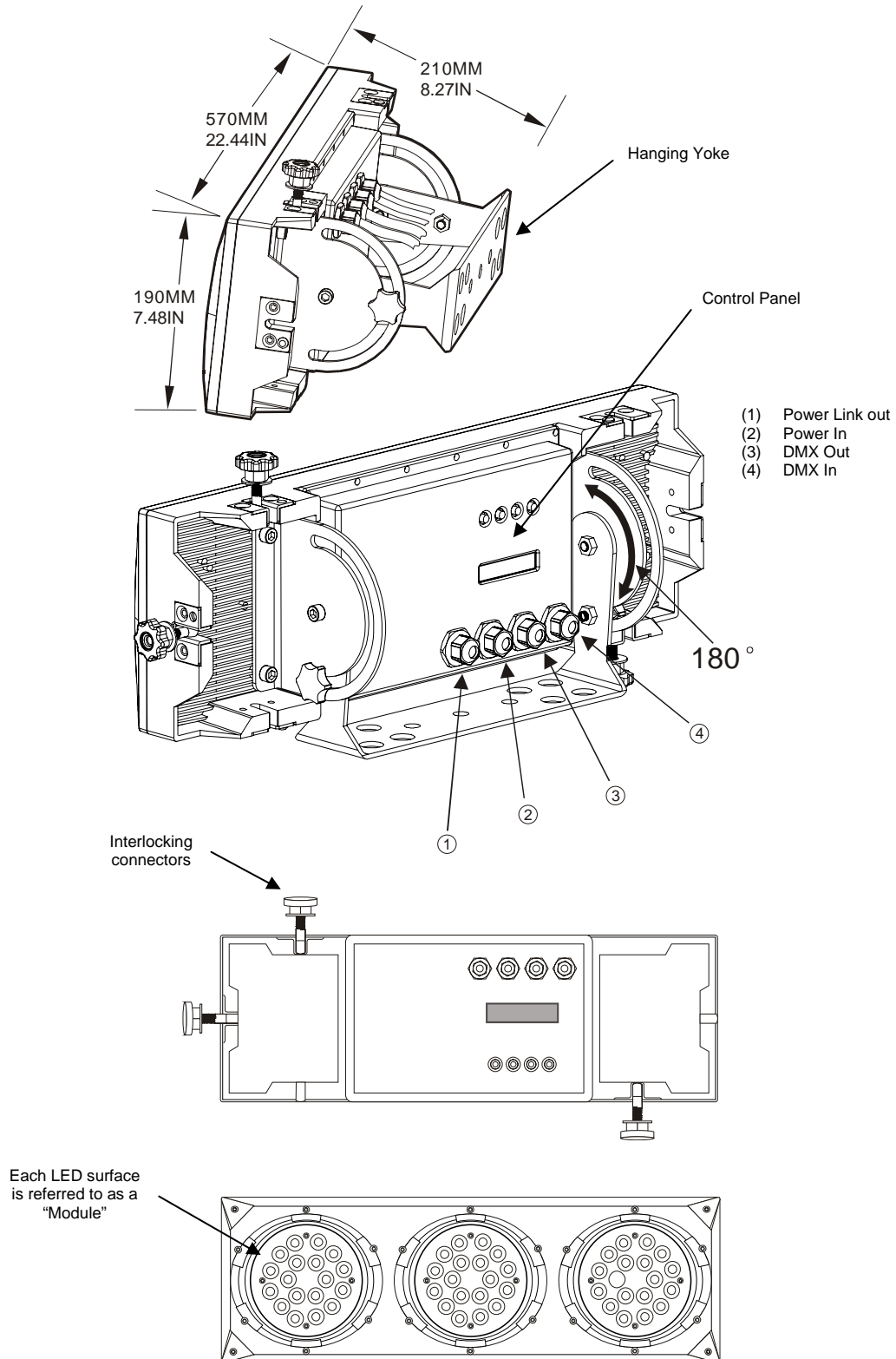

3. Setup

AC Power

Warning!

Verify that the power requirement label on your unit matches the line voltage applied. All fixtures must be connected to circuits with a suitable Earth Ground.

- To determine the power requirements for a particular fixture, see the label affixed to the back plate of the fixture or refer to the fixture's specifications chart.
- A fixture's listed current rating is its average current draw under normal conditions.
- All fixtures must be powered directly off a switched circuit and cannot be run off a rheostat (variable resistor) or dimmer circuit, even if the rheostat or dimmer channel is used solely for a 0% to 100% switch.
- Before applying power to a fixture, check that the source voltage matches the fixture's requirement.
- All fixtures must be connected to circuits with a suitable Earth Ground.

Power Cable Configuration

CABLE	Pin	International	Screw Color
BROWN	Live	L	Yellow or Brass
BLUE	Neutral	N	Silver
YELLOW/GREEN	Earth	EG (Ground)	Green

Mounting

Orientation

This fixture can be mounted on a truss using a clamp in any position.

Rigging

The fixture includes a mounting yoke to which a rigging clamp can be attached. You must supply your own clamp and make sure the clamp is capable of supporting the weight of this fixture. You can order C-clamps from any CHAUVET dealer or distributor.

1. Block access below the work area and use suitable and stable platform when installing or servicing fixture.
2. Align the clamp screw with the center hole on the yoke and tighten.
3. Verify the structure can hold 10 times the weight of all to-be installed fixtures.
4. Adjust the angle on the yoke arm as necessary.
5. Always use a safety cable or chain as a secondary source of attachment. The safety cable must hold 10 times the weight of the fixture. If safety cable attachment point is provided that is permanently affixed to the surface or body of the fixture, use that instead of looping through a hanging yoke/arm.

Hanging Clamp

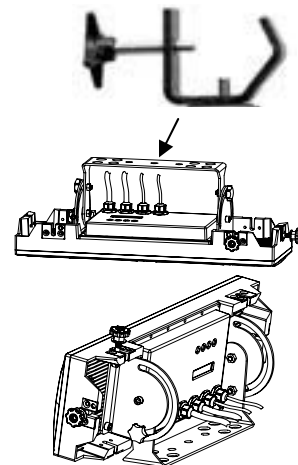

Stacking

The COLORado™ 3 can be stacked vertically and horizontally creating a blinder or a strip light. Stack them horizontally to increase intensity of the projection for more distant throws or to use as a blinder effect. The strip light stacking can be used for runway lighting and cycloramas.

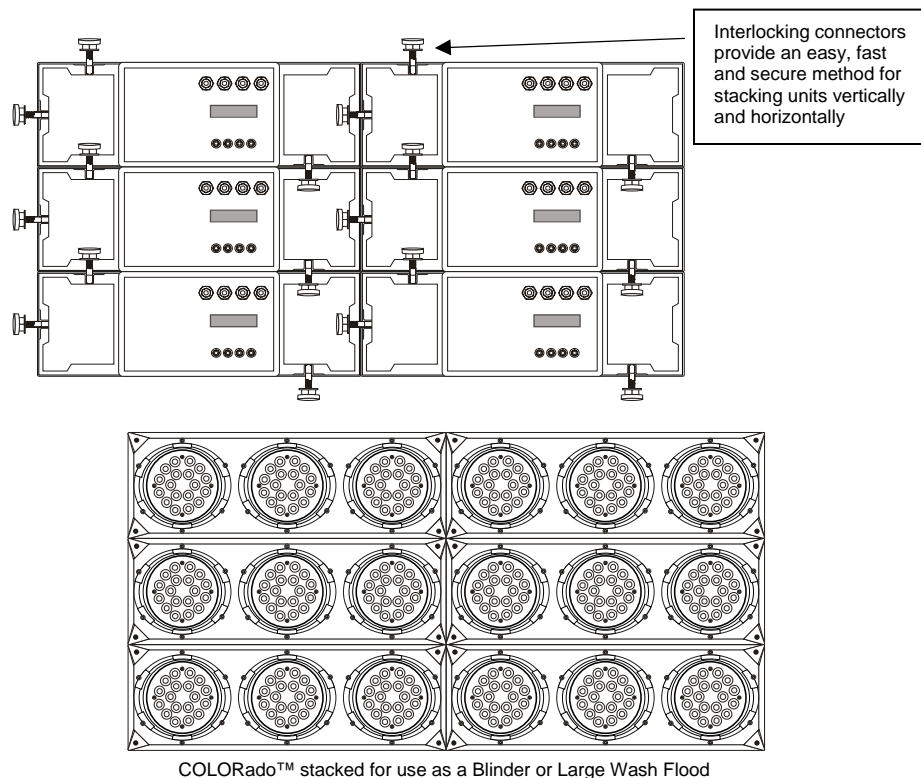

Fixture Linking

You will need a serial data link to run light shows of one or more fixtures using a DMX-512 controller or to run synchronized shows on two or more fixtures set to a master/slave operating mode. The combined number of channels required by all the fixtures on a serial data link determines the number of fixtures the data link can support.

The COLORado™ 3 fixtures use 12 channels of DMX control.

Important: Fixtures on a serial data link must be daisy chained in one single line. To comply with the EIA-485 standard no more than 32 devices should be connected on one data link. Connecting more than 32 fixtures on one serial data link without the use of a DMX optically isolated splitter may result in deterioration of the digital DMX signal.

Maximum recommended serial data link distance: 500 meters (1640 ft.)

Maximum recommended number of fixtures on a serial data link: 32 fixtures

Data Cabling

To link fixtures together you must obtain data cables. You can purchase CHAUVET certified DMX cables directly from a dealer/distributor or construct your own cable. If you choose to create your own cable please use data-grade cables that can carry a high quality signal and are less prone to electromagnetic interference.

DMX Data Cable

Use a Belden® 9841 or equivalent cable which meets the specifications for EIA RS-485 applications. Standard microphone cables cannot transmit DMX data reliably over long distances. The cable will have the following characteristics:

- 2-conductor twisted pair plus a shield
- Maximum capacitance between conductors – 30 pF/ft.
- Maximum capacitance between conductor and shield – 55 pF/ft.
- Maximum resistance of 20Ω / 1000 ft.
- Nominal impedance 100 - 140Ω

Cable Connectors

Cabling must have a male XLR connector on one end and a female XLR connector on the other end.

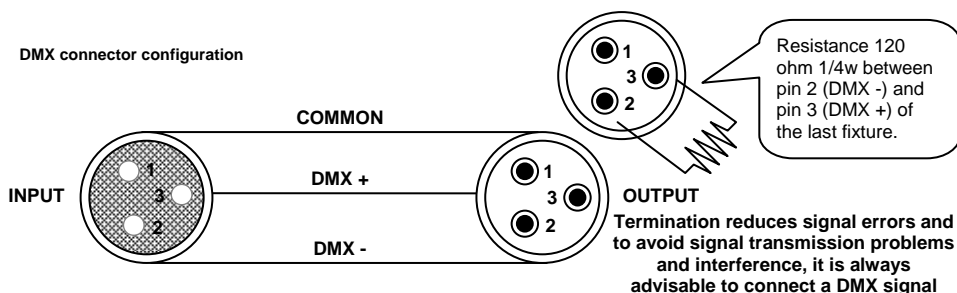

CAUTION Do not allow contact between the common and the fixture's chassis ground. Grounding the common can cause a ground loop and your fixture to perform erratically. Test cables with OHM meter to verify correct polarity and to make sure the pins are not grounded or shorted to the shield or each other.

3-Pin to 5-Pin Conversion Chart

Note! If you use a controller with a 5 pin DMX output connector, you will need to use a 5 pin to 3 pin adapter. CHAUVET Model No: DMX5M. The chart below details a proper cable conversion:

3 PIN TO 5 PIN CONVERSION CHART		
Conductor	3 Pin Female (output)	5 Pin Male (Input)
Ground/Shield	Pin 1	Pin 1
Data (-) signal	Pin 2	Pin 2
Data (+) signal	Pin 3	Pin 3
Do not use		Do not use
Do not use		Do not use

Setting up a DMX Serial Data Link

Connect the (male) 3 pin connector side of the DMX cable to the output (female) 3 pin connector of the controller.

Connect the end of the cable coming from the controller which will have a (female) 3 pin connector to the input connector of the next fixture consisting of a (male) 3 pin connector.

Then, proceed to connect from the output as stated above to the input of the following fixture and so on.

CHAUVET Certified DMX Data Cables

Order Code	Description
DMX1.5	DMX Cable 1.5m/4.9ft
DMX4.5	DMX Cable 4.5m/14.8ft
DMX10	DMX Cable 10m/32.8ft

Universal DMX Controller

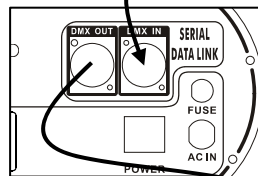
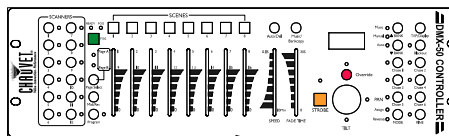

This drawing provides a general illustration of the DMX Input/Output panel of a lighting fixture.

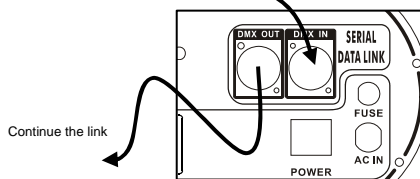

4. Operating Instructions

Control Options

The COLORado™ 3 is addressable in the DMX range of 001 to 245 in its simplest control form, this allows for the control of 20 fixtures; however, a secondary “ID” address system exists for use in a limited DMX universe and architectural environments. The “ID” address system allows the user to assign up to 66 fixtures within the same DMX address. In effect, multiplying the control of COLORado’s™ within a single universe to 1,320 fixtures. The COLORado’s™ “ID” address system is accessed using DMX channel 10. Consideration must be placed when programming live performances or cues that need to trigger on demand or on a time line. So, to remain within one second execution time, program no greater than 10 fixtures on ID addressing per DMX channel.

ADAS Overview

Automatic DMX512 Addressing System. Up to 20 fixtures in one universe can be automatically addressed. In ADAS with ID address setting, upon activation of CH8 and CH10 at value 255, the fixtures will self DMX address. This address is not random; it is calculated using the {**ADAS fader no**} value setting which the user sets in advance. The user can choose between 001 and 244 for the ADAS fader value, this value would be set to at least the number of control channels for a COLORado™ (which is 12) or the number of channel faders on a small console maybe 16 OR 18 (i.e. for a DMX 50). The ADAS DMX address is calculated within each fixture using the following method;

{ADAS fader no value} x (ID – 1) + 1 = ADAS DMX Address

Let’s see how that translates, I’ll use an ID value of 2 and an {**ADAS fader no**} value of 12;

{(ADAS=12) x [(ID=2) – 1]} + 1 || {12 x (2-1)} + 1 || {12 x 1} + 1 = **(13) DMX Address**

COLORado™ Control Quick Setup

For detailed instructions on display panel operations and functions please advance to the section titled; “Display Panel Functions”. These steps assume that you have read and are familiar with setting up a DMX serial data link.

DMX-512 control without “ID” address

The COLORado™ operates on 12 channels of DMX. Address each fixture in increments of 12 channels. (I.e. 1,13,25,37 etc...) To save time you can use the same DMX address for each fixture. All fixtures will then respond simultaneously to control. You may also group your fixtures and address those groups alike for faster programming and control.

1. Access the control panel’s {**DMX512 address**} function by pressing the (**UP/DOWN**) buttons until the function is displayed
2. Press the (**SET**) button to enter panel function.
3. Use the (**UP/DOWN**) buttons to increase or decrease channels between 001 and 244.
4. Press the (**SET**) button to confirm action.

Deactivate ID addressing in each fixture by setting panel function {**ID ON/OFF**} to OFF.
{**MENU**} → {**Settings**} → {**ID ON/OFF**} → [**OFF**]

Notes: If ID addressing is not deactivated in the fixture’s control panel function, unintended results may occur if values are present in channel 10. Make sure values on channel 10 are set to “0”.

DMX-512 addressing with ID address

Follow instructions 1 ~ 4 for DMX512 addressing.

Activate ID addressing in each fixture by setting panel function **{ID ON/OFF}** to ON.

{MENU} ↻ {Settings} ↻ {ID ON/OFF} ↻ [ON]

For every DMX512 starting address the user can set 66 separate ID addresses.

Set ID addresses in each fixture by setting panel function **{ID address}** to incremental values. (I.e. 1,2,3,4,5,6,etc...)

{MENU} ↻ {Settings} ↻ {ID address} ↻ [01 ~ 66]

ID addresses are accessible using Channel 10.

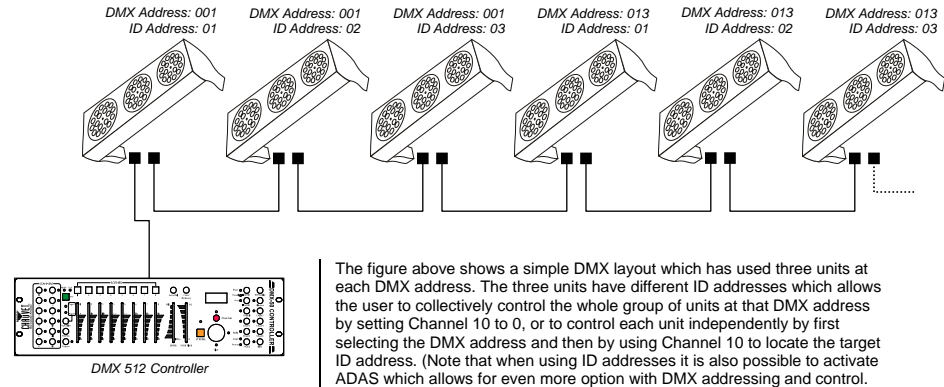

ADAS with ID address

With ADAS activated it is not necessary to set DMX512 addresses on each fixture. The fixture will automatically assign a temporary DMX address based on the fixture ID address and the value of **{ADAS fader no}** that will be assigned.

1. Set ID addresses as previously explained in ascending numerical order.
2. Set **{ADAS ON/OFF}** to ON.
{MENU} ↻ {Settings} ↻ {ADAS ON/OFF} ↻ [ON]
3. Set **{ADAS fader no}** to "12". Which is the number of control channels on a COLORado™.
{MENU} ↻ {Settings} ↻ {ADAS fader no} ↻ [12]
4. Activate **ADAS** DMX addressing by setting **Channels 8 and 10** to value **255**. (Faders 8 & 10 all the way up!)
5. A DMX address will be calculated and temporarily assigned as explained in the "ADAS Overview" section.
6. Deactivate **ADAS** DMX addressing by setting **Channels 8, 10 and 11** to value **255**. (Faders 8, 10 & 11 and the way up!). All fixtures will return to the DMX address previously set before the ADAS activation.

Note: You must set channels 8, 10, and 11 to 255 for EACH fixture you want to deactivate ADAS DMX addressing. For example, if a fixture has a starting address of 17, you must set DMX channels 24, 26, and 27.

You can make the temporary ADAS DMX address permanent on each fixture by selecting the **{ADAS copy}** function.

{MENU} ↻ {Settings} ↻ {ADAS copy} ↻ [ON] (Will store the new DMX address)

Important When using ADAS, all fixtures must have the following settings;

{ID address}	All ID addresses need to be set in ascending order
{ID ON/OFF}	Set to [ON]
{ADAS fader no}	All units set to the same value
{ADAS ON/OFF}	Set to [ON]

COLORcon™ setup

1. FIXTURE CONTROL PANEL SETUP

Activate ID addressing in each fixture by setting panel function **{ID ON/OFF}** to ON.
{MENU} → **{Settings}** → **{ID ON/OFF}** → **[ON]**

Set ID addresses in each fixture by setting panel function **{ID address}** to incremental values. (I.e. 1,2,3,4,5,6,etc...)

{MENU} → **{Settings}** → **{ID address}** → **[01 ~ 66]**

It is not necessary to set the DMX address.

2. CONTROLLER SETUP

When using the **{Effect program}** function, it is necessary to set the **{Settings}** → **{Range}** setting, which is the quantity of fixtures in series.

{MENU} → **{Settings}** → **{Range}** → **[(No. of fixtures)]**

Single Row Application

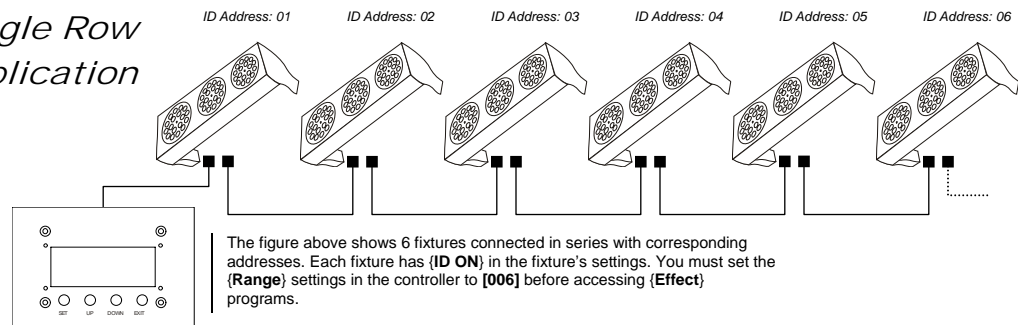

Repeat Row Block Application

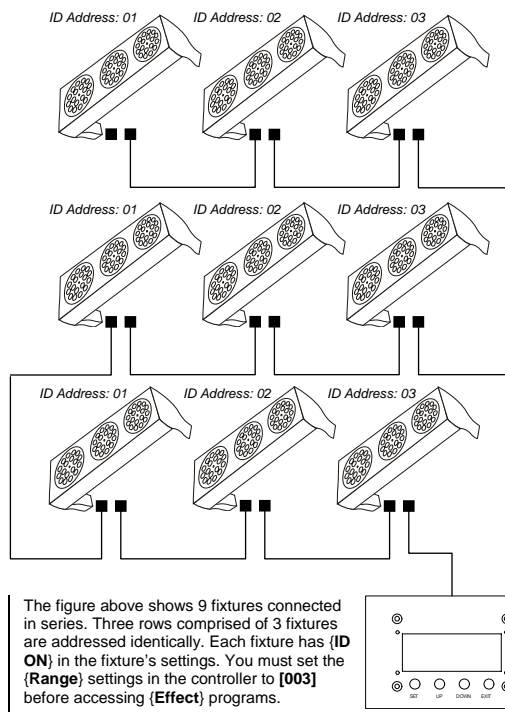

Block Application

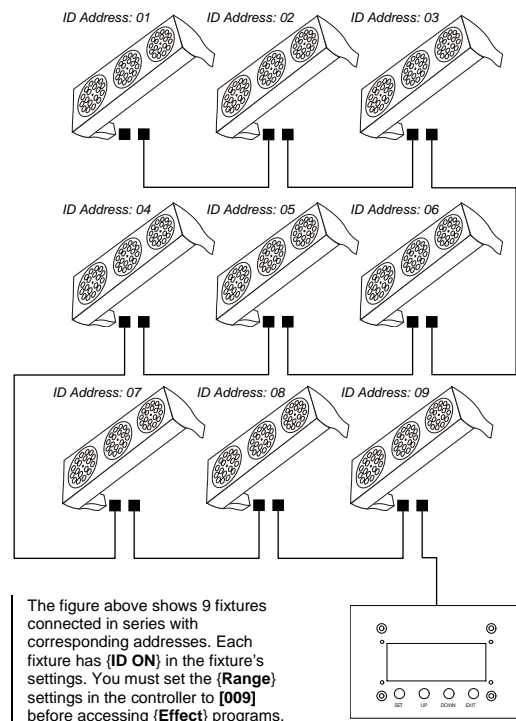

Setting the DMX address

Each fixture requires a "start address" from 1 to 244. A fixture requiring one or more channels for control begins to read the data on the channel indicated by the start address. For example, a fixture that occupies or uses 7 channels of DMX and was addressed to start on DMX channel 100, would read data from channels: 100, 101, 102, 103, 104, 105 and 106. Choose start addresses so that the channels used do not overlap and note the start address selected for future reference. The COLORado™ 3 uses 12 channels of DMX. If this is your first time using DMX, we recommend reading the DMX Primer in the Appendix Section.

Control Panel Functions

All fixture functions and settings are accessible via the built in control panel interface.

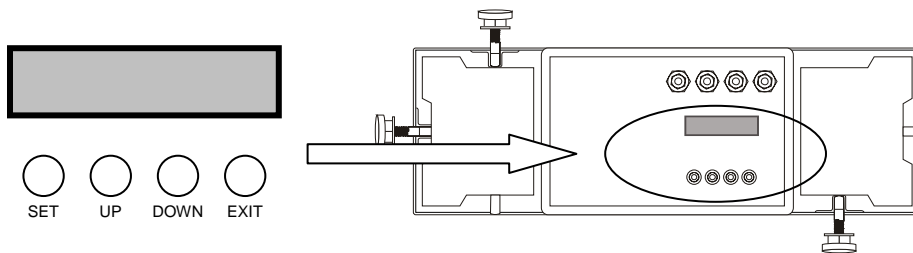

BUTTON	FUNCTION
SET	Enables the currently displayed menu or sets the currently selected value in to the selected function
UP	Navigates upwards through the menu list and increases the numeric value when in a function
DOWN	Navigates downwards through the menu list and decreases the numeric value when in a function
EXIT	Exits from the current menu or function

Menu Map

MAIN FUNCTION	SUB-FUNCTION	SELECTION	INSTRUCTION
Static color	Red	000 ~ 255* (0 ~ 100%) *Strobe range is 0 ~ 20	<ul style="list-style-type: none"> User can combine Red, Green and Blue to generate a custom color Select intensity over pre-composed colors yellow, cyan, purple and white Select strobing frequency between 0 and 20Hz
	Green		
	Blue		
	Yellow		
	Cyan		
	Purple		
	White		
	Strobe		
DMX512 address		001 ~ 244	<ul style="list-style-type: none"> 244 addressable DMX channels
Auto program		1	<ul style="list-style-type: none"> Choose from 8 Automatic run programs
		2	
		3	
		4	
		5	
		6	
		7	
		8	
Settings	ID address	01 ~ 66	Assigns the ID address to a fixture
	ID ON/OFF	On ~ Off	Either enables or disables ID addressing
	ADAS faders no	01 ~ 244	Sets the number of ADAS channels for use when automating DMX channel assignment
	ADAS ON/OFF	On ~ Off	Enables the Automatic DMX512 Addressing System
	ADAS copy	On ~ Off	When activated the DMX512 address assigned by the ADAS will become permanent on the fixture
	Factory settings	Reset confirm	Resets fixture to factory default settings
Password	ON/OFF	On ~ Off	When password is set to on the control panel will ask for a password each time the control panel is accessed
	Set Password	[????????]	Use UP and DOWN buttons to set and press SET to confirm Note! If you forget the password use the following factory password: UP, DOWN, UP, DOWN, UP, UP, DOWN, DOWN

Manual Power ON/OFF

The COLORado™ can be turned on and off using the control panel.

POWER	ACTION
Turn OFF	When {MENU} is displayed in the LCD panel, hold down the (EXIT) button for 3 seconds to turn off the fixture.
Turn ON	Hold the (EXIT) button for 3 seconds to turn power on.

DMX512 Channel Values

The COLORado™ has two DMX512 channel profiles (modes). Channel 9 is used to switch between profiles.

DMX CONTROL MODE 1

CHANNEL	VALUE	FUNCTION
1	000 ⇔ 004	Red
	005 ⇔ 255	No Function 0 ⇔ 100%
2	000 ⇔ 004	Green
	005 ⇔ 255	No Function 0 ⇔ 100%
3	000 ⇔ 004	Blue
	005 ⇔ 255	No Function 0 ⇔ 100%
4	000 ⇔ 004	Yellow
	005 ⇔ 255	No Function 0 ⇔ 100%
5	000 ⇔ 004	Cyan
	005 ⇔ 255	No Function 0 ⇔ 100%
6	000 ⇔ 004	Purple
	005 ⇔ 255	No Function 0 ⇔ 100%
7	000 ⇔ 004	White
	005 ⇔ 255	No Function 0 ⇔ 100%
8	000 ⇔ 004	Strobe
	005 ⇔ 255	No Function 0 ⇔ 20Hz
9	000 ⇔ 004	Mode Selection
	005 ⇔ 034	No Function
	035 ⇔ 064	Color-Cycle Mode 1
	065 ⇔ 094	Color-Cycle Mode 2
	095 ⇔ 124	Color-Cycle Mode 3
	125 ⇔ 154	Color-Cycle Mode 4
	155 ⇔ 184	Color-Cycle Mode 5
	185 ⇔ 214	Color-Cycle Mode 6
	215 ⇔ 244	Color-Cycle Mode 7
	245 ⇔ 255	Color-Cycle Mode 8 DMX MODE 2

Channel 10 (ID address selection)

000 ⇔ 009	All IDs	212	ID 23	235	ID 46
010 ⇔ 019	ID 1	213	ID 24	236	ID 47
020 ⇔ 029	ID 2	214	ID 25	237	ID 48
030 ⇔ 039	ID 3	215	ID 26	238	ID 49
040 ⇔ 049	ID 4	216	ID 27	239	ID 50
050 ⇔ 059	ID 5	217	ID 28	240	ID 51
060 ⇔ 069	ID 6	218	ID 29	241	ID 52
070 ⇔ 079	ID 7	219	ID 30	242	ID 53
080 ⇔ 089	ID 8	220	ID 31	243	ID 54
090 ⇔ 099	ID 9	221	ID 32	244	ID 55
100 ⇔ 109	ID 10	222	ID 33	245	ID 56
110 ⇔ 119	ID 11	223	ID 34	246	ID 57
120 ⇔ 129	ID 12	224	ID 35	247	ID 58
130 ⇔ 139	ID 13	225	ID 36	248	ID 59
140 ⇔ 149	ID 14	226	ID 37	249	ID 60
150 ⇔ 159	ID 15	227	ID 38	250	ID 61
160 ⇔ 169	ID 16	228	ID 39	251	ID 62
170 ⇔ 179	ID 17	229	ID 40	252	ID 63
180 ⇔ 189	ID 18	230	ID 41	253	ID 64
190 ⇔ 199	ID 19	231	ID 42	254	ID 65
200 ⇔ 209	ID 20	232	ID 43	255	ID 66
210	ID 21	233	ID 44		
211	ID 22	234	ID 45		

CHANNEL	VALUE	FUNCTION
11		Module Selection
	000 ⇔ 004	#1=ON, #2=ON, #3=ON
	005 ⇔ 034	#1=ON
	035 ⇔ 064	#2=ON
	065 ⇔ 094	#3=ON
	095 ⇔ 124	#1=ON, #2=ON
	125 ⇔ 154	#2=ON, #3=ON
	155 ⇔ 184	#1=ON, #3=ON
	185 ⇔ 214	#1=ON, #2=ON, #3=ON
	215 ⇔ 255	#1=OFF, #2=OFF, #3=OFF
	000 ⇔ 255	Speed control of Channel 9 Color-Cycle Mode 4
12		Effect Macro
	000 ⇔ 004	No Function
	005 ⇔ 008	Macro 01
	009 ⇔ 013	Macro 02
	014 ⇔ 018	Macro 03
	019 ⇔ 023	Macro 04
	024 ⇔ 028	Macro 05
	029 ⇔ 033	Macro 06
	034 ⇔ 038	Macro 07
	039 ⇔ 043	Macro 08
	044 ⇔ 048	Macro 09
	049 ⇔ 053	Macro 10
	054 ⇔ 058	Macro 11
	059 ⇔ 063	Macro 12
	064 ⇔ 068	Macro 13
	069 ⇔ 073	Macro 14
	074 ⇔ 078	Macro 15
	079 ⇔ 083	Macro 16
	084 ⇔ 088	Macro 17
	089 ⇔ 093	Macro 18
	094 ⇔ 098	Macro 19
	099 ⇔ 103	Macro 20
	104 ⇔ 108	Macro 21
	109 ⇔ 113	Macro 22
	114 ⇔ 118	Macro 23
	119 ⇔ 123	Macro 24
	124 ⇔ 128	Macro 25
	129 ⇔ 133	Macro 26
	134 ⇔ 138	Macro 27
	139 ⇔ 143	Macro 28
	144 ⇔ 148	Macro 29
	149 ⇔ 153	Macro 30
	154 ⇔ 158	Macro 31
	159 ⇔ 163	Macro 32
	164 ⇔ 168	Macro 33
	169 ⇔ 173	Macro 34
	174 ⇔ 178	Macro 35
	179 ⇔ 183	Macro 36
	184 ⇔ 188	Macro 37
	189 ⇔ 193	Macro 38
	194 ⇔ 198	Macro 39
	199 ⇔ 203	Macro 40
	204 ⇔ 208	Macro 41
	209 ⇔ 213	Macro 42
	214 ⇔ 218	Macro 43
	219 ⇔ 223	Macro 44
	224 ⇔ 228	Macro 45
	229 ⇔ 233	Macro 46
	234 ⇔ 238	Macro 47
	239 ⇔ 243	Macro 48
244 ⇔ 248	Macro 49	
249 ⇔ 255	Macro 50	

Important Notes about DMX Mode 1

Red, Green and Blue Selection

- Channels 1, 2 and 3 control overall intensity of each respective color.
- Channels 1, 2 and 3 can be combined to create an unlimited range of colors.
- Channels 1, 2 and 3 have priority over Channels 4, 5, 6 and 7.

Yellow, Cyan, Purple and White

- These colors can not be mixed.
- When levels are raised on more than one of these channels, the lowest channel number will have priority.

Strobe

- Strobe occurs at every channel with exception to programs on Channel 9 and 12.
- Speed of the strobe is adjustable from 0 to 20 Hz.

Mode Selection

- Channel 9 values 5-244 provides mode selection and can only be activated while Channels 1 through 7 are at value 0. When channel 9 is between 245 and 255, channels 1 through 7 can be any value.
- When Color-Cycle mode 4 is selected channel 11 controls the speed.

ID address selection

- Use channel 10 to select ID addressed fixtures.
- Each independent DMX address can have up to 66 ID addressed fixtures.
- ID address "0" allows control of all fixtures simultaneously.

Module selection

- Provides individual control of the three LED modules in each fixture.
- Channel 11 has priority over channel 12.

Effect macro

- These are pre-programmed color patterns and module chases.
- Channel 12 has priority over channels (1, 2, 3, 4, 5, 6 & 7).
- Channel 12 has priority over channel 11 if first activated.

DMX CONTROL MODE 2

CHANNEL	VALUE	FUNCTION
1	000 ⇔ 004	Module 1 No Function
	005 ⇔ 034	Red
	035 ⇔ 064	Green
	065 ⇔ 094	Blue
	095 ⇔ 124	Yellow
	125 ⇔ 154	Cyan
	155 ⇔ 184	Purple
	185 ⇔ 255	Pink-White
2	000 ⇔ 004	Module 2 No Function
	005 ⇔ 034	Red
	035 ⇔ 064	Green
	065 ⇔ 094	Blue
	095 ⇔ 124	Yellow
	125 ⇔ 154	Cyan
	155 ⇔ 184	Purple
	185 ⇔ 255	Pink-White
3	000 ⇔ 004	Module 3 No Function
	005 ⇔ 034	Red
	035 ⇔ 064	Green
	065 ⇔ 094	Blue
	095 ⇔ 124	Yellow
	125 ⇔ 154	Cyan
	155 ⇔ 184	Purple
	185 ⇔ 255	Pink-White
4		No Function
5		
6		
7		
8	000 ⇔ 004	Strobe No Function
	005 ⇔ 255	0 ⇔ 20Hz
9	000 ⇔ 244	Mode Selection DMX MODE 1 (only when channels 1-7 = 0)
	245 ⇔ 255	DMX MODE 2
10	ID Address Selection	See Channel 10 (ID address selection) on page 16 under DMX Control Mode 1
11		No Function
12		

Important Notes about DMX Mode 2

Module selection

- Simplified control of modules using channels 1,2 & 3.

Strobe

- Controls the strobe of channels 1, 2 and 3 simultaneously.
- Speed of the strobe is adjustable from 0 to 20 Hz.

Mode selection

- Use channel 9 to switch between DMX mode 1 and DMX mode 2.

ID address selection

- Channel 10 selects ID addressed fixtures.

5. COLORado™ Controller

Overview

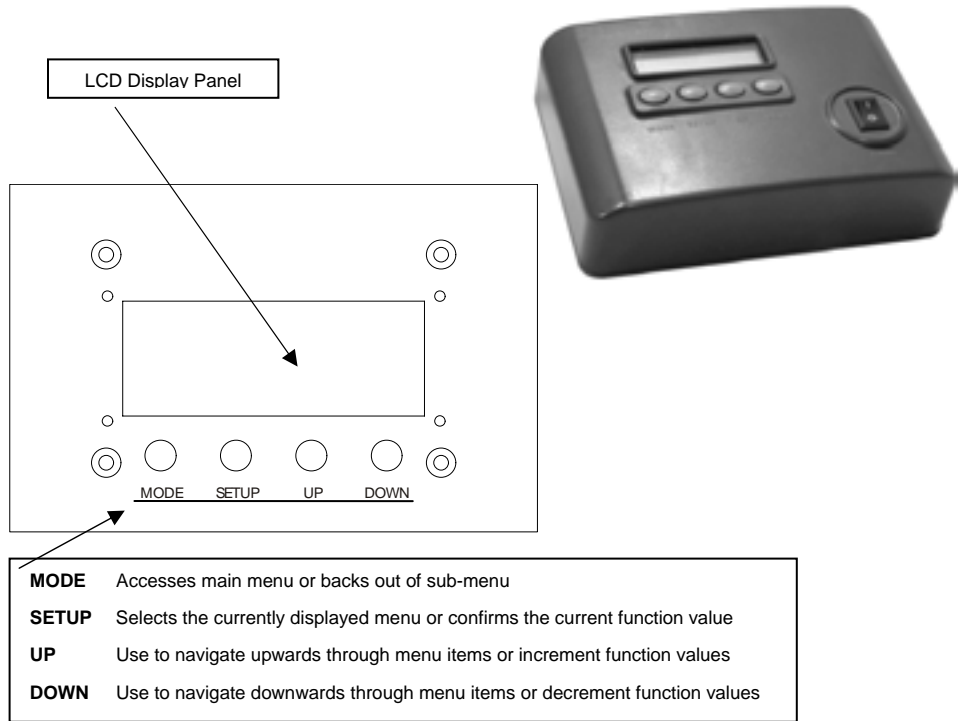

Setup

Connect from the OUT on the controller to the DMX Input side of the COLORado™ using a DMX XLR cable. Visit the section titled: Setting up a DMX Serial Data Link on Page 11.

It is recommended that you power up all COLORado units connected prior to turning on the controller. This ensures that the controller will auto-detect DMX addresses. Alternatively you can use {**Detect device**} from the {**Settings**} menu.

Set ID addresses on the COLORados in ascending order.

Set the {**Range**} in the {**Settings**} menu.

Note There is no need to set ID and Range for {**Wash**} programs.

Menu Map

MAIN FUNCTION	SELECTION	SELECTION	SELECTION	SELECTION
Wash program	Wash [1] ⇕ Wash [8]	Edit	Step time [001] ⇕ [255]	
			Fade time [001] ⇕ [255]	
Effect program	Effect [1] ⇕ Effect [8]	Edit	Speed [001] ⇕ [100]	
Custom program	Custom [1] ⇕ Custom [8]	Edit	Scene [1] ⇕ Scene [100]	ID address [000*] ⇕ [100] (*0 = all units)
				Step time [000] ⇕ [255]
				Fade time [000] ⇕ [255]
				Red [000] ⇕ [255]
				Green [000] ⇕ [255]
				Blue [000] ⇕ [255]
				Module [001] ⇕ [006]
Strobe [000] ⇕ [020]				
Play schedule	Schedule			
Clock	Time now	i.e. 12/31/2006 13:50:24		
	Edit time	i.e. 12/31/2006 13:50:24		
Schedule	Wash [1] ⇕ Wash [8]	Start>>>End 00:00>>00:00		
	Effect [1] ⇕ Effect [8]			
	Custom [1] ⇕ Custom [8]			
Settings	DMX address	[001] ⇕ [255]		
	Range	[001] ⇕ [066]		
	Allow edit	[YES] ⇕ [NO]		
	Detect device	>>>		
	Reset to Factory settings	[YES] ⇕ [NO]		
Password	Password ON/OFF	[ON] ⇕ [OFF]		
	Set password	[]		

Wash Program

Select from the eight existing [**Wash**] programs and it will instantly play.

Set the [**Step time**] and the [**Fade time**] in the [**Edit**] function if desired.

The unit of time is 5 seconds and it can be adjusted between 1 and 255.

Effect Program

Select from the eight existing [**Effect**] programs and it will instantly play.

Vary the [**Speed**] of the effect between 1 and 255.

Custom Program

Select from the eight existing [**Custom**] programs and it will instantly play.

Enter the [**Edit**] section to create or edit program.

You can create or edit up to 100 scenes. To omit a scene from execution set its [**Step time**] to 0.

Select the ID address of the target unit. Setting ID address to 0 selects all units in the serial link. Color/Effects combination for different IDs is allowed.

Specify the [**Module**] or modules to run active.

0 = 1,2,3

1 = 1

2 = 2

3 = 3

4 = 1,2

5 = 2,3

6 = 1,3

RGB mix using the [**Red**], [**Green**] and [**Blue**] functions and adjusting the range between 0 and 255.

Select a [**Strobe**] speed from 0-20Hz if desired.

Select the [**Step time**] for the current scene.

Step time unit values

Range 0 – 10 = 0.1sec per unit

Range 11 – 255 = 1 sec per unit

Set a [**Fade time**] for the current scene in one second increments from 0 to 255.

Play Schedule

Simply activate this menu [**Play schedule**] to run.

Clock

[**Clock**] ⇨ [**Time now**]: To view the current time on the controller.

[**Clock**] ⇨ [**Edit now**]: Edit the time and date.

Schedule

There are 24 **Wash**, **Effect** and **Custom** programs that can be set with Start and End times. Start times take priority over End times. Programs will not overlap. Programs with the most recent Start time will always override the existing previously executed program.

Settings

[**DMX address**]

This function sets the DMX address for the controller. It is addressable from 1 to 250.

[**Range**]

Enter the number of fixtures connected in series.

[**Allow edit**]

This function either enables or disables editing in **Wash**, **Effect** and **Custom** programs.

[**Detect device**]

This is the manual method of detecting and connecting the controller to all new units in series. It is generally used when you add more units to an existing system. Turning off and then on the controller has the same effect.

[Reset to factory settings]

This function will reset all the settings to the factory defaults except for **[Custom]** programs.

Factory Default Settings	
Setting	Default
[Schedule]	All times in schedule are reset to [00:00]
[Wash program]	Step times and fade times are reset to [001]
[Effect program]	Speeds are reset to [001]
[DMX address]	DMX address is reset to [001]
[Range]	Range is reset to [066]
[Allow edit]	Reset to [Yes]
[Password ON/OFF]	Password is reset to [OFF]
[Set password]	Password is reset to [00000000] Down=0, Up=1

Activating password mode

Set **[Password]** function to [ON]. This will prompt the user for a password every time the controller is powered on.

Toggle to **[Set password]** function in order to change the password.

Input an 8 digit password using the **[UP]** & **[DOWN]** keys. Press the **[SET]** button to confirm.

Note In the event that the user forgets the password use the following factory password override:

[UP] ⇨ [DOWN] ⇨ [UP] ⇨ [DOWN] ⇨ [UP] ⇨ [UP] ⇨ [DOWN] ⇨ [DOWN]

Control via external DMX

Programs in the controller can be accessed via an external DMX controller. It will be necessary to have the DMX address set on the COLORado Controller. The controller operates on 4 channels of control.

DMX Channel Values

CHANNEL	VALUE	FUNCTION
1	000 ⇨ 010	Blackout
	011 ⇨ 030	Wash [1]
	031 ⇨ 040	Blackout
	041 ⇨ 060	Wash [2]
	061 ⇨ 070	Blackout
	071 ⇨ 090	Wash [3]
	091 ⇨ 100	Blackout
	101 ⇨ 120	Wash [4]
	121 ⇨ 130	Blackout
	131 ⇨ 150	Wash [5]
	151 ⇨ 160	Blackout
	161 ⇨ 180	Wash [6]
	181 ⇨ 190	Blackout
2	000 ⇨ 010	Blackout
	011 ⇨ 030	Effect [1]
	031 ⇨ 040	Blackout
	041 ⇨ 060	Effect [2]
	061 ⇨ 070	Blackout
	071 ⇨ 090	Effect [3]
	091 ⇨ 100	Blackout
	101 ⇨ 120	Effect [4]
	121 ⇨ 130	Blackout
	131 ⇨ 150	Effect [5]
	151 ⇨ 160	Blackout
	161 ⇨ 180	Effect [6]

	181 ⇔ 190	Blackout
	191 ⇔ 210	Effect [7]
	211 ⇔ 220	Blackout
	221 ⇔ 255	Effect [8]
3	000 ⇔ 010	Blackout
	011 ⇔ 030	Custom [1]
	031 ⇔ 040	Blackout
	041 ⇔ 060	Custom [2]
	061 ⇔ 070	Blackout
	071 ⇔ 090	Custom [3]
	091 ⇔ 100	Blackout
	101 ⇔ 120	Custom [4]
	121 ⇔ 130	Blackout
	131 ⇔ 150	Custom [5]
	151 ⇔ 160	Blackout
	161 ⇔ 180	Custom [6]
	181 ⇔ 190	Blackout
	191 ⇔ 210	Custom [7]
211 ⇔ 220	Blackout	
221 ⇔ 255	Custom [8]	
4	000 ⇔ 127	OFF
	128 ⇔ 255	ON

6. Appendix

DMX Primer

There are 512 channels in a DMX-512 connection. Channels may be assigned in any manner. A fixture capable of receiving DMX-512 will require one or a number of sequential channels. The user must assign a starting address on the fixture that indicates the first channel reserved in the controller. There are many different types of DMX controllable fixtures and they all may vary in the total number of channels required. Choosing a start address should be planned in advance. Channels should never overlap. If they do, this will result in erratic operation of the fixtures whose starting address is set incorrectly. You can however, control multiple fixtures of the same type using the same starting address as long as the intended result is that of unison movement or operation. In other words, the fixtures will be slaved together and all respond exactly the same.

DMX fixtures are designed to receive data through a serial Daisy Chain. A Daisy Chain connection is where the DATA OUT of one fixture connects to the DATA IN of the next fixture. The order in which the fixtures are connected is not important and has no effect on how a controller communicates to each fixture. Use an order that provides for the easiest and most direct cabling. Connect fixtures using shielded two conductor twisted pair cable with three pin XLR male to female connectors. The shield connection is pin 1, while pin 2 is Data Negative (S-) and pin 3 is Data positive (S+). CHAUVET carries 3-pin XLR DMX compliant cables, DMX-10 (33'), DMX-4.5 (15') and DMX-1.5 (5')

Returns Procedure

Returned merchandise must be sent prepaid and in the original packing, call tags will not be issued. Package must be clearly labeled with a Return Merchandise Authorization Number (RA #). Products returned without an RA # will be refused. Call CHAUVET and request RA # prior to shipping the fixture. Be prepared to provide the model number, serial number and a brief description of the cause for the return. Be sure to properly pack fixture, any shipping damage resulting from inadequate packaging is the customer's responsibility. CHAUVET reserves the right to use its own discretion to repair or replace product(s). As a suggestion, proper UPS packing or double-boxing is always a safe method to use.

Claims

Damage incurred in shipping is the responsibility of the shipper; therefore the damage must be reported to the carrier upon receipt of merchandise. It is the customer's responsibility to notify and submit claims with the shipper in the event that a fixture is damaged due to shipping. Any other claim for items such as missing component/part, damage not related to shipping, and concealed damage, must be made within seven (7) days of receiving merchandise.

Maintenance

To maintain optimum performance and minimize wear, fixtures should be cleaned frequently. Usage and environment are contributing factors in determining frequency. As a general rule, fixtures should be cleaned at least twice a month. Dust build up reduces light output performance and can cause overheating. This can lead to reduced lamp life and increased mechanical wear. Be sure to power off fixture before conducting maintenance.

Unplug fixture from power. Clean all glass when the fixture is cold with a mild solution of glass cleaner or Isopropyl Alcohol and a soft lint free cotton cloth or lens tissue. Apply solution to the cloth or tissue and drag dirt and grime to the outside of the lens. Gently polish optical surfaces until they are free of haze and lint.

The cleaning of internal and external optical lenses and/or mirrors must be carried out periodically to optimize light output. Cleaning frequency depends on the environment in which the fixture operates: damp, smoky or particularly dirty surrounding can cause greater accumulation of dirt on the unit's optics. Clean with soft cloth using normal glass cleaning fluid. - Always dry the parts carefully. - Clean the external optics at least every 20 days.

Photometric

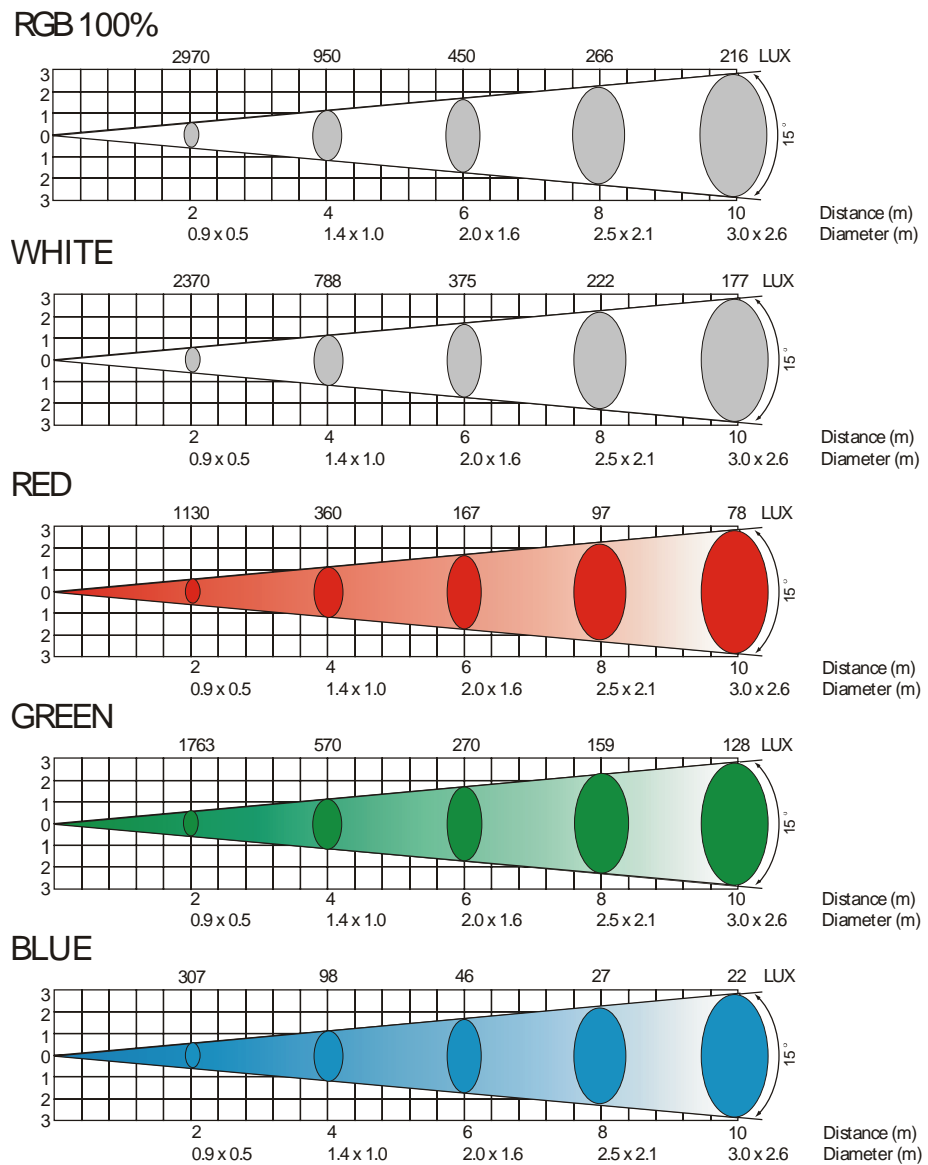

Technical Specifications

WEIGHT & DIMENSIONS

Length.....	22.5 in (570 mm)
Width.....	7.5 in (190 mm)
Height.....	8.3 in (210 mm)
Weight.....	18 lbs (8.2 kg)

POWER

Operating Voltage.....	90V ~ 240V 50/60 Hz
AC input.....	IEC 60320 C14
Current draw.....	(peak <84W @ 120V), (inrush <42W @ 120V)

FUSE

Main.....	20mm Glass 2A Fast Blow
-----------	-------------------------

LED

Quantity.....	54 Total, (Red 18, Green 18, Blue 18)
LED.....	1 Watt

PHOTO OPTIC

Beam Angle.....	18° by 15°
Field Angle.....	34° by 23°
Illuminance at 1 meter.....	675 fc (7,270lux)

CONTROL & PROGRAMMING

Data input.....	locking 3-pin XLR male socket
Data output.....	locking 3-pin XLR female socket
Data pin configuration.....	pin 1 shield, pin 2 (-), pin 3 (+)
Protocols.....	DMX-512 USITT
DMX Channels.....	12

ORDERING INFORMATION

COLORado™ 3.....	COLORADO3
------------------	-----------

Technical Support

Address: Service Dept.
 3000 N 29th Ct, Hollywood, FL 33020 (U.S.A.)
 Support (Email): tech@chauvetlighting.com
 Telephone: (954) 929-1115 - (Press 4)
 Fax: (954) 929-5560 - (Attention: Service)
 Website: <http://www.chauvetlighting.com>