

PROFESSIONAL PORTABLE TRANSCEIVER

QD16-C

USER MANUAL



PRECAUTIONS

Observe the following precautions to prevent fire, personal injury and transceiver damage.

- Do not modify or attempt to adjust this transceiver for any reason.
- Do not expose the transceiver to long periods of direct sunlight, nor place it close to heating appliances.
- Do not place the transceiver in excessively dusty, humid and/or wet areas, nor on unstable surfaces.

CONTENTS

UNPACKING AND CHECKING EQUIPMENT	1
SUPPLIED ACCESSORIES	1
PREPARATION	2-4
INSTALLING / REMOVING THE OPTIONAL BATTERY PACK	2
INSTALLING THE ANTENNA	2
INSTALLING THE BELT CLIP	3
INSTALLING THE COVER OVER THE SPEAKER / MICROPHONE JACKS	3
INSTALLING THE OPTIONAL SPEAKER / MICROPHONE (OR HEADSET)	4
INSTALLING THE HAND STRAP	4
GETTING ACQUAINTED	5
PROGRAMMABLE AUXILIARY FUNCTIONS	6
BASIC OPERATIONS	7
ADVANCED OPERATIONS	8-9
KEY LOCK	8
MONITOR / SQUELCH OFF	8
SCAN	8
PRIORITY SCAN	9
TEMPORARY DELETE	9
REVERT CHANNEL	9
VOICE OPERATED TRANSMISSION (VDX)	10-11
BACKGROUND OPERATIONS	12-13
TIME-OUT TIMER (TOT)	12
BUSY CHANNEL LOCKOUT (BCL)	12
BATTERY SAVE	12
LOW BATTERY WARNING	12
CHANNEL ANNUNCIATION	13
CTCSS / DCS	13

UNPACKING AND CHECKING EQUIPMENT

Carefully unpack the transceiver. We recommend that you identify the items listed in the following table before discarding the packing material. If any items are missing or have been damaged during shipment contact QD Group.

SUPPLIED ACCESSORIES

ITEM		QUANTITY
ANTENNA	66-88MHz	1
HAND STRAP		1
SPEAKER / MICROPHONE JACK COVER		1
SPEAKER / MICROPHONE LOCKING BRACKET		1
BELT CLIP		1
SCREW SET		1
INSTRUCTION MANUAL		1

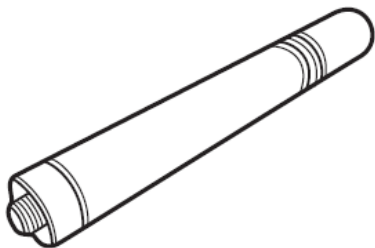

ANTENNA

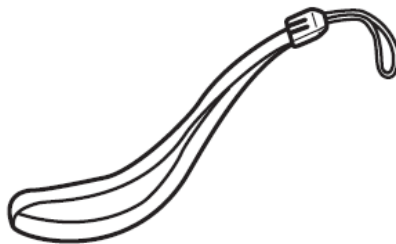

HAND STRAP



JACK COVER

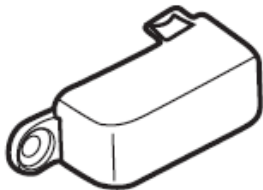

**LOCKING BRACKET
SCREW SET**

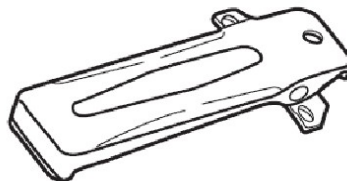

BELT CLIP



INSTRUCTION MANUAL

PREPARATION

INSTALLING/REMOVING THE OPTIONAL BATTERY PACK

The battery pack is not charged at the factory. Charge it before use.



CAUTION

- Do not short the battery terminals or dispose of the battery by fire.
- Never attempt to remove the casing from the battery pack

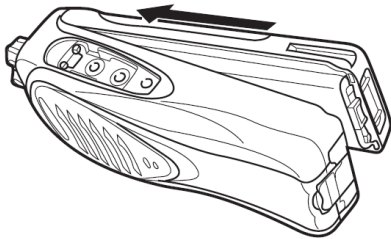

1. Align the battery pack with the back of the transceiver, then press the battery pack and transceiver firmly together until the release latch on the base of the transceiver locks.

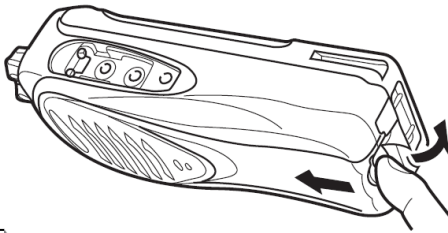

2. To remove the battery pack, lift the safety catch on the base of the transceiver then press the release latch underneath the safety catch.

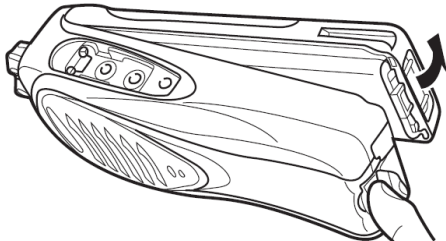

3. While pressing the release latch, pull the battery pack away from the transceiver

INSTALLING THE ANTENNA

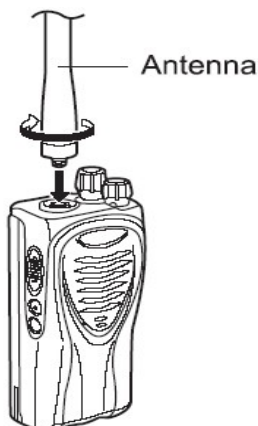

Screw the antenna into the connector on the top of the transceiver, holding the antenna at the base and turning it clockwise until secure.

Note: The antenna is neither a handle, a keyring retainer nor a speaker / microphone attachment point. Using the antenna in these ways may damage the antenna and degrade your transceiver's performance.

INSTALLING THE BELT CLIP

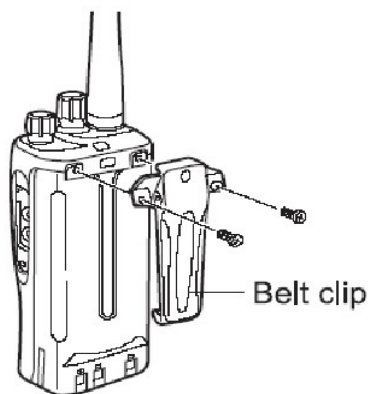

If necessary, attach the belt clip using the two supplied 3x8mm screws.

Note: If the belt clip is not installed its mounting location may get hot during continuous transmission or when left sitting in a hot environment.



CAUTION

Do not use glue which is designed to prevent screw loosening when installing the belt clip as it may cause damage to the transceiver. Acrylic ester, which is contained in these glues, may crack the transceiver's back panel.

INSTALLING THE COVER OVER THE SPEAKER / MICROPHONE JACKS

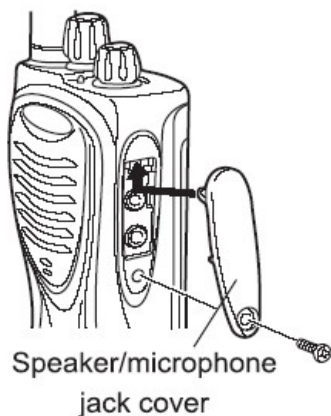

If you are not using a speaker / microphone, install the cover over the speaker / microphone jacks using the supplied 3x6mm screw.

Note: To keep the transceiver water resistant, you must cover the speaker / microphone jacks with the supplied cover.

INSTALLING THE OPTIONAL SPEAKER / MICROPHONE (OR HEADSET)

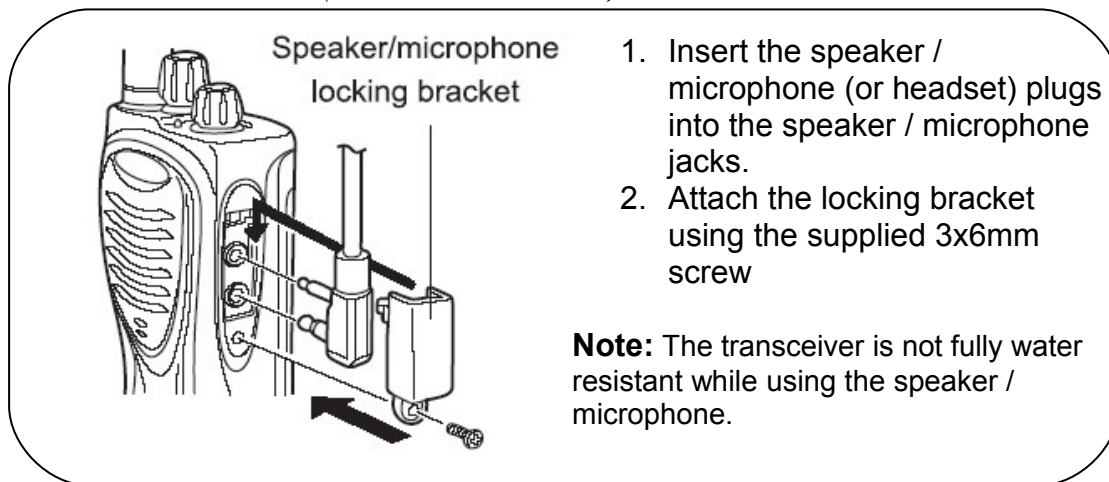

INSTALLING THE HAND STRAP

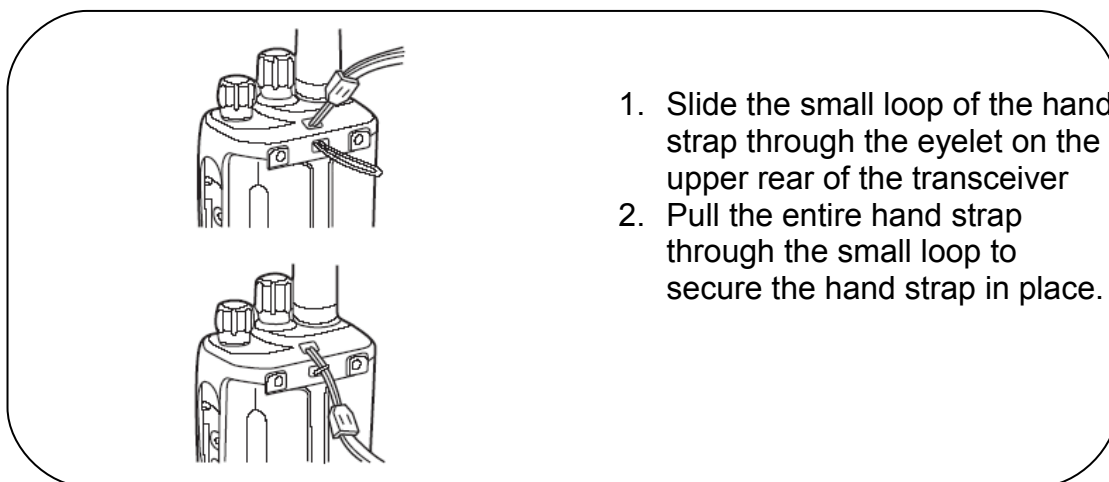

GETTING ACQUAINTED

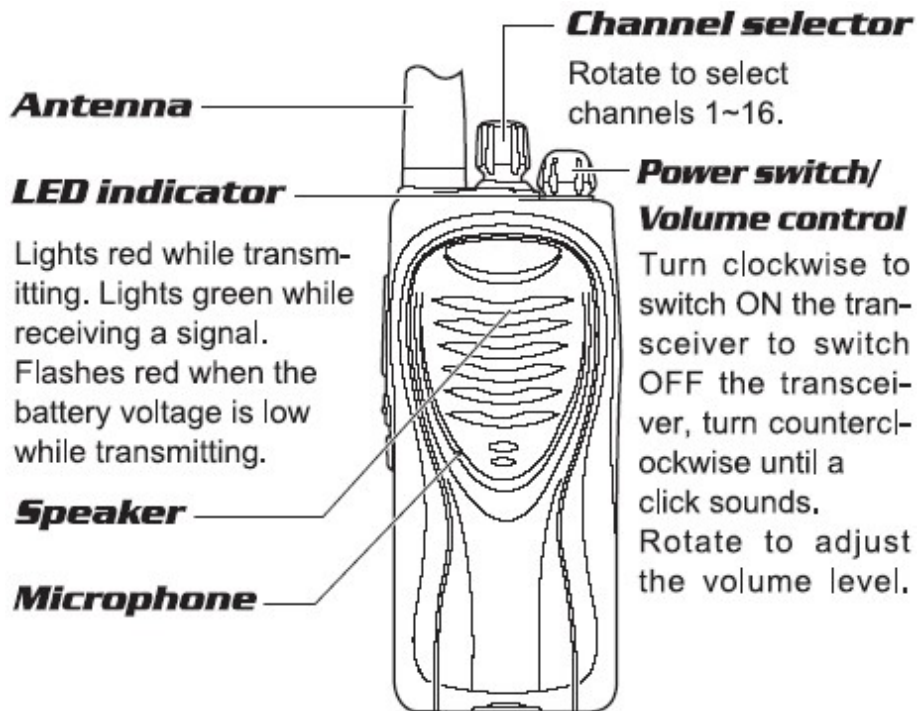

PTT (Push-To-Talk) switch

Press, then speak into the microphone to call a station. Release to receive.

Side 1 key

Press to activate its programmable function

Side 2 key

Press to activate its programmable function

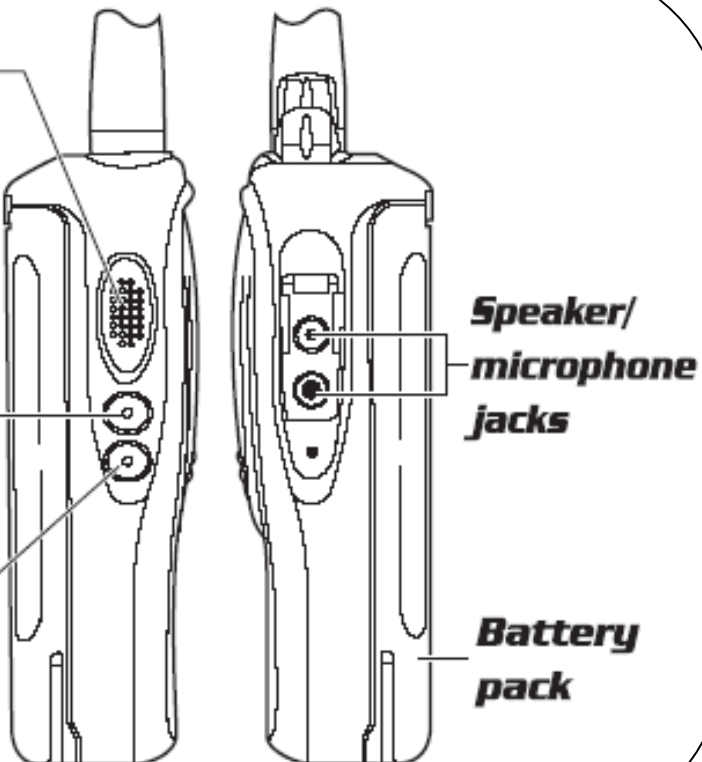

PROGRAMMABLE AUXILIARY FUNCTIONS

Your dealer can program each of the **Side 1** and **Side 2** keys with one of the following auxiliary functions. Refer to their descriptions, starting on page 8.

- Key Lock
- Key Lock (with backup)
- Monitor
- Monitor Momentary
- None (No function) (default setting for Side 1 key)
- Scan
- Scan + Temporary Delete
- Squelch Off
- Squelch Off Momentary (default setting for Side 2 key)
- Temporary Delete

BASIC OPERATIONS

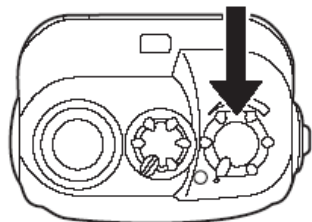

1. Turn the **Power switch / Volume** control clockwise to switch the transceiver power ON

- A beep sounds if enabled by your dealer

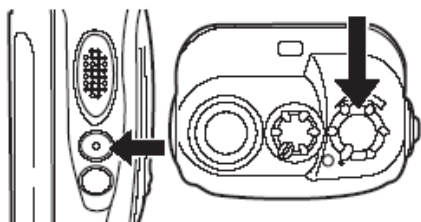

2. Press the key programmed with the **Monitor** or **Squelch Off** function to hear background noise, then release the **Power switch / Volume** control to adjust the volume

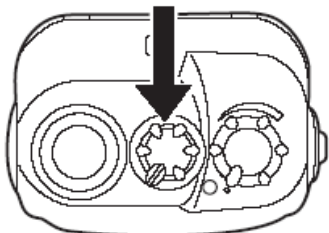

3. Rotate the Channel selector to select your desired channel.

- When you receive an appropriate signal, you will hear audio from the speaker.

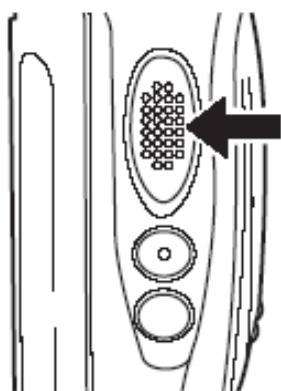

4. To make a call, press and hold the **PTT** switch, then speak into the microphone using your normal speaking voice.

- Hold the microphone approximately 1,5 inches (3-4 cm) from your lips.

5. Release the **PTT** switch to receive.

NOTE

When the battery pack voltage becomes too low, transmission will stop and an alert tone will sound. See “Low Battery Warning” on page 18

ADVANCED OPERATIONS

The following functions are programmable by your dealer as described on page 6.

KEY LOCK

Press and hold the key programmed as Key Lock for 1 second to lock/unlock the transceiver keys. The following keys/functions can still be used when Key Lock is active: Key Lock, Monitor, Monitor Momentary, PTT, Squelch Off, Squelch Off Momentary and Volume.

If the key is programmed "with backup" when the transceiver power is turned OFF and then ON again, the keys remain locked.

Otherwise, when the transceiver power is turned OFF and then ON again, the Key Lock function will be cancelled.

MONITOR / SQUELCH OFF

You can use the key programmed as Monitor or Squelch Off to listen to weak signals that you cannot hear during normal operation, to deactivate channel signalling and to adjust the volume when no signals are present on your selected channel.

- **Squelch Off:** Momentarily press to hear background noise. Press the key again to return to normal operation.
- **Squelch Off Momentary:** Press and hold to hear background noise. Release the key to return to normal operation.
- **Monitor:** Momentarily press to deactivate CTCSS, DCS signal. Press the key again to return to normal operation.
- **Monitor Momentary:** Press and hold to deactivate CTCSS, DCS signal. Release the key to return to normal operation.

SCAN

Scan is useful for monitoring signals on the transceiver channels. When scanning, the transceiver checks for a signal on each channel and only stops if a signal is present.

The transceiver will remain on a busy channel until the signal is no longer present. Your dealer programs the delay time between signal drop-out and Scan resumption. If a signal is received during the delay time, the transceiver will remain on the same channel.



NOTE

You can only use Scan if your dealer has programmed at least 2 channels and they are not locked out of Scan

To start scanning, momentarily press the key programmed as either **Scan** or **Scan + Temporary Delete**

- Scanning starts from the current channel and ascends through the channel numbers.
- The LED indicator flashes green.
- When a signal is received on a channel and signalling matches, the LED indicator lights green.

To end Scan, press the **Scan** or **Scan + Temporary Delete** key again.

PRIORITY SCAN

If enabled, a priority channel is set up one of two ways:

- Your dealer may set up a fixed priority channel on your transceiver.
- You can select your own priority channel, prior to scanning, using the **Channel** selector.
- Your dealer programs the delay time between signal drop-out and scan resumption.

TEMPORARY DELETE

If a key is programmed with the **Temporary Delete** or **Scan + Temporary Delete** function, you can temporarily remove specific channels from the scanning sequence during Scan. When Scan stops at a channel, you can remove that channel from the scanning sequence by pressing and holding the key programmed as **Temporary Delete** or **Scan + Temporary Delete** for 1 second.

- You cannot delete the Priority channel, if one has been set up.
- You cannot delete a channel if there will be less than 2 channels available for scanning remaining.
- To add the channel back into the Scan list, simply exit Scan mode or switch the transceiver OFF and then ON again.

REVERT CHANNEL

During Scan, pressing the PTT switch to transmit will cause the transceiver to select the revert channel. Your dealer can program the revert channel using one of the following methods:

- **Selected:** The last channel selected is assigned as the new revert channel.
- **Selected + Talkback:** If the channel has been changed during Scan, the newly selected channel is assigned as the new revert channel. However, the transceiver also transmits on the channel where Scan is currently paused.
- **Priority:** If your dealer has programmed a Priority channel, it is the revert channel.
- **Priority + Talkback:** If your dealer has programmed a Priority channel, it is the revert channel. However, the transceiver also transmits on the channel where Scan is currently paused.

VOICE OPERATED TRANSMISSION (VDX)

VDX operation allows you to transmit hands-free. This feature must first be activated by your dealer and can only be used if you are using a supported headset.

When operating VDX, you must set a VDX Gain level. This setting allows the transceiver to recognize sound levels. If the microphone is too sensitive, it will begin transmitting when there is noise in the background. If it is not sensitive enough, it will not pick up your voice when you begin speaking. Be sure to adjust the VDX Gain level to an appropriated sensitivity to allow smooth transmission.

To activate VDX and set the VDX Gain level, perform the following steps:

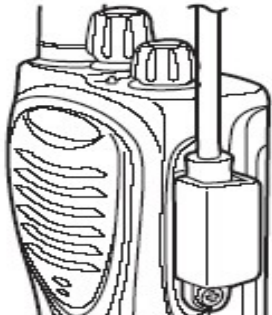

1. Connect the headset to the transceiver (page 4)

- The VDX function does not activate when a headset is not connected to the accessory terminal of the transceiver

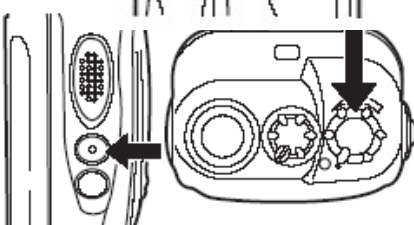

2. With the transceiver power OFF, press and hold the **Side 1** key while tuning the transceiver power ON.

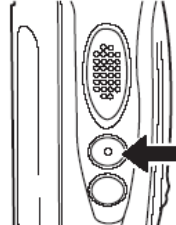

3. Continue to hold the **Side 1** key until a beep sounds.

- The LED indicator lights orange.
- When the **Side 1** key is released the transceiver announces the VDX Gain level

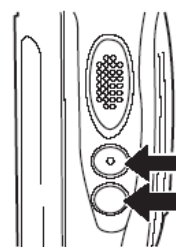

4. Press the **Side 1** key to increase the VDX Gain level and the **Side 2** key to decrease the level

- The VDX Gain can be adjusted from levels 1-10 and OFF
- The transceiver announces the VDX Gain level as you adjust it. If OFF is selected, a beep sounds

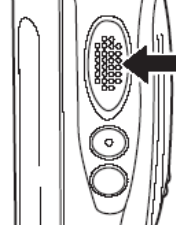

5. Press the **PTT** switch to save the setting

- A beep will sound.
- The transceiver announces the new VDX Gain level.

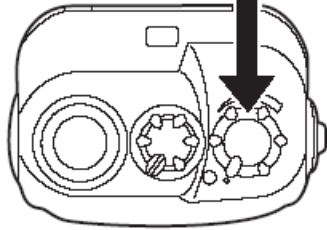

6. Turn the transceiver power OFF and then ON again to activate VDX

! *NOTE*

- The speaker/microphone is connected to the transceiver while the VDX function is switched ON and VDX Gain level is configured to a higher, more sensitive level. Louder received signals may cause the transceiver to start transmission.
- When you operate the VDX function, you must use an optional KHS-1 or KHS-21 accessory.

BACKGROUND OPERATIONS

TIME-OUT TIMER (TOT)

The purpose of the Time-out Timer is to prevent any caller from using a channel for an extended period of time. If you continuously transmit for a period of time that exceeds the programmed time set by your dealer (default is 1 minute) the transceiver will stop transmitting and an alert tone will sound. To stop the tone, release the PTT switch. Your dealer can program a warning function to alert you before the TOT expires. Continuously transmitting for the time specified by your dealer will cause the warning tone to sound.

BUSY CHANNEL LOCKOUT (BCL)

When activated, BCL prevents you from interfering with other parties who may be using the same channel that you selected.

Pressing the PTT switch while the channel is in use will cause your transceiver to emit an alert tone and transmission will be inhibited (you cannot transmit). Release the PTT switch to stop the tone and return to receive mode.



NOTE

Ask your dealer for an explanation on how BCL functions when using CTCSS/DCS

BATTERY SAVE

If activated by your dealer, the Battery Save function will decrease the amount of power used when a signal is not being received and no operations are being performed (no keys are being pressed and no switches are being turned). While the channel is not busy and no operation is performed for 5 seconds, Battery Save turns ON. When a signal is received or an operation is performed, Battery Save turns OFF.

LOW BATTERY WARNING

Low Battery Warning alerts you when the battery needs to be recharged or replaced.

While operating the transceiver, if the battery power becomes low, an alert tone will sound every 30 seconds and the LED indicator will blink red. Replace or recharge the battery pack.

CHANNEL ANNUNCIATION

When changing the channel using the Channel selector, an audio voice will announce the selected channel number after you stop changing the channel (Channel Annunciation can be activated or deactivated by your dealer)

CTCSS/DCS

Your dealer may have programmed CTCSS or DCS signalling on your transceiver channels. A CTCSS/DCS tone or CTCSS/DCS code is a sub-audible tone/code, which allows you to ignore (not hear) calls from other parties who are using the same channel.

When a channel is set up with a CTCSS/DCS tone or CTCSS/DCS code, squelch will only open when a call containing a matching tone or code is received. Likewise, signals that you transmit will only be heard by parties whose CTCSS/DCS signalling matches your transceiver.

If a call containing a different tone or code is made on the same channel you are using, squelch will not open and you will not hear the call. This allows you to ignore (not hear) these calls.

Although it may seem like you have your own private channel while using CTCSS/DCS, other parties can still hear your calls if they set up their transceiver with the same tone or code.



Silverstone Crescent
Kyalami Business Park
P.O. Box 76117,
Wendywood, 2144
Tel. (011) 996-4400
Fax. (011) 466-1878
Web: <http://www.qd-group.co.za>