

AUTOMATIC ESPRESSO COFFEE GRINDER # 55

USER AND MAINTENANCE MANUAL



IMPORTANT: documents included in this manual to be kept:

- "CE" COMPLIANCE DECLARATION
- WARRANTY CERTIFICATE

Translation of the original version

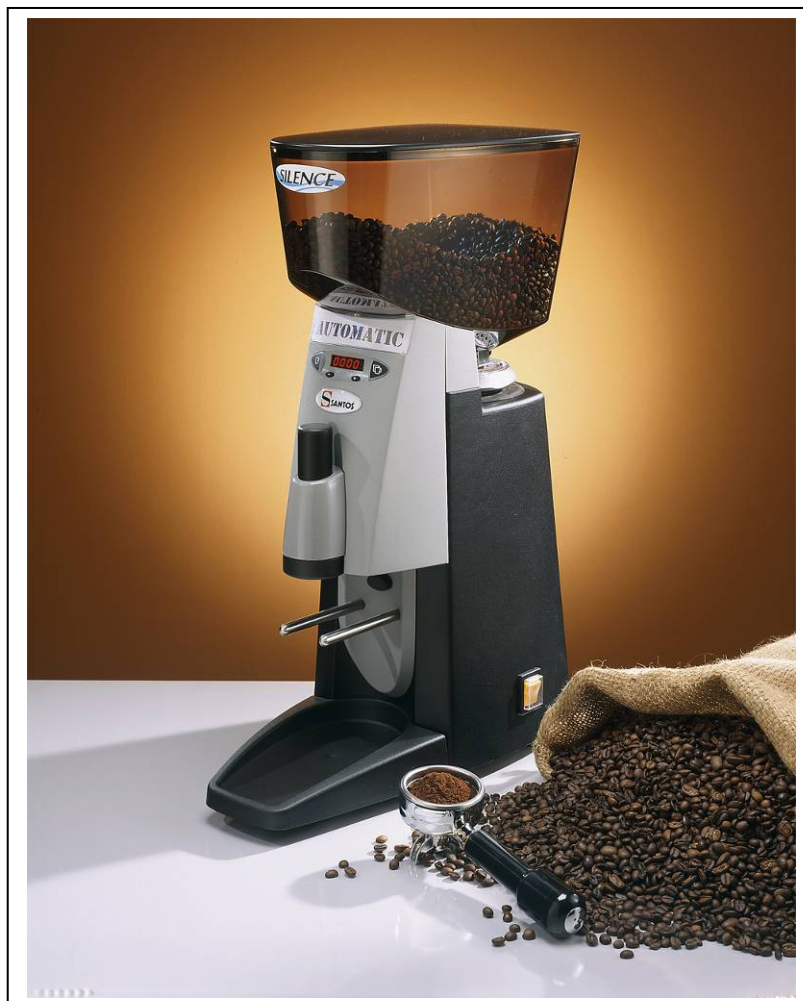

*Coffee grinders - Fruit juicers - Mixers - Blenders - Drinks dispensers - Planetary mixers
Cheese graters - Ice crushers - Mincers - Vegetable slicers - Dough mixer*

INTERNATIONALLY PATENTED MODELS



CONTENTS

“CE” COMPLIANCE DECLARATION	4
IMPORTANT SAFEGUARDS	5
<i>INSTALLATION AND HANDLING.....</i>	<i>5</i>
<i>IMPROPER USE</i>	<i>5</i>
<i>ELECTRICAL CONNECTION</i>	<i>6</i>
<i>USING FOR THE 1ST TIME</i>	<i>6</i>
<i>RECYCLING THE PRODUCT AT THE END OF ITS SERVICE LIFE.....</i>	<i>6</i>
YOUR BAR ESPRESSO COFFEE GRINDER No. 55.....	7
<i>CONTROL PANEL PERSONALISATION.....</i>	<i>7</i>
USING THE MACHINE.....	8
<i>CONTROL PANEL DESCRIPTION.....</i>	<i>8</i>
<i>MEASURE SELECTION.....</i>	<i>8</i>
<i>DISPLAY MODE SELECTION</i>	<i>8</i>
Mode 1: Display of the Total measures distributed.....	8
Mode 2: Display of the Partial measures distributed since last reset.....	8
Mode 3: Display of the current selection (the counters are hidden).....	9
<i>STARTING UP:.....</i>	<i>9</i>
<i>USING:</i>	<i>9</i>
Grinding adjustment:	10
Setting the measured dose of ground coffee (timers):	11
Initialising the factory parameters	12
<i>CLEANING:.....</i>	<i>13</i>
<i>MAINTENANCE</i>	<i>13</i>
Spare parts:	13
Replacing the grindstones:.....	13
FAULT FINDING.....	15
The machine will not start:	15
The machine stops as a result of motor over-heating: (the motor unit is hot)	15
The machine stops as a result of an overload:	15
The ground coffee dose measurement is not consistent	16
The machine runs but without the filling filter holder.....	16
The espresso coffees are getting weaker and weaker	16
The machine does not work after having changed the timer settings.....	16
The machine does not work following a power cut.....	16
MACHINE TECHNICAL SPECIFICATIONS	17
<i>TECHNICAL SPECIFICATIONS.....</i>	<i>17</i>
<i>110-120V 50/60Hz and 220-240V 50/60Hz wiring diagram.....</i>	<i>18</i>



<i>Element cross-reference table</i>	19
WARRANTY CERTIFICATE	22
APPLIANCE IDENTIFICATION PLATE	22



“CE” COMPLIANCE DECLARATION

THE MANUFACTURER:

SANTOS sas - 140-150, Av. Roger SALENGRO 69120 VAULX-EN-VELIN (LYON)
FRANCE

declares that the appliance intended for the professional market described below:

Description: **Automatic espresso coffee grinder**
Type number: **55**

complies with:

- the statutory provisions defined in appendix 1 of the European "machines" directive n°**2006/42/CE** and the national legislation transposing it
- the statutory provisions of the following European directives and regulations:
 - N° 2006/95/CE (low voltage directive)
 - N° 2004/108/CE (EMC directive)
 - No. 2002/95/CE (RoHS directive)
 - No. 2002/96/CE (WEEE directive)
 - N° 1935/2004/CE (regulation) relating to materials and articles intended to come into contact with foodstuffs

Harmonised European standards used to give presumption of conformity with the essential requirements of the above-mentioned directives:

- NF EN ISO 12100 -1 and 2:2004: Safety of machinery - General principles for design
- NF EN 60204-1: 2006 : Safety of machinery - Electrical equipment of machines- General requirements
- NF EN 1672-2: 2005, Food processing machinery – Basic concepts – Hygiene requirements
- NF EN 60335-1: 2013 Safety of household and similar electrical appliances
- EN 60335-2-64: 2004 Part 2-64: Particular requirements for commercial electric kitchen machines.

Drawn up in VAULX-EN-VELIN on: **01/05/2014**

Signatory's position: **CHIEF EXECUTIVE OFFICER**

Signatory's name: **Aurélien FOUQUET**

Signature:

IMPORTANT SAFEGUARDS

When using, cleaning or maintaining the machine, always follow these instructions:

Read all instructions

Note: You will find it easier to understand the next few paragraphs if you refer to the diagrams at the end of this manual.

INSTALLATION AND HANDLING

Just one person is required for handling the appliance. For ease of use, it is recommended that the machine is placed on a table or work surface so as to have the control panel in front of you (recommended height: 90 cm, to be adapted to suit the user).

IMPROPER USE



1. The appliance is not intended for a continuous operation (maximum usage range: 10 seconds in operation and 20 seconds stopped)
2. Do not use this appliance for grinding anything other than roasted coffee beans.
3. Never operate the appliance with no coffee beans in the bean container.
4. Remove from the coffee beans any foreign bodies which may damage the grinding wheels (metal staples, stones, etc.).
5. For electrocution risk protection reasons, never plunge the base into water or any other liquid.
6. Use a hose nor a pressure hose for cleaning: this is forbidden
7. Never touch the moving parts.
8. The appliance must not be used on any surface which has a slope of more than 10° relative to horizontal. The machine's 4 feet must always be resting on that surface.
9. Unplug the appliance before carrying out any work on it: cleaning, maintenance or repair.
10. Do not use the appliance if the power supply cord is damaged. It must be replaced by either a SANTOS approved dealer or a person with similar qualifications to avoid any danger.
11. The use of spare parts other than certified SANTOS original parts is prohibited.
12. Turn the On/Off switch (11) to "0" when the appliance is not operating.
13. Connect several appliances to the same power socket.
14. Use the appliance outdoors.
15. Never place the appliance close to or on a source of heat.
16. This appliance is a professional machine designed exclusively for professional use. It is not designed for household use.
17. This appliance is not designed for use by people (including children) whose physical, sensorial or mental capacities are impaired or by people with no experience or knowledge, unless they have been supervised or given training in the use of the appliance beforehand by a person responsible for their safety. Supervise children to ensure they do not play with the appliance.

ELECTRICAL CONNECTION

- The electric power supply for the machine is available in 2 single-phase voltages:
 - 110-120 V 50/60 Hz: Model 55V1
 - 220-240 V 50/60 Hz: Model 55

Line protection: the machine should be connected to a standard 2-pole + earth electric socket. The system should be fitted with an RCD and a fuse rated at 16A. **The appliance must be earthed** (fig. B).

CARE:

- Before connecting the machine, check that the mains electrical voltage is the same as the voltage for your appliance. Its value is shown:
 - either on the identification plate (**16**) under the machine.
 - or on the identification plate on the last page of this manual.



If the power cable (**10**) is damaged, it should be replaced by a SANTOS approved dealer, SANTOS or a person with similar qualifications to avoid any danger.

CARE: Check that the On / Off switch (**11**) is in the **0 position** before connecting the power cable plug (**10**) to your mains electric power socket (fig. A).



USING FOR THE 1ST TIME

Carefully clean the parts in contact with the coffee (fig. A).

- Take off the lid (**1**), the bean container (**2**) and the ground coffee collector (**3**) and wash them with a standard dish washing product.

RECYCLING THE PRODUCT AT THE END OF ITS SERVICE LIFE



This equipment is marked with the selective sorting symbol relating to wastes from electrical and electronic equipment. It signifies that this product should be taken over by a selective collection system conforming to the Guideline 2002/96/EC (WEEE) – part Professional Equipment – so that it can be either recycled or dismantled in order to reduce any impact on the environment.

For more information, please contact your Retailer or the SANTOS.

For eliminating or recycling components of equipment, please contact a specialized company or contact SANTOS.

The electronic products not undergoing a selective sorting are potentially dangerous for the environment.

The damaging materials should be eliminated or recycled according to the regulations in force.

YOUR BAR ESPRESSO COFFEE GRINDER No. 55

- The silent bar espresso coffee grinder No. 55 is designed for bars, cafés, hotels and restaurants. It is suitable for all types of espresso coffee machine.
- The machine consists of an aluminium grinder unit and base, a transparent plastic bean container, and an electronic system combining the dose measurer and a dose counter.
- The machine can be used to grind roasted coffee and to dispense it via an electronic dose measurer.
- The following adjustments can be made:
 - Adjustment of the grinding fineness (from Filter, Fine to Espresso)
 - Adjustment of the ground coffee measure dispensed (from approximately 5.5g to 20g).

CONTROL PANEL PERSONALISATION

You can personalise the control panel label, for example to show the brand of coffee served and the type of coffee, or simply to identify the coffee used if you have more than one appliance side by side (with more than one type of coffee).

Templet for the personalised label. Print to scale 1:1 then cut out.

You can produce a personalised label directly on our Internet site (Word document).

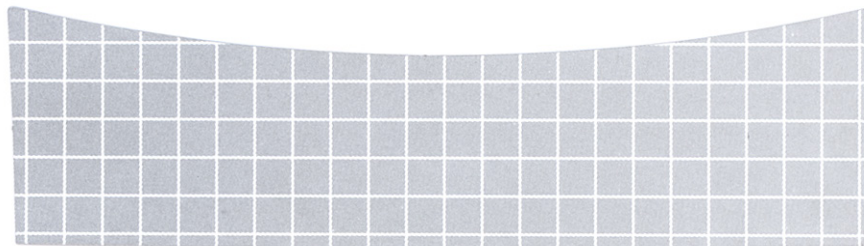



USING THE MACHINE

The machine provides automatic delivery of the required measure of coffee ground there and then for making:

- 1 espresso coffee (1 measure selection)
- 2 espresso coffees (2 measures selection).

CONTROL PANEL DESCRIPTION

The control panel is made up of: (fig. A)

- a screen **(19)** (measure counter and adjustment display),
- a "1 coffee" selection button **(20)**,
- a "2 coffees" selection button **(21)**
- 2 "+" and "-" setting buttons **(22)**.

MEASURE SELECTION

2 separate buttons provide selection by pushing just once.

- Selection button 1 for 1 coffee **(20)**
- Selection button 2 for 2 coffees **(21)**

A luminous indicator showing the measure selected lights up according to the selection.

The measure selected is automatically dispensed as soon as the user places the filter holder under the ground coffee outlet tube (23) (fig. H).

DISPLAY MODE SELECTION

Pressing the "1 coffee" or "2 coffees" selection key **which is already illuminated** provides the means for changing the display mode.

Note: On turning on the power or after having changed the timer values, "mode 1" is automatically active. Operating either of the 2 measure selection keys, or changing the timers, activates the active display mode before the appliance stops.

Mode 1: Display of the Total measures distributed

The Total counter cannot be reset

Mode 1 display format "XXXXX" i.e. "00001" to "99999"

Mode 2: Display of the Partial measures distributed since last reset

Partial counter initialisation.

Pressing and holding down both the "1 cup" and "2 cups" selection keys for 2 seconds causes the Partial counter value to flash. After flashing 3 times, the value is reset to zero.

Mode 2 display: "PXXXX" i.e. "P---1" to "P9999"



Mode 3: Display of the current selection (the counters are hidden)

Mode 3 provides the means for hiding the counters.

Mode 3 display:

" 1 " for the 1 cup selection

" 2 " for the 2 cup selection

STARTING UP:

Assembly and preparation:

(fig. A)

1. **Clip the ground coffee collector (3)** onto the base (4).
2. **Placer the bean container (2)** on the grinder unit adjustment nut (5).
3. **Pour the roasted coffee beans** into the bean container and put the lid on the bean container.
4. Open the bean container shutter (6).

USING:

1. Switch the electric current on to the machine by putting the On / Off switch (11) to **the 1 position** (the control panel display (19) shows the total number of measures dispensed) (fig. A).
2. Press the selector button (20 or 21) according to your selection (1 coffee or 2 coffees).
3. Place the filter holder under the measurer outlet (23) using the filter holder support (24) to help.
4. The coffee beans are then ground by the grindstones and the grounds come out of the grinder unit to fill the filter holder.
5. Remove the filter holder and tamp down the coffee with the tamper (15).

Note: If the 1 coffee button is already selected and you want to make 1 coffee again, you do not need to press the 1 coffee button again. Simply put the filtre holder under the coffee outlet tube to obtain the measure selected.

If the 1 coffee button is already selected and you want to make 2 coffees, you have to press the 2 coffees button and then place the filter holder under the coffee outlet tube to obtain the measure selected

Grinding adjustment:

CARE: Changing the grinding setting will always require resetting the timers. See the information chart in the next section:

Note: Never operate the machine with the two grindstones in contact. Letting the grindstones come into contact may result in the grindings jamming in the grinder unit and premature wear of the grindstones.

The machine is set in the factory for the "0" marker on the nut (5) graduated plate to correspond to the finest grinding without the grindstones touching (fig. C).

On delivery, the machine is set to an espresso-type grinding with the adjusting nut (5) on the **6 marker**

1. Hold the adjustment nut (5) with one hand and press the indexing pointer (7) with the other
2. Tighten the adjustment nut by turning in a clockwise direction (right-handed thread) by one or two notches for finer grinding.
3. Loosen the adjustment nut by turning in an anti-clockwise direction (right-handed thread) by one or two notches for coarser grinding.
4. Release the indexing pointer (7) to lock the nut in position.
5. Draw off a few measures of coffee to check the grinding adjustment.

The machine can provide very fine grinding. However, depending on the type of coffee used, be careful not to bring the grindstones into contact as this would cause the output to drop considerably and alter the coffee aroma.

Setting the measured dose of ground coffee (timers):

The ground coffee outlet tube (23) should be cleaned regularly to prevent the coffee which has built up on the walls from interfering with the consistency of the coffee dose measurement (fig. H).



IMPORTANT: Check or adjust the grinding before setting the timers.
Where the timers are being set following adjustment of the grinding, you can use the chart BELOW

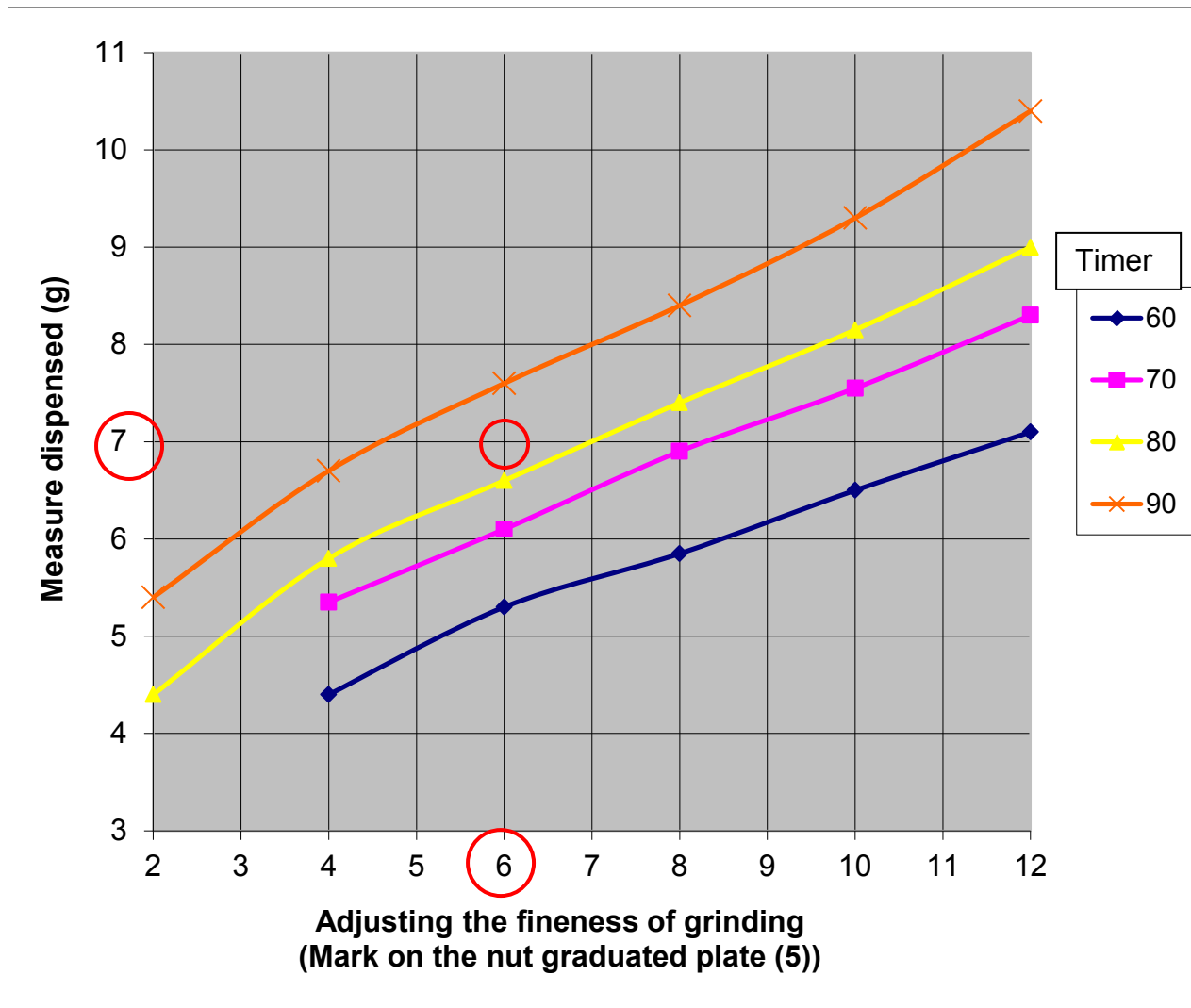

Approximate values for one measure and for new SANTOS grindstones

Explanatory notes for the table:

For example: you have made your grinding setting, which corresponds to "Notch 6" on the grinding adjustment nut (5). If you want to obtain a 7g measure of coffee, you will need to set the value of the timer to between 080 and 090 for an espresso type coffee.



The 2 selector buttons are set independently (fig. D).

Generally speaking:

The 2 "+" and "-" buttons (22) are used to increase or decrease the values and the "Selection" buttons (20 and 21) are used to confirm the timer values.

Pressing simultaneously on both the "+" and "-" buttons (22) for 2 seconds activates the "timer setting" mode".

"1 XXX" appears on the screen (timer 1 value) and the "1 coffee" button (20) flashes (indicating setting of the value of the 1 coffee timer)

- pressing the "+" button increases the value by one unit
- pressing the "-" button decreases the value by one unit
- pressing either of the 2 "Selection" buttons confirms the value displayed and gives access to setting of the timer "2". The value of the timer "2" appears.

"2 XXX" appears on the screen (timer 2 value) and the "2 coffee" button (21) flashes (indicating setting of the value of the 2 coffees timer).

- pressing the button "+" increases the value by one unit
- pressing the button "-" decreases the value by one unit

pressing either of the 2 "Selection" buttons confirms the value displayed, saves it and returns the machine to the normal operating mode.

Timer setting range

No. 1 "1 coffee": from 40 to 499

No. 2 "2 coffees": from 80 to 999

The machine is set in the factory. You can initialise the factory parameters at any time.

Initialising the factory parameters

1. Turn the machine off (On / Off switch (11) to the (0) position)
2. With one hand, press and hold down both the "+" and "-" adjustment buttons and then at the same time turn the power on (On / Off switch (11) to the (1) position). A test procedure is launched at the end of which the factory parameters are reinitialised.

If you release either of the buttons during the test phase, the initialisation is cancelled and your settings retained.

CLEANING:

IMPORTANT:



- In all circumstances, the machine should be stopped and the machine's power supply cable (10) unplugged.
- Do not clean with a water spray or pressure jet

The ground coffee outlet tube (23) should be cleaned regularly using a commercially-available bottle-brush (fig. H).

MAINTENANCE

Before carrying out any work on the machine, it must be unplugged from the mains and the motor start capacitor discharged.

Discharging the capacitor:



- Unscrew the 2 screws located under the machine in the middle of the base plate (fig. E).
- Pull the electrical components unit (26) out of the base plate.
- Using a screwdriver with an **insulated handle**, touch the 2 capacitor connections (14). You should see an electric arc which means that the capacitor has been discharged.

Spare parts:

This machine requires no specific maintenance. The bearings are lubricated for life. If work is required to replace worn parts such as the grindstones or the electric or other components, refer to the parts list (see exploded view at the end of the manual).

For **all spare part orders** (see references in the exploded view at the end of the manual), state:

- the type,
- the machine serial number and
- the electrical specifications (16)

recorded under the machine.

Replacing the grindstones:



IMPORTANT: always replace both 2 grindstones (9) at the same time. (use SANTOS reference 00001B).

The 2 grindstones are identical and can be fitted equally either on the moving plate (8) (moving grindstone) or on the adjusting nut (5) (fixed grindstone) (fig. F).

1. Close the bean shutter (6) (fig. G).
2. Run the machine until the coffee beans waiting in the grinder body have passed through.

3. Stop the machine and unplug the mains power lead (10).
4. Take off the bean container (2).
5. With one hand, press the **indexing pointer (7)** and with the other unscrew the adjustment nut by turning it in an anti-clockwise direction (fig. I).

Care: When this part is fully unscrewed, handle it with care so as not to damage the brass thread.

6. Unscrew the three screws of each grinder (fig. J). For blocking the rotation of grinder holding plate while unscrewing or screwing the fastening screws of movable grinder, place a screwdriver, non aggressive, between the grinding body and one of the fins of the plate.



ATTENTION: Do not introduce the screwdriver in the coffee output hole. This may destroy the anti-static strip and damage the operation of the equipment.

7. Carefully clean the whole grinder body, in particular the grindstone facing areas.
8. Place each grindstone on its support making sure that there is no coffee dust between the grindstone and its support.



CARE: The slightest small coffee particle under the grindstone may prevent the machine from operating correctly. It is recommended that the grinder body is cleaned with a compressed air jet or a dry brush.

CARE: Do not unscrew the retaining shaft (17) from the grindstone carrier plate (8) so as not to upset the assembly geometry (fig. K).

9. Once the 2 grindstones have been replaced, with one hand press the indexing pointer (7) and with the other place the ground coffee adjustment nut (5) onto the grinder body taking care not to damage the thread. Without using force, put the "nut" (5) on the grinder body unscrewing it gently to feel for alignment of the two threads and thus to be able to feed them in **without using force**. Then tighten until the 2 grindstones come into contact (fig. L).
10. Unscrew the "adjustment nut" (5) by ten or so notches to free the grindstones in contact.
11. Plug the machine in and switch it on with no coffee.
12. While pressing the indexing pointer with one hand, with the other screw up the "adjustment nut" (5) until the 2 grindstones make **slight** contact (slight noise).
13. Stop the machine.
14. Unscrew the graduated plate (12) retaining screws and re-index the graduated plate "0" with the indexing pointer (7) (fig. M).
15. Loosen the "adjustment nut" (5) by 5 to 10 notches.
16. With coffee in, adjust the ground coffee setting (see "**Grinding adjustment**" section).
17. Next, set the timers if the new grindstones have changed the machine output (see "**Setting the measured dose of ground coffee**" section).

FAULT FINDING

Carefully determine the reason for the machine stopping.

In all circumstances, if the problem persists, disconnect the electric power supply (unplug the mains supply lead plug **(10)**) and call on someone from the maintenance department or contact an approved SANTOS dealer.

Where appropriate, do not forget to close the bean container shutter **(6)** before removing the container.

The machine will not start:

- Check that the On / Off switch indicator **(11)** lights up when the switch is in the **1** position. If not, check the following 2 points, then replace the switch.
- Check that the amperometric protector has not tripped following an overload. (See "**The machine stops as a result of a motor overload**" paragraph)
- Check: the mains power supply and the condition of the power supply lead **(10)**.
- Check that the display **(19)** lights up (it shows the total number of measured doses) If not, replace the control part of the electronic module.
- Check that the 2 selector buttons are on (press one of the buttons).
- Check that the grindstones **(9)** are not making contact preventing the motor from starting.
- Check that there are no foreign bodies stuck between the grindstones.
- Inside the machine, check the condition of the electric wiring and the connections (on the switch **(11)**, on the component support module **(26)** (fig. N) (the electric components can be accessed without dismantling the machine), on the control panel **(19)** and on the filter holder micro-switch **(25)**).
- Check the electric components, replacing them one by one.

The machine stops as a result of motor over-heating: (the motor unit is hot)

(220V version)

The motor is protected by an integral thermal protection. If the motor overheats, it stops.

- Check that there are still coffee beans in the bean container **(2)**.
- Put the On / Off switch **(11)** to the **0** position and unplug the machine.
- Wait for the motor to cool down (20 to 45 minutes) then press the On / Off switch **(11)** (position **1**).

The machine stops as a result of an overload:

A foreign body between the grindstones, grindstones making contact, too fine coffee grinding or intensive operation may result in a motor overload.

Under these circumstances, either the thermal protection or the excess current protection may be activated and stop the machine from operating.

If the machine is hot, refer to the section "The machine stops as a result of motor over-heating").

Otherwise:

- Turn off the electric power supply (unplug the mains power lead **(10)**)
- Move the On / Off switch **(11)** to the **0** position.



- Under the machine (fig. O), press the button (13) to reset the excess current protection. If the button does not remain in the "reset" position, allow the machine to cool down before repeating the operation.

If the problem persists, turn the machine electric power off (unplug the mains power lead (10)) and call on someone from the maintenance department or contact an approved SANTOS dealer.

The ground coffee dose measurement is not consistent

- Check that there are coffee beans in the bean container. It is recommended that there is a minimum of 400g of coffee beans in the hopper.
- Clean the ground coffee outlet tube (23) (fig. H).

The machine runs but without the filling filter holder

- Check that there are coffee beans in the bean container.
- Check that the bean container shutter (6) is in the open position.
- Try with a coarser grind setting
- Replace the grindstones (9).

The espresso coffees are getting weaker and weaker

- Check and adjust the grinding setting then
- Check and adjust the timer settings. (The timer values increase depending on the wear on the grindstones. If the values are too high, then replace the grindstones (9).

The machine does not work after having changed the timer settings

- For safety reasons, the motor is disabled during the timer setting stage. To prevent any sudden motor start at the end of that phase, the user must activate the machine manually by selecting one of the 2 buttons (20 or 21).
- Select one of the 2 buttons (20 or 21).

The machine does not work following a power cut

- Ditto previous point
- Select one of the 2 buttons (20 or 21).

MACHINE TECHNICAL SPECIFICATIONS

TECHNICAL SPECIFICATIONS

Model 55		Single phase
Power supply voltage	(V)	220-240 100-120
Frequency	(Hz)	50/60 50/60
Motor: rating		
Input power	(W)	1150 800
Speed:	(rpm)	2850 at 50Hz 3400 at 60Hz
Bean container capacity	(kg)	2.2
Grindstone diameter	(mm)	63.5
Average output	(Kg/h)	25
Timer no. 1 setting		40 to 499
Timer no. 2 setting		80 to 999
Dose measurement settings (approx.)	(g)	From 5.5 to 20
The appliance is not intended for a continuous operation		10 seconds operating and 20 seconds stopped
Dimensions: Height	(mm)	577
Width	(mm)	198
Depth	(mm)	397
Weight: Net weight	(kg)	14
Packaged weight	(kg)	16
Noise: (2)	(dBA)	63

- (1) These values are given as an indication only. The exact electrical specifications for your machine are recorded on the identification plate.
- (2) Noise level measured in acoustic pressure with the machine under load at 1 m from its axis in accordance with standard EN 31201.

110-120V 50/60Hz and 220-240V 50/60Hz wiring diagram

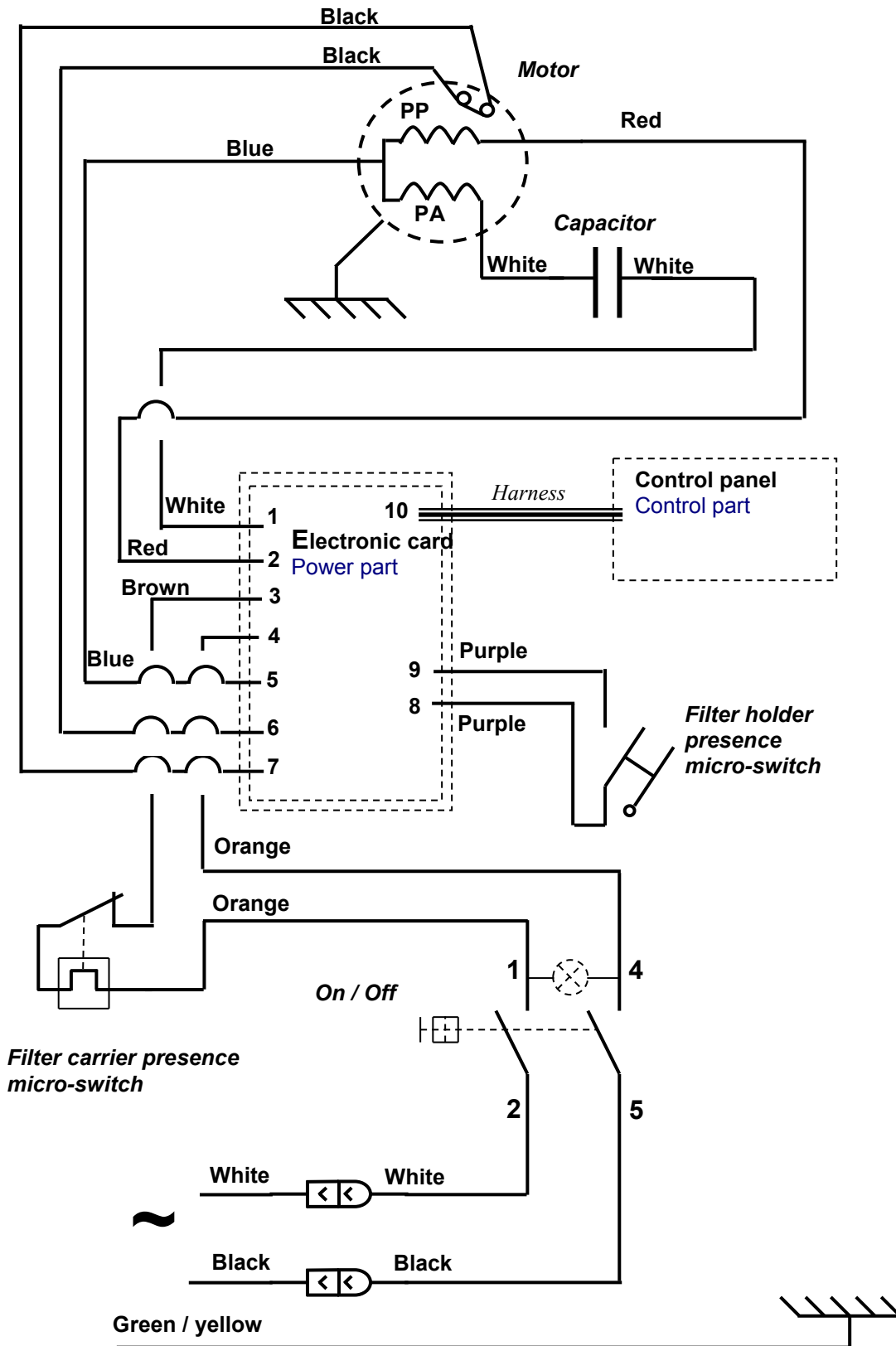

Element cross-reference table

ITEM	Description
1	Bean container lid
2	Bean container
3	Ground coffee collector
4	Base
5	Grinder unit
6	Bean container shutter
7	Indexing pointer
8	Grindstone holder plate
9	Grindstone
10	Power supply lead.
11	On / Off switch
12	Graduated plate
13	Current overload protector
14	Capacitor
15	Ground coffee tamper
16	Identification plate
17	Motor shaft nut
18	Control panel
19	Luminous display
20	1 coffee selection button
21	2 coffees selection button
22	Setting buttons
23	Ground coffee outlet tube
24	Filter holder support
25	Filter holder micro-switch
26	Electric components unit

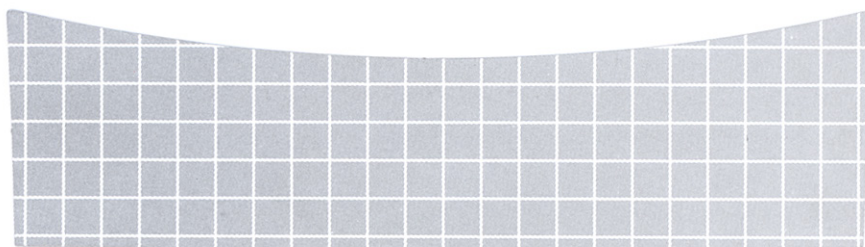

Templet for the personalised label. Print to scale 1:1 then cut out.

You can produce a personalised label directly on our Internet site (Word document).

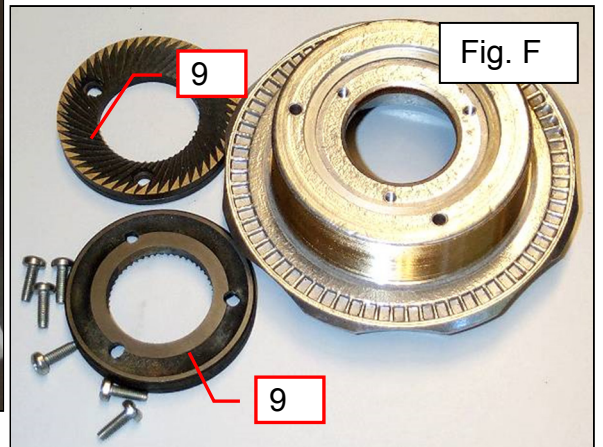
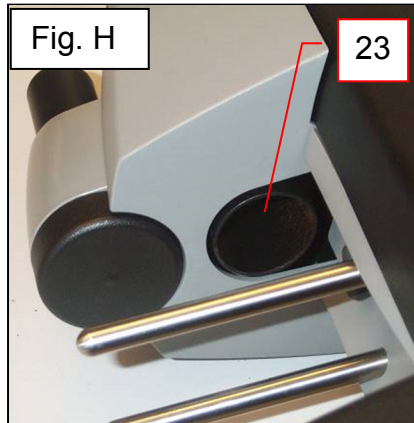
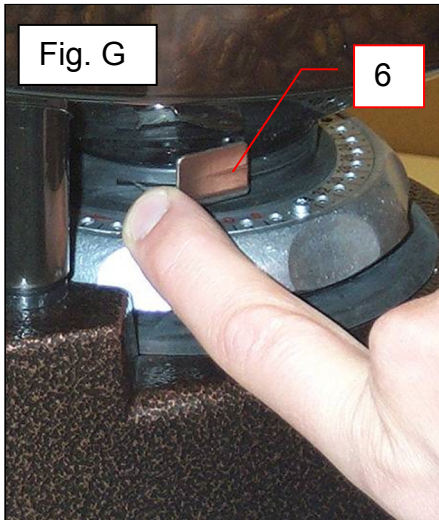
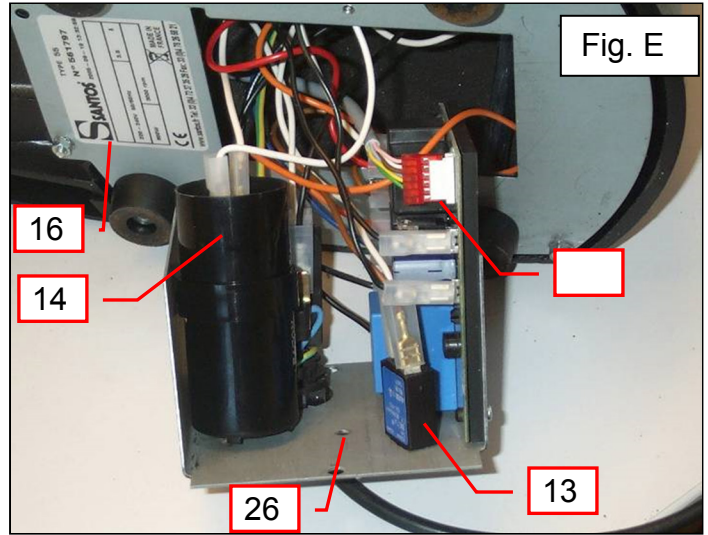
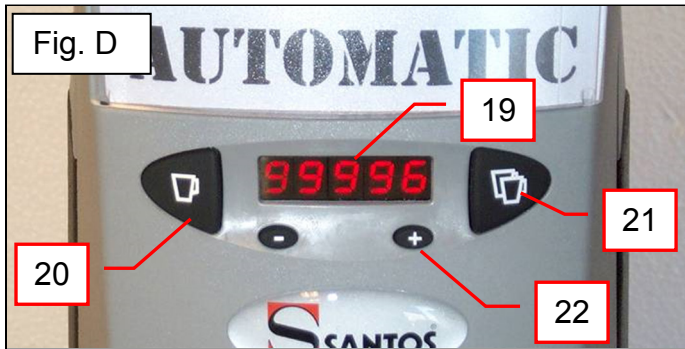
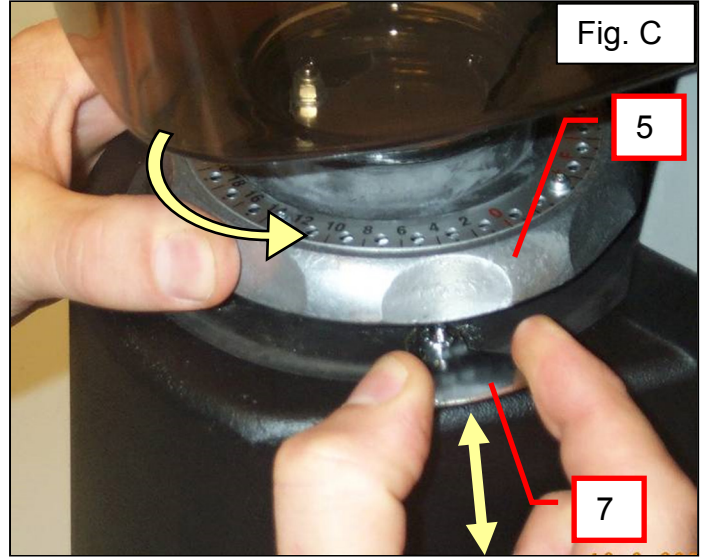
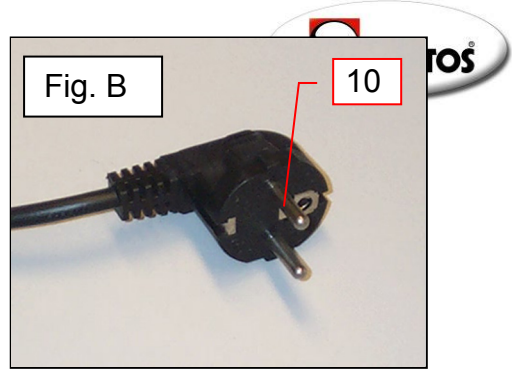
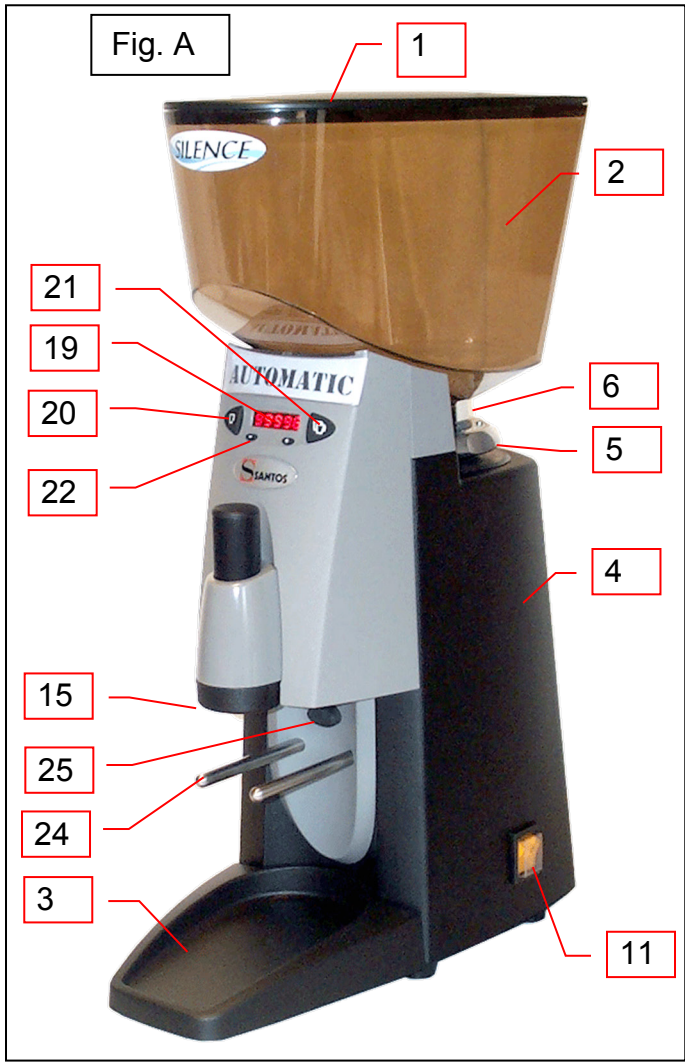

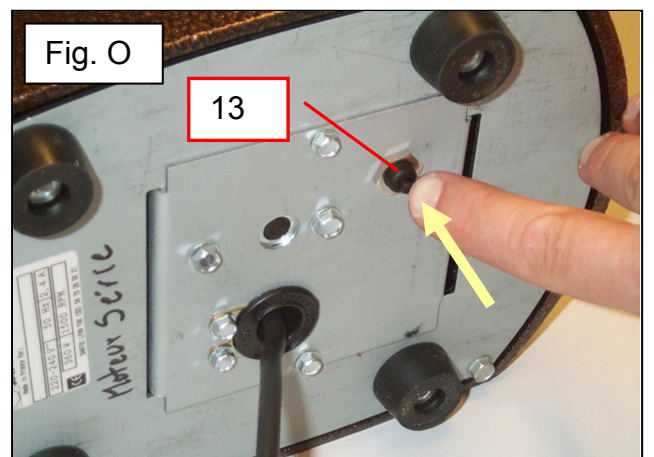
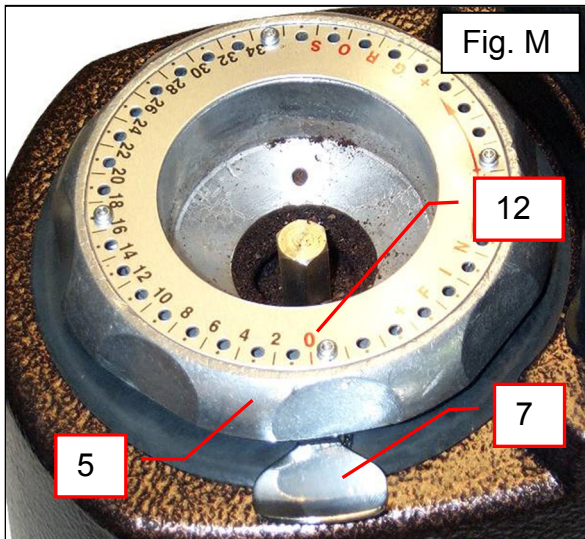
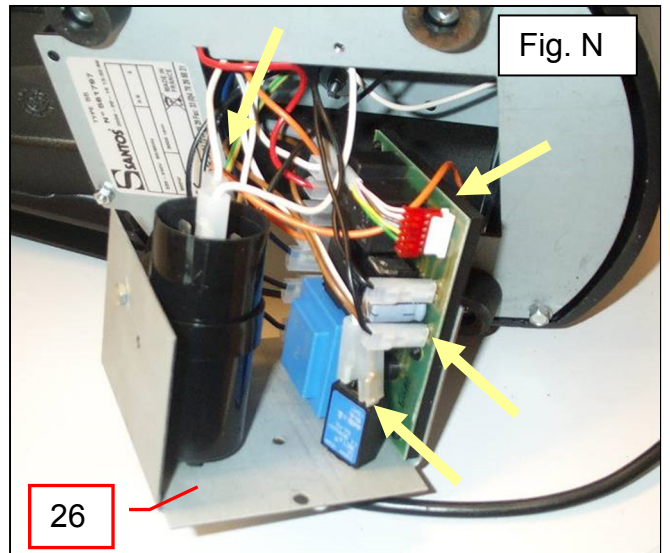
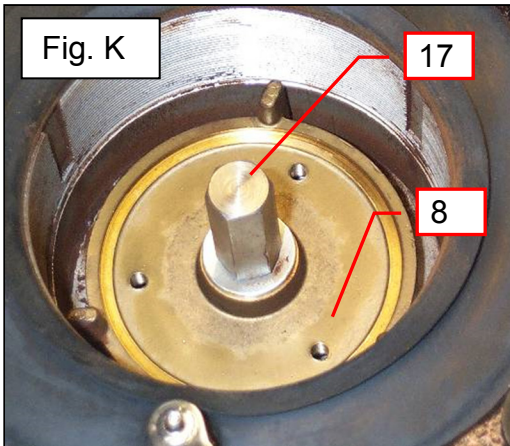
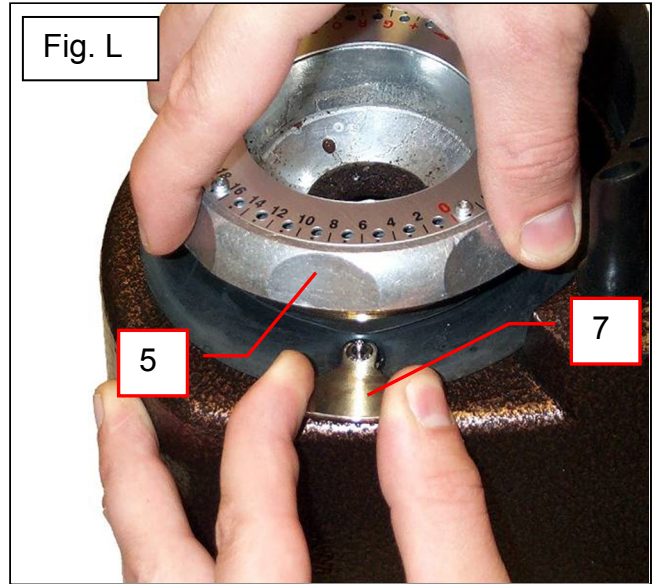
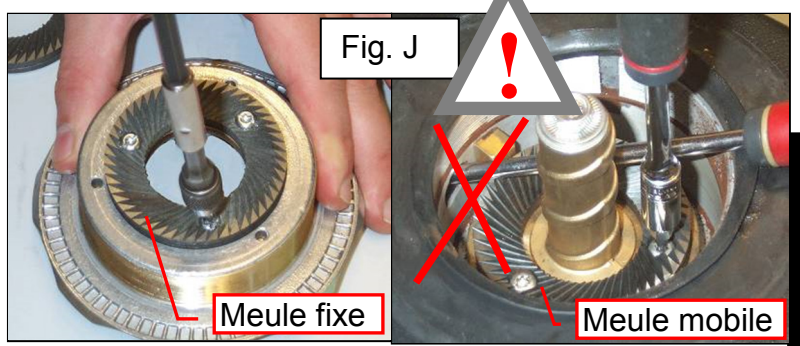
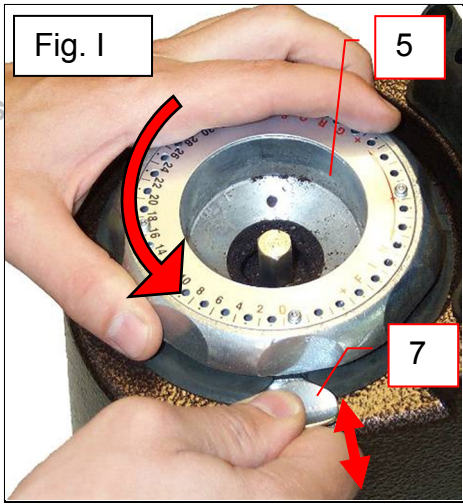



WARRANTY CERTIFICATE

WARRANTY

Since the 01.01.95, all our appliances comply with CE and possess the CE label. Our guarantee is of 24 months from the manufacturing date mentioned on the descriptive plate, except concerning the asynchronous motors (consisting of a rotor and a stator) which are warranted for 5 years from their manufacturing date. Warranty is strictly limited to the free replacement of any part of origin recognized by us as defective due to a defect or building default and identified as belonging to the concerned appliance. Warranty does not apply to damages resulting from installation or use non-complying with our appliance data sheet (user's manual) or in case of an evident lack of maintenance or disrespect of elementary security electric rules. It does not apply in case of regular wear and tear. Any replacement of parts under warranty will be realized after return of the defective part in our workshops, postage paid, supported by a copy of a conformity statement on which appears the serial number of the appliance. Every appliance is equipped with a descriptive plate conforming to the EC recommendations and of which a duplicate exists in the conformity statement (serial number, manufacturing date, electrical characteristics ...). In case of serious damage judged repairable only in our workshops, and after prior consent from our departments, any appliance under guarantee is sent by the Distributor, carriage paid. In case of repairs or reconditioning of appliances not under guarantee, the round trip transport is payable by the distributor. The parts and workforce are invoiced at the current rate. A preliminary estimate can be supplied.

Coffee grinder not using SANTOS original burrs are not taken under guarantee. The warranty conditions, repairs, reconditioning, of the espresso coffee grinder are the object of a specific note. Our guarantee does not extend to the payment of penalties, the repair of direct or indirect damages and notably to any loss of income resulting from the nonconformity or the defectiveness of products, SANTOS's global responsibility being limited to the sale price of the delivered product and to the possible repair of the defective products.

In case of revelation of an imperfection during the warranty period, the Distributor has to, unless a different written agreement of SANTOS, indicate to his customer to stop any use of the defective product. Such a use would release SANTOS of any responsibility.

APPLIANCE IDENTIFICATION PLATE

