

FLUKE®

8845A/8846A

Digital Multimeter

Users Manual

July 2006, Rev. 2, 6/08

© 2006, 2007, 2008 Fluke Corporation. Specifications subject to change without notice. All rights reserved.
All product names are trademarks of their respective companies.

LIMITED WARRANTY AND LIMITATION OF LIABILITY

Each Fluke product is warranted to be free from defects in material and workmanship under normal use and service. The warranty period is one year and begins on the date of shipment. Parts, product repairs, and services are warranted for 90 days. This warranty extends only to the original buyer or end-user customer of a Fluke authorized reseller, and does not apply to fuses, disposable batteries, or to any product which, in Fluke's opinion, has been misused, altered, neglected, contaminated, or damaged by accident or abnormal conditions of operation or handling. Fluke warrants that software will operate substantially in accordance with its functional specifications for 90 days and that it has been properly recorded on non-defective media. Fluke does not warrant that software will be error free or operate without interruption.

Fluke authorized resellers shall extend this warranty on new and unused products to end-user customers only but have no authority to extend a greater or different warranty on behalf of Fluke. Warranty support is available only if product is purchased through a Fluke authorized sales outlet or Buyer has paid the applicable international price. Fluke reserves the right to invoice Buyer for importation costs of repair/replacement parts when product purchased in one country is submitted for repair in another country.

Fluke's warranty obligation is limited, at Fluke's option, to refund of the purchase price, free of charge repair, or replacement of a defective product which is returned to a Fluke authorized service center within the warranty period.

To obtain warranty service, contact your nearest Fluke authorized service center to obtain return authorization information, then send the product to that service center, with a description of the difficulty, postage and insurance prepaid (FOB Destination). Fluke assumes no risk for damage in transit. Following warranty repair, the product will be returned to Buyer, transportation prepaid (FOB Destination). If Fluke determines that failure was caused by neglect, misuse, contamination, alteration, accident, or abnormal condition of operation or handling, including overvoltage failures caused by use outside the product's specified rating, or normal wear and tear of mechanical components, Fluke will provide an estimate of repair costs and obtain authorization before commencing the work. Following repair, the product will be returned to the Buyer transportation prepaid and the Buyer will be billed for the repair and return transportation charges (FOB Shipping Point).

THIS WARRANTY IS BUYER'S SOLE AND EXCLUSIVE REMEDY AND IS IN LIEU OF ALL OTHER WARRANTIES, EXPRESS OR IMPLIED, INCLUDING BUT NOT LIMITED TO ANY IMPLIED WARRANTY OF MERCHANTABILITY OR FITNESS FOR A PARTICULAR PURPOSE. FLUKE SHALL NOT BE LIABLE FOR ANY SPECIAL, INDIRECT, INCIDENTAL, OR CONSEQUENTIAL DAMAGES OR LOSSES, INCLUDING LOSS OF DATA, ARISING FROM ANY CAUSE OR THEORY.

Since some countries or states do not allow limitation of the term of an implied warranty, or exclusion or limitation of incidental or consequential damages, the limitations and exclusions of this warranty may not apply to every buyer. If any provision of this Warranty is held invalid or unenforceable by a court or other decision-maker of competent jurisdiction, such holding will not affect the validity or enforceability of any other provision.

Fluke Corporation	Fluke Europe B.V.
P.O. Box 9090	P.O. Box 1186
Everett, WA 98206-9090	5602 BD Eindhoven
U.S.A.	The Netherlands

11/99

To register your product online, visit <http://register.fluke.com>

Table of Contents

Chapter	Title	Page
1	Introduction and Specifications.....	1-1
	Introduction.....	1-3
	Manual Set.....	1-3
	About this Manual.....	1-4
	Safety Information.....	1-4
	General Safety Summary.....	1-4
	Symbols.....	1-6
	Instrument Security Procedures.....	1-6
	Volatile Memory.....	1-6
	Non Volatile Memory.....	1-7
	Media Memory (8846A Only).....	1-7
	Accessories.....	1-7
	General Specifications.....	1-9
	Power.....	1-9
	Dimensions.....	1-9
	Display.....	1-9
	Environment.....	1-9
	Safety.....	1-9
	EMC.....	1-9
	Triggering.....	1-9
	Memory.....	1-10
	Math Functions.....	1-10
	Electrical.....	1-10
	Remote Interfaces.....	1-10
	Warranty.....	1-10
	Electrical Specifications.....	1-10
	DC Voltage Specifications.....	1-10
	AC Voltage Specifications.....	1-11
	Resistance.....	1-14
	DC Current.....	1-15
	AC Current.....	1-16
	Frequency.....	1-19
	Capacitance (8846A Only).....	1-21
	Temperature (8846A only).....	1-21
	Additional Errors.....	1-21

	Continuity.....	1-21
	Diode Test.....	1-22
	Measurement Rates (IEEE488[4]).....	1-22
2	Preparing the Meter for Operation	2-1
	Introduction.....	2-3
	Unpacking and Inspecting the Meter.....	2-3
	Contacting Fluke.....	2-3
	Storing and Shipping the Meter.....	2-3
	Power Considerations.....	2-3
	Selecting the Line Voltage.....	2-4
	Replacing the Fuses.....	2-4
	Connecting to Line Power.....	2-7
	Turning Power-On.....	2-8
	Adjusting the Bail.....	2-8
	Installing the Meter in an Equipment Rack.....	2-8
	Cleaning the Meter.....	2-9
3	Front-Panel Operation	3-1
	Introduction.....	3-3
	Controls and Indicators.....	3-4
	Front-Panel Feature Descriptions.....	3-4
	Display Panel.....	3-5
	Rear-Panel Connectors.....	3-7
	Adjusting the Meter's Range.....	3-8
	Navigating the Front-Panel Menu.....	3-8
	Configuring the Meter for a Measurement.....	3-8
	Setting the Beeper State.....	3-8
	Setting the Display Resolution.....	3-9
	Setting the AC Signal Filter.....	3-9
	Setting Continuity Resistance Threshold and Diode Test Parameters.....	3-10
	Setting the Default Temperature Scale (8846A Only).....	3-10
	Enabling High Input Impedance.....	3-10
	Using the Analyze Functions.....	3-11
	Collecting Statistics on Measurements.....	3-11
	Testing Using Limits.....	3-12
	Setting an Offset Value.....	3-13
	Using MX+B.....	3-13
	Using TrendPlot.....	3-14
	Using the Histogram Function.....	3-15
	Controlling Trigger Functions.....	3-16
	Choosing a Trigger Source.....	3-16
	Setting the Trigger Delay.....	3-17
	Setting the Number of Samples.....	3-18
	Understanding the Measurement Complete Signal.....	3-18
	Accessing and Controlling Memory.....	3-18
	Storing Readings in Memory.....	3-18
	Recalling Readings from Memory.....	3-20
	Storing Meter Configuration Information.....	3-20
	Storing the Power-up Configuration.....	3-21
	Recalling the Power-up Configuration.....	3-21
	Removing the Power-up Configuration.....	3-22
	Recalling a Meter Configuration.....	3-22
	Managing Memory.....	3-22

Controlling System-Related Operations	3-23
Identifying Meter Errors	3-23
Querying the Firmware for Revision Level	3-24
Adjusting Display Brightness	3-24
Setting the Meter's Date and Time	3-24
USB Operation	3-24
USB Storage Capacity and Write Time	3-24
USB Memory Device Compatibility and Special Instruction	3-25
Configuring the Remote Interface	3-25
Checking the Meter's Calibration Date	3-25
Resetting the Meter's Default Settings	3-27
4 Making Measurements	4-1
Introduction	4-3
Selecting Function Modifiers	4-3
Activating the Secondary Display	4-3
Measuring Voltage	4-4
Measuring DC Voltage	4-4
Measuring AC Voltage	4-5
Measuring Frequency and Period	4-7
Measuring Resistance	4-7
Making a Two-wire Resistance Measurement	4-8
Making a Four-wire Resistance Measurement	4-8
Measuring Current	4-10
Measuring DC Current	4-11
Measuring AC Current	4-12
Measuring Capacitance (8846A only)	4-13
Measuring RTD Temperature (8846A only)	4-14
Testing Continuity	4-15
Checking Diodes	4-16
Making a Triggered Measurement	4-17
Setting the Trigger Mode	4-17
Setting a Trigger Delay	4-17
Setting Number of Samples per Trigger	4-17
Connecting an External Trigger	4-18
Monitoring the Measurement-Complete Signal	4-18
Appendices	
A 2X4 Test Leads	A-1
B Errors	B-1
C RS-232 Port Connections	C-1
D Analog Filter Applications	D-1
Index	

List of Tables

Table	Title	Page
1-1.	Safety Information	1-5
1-2.	Safety and Electrical Symbols.....	1-6
1-3.	Volatile Memory Space.....	1-6
1-4.	Non-volatile Memory Space	1-7
1-5.	Accessories.....	1-7
2-1.	Line Voltage to Fuse Rating.....	2-5
2-2.	Line Power Cord Types Available from Fluke	2-7
3-1.	Front-Panel Controls and Connectors	3-4
3-2.	Display Elements	3-6
3-3.	Rear-Panel Connectors.....	3-7

List of Figures

Figure	Title	Page
2-1.	Replacing the Line Fuse.....	2-5
2-2.	Replacing the Current Input Fuses.....	2-6
2-3.	Line Power Cords Types Available from Fluke.....	2-7
2-4.	Bail Adjustment and Removal.....	2-8
3-1.	TrendPlot Display.....	3-15
3-2.	Histogram Display.....	3-16
4-1.	Input Connections for Voltage, Resistance, and Frequency Measurements.....	4-4
4-2.	Input Connections for 4-wire Resistance Measurements.....	4-9
4-3.	Input Connections for 4-wire Ohms Using 2x4 Wire Leads.....	4-10
4-4.	Input Connections for Current Measurements Below 400 mA.....	4-11
4-5.	Input Connections for Current Measurements Above 400 mA.....	4-11
4-6.	Measuring Capacitance.....	4-14
4-7.	Temperature Measurements.....	4-14
4-8.	Diode Testing Connections.....	4-16
4-9.	TRIG I/O Pin-out Description.....	4-18

Chapter 1

Introduction and Specifications

Title	Page
Introduction.....	1-3
Manual Set.....	1-3
About this Manual.....	1-4
Safety Information.....	1-4
General Safety Summary.....	1-4
Symbols.....	1-6
Instrument Security Procedures.....	1-6
Volatile Memory.....	1-6
Non Volatile Memory.....	1-7
Media Memory (8846A Only).....	1-7
Accessories.....	1-7
General Specifications.....	1-9
Power.....	1-9
Dimensions.....	1-9
Display.....	1-9
Environment.....	1-9
Safety.....	1-9
EMC.....	1-9
Triggering.....	1-9
Memory.....	1-10
Math Functions.....	1-10
Electrical.....	1-10
Remote Interfaces.....	1-10
Warranty.....	1-10
Electrical Specifications.....	1-10
DC Voltage Specifications.....	1-10
AC Voltage Specifications.....	1-11
Resistance.....	1-14
DC Current.....	1-15
AC Current.....	1-16
Frequency.....	1-19
Capacitance (8846A Only).....	1-21
Temperature (8846A only).....	1-21
Additional Errors.....	1-21
Continuity.....	1-21

Diode Test	1-22
Measurement Rates (IEEE488[4]).....	1-22

Introduction

The 8845A and 8846A are 6-1/2 digit, dual-display multimeters designed for bench-top, field service, and system applications. Their full complement of measurement functions plus its RS-232, IEEE 488, and Ethernet Remote Interfaces makes these multimeters ideal candidates for precision manual measurements and use in automated systems. For portability, these multimeters include a carrying handle that also serves as a bail for bench top operation.

There are a few feature differences between these two multimeters, and some specifications are tighter for the 8846A. Features that exist in only one multimeter will be identified with the addition of “8846A Only” by each feature that is found only in that model. Separate specification tables are also used to clarify the differences between these two models.

The following is a list of some of the features and functions:

- Bright, large-digit, wide-viewing-angle display
- Dual display for displaying two properties of an input signal (e.g., ac voltage in one display and frequency in the other).
- Remote operation via IEEE 488, RS-232, and Ethernet interface.
- Trigger in and measurement-complete out
- Front panel USB port for optional memory (8846A Only)
- 6-1/2 digit resolution
- Half-rack width
- True rms ac
- 2 and 4-wire resistance measurements
- Extended 10 Ω and 1 G Ω ranges (8846A Only)
- Frequency measurements to 300 kHz (8846A to 1 MHz)
- Capacitance measurements (8846A Only)
- Temperature measurement (8846A Only)
- 10 A current capability
- Decibels (dB and dBm) with variable reference impedance and audio power measurement capability
- Input terminals on both front and rear panels of the meter
- Closed-case calibration (no internal calibration adjustments)

Manual Set

The manual set for these multimeters consists of a *Users Manual* and *Programmers Manual* on a CD ROM. The *Users Manual* contains information on specifications, setup, and operating from the front panel. The *Programmers Manual* covers operating the Meter from a PC or controller.

About this Manual

This is the *Users Manual* for the 8845A and 8846A Digital Multimeters (hereafter referred to as the Meter). It contains all of the information a new user will need to operate the Meter effectively. The manual is divided into the following chapters:

Chapter 1 “Introduction and Specifications” provides information on how to safely use the Meter, standard and optional accessories, and specifications.

Chapter 2 “Preparing for Operation” provides information on setting the Meter’s line voltage, connecting it to a power source, and turning the Meter on.

Chapter 3 “Front Panel Operation” introduces the controls and connections on the front and rear panels of the Meter.

Chapter 4 “Making Measurements” provides detailed information on using the Meter to make electrical measurements.

Appendices

Safety Information

This section addresses safety considerations and describes symbols that may appear on the Meter or in the manual.

A  **Warning** statement identifies conditions or practices that could result in injury or death.

A  **Caution** statement identifies conditions or practices that could result in damage to the Meter or equipment to which it is connected.

Warning

To avoid electric shock, personal injury, or death, carefully read the information under “Safety Information” before attempting to install, use, or service the Meter.

General Safety Summary

This instrument has been designed and tested in accordance with the European standard publication EN 61010-1:2001 and U.S. / Canadian standard publications UL 61010-1A1 and CAN/CSA-C22.2 No.61010.1. The Meter has been supplied in a safe condition.

This manual contains information and warnings that must be observed to keep the instrument in a safe condition and ensure safe operation.

To use the Meter correctly and safely, read and follow the precautions in Table 1-1, and follow all the safety instructions or warnings given throughout this manual that relate to specific measurement functions. In addition, follow all generally accepted safety practices and procedures required when working with and around electricity.

CAT I equipment is designed to protect against transients from high-voltage, low-energy sources, such as electronic circuits or a copy machine.

CAT II equipment is designed to protect against transients from energy-consuming equipment supplied from the fixed installation, such as TVs, PCs, portable tools, and other household appliances.

Table 1-1. Safety Information

⚠ ⚠ Warning

















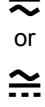

To avoid possible electric shock, personal injury, or death, read the following before using the Meter:

- Use the Meter only as specified in this manual, or the protection provided by the Meter might be impaired.
- Do not use the Meter in wet environments.
- Inspect the Meter before using it. Do not use the Meter if it appears damaged.
- Inspect the test leads before use. Do not use them if insulation is damaged or metal is exposed. Check the test leads for continuity. Replace damaged test leads before using the Meter.
- Verify the Meter's operation by measuring a known voltage before and after using it. Do not use the Meter if it operates abnormally. Protection may be impaired. If in doubt, have the Meter serviced.
- Whenever it is likely that safety protection has been impaired, make the Meter inoperative and secure it against any unintended operation.
- Have the Meter serviced only by qualified service personnel.
- Do not apply more than the rated voltage, as marked on the Meter, between the terminals or between any terminal and earth ground.
- Always use the power cord and connector appropriate for the voltage and outlet of the country or location in which you are working.
- Remove test leads from the Meter before opening the case.
- Never remove the cover or open the case of the Meter without first removing it from the main power source.
- Never operate the Meter with the cover removed or the case open.
- Use caution when working with voltages above 30 V ac rms, 42 V ac peak, or 42 V dc. These voltages pose a shock hazard.
- Use only the replacement fuse(s) specified by the manual.
- Use the proper terminals, function, and range for your measurements.
- Do not operate the Meter around explosive gas, vapor, or dust.
- When using probes, keep your fingers behind the finger guards.
- When making electrical connections, connect the common test lead before connecting the live test lead; when disconnecting, disconnect the live test lead before disconnecting the common test lead.
- Disconnect circuit power and discharge all high-voltage capacitors before testing resistance, continuity, diodes, or capacitance.
- Before measuring current, check the Meter's fuses and turn OFF power to the circuit before connecting the Meter to the circuit.
- When servicing the Meter, use only specified replacement parts.

Symbols

Table 1-2 is a list of safety and electrical symbols that appear on the Meter or in this manual.

Table 1-2. Safety and Electrical Symbols

Symbol	Description	Symbol	Description
	Risk of danger. Important information. See manual		Display ON / OFF
	Hazardous voltage. Voltage >30 V dc or ac peak might be present		Earth ground
	AC (Alternating Current)		Capacitance
	DC (Direct Current)		Diode
	AC or DC (Alternating or Direct Current)		Fuse
			Digital signal
	Continuity test or continuity beeper tone		Maintenance or Service
	Potentially hazardous voltage	CAT II	IEC 61010 Overvoltage (installation or measurement) Category 2.
	Double insulated		Recycle
	Static awareness. Static discharge can damage part(s)		Do not dispose of this product as unsorted municipal waste. Go to Fluke's website for recycling information.

Instrument Security Procedures

This section describes the Meter's memory elements and the procedures for clearing them.

Volatile Memory

Table 1-3 lists the Meter's volatile memory elements.

Table 1-3. Volatile Memory Space

Type	Size	Function
SDRAM	128 MB	Out-guard measurement data, user strings, temporary configuration information, and Ethernet Host name.
SRAM	4 MB	In-guard Measurement data and configuration information.

To clear both volatile memory elements listed in Table 1-3:

1. Press **MEMORY**.
2. Press the **MANAGE MEMORY** soft key.
3. Press the **ERASE MEMORY** soft key.

Non Volatile Memory

Table 1-4 lists the Meter's non-volatile memory elements.

Table 1-4. Non-volatile Memory Space

Type	Size	Function
Flash	128 MB	Application program storage, user string, user data, user remote interface settings, calibration constants.
Flash	4 MB	FPGA hardware setup, application program storage, calibration constants.

To clear the 128 MB of non-volatile flash memory listed in Table 1-4:

1. Press **MEMORY**.
2. Press the **MANAGE MEMORY** soft key.
3. Press the **ERASE USB / FLK** soft key.

This process clears only the user accessible portion of memory.

Note

The 4 MB non-volatile memory element is not usable and cannot be cleared by the user.

Media Memory (8846A Only)

The 8846A has a front-panel USB port for connecting flash memory modules up to 2 Gigabytes capacity to store Meter configuration and measurement data. To clear a memory module while connected to the 8846A:

1. Press **MEMORY**.
2. Press the **MANAGE MEMORY** soft key.
3. Press the **ERASE USB MEMORY** soft key.

Accessories

Table 1-5 lists the available accessories for the 8845A and 8846A.

Table 1-5. Accessories

Model/Fluke PN	Description
TL71	Premium Test Lead Set
6303	Kelvin Probes
6730	Kelvin Lead Set with Alligator Clips
5940	Kelvin clip set
5143	SMD Test Tweezer Leads
6275	Precision Electronic Probe Set
6344	Basic Electronic DMM Test Set
884X-Short	4-Wire Short

Table 1-5. Accessories (cont)

Model/Fluke PN	Description
884X-Case	Black plastic case
TL910	Precision Electronic Probe Set
TL910	Precision Electronic Probe Set
TL80A	Basic Electronic DMM Test Set
TL2X4W-PTII	2X4 Wire Ohms Test Lead
TL2X4W-TWZ	2X4 Wire Ohms SMD Test Tweezer
8845A-EFPT	Test Probe Tip Adapter, Extended Fine Point
8845A-TPIT	Test Probe Tip Adapter, IC Probe Tip
803293	Fuse, 11 A, 1000 V, Fast, .406INX1.5IN, Bulk
943121	Fuse, 440 mA, 1000 V, Fast, .406X1.375, Bulk
884X-RTD	100 Ohm RTD Temperature Probe
Y8846S	Rack Mount Kit 8845A & 8846A Single
Y8846D	Rackmount Kit 8845A & 8846A Dual
Y8021	Shielded IEEE 488 one-meter (39.4 inches) cable, with plug and jack at each end.
Y8022	Shielded IEEE 488 two-meter (78.8 inches) cable, with plug and jack at each end.
884X-USB	USB to RS-232 Cable Adapter
RS43	Shielded RS-232 Cable (2 Meters)
884X-ETH	Ethernet Cable
884X-512M	512 Mbyte memory (8846A only)
884X-1G	1 Gbyte memory (8846A only)
FVF-SC5	FlukeView Forms, Basic Software
FVF-UG	FlukeView Forms, Software Upgrade – No Cable
FVF-SC4	Extended FlukeView Forms with USB Cable
2132558	Calibration, traceable with data
1259800	Calibration, traceable without data
1256480	Calibration, Z540 traceable with data
1258910	Calibration, Z540 traceable, without data
1256990	Calibration, accredited
1024830	Agreement, Extended Warranty
2426684	Agreement, Calibration, Traceable, with data
1028820	Agreement, Calibration, Traceable, without data
1259170	Agreement, Calibration, Z540 Traceable, with data
1258730	Agreement, Calibration, Z540 Traceable, without data

Table 1-5. Accessories (cont)

Model/Fluke PN	Description
1259340	Agreement, Calibration, Accredited
2441827	Agreement, Calibration, primary standards lab
1540600	Agreement, Calibration, artifact

General Specifications

Power

Voltage

100 V Setting	90 V to 110 V
120 V Setting	108 V to 132 V
220 V Setting	198 V to 242 V
240 V Setting	216 V to 264 V

Frequency 47 Hz to 440 Hz. Automatically sensed at power-on.

Power Consumption..... 28 VA peak (12 Watt average)

Dimensions

Height.....	88 mm (3.46 in.)
Width.....	217 mm (8.56 in.)
Depth	297 mm (11.7 in.)
Weight.....	3.6 kg (8.0 lb)
Shipping Weight.....	5.0 kg (11.0 lb)

Display

Vacuum Fluorescent Display, dot matrix

Environment

Temperature

Operating	0 °C to 55 °C
Storage	-40 °C to 70 °C
Warm Up.....	1 hour to full uncertainty specifications

Relative Humidity (non-condensing)

Operating	0 °C to 28 °C <90 %
	28 °C to 40 °C <80 %
	40 °C to 55 °C <50 %
Storage	-40 °C to 70 °C <95 %

Altitude

Operating	2,000 Meters
Storage	12,000 Meters

Vibration and Shock..... Complies with Mil-T-28800F Type III, Class 5 (Sine only)

Safety

Designed to comply with IEC 61010-1:2000-1, UL 61010-1A1, CAN/CSA-C22.2 No. 61010.1, CAT I 1000V/CAT II 600V

EMC

Designed to comply with IEC 61326-1:2000-11 (EMC) when used with shielded communications cables. This Meter has shown susceptibility to radiated frequencies greater than 1 V/m from 250 to 450 MHz.

Triggering

Samples per Trigger	1 to 50,000
---------------------------	-------------

Trigger Delay	0 s to 3600 s; in 10 μ S increments
External Trigger Delay	<1 mS
External Trigger Jitter	<500 μ S
Trigger Input	TTL Levels
Trigger Output	5 V maximum (open collector)

Memory

8845A	10,000 measurements, internal only
8846A	10,000 measurements, internal, and up to 2 Gigabyte capacity with USB memory module (available separately, see "Accessories") through front-panel USB port

Math Functions

Zero, dBm, dB, MX+B, Offset, DCV ratio and TrendPlot, Histogram, Statistics (min/max/average/standard deviation), and Limit Test

Electrical

Input Protection	1000 V all ranges
Overrange	20 % on all ranges except 1000 V dc, 1000 V ac (8846A), 750 V ac (8845A), Diode, and 10 A ranges

Remote Interfaces

RS-232C, DTE 9-pin, 1200 to 230400 baud (RS-232C to USB cable available to connect the Meter to a PC USB port. See Accessories)

IEEE 488.2

LAN and "Ethernet 10/100 base T with DHCP (for IP_ADDRESS) option"

Warranty

One year

Electrical Specifications

Accuracy specifications are valid for 6½ digit resolution mode after at least a 1-hour warm-up with Auto Zero enabled.

24-hour specifications are relative to calibration standards and assume a controlled electromagnetic environment per EN 61326-1:2000-11

DC Voltage Specifications

Maximum Input	1000 V on any range
Common Mode Rejection	140 dB at 50 or 60 Hz \pm 0.1 % (1 k Ω unbalance)
Normal Mode Rejection	60 dB for NPLC of 1 or greater with analog filter off and power line frequency \pm 0.1 % 100 dB for NPLC of 1 or greater with analog filter on and power line frequency \pm 0.1 %
Measurement Method	Multi-ramp A/D
A/D Linearity	0.0002 % of measurement +0.0001 % of range
Input Bias Current	<30 pA at 25 °C
Autozero Off Operation	Following instrument warm-up at calibration temperature \pm 1 °C and less than 10 minutes, add error: 0.0002 % range additional error +5 μ V.
Analog Filter	When using the analog filter, specifications are relative to within one hour of using the ZERO function for that range and NPLC setting.
DC Ratio	Accuracy is +/- (Input accuracy + Reference accuracy), where Input accuracy = DC Voltage accuracy for the HI to LO Input (in ppm of the Input voltage), and Reference accuracy = DC Voltage accuracy for the HI to LO (Sense) Reference (in ppm of the Reference voltage).
Settling Considerations	Measurement settling times are affected by source impedance, cable dielectric characteristics, and input signal changes.

Input Characteristics

Range	Resolution	Resolution			Input Impedance
		4½ Digits	5½ Digits	6½ Digits	
100 mV	100.0000 mV	10 µV	1 µV	100 nV	10 MΩ or >10 GΩ ^[1]
1 V	1.000000 V	100 µV	10 µV	1 µV	10 MΩ or >10 GΩ ^[1]
10 V	10.00000 V	1 mV	100 µV	10 µV	10 MΩ or >10 GΩ ^[1]
100 V	100.0000 V	10 mV	1 mV	100 µV	10 MΩ ±1%
1000 V	1,000.000 V	100 mV	10 mV	1 mV	10 MΩ ±1%

[1] Inputs beyond ±14 V are clamped through 200 kΩ typical. 10 MΩ is default input impedance.

8846A Accuracy

Accuracy is given as ± (% measurement + % of range)

Range	24 Hour (23 ±1 °C)	90 Days (23 ±5 °C)	1 Year (23 ±5 °C)	Temperature Coefficient/ °C Outside 18 to 28 °C
100 mV	0.0025 + 0.003	0.0025 + 0.0035	0.0037 + 0.0035	0.0005 + 0.0005
1 V	0.0018 + 0.0006	0.0018 + 0.0007	0.0025 + 0.0007	0.0005 + 0.0001
10 V	0.0013 + 0.0004	0.0018 + 0.0005	0.0024 + 0.0005	0.0005 + 0.0001
100 V	0.0018 + 0.0006	0.0027 + 0.0006	0.0038 + 0.0006	0.0005 + 0.0001
1000 V	0.0018 + 0.0006	0.0031 + 0.001	0.0041 + 0.001	0.0005 + 0.0001

8845A Accuracy

Accuracy is given as ± (% measurement + % of range)

Range	24 Hour (23 ±1 °C)	90 Days (23 ±5 °C)	1 Year (23 ±5 °C)	Temperature Coefficient/ °C Outside 18 to 28 °C
100 mV	0.003 + 0.003	0.004 + 0.0035	0.005 + 0.0035	0.0005 + 0.0005
1 V	0.002 + 0.0006	0.003 + 0.0007	0.004 + 0.0007	0.0005 + 0.0001
10 V	0.0015 + 0.0004	0.002 + 0.0005	0.0035 + 0.0005	0.0005 + 0.0001
100 V	0.002 + 0.0006	0.0035 + 0.0006	0.0045 + 0.0006	0.0005 + 0.0001
1000 V	0.002 + 0.0006	0.0035 + 0.0010	0.0045 + 0.0010	0.0005 + 0.0001

Additional Errors

Digits	NPLC	Additional NPLC Noise Error
6½	100	0 % of range
6½	10	0 % of range
5½	1	0.001 % of range
5½	.2	0.0025 % of range +12 µV
4½	0.02	0.017 % of range +17 µV

AC Voltage Specifications

AC Voltage specifications are for ac sinewave signals >5 % of range. For inputs from 1 % to 5 % of range and <50 kHz, add an additional error of 0.1 % of range, and for 50 kHz to 100 kHz, add 0.13 % of range.

Maximum Input 750 V rms or 1000 V peak (8845A), 1000 V rms or 1414 V peak (8846A) or 8×10^7 volts-Hertz product (whichever is less) for any range.

Measurement Method AC-coupled true-rms. Measures the ac component of input with up to 1000 V dc bias on any range.

AC Filter Bandwidth:

Slow 3 Hz – 300 kHz

Medium 20 Hz – 300 kHz

Fast 200 Hz – 300 kHz

Common Mode Rejection 70 dB at 50 Hz or 60 Hz ±0.1 % (1 kΩ unbalance)

Crest Factor Error (applies to non-sinusoidal waveforms only)

Maximum Crest Factor 5:1 at Full Scale

Additional Crest Factor Errors (<100 Hz)..... Crest factor 1-2, 0.05 % of full scale
 Crest factor 2-3, 0.2 % of full scale
 Crest factor 3-4, 0.4 % of full scale
 Crest factor 4-5, 0.5 % of full scale

Input Characteristics

Range	Resolution	Resolution			Input Impedance
		4½ Digits	5½ Digits	6½ Digits	
100 mV	100.0000 mV	10 µV	1 µV	100 nV	1 MΩ ±2 % shunted by <100 pf
1 V	1.000000 V	100 µV	10 µV	1 µV	
10 V	10.00000 V	1 mV	100 µV	10 µV	
100 V	100.0000 V	10 mV	1 mV	100 µV	
1000 V	1,000.000 V	100 mV	10 mV	1 mV	

8846A Accuracy

Accuracy is given as ± (% measurement + % of range)

Range	Frequency	24 Hour (23 ±1 °C)	90 Days (23 ±5 °C)	1 Year (23 ±5 °C)	Temperature Coefficient/ °C Outside 18 to 28 °C
100 mV	3 – 5 Hz	1.0 + 0.03	1.0 + 0.04	1.0 + 0.04	0.1 + 0.004
	5 – 10 Hz	0.35 + 0.03	0.35 + 0.04	0.35 + 0.04	0.035 + 0.004
	10 Hz – 20 kHz	0.04 + 0.03	0.05 + 0.04	0.06 + 0.04	0.005 + 0.004
	20 – 50 kHz	0.1 + 0.05	0.11 + 0.05	0.12 + 0.05	0.011 + 0.005
	50 – 100 kHz	0.55 + 0.08	0.6 + 0.08	0.6 + 0.08	0.06 + 0.008
	100 – 300 kHz ^[1]	4.0 + 0.50	4.0 + 0.50	4.0 + 0.50	0.20 + 0.02
1 V	3 – 5 Hz	1.0 + 0.02	1.0 + 0.03	1.0 + 0.03	0.1 + 0.003
	5 – 10 Hz	0.35 + 0.02	0.35 + 0.03	0.35 + 0.03	0.035 + 0.003
	10 Hz – 20 kHz	0.04 + 0.02	0.05 + 0.03	0.06 + 0.03	0.005 + 0.003
	20 – 50 kHz	0.1 + 0.04	0.11 + 0.05	0.12 + 0.05	0.011 + 0.005
	50 – 100 kHz	0.55 + 0.08	0.6 + 0.08	0.6 + 0.08	0.06 + 0.008
	100 – 300 kHz ^[1]	4.0 + 0.50	4.0 + 0.50	4.0 + 0.50	0.2 + 0.02
10 V	3 – 5 Hz	1.0 + 0.02	1.0 + 0.03	1.0 + 0.03	0.1 + 0.003
	5 – 10 Hz	0.35 + 0.02	0.35 + 0.03	0.35 + 0.03	0.035 + 0.003
	10 Hz – 20 kHz	0.04 + 0.02	0.05 + 0.03	0.06 + 0.03	0.005 + 0.003
	20 – 50 kHz	0.1 + 0.04	0.11 + 0.05	0.12 + 0.05	0.011 + 0.005
	50 – 100 kHz	0.55 + 0.08	0.6 + 0.08	0.6 + 0.08	0.06 + 0.008
	100 – 300 kHz ^[1]	4.0 + 0.50	4.0 + 0.50	4.0 + 0.50	0.2 + 0.02
100 V	3 – 5 Hz	1.0 + 0.02	1.0 + 0.03	1.0 + 0.03	0.1 + 0.003
	5 – 10 Hz	0.35 + 0.02	0.35 + 0.03	0.35 + 0.03	0.035 + 0.003
	10 Hz – 20 kHz	0.04 + 0.02	0.05 + 0.03	0.06 + 0.03	0.005 + 0.003
	20 – 50 kHz	0.1 + 0.04	0.11 + 0.05	0.12 + 0.05	0.011 + 0.005
	50 – 100 kHz	0.55 + 0.08	0.6 + 0.08	0.6 + 0.08	0.06 + 0.008
	100 – 300 kHz ^[1]	4.0 + 0.50	4.0 + 0.50	4.0 + 0.50	0.2 + 0.02
1000 V	3 – 5 Hz	1.0 + 0.015	1.0 + 0.0225	1.0 + 0.0225	0.1 + 0.00225
	5 – 10 Hz	0.35 + 0.015	0.35 + 0.0225	0.35 + 0.0225	0.035 + 0.00225
	10 Hz – 20 kHz	0.04 + 0.015	0.05 + 0.0225	0.06 + 0.0225	0.005 + 0.00225
	20 – 50 kHz	0.1 + 0.03	0.11 + 0.0375	0.12 + 0.0375	0.011 + 0.00375
	50 – 100 kHz ^[2]	0.55 + 0.06	0.6 + 0.06	0.6 + 0.06	0.06 + 0.006
	100 – 300 kHz ^{[1][2]}	4.0 + 0.375	4.0 + 0.375	4.0 + 0.375	0.2 + 0.015

[1] Typically 30 % reading error at 1 MHz
 [2] 1000 Volt range is limited to 8 X 10⁷ volt-Hertz

8845A Accuracy

Accuracy is given as \pm (% measurement + % of range)

Range	Frequency (Hz)	24 Hour (23 \pm 1 °C)	90 Days (23 \pm 5 °C)	1 Year (23 \pm 5 °C)	Temperature Coefficient/ °C Outside 18 to 28 °C
100 mV	3 – 5 Hz	1.0 + 0.03	1.0 + 0.04	1.0 + 0.04	0.10 + 0.004
	5 – 10 Hz	0.35 + 0.03	0.35 + 0.04	0.35 + 0.04	0.035 + 0.004
	10 Hz – 20 kHz	0.04 + 0.03	0.05 + 0.04	0.06 + 0.04	0.005 + 0.004
	20 – 50 kHz	0.1 + 0.05	0.11 + 0.05	0.12 + 0.05	0.011 + 0.005
	50 – 100 kHz	0.55 + 0.08	0.6 + 0.08	0.6 + 0.08	0.06 + 0.008
	100 – 300 kHz ^[1]	4.0 + 0.50	4.0 + 0.50	4.0 + 0.50	0.2 + 0.02
1 V	3 – 5 Hz	1.0 + 0.02	1.0 + 0.03	1.0 + 0.03	0.1 + 0.003
	5 – 10 Hz	0.35 + 0.02	0.35 + 0.03	0.35 + 0.03	0.035 + 0.003
	10 Hz – 20 kHz	0.04 + 0.02	0.05 + 0.03	0.06 + 0.03	0.005 + 0.003
	20 – 50 kHz	0.1 + 0.04	0.11 + 0.05	0.12 + 0.05	0.011 + 0.005
	50 – 100 kHz	0.55 + 0.08	0.6 + 0.08	0.6 + 0.08	0.06 + 0.008
	100 – 300 kHz ^[1]	4.0 + 0.50	4.0 + 0.50	4.0 + 0.50	0.2 + 0.02
10 V	3 – 5 Hz	1.0 + 0.02	1.0 + 0.03	1.0 + 0.03	0.1 + 0.003
	5 – 10 Hz	0.35 + 0.02	0.35 + 0.03	0.35 + 0.03	0.035 + 0.003
	10 Hz – 20 kHz	0.04 + 0.02	0.05 + 0.03	0.06 + 0.03	0.005 + 0.003
	20 – 50 kHz	0.1 + 0.04	0.11 + 0.05	0.12 + 0.05	0.011 + 0.005
	50 – 100 kHz	0.55 + 0.08	0.6 + 0.08	0.6 + 0.08	0.06 + 0.008
	100 – 300 kHz ^[1]	4.0 + 0.50	4.0 + 0.50	4.0 + 0.50	0.2 + 0.02
100 V	3 – 5 Hz	1.0 + 0.02	1.0 + 0.03	1.0 + 0.03	0.1 + 0.003
	5 – 10 Hz	0.35 + 0.02	0.35 + 0.03	0.35 + 0.03	0.035 + 0.003
	10 Hz – 20 kHz	0.04 + 0.02	0.05 + 0.03	0.06 + 0.03	0.005 + 0.003
	20 – 50 kHz	0.1 + 0.04	0.11 + 0.05	0.12 + 0.05	0.011 + 0.005
	50 – 100 kHz	0.55 + 0.08	0.6 + 0.08	0.6 + 0.08	0.06 + 0.008
	100 – 300 kHz ^[1]	4.0 + 0.50	4.0 + 0.50	4.0 + 0.50	0.2 + 0.02
750 V	3 – 5 Hz	1.0 + 0.02	1.0 + 0.03	1.0 + 0.03	0.1 + 0.003
	5 – 10 Hz	0.35 + 0.02	0.35 + 0.03	0.35 + 0.03	0.035 + 0.003
	10 Hz – 20 kHz	0.04 + 0.02	0.05 + 0.03	0.06 + 0.03	0.005 + 0.003
	20 – 50 kHz	0.1 + 0.04	0.11 + 0.05	0.12 + 0.05	0.011 + 0.005
	50 – 100 kHz ^[2]	0.55 + 0.08	0.6 + 0.08	0.6 + 0.08	0.06 + 0.008
	100 – 300 kHz ^{[1] [2]}	4.0 + 0.5	4.0 + 0.5	4.0 + 0.5	0.2 + 0.02

[1] Typically 30 % reading error at 1 MHz
 [2] 750 Volt range is limited to 8 X 10⁷ volt-Hertz

Additional Low Frequency Errors

Error is stated as % of reading.

Frequency	AC Filter		
	3 HZ (slow)	20 HZ (medium)	200 HZ (fast)
10 – 20 Hz	0	0.25	–
20 – 40 Hz	0	0.02	–
40 – 100 Hz	0	0.01	0.55
100 – 200 Hz	0	0	0.2
200 Hz – 1 kHz	0	0	0.02
>1 kHz	0	0	0

Resistance

Specifications are for 4-wire resistance function, 2 x 4-wire resistance, or 2-wire resistance with zero. If zero is not used, add 0.2 Ω for 2-wire resistance plus lead resistance, and add 20 m Ω for 2 x 4-wire resistance function.

Measurement Method	Current source referenced to LO input
Max. Lead Resistance (4-wire ohms)	10 % of range per lead for 10 Ω , 100 Ω , 1 k Ω ranges. 1 k Ω per lead on all other ranges
Input Protection	1000 V on all ranges
Common Mode Rejection	140 dB at 50 or 60 Hz ± 0.1 % (1 k Ω unbalance)
Normal Mode Rejection	60 dB for NPLC of 1 or greater with analog filter off and power line frequency ± 0.1 % 100 dB for NPLC of 1 or greater with analog filter on and power line frequency ± 0.1 %
Analog Filter	When using the analog filter, specifications are relative to within one hour of using the ZERO function for that range and NPLC setting.

Input Characteristics

Range	Resolution	Resolution			Source Current
		4½ Digits	5½ Digits	6½ Digits	
10 Ω ^[1]	10.00000 Ω	1 m Ω	100 $\mu\Omega$	10 $\mu\Omega$	5 mA/13 V
100 Ω	100.0000 Ω	10 m Ω	1 m Ω	100 $\mu\Omega$	1 mA/6 V
1 k Ω	1.000000 k Ω	100 m Ω	10 m Ω	1 m Ω	1 mA/6 V
10 k Ω	10.00000 k Ω	1 Ω	100 m Ω	10 m Ω	100 $\mu\text{A}/6$ V
100 k Ω	100.0000 k Ω	10 Ω	1 Ω	100 m Ω	100 $\mu\text{A}/13$ V
1 M Ω	1.000000 M Ω	100 Ω	10 Ω	1 Ω	10 $\mu\text{A}/13$ V
10 M Ω	10.00000 M Ω	1 k Ω	100 Ω	10 Ω	1 $\mu\text{A}/13$ V
100 M Ω	100.0000 M Ω	10 k Ω	1 k Ω	100 Ω	1 $\mu\text{A} \parallel 10$ M $\Omega/10$ V
1.0 G Ω ^[1]	1.000000 G Ω	100 k Ω	10 k Ω	1 k Ω	1 $\mu\text{A} \parallel 10$ M $\Omega/10$ V

[1] 8846A Only

8846A Accuracy

Accuracy is given as \pm (% measurement + % of range)

Range	24 Hour (23 ± 1 $^{\circ}\text{C}$)	90 Days (23 ± 5 $^{\circ}\text{C}$)	1 Year (23 ± 5 $^{\circ}\text{C}$)	Temperature Coefficient/ $^{\circ}\text{C}$ Outside 18 to 28 $^{\circ}\text{C}$
10 Ω	0.003 + 0.01	0.008 + 0.03	0.01 + 0.03	0.0006 + 0.0005
100 Ω	0.003 + 0.003	0.008 + 0.004	0.01 + 0.004	0.0006 + 0.0005
1 k Ω	0.002 + 0.0005	0.008 + 0.001	0.01 + 0.001	0.0006 + 0.0001
10 k Ω	0.002 + 0.0005	0.008 + 0.001	0.01 + 0.001	0.0006 + 0.0001
100 k Ω	0.002 + 0.0005	0.008 + 0.001	0.01 + 0.001	0.0006 + 0.0001
1 M Ω	0.002 + 0.001	0.008 + 0.001	0.01 + 0.001	0.001 + 0.0002
10 M Ω	0.015 + 0.001	0.02 + 0.001	0.04 + 0.001	0.003 + 0.0004
100 M Ω	0.3 + 0.01	0.8 + 0.01	0.8 + 0.01	0.15 + 0.0002
1 G Ω	1.0 + 0.01	1.5 + 0.01	2.0 + 0.01	0.6 + 0.0002

8845A Accuracy

Accuracy is given as \pm (% measurement + % of range)

Range	24 Hour (23 \pm 1 °C)	90 Days (23 \pm 5 °C)	1 Year (23 \pm 5 °C)	Temperature Coefficient/ °C Outside 18 to 28 °C
100 Ω	0.003 + 0.003	0.008 + 0.004	0.01 + 0.004	0.0006 + 0.0005
1 k Ω	0.002 + 0.0005	0.008 + 0.001	0.01 + 0.001	0.0006 + 0.0001
10 k Ω	0.002 + 0.0005	0.008 + 0.001	0.01 + 0.001	0.0006 + 0.0001
100 k Ω	0.002 + 0.0005	0.008 + 0.001	0.01 + 0.001	0.0006 + 0.0001
1 M Ω	0.002 + 0.001	0.008 + 0.001	0.01 + 0.001	0.0010 + 0.0002
10 M Ω	0.015 + 0.001	0.02 + 0.001	0.04 + 0.001	0.0030 + 0.0004
100 M Ω	0.3 + 0.01	0.8 + 0.01	0.8 + 0.01	0.1500 + 0.0002

Additional Ohms Errors

Digits	NPLC	Additional NPLC Noise Error
6½	100	0 % of range
6½	10	0 % of range
5½	1	0.001 % of range
5½	0.2	0.003 % of range \pm 7 m Ω
4½	0.02	0.017 % of range \pm 15 m Ω

DC Current

Input Protection..... Tool-accessible 11 A/1000 V and 440 mA/1000 V fuses, limits of 400 mA continuous 550 mA for 2 minutes on, 1 minute off.

Common Mode Rejection 140 dB at 50 or 60 Hz \pm 0.1 % (1 k Ω unbalance)

Normal Mode Rejection 60 dB for NPLC of 1 or greater with analog filter off and power line frequency \pm 0.1 %
100 dB for NPLC of 1 or greater with analog filter on and power line frequency \pm 0.1 %

Analog Filter..... When using the analog filter, specifications are relative to within one hour of using the ZERO function for that range and NPLC setting.

Input Characteristics

Range	Resolution	Resolution			Shunt Resistance (Ohms)	Burden Voltage
		4½ Digits	5½ Digits	6½ Digits		
100 μ A	100.0000 μ A	10 nA	1 nA	100 pA	100 Ω	<0.015 V
1 mA	1.000000 mA	100 nA	10 nA	1 nA	100 Ω	<0.15 V
10 mA	10.000000 mA	1 μ A	100 nA	10 nA	1 Ω	<0.025 V
100 mA	100.0000 mA	10 μ A	1 μ A	100 nA	1 Ω	<0.25 V
400 mA ^[3]	400.0000 mA	100 μ A	10 μ A	1 μ A	1 Ω	<0.50 V
1 A ^[2]	1.000000 A	100 μ A	10 μ A	1 μ A	0.01 Ω	<0.05 V
3 A ^[1]	3.000000 A	1 mA	100 μ A	10 μ A	0.01 Ω	<0.15 V
10 A	10.000000 A	1 mA	100 μ A	10 μ A	0.01 Ω	<0.5 V

[1] Part of 10 A range.

[2] Available on the front panel terminal only.

[3] 400 mA available in software version 2.0 or greater only. 400 mA continuously; 550 mA for 2 minutes on, 1 minute off.

Accuracy (8846A)Accuracy is given as \pm (% measurement + % of range)

Range	24 Hour (23 \pm 1 $^{\circ}$ C)	90 Days (23 \pm 5 $^{\circ}$ C)	1 Year (23 \pm 5 $^{\circ}$ C)	Temperature Coefficient/ $^{\circ}$ C Outside 18 to 28 $^{\circ}$ C
100 μ A	0.01 + 0.02	0.04 + 0.025	0.05 + 0.025	0.002 + 0.003
1 mA	0.007 + 0.005	0.030 + 0.005	0.05 + 0.005	0.002 + 0.0005
10 mA	0.007 + 0.02	0.03 + 0.02	0.05 + 0.02	0.002 + 0.002
100 mA	0.01 + 0.004	0.03 + 0.005	0.05 + 0.005	0.002 + 0.0005
400 mA ^[3]	0.03 + 0.004	0.04 + 0.005	0.05 + 0.005	0.005 + 0.0005
1 A ^[2]	0.03 + 0.02	0.04 + 0.02	0.05 + 0.02	0.005 + 0.001
3 A ^{[1][2]}	0.05 + 0.02	0.08 + 0.02	0.1 + 0.02	0.005 + 0.002
10 A ^[2]	0.1 + 0.008	0.12 + 0.008	0.15 + 0.008	0.005 + 0.0008

[1] Part of 10 A range
 [2] Available at front panel connectors only
 [3] 400 mA available in software version 2.0 or greater only. 400 mA continuously; 550 mA for 2 minutes on, 1 minute off.

Accuracy (8845A)Accuracy is given as \pm (% measurement + % of range)

Range	24 Hour (23 \pm 1 $^{\circ}$ C)	90 Days (23 \pm 5 $^{\circ}$ C)	1 Year (23 \pm 5 $^{\circ}$ C)	Temperature Coefficient/ $^{\circ}$ C Outside 18 to 28 $^{\circ}$ C
100 μ A	0.01 + 0.02	0.04 + 0.025	0.05 + 0.025	0.002 + 0.003
1 mA	0.007 + 0.005	0.030 + 0.005	0.05 + 0.005	0.002 + 0.0005
10 mA	0.007 + 0.02	0.03 + 0.02	0.05 + 0.02	0.002 + 0.002
100 mA	0.01 + 0.004	0.03 + 0.005	0.05 + 0.005	0.002 + 0.0005
400 mA ^[3]	0.03 + 0.004	0.04 + 0.005	0.05 + 0.005	0.005 + 0.0005
1 A ^[2]	0.03 + 0.02	0.04 + 0.02	0.05 + 0.02	0.005 + 0.001
3 A ^{[1][2]}	0.05 + 0.02	0.08 + 0.02	0.10 + 0.02	0.005 + 0.002
10 A ^[2]	0.10 + 0.008	0.12 + 0.008	0.15 + 0.008	0.005 + 0.0008

[1] Part of 10 A range
 [2] Available at front panel connectors only
 [3] 400 mA available in software version 2.0 or greater only. 400 mA continuously; 550 mA for 2 minutes on, 1 minute off.

Additional Current Errors

Digits	NPLC	Additional NPLC Noise Error for 1 mA, 100 mA, 400 mA, 3 A and 10 A	Additional NPLC Noise Error for 100 μ A, 10 mA, 1 A
6 $\frac{1}{2}$	100	0 % of range	0 % of range
6 $\frac{1}{2}$	10	0 % of range	0 % of range
5 $\frac{1}{2}$	1	0.001 % of range	0.01 % of range
5 $\frac{1}{2}$	0.2	0.011 % of range \pm 4 μ A	0.11 % of range \pm 4 μ A
4 $\frac{1}{2}$	0.02	0.04 % of range \pm 4 μ A	0.28 % of range \pm 4 μ A

AC Current

The following ac current specifications are for sinusoidal signals with amplitudes greater than 5 % of range. For inputs from 1 % to 5 % of range, add an additional error of 0.1 % of range.

Input Protection..... Tool accessible 11 A/1000 V and 440 mA/1000 V fuses, limits of 400 mA continuous 550 mA for 2 minutes on, 1 minute off.

Measurement Method..... ac-coupled true-rms, dc-coupled to the fuse and shunt (no blocking capacitor)

AC Filter Bandwidth

Slow 3 Hz to 10 kHz

Medium 20 Hz to 10 kHz

8846A AccuracyAccuracy is given as \pm (% measurement + % of range)

Range	Frequency (Hz)	24 Hour (23 \pm 1 $^{\circ}$ C)	90 Days (23 \pm 5 $^{\circ}$ C)	1 Year (23 \pm 5 $^{\circ}$ C)	Temperature Coefficient/ $^{\circ}$ C Outside 18 to 28 $^{\circ}$ C
100 μ A	3 – 5 Hz	1.1 + 0.06	1.1 + 0.06	1.1 + 0.06	0.2 + 0.006
	5 – 10 Hz	0.35 + 0.06	0.35 + 0.06	0.35 + 0.06	0.1 + 0.006
	10 Hz – 5 kHz	0.15 + 0.06	0.15 + 0.06	0.15 + 0.06	0.015 + 0.006
	5 – 10 kHz	0.35 + 0.7	0.35 + 0.7	0.35 + 0.7	0.03 + 0.006
1 mA	3 – 5 Hz	1.0 + 0.04	1.0 + 0.04	1.0 + 0.04	0.1 + 0.006
	5 – 10 Hz	0.3 + 0.04	0.3 + 0.04	0.3 + 0.04	0.035 + 0.006
	10 Hz – 5 kHz	0.1 + 0.04	0.1 + 0.04	0.1 + 0.04	0.015 + 0.006
	5 – 10 kHz	0.2 + 0.25	0.2 + 0.25	0.2 + 0.25	0.03 + 0.006
10 mA	3 – 5 Hz	1.1 + 0.06	1.1 + 0.06	1.1 + 0.06	0.2 + 0.006
	5 – 10 Hz	0.35 + 0.06	0.35 + 0.06	0.35 + 0.06	0.1 + 0.006
	10 Hz – 5 kHz	0.15 + 0.06	0.15 + 0.06	0.15 + 0.06	0.015 + 0.006
	5 – 10 kHz	0.35 + 0.7	0.35 + 0.7	0.35 + 0.7	0.03 + 0.006
100 mA	3 – 5 Hz	1.0 + 0.04	1.0 + 0.04	1.0 + 0.04	0.1 + 0.006
	5 – 10 Hz	0.3 + 0.04	0.3 + 0.04	0.3 + 0.04	0.035 + 0.006
	10 Hz – 5 kHz	0.1 + 0.04	0.1 + 0.04	0.1 + 0.04	0.015 + 0.006
	5 – 10 kHz	0.2 + 0.25	0.2 + 0.25	0.2 + 0.25	0.03 + 0.006
400 mA ^[3]	3 – 5 Hz	1.0 + 0.1	1.0 + 0.1	1.0 + 0.1	0.1 + 0.006
	5 – 10 Hz	0.3 + 0.1	0.3 + 0.1	0.3 + 0.1	0.035 + 0.006
	10 Hz – 1 kHz	0.1 + 0.1	0.1 + 0.1	0.1 + 0.1	0.015 + 0.006
	1kHz – 10 kHz	0.2 + 0.7	0.2 + 0.7	0.2 + 0.7	0.03 + 0.006
1 A ^[2]	3 – 5 Hz	1.0 + 0.04	1.0 + 0.04	1.0 + 0.04	0.1 + 0.006
	5 – 10 Hz	0.3 + 0.04	0.3 + 0.04	0.3 + 0.04	0.035 + 0.006
	10 Hz – 5 kHz	0.1 + 0.04	0.1 + 0.04	0.1 + 0.04	0.015 + 0.006
	5 – 10 kHz	0.35 + 0.7	0.35 + 0.7	0.35 + 0.7	0.03 + 0.006
3 A ^{[1][2]}	3 – 5 Hz	1.1 + 0.06	1.1 + 0.06	1.1 + 0.06	0.1 + 0.006
	5 – 10 Hz	0.35 + 0.06	0.35 + 0.06	0.35 + 0.06	0.035 + 0.006
	10 Hz – 5 kHz	0.15 + 0.06	0.15 + 0.06	0.15 + 0.06	0.015 + 0.006
	5 – 10 kHz	0.35 + 0.7	0.35 + 0.7	0.35 + 0.7	0.03 + 0.006
10 A ^[2]	3 – 5 Hz	1.1 + 0.06	1.1 + 0.06	1.1 + 0.06	0.1 + 0.006
	5 – 10 Hz	0.35 + 0.06	0.35 + 0.06	0.35 + 0.06	0.035 + 0.006
	10 Hz – 5 kHz	0.15 + 0.06	0.15 + 0.06	0.15 + 0.06	0.015 + 0.006
	5 – 10 kHz	0.35 + 0.7	0.35 + 0.7	0.35 + 0.7	0.03 + 0.006

[1] Part of 10 A range

[2] Available only on front panel connectors

[3] 400 mA available in software version 1.0.700.18 or greater only. 400 mA continuously; 550 mA for 2 minutes on, 1 minute off; maximum crest factor 3:1 at 400 mA; specification for current above 329 mA is typical.

8845A Accuracy

Accuracy is given as \pm (% measurement + % of range)

Range	Frequency (Hz)	24 Hour (23 \pm 1 $^{\circ}$ C)	90 Days (23 \pm 5 $^{\circ}$ C)	1 Year (23 \pm 5 $^{\circ}$ C)	Temperature Coefficient/ $^{\circ}$ C Outside 18 to 28 $^{\circ}$ C
10 mA	3 – 5 Hz	1.1 + 0.06	1.1 + 0.06	1.1 + 0.06	0.2 + 0.006
	5 – 10 Hz	0.35 + 0.06	0.35 + 0.06	0.35 + 0.06	0.1 + 0.006
	10 Hz – 5 kHz	0.15 + 0.06	0.15 + 0.06	0.15 + 0.06	0.015 + 0.006
	5 – 10 kHz	0.35 + 0.7	0.35 + 0.7	0.35 + 0.7	0.03 + 0.006
100 mA	3 – 5 Hz	1.0 + 0.04	1.0 + 0.04	1.0 + 0.04	0.1 + 0.006
	5 – 10 Hz	0.3 + 0.04	0.3 + 0.04	0.3 + 0.04	0.035 + 0.006
	10 Hz – 5 kHz	0.1 + 0.04	0.1 + 0.04	0.1 + 0.04	0.015 + 0.006
	5 – 10 kHz	0.2 + 0.25	0.2 + 0.25	0.2 + 0.25	0.03 + 0.006
400 mA ^[3]	3 – 5 Hz	1.0 + 0.1	1.0 + 0.1	1.0 + 0.1	0.1 + 0.006
	5 – 10 Hz	0.3 + 0.1	0.3 + 0.1	0.3 + 0.1	0.035 + 0.006
	10 Hz – 1 kHz	0.1 + 0.1	0.1 + 0.1	0.1 + 0.1	0.015 + 0.006
	1kHz – 10 kHz	0.2 + 0.7	0.2 + 0.7	0.2 + 0.7	0.03 + 0.006
1 A ^[2]	3 – 5 Hz	1.0 + 0.04	1.0 + 0.04	1.0 + 0.04	0.1 + 0.006
	5 – 10 Hz	0.3 + 0.04	0.3 + 0.04	0.3 + 0.04	0.035 + 0.006
	10 Hz – 5 kHz	0.1 + 0.04	0.1 + 0.04	0.1 + 0.04	0.015 + 0.006
	5 – 10 kHz	0.35 + 0.7	0.35 + 0.7	0.35 + 0.7	0.03 + 0.006
3 A ^{[1][2]}	3 – 5 Hz	1.1 + 0.06	1.1 + 0.06	1.1 + 0.06	0.1 + 0.006
	5 – 10 Hz	0.35 + 0.06	0.35 + 0.06	0.35 + 0.06	0.035 + 0.006
	10 Hz – 5 kHz	0.15 + 0.06	0.15 + 0.06	0.15 + 0.06	0.015 + 0.006
	5 – 10 kHz	0.35 + 0.7	0.35 + 0.7	0.35 + 0.7	0.03 + 0.006
10 A ^[2]	3 – 5 Hz	1.1 + 0.06	1.1 + 0.06	1.1 + 0.06	0.2 + 0.006
	5 – 10 Hz	0.35 + 0.06	0.35 + 0.06	0.35 + 0.06	0.035 + 0.006
	10 Hz – 5 kHz	0.15 + 0.06	0.15 + 0.06	0.15 + 0.06	0.015 + 0.006
	5 – 10 kHz	0.35 + 0.7	0.35 + 0.7	0.35 + 0.7	0.03 + 0.006

[1] Part of the 10 A range

[2] Available only at front panel connectors

[3] 400 mA available in software version 1.0.700.18 or greater only. 400 mA continuously; 550 mA for 2 minutes on, 1 minute off; maximum crest factor 3:1 at 400 mA; specification for current above 329 mA is typical.

Additional Low Frequency Errors

Error is stated as % of reading.

Frequency	AC Filter		
	3HZ (slow)	20HZ (medium)	200HZ (fast)
10 – 20 Hz	0	0.25	–
20 – 40 Hz	0	0.02	–
40 – 100 Hz	0	0.01	0.55
100 – 200 Hz	0	0	0.2
200 Hz – 1 kHz	0	0	0.02
> 1 kHz	0	0	0

Frequency

Gate Times Programmable to 1 s, 100 ms, and 10 ms

Measurement Method Flexible counting technique. AC-coupled input using the ac voltage measurement function.

Settling Considerations When measuring frequency or period after a dc offset voltage change, errors may occur. For the most accurate measurement, wait up to 1 second for the input blocking capacitor to settle.

Measurement Considerations To minimize measurement errors, shield inputs from external noise when measuring low-voltage, low-frequency signals.

8846A AccuracyAccuracy is given as \pm % measurement

Range	Frequency	24 Hour (23 \pm 1 $^{\circ}$ C)	90 Days (23 \pm 5 $^{\circ}$ C)	1 Year (23 \pm 5 $^{\circ}$ C)	Temperature Coefficient/ $^{\circ}$ C Outside 18 to 28 $^{\circ}$ C
100 mV to 1000 V ^{[1][2]}	3 – 5 Hz	0.1	0.1	0.1	0.005
	5 – 10 Hz	0.05	0.05	0.05	0.005
	10 – 40 Hz	0.03	0.03	0.03	0.001
	40 Hz – 300 kHz	0.006	0.01	0.01	0.001
	300 kHz – 1 MHz	0.006	0.01	0.01	0.001
[1] Input >100 mV. For 10 – 100 mV, multiply percent measurement error by 10. [2] Limited to 8 X 10 ⁷ volt-Hertz					

8845A AccuracyAccuracy is given as \pm % measurement

Range	Frequency	24 Hour (23 \pm 1 $^{\circ}$ C)	90 Days (23 \pm 5 $^{\circ}$ C)	1 Year (23 \pm 5 $^{\circ}$ C)	Temperature Compensation/ $^{\circ}$ C Outside 18 to 28 $^{\circ}$ C
100 mV to 750 V ^{[1][2]}	3 – 5 Hz	0.1	0.1	0.1	0.005
	5 – 10 Hz	0.05	0.05	0.05	0.005
	10 – 40 Hz	0.03	0.03	0.03	0.001
	40 Hz – 300 kHz	0.006	0.01	0.01	0.001
[1] Input >100 mV. For 10 – 100 mV, multiply percent measurement error by 10. [2] Limited to 8 X 10 ⁷ volt-Hertz					

Gate Time vs. Resolution

Gate Time	Resolution
0.01	5½
0.1	6½
1.0	6½

Additional Low Frequency Errors

Error stated as percent of measurement for inputs >100 mV. For 10 – 100 mV, multiply percent by 10.

Frequency	Resolution		
	6½	5½	4½
3 – 5 Hz	0	0.12	0.12
5 – 10 Hz	0	0.17	0.17
10 – 40 Hz	0	0.2	0.2
40 – 100 Hz	0	0.06	0.21
100 – 300 Hz	0	0.03	0.21
300 Hz – 1 kHz	0	0.01	0.07
> 1 kHz	0	0	0.02

Capacitance (8846A Only)

Accuracy is stated as \pm (% of measurement + % of range)

Range	Resolution	1 Year Accuracy ^[1] (23 \pm 5 °C)	Temperature Coefficient/ °C Outside 18 to 28 °C
1 nF	1 pF	2% \pm 2.5 %	0.05 + 0.05
10 nF	10 pF	1% \pm 0.5 %	0.05 + 0.01
100 nF	100 pF	1% \pm 0.5 %	0.01 + 0.01
1 μ F	1 nF	1% \pm 0.5 %	0.01 + 0.01
10 μ F	10 nF	1% \pm 0.5 %	0.01 + 0.01
100 μ F	100 nF	1% \pm 0.5 %	0.01 + 0.01
1 mF	1 μ F	1% \pm 0.5 %	0.01 + 0.01
10 mF	10 μ F	1% \pm 0.5 %	0.01 + 0.01
100 mF	100 μ F	4% \pm 0.2 %	0.05 + 0.05

[1] Stated accuracy is attained when Zero function is used.

Temperature (8846A only)

Test Current..... 1 mA

Accuracy is stated as \pm °C and is based on a Platinum RT100 (DIN IEC 751, 385 type) RTD with less than 10 ohms lead resistance. The accuracy listed in the table below are valid only when using the 4-wire RTD measurement function. Specifications do not include probe accuracy, which must be added.

Range	Resolution	Accuracy		Temperature Coefficient/ °C Outside 18 to 28 °C
		90 Days (23 \pm 5 °C)	1 Year (23 \pm 5 °C)	
-200 °C	0.001 °C	0.06	0.09	0.0025
-100 °C	0.001 °C	0.05	0.08	0.002
0 °C	0.001 °C	0.04	0.06	0.002
100 °C	0.001 °C	0.05	0.08	0.002
300 °C	0.001 °C	0.1	0.12	0.002
600 °C	0.001 °C	0.18	0.22	0.002

Additional Errors

Digits	NPLC	Additional NPLC Noise Error
6 ½	100	0 °C
6 ½	10	0 °C
5 ½	1	0.03 °C
5 ½	0.2	0.12 °C
4 ½	0.02	0.6 °C

Continuity

Continuity Threshold..... Selectable between 1 Ω and 1000 Ω

Test Current..... 1 mA

Response Time..... 300 samples/sec with audible tone

Accuracy is given as \pm (% measurements + % of range)

Range	24 Hour (23 \pm 1 °C)	90 Days (23 \pm 5 °C)	1 Year (23 \pm 5 °C)	Temperature Coefficient/ °C Outside 18 to 28 °C
1000.0 Ω	0.002 + 0.01	0.008 + 0.02	0.01 + 0.02	0.001 + 0.002

Diode TestTest Current..... 100 μ A or 1 mA

Response Time..... 300 samples/sec with audible tone.

Accuracy is given as \pm (% measurements + % of range)

Range	24 Hour (23 \pm 1 $^{\circ}$ C)	90 Days (23 \pm 5 $^{\circ}$ C)	1 Year (23 \pm 5 $^{\circ}$ C)	Temperature Coefficient/ $^{\circ}$ C Outside 18 to 28 $^{\circ}$ C
5.0000 V	0.002 + 0.002	0.008 + 0.002	0.01 + 0.002	0.001 + 0.002
10.0000 V	0.002 + 0.001	0.008 + 0.002	0.01 + 0.002	0.001 + 0.002

Measurement Rates (IEEE488[4])

Function	Digits	Setting	Integration Time 60 Hz (50 Hz)	Measurements/Second ^[1]	
				8845A	8846A
DC Volts, DC Current, and Resistance	6½	100 NPLC	1.67 (2) s	0.6 (0.5)	0.6 (0.5)
	6½	10 NPLC	167 (200) ms	6 (5)	6 (5)
	5½	1 NPLC	16.7 (20) ms	60 (50)	60 (50)
	5½	0.2 NPLC	3.3 ms	270	270
	4½	0.02 NPLC	500 us	995	995
AC Voltage and AC Current ^[2]	6½	3 Hz		0.47	0.47
	6½	20 Hz		1.64	1.64
	6½	200 Hz ^[3]		4.5	4.5
Frequency and Period	6½	1 s		1	1
	5½	100 ms		9.8	9.8
	4½	10 ms		80	80
Capacitance	6½			NA	2

[1] Typical measurement rates with auto-zero off, delay = 0, display off, auto range off and math off.

[2] Maximum measurement rates for 0.01 % of ac step. When dc input varies, additional settling delay is required.

[3] For remote operation or external trigger using default settling delay

[4] Speeds available in OutG SW 1.0.700.18 or higher. Note that the measurements rates for RS232 can vary depending on the baud rate chosen. If the baud rate selected is 115,200, the maximum measurement rate is 711 measurement/s. The LAN bus has a maximum measurement rate of 963 measurement/s.

Chapter 2

Preparing the Meter for Operation

Title	Page
Introduction.....	2-3
Unpacking and Inspecting the Meter	2-3
Contacting Fluke	2-3
Storing and Shipping the Meter	2-3
Power Considerations	2-3
Selecting the Line Voltage	2-4
Replacing the Fuses	2-4
Line-Power Fuse	2-4
Current-Input Fuses.....	2-5
Connecting to Line Power	2-7
Turning Power-On	2-8
Adjusting the Bail	2-8
Installing the Meter in an Equipment Rack	2-8
Cleaning the Meter.....	2-9

Introduction

This chapter explains how to prepare the Meter for operation by selecting the proper line voltage, connecting an appropriate line power cord, and turning on the Meter. Also included is information on the proper storage and cleaning of the Meter.

Unpacking and Inspecting the Meter

Every care is taken in the choice of packing material to ensure that your equipment will reach you in perfect condition. If the equipment has been subject to excessive handling in transit, there may be visible external damage to the shipping carton. In the event of damage, the shipping container and cushioning material should be kept for the carrier's inspection.

Carefully unpack the Meter from its shipping container and inspect the contents for damaged or missing items. If the Meter appears damaged or something is missing, contact both the carrier and Fluke immediately. Save the container and the packing material in case you have to return the Meter.

Contacting Fluke

To order accessories, receive operating assistance, or get the location of the nearest Fluke distributor or Service Center, call:

USA:	1-888-44-FLUKE (1-888-443-5853)
Canada:	1-800-36-FLUKE (1-800-363-5853)
Europe:	+31 402-675-200
Japan:	+81-3-3434-0181
Singapore:	+65-738-5655
Anywhere in the world:	+1-425-446-5500
Service in USA:	1-888-99-FLUKE (1-888-993-5853)

Or, visit Fluke's Web site at www.fluke.com.

To register this product, visit <http://register.fluke.com>.

Storing and Shipping the Meter

The Meter should be stored under cover. The shipping container provides the most suitable receptacle for storage, as it provides the necessary shock isolation for normal handling operations.

Place the Meter inside a sealed bag. Place the bag into the cushioning material inside the shipping container, and store in a location that complies with the storage environment specification described in Chapter 1.

If the Meter is shipped, use the original shipping container if possible. It provides shock isolation for normal handling operations. If the original shipping container is not available, a box that is 17.5" x 15.5" x 8.0", with cushioning material that fills the space between the Meter and the sides of the box, should provide similar shock isolation.

Power Considerations

The Meter operates on power distribution standards found throughout the world, and must be set up to operate on the line voltage that will power it. The Meter is packed ready for use with a line voltage determined at the time of ordering. If the selected line voltage

does not match the power the Meter will be plugged into, then the Meter's line voltage setting must be changed and the line fuse possibly replaced.

Selecting the Line Voltage

The Meter will operate on any one of four different input line voltages. The set line voltage is visible through the window in the line fuse holder, found on the Meter's rear panel.

To change the line voltage:

1. Remove the power cord from the Meter.
2. Insert a small screwdriver blade in the narrow recess to the left of the fuse holder and pry to the right until the holder pops out, as shown in Figure 2-1.
3. Remove the voltage selector block from the fuse holder.
4. Rotate the selector block until the preferred voltage rating faces outward.
5. Replace the selector block back into the fuse holder.

Changing the line voltage setting may require a different line-power fuse for proper operation. Check Table 2-1 for the appropriate fuse for the selected line voltage.

With the voltage set and appropriate fuse installed, replace the fuse holder back into the Meter and reconnect the power cord.

Replacing the Fuses

The Meter employs fuses to protect both the line-power and current measurement inputs.

Line-Power Fuse

The Meter has a line-power fuse in series with the power supply. Table 2-1 indicates the proper fuse for each of the four line voltage selections. This fuse is located on the rear-panel.

To replace this fuse:

1. Unplug the power cord from the Meter.
2. Remove the fuse holder by inserting a small screwdriver blade in the narrow recess to the left of the fuse holder and pry to the right until the holder pops out as shown in Figure 2-1. The Meter is shipped with a replacement fuse of the same rating as the fuse installed in the fuse block.
3. Remove the fuse and replace with one rated appropriately for the selected line-power voltage. See Table 2-1.
4. Replace the selector block back into the fuse holder.

Warning

To avoid electric shock or fire, do not use makeshift fuses or short-circuit the fuse holder. Use only Fluke fuses

Table 2-1. Line Voltage to Fuse Rating

Line Voltage Selection	Fuse Rating	Fluke Part No.
100	0.25 A, 250 V (slow blow)	166306
120	0.25 A, 250 V (slow blow)	166306
220	0.125 A, 250 V (slow blow)	166488
240	0.125 A, 250 V (slow blow)	166488

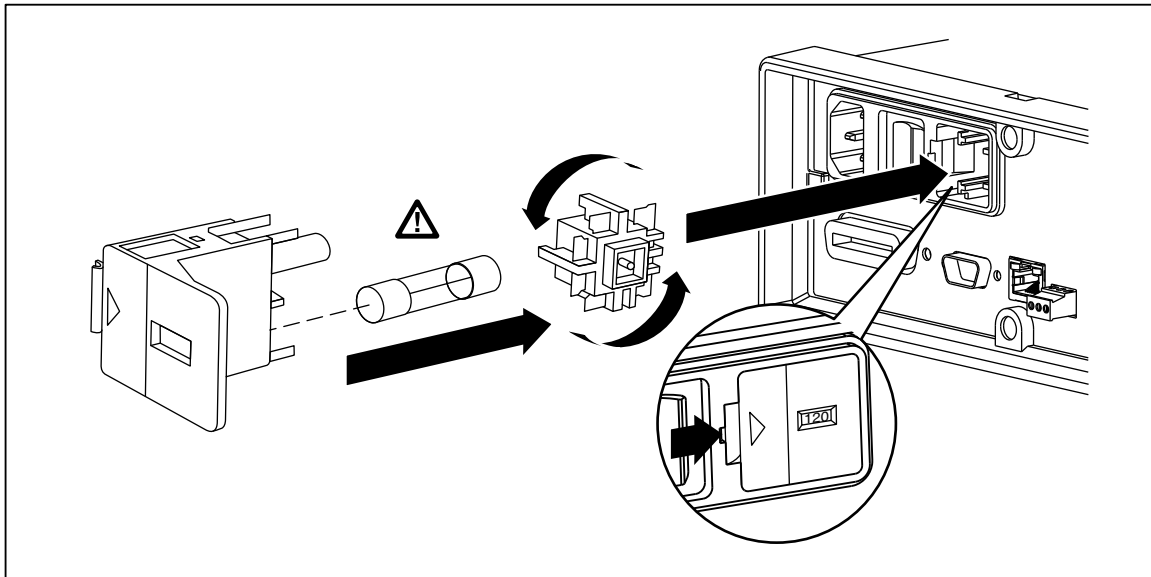

Figure 2-1. Replacing the Line Fuse

caw0201f.eps

Current-Input Fuses

The 400 mA and 10 A inputs are protected by user-replaceable fuses.

- The 400 mA input is protected by a fuse (F2) rated at 440 mA, 1000 V (fast blow), 10,000 A minimum breaking capacity (Fluke Part No. 943121).
- The 10 A input is protected by a fuse (F1) rated at 11 A, 1000 V (fast blow), 10,000 A minimum breaking capacity (Fluke Part No. 803293).

⚠ Warning

For protection against fire or arc flash, replace a blown fuse only with one from Fluke.

To test for a blown Current Input Fuse:

1. With the Meter powered up, plug a test lead into the **VΩ→←(←||)** connector.
2. Press **Ω**.
3. Insert the other end of the test lead into the 400 mA input connector.

If the fuse is good, the Meter will read less than 200 Ω. If the fuse is blown, the Meter will read **over load**.

4. Remove the probe from the 400 mA connector and insert into the 10 A connector.

If the fuse is good, the Meter will read less than 1 Ω . If the fuse is blown, the Meter will read **over load**.

To replace the Current Input fuses,

1. Turn the Meter off, unplug the power cord from the Meter, and remove all test leads.
2. Turn the Meter on its back.
3. Unscrew the retaining screw on the fuse access door as depicted in Figure 2-2.
4. Remove the protective cover from the fuse holders by slightly depressing the back edge of the cover to unlatch it from the printed circuit board. Pull up on the back edge of the cover and remove it from the fuse compartment.
5. Remove the defective fuse, and replace with one having the appropriate rating.
6. Replace the protective cover by pushing it over the fuses while aligning the catches with the holes in the printed circuit board. Press the cover down until the catches engage the printed circuit board.
7. Replace the fuse door and secure it by tightening the retaining screw.

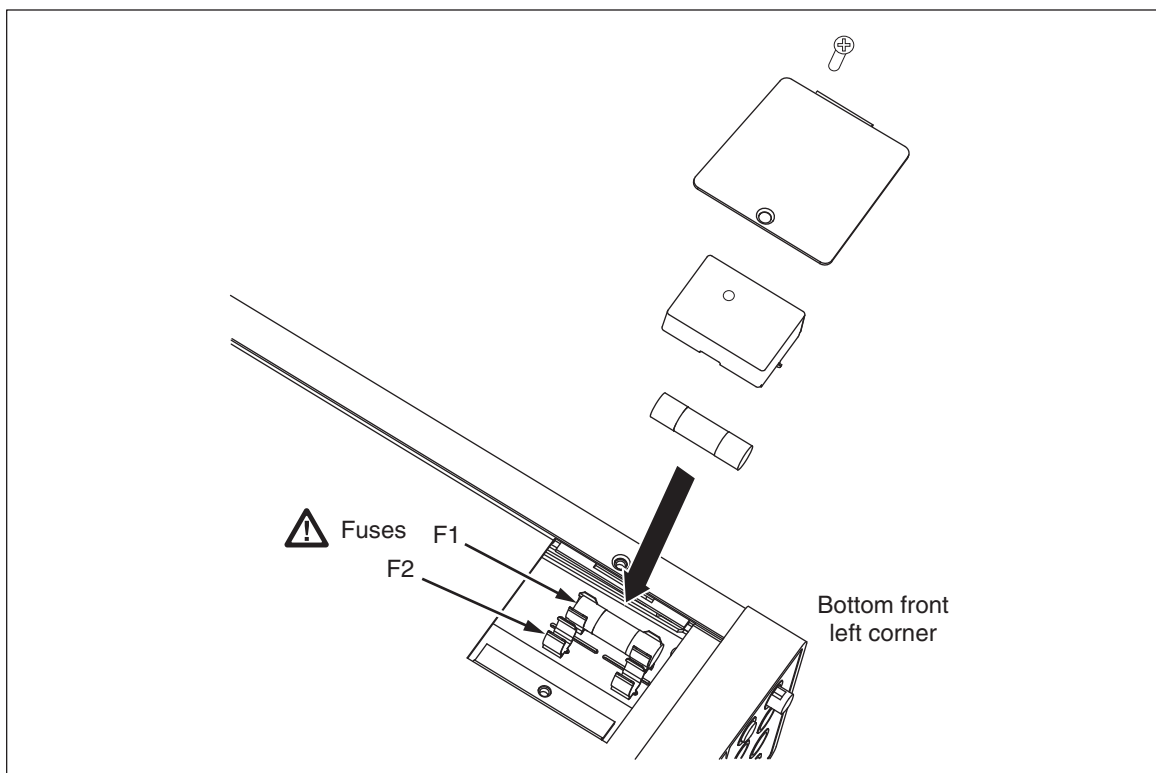

Figure 2-2. Replacing the Current Input Fuses

caw020.eps

Connecting to Line Power

⚠️⚠️ Warning

To avoid shock hazard, connect the factory supplied three-conductor line power cord to a properly grounded power outlet. Do not use a two-conductor adapter or extension cord; this will break the protective ground connection. If a two-conductor power cord must be used, a protective grounding wire must be connected between the ground terminal and earth ground before connecting the power cord or operating the instrument.

First verify that the line voltage selection is set to the correct position, and then that the correct fuse for that line voltage is installed. Connect the Meter to a properly grounded three-prong outlet.

Table 2-2. Line Power Cord Types Available from Fluke

Type	Voltage/Current	Fluke Model Number
North America	120V/15A	LC-1
North America	240V/15A	LC-2
Universal Euro	220V/16A	LC-3
United Kingdom	240V/13A	LC-4
Switzerland	220V/10A	LC-5
Australia	240V/10A	LC-6
South Africa	240V/5A	LC-7

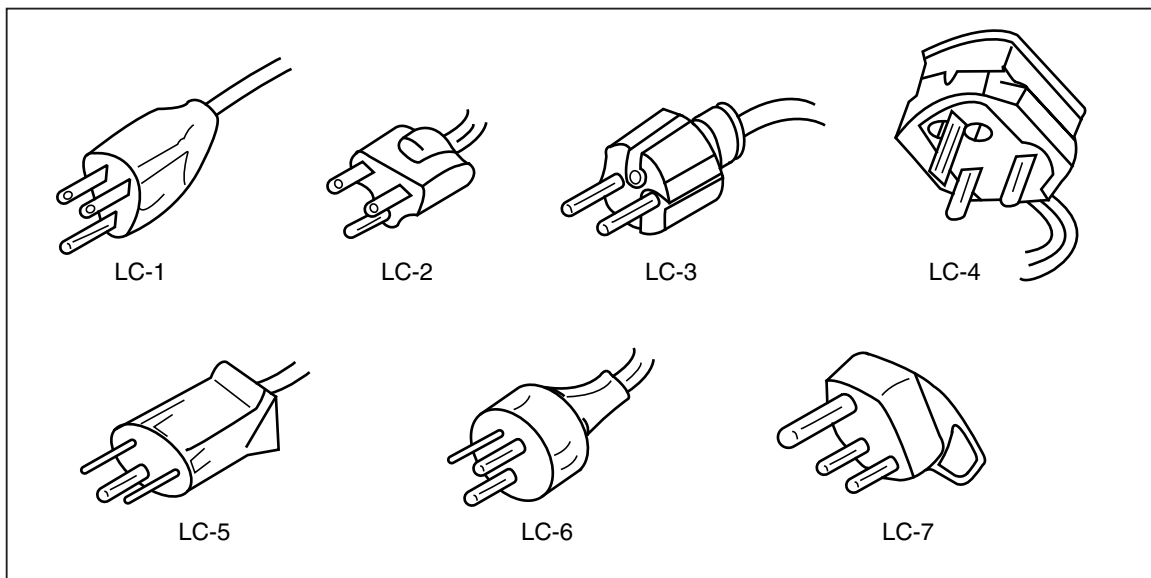

Figure 2-3. Line Power Cords Types Available from Fluke

alh3.eps

Turning Power-On

⚠ ⚠ Warning

To avoid electric shock, connect the Meter's power cord to a power receptacle with proper earth ground. A protective ground connection by way of the grounding conductor in the power cord is essential for safe operation.

With the proper line voltage selected and the appropriate power cord connected to the Meter, connect the power cord to a power outlet and switch rear-panel power switch so the "I" side of the switch is depressed.

Adjusting the Bail

For bench-top use, the Meter's bail or handle is adjustable to provide two viewing angles. To adjust its position, pull the ends out to a hard stop (about 1/4-inch on each side) and rotate it to one of the four stop positions shown in Figure 2-4. To completely remove the handle, adjust it to the vertical stop position and pull the ends all the way out.

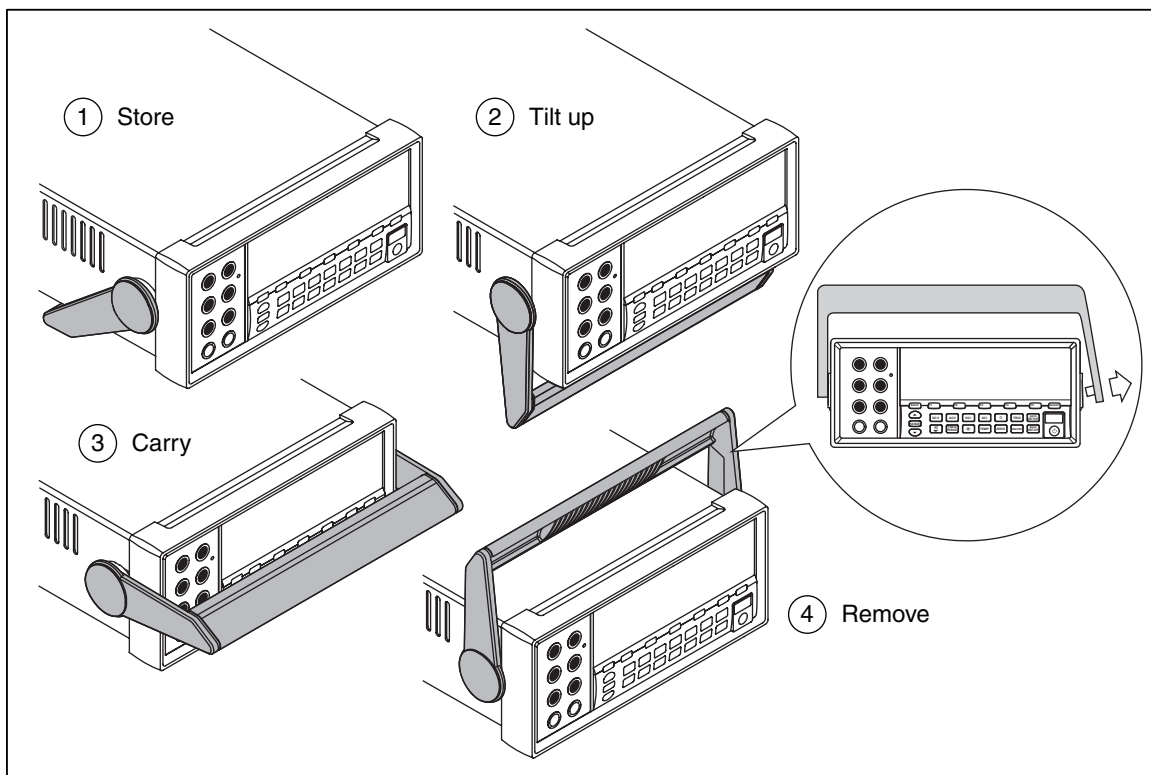

Figure 2-4. Bail Adjustment and Removal

caw017.eps

Installing the Meter in an Equipment Rack

The Meter is mountable in a standard 19-inch rack using a rack mount kit. See the "Options and Accessories" section in Chapter 1 for ordering information. In preparation for rack mounting, remove the bail (see the "Adjusting the Bail" section above) and the front and rear protective boots. Then refer to the instructions provided with the Rack Mount Kit to mount the Meter.

Cleaning the Meter

⚠️⚠️ Warning

To avoid electric shock or damage to the Meter, never get water inside the meter.

⚠️ Caution

To avoid damaging the Meter's housing, do not apply solvents to the Meter.

If the Meter requires cleaning, wipe it down with a cloth lightly dampened with water or a mild detergent. Do not use aromatic hydrocarbons, chlorinated solvents, or methanol-based fluids when wiping down the meter.

Chapter 3

Front-Panel Operation

Title	Page
Introduction.....	3-3
Controls and Indicators.....	3-4
Front-Panel Feature Descriptions.....	3-4
Display Panel.....	3-5
Rear-Panel Connectors.....	3-7
Adjusting the Meter's Range.....	3-8
Navigating the Front-Panel Menu.....	3-8
Configuring the Meter for a Measurement.....	3-8
Setting the Beeper State.....	3-8
Setting the Display Resolution.....	3-9
Setting the AC Signal Filter.....	3-9
Setting Continuity Resistance Threshold and Diode Test Parameters.....	3-10
Setting the Default Temperature Scale (8846A Only).....	3-10
Enabling High Input Impedance.....	3-10
Using the Analyze Functions.....	3-11
Collecting Statistics on Measurements.....	3-11
Testing Using Limits.....	3-12
Setting an Offset Value.....	3-13
Using MX+B.....	3-13
Using TrendPlot.....	3-14
Using the Histogram Function.....	3-15
Controlling Trigger Functions.....	3-16
Choosing a Trigger Source.....	3-16
Setting the Trigger Delay.....	3-17
Setting the Number of Samples.....	3-18
Understanding the Measurement Complete Signal.....	3-18
Accessing and Controlling Memory.....	3-18
Storing Readings in Memory.....	3-18
Recalling Readings from Memory.....	3-20
Storing Meter Configuration Information.....	3-20
Storing the Power-up Configuration.....	3-21
Recalling the Power-up Configuration.....	3-21
Removing the Power-up Configuration.....	3-22
Recalling a Meter Configuration.....	3-22
Managing Memory.....	3-22
Controlling System-Related Operations.....	3-23

Identifying Meter Errors.....	3-23
Querying the Firmware for Revision Level.....	3-24
Adjusting Display Brightness.....	3-24
Setting the Meter's Date and Time.....	3-24
USB Operation	3-24
USB Storage Capacity and Write Time.....	3-24
USB Memory Device Compatibility and Special Instruction	3-25
Configuring the Remote Interface	3-25
Checking the Meter's Calibration Date	3-25
Resetting the Meter's Default Settings	3-26

Introduction

The Meter can be controlled either by sending commands through one of its communication interfaces or by manually operating its front panel controls. This chapter explains the function and use of the controls and indicators located on the front and rear panels of the Meter. Operating the Meter through its computer interfaces is covered in the *Programmers Manual*. The following features are not available in OutGuard SW versions earlier than 2.0: DCI with DCV dual-function, DCV Ratio, 400 mA range, and digital filter. Also, the function softkey positions for earlier releases are slightly different than illustrated.

To view the OutG SW version:

1. Press .
2. Press the softkey labeled SYSTEM.
3. Press the softkey labeled VERSION.

Controls and Indicators

Front-Panel Feature Descriptions

Table 3-1 shows the Meter's front-panel controls and connectors.

Table 3-1. Front-Panel Controls and Connectors

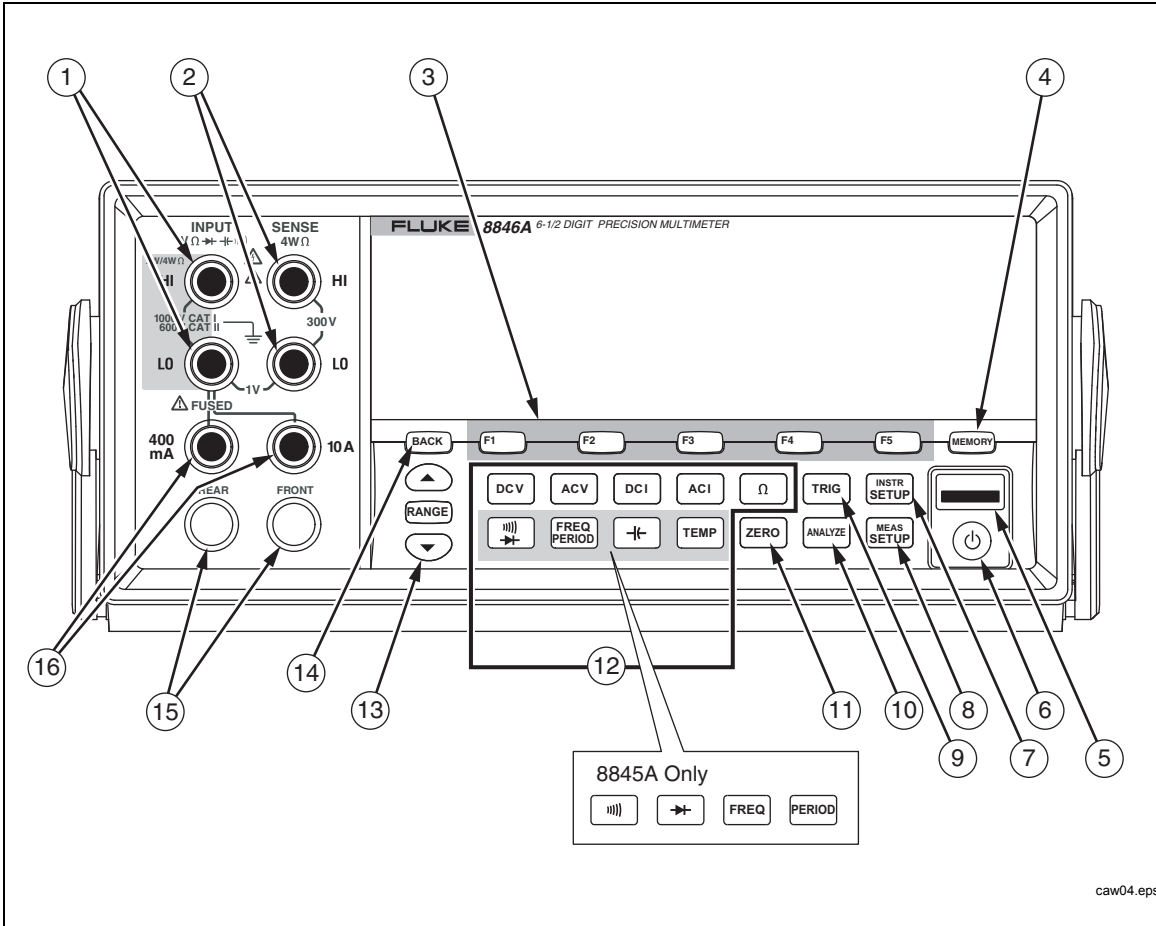

caw04.eps

Item	Description
①	Input HI and LO connectors. Input connectors for Volts, 2-wire Ohms, Hz, Period, Temperature, and Capacitance measurements. Input connectors source current for 4-wire Ohms measurements. All measurements use the Input LO connector as a common input. The LO input is isolated, and may be safely floated up to 1000 V above earth ground regardless of the measurement type. 1000 V is the maximum voltage rating between the Input HI and LO connectors and between each HI and LO input and earth ground.
②	Sense HI and LO connectors. Sense connectors sense the voltage across the unknown resistance for 4-wire Ohms measurements or provide the DCV reference Input for DCV Ratio measurements.
③	Soft keys F1 through F5. Soft keys are used to select various menu options while navigating the Meter's menus. Each soft key's function is identified with a label in the bottom row of the display. Keys without a label above them are inactive

Table 3-1. Front-Panel Controls and Connectors (cont.)

Item	Description
④	Memory key for accessing internal and external memory ^[1] containing meter setups and measurements. See the “Accessing and Controlling Memory” section for more information.
⑤	USB Port. ^[1] Connection for optional memory device to store meter readings.
⑥	Standby key to turn off the display. While in standby, the Meter will not respond to remote or front-panel commands. When taken out of standby, the Meter sets itself to its power-up configuration.
⑦	Instrument Setup key. Accesses communication interface selection and setup, remote command set, system settings, and meter reset.
⑧	Measurement Setup key. Accesses to resolution setting, trigger functions, temperature setup, dBm reference selection, continuity settings, and other measurement related parameters.
⑨	Trigger key. Triggers measurement when trigger is set to external triggering. See the “Controlling Trigger Functions” section later in this chapter to learn how to use the trigger key (TRIG) to control the Meter’s measurement cycle.
⑩	Analyze key. Accesses math functions, Statistics, TrendPlot, and Histogram.
⑪	Zero key. Uses the present reading as an offset value to create relative readings.
⑫	Meter function keys. Selects meter function between volts dc, volts ac, amp dc, amps ac, ohms, continuity, diode test, frequency, period, capacitance ^[1] , and temperature ^[1] . For the 8845A, the lower four keys select different functions; see inset.
⑬	Range keys. Selects between manual and auto range mode. Also increases or decreases the range when in manual ranging mode.
⑭	Back key. Backs up one layer in the menu selection.
⑮	Front and Rear input switch. All front-panel input connectors, except 10 A, are available on the rear-panel of the Meter. These switches switch the Meter’s input between them.
⑯	400 mA and 10 A input connectors for ac and dc current measurement functions.
Notes:	
[1] Available on 8846A only	

Display Panel

The display panel described in Table 3-1, performs the following three functions:

- Displays measurements as a value, with measurement units, and measurement statistics in both numerical and graphical format (TrendPlot and Histogram).
- Displays soft labels for soft keys, F1 through F5.
- Identifies the current mode of operation, Local (MAN) or Remote (REM).

Table 3-2. Display Elements

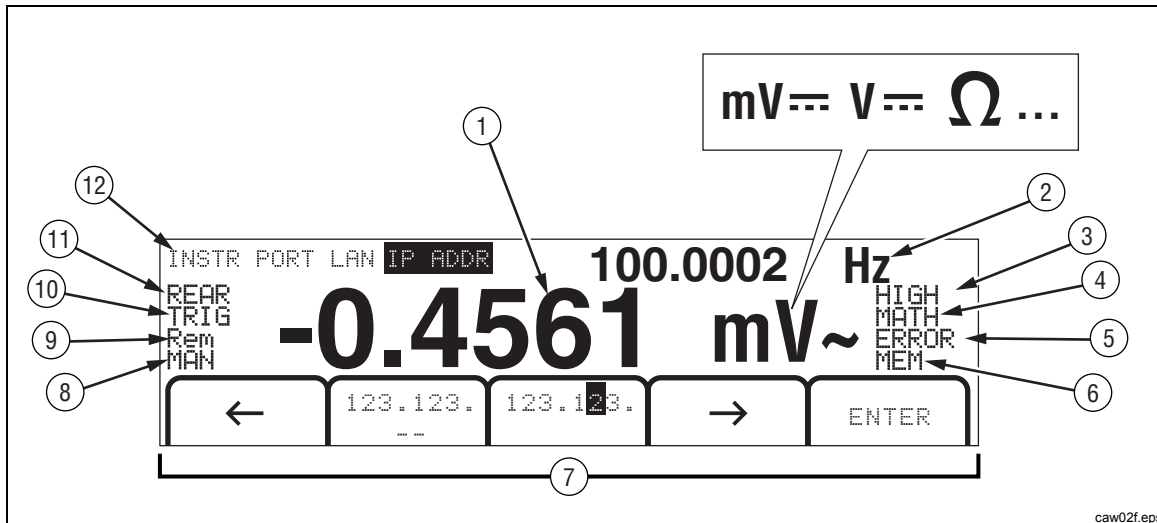

caw02f.eps

Item	Description
①	Primary display.
②	Secondary display.
③	Indicates PASS, HIGH or LOW for limits testing.
④	Math function selected.
⑤	Error detected.
⑥	Memory enabled for storing readings. Extinguishes when last sample is stored.
⑦	Softkey labels.
⑧	Manual range mode selected. See “Adjusting the Meter’s Range” section.
⑨	The Meter is under remote control.
⑩	External Trigger Enabled.
⑪	Rear inputs connectors selected.
⑫	Menu selection path.

Measurement results occupy the first two rows of the display. The primary display consists of larger sized characters that comprise the 6½ digits (-1999999 to 1999999), plus a decimal point. In the example shown above, the primary display shows measurement results for an ac voltage measurement.

The secondary display is smaller than the primary display and located in the upper right area of the display. However, it is also capable of displaying 6½ digits. Its function is to display the results of a secondary measurement associated with the primary measurement. In the example shown, the secondary display shows the frequency of the ac voltage measurement.

The Soft Key labels, row three, identify the functions of the five soft keys just below the display.

Rear-Panel Connectors

Table 3-3 indicates the connections on the rear panel and describes their use.

Table 3-3. Rear-Panel Connectors

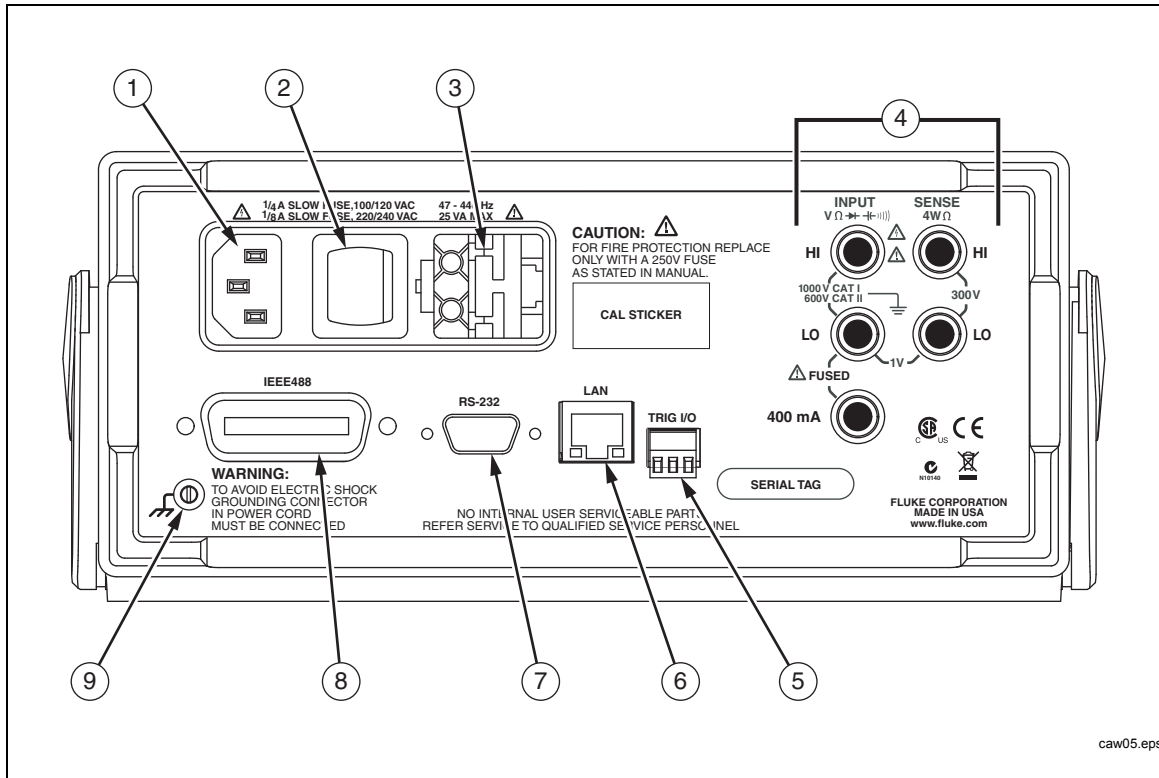



Item	Description
①	Line Power Cord connector
②	Power Switch
③	Fuse holder and power line voltage selector
④	Rear-panel input connectors ^[1]
⑤	External trigger input and measurement complete output port
⑥	Ethernet (LAN) connector
⑦	RS-232 connector. See appendix C for signals available on this connector.
⑧	IEEE 488 (GPIB) connector
⑨	Ground connector

Notes:

[1] 10 A current measurements can not be performed through the rear-panel connectors



Adjusting the Meter's Range

The range keys, ( **RANGE** ) , switch the Meter between auto and manual ranging. The presence or absence of **MAN** in the display indicates the Meter's ranging mode. All functions utilize these keys to control the Meter's range except continuity, diode test, temperature (8846A only), frequency and period, which only have a single range.

Note







The secondary display's range is always the same as that of the primary display when the functions are the same.

Pressing  causes the Meter to toggle between auto and manual ranging mode. The autorange selected range in use when you enter the manual range mode becomes the selected range. The Meter will extinguish **MAN** when autorange is selected.

Pressing  or  causes the Meter to switch from auto to manual ranging and moves the range up or down respectively from the range autorange had selected. **MAN** will also appear in the display. If the input signal is greater than the selected range can measure, the Meter displays **over load** and sends 9.9000 E+37 over the remote interface.

In autorange mode, the Meter automatically selects the next highest range when the measured value exceeds full scale of the present range. If no higher range is available, **over load** is displayed on the primary or secondary display. The Meter automatically selects the next lower range if the measured value drops below (11 %) of full scale.

Navigating the Front-Panel Menu

The Meter uses a multilevel menu system for the selection of function parameters, configuration, and features. Menu selection and navigation is accomplished with the front panel's five function keys (    ) and  key. Labeling of the five function keys is presented across the bottom row of the display and is dependent on which function is selected.

The following sections, "Configuring the Meter for a Measurement" and Chapter four's instructions on "Making Measurements", cover the use of the Meter's menu system.

Configuring the Meter for a Measurement

The Meter's display resolution, reading rate, trigger mode, continuity threshold, beeper on/off, input impedance setting, default temperature scale, and dBm reference are adjustable through the Measurement Setup function.

Setting the Beeper State

The Meter will emit a tone when a limit is exceeded during limit testing and when a forward-biased diode is measured during diode testing. To disable the beeper for these two conditions:

1. Press  .
2. Press the softkey labeled **MORE**.

If the softkey labeled **BEEP ON** is highlighted, press it to disable the beeper.

Note

Disabling the beeper has no effect on the tone when an error is generated during remote operation or when the continuity threshold is exceeded during continuity testing.

The beeper state is stored in non-volatile memory and does not change when the Meter is turned off or after a remote interface reset. The beeper is enabled when the Meter is shipped from the factory.

Setting the Display Resolution

The steps for setting the Meter's displayed resolution, varies depending on the selected function. The dc volts, dc current and ohms functions set the resolution based on the power line cycle (PLC) setting. AC volts, ac current, capacitance and temperature set resolution using a low, medium or high setting.

To set the Meter's display resolution dc volts, dc current and ohms:

1. Press **MEAS SETUP** to see the measurement Setup menu.
2. Press the soft key under the **RESOLUTION #DIG PLC** label to reveal the resolution selection menu.

The soft key labels are updated with five choices.

```

4 DIGIT .02 PLC
5 DIGIT .2 PLC
5 DIGIT 1 PLC
6 DIGIT 10 PLC
6 DIGIT 100 PLC
    
```

These choices determine the displayed resolution (4½, 5½, and 6½ digits) and the measurement cycle time in reference to the power line frequency in cycles (PLC)

For example, selecting **5 DIGIT 1 PLC** will display 5½ digit resolution and take a measurement using one power line cycle A/D integrate period. For 60 Hz power, a measurement is almost once every 60th of a second or 16.6666 milliseconds.

3. Press the soft key labeled with the desired resolution.

Note

Some of the faster PLC choices are not available when 2nd MEAS or DCV Ratio are selected.

To set the Meter's display resolution for ac volts, ac current, capacitance and temperature:

1. Press **MEAS SETUP** to see the measurement Setup menu.
2. Press the soft key under the **RESOLUTN** label to reveal the resolution selection menu.

Three soft key labels are updated with **HIGH**, **MEDIUM**, and **LOW**. The actual number of digits displayed will depend on the selected function and the Meter's range.

3. Press the soft key labeled with the desired resolution.

Setting the AC Signal Filter

There are three ac filter settings that can be employed to help make more accurate measurements: 3 Hz Slow, 20 Hz, and 200 Hz.

For the ac volts and ac current functions, a filter selection is available as a modifier. Pressing the **F i l t e r** soft key will expose a menu that allows you to select between the three filter settings.

Note

The 20 Hz filter is the power-up default selection.

Setting Continuity Resistance Threshold and Diode Test Parameters

The threshold resistance value for the continuity function and the amount of current and voltage used for Diode testing are adjustable. Continuity resistance threshold can be set to four different values: 1 Ω , 10 Ω , 100 Ω and 1 k Ω . Diode test voltage and current can also be set to two different values: 5 V or 10 V and 1 mA or 0.1 mA.

Setting the Continuity Threshold Resistance



The resistance threshold can be set at 1, 10, 100, or 1000 Ω . To set the threshold:

1. Press  to see the Measurement Setup menu.
2. Press the **MORE** soft key.
3. Press the **CONTIN OHMS** soft key.
4. Press the soft key labeled with the desired threshold.

Refer to the “Testing Continuity” section in Chapter 4 to test continuity.

Setting the Diode Test Voltage and Current

To set the diode test current:

1. Press  twice on the 8846A, or press  once on the 8845A, to select the Diode function.
2. Press the **1 mA** or **0.1 mA** soft key to set the diode test current.
3. Press the **5V** or **10V** soft key to set the diode test voltage.

Refer to the “Checking Diodes” section in Chapter 4 to check diodes.

Setting the Default Temperature Scale (8846A Only)

When the temperature function is selected, the Meter displays temperature measurements based on a preselected (default) temperature scale.

To change the default temperature scale:

1. Press  to see the measurement setup selection menu.
2. Press the **TEMP UNITS** soft key to display the temperature scale selection menu.
Available temperature scales are C for Celsius ($^{\circ}\text{C}$), F for Fahrenheit ($^{\circ}\text{F}$) and K for Kelvin (K).
3. Press the soft key labeled with the desired scale.

Refer to the “Measuring Temperature” section in Chapter 4 to make a temperature measurement with the Meter.

Enabling High Input Impedance

The DCV input impedance of the Meter is normally set to 10 M Ω . Enabling the high input impedance feature allows the input impedance to exceed 10 G Ω for the 10 V and lower DCV ranges.

To enable high input impedance:

1. Press  to see the Measurement Setup menu.

2. Press the **MORE** soft key.
3. Press the **HIGH INPUT Z** soft key.

The soft key label becomes highlighted to indicate high input Z is activated. Press the soft key again to disable the function.

Using the Analyze Functions

The Meter is capable of performing mathematical operations with measured values, as well as tracking a series of measurements. With the exception of Diode Test and Continuity, all Meter functions work with all analysis functions. The mathematical functions include statistics, limits, offset, and $mX + b$. Meter measurement tracking is performed through the TrendPlot and Histogram functions.

To access the analyze functions press .

Collecting Statistics on Measurements

The statistical analysis function displays the minimum and maximum measurements of a series of Meter measurements. The Meter also calculates an average and a standard deviation value for the same measurement series. This function also provides control over the starting and stopping of the measurement series.

Starting the Measurement Collection

To start the statistics process:

1. Press  to display the Meter's analysis menu.
2. Press the **STATS** soft key.

The Meter starts collecting data immediately. Individual readings are never stored in the Meter, but each reading is added to the Average and Standard Deviation calculation. At the same time, the measured value is compared to the values stored in the minimum and maximum registers, and overwrites one of these values if it is lower than the minimum value or greater than the maximum value.

While a series of measurements are being collected, the process can be stopped by pressing the **STOP** soft key. To start calculations on another series of measurements, press the **RESTART** soft key.

Reading the Min, Max, Std. Dev. and Avg. Values

As the measurements are collected, the display is continually updated with the latest statistical data as shown below.

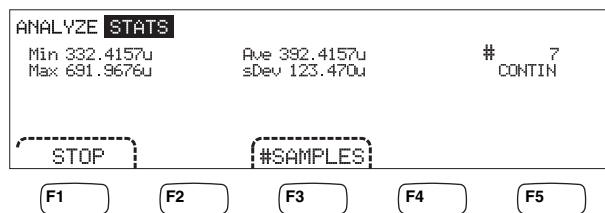

caw03.eps

The minimum, maximum, average, and standard deviation is displayed along with the number of measurements the statistics were calculated on.

Stopping Measurement Collection

There are two methods of stopping the collection of measurements for the statistics function.

To manually stop the measurement collection, press the **STOP** soft key from the statistics menu. The display will update with the final set of statistical data.

The process can also be stopped automatically by entering the number of samples on which you want to calculate statistics. To enter the number of statistic samples:

1. While in the statistics function, press **#SAMPLES**.
To select the digit to adjust, press the soft key labeled either **<--** or **-->**.
With the desired digit selected, press the soft key labeled **--** to decrement the digit or **++** to increment the character.
2. Press **ENTER** to set the number of samples.

Note

Setting the number of samples to zero will cause the Meter to collect samples continuously.

Testing Using Limits

The limits function provides Pass/Fail testing to user specified upper and lower limits. The upper and lower limits are stored in volatile memory and will be set to zero when the Meter is first turned on or the meter receives a reset through the remote interface. Changing the function will also set the limits to zero.

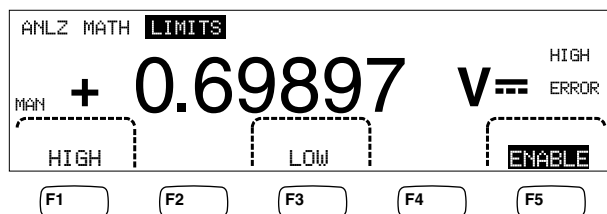

caw029.eps

When testing from the front panel, the Meter displays **OK** in the secondary display when the measurement is between the high and low limit. It displays **HIGH** or **LOW**, as shown above, for each measurement that exceeds the upper or lower limit. The beeper will beep once (if enabled) for the first measurement outside the limits after an **OK** measurement.

For remote operation, the Meter can be set to generate a service request (SRQ) on the first occurrence of a measurement outside the limits. See the *Programmers Manual* for information on enabling SRQ for this test.

To set the high and low limits through the front panel:

1. Press **ANALYZE**.
2. Press the **MATH** soft key
3. Press the **LIMITS** soft key.
4. Press the **HIGH** or **LOW** soft key as shown above to set the high or low limit respectively.

To select the digit to adjust, press either **<--** or **-->**.

With the desired digit selected, press the soft key labeled -- to decrement the digit or ++ to increment the character. The right most character is the multiplier. This character can be set to p, n, μ, m, k, M, or G.

5. Press **ENTER** to set the selected limit.
6. Press **ENABLE** to start the limits testing.

Note

Since the high and low limits are independent of each other, both high and low limit conditions could be satisfied by a measurement. In this case, the Meter gives priority to the low limit condition by displaying LOW and setting the low bit of the questionable data event register.

Refer to the *Programmers Manual* for instructions on setting the limits remotely.

Setting an Offset Value

The offset function provides a means of displaying the difference between a measured value and a stored offset value. This type of measurement is referred to as a relative measurement.

There are two methods of entering an offset value into the Meter. The first method is to enter a specified number into the offset register either through the front-panel or over the remote interface. Previously stored values are replaced with the new value. The offset value is stored in volatile memory and is set to zero when power is applied to the Meter or the Meter receives a reset through the remote interface.

The second method is to measure the desired reference value through the Meter's input connections and press **ZERO**. The measured value is placed into the offset register and the display immediately starts showing the difference between measurements and the stored value.

Note

The Zero key cannot be used to zero a DB or DBM measurement. Refer to "Measuring AC Voltage" in Chapter 4 of this manual.

To enter an offset value through the front-panel:

1. Press **ANALYZE**
2. Press the **MATH** soft key
3. Press the **OFFSET** soft key.

To select the digit to adjust, press either <-- or -->.

With the desired digit selected, press the soft key labeled -- to decrement the digit or ++ to increment the character. The right most character is the multiplier. This character can be set to p, n, μ, m, k, M, or G.

4. Press **ENTER** to set the value in the offset register.

Note

Limits and Offset are Math functions that cannot be active simultaneously.

Using MX+B

The MX+B function provides a means of calculating a linear value using a measured value (X) and two constants: M and B. The constant M represents a gain, while the constant B represents an offset.

To make an mX+B calculation:

1. Press **ANALYZE**.
2. Press the **MATH** soft key.
3. Press the **mX+B** soft key.

To enter the M value:

4. Press the **mX** soft key

To select the digit to adjust, press either **<--** or **-->**.

With the desired digit selected, press the soft key labeled **--** to decrement the digit or **++** to increment the character.

5. Press **ENTER** to enter the M value.
6. Press **BACK** to return to the MX+B menu.

To enter the B value:

7. Press the **B** soft key.

To select the digit to adjust, press either **<--** or **-->**.

With the desired digit selected, press the soft key labeled **--** to decrement the digit or **++** to increment the character. The right most character is the multiplier. This character can be set to p, n, μ , m, k, M, or G.

8. Press the **ENTER** soft key.
9. Press **BACK** to return to the MX+B menu.
10. Press the **ENABLE** soft key to start MX+B calculations.

ENABLE stays highlighted, and all displayed values are the measured value modified by the formula MX+B.

Pressing **ENABLE** again disables MX+B, and **ENABLE** is no longer highlighted. The MX+B calculation is applied after other MATH scaling calculations, but before other MATH comparisons.

Using TrendPlot

TrendPlot provides a visual representation of the measured signal over time. About three-quarters of the Meter's display is used to plot the maximum and minimum readings vertically, while the horizontal axis represents time. The vertical and horizontal axis' are not calibrated, and only represent relative time and amplitude depending on the input signal.

Each plot mark is a one pixel-wide vertical line that represents the highest (top of mark) and lowest (bottom of mark) reading the Meter has taken in the time since the previous mark was made. The left-most plot mark represents the time TrendPlot was started. When all available plot points across the plot area are filled, the Meter compresses the plot marks to one-half of the plot area. The compression process takes the highest and lowest reading between every two plot marks, and makes a single plot mark representing the highest and lowest readings of the two combined plot marks. Future plot marks added to the end of the compressed display are now the Meter's highest and lowest readings, taken over a time period twice as long as the period before the compression.

If the amplitude of the measured value exceeds the positive or negative range of the vertical axis, the Meter adjusts the vertical range to accommodate the range of the new

plot point. Previously laid down plot marks are adjusted down in size proportionally to the new vertical axis.

The left section of the Meter's display indicates the highest (maximum) and lowest (minimum) reading taken since the start of a TrendPlot session. In addition, the length of the TrendPlot session is displayed in hours, minutes, and seconds (hh:mm:ss).

To start a TrendPlot session:

1. Set up the Meter for the desired measurement by selecting the function and connecting the signal to the Meter's input.

Note

Setting the range function to manual will cause the Trendplot display to plot at the top or bottom edge of the plot area without making an amplitude adjustment when the input signal exceeds the limits of the Meter's range.

2. With the Meter taking measurements, press **ANALYZE**.
3. Press the **TREND PLOT** soft key to start the session.

As shown in Figure 3-1, the display will start plotting the readings across the plot area, and the maximum, minimum, and elapsed time are displayed. When there are longer intervals or delays between readings, TrendPlot will initially look like unconnected dots until enough time elapses to gather more readings.

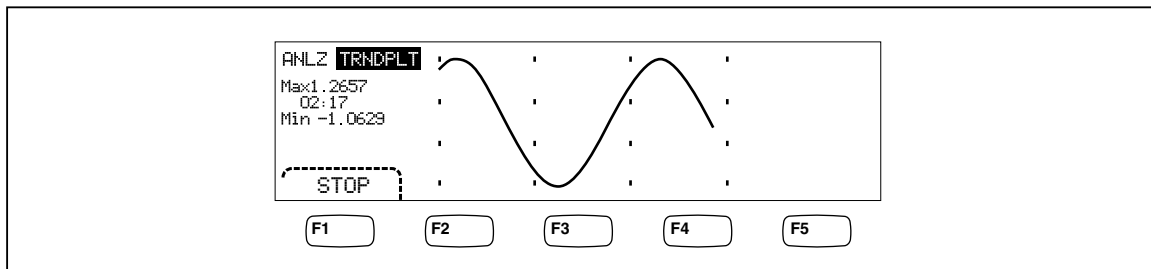

Figure 3-1. TrendPlot Display

caw057.eps

To stop the TrendPlot session, press **BACK** or the **STOP** soft key.

To start the TrendPlot session over, press the **STOP** soft key followed by the **RESTART** soft key.

Using the Histogram Function

The Histogram function provides a graphical representation of the standard deviation of a series of measurements. The right two-thirds of the Meter's display is used as a bar graph chart. The vertical axis is a relative measure of the number of readings while 10 vertical bars represent the standard deviation across the horizontal axis. The two center bars indicates the number of readings that fall on either side of the average reading within the 1st standard deviation. The two bars on either side of the center two bars represent the number of readings that fall within the 2nd standard deviation. The next two represent the 3rd standard deviation and so on to the 5th standard deviation.

The histogram function is helpful in looking at the standard distribution of the UUT. While observing the bar graph display (see Figure 3-2), adjust the UUT variable control to peak the center two bars of the histogram.

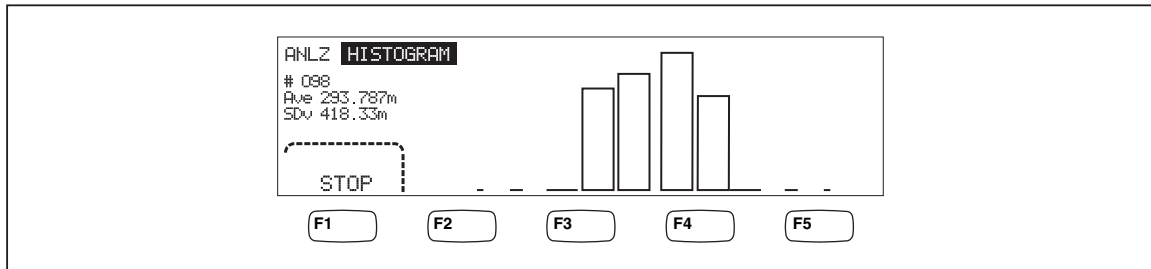

caw056.eps

Figure 3-2. Histogram Display

In addition to the bar graph, the left third of the display also displays the number of samples, the average, and standard deviation values.

To start a histogram session:

1. Set up the Meter for the desired measurement by selecting the function, and connecting the signal to the Meter's input.
2. With the Meter taking measurements, press **ANALYZE**.
3. Press **HISTOGRAM** to start the session.

The display will start adjusting the bar graph as the number of readings accumulates. The mean and standard deviation values also change in accordance with the collected readings.

To start the histogram session over, press the **STOP** soft key followed by the **RESTART** soft key.

To stop the histogram session, press **BACK** or the **STOP** soft key.

Controlling Trigger Functions

The Meter's trigger functions allows you to select a measurement trigger source, set the number of measurements (samples) per trigger, and set the delay time between receiving the trigger and the start of a measurement. In addition, the trigger function provides a "measurement complete" signal on the trigger port on the rear panel. See item 5 in Table 3-3. Triggering the Meter remotely through one of its communication interfaces is covered in the Programmers Manual. The following sections discuss triggering the Meter automatically (internal trigger), or externally using the trigger key on the front panel and the trigger connector on the rear-panel.

Setup and control of the trigger function is accessible through the Meter's Measurement Setup key **MEAS SETUP**.

Choosing a Trigger Source

There are four possible sources for triggering a Meter measurement: automatic, front panel trigger key **TRIG**, external, and remote. With the exception of remote triggering, trigger source selection is through the trigger menu, found under the measurement setup menu.

To select a trigger source:

1. Press **MEAS SETUP** to see the measurement setup menu.
2. Press the **TRIGGER** soft key to reveal the trigger control selections.

Note

Setting the Meter to trigger via a remote command is only accessible through the remote interface. See the “Triggering” section in the Programmers Manual for more information on remote triggering.

Auto Triggering

In auto trigger mode, the Meter’s measurements are triggered by internal circuitry. These triggers are continuous and occur as fast as the configuration will allow. Auto triggering is the Meter’s power-on trigger source.

To return the Meter to auto trigger mode,

1. Press **MEAS SETUP**.
2. Press the soft key labeled **TRIGGER**. If the Meter is in external trigger mode, the soft key label **EXT TRIG** will be highlighted in the display.
3. Press the soft key labeled **EXT TRIG**.

External Triggering

In the external trigger mode, a Meter measurement starts each time a low-true pulse is sensed on the external trigger connector or the front-panel trigger key **TRIG** is pressed. For each trigger or pulse received, the Meter will take the specified number of measurements after the specified trigger delay.

Note

The trigger key is disabled whenever the Meter is in Remote mode.

To set up for an external trigger:

1. Press **MEAS SETUP**.
2. Press the soft key labeled **TRIGGER**.
3. Press the soft key labeled **EXT TRIG**.

The Ext Trig soft key label will remain highlighted to indicate the Meter is in external trigger mode. To return to auto trigger mode, press **EXT TRIG** again.

If the Meter does not receive a trigger for a few seconds, a **TRIG** annunciator illuminates indicating the Meter is waiting for a trigger and a lightning bolt appears indicating the Meter does not know what voltage is applied to the terminals. Each press of the trigger key **TRIG** or an active low pulse on the trigger port will initiate a measurement.

Setting the Trigger Delay

A Meter measurement can be delayed a set amount of time after receiving a trigger. This feature may be useful when you need to wait for a signal to settle before measuring it. When a trigger delay is specified, that delay is used for all functions and ranges.

To set a trigger delay:

1. Press **MEAS SETUP**.
2. Press the soft key labeled **TRIGGER**.
3. Press the soft key labeled **SET DELAY**.

The trigger delay can be set between 0 and 3600 seconds with a resolution of 10 microseconds.

4. To select a specific digit to adjust, press either <-- or -->.

With the desired digit selected, press the soft key labeled -- to decrement the digit or ++ to increment the digit.
5. With the desired delay set, press the soft key labeled ENTER.

Setting the Number of Samples

Normally, the Meter takes one measurement (or sample) each time a trigger is received if in “wait-for-trigger” state. However, you can set the Meter to take a specified number of measurements for each trigger.

To set the number of samples per trigger:

1. Press **MEAS SETUP**.
2. Press the soft key labeled TRIGGER.
3. Press the soft key labeled #SAMPLES.

The number of samples per trigger can be set between 0 and 50000 samples.

4. To select a specific digit to adjust, press either <-- or -->.

With the desired digit selected, press the soft key labeled -- to decrement the digit or ++ to increment the digit.
5. With the desired delay set, press the soft key labeled ENTER.

Understanding the Measurement Complete Signal

The trigger port on the Meter’s back panel provides a low-true pulse at the completion of each Meter measurement. See the specifications section for more details on this signal.

Accessing and Controlling Memory

The Meter stores readings and meter configuration information using internal and external memory (8846A only). On the 8846A, external memory connects through the USB port on the front panel of the Meter. Optional Memory in various storage capacities is available from Fluke. See the “Options and Accessories” section in Chapter 1 for Fluke part numbers. In addition to storing and recalling readings and configurations, a memory management function is available to delete files.

To access the Memory functions, press the **MEMORY** key. The memory menu appears over the five soft keys: RECALL CONFIG, RECALL READING, STORE CONFIG, STORE READINGS, and MANAGE MEMORY.

Storing Readings in Memory

The Meter will hold up to 9999 readings in one internal memory file. The 8846A, with external memory, will hold 999 additional readings files, each of which will store up to 10000 readings.

To store readings in internal memory:

1. Press **MEMORY**.

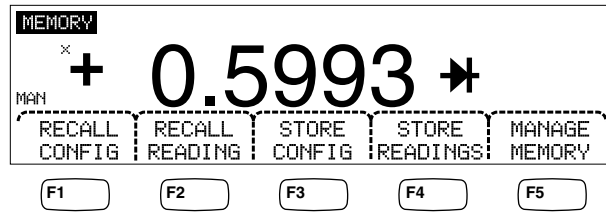

caw032.eps

2. Press the **STORE READINGS** soft key shown above.
3. If not already highlighted, press the **INTERNAL MEMORY** soft key.
4. Press the **#SAMPLES** soft key.
5. To adjust the number of samples, press either **<--** or **-->** to select a digit.
 With the desired digit selected, press the soft key labeled **--** to decrement the digit or **++** to increment the character. When 2nd Meas is enabled, each primary and secondary reading is counted as a sample and appears in a separate line/row in the readings file.
6. With the desired number of samples set, press the **ENTER** soft key to return to the store readings menu.
7. Press the **START** soft key to initiate measurement storing. The **START** soft key will change to **STOP** which can be pressed to stop the storage process. When the requested number of samples have been stored, the soft key label changes back to **START**. The MEM annunciator in the display also illuminates while readings are being stored.

Note

For internal storage of readings, the number of readings stored will not exceed 9999 readings regardless of the value set for number of samples.

To store readings in external memory (8846A Only)

1. Press **(MEMORY)**.
2. Press the **STORE READINGS** soft key.
3. Press the **USB** soft key.
4. Press the **#SAMPLES** soft key.
5. To adjust the number of samples, press either **<--** or **-->** to select a digit.
 With the chosen digit selected, press the soft key labeled **--** to decrement the digit or **++** to increment the character.
6. With the number of samples set, press the **ENTER** soft key to return to the Store Readings menu.
7. Press the **START** soft key to begin storing measurements. The **START** soft key will change to **STOP** which can be pressed to stop the storage process. When the requested number of samples have been stored, the soft key label changes back to **START**. The MEM annunciator in the display also illuminates while readings are being stored.

Note

Each memory file will store up to 10000 readings. If the number of samples is set to a value greater than 10000, consecutive memory files will be used to store all the samples. If the readings fill the last file (999), reading storage will stop.

Recalling Readings from Memory

To recall readings from internal memory:

1. Press **MEMORY**.
2. Press the **RECALL READING** soft key.

The Meter displays the first stored reading from the internal file. Four soft keys provide the means to scroll through the readings stored in the file. The **FIRST** soft key displays the first reading in the file while the **LAST** soft key displays the last reading. Use the **<--** and **-->** soft keys to move forward and backward through the file one reading at a time.

To recall readings from external memory (8846A Only), the memory device must be removed from the 8846A and plugged into a PC where the comma delimited files can be read. Each file is labeled MEAS0XXX.CSV. The XXX is the file number starting at 001 and going up to 999. Each file is date and time stamped.

Storing Meter Configuration Information

Up to five meter configurations can be stored in the Meter's internal memory. The 8846A, with optional USB memory installed, can store an additional 99 configurations in the external memory.

To store a meter configuration in the Meter's internal memory:

1. Press **MEMORY**.
2. Press the **STORE CONFIG** soft key as shown below.

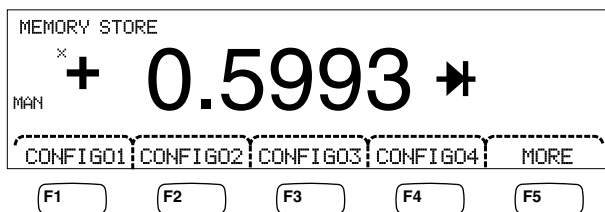

caw033.eps

3. Press the **STORE INT MEM** soft key.
4. Press one of the five soft keys labeled with the desired memory location to store the present Meter configuration.

To store a meter configuration in to optional external memory (8846A Only):

1. Press **MEMORY**.
2. Press the **STORE CONFIG** soft key.
3. Press the **STORE USB** soft key.

The Meter labels the first four soft keys with the first four memory locations. **CONFIG01** through **CONFIG04**. The fifth soft key is labeled **MORE** to allow access to all 100 memory locations.

- To store the present Meter configuration in one of the first four memory locations, press the appropriate soft key. If you want to store the present Meter configuration in a location other than the first four locations, press the **MORE** soft key.

The display indicates the next available memory location. If all configuration memory locations are filled, the Meter will always indicate memory location 10.

- To adjust the display to the desired memory location, press either $\langle --$ or $-- \rangle$ to select a specific digit.

With the digit selected, press the soft key labeled $--$ to decrement the digit or $++$ to increment the digit.

- With the preferred memory location set, press the **ENTER** soft key to store the Meter configuration.

Storing the Power-up Configuration

To store the Meter's present configuration as a power-up configuration:

- Press **MEMORY**.
- Press the **STORE CONFIG** softkey.
- Press the **STORE POWER-UP** softkey.

The Meter configuration stored as a power-up configuration will be set whenever the Meter is powered on.

Note

LAN port remote settings (address, hostname, DHCP, mask, etc.) are saved separately when selected in each instrument, and are not included in individually stored/copied configurations.

Recalling the Power-up Configuration

In addition to having the power-up configuration to set up the Meter at power on, the power-up configuration can be recalled through the front-panel keys. To recall the power-up configuration:

- Press **MEMORY**.
- Press the **RECALL POWER-UP** softkey.

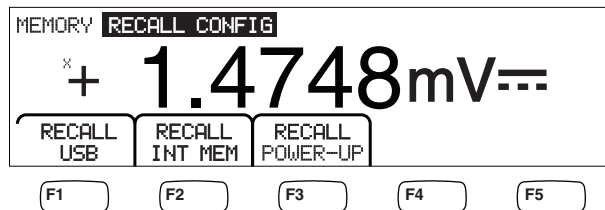

caw063.eps

- Press the **RECALL CONFIG** softkey.

Note

*The **RECALL POWER-UP** softkey will only appear when a power-up configuration has been saved in the Meter's memory.*

Removing the Power-up Configuration

To remove the Meter's stored power-up configuration:

4. Press **MEMORY**.
5. Press the **STORE CONFIG** softkey.
6. Press the **REMOVE POWER-UP** softkey.

After removing the power-up configuration, power the Meter down and back up using the rear-panel power switch to restore factory default settings.

Recalling a Meter Configuration

To recall a configuration from internal memory:

1. Press **MEMORY**.
2. Press the **RECALL CONFIG** soft key.
3. Press the **RECALL INT MEM** soft key.
4. Press the soft key labeled with the memory location (**CONFIGA** through **CONFIGE**).

To recall a configuration from external memory (8846A Only):

1. Press **MEMORY**.
2. Press the **RECALL CONFIG** soft key.
3. Press the **RECALL USB** soft key.

The Meter labels the first four soft keys with the first four memory locations **CONFIG01** through **CONFIG04**. The fifth soft key is labeled **MORE** to allow access to all 100 memory locations.

4. To recall the Meter configuration from one of the first four memory locations, press the appropriately labeled soft key. If you want a memory location other than the first four locations, press the **MORE** soft key.

The display indicates the last memory location containing a Meter configuration. If all configuration memory locations are filled, the Meter will always indicate memory location 10.

5. To select the memory location, press either **<--** or **-->** to select a specific digit. With the digit selected, press the soft key labeled **--** to decrement the digit or **++** to increment the digit.
6. Once the chosen memory location is set, press the **ENTER** soft key to recall that Meter configuration.

Note

Incompatible configurations (from incompatible configuration versions) will not be loaded, but will generate error +229 "Incompatible measurement configuration not loaded".

Managing Memory

The Meter provides a method of clearing internal memory and displaying the status of external memory (8846A Only). Per Department of Defense requirements, the Meter allows the erasure of Meter configuration and data files from external USB memory modules. Other files are not erased from the modules.

To copy the last or interrupted readings file from internal memory to an already-inserted USB memory device:

1. Press **MEMORY**.
2. Press the **INIT MEAS TO USB** soft key.

The copy process will take several seconds.

To erase USB memory, refer to the “Media Memory” section in Chapter 1.

To clear internal memory contents:

3. Press **MEMORY**.
4. Press the **MANAGE MEMORY** soft key as shown below.

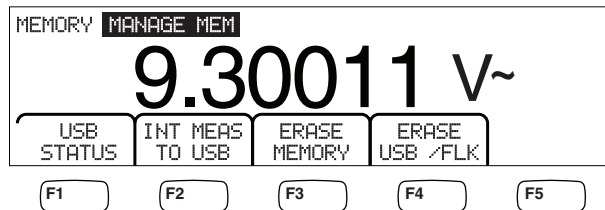

caw062.eps

5. Press the **ERASE MEMORY** soft key.
6. If you are sure you want to clear all stored readings, all stored configurations, the user string and the hostname from internal memory, press the **ERASE** soft key. If not, press the **CANCEL** soft key.

To check the amount of external memory available (8846A Only):

1. Press **MEMORY**.
2. Press the **MANAGE MEMORY** soft key.
3. Press the **USB STATUS** soft key.

After a few seconds, the Meter displays the total external memory, the amount of external memory used and free external memory.

Controlling System-Related Operations

Identifying Meter Errors

When the Meter detects an error, the error annunciator (item 5 in Table 3-2) is illuminated, and the beeper sounds. A list of possible Meter errors can be found in Appendix B of this manual.

To read the error or errors:

1. Press **INSTR SETUP**.
2. Press **SYSTEM**.
3. Press **ERROR**.
4. The first error, if there is more than one, is displayed. To read additional errors, press **NEXT**.

If you want to erase all error messages without looking at each, press the **CLR ALL** soft key.

Querying the Firmware for Revision Level

The Meter makes available the hardware version, software version, and serial number of the instrument.

To view the versions and serial number:

1. Press **INSTR SETUP**.
2. Press the soft key under **SYSTEM**.
3. Press the soft key under **VERSIONS + SN** under the Setup menu.

The display shows the outguard software version (**OutG SW**), the inguard software version (**InG SW**), the outguard hardware version (**OutG HW**) and the inguard hardware version (**InG HW**). Also displayed is the Meter's serial number (**Serial #**).

Adjusting Display Brightness

Setting the brightness of the display is accessible through the Instrument Setup key.

To adjust display brightness:

1. Press **INSTR SETUP**.
2. Press the **SYSTEM** soft key.
3. Press the **BRIGHT** soft key.
4. Press one of the soft keys under **LOW**, **MEDIUM**, and **HIGH**.
5. Press **BACK** to return to the previous menu.

Setting the Meter's Date and Time

1. Press **INSTR SETUP**.
2. Press the **SYSTEM** soft key.
3. Press the **DATE TIME** soft key.
4. To adjust the display to the desired date and time, press either **<--** or **-->** to select a specific digit or the month.

With the desired digit or month selected, press the soft key labeled **--** to decrement the digit or **++** to increment the digit.

5. Press the **ENTER** soft key to set the date and time and return to the system menu.

USB Operation

Starting with software version OutG SW 1.0.688.18, the USB memory operation offers a variety of capabilities. As an example, a USB device can be used to store readings either directly from the A/D or by transferring readings from internal memory. The data stored in the USB memory device is in a comma delimited (CSV) format.

USB Storage Capacity and Write Time

The 8846A USB storage limit is 50,000 readings every time **START** is pressed (*F1 soft key press*). Previous versions stored 50,000 readings in 10 files, each with 5,000 readings. This version stores 50,000 readings in five files, with 10,000 readings each.

If storing readings to the USB memory device is not completed (or is interrupted by changing function, NPLC, remote...), press **MEMORY**, **MANAGE MEMORY**, **INIT MEAS TO USB** so volatile readings in internal memory are stored to the USB.

If **STOP** is selected during storage to the USB device, readings in internal memory will be written directly to the device. Note that this may take several seconds. A USB memory device should never be removed while a write is occurring.

The data is initially stored in internal memory and then transferred to the USB memory device. For large data samples (i.e. > 10,000 readings), when 10,000 readings have been stored in the internal memory, the data will be transferred to the USB memory device. The front panel display shows “**BUSY WRITING USB**” during the write. For 10,000 samples, the write time will typically take ~14 seconds.

In ACV, you can press dB, dBm, or zero while data is being stored. Units (and dgC, dgF, K etc) can be changed in the middle of a USB readings file as well.

Each *.CSV file stored or copied to the USB memory device shows the date + time of the first sample line/row and the date + time of the last sample in each file.

Note

Readings are not stored during the time each file is written to USB memory stick, which can take 7 - 15 seconds. As a result, when storing more than 10,000 readings, there will be data gaps during the time the file is written to the USB memory device.

Note

When using Mx+B and other math functions, the internal sampling rate is slowed to permit data collection without loss. As an example, with Mx+B active, the maximum dcV storage rate is ~340 reading/s.

USB Memory Device Compatibility and Special Instruction

After inserting a USB memory device (Mass Storage Device) into the 8846A, wait 5+ seconds for the USB memory to be mounted before initiating any memory or measurement activity.

Press **[MEMORY]**, **MANAGE MEMORY**, and **USB STATUS** to verify a USB memory device is readable by the 8846A Not all USB memory devices are usable. Devices that try to upload their own driver are generally not compatible.

Wait 3 or more seconds after the USB memory device light stops indicating any activity before removing the USB memory device. Powering the 8846A down or removing the USB memory device prematurely can leave the USB memory device unreadable.

Configuring the Remote Interface

Selecting an interface port, setting up the ports, and selecting the command set the Meter will recognize is accomplished through the Instrument Setup key. For information on the commands that will remotely control the Meter, refer to the *Programmers Manual*.

Checking the Meter’s Calibration Date

To read the Meter’s calibration date:

1. Press 
2. Press the **CAL** soft key as shown below.

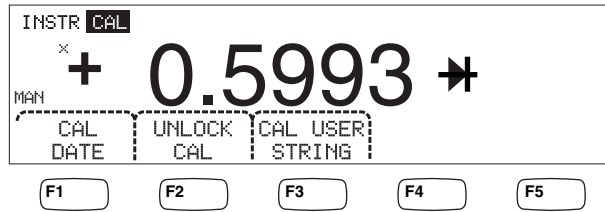

caw034.eps

3. Press the **CAL DATE** soft key to display the date the Meter was last calibrated.
4. Press **BACK** to go back to the previous menu.

Note

UNLOCK CAL allows entry of a password so authorized personnel can calibrate the Meter or change the (CAL) USER STRING.

Note

CAL USER STRING can be changed/entered after UNLOCK CAL. The string also appears on the top line/row of the stored readings files.

Resetting the Meter's Default Settings

To reset the Meter's default settings:

1. Press **INSTR SETUP** to see the instrument setup menu.
2. Press the **RESET** soft key to reset the Meter.

Note

Pressing the reset soft key will restore the Meter to the stored Power-up configuration if defined, otherwise it will reset to the Meter factory default settings.

Chapter 4

Making Measurements

Title	Page
Introduction.....	4-3
Selecting Function Modifiers.....	4-3
Activating the Secondary Display	4-3
Measuring Voltage.....	4-4
Measuring DC Voltage.....	4-4
Measuring AC Voltage.....	4-5
Measuring Frequency and Period	4-7
Measuring Resistance	4-7
Making a Two-wire Resistance Measurement	4-8
Making a Four-wire Resistance Measurement	4-8
Measuring Current	4-10
Measuring DC Current	4-11
Measuring AC Current	4-12
Measuring Capacitance (8846A only).....	4-13
Measuring RTD Temperature (8846A only)	4-14
Testing Continuity	4-15
Checking Diodes.....	4-16
Making a Triggered Measurement.....	4-17
Setting the Trigger Mode.....	4-17
Setting a Trigger Delay	4-17
Setting Number of Samples per Trigger.....	4-17
Connecting an External Trigger	4-18
Monitoring the Measurement-Complete Signal.....	4-18

Introduction

Warning

To avoid possible electrical shock, and/or damage to the Meter,

- Read the safety information found in Chapter 1 before operating this meter.
- Do not apply more than 1000 volts between any terminal and earth ground.

This chapter covers the steps for making a measurement with each of the Meter's functions. These steps include making a proper and safe connection between the Meter and the circuit, as well as the manipulation of the front-panel controls to display the selected measurement.

If you are unfamiliar with the front-panel controls, review the relevant sections in Chapter 3.

Selecting Function Modifiers

Most of the functions described in this Chapter will have choices for changing how the measured value is displayed or how the input signal is processed. These "Function Modifiers" appear in the bottom line of the display as soft key labels. The available selections are dependent on the selected function and are described in the Meter function descriptions provided in this Chapter.

Activating the Secondary Display

For most of the Meter's functions, an additional measured parameter may appear in the display. These additional parameters are available when **2ND MEAS** appears over one of the soft keys.

The secondary measurement may be another parameter of the primary signal (e.g., ac voltage and frequency of one signal), or a measurement of another signal made simultaneously with the primary signal (e.g., dc voltage and dc current).

The range of the secondary display is always automatically controlled.

To select a secondary measurement:

1. Press the soft key labeled **2ND MEAS**.

Each additional press of this soft key will cause the secondary display to cycle through the available measurements. After the last secondary measurement is shown, the next press of this soft key turns the secondary display off.

Note

When switching between Meter functions, the secondary display selection for the function you last selected is deactivated the next time that function is selected.

Measuring Voltage

The Meter is capable of measuring up to 1000 V dc, 750 V ac (8845A) or 1000 V ac (8846A).

⚠ Caution

To avoid blowing the current fuses and possible damage to other equipment, do not apply voltage to the meter's input until the test leads are properly connected to the input, and the proper voltage function selected.

Measuring DC Voltage

To make a dc voltage measurement:

1. Press **DCV**.

The dc voltage icon **V_{DC}** will appear to the right of the displayed value as shown below.

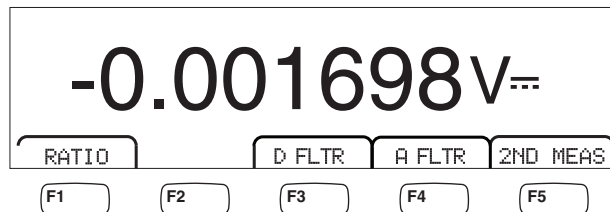

caw021.eps

2. Connect the test leads to the Meter's inputs as shown in Figure 4-1.
3. Connect the test leads to the circuit and read the measured voltage in the Meter's display.

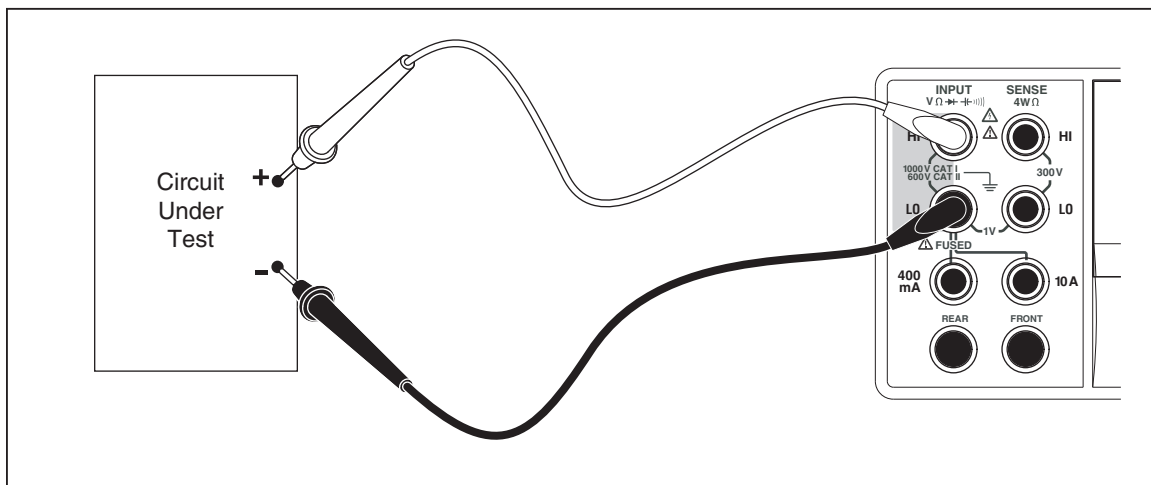

caw019.eps

Figure 4-1. Input Connections for Voltage, Resistance, and Frequency Measurements

Function modifiers:

- D FLTR** A filter for quieting noisy measurements. This filter averages readings to reduce reading noise when in immediate trigger mode or when in trigger mode with an unending number of triggers selected. The filter

is only available for dc functions at rates slower than 1 PLC. The number of readings averaged by the digital filter varies with dc function and range.

A FLTR A 3-pole analog filter for improving noise immunity. The filter is active when this soft key label is highlighted and will increase stabilization time of the measurement. See Appendix D for more information on when to use the analog filter.

Note

For best results, the filter may require zeroing the function when used.

RATIO DC measurement voltage divided by dc reference voltage. For dc ratio, connect the reference HI/LO to the Meter’s HI/LO sense terminals and the measurement voltage to the Meter’s HI/LO input terminals. Note the specified measurement range applies to the input terminals only.

Note

For best results in RATIO, the two input commons must be shorted at the Meter terminals. The analog filter (A FLTR) should be off.

2ND MEAS Cycles the secondary display through the measurement functions listed below, and then off. When a second measurement function is selected, the **2ND MEAS** soft key label is highlighted.

VAC - Displays the ac signal riding on the measured dc voltage.

Note

DCV/ACV dual mode should not be used at frequencies below 20 Hz.

See the “Range Keys” section in Chapter 1 to learn how to switch between auto and manual ranging.

Measuring AC Voltage

To make an ac voltage measurement:

1. Press **ACV**.

The ac voltage icon **V~** will appear in display as shown below.

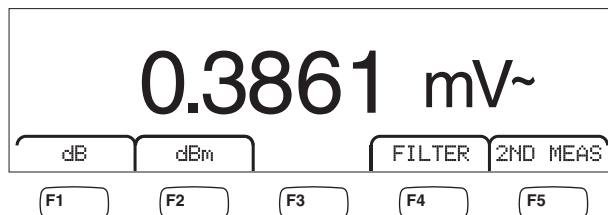

caw022.eps

2. Connect the test leads to the Meter’s input as shown in Figure 4-1.
3. Connect the test leads to the circuit and read the measured voltage in the Meter’s display.

Function modifiers:

- Filter** Displays the filter menu. For best accuracy and stable readings, choose a filter based on the lowest frequency to be measured and the performance needed.
- 3HZ SLOW** Provides higher measurement accuracy on ac signals between 3 Hz and 20 Hz. However, the measurement cycle time is longer than it is when using the 20 Hz filter.
- 20HZ** Provides higher measurement accuracy on ac signals between 20 Hz and 200 Hz. The measurement cycle time is longer, however, than it is when using the 200 Hz filter.
- 200HZ** Provides accurate measurements on ac signals 200 Hz and above.
- dB** Displays the measured voltage as a decibel value referenced to a stored relative value ($\text{dB} = 20 \log(V_{\text{new}}/V_{\text{stored}})$). The stored value is obtained from the first measurement the Meter makes after pressing the **dB** soft key. All future measurements are displayed using the stored value as an offset. To take the Meter out of dB mode, press the **dB** soft key.
- dBm** Displays the measured voltage as a power decibel value referenced to 1 milliwatt ($\text{dBm} = 10 \log(\text{power of } V_{\text{new}} \text{ into the reference resistance} / 1 \text{ mW})$ or $10 \log(V^2/R * 1 \text{ mW})$ where R is the resistance. To accommodate the various impedances that a dBm measurement can be made across, the Meter allows for the selection of 21 different impedance values.
- To set the dB reference impedance:
1. Press **MEAS SETUP**.
 2. Press the soft key labeled **dBm Ref**.
The available impedance settings are presented in sets of three values. To move to a higher set of impedance values, press **++ -->**. Press **<-- --** to go to a lower set of impedance values.
 3. With the impedance highlighted, press the soft key under the value selected.
- 2ND MEAS** Cycles the secondary display through the measurement functions listed below, and then off. When a second measurement function is selected, the **2ND MEAS** soft key label is highlighted.
- VDC** - Displays the dc voltage on which the ac signal may be riding.

Note

ACV/DCV dual mode should not be used at frequencies below 10 Hz.

Frequency - Displays the frequency of the ac signal applied to the **Input HI** and **LO** connectors of the Meter.

Measuring Frequency and Period

The Meter measures the frequency, or period of ac signals between 3 Hz and 1 MHz, applied between the Meter's HI and LO connectors.

The **FREQ PERIOD** key not only activates the Meter's Frequency/Period function, but also toggles the Meter's primary display between the signal's frequency and period measurement. Therefore, whether a frequency or period measurement appears after pressing **FREQ PERIOD** depends on the condition this function was left in the last time it was used.

To make a frequency measurement:

1. Press **FREQ PERIOD**.

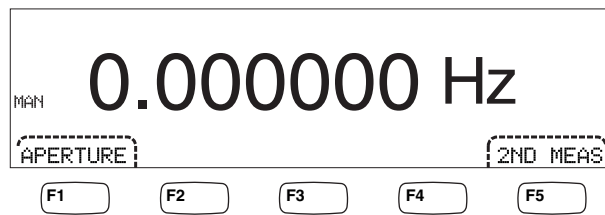

caw06f.eps

If **S** is displayed, press **FREQ PERIOD** again to switch the primary display to frequency.

2. Connect the Meter to the signal as shown in Figure 4-1.

To make a period measurement:

1. Press **FREQ PERIOD**.

If **HZ** is displayed, press **FREQ PERIOD** again to switch the primary display to period.

2. Connect the Meter to the signal as shown in Figure 4-1.

Note

Each press of **FREQ PERIOD** switches the measurement between frequency and period.

Function modifiers:

APERTURE Displays three different gate time selections: 0.01, 0.1 and 1 second. These selections set the minimum amount of time the Meter takes to measure frequency. Shorter gate times result in lower measurement resolution.

2ND MEAS Cycles the secondary display through the measurement functions listed below, and then off. When a second measurement function is selected, the **2ND MEAS** soft key label is highlighted.

Period – If a frequency measurement is in the primary display, the period of the signal appears in the secondary display when the **2ND MEAS** soft key is pressed.

Measuring Resistance

The Meter is capable of making two-wire and four-wire resistance measurements. Two-wire measurements are easy to set up, and will make accurate measurements in most applications. In a two-wire resistance measurement, both the source current and sensing is done through the **INPUT HI** and **LO** terminals. A four-wire resistance measurement

will source current through the **INPUT HI** and **LO** terminals and use the **SENSE HI** and **LO** to measure the resistance.

Making a Two-wire Resistance Measurement

To make a two-wire resistance measurement:

1. Connect the test leads to the Meter's input connectors as shown in Figure 4-1.
2. Press Ω .

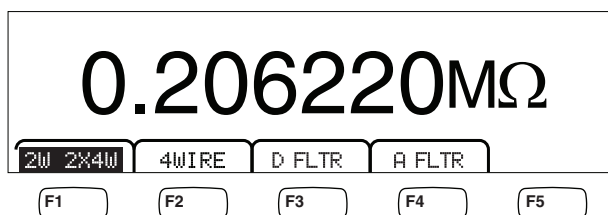

caw030.eps

3. If not already highlighted as shown above, press the **2W 2X4W** soft key.

Function modifiers:

- D FLTR** A filter for quieting noisy measurements. This filter averages readings to reduce reading noise when in immediate trigger mode or when in trigger mode with an unending number of triggers selected. The filter is only available for dc functions at rates slower than 1 PLC. The number of readings averaged by the digital filter varies with dc function and range.
- A FLTR** A 3-pole analog filter for improving noise immunity. The filter is active when this soft key label is highlighted and will increase stabilization time of the measurement. See Appendix D for more information on when to use the analog filter.

Note

For best results, the filter may require zeroing during the ohms function.

Refer to the "Range Keys" section in Chapter 3 of this manual for information on how to adjust the measurement range.

Making a Four-wire Resistance Measurement

The Meter incorporates two methods of making a four-wire resistance measurement. The traditional method is to use four meter leads to connect the Meter to the resistance to be measured. The optional 2X4 Wire test leads simplifies the four-wire measurement so you only have to plug in two test leads to the front-panel **Input HI** and **LO** connectors of the meter.

To make a four-wire resistance measurement using four test leads:

1. Connect the test leads to the Meter's input connectors as shown in Figure 4-2.
2. Press Ω .

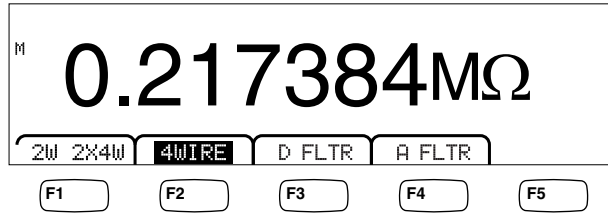

caw031.eps

3. If not already highlighted as shown above, press the **4WIRE** soft key to switch to a four-wire measurement.

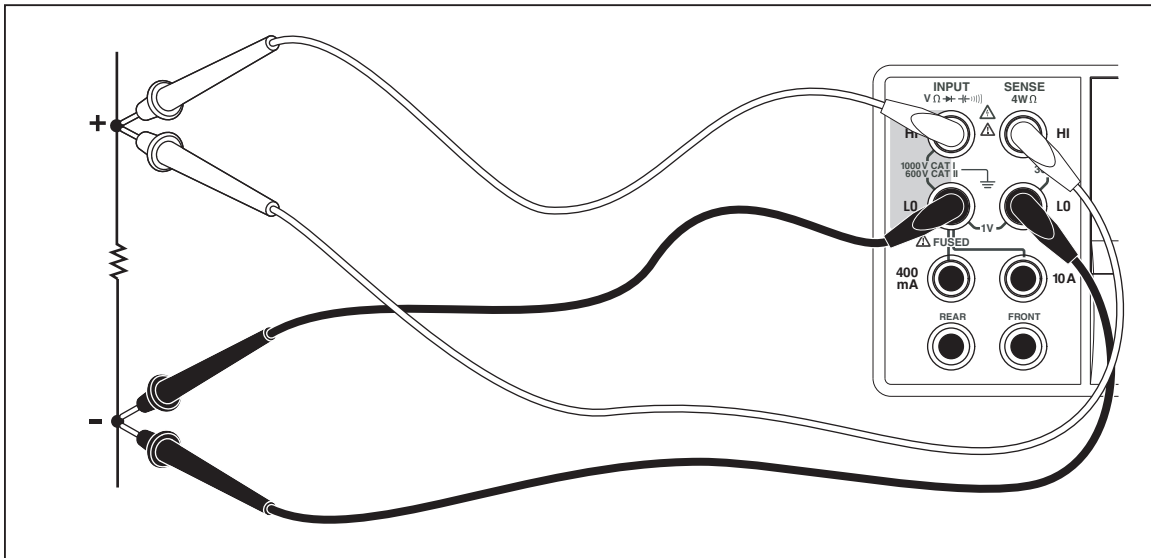

caw023.eps

Figure 4-2. Input Connections for 4-wire Resistance Measurements

To make a four-wire resistance measurement using Fluke’s 2X4 test leads:

1. Connect the test leads to the Meter’s input connectors as show in Figure 4-3.
2. Press Ω .
3. If not already highlighted, press the **2X4WIRE** soft key.

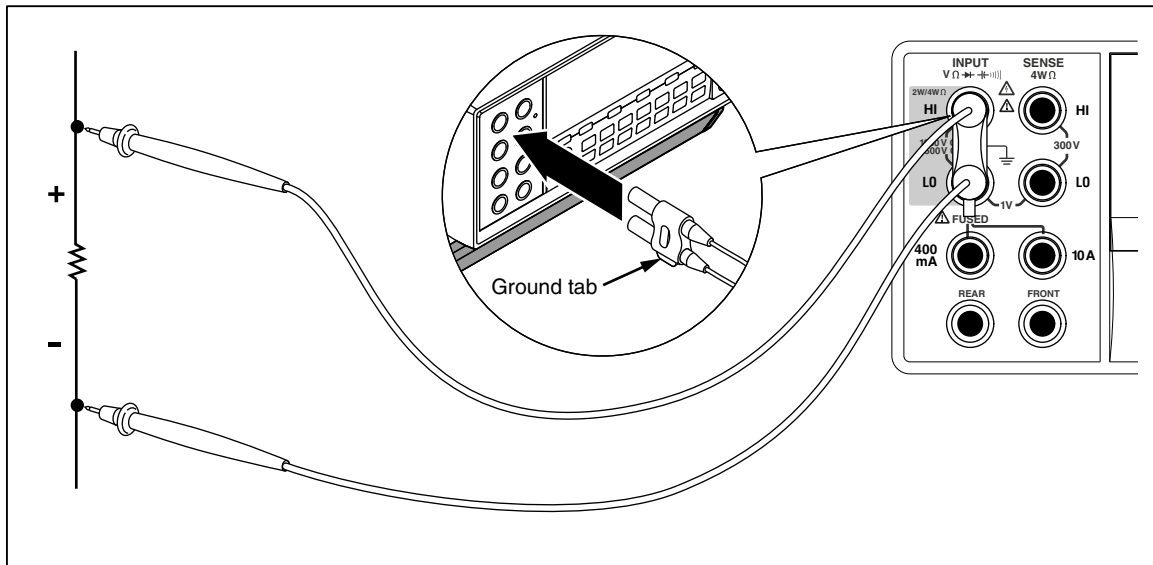

Figure 4-3. Input Connections for 4-wire Ohms Using 2x4 Wire Leads

caw060.eps

Function modifiers:

- D FLTR** A filter for quieting noisy measurements. This filter averages readings to reduce reading noise when in immediate trigger mode or when in trigger mode with an unending number of triggers selected. The filter is only available for dc functions at rates slower than 1 PLC. The number of readings averaged by the digital filter varies with dc function and range.
- A FLTR** A 3-pole analog filter for improving noise immunity. The filter is active when this soft key's label is highlighted.

Refer to the “Range Keys” section in Chapter 3 of this manual for information on how to adjust the measurement range.

Measuring Current

The Meter is capable of making both ac and dc current measurements up to 10 A. Two separate input connectors, in conjunction with the **LO** connector, are used for current measurements. For best resolution, current measurements not exceeding 400 mA should be made using the **LO** and **mA** input connectors as shown in Figure 4-4.

⚠ Caution

To avoid blowing the current input fuse or possibly damaging the Meter:

- **Current measurements between 400 mA and 10 A should be measured using only the 10 A and LO input connectors.**
- **BEFORE applying power to the circuit to be measured, ensure the test leads are correctly connected to the Meter inputs appropriate for the expected current.**
- **Exceeding 440 mA on the 400 mA input connector or exceeding 11 A on the 10 Amp connector will blow the internal fuse.**

Current measurements expecting to be between 400 mA and 10 A are made using the **Input LO** and **10A** input connectors as shown in Figure 4-5.

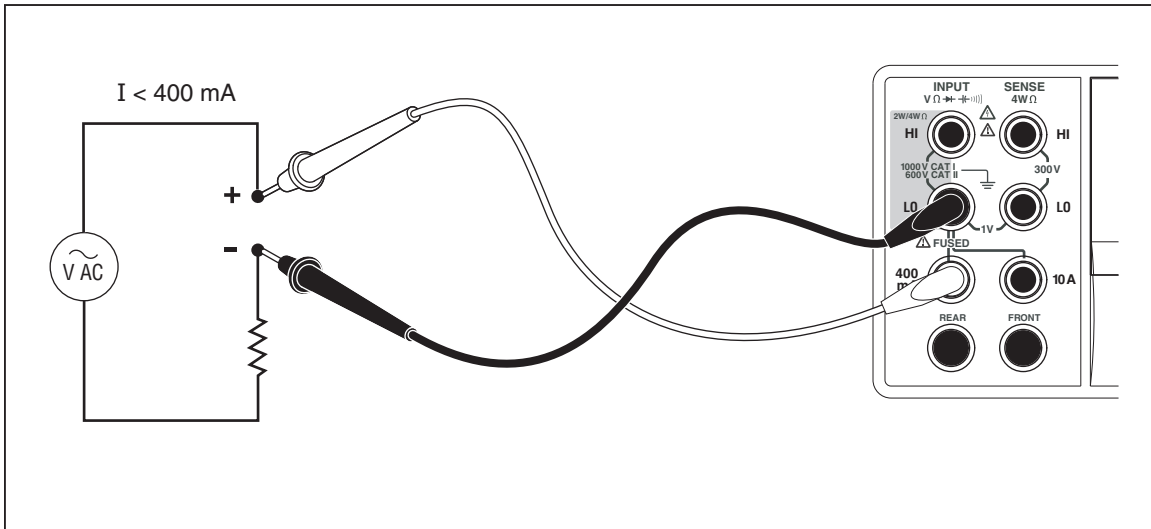

Figure 4-4. Input Connections for Current Measurements Below 400 mA

caw025.eps

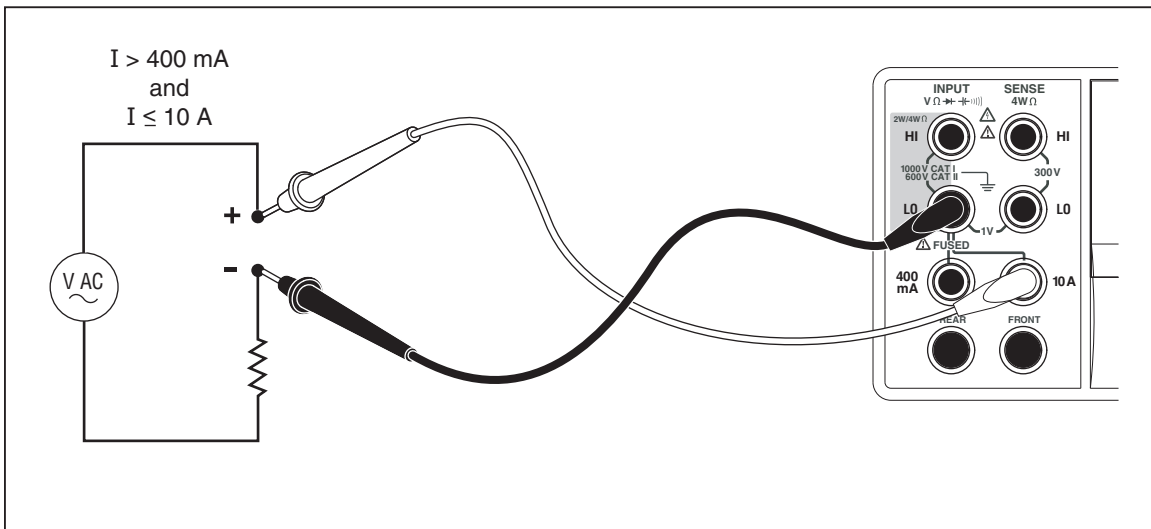

Figure 4-5. Input Connections for Current Measurements Above 400 mA

caw026.eps

Refer to the “Range Keys” section in Chapter 3 of this manual for information on how to adjust the measurement range.

Measuring DC Current

To measure dc current:

1. Connect the test leads between the Meter’s input connectors and the measured circuit as shown in Figure 4-4 for currents 400 mA or less or Figure 4-5 for currents up to 10 amps.
2. Press .

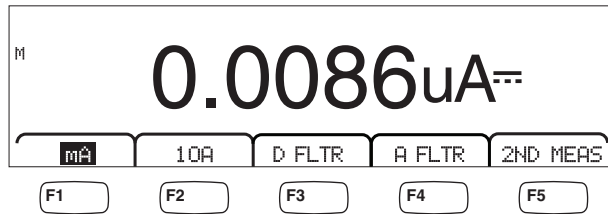

caw09f.eps

- With the test leads connected to the **400 mA** and **Input LO** connectors, press the **mA** soft key as shown above, if not already highlighted. If the test leads are connected to the **10A** and **Input LO** connectors, then press the **10A** soft key.
- Apply power to the measured circuit and read the current in the Meter's display.

Function modifiers:

- D FLTR** A filter for quieting noisy measurements. This filter averages readings to reduce reading noise when in immediate trigger mode or when in trigger mode with an unending number of triggers selected. The filter is only available for dc functions at rates slower than 1 PLC. The number of readings averaged by the digital filter varies with dc function and range.
- A FLTR** A 3-pole analog filter for improving noise immunity. The filter is active when this soft key label is highlighted and will increase stabilization time of the measurement. See Appendix D for more information on when to use the analog filter.

Note

For best results, the filter may require zeroing during the current function.

- 2ND MEAS** Cycles the secondary display through the measurement functions listed below, and then off. When a second measurement function is selected, the **2ND MEAS** soft key label is highlighted.

ACI - Displays the ac current riding on the dc current measurement.

DCI/DCV – Displays the dc current and dc voltage present on the input. To measure the voltage and current of an input signal requires three leads. The voltage and current measurement must share the same common lead. The resistance of the common lead combines with a small amount of internal resistance in the meter to cause an IR drop that affects the accuracy of the voltage measurement. Depending on the circumstance, this effect can be substantial. As an example, 20 mΩ of lead resistance can cause more than 20 mV of additional error at 1 A.

Note

Measurement of ac signals below 20 Hz is not recommended in DCI/ACI dual mode. Use the ACI function for this measurement.

Measuring AC Current

To measure ac current:

- Connect the test leads between the Meter's input connectors and the measured circuit as shown in Figure 4-4 or Figure 4-5, based on the anticipated level of current.

- Press .

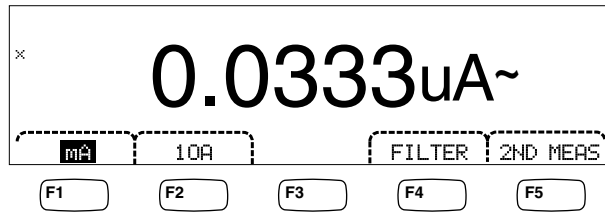

caw08f.eps

- With the test leads connected to the **400 mA** and **Input LO** connectors, press the **mA** soft key as shown above, if not already highlighted. If the test leads are connected to the **10A** and **Input LO** connectors, then press the **10A** soft key.
- Apply power to the measured circuit and read the current in the Meter's display.

Function modifiers:

- Filter** Displays the filter menu. For best accuracy and stable readings, choose a filter based on the lowest frequency to be measured and the accuracy needed.
- 3HZ SLOW** Provides higher measurement accuracy on ac signals between 3 Hz and 20 Hz. However, the measurement cycle time is longer than it is when using the 20 Hz filter.
 - 20HZ** Provides higher measurement accuracy on ac signals between 20 Hz and 200 Hz. However, the measurement cycle time is longer than it is when using the 200 Hz filter.
 - 200HZ** Provides accurate measurements on ac signals 200 Hz and above.
- 2ND MEAS** Cycles the secondary display through the measurement functions listed below, and then off. When a second measurement function is selected, the **2ND MEAS** soft key label is highlighted.
- IDC** - Displays the dc current the ac signal is riding on.
 - Frequency** - Displays the frequency of the ac signal on the Meter's current connectors (**Input Lo** and **400 ma** or **10A**) connectors.

Measuring Capacitance (8846A only)

The Fluke 8846A is capable of measuring capacitance from 1 pF to 100 mF (0.1 F).

To make a capacitance measurement:

- Press . An example of the capacitance display is shown below.



caw10f.eps

2. With the leads open, press **ZERO**.
3. Connect the Meter's test leads as shown in Figure 4-6.

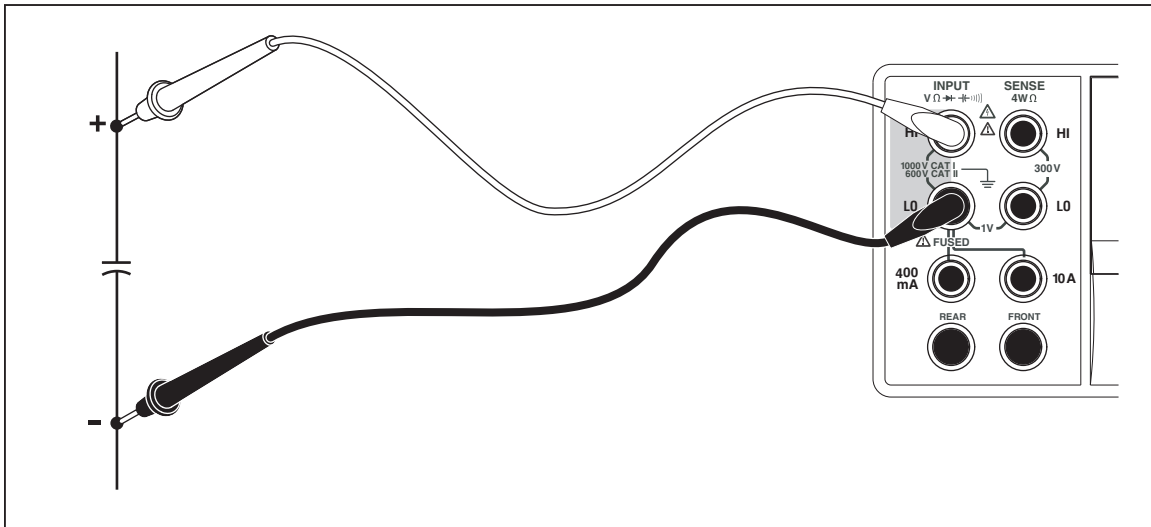

Figure 4-6. Measuring Capacitance

caw027.eps

Refer to the “Range Keys” section in Chapter 3 of this manual for information on how to adjust the measurement range.

Measuring RTD Temperature (8846A only)

The Fluke 8846A is capable of measuring temperatures between -200 °C and 600 °C using Resistance Temperature Detectors (RTDs).

To make a temperature measurement:

1. Connect the RTD to the **Input HI**, and **LO**, then the **SENSE HI** and **LO** connectors as shown in Figure 4-7.

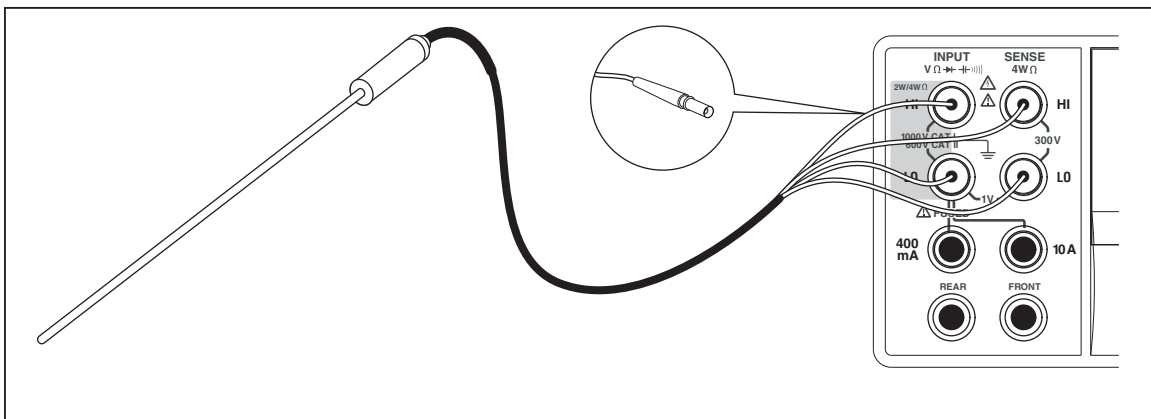
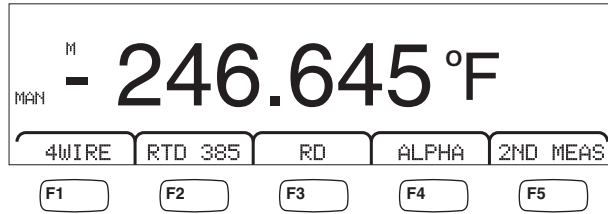

Figure 4-7. Temperature Measurements

caw028.eps

2. Press **TEMP** to display the measured temperature as shown below.



caw11f.eps

To change the temperature scale, refer to the “Setting the Default Temperature Scale” section in Chapter 3 of this manual. Available scales are Celsius, Fahrenheit, and Kelvin.

Refer to the “Adjusting the Meter’s Range” section in Chapter 3 of this manual for information on how to adjust the measurement range.



Function modifiers:

- 4Wire** Switches the measurement input connectors to 4-wire measurement for 4-wire RTDs. 4-wire RTDs make more accurate measurements.
- RTD 385** Default RTD type. All coefficients are predefined.
- RD** Used to select a different value of RTD resistance at 0 °C.
- ALPHA** Used to set the first coefficient of the Calendar-Van Dusen equation.
- 2ND MEAS** Cycles the secondary display through the measurement functions listed below and then off.
OHMS - Displays the resistance of the RTD. 2-wire resistance is used when in 2-wire temperature mode and 4-wire resistance when the Meter is in 4-wire RTD mode.

Testing Continuity

Continuity testing determines whether a circuit is intact (i.e., has a resistance less than the threshold). The threshold is selectable between 1 and 1000 Ω.

To perform a continuity test:

1. Press  on the 8846A or  on the 8845A. An example of the continuity display is shown below.



caw12f.eps

Connect the test leads as shown in Figure 4-1.

Note

The Beeper cannot be disabled in continuity. Pressing BEEPER OFF turns off the beeper for errors.

To set the threshold value, refer to the “Setting the Continuity Threshold Resistance” section in Chapter 3 of this manual.

Function modifiers:



None

Checking Diodes

The diode function sends a current through a semiconductor junction while the Meter measures the voltage drop across the junction (or junctions). Measurements are displayed in the 10 V range at a relatively fast measurement rate. "OPEN" is displayed for voltages 10 % above the compliance voltage setting. Typical junction voltage drop on good junctions are 0.3 to 0.8 volts. If enabled, the beeper will make a short beep when a good junction is detected. Shorted diodes will indicate a significantly lower voltage.

With the higher compliance voltage (up to 10 V), the Meter's diode test function can test zeners up to 10 volts, diode stacks and LEDs. The selectable current and maximum voltage allows you to tailor the diode test to the expected voltage for the junction being tested.

To check a diode:

1. Press  twice on the 8846A or  once on the 8845A. An example of the diode test display is shown below.

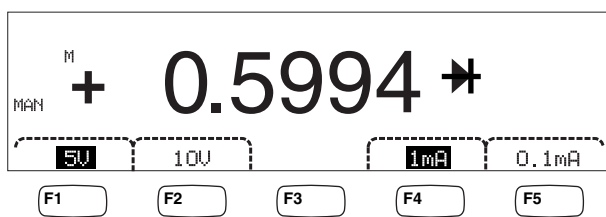

caw13f.eps

2. Select the test voltage and current appropriate for the diode being tested by pressing the associated soft keys.
3. Connect the test leads as shown in Figure 4-8.

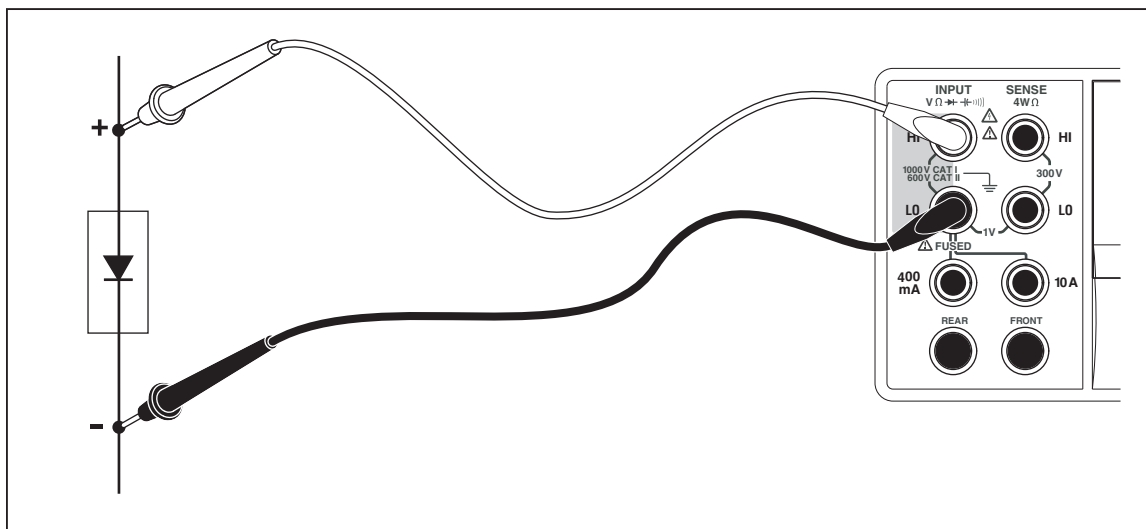

caw024.eps

Figure 4-8. Diode Testing Connections

Function modifiers:

None

Four soft keys allow changing the test voltage and current applied to the diode through the test leads. The compliance voltage is set to either 5 volts or 10 volts. The compliance current is set to either 1 mA or 0.1 mA. Press the appropriate soft key to select the desired voltage and current setting.

Making a Triggered Measurement

Triggering the Meter's measurement cycle is set through the trigger menu and performed via a connection on the Meter's rear panel or the front panel trigger key. The trigger menu also allows setting a trigger delay and setting the number of samples or measurement cycles taken for each trigger received. All trigger function parameters are accessed through the measurement setup key.

Press **MEAS SETUP** to see the measurement setup menu.

A measurement trigger can also be initiated through the IEEE 488 port with a remote command. This method of triggering is covered in the *8845A/8846A Programmers Manual*.

Setting the Trigger Mode

The Meter's measurement cycle can be initiated either by the internal measurement circuit or by external stimulus.

To select the trigger mode:

1. With the measurement setup menu displayed, press the soft key labeled **TRIGGER**.
 If **EXT TRIG** is highlighted, the Meter's measurement cycle is triggered externally either through the external trigger jack on the rear panel, or the trigger key on the front panel. If **EXT TRIG** is not highlighted, then the Meter's measurement cycle is triggered automatically by its internal circuitry.
2. Press the soft key labeled **EXT TRIG** to toggle between internal and external triggering.

Setting a Trigger Delay

When in external trigger mode, the Meter is capable of delaying the start of the measurement cycle after the trigger stimulus is sensed by up to 3600 seconds.

To set a trigger delay:

1. With the measurement setup menu displayed, press the soft key labeled **TRIGGER**.
2. Press the soft key labeled **TRIG DELAY**.
3. Use the soft keys to set the trigger delay.

Select the digit in the value by pressing either **<--** or **-->**.

With the desired digit selected, press the soft key labeled **--** to decrement the digit or **++** to increment the character.

4. Press **ENTER**.

Setting Number of Samples per Trigger

When in external trigger mode, the Meter will take between 1 and 50,000 measurements for each trigger received.

To set the number of samples, or measurements the Meter will take for each external trigger received:

1. Press **MEAS SETUP** to display the measurement setup menu.
2. Press the **TRIGGER** soft key.
3. Press the soft key labeled **#SAMPLES**.
4. Use the soft keys to set the number of samples between 1 and 50,000.
Select the digit in the value by pressing either **<--** or **-->**.
With the digit selected, press the soft key labeled **--** to decrement the digit or **++** to increment the character.
5. Press **ENTER**.

Connecting an External Trigger

The TRIG I/O jack on the Meter's rear panel is used to connect to an external trigger signal. The falling edge of a TTL signal will trigger the Meter to start taking measurements, if the Meter is in external trigger mode.

Figure 4-9 indicates the purpose of the three pins in the TRIG I/O connector.

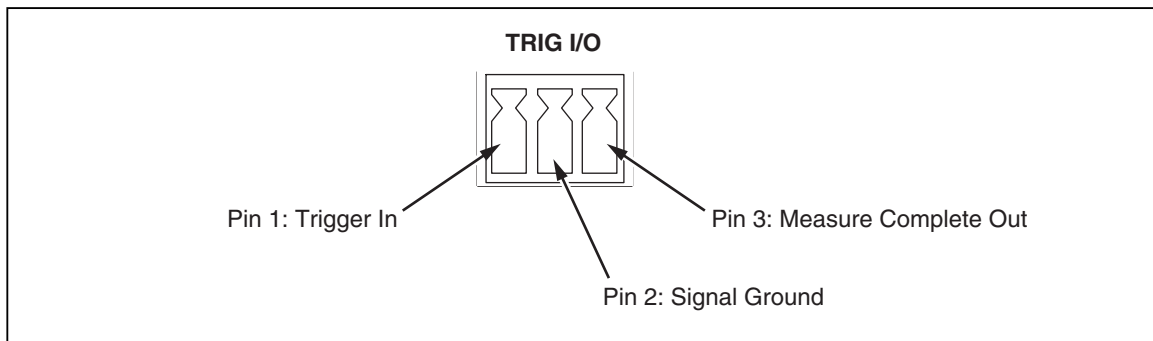

Figure 4-9. TRIG I/O Pin-out Description

caw059.eps

Monitoring the Measurement-Complete Signal

In addition to being a trigger input, the TRIG I/O jack on the Meter's rear panel also provides a signal indicating the completion of a measurement cycle. A falling edge of a TTL signal indicates a measurement cycle is complete. See Figure 4-9 above to identify which pins on the TRIG I/O connector are used to sense the measurement-complete signal.

Appendices

Appendix	Title	Page
A	2X4 Test Leads	A-1
B	Errors.....	B-1
C	RS-232 Port Connections.....	C-1
D	Analog Filter Applications.....	D-1

Appendix A 2X4 Test Leads

Introduction

The optional Fluke TL2X4W test leads simplify making 4-wire ohms measurements by integrating the HI+HI Sense and LO+LO Sense test leads into one cable. The Meter's **Input HI** and **LO** jacks consist of two contacts. One contact is connected to HI or LO input circuits and the other contact is connected to the Sense input circuits. Like the input jacks, the 2x4 test lead also has two contacts that align with the input jack contacts to provide a four wire connection.

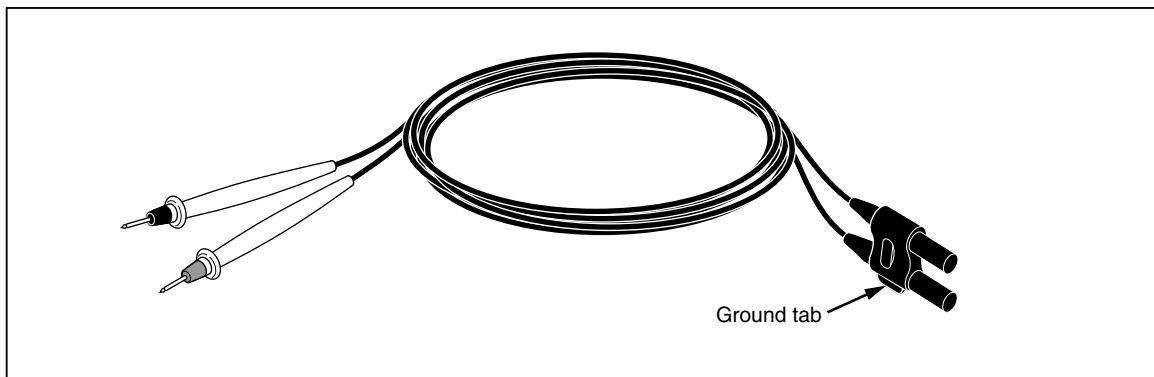

Figure A-1. 2X4 Wire Test Leads

caw061.eps

⚠ ⚠ Warning

To avoid electric shock and possible damage to the Meter, use the 2X4 Wire test leads as specified in the instruction sheet that comes with the probes. Inspect the test leads before use. Do not use them if insulation is damaged or metal is exposed. Check the test leads for continuity. Replace damaged test leads before using the Meter.

Appendix B

Errors

Introduction

Listed below are the error messages the Meter uses to indicate a problem.

- AC Line frequency too high
- Invalid calibration step number
- *TRG/GET received but was ignored
- 488.2 I/O deadlock
- 488.2 interrupted query
- 488.2 query after indefinite response
- 488.2 unterminated command
- A fatal error occurred configuring the serial port
- A fatal error occurred opening the serial port
- AC Line frequency too low
- Acknowledgement queue full
- ACPOLE: all CAPDAC settings are too high
- ACPOLE: all CAPDAC settings are too low
- ACPOLE: no CAPDAC setting is close enough
- Bad CRC
- Bad keyword
- Bad parameter value
- Cal reference value out of tolerance
- Cal secured
- CAL? only works if you are calibrating
- Calibration Aborted
- Calibration measurements out of tolerance
- Calibration steps out of sequence

CALibration:DATE not supported for the 8846A
Can't get 1V/10V DC linearization constants
CCO constant name is bad
Character string was more than 12 characters
Command not allowed in local
Command only allowed in RS-232/Ethernet
Could not open guard crossing port
Could not open measurement file on USB device
Could not open the ethernet port
Could not save configuration
Could not save MAC address
Could not save network configuration
Data stale
Error occurred reading characters from Ethernet port
Error occurred reading characters from GPIB controller
Error occurred sending characters to the GPIB controller
Error occurred when purging memory
Error opening GPIB Controller
Error setting GPIB Primary Address
Error setting the RTC/System date
Error setting the RTC/System time
Ethernet port not available in Fluke 45 emulation mode
Function/2nd func mismatch
Function/math mismatch
Function/range mismatch
Generic Execution Error
Got out of sequence packet
GPIB Command byte transfer error
GPIB DOS Error
GPIB File System Error
GPIB I/O operation aborted (time-out)
GPIB Interface Board has not been addressed properly
GPIB Invalid argument
GPIB No capability for operation
GPIB No present listening devices
GPIB Non-existent GPIB board
GPIB Routine not allowed during asynchronous I/O operation
GPIB Serial poll status byte lost
GPIB Specified GPIB Interface Board is Not Active Controller
GPIB Specified GPIB Interface Board is not System Controller
GPIB SRQ stuck in ON position
GPIB Table problem
Guard crossing link failed to start
Guard crossing restarted
Illegal Data value was entered
Illegal/Unknown NPLC Selection
Illegal/Unknown TRIGGER Selection

Incorrect packet size from inguard
 Info packet rec'd; link not active
 Inguard Calibration Constant write failed
 Inguard not responding (recv)
 Inguard not responding (send)
 INITiate received but was ignored
 Instrument configuration load failed
 Instrument configuration store failed
 Insufficient memory
 Invalid dimensions in a channel list
 Invalid parameter
 Invalid parameter
 Invalid response type from inguard
 Invalid secure code
 Invalid string data
 Invalid suffix in command header
 Line too long (greater than 350 characters)
 Load reading from file failed
 Lost sync with inguard
 Math error during calibration
 Measurement configuration load failed
 Measurement configuration store failed
 Measurement data lost
 Missing or wrong number of parameters
 No entry in list to retrieve
 No error
 No measurements taken during calibration
 Not ACKing my packets
 Numeric value is invalid
 Numeric value is negative
 Numeric value is real
 Numeric value overflowed its storage
 Overload at input during calibration
 Oversize packet rec'd
 Parameter is not a boolean type
 Parameter is not a character type
 Parameter is not a numeric type
 Parameter is not an quoted string type
 Parameter is not an unquoted string type
 Parameter type detection error
 Port value is out of range (1024 to 65535)
 Present function is invalid for selected command
 Quality indicator too low
 RS-232 framing/parity/overrun error detected
 Secondary function is not enabled
 Secure code too long
 Self Test Failed

Serial buffer full
Someone forgot to call begin (cal)
Someone forgot to call begin (ICONF)
Someone forgot to call begin (MCONF)
Store reading to file failed
String size is beyond limit
Suffix Error. Wrong units for parameter
Syntax error
Time out while taking data
Timeout error during calibration
Timeout occurred while opening the ethernet port
Too many dimensions to be returned
Too many errors
Tried to set invalid state
Tried to set invalid state
Trigger Deadlock
Trigger ignored (just like 34401)
Unable to access storage memory
Unknown ACK byte
Unknown Calibration Constant
Unknown control byte
Unknown error %d
Unknown Function Selection
Unknown Range Selection
Unmatched bracket
Wizard password is invalid
Wrong ACK number
Wrong number configuration acknowledgement
Wrong type of parameter(s)

Appendix C

RS-232 Port Connections

Introduction

Table C-1 lists the pins and related signals available through the RS-232 port.

Table C-1. RS-232 Pin to Signal List

Pin	Name	Usage
1	DCD	Not used
2	RX	Receive data
3	TX	Transmit data
4	DTR	Not used
5	GND	Signal ground
6	DSR	Not used
7	RTS	Request to send
8	CTS	Clear to send
9	RI	Not used

The Meter's RS-232 control lines can be rewired to an alternate pairing instead of the RTS/CTS control pair. This alteration should be done by a trained technician at Fluke service center. Opening the cover of the Meter to make this alteration may void the Meter's warranty.

Appendix D

Analog Filter Applications

Introduction

The Meter's analog filter is intended to reduce the presence of external ac when making dc measurements. Most applications do not require the use of this filter, but in some situations it can be utilized to improve DC measurements. A good example of this is using the filter when measuring the DC value of a signal with AC content, such as a DC power supply voltage that has significant AC line ripple present.

The analog filter is not intended to reduce the internal noise within the DMM, and usually has no affect in reducing noise when measuring an open circuit in DCI, measuring a short circuit in DCV or Resistance, or measuring the output of a precision DC calibrator. In fact, the analog filter may actually add to the noise in these situations, and often times offsets the reading. Because of the latter phenomena, when the analog filter is used, the DMM must first be Zeroed in the range, NPLC setting, and triggering approach used. If your application makes it difficult to first ZERO the instrument, the offset can be characterized, and the typical errors are shown in Tables D-1 through D-3 can be used. For those ranges and NPLCs not shown, there are usually no additional errors associated with using the analog filter.

Table D-1. DC Volts Analog Filter Errors

Range	NPLC	Additional Analog Filter Error
100 mVdc	1, 10	1.5 μ V
	0.2	12 μ V
	0.02	40 μ V
100 Vdc	10, 100	0.0002 V
	<10	0.001 V

Table D-2. Ohms Analog Filter Errors

Range	NPLC	Additional Analog Filter Error
10 Ω	10, 100	0.5 m Ω
	<10	1.9 m Ω
100 Ω	10, 100	1.5 m Ω
	<10	9.0 m Ω
100 k Ω	10, 100	0.6 Ω
	<10	2.5 Ω

Table D-3. DC Current Analog Filter Errors

Range	NPLC	Additional Analog Filter Error
100 μ A, 10 mA, 1 A	100	0.005 % of range
	10	0.015 % of range
	1	0.027 % of range
	0.2	0.09 % of range
	0.02	0.27 % of range
1 mA, 100 mA, 10 A ^[1]	10	0.001 % of range
	1	0.0025 % of range
	0.2	0.009 % of range
	0.02	0.026 % of range

[1] 3 A range uses the 10 A range errors.

Index

—A—

- AC Voltage
 - Measurements, 4-5
- Analyze functions
 - Histogram, 3-15
 - Math
 - Limits testing, 3-12
 - MX+B, 3-13
 - Offset, 3-13
 - Statistics, 3-11
 - TrendPlot, 3-14

—B—

- Bail
 - adjustment of, 2-8
 - removal of, 2-8

—C—

- Calibration date
 - checking of, 3-25
- Capacitance measurements, 4-13
- Cleaning the Meter, 2-9
- Clock
 - setting date and time, 3-24
- Configurations
 - recalling, 3-22
 - storing, 3-20
- Configure for Measurements, 3-8
- Continuity
 - Setting of threshold, 3-10
 - Testing for, 4-15
- Current measurements
 - AC, 4-12
 - DC, 4-11

—D—

- Date, setting of, 3-24

- DC Voltage
 - Measurements, 4-4
- Defaults, resetting of, 3-27
- Diode Test
 - checking of, 4-16
 - setting compliance voltage, 3-10
 - setting of current, 3-10
- Display
 - Brightness, setting of, 3-24
 - Panel elements, 3-5
 - Resolution, Setting of, 3-9

—E—

- Equipment rack mounting, 2-8
- Errors
 - List of, B-1
 - Reading, 3-23

—F—

- Filter
 - AC, 3-9
 - DC
 - DC Current, 4-12
 - DC Voltage, 4-4, 4-8, 4-10, 4-12
 - Resistance, 4-8
- Firmware
 - checking revision, 3-24
- Fluke
 - contacting of, 2-3
- Frequency measurements, 4-7
- Front Panel, 3-4
- Front Panel Navigation, 3-8
- Function modifiers, 4-3
- Fuses
 - Current input, 2-5
 - Line-Power, 2-4

—H—

Histogram, 3-15

—I—

Input Impedance, Automatic, 3-10

Inspecting Meter, 2-3

—K—

Keys

Range, 3-8

Soft, 3-4

Soft, labels for, 3-6

—L—

Limits Testing

setting of limits, 3-12

Using, 3-12

Line Voltage Selection, 2-4

—M—

Manual set, 1-3

Math functions

Limits testing, 3-12

MX+B, 3-13

Offset, 3-13

Math Operations, 3-11

Measurement Complete

Monitoring of, 4-18

Understanding of, 3-18

Measurements

AC current, 4-12

AC Voltage, 4-5

Capacitance, 4-13

Current, 4-10

DC current, 4-11

DC Voltage, 4-4

Frequency, 4-7

Period, 4-7

Resistance, 4-7

2-wire, 4-8

4-wire, 4-8

Temperature, 4-14

Voltage, 4-4

Memory

Configuration

Recall, 3-22

Storing, 3-20

management of, 3-22

Reading recall, 3-20

Reading storage, 3-18

Memory, Access to, 3-18

Meter errors

Reading, 3-23

MX+B function, 3-13

—O—

Offset, setting of, 3-13

Options and Accessories, 1-7

—P—

Period measurements, 4-7

Product Description, 1-3

—R—

Range Key, 3-8

Readings

recalling, 3-20

storing, 3-18

Rear panel, 3-7

Recalling configurations, 3-22

Recalling readings, 3-20

Resistance measurements

2-wire, 4-8

4-wire, 4-8

Resistance Measurements, 4-7

RTD Temperature measurements, 4-14

—S—

Safety Information, 1-4

Secondary display

activation of, 4-3

Shipping Meter, 2-3

Specifications, 1-9

Statistics

taking of, 3-11

Storing configurations, 3-20

Storing Meter, 2-3

Storing readings, 3-18

Symbols, 1-6

—T—

Temperature

setting default scale, 3-10

Temperature measurements, 4-14

Time, setting of, 3-24

TrendPlot, 3-14

Trigger functions, 3-16

Trigger sources, 3-16

Triggering

Auto, 3-17

Choosing a source, 3-16

External, 3-17

I/O jack, 4-18

setting a delay, 4-17

Setting a delay, 3-17

Setting number of samples, 3-18

Setting the mode, 4-17

Triggered Measurement, 4-17

Turning power on, 2-8

—U—

Unpacking Meter, 2-3
User documentation, 1-3

—V—

Voltage
AC measurements, 4-5
DC measurements, 4-4

This page is for holding the Reference Document (RD) fields. Do not remove from this master document.
All RD fields will be placed after this text.