



VT1521

4-CH HIGH-SPEED DYNAMIC BRIDGE SIGNAL CONDITIONING PLUG-ON

USER'S MANUAL

P/N: 82-0108-000
Rev: January 11, 2007

VXI Technology, Inc.

2031 Main Street
Irvine, CA 92614-6509
(949) 955-1894



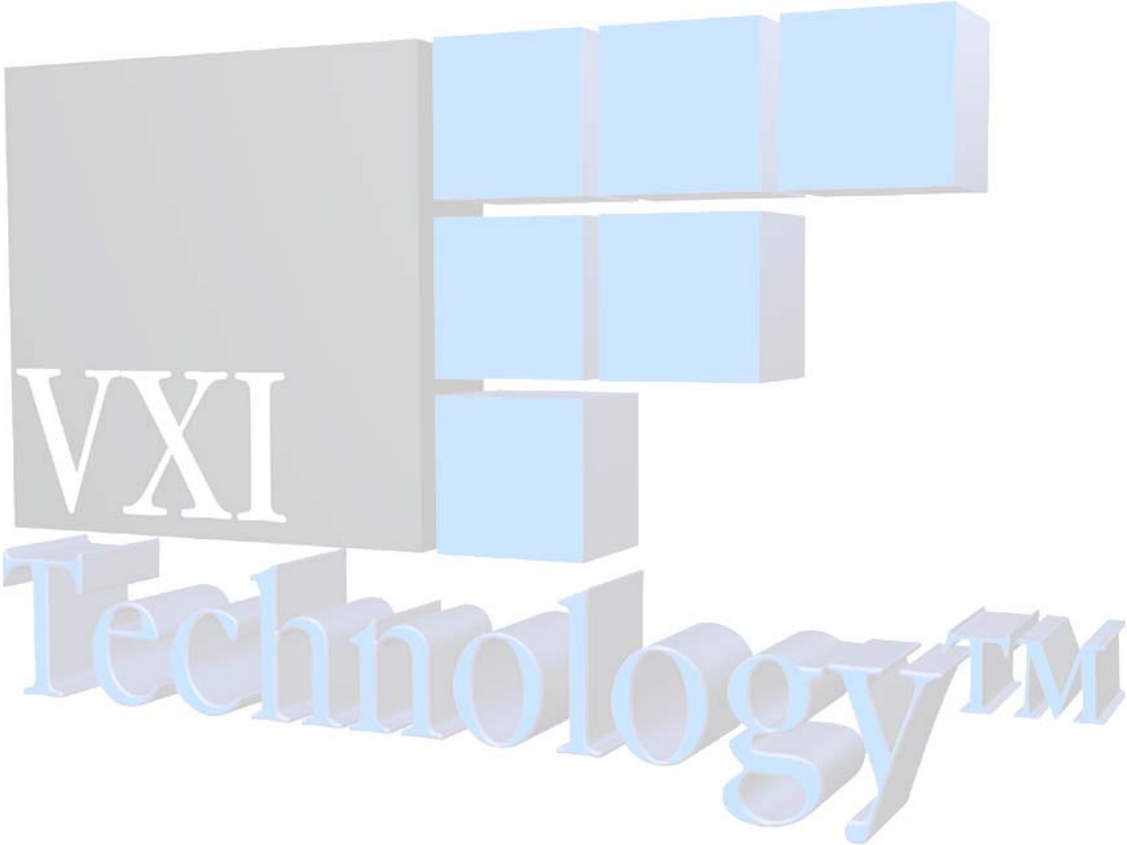

TABLE OF CONTENTS

INTRODUCTION

Certification	5
Warranty	5
Limitation of Warranty	5
Restricted Rights Legend	5
DECLARATION OF CONFORMITY	6
GENERAL SAFETY INSTRUCTIONS	7
Terms and Symbols	7
Warnings	7
SECTION 1.....	11
INTRODUCTION	11
Overview	11
VT1521-TFB Terminal Block	11
About this Manual	11
Specifications	13
SECTION 2.....	21
OPERATION	21
Operation	21
Channels	22
SECTION 3.....	23
PROGRAMMING	23
Programming with API Commands	23
Commands Used	23
PROGRAMMING EXAMPLES	24
Checking the ID of the SCP	24
Making Quarter-Bridge Measurements	25
Making Full-Bending Poisson Bridge Measurements	27
Explanation of Commands Used	29
Purpose of the Initialize Command (vt1413_init)	29
Purpose of the Get SCP Description Command (vt1413_get_scp_description)	29
Purpose of the Close Command (vt1413_close)	29
Purpose of the Error Message Command (vt1413_error_message)	30
Purpose of the Channel Set Voltage Command (vt1413_channel_set_voltage)	30
Connecting Input (vt1413_channel_set_low_input)	30
Purpose of the Set Filter Frequency Command (vt1413_channel_set_filter_freq)	30
Purpose of the Set Channel Gain Command (vt1413_channel_set_gain)	31
Purpose of the Strain Gage Factor Command (vt1413_set_strain_gauge_factor)	31
Purpose of the Quick Measure Strain Command (vt1413_quick_measure_strain)	31
The Purpose of the Shunt Enable Command (vt1413_channel_set_enable)	32
Using External Excitation Voltages	32
Connecting the External Supply	33
Enter Excitation Voltage Value (vt1413_set_strain_excitation)	33
Register-Based Programming	34
Checking the ID of the SCP	34
Setting the Filter Cutoff Frequency	35
Setting the Channel Gain	35
Setting the Excitation, Wagner Voltage, and Shunt Cal Resistor	35
Adjusting the Excitation DACs	36

CERTIFICATION

VXI Technology, Inc. (VTI) certifies that this product met its published specifications at the time of shipment from the factory. VTI further certifies that its calibration measurements are traceable to the United States National Institute of Standards and Technology (formerly National Bureau of Standards), to the extent allowed by that organization's calibration facility, and to the calibration facilities of other International Standards Organization members.

WARRANTY

The product referred to herein is warranted against defects in material and workmanship for a period of three years from the receipt date of the product at customer's facility. The sole and exclusive remedy for breach of any warranty concerning these goods shall be repair or replacement of defective parts, or a refund of the purchase price, to be determined at the option of VTI.

For warranty service or repair, this product must be returned to a VXI Technology authorized service center. The product shall be shipped prepaid to VTI and VTI shall prepay all returns of the product to the buyer. However, the buyer shall pay all shipping charges, duties, and taxes for products returned to VTI from another country.

VTI warrants that its software and firmware designated by VTI for use with a product will execute its programming when properly installed on that product. VTI does not however warrant that the operation of the product, or software, or firmware will be uninterrupted or error free.

LIMITATION OF WARRANTY

The warranty shall not apply to defects resulting from improper or inadequate maintenance by the buyer, buyer-supplied products or interfacing, unauthorized modification or misuse, operation outside the environmental specifications for the product, or improper site preparation or maintenance.

VXI Technology, Inc. shall not be liable for injury to property other than the goods themselves. Other than the limited warranty stated above, VXI Technology, Inc. makes no other warranties, express or implied, with respect to the quality of product beyond the description of the goods on the face of the contract. VTI specifically disclaims the implied warranties of merchantability and fitness for a particular purpose.

RESTRICTED RIGHTS LEGEND

Use, duplication, or disclosure by the Government is subject to restrictions as set forth in subdivision (b)(3)(ii) of the Rights in Technical Data and Computer Software clause in DFARS 252.227-7013.

VXI Technology, Inc.
2031 Main Street
Irvine, CA 92614-6509 U.S.A.

DECLARATION OF CONFORMITY
Declaration of Conformity According to ISO/IEC Guide 22 and EN 45014

MANUFACTURER'S NAME	VXI Technology, Inc.
MANUFACTURER'S ADDRESS	2031 Main Street Irvine, California 92614-6509
PRODUCT NAME	4-ch High-Speed Dynamic Bridge
MODEL NUMBER(S)	VT1521
PRODUCT OPTIONS	All
PRODUCT CONFIGURATIONS	All

VXI Technology, Inc. declares that the aforementioned product conforms to the requirements of the Low Voltage Directive 73/23/EEC and the EMC Directive 89/366/EEC (inclusive 93/68/EEC) and carries the "CE" mark accordingly. The product has been designed and manufactured according to the following specifications:

SAFETY	EN61010 (2001)
EMC	EN61326 (1997 w/A1:98) Class A CISPR 22 (1997) Class A VCCI (April 2000) Class A ICES-003 Class A (ANSI C63.4 1992) AS/NZS 3548 (w/A1 & A2:97) Class A FCC Part 15 Subpart B Class A EN 61010-1:2001



The product was installed into a C-size VXI mainframe chassis and tested in a typical configuration.

I hereby declare that the aforementioned product has been designed to be in compliance with the relevant sections of the specifications listed above as well as complying with all essential requirements of the Low Voltage Directive.

January 2007



Steve Mauga, QA Manager

GENERAL SAFETY INSTRUCTIONS

Review the following safety precautions to avoid bodily injury and/or damage to the product. These precautions must be observed during all phases of operation or service of this product. Failure to comply with these precautions, or with specific warnings elsewhere in this manual, violates safety standards of design, manufacture, and intended use of the product.

Service should only be performed by qualified personnel.

TERMS AND SYMBOLS

These terms may appear in this manual:

- WARNING** Indicates that a procedure or condition may cause bodily injury or death.
- CAUTION** Indicates that a procedure or condition could possibly cause damage to equipment or loss of data.

These symbols may appear on the product:



ATTENTION - Important safety instructions



Frame or chassis ground



Indicates that the product was manufactured after August 13, 2005. This mark is placed in accordance with *EN 50419, Marking of electrical and electronic equipment in accordance with Article 11(2) of Directive 2002/96/EC (WEEE)*. End-of-life product can be returned to VTI by obtaining an RMA number. Fees for take-back and recycling will apply if not prohibited by national law.

WARNINGS

Follow these precautions to avoid injury or damage to the product:

- Use Proper Power Cord** To avoid hazard, only use the power cord specified for this product.
- Use Proper Power Source** To avoid electrical overload, electric shock, or fire hazard, do not use a power source that applies other than the specified voltage.
- Use Proper Fuse** To avoid fire hazard, only use the type and rating fuse specified for this product.

WARNINGS (CONT.)**Avoid Electric Shock**

To avoid electric shock or fire hazard, do not operate this product with the covers removed. Do not connect or disconnect any cable, probes, test leads, etc. while they are connected to a voltage source. Remove all power and unplug unit before performing any service. ***Service should only be performed by qualified personnel.***

Ground the Product

This product is grounded through the grounding conductor of the power cord. To avoid electric shock, the grounding conductor must be connected to earth ground.

Operating Conditions

To avoid injury, electric shock or fire hazard:

- Do not operate in wet or damp conditions.
- Do not operate in an explosive atmosphere.
- Operate or store only in specified temperature range.
- Provide proper clearance for product ventilation to prevent overheating.
- DO NOT operate if any damage to this product is suspected. ***Product should be inspected or serviced only by qualified personnel.***

Improper Use

The operator of this instrument is advised that if the equipment is used in a manner not specified in this manual, the protection provided by the equipment may be impaired. Conformity is checked by inspection.

SUPPORT RESOURCES

Support resources for this product are available on the Internet and at VXI Technology customer support centers.

VXI Technology World Headquarters

VXI Technology, Inc.
2031 Main Street
Irvine, CA 92614-6509

Phone: (949) 955-1894
Fax: (949) 955-3041

VXI Technology Cleveland Instrument Division

VXI Technology, Inc.
7525 Granger Road, Unit 7
Valley View, OH 44125

Phone: (216) 447-8950
Fax: (216) 447-8951

VXI Technology Lake Stevens Instrument Division

VXI Technology, Inc.
1924 - 203 Bickford
Snohomish, WA 98290

Phone: (425) 212-2285
Fax: (425) 212-2289

Technical Support

Phone: (949) 955-1894
Fax: (949) 955-3041
E-mail: support@vxitech.com



Visit <http://www.vxitech.com> for worldwide support sites and service plan information.

SECTION 1

INTRODUCTION

OVERVIEW

The VT1521 is designed to provide an accurate means of doing high-speed bridge measurements. It provides bridge completion circuitry, excitation voltage, programmable low-pass filters, and wideband buffered outputs on four channels. The low-pass filter on each channel is a 4th order Butterworth active RC filter used to provide alias protection and improved noise reduction. The low-pass filter cutoff frequencies are 10 kHz, 3 kHz, 1 kHz, 300 Hz, and 100 Hz. Bridge completion resistors for quarter- and half-bridge measurements are built-in to the VT1521-TFB (*trifilar bridge*) terminal block option with completion values of 120 Ω and 350 Ω . The VT1521 SCP is designed to provide self-regulating excitation voltages of 0 V, 1 V, 2 V, 5 V, or 10 V on each channel, for improved measurement accuracy. The SCP provides a voltage gain of 0.5, 8, 64, or 512 for each channel. This SCP takes two adjacent slots in the VXI module. Use the VT1521 with the following VXI module:

VT1413C 64-channel scanning A/D converter

VT1521-TFB TERMINAL BLOCK

The VT1521-TFB terminal block option is a 16-channel terminal block with a trifiler filter per channel for high common mode signal rejection. Designed to work with the VT1521, the TFB option also contains user replaceable shunt calibration resistors. The specifications for the VT1521 reflect the combined performance of the scanning A/D and the VT1521 SCP and VT1521-TFB terminal block option.

ABOUT THIS MANUAL

This manual shows how to connect to the terminal module for strain measurements, and also shows how to control the SCP using API (*application programming interface*) and register-based commands.

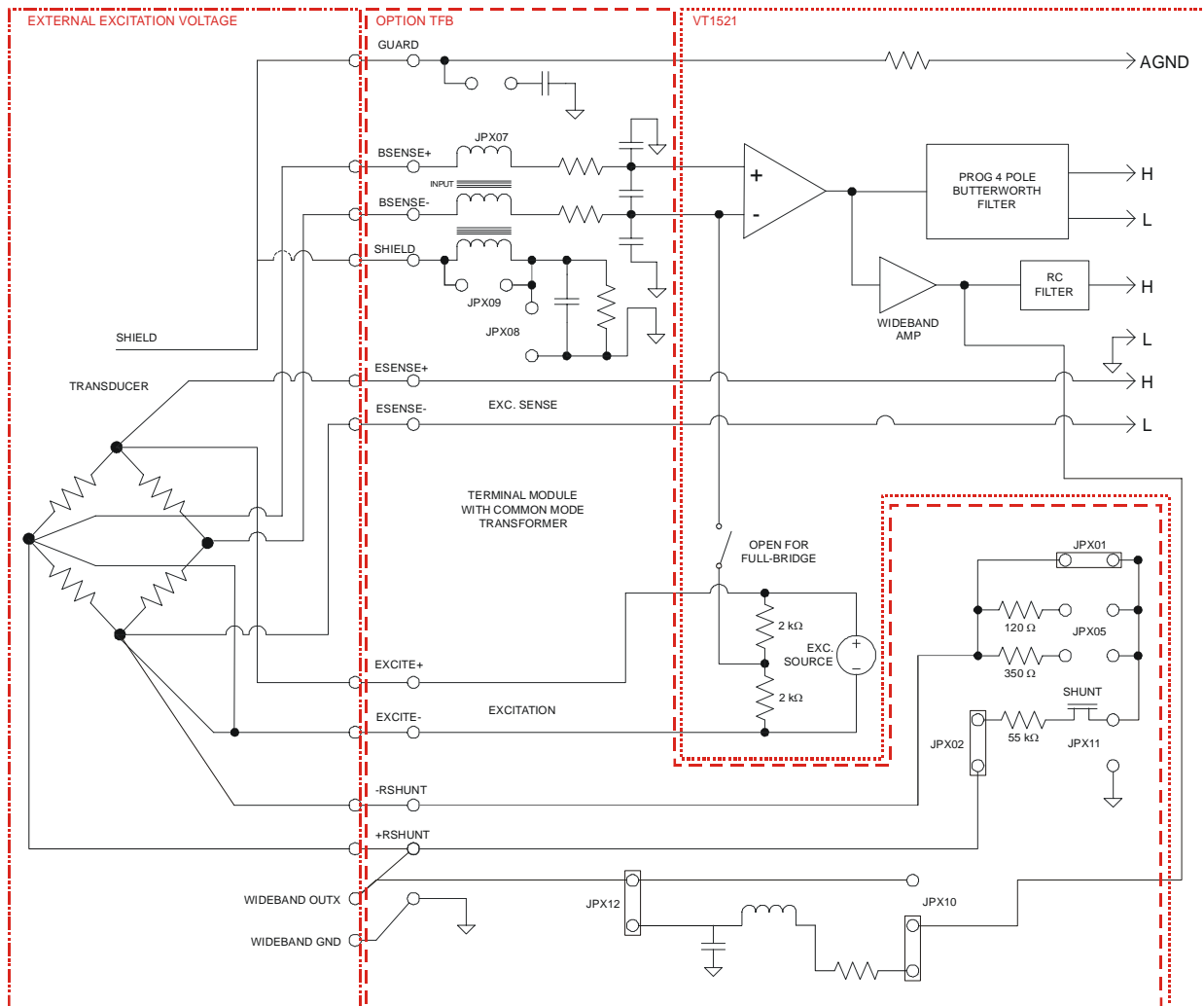

FIGURE 1-1: VT1521 BLOCK DIAGRAM, FULL-BRIDGE CONFIGURATION

NOTE More detailed schematics for the VT1521 Option TFB exist in the *VT1521-TFB User's Manual*.

SPECIFICATIONS

GENERAL SPECIFICATIONS

MEASUREMENT RANGES

Volts (dc)	±16 V peak
------------	------------

INPUT CHARACTERISTICS

Maximum input voltage (normal mode plus common mode)*

Operating <±16 V peak

Damage level >±42 V peak

* Note: The voltage at the output of the VT1521 must be limited to 10 V. This means that the product of the input voltage (V_{in}) and the VT1521 gain must be less than or equal to 10 V. For example,

$$\text{since } V_{in} \times \text{Gain} \leq 10 \text{ V, if Gain} = 64, \text{ then } V_{in} \leq \frac{10}{64} \text{ V}$$

Maximum common mode voltage

Operating <±16 V peak

Damage level >±42 V peak

Common mode rejection (0 Hz to 60 Hz)

x0.5 gain >60 dB

x8 gain >78 dB

x64 gain >100 dB

x512 gain >100 dB

Input impedance 100 MΩ

MAXIMUM TARE CAL OFFSET

x0.5 gain ±25% of full-scale

x8 gain ±90 mV

x64 gain ±95 mV

x512 gain ±95 mV

FILTER CHARACTERISTICS

Frequency	4-pole Butterworth Filter	Settling Time*
100 Hz	-3 dB, 400 Hz: >47 dB	39.2 ms
300 Hz	-3 dB, 1.2 kHz: >47 dB	16.67 ms
1 kHz	-3 dB, 4 kHz: >47 dB	4.38 ms
3 kHz	-3 dB, 12 kHz: >47 dB	1.09 ms
10 kHz	-3 dB, 40 kHz: >47 dB	401 μs

* Note: Settling time provided is for a 10 V pulse at the input filter to < 0.01% of final value. For example, given a specified gain, the following input voltages (V_{in}) would be required:

Gain = 0.5, $V_{in} = 20 \text{ V}$

Gain = 8, $V_{in} = 1.25 \text{ V}$

Gain = 64, $V_{in} = 0.15625 \text{ V}$

Gain = 512, $V_{in} = 0.01953125 \text{ V}$

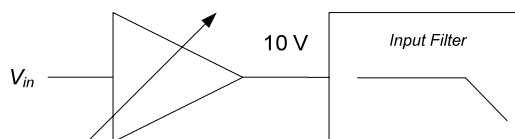

DC VOLTAGE MEASUREMENT ACCURACY

x0.5 gain*	Range \pm FS	Linearity (% of reading)	Offset Error	Noise (3 σ)
	125 mV	0.02	488 μ V	1.5 μ V
0.5 V	0.02	488 μ V	1.5 μ V	
2.0 V	0.02	488 μ V	1.5 μ V	
8.0 V	0.02	488 μ V	1.5 μ V	
16.0 V	0.02	488 μ V	1.5 μ V	

x8 gain*	Range \pm FS	Linearity (% of reading)	Offset Error	Noise (3 σ)
	7.8 mV	0.02	30.5 μ V	95 μ V
31.25 mV	0.02	30.5 μ V	95 μ V	
125 mV	0.02	30.5 μ V	95 μ V	
0.5 V	0.02	30.5 μ V	95 μ V	
1 V	0.02	30.5 μ V	95 μ V	

*Temperature Coefficients: add tempco error to the table above:

Gain	10 ppm/°C (after *CAL)
Offset	0 °C - 30 °C 0 μ V
	30 °C - 55 °C 0.75 μ V

x64 gain**	Range \pm FS	Linearity (% of reading)	Offset Error	Noise (3 σ)
	3.9 mV	0.02	15 μ V	12 μ V
15.6 mV	0.02	15 μ V	12 μ V	
62.5 mV	0.02	15 μ V	12 μ V	
125 mV	0.02	15 μ V	12 μ V	

x512 gain**	Range \pm FS	Linearity (% of reading)	Offset Error	Noise (3 σ)
	7.8 mV	0.04	15 μ V	2 μ V

**Temperature Coefficients: add tempco error to the table above:

Gain	10 ppm/°C (after *CAL)
Offset	0 °C - 30 °C 0 μ V
	30 °C - 55 °C 0.75 μ V

For all dc voltage measurement accuracy measurements: Specifications are 90 days, 23 °C \pm 1 °C with vt1413_calibrate_channel_start done after a 1 hr warm-up and vt1413_calibrate_zero done within 5 minutes. Note: Beyond the 5 minute limitation and vt1413_calibrate_zero not done, apply the following drift error: Drift = 10 μ V/°C \div SCP gain, per °C change from vt1413_calibrate_zero temperature.

BRIDGE EXCITATION

Bridge excitation values	1 V, 2 V, 5 V, 10 V
Maximum current	50 mA per channel

WIDEBAND BUFFERED OUTPUTS

Frequency response (-3 dB)	40 kHz
Signal gain	1 \pm 1%
Maximum output level (@ dc)	\pm 16 V \pm 1.8 V (into 10 k Ω load)
Maximum output current	5 mA/channel
Output impedance	<1.5 Ω (without filter)

TFB TERMINAL BLOCK

Wideband Output Connector	1 x 34-pin SGMC Positronic connector
Input Connectors	4 x 44-pin SGMC Positronic connectors

CURRENT REQUIREMENTS

+5 V max	0.65 A
+24 V max	0.18 A
-24 V max	0.18 A

VT1521 Quarter-Bridge Error

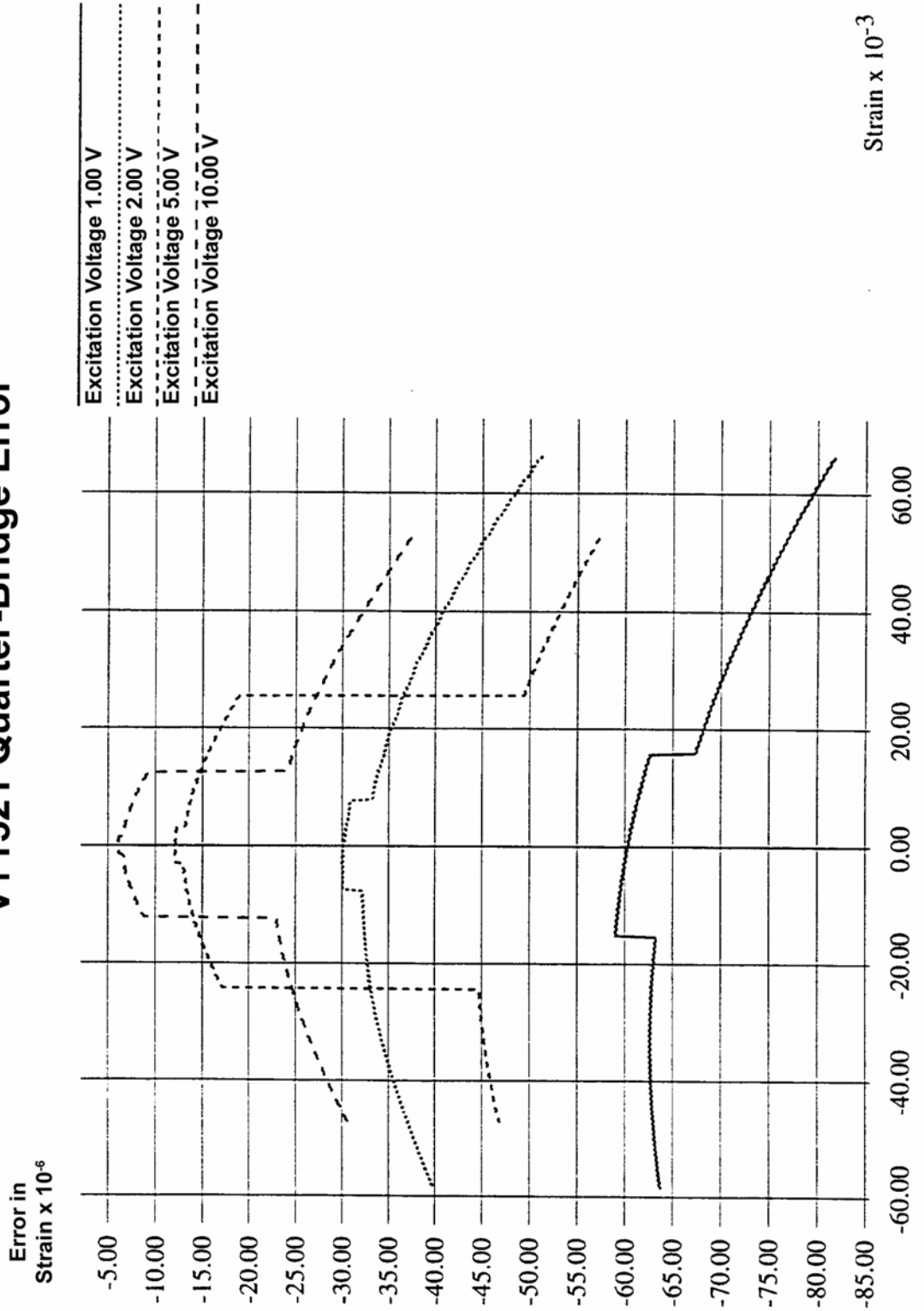

VT1521 Half-Bridge Bending Error

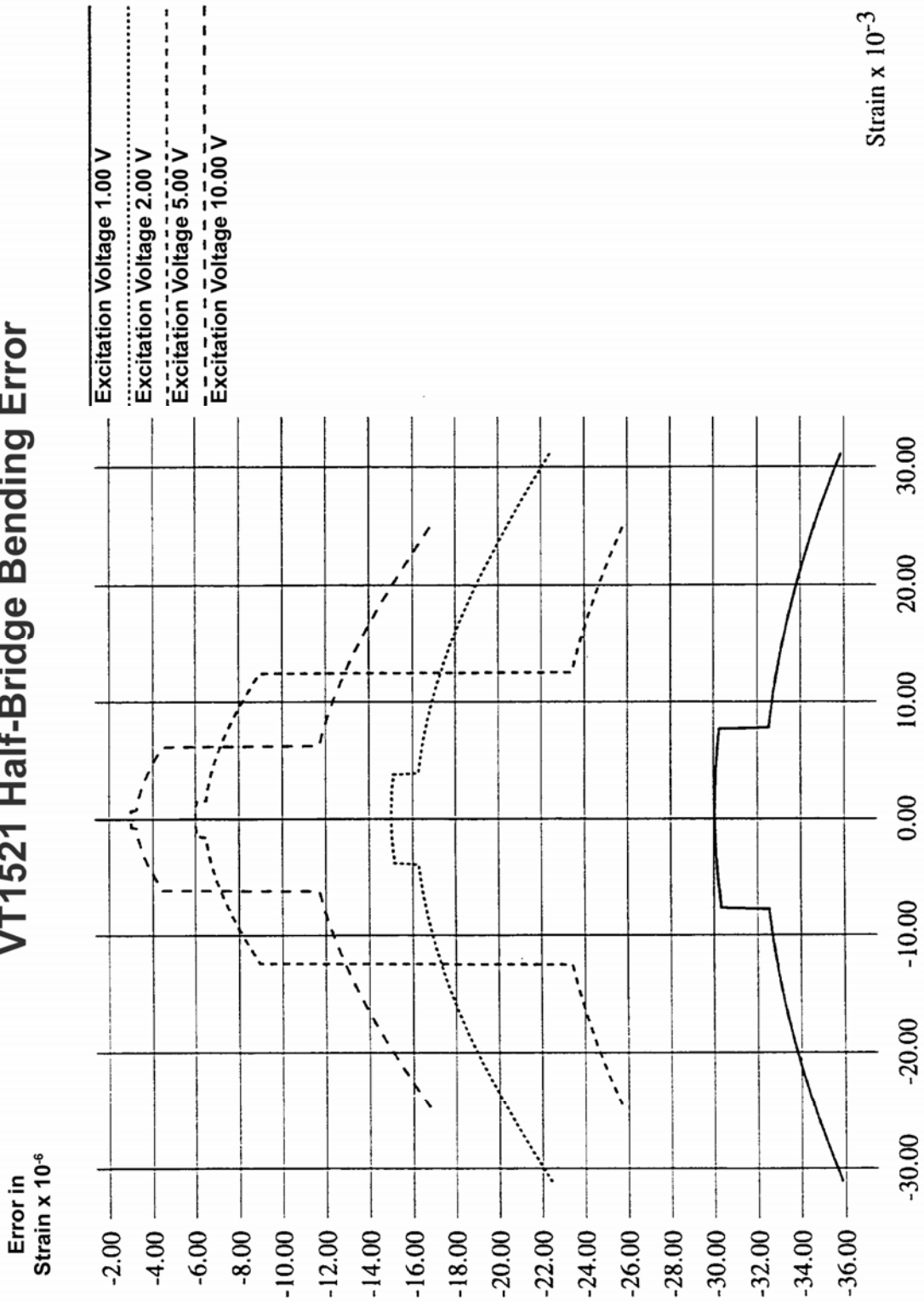

VT1521 Half-Bridge Poisson Error

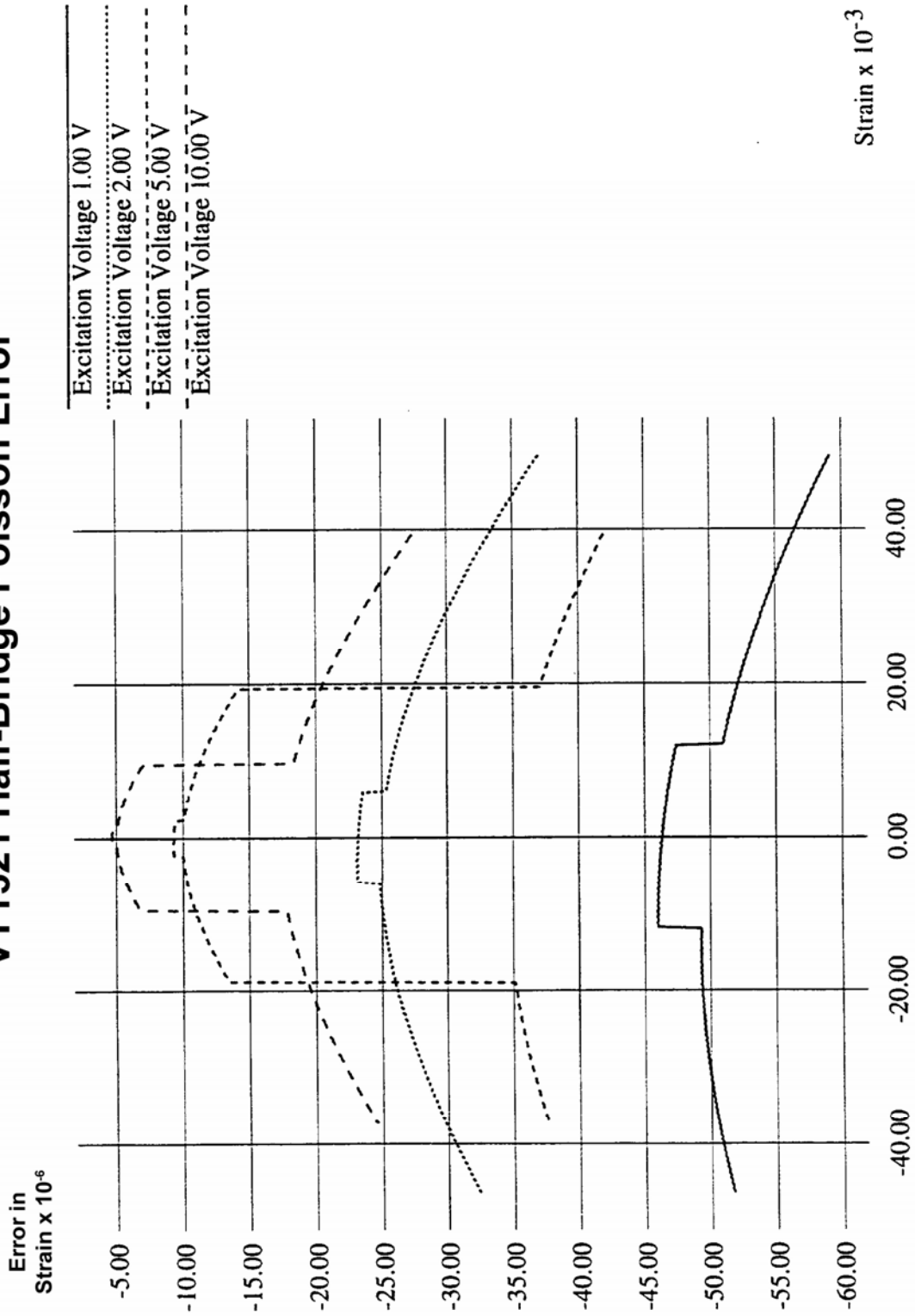

VT1521 Full-Bridge Bending Error

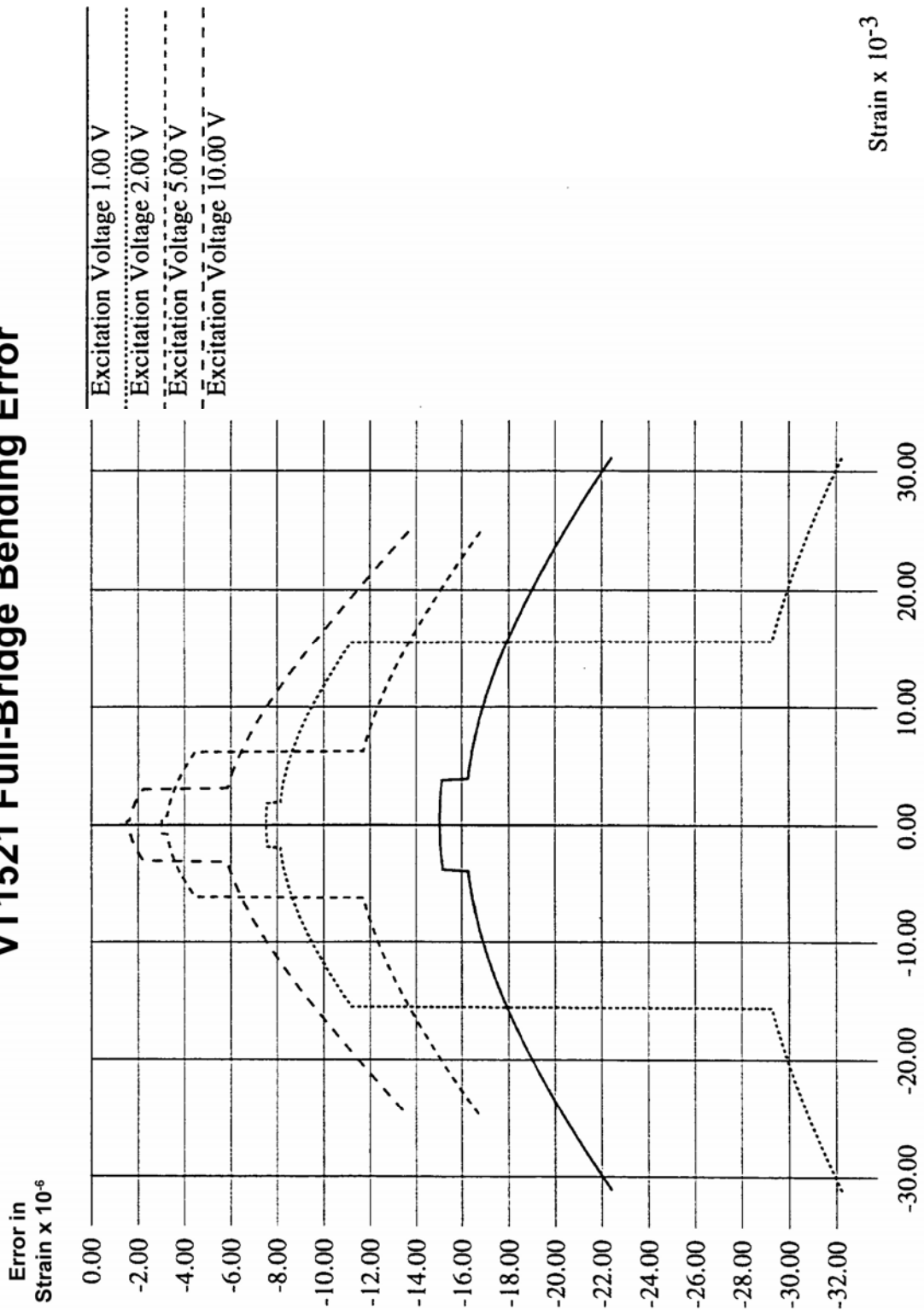

VT1521 Full-Bridge Poisson Error

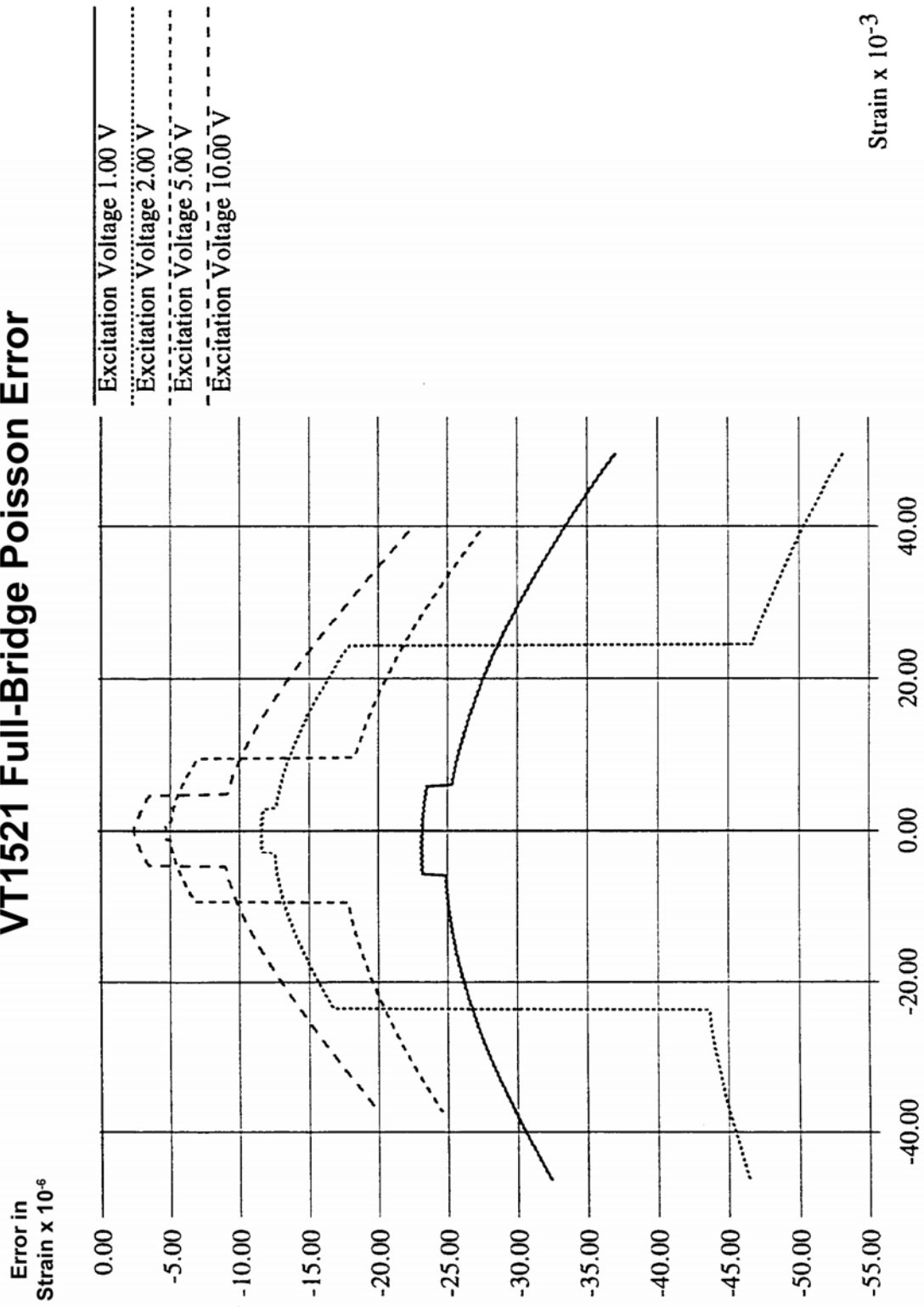

VT1521 Full-Bridge Bending Poisson Error

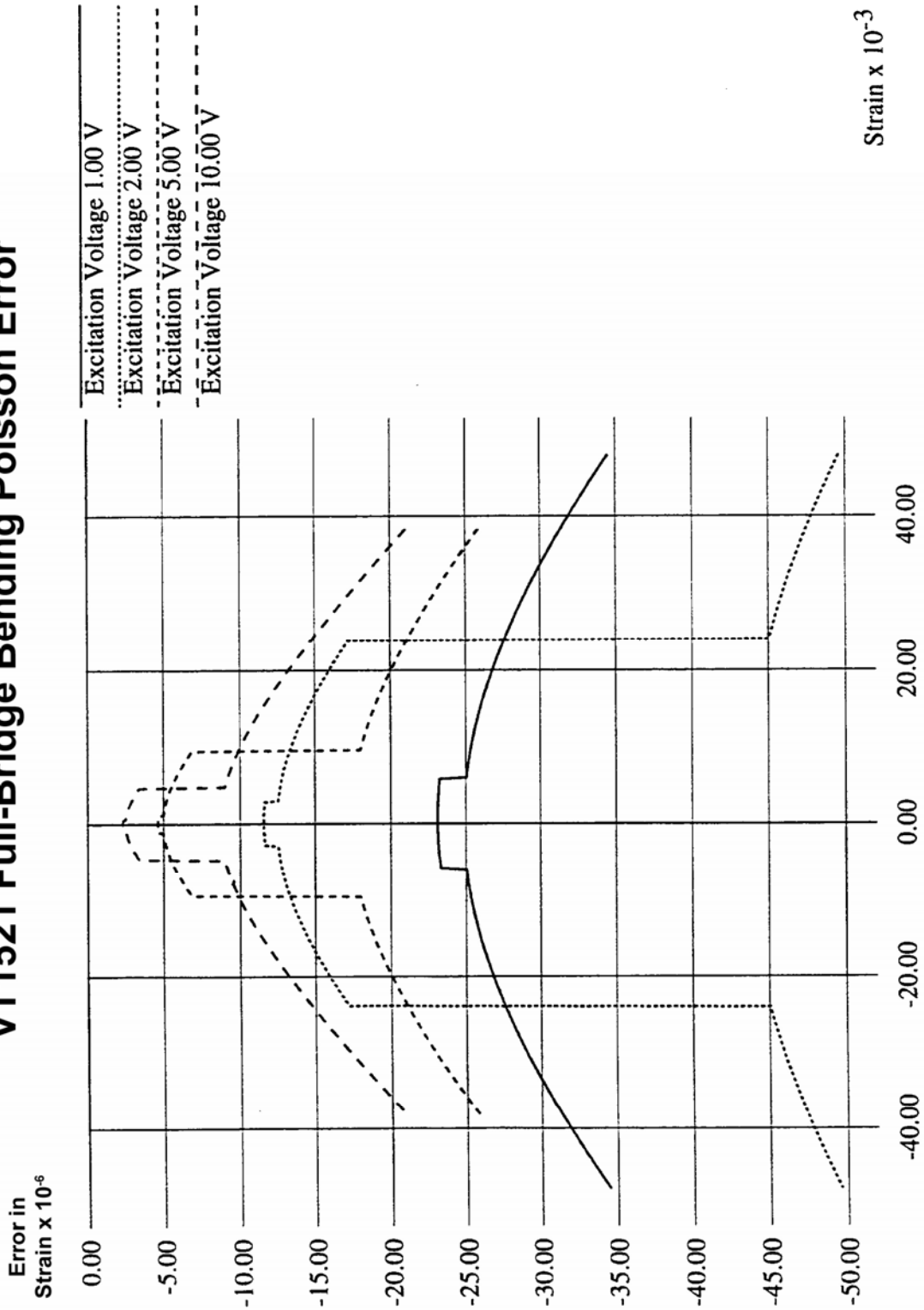

SECTION 2

OPERATION

OPERATION

There are two circuits on the VT1521 SCP for each of the four channels: one circuit provides the bridge excitation voltage and bridge completion circuitry, and the other circuit provides the gain and the filtering.

The completion circuitry can output a bridge excitation voltage of 0 V, 1 V, 2 V, 5 V, or 10 V on each channel.

NOTE	The 10 V excitation level cannot be used with a 120 Ω full-bridge configuration. This low impedance bridge configuration draws too much current from the excitation supply at 10 V (>50 mA supply limit).
-------------	--

The measurement circuitry provides the measurement path to the VT1413C for both the excitation and output voltage of the strain gage bridge. The VT1413C measures the excitation voltage during calibration and measures the bridge output voltage during a measurement cycle.

When reducing the filter bandwidth, the propagation delay increases between the channels, which cause a larger delay between channels programmed to the same bandwidth. The circuitry provides a voltage gain of 0.5, 8, 64, or 512 for each bridge output measurement channel.

The SCP also has a low-pass filter on each bridge output measurement channel. The filter is a 4th order Bessel active RC filter used to provide alias protection and noise reduction. The filter cutoff frequencies are 10 kHz, 3 kHz, 1 kHz, 300 Hz, and 100 Hz.

There are two ways the VT1413C can measure the excitation voltage while calibrating the SCP. One-way measures the voltages at the bridge connections (remote sense) and the other way measure the voltage locally at the connections in the terminal module. The remote sense is more accurate, but requires extra wiring to the bridge. The VT1521 uses the remote sense wires (when connected) to automatically adjust the excitation voltage using a feedback loop. If the remote sense wires are not connected at the bridge, a local 10 k Ω resistor closes the feedback loop.

CHANNELS

The VT1521 SCP takes up two positions on the VT1413C. This corresponds to 16 channels.

Only four of these channels correspond to bridge voltage measurements. Aside from the four bridge voltages, there are twelve other channels that can be measured:

Channel	Measurement
0	Channel 0 bridge voltage
1	Channel 1 bridge voltage
2	Channel 2 bridge voltage
3	Channel 3 bridge voltage
4	Channel 0 excitation sense voltage
5	Channel 1 excitation sense voltage
6	Channel 2 excitation sense voltage
7	Channel 3 excitation sense voltage
8	Channel 0 wideband output voltage
9	Channel 1 wideband output voltage
10	Channel 2 wideband output voltage
11	Channel 3 wideband output voltage
12	Channel 0 excitation drive voltage
13	Channel 1 excitation drive voltage
14	Channel 2 excitation drive voltage
15	Channel 3 excitation drive voltage

SECTION 3

PROGRAMMING

PROGRAMMING WITH API COMMANDS

By using the VT1521 in conjunction with the VT1413C, a user is able to perform strain measurements. The APIs used are listed below and are followed by programming examples. The APIs can also be found in the VT1413C Help File.

COMMANDS USED

The following table lists all commands used in this section of the manual.

Command	Description
vt1413_channel_set_filter_freq (ViSession instrumentHandle, ViInt16 _VI_FAR channels[], ViInt16 number_ofChannels, ViReal64 cutoffFrequency);	Sets the filter frequency on the input SCPs that support programmable filtering.
vt1413_channel_set_gain (ViSession instrumentHandle, ViInt16 _VI_FAR channels[], ViInt16 number_ofChannels, ViReal64 gain);	Sets the filter gain on the Input SCPs that support programmable gain.
vt1413_channel_set_low_input (ViSession instrumentHandle, ViInt16 _VI_FAR channels[], ViInt16 number_ofChannels, ViBoolean LOInput_toWV);	Enables the low input on a transient strain gauge board (VT1521) to be connected to a terminal or to the bridge's internal Wagner voltage.
vt1413_channel_set_voltage (ViSession instrumentHandle, ViInt16 _VI_FAR channels[], ViInt16 number_ofChannels, ViReal64 voltageAmplitude);	Sets the voltage source amplitude on the Output SCPs that support programmable voltage sources. For the VT1521, it sets the excitation voltage.
vt1413_close (ViSession instrumentHandle);	Closes the instrument session.
vt1413_error_message (ViSession instrumentHandle, ViStatus errorCode, ViChar _VI_FAR errorMessage[]);	Takes the Status Code returned by the instrument driver functions, interprets it, and returns it as a user readable string.
vt1413_get_scp_description (ViSession instrumentHandle, ViInt16 SCPModulePosition, ViChar _VI_FAR SCPDescription[]);	Returns a text description of the SCP installed in the specified position (0-7).
vt1413_init (ViRsrc resource_Name, ViBoolean ID_Query, ViBoolean reset_Device, ViSession instrument_Handle)	Performs various initialization actions.
vt1413_quick_measure_strain (ViSession instrumentHandle, ViInt16 list, ViInt16 _VI_FAR channels[], ViInt16 number_of_Channels, ViReal64 range, ViInt16 bridge_Type, ViReal64 sample_Rate_Seconds, ViInt32 trigger_Count, ViReal64 _VI_FAR data[]);	Used for simple configurations where only a single strain measurement type is needed, or for system testing.
vt1413_set_strain_gauge_factor (ViSession instrumentHandle, ViInt16 _VI_FAR channels[], ViInt16 number_ofChannels, ViReal64 gaugeFactor);	Sets the strain gauge Gauge Factor to be used for strain gauge EU conversions.

PROGRAMMING EXAMPLES

CHECKING THE ID OF THE SCP

This is a sample program to illustrate the use of the VT1413C *VXIplug&play* driver. This program queries the instrument for the installed SCPs and prints their descriptions.

```

*****/
/* include the driver header file*/
#include<vt1413_32.h>

int main( int argc, char **argv )
{
    ViSession vi;           /* session handle */
    ViStatus status;       /* status variable */
    ViUInt32 i;            /* counter variable */
    FILE *fout;           /* file handle */
    ViChar scp_descrip[256]; /* hold SCP description */

    /* Connect to the VT1413 at the default Logical Address and reset it */
    status = vt1413_init ("VXI0::24::INSTR", VI_ON, VI_ON, &vi);
    if( status != VI_SUCCESS )
        return -1;

    /* Open a file for output */
    fout = fopen("SCP_ID.txt", "w");

    /* Query the instrument for the descriptions of all 8 SCPS positions */
    for(i = 0; i < 8; i++)
    {
        status = vt1413_get_scp_description( vi, i, scp_descrip);
        fprintf(fout, "MODULE %d %s\n", i, scp_descrip);
    }

    /* Close the file */
    fclose( fout );

    /* Close the instrument session*/
    status = vt1413_close (vi);

    return 0;
}
*****/

```

With a single VT1521 plugged into positions 0 and 1, the output received after execution of this sample program is as follows:

```
MODULE 0 MODEL: VT1521 DESCRIPTION: 4-Ch Transient Strain SCP
MODULE 1 MODEL: VT1521 DESCRIPTION: 4-Ch Transient Strain SCP
MODULE 2 MODEL: DESCRIPTION: No SCP at this Address
MODULE 3 MODEL: DESCRIPTION: No SCP at this Address
MODULE 4 MODEL: DESCRIPTION: No SCP at this Address
MODULE 5 MODEL: DESCRIPTION: No SCP at this Address
MODULE 6 MODEL: DESCRIPTION: No SCP at this Address
MODULE 7 MODEL: DESCRIPTION: No SCP at this Address
```

“VT1521” is returned for both module 0 and module 1, as the VT1521 occupies two SCP module slots in a VT1413C base module.

MAKING QUARTER-BRIDGE MEASUREMENTS

This programming example illustrates how to make a quarter-bridge measurement on channels 0 through 3.

```
*****/
/* include the driver header file*/
#include<vt1413_32.h>

/* Function prototype */
ViStatus Qbridge(ViSession vi, FILE *fout);

int main( int argc, char **argv )
{
    ViSession vi          /* session handle */
    ViStatus  status;
    FILE     *fout;      /* file handle */
    ViChar   msg[1000];  /* pointer to error message */

    /* Connect to the VT1413 at the default Logical Address and reset it */
    status = vt1413_init ("VXI0::24::INSTR", VI_ON, VI_ON, &vi);
    if (status != VI_SUCCESS) return status;

    /* Open a file for output */
    fout = fopen("QBridge.txt", "w");

    /* Go make the measurement */
    status = Qbridge(vi, fout);

    vt1413_error_message (vi, status, msg);
    fprintf(fout, "%s\n", msg);

    /* Close the file */
    fclose( fout );
```

```

    /* Close the instrument session*/
    vt1413_close (vi);
}

ViStatus Qbridge(ViSession vi, FILE *fout)
{
    ViStatus  status;           /* status variable */
    ViUInt32  i;               /* counter variable */
    ViInt16   chans[4];       /* channel list */
    ViReal64  data[4];        /* data goes here */

    /* Create a channel list of channels 0 to 3 */
    for (i=0; i<4; i++)
    {
        chans[i] = i;
    }
    /* Set the excitation voltage to 1.0V */
    status = vt1413_channel_set_voltage (vi, chans, 4, 1.0);
    if (status != VI_SUCCESS) return status;

    /* Enable the wagner voltage */
    status = vt1413_channel_set_low_input (vi, chans, 4, VI_TRUE);

    /* Set the low-pass filter frequency to 100 Hz. */
    status = vt1413_channel_set_filter_freq (vi, chans, 4, 100.0);
    if (status != VI_SUCCESS) return status;

    /* Set the gain to 8 */
    status = vt1413_channel_set_gain (vi, chans, 4, 8.0);
    if (status != VI_SUCCESS) return status;

    /* Set the gauge factor to 2.0 */
    status = vt1413_set_strain_gauge_factor (vi, chans, 4, 2.0);
    if (status != VI_SUCCESS) return status;

    /* Normally a tare calibration would be performed here */
    /* on the unstrained bridge to remove offsets */

    /* Then the bridge would be strained */

    /* Do the measurement the easy way on auto, quarter bridge */
    status = vt1413_quick_measure_strain (vi, VT1413_LIST1, chans, 4,
                                         VT1413_RANGE_AUTO,
                                         VT1413_CONV_STRAIN_QUARTER_BRIDGE,
                                         0.00001, 1, data);
    if (status != VI_SUCCESS) return status;

    /* Write the strain data to the file */
    for(i = 0; i < 4; i++)
    {
        fprintf(fout, "Channel %d strain is %f\n", i, data[i]);
    }

    return status;
}
*****/

```

Upon execution of this program, the following output is returned:

```
Channel 0 strain is 0.017178
Channel 1 strain is 0.061576
Channel 2 strain is 0.034943
Channel 3 strain is 0.302573
Operation completed successfully.
```

MAKING FULL-BENDING POISSON BRIDGE MEASUREMENTS

This programming example illustrates how to make a full-bending poisson bridge measurement on channels 0 through 3.

```
*****/
/* include the driver header file*/
#include<vt1413_32.h>

/* Function prototype */
ViStatus FPbridge(ViSession vi, FILE *fout);

int main( int argc, char **argv )
{
    ViSession vi                /* session handle */
    ViStatus  status;
    FILE      *fout             /* file handle */
    ViChar    msg[1000];        /* pointer to error message */

    /* Connect to the VT1413 at the default Logical Address and reset it */
    status = vt1413_init ("VXI0::24::INSTR", VI_ON, VI_ON, &vi);
    if (status != VI_SUCCESS) return status;

    /* Open a file for output */
    fout = fopen("FPbridge.txt", "w");

    /* Go make the measurement */
    status = FPbridge(vi, fout);

    vt1413_error_message (vi, status, msg);
    fprintf(fout, "%s\n", msg);

    /* Close the file */
    fclose( fout );

    /* Close the instrument session*/
    vt1413_close (vi);
}
```

```

ViStatus FPbridge(ViSession vi, FILE *fout)
{

    ViStatus  status;           /* status variable */
    ViUInt32  i;               /* counter variable */
    ViInt16   chans[4];       /* channel list */
    ViReal64  data[4];        /* data goes here */
    /* Create a channel list of channels 0 to 3 */
    for (i=0; i<4; i++)
    {
        chans[i] = i;
    }

    /* Set the excitation voltage to 1.0 V */
    status = vt1413_channel_set_voltage (vi, chans, 4, 1.0);
    if (status != VI_SUCCESS) return status;

    /* Set the low-pass filter frequency to 100 Hz. */
    status = vt1413_channel_set_filter_freq (vi, chans, 4, 100.0);
    if (status != VI_SUCCESS) return status;

    /* Set the gain to 8 */
    status = vt1413_channel_set_gain (vi, chans, 4, 8.0);
    if (status != VI_SUCCESS) return status;

    /* Set the gauge factor to 2.0 */
    status = vt1413_set_strain_gauge_factor (vi, chans, 4, 2.0);
    if (status != VI_SUCCESS) return status;

    /* Normally a tare calibration would be performed here */
    /* on the unstrained bridge to remove offsets */

    /* Then the bridge would be strained */

    /* Do the measurement the easy way on auto, full bending poisson bridge */
    status = vt1413_quick_measure_strain (vi, VT1413_LIST1, chans, 4,
                                         VT1413_RANGE_AUTO,
                                         VT1413_CONV_STRAIN_FULL_BRDG_BEND_POIS,
                                         0.00001, 1, data);
    if (status != VI_SUCCESS) return status;

    /* Write the strain data to the file */
    for(i = 0; i < 4; i++)
    {
        fprintf(fout, "Channel %d strain is %f\n", i, data[i]);
    }

    return status;
}
*****/

```

Upon execution of this program, the following output is returned:

```
Channel 0 strain is -0.128701
Channel 1 strain is 0.046064
Channel 2 strain is 0.051099
Channel 3 strain is 0.299317
Operation completed successfully.
```

EXPLANATION OF COMMANDS USED

The following explains the commands used in strain measurements.

Purpose of the Initialize Command (vt1413_init)

The vt1413_init command performs the following initialization actions:

- opens a session to the Default Resource Manager resource and a session to the specified device using the interface and address specified in the Resource_Name control
- performs an identification query on the VT1521, resets the instrument to a known state
- sends initialization commands to the instrument that set any necessary programmatic variables
- returns an instrument handle which is used to differentiate between different sessions of this instrument driver.

Each time this function is invoked, a unique session is opened. It is possible to have more than one session open for the same resource. The command syntax is:

```
vt1413_init (resource_Name, ID_Query, reset_Device, *instrument_Handle)
```

The resource_Name parameter specifies the interface and address of the device that is to be initialized (Instrument Descriptor). ID_Query is a Boolean control that specifies whether an ID Query will be sent to the instrument during the initialization procedure. The reset_Device parameter is a Boolean control that specifies whether the VT1521 will be reset to its power-on settings during the initialization procedure. Lastly, *instrumentHandle is a session handle returned by this function.

Purpose of the Get SCP Description Command (vt1413_get_scp_description)

The vt1413_get_scp_description command returns a text description of the SCP installed in the specified position (0-7). The command syntax is:

```
vt1413_get_scp_description (instrumentHandle, SCPModulePosition, SCPDescription[])
```

The instrumentHandle parameter is a session handle. SCPModulePosition indicates the module position (0 - 7). The SCPDescription[] parameter returns a string describing the SCP found at the specified position.

Purpose of the Close Command (vt1413_close)

The vt1413_close command closes the instrument session. The command syntax is:

```
vt1413_close (instrumentHandle)
```

The instrumentHandle parameter indicates the session handle to close.

Purpose of the Error Message Command (vt1413_error_message)

The vt1413_error_message takes the Status Code returned by the instrument driver functions, interprets it, and returns it as a user readable string. The command syntax is:

```
vt1413_error_message (instrumentHandle, errorCode, errorMessage[])
```

The **instrumentHandle** parameter is a session handle. The **errorCode** parameter accepts the Status Code returned from the instrument driver functions. Lastly, **errorMessage[]** returns the interpreted Status Code as a user readable message string.

Purpose of the Channel Set Voltage Command (vt1413_channel_set_voltage)

The vt1413_channel_set_voltage takes the Status Code returned by the instrument driver functions, interprets it, and returns it as a user readable string. The command syntax is:

```
vt1413_channel_set_voltage (instrumentHandle, channels[], number_ofChannels, voltageAmplitude)
```

The **instrumentHandle** parameter is a session handle. The **channels[]** parameter is an array of channel numbers (0 - 63) to be configured. The **number_ofChannels** parameter indicates how many channels exist in the **channels[]** array. Lastly, **voltageAmplitude** sets voltage amplitude in volts. The supported voltage amplitude closest to the desired value is set. If the desired value is out of the range of supported values, an error is returned. On a VT1521, this sets the excitation voltage.

Connecting Input (vt1413_channel_set_low_input)

For quarter- and half-bridge configurations, the low input of the input amplifier should be connected to the negative side of the internal bridge connection on the SCP itself. This is done by a switch on the SCP that provides the Wagner voltage for the bridge (see the *VT1521-TFB manual* for more information).

For full-bridge configuration, the low input of the input amplifier should be externally connected to the negative side of the bridge. The amplifier input must not be connected to the internal bridge (see the *VT1521-TFB manual* for more information).

Use the following command for either configuration:

```
vt1413_channel_set_low_input (instrumentHandle, channels[], number_ofChannels, LOInput_toWV)
```

The **instrumentHandle** parameter is a session handle. The **channels[]** parameter is an array of channel numbers (0 - 63) to be configured. The **number_ofChannels** parameter indicates how many channels exist in the **channels[]** array. Lastly, **LOInput_toWV** is a Boolean value that enables or disables the connection to the bridge's internal Wagner voltage.

Purpose of the Set Filter Frequency Command (vt1413_channel_set_filter_freq)

The vt1413_channel_set_filter_freq sets the filter frequency on input SCPs that support programmable filtering. The command syntax is:

```
vt1413_channel_set_filter_freq (instrumentHandle, channels[], number_ofChannels, cutoffFrequency)
```

The **instrumentHandle** parameter is a session handle. The **channels[]** parameter is an array of channel numbers (0 - 63) to be configured. The **number_ofChannels** parameter indicates how many channels exist in the **channels[]** array. Lastly, **cutoffFrequency** sets the filter cutoff frequency, in hertz. The supported frequency closest to the desired value is set. If the desired value is out of the range of supported values, an error is returned.

Purpose of the Set Channel Gain Command (vt1413_channel_set_gain)

The vt1413_channel_set_gain sets the filter gain on input SCPs that support programmable gain. The command syntax is:

```
vt1413_channel_set_gain (instrumentHandle, channels[], number_ofChannels, gain)
```

The `instrumentHandle` parameter is a session handle. The `channels[]` parameter is an array of channel numbers (0 - 63) to be configured. The `number_ofChannels` parameter indicates how many channels exist in the `channels[]` array. Lastly, `gain` is the gain value (e.g., 1.0, 10.0, etc.). The supported gain closest to the desired value is set. If the desired value is out of the range of supported values, an error is returned.

Purpose of the Strain Gauge Factor Command (vt1413_set_strain_gauge_factor)

The vt1413_set_strain_gauge_factor command specifies the gage factor to be used by the VT1413C to calculate the strain measurements. The default value of the command is a factor of 2. The command syntax is:

```
vt1413_set_strain_gauge_factor (instrumentHandle, channels[], number_ofChannels, gaugeFactor)
```

The `instrumentHandle` parameter is a session handle. The `channels[]` parameter is an array of channel numbers (0 - 63) to be configured. The `number_ofChannels` parameter indicates how many channels exist in the `channels[]` array. Lastly, `gaugeFactor` is the gauge factor to be used for strain gauge EU conversions.

Purpose of the Quick Measure Strain Command (vt1413_quick_measure_strain)

The vt1413_quick_measure_strain command performs the following operations: configures the specified scanlist with the provided channels and sample rate, configures the provided channels for strain measurement on the range provided, configures the trigger subsystem for the number of triggers provided, trigger immediate, and arm immediate, performs an init and transfers the resulting data into the buffer provided. This function should only be used for simple configurations where only a single strain measurement type is needed, or for system testing. The command syntax is:

```
vt1413_quick_measure_strain (instrumentHandle, list, channels[], number_of_Channels, range, bridge_Type, sample_Rate_Seconds, trigger_Count, data[]);
```

The `instrumentHandle` parameter is a session handle. The `channels[]` parameter is an array of channel numbers (0 - 63) to be configured. The `number_ofChannels` parameter indicates how many channels exist in the `channels[]` array. The `range` parameter sets the voltage range. The `bridge_Type` parameter indicates the bridge type to use. The `sample_Rate_Seconds` parameter indicates the sample rate (between the 0.00001 s and is 32.768E-3 s) for the acquisition. The `trigger_Count` parameter specifies the number of times to trigger a scanlist acquisition before shutting down the trigger/arm subsystem. Lastly, `data[]` indicates the data buffer in where the acquired data will be returned.

The `bridge_Type` parameter has the following possible values:

Name	Value	Description
VT1413_CONV_STRAIN_QUARTER_BRIDGE	0x100	Quarter-Bridge
VT1413_CONV_STRAIN_HALF_BRDG_BEND	0x101	Half-Bridge Bending
VT1413_CONV_STRAIN_HALF_BRDG_POIS	0x102	Half-Bridge Poisson
VT1413_CONV_STRAIN_FULL_BRDG_BEND	0x103	Full-Bridge Bending
VT1413_CONV_STRAIN_FULL_BRDG_POIS	0x104	Full-Bridge Poisson
VT1413_CONV_STRAIN_FULL_BRDG_BEND_POIS	0x105	Full-Bridge Bending Poisson

NOTES

1. The strain readings from the VT1413C are output as strain (ϵ) units.
2. Because of the number of possible strain gage configurations, the driver must generate any Strain EU conversion tables and download them to the instrument when INITiate is executed. This can cause the time to complete the INIT command to exceed 1 minute.

Purpose of the Shunt Enable Command (vt1413_channel_set_enable)

To check if the bridge is operational, a 55 k Ω shunt resistor can be added across one leg of the bridge. A FET switch adds or removes the resistor. When the resistor is added, it changes the unstrained offset voltage on the bridge. The syntax of the command is:

`vt1413_channel_set_shunt_enable (instrumentHandle, channels[], number_ofChannels, shuntEnable)`

The `instrumentHandle` parameter is a session handle. The `channels[]` parameter is an array of channel numbers (0 - 63) to be configured. The `number_ofChannels` parameter indicates how many channels exist in the `channels[]` array. Lastly, `shuntEnable` is a Boolean value that enables or disables the shunt resistor. See the *VT1521-TFB User's Manual* for more information on configuring the shunt resistor.

USING EXTERNAL EXCITATION VOLTAGES

A user-defined external excitation voltage can be used instead of the internal voltage of the SCP. If using an external voltage, the following must be done:

- User-defined bridge completion circuitry must be used
- the internal excitation supply must be isolated from the bridge
- the value of the excitation voltage must be entered into the VT1413C so it can make the correct EU conversions for strain measurements

Connecting the External Supply

Use Figure 3-1 to connect the external supply to the terminal module. Be sure not to connect the external excitation voltage to the “E+” and “E-” terminals.

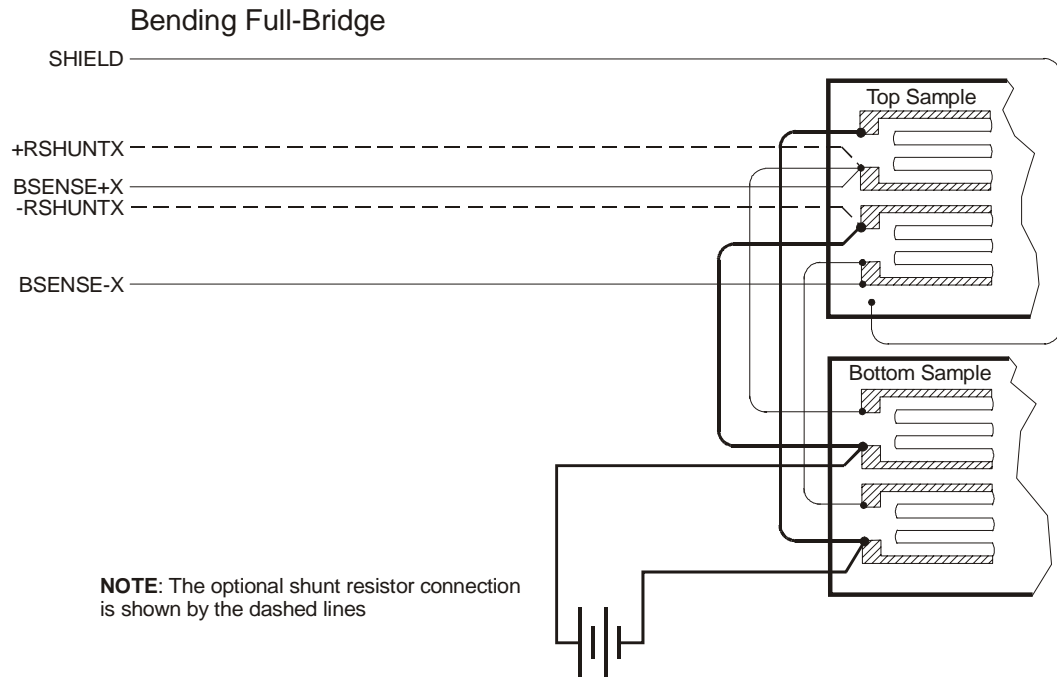

FIGURE 3-1: CONNECTING EXTERNAL EXCITATION VOLTAGES

Enter Excitation Voltage Value (*vt1413_set_strain_excitation*)

Use the `vt1413_set_strain_excitation` command to enter the value of the external excitation voltage. The syntax for the command is:

```
vt1413_set_strain_excitation (instrumentHandle, channels[], number_ofChannels, excitationVoltage)
```

The `instrumentHandle` parameter is a session handle. The `channels[]` parameter is an array of channel numbers (0 - 63) to be configured. The `number_ofChannels` parameter indicates how many channels exist in the `channels[]` array. Lastly, `excitationVoltage` sets the excitation voltage to be used for strain gauge EU conversions.

The default value of the excitation voltage is 3.9 V, the minimum allowable voltage value that can be entered is 0.01 V, and the maximum value that can be entered is 99. However, the maximum allowable input voltage of the input amplifier is 16 V.

NOTE This function does not configure the excitation voltages, only the value used by the voltage measurement to strain conversion.

REGISTER-BASED PROGRAMMING

Appendix D of the *VT1413C User's Manual* covers the register-based commands shown below. Reading this appendix is recommended to become familiar with accessing registers and executing register-based commands. This section relates those commands to the parameter values that are specified for this SCP.

When register programming an SCP, most communication is through the channel registers. For this, use the following register commands:

```
SCPWRITE <regaddr> <regvalue>
      and
SCPREAD? <regaddr>
```

Read (returned value)	Write (<regvalue>)	SCP Register*	<regaddr> Value
SCP ID		Whole SCP Reg 0	00ppp000000 ₂
SCP Gain Scale - (XXX3₁₆)		Whole SCP Reg 1	00pp0000001 ₂
Excitation, Wagner Voltage, and Shunt Cal Resistor: Data format is XEVVVVWS ₂ where: X = don't care E = enable excitation voltage 1=on, 0=off V = Excit. V bits, 0001 ₂ =1 V, 0010 ₂ =2 V, 0100 ₂ =5 V, 1000 ₂ =10 V W = Wagner voltage to LO, 1=connected, 0=disconnected S = shunt cal resistor, 1=in circuit, 0=out		Channel Reg 0	01pp00cc00 ₂
Channel Gain: (FFF ₁₆ =0.5, FFF1 ₁₆ =8, FFF2 ₁₆ =64, FFF3 ₁₆ =512) Channel Gain (direct channels): 0000 ₁₆ =1		Channel Reg 1	01pp00cc001 ₂
Channel Frequency: (XXX0 ₁₆ = 100 Hz, XXX1 ₁₆ = 300 Hz, XXX2 ₁₆ = 1 kHz, XXX3 ₁₆ = 3 kHz, XXX4 ₁₆ =10 kHz)		Channel Reg 2	01pp00cc010 ₂
Excitation Adjustment DAC: 0000 ₁₆ to 0FFF ₁₆		Channel Reg 7	01pp10cc111 ₂
Legend: X = don't care, 0cc = SCP channel (0 – 3), ppp = any SCP (0 – 7), pp0 = any even numbered SCP (0, 2, 4, 6), pp1 = any odd numbered SCP (1, 3, 5, 7)			
* see the SCPWRITE and SCPREAD? commands in “Appendix D” of the <i>VT1413C User's Manual</i> to learn more on how to read the SCP registers.			

CHECKING THE ID OF THE SCP

To query an SCP for its ID value, write the following value to Parameter Register 1:

$$(\text{SCP Number}) \times 40_{16}$$

Then write the opcode for SCPREAD? (0800₁₆) to the Command Register. The ID value will be written to the Response Register. Read the response register for the value. The ID for the first half of the VT1521 is 6300₁₆ and the second half's ID is 6400₁₆.

SETTING THE FILTER CUTOFF FREQUENCY

To set the filter cutoff frequency for an SCP channel, write the following SCP channel address to Parameter Register 1:

$$200_{16} + (\text{SCP number}) \times 40_{16} + (\text{SCP channel number}) \times 8_{16} + 2_{16}$$

Write one of the following cutoff values to Parameter Register 2:

000016 for 100 Hz, 000116 for 300 Hz, 000216 for 1 kHz,
000316 for 3 kHz, 000416 for 10 kHz

Then write the opcode for SCBWRITE (0810₁₆) to the command register.

SETTING THE CHANNEL GAIN

To set the amplifier gain for an SCP channel, write the following SCP channel address to Parameter Register 1:

$$200_{16} + (\text{SCP number}) \times 40_{16} + (\text{SCP channel number}) \times 8_{16} + 1_{16}$$

Write one of the following gain values to Parameter Register 2:

FFFF₁₆ for 0.5, FFF1₁₆ for 8, FFF2₁₆ for 64, FFF3₁₆ for 512

Then write the opcode for SCBWRITE (0810₁₆) to the command register.

SETTING THE EXCITATION, WAGNER VOLTAGE, AND SHUNT CAL RESISTOR

To set the excitation voltage for an SCP channel, write the following SCP channel address to Parameter Register 1:

$$200_{16} + (\text{SCP number}) \times 40_{16} + (\text{SCP channel number}) \times 8_{16}$$

Write one of the following values to Parameter Register 2:

FF00₁₆ for 0 V, FF44₁₆ for 1 V, FF48₁₆ for 2 V, FF50₁₆ for 5 V, or FF60₁₆ for 10 V

To connect the Wagner voltage to the LO terminal, simply add the value 0002₁₆ to the excitation voltage code sent in the procedure above.

To shunt the bridge with the cal resistor, add the value 0001₁₆ to the excitation voltage code sent in the procedure above.

Then, write the opcode for SCBWRITE (0810₁₆) to the command register. The values above will set the stated excitation values as well as the state for the channel's Wagner ground and cal shunt resistor.

ADJUSTING THE EXCITATION DACS

There is a DAC to adjust the excitation level a small amount on each channel.

To set excitation DAC for an SCP channel, write the following SCP channel address to Parameter Register 1:

$$200_{16} + (\text{SCP number}) \times 40_{16} + (\text{SCP channel number}) \times 8_{16} + 7.$$

Use the channel number + 8 for the SCP channel number (the DACs are on the second half of the VT1521).

Write the DAC value to Parameter Register 2. Valid values range from 0000_{16} to $0FFF_{16}$. Calibrated excitation voltages usually occur with values in the range of 600 to 800 (decimal). Then, write the opcode for SCBWRITE (0810_{16}) to the Command Register.