

Discriminating Metal Detector

Signum MFT 7272M



Attention!
Please read
this manual
thoroughly.

Instruction Manual

Contents

| | |
|---|----|
| GENERAL INFORMATION | 4 |
| GENERAL DESCRIPTION OF THE DEVICE | 4 |
| PACKAGE CONTENTS | 5 |
| TECHNICAL SPECIFICATIONS | 5 |
| GETTING STARTED | 6 |
| POWER SUPPLY | 6 |
| CONTROLS AND CONNECTIONS | 7 |
| DISPLAY SCREEN | 9 |
| SENSITIVITY CT, PB SENSITIVITY / CT VOLUME | 9 |
| GROUND BALANCE | 10 |
| DISCRIMINATION SEARCH MODE AND SETUP | 14 |
| SEARCH MODE “ ALL METAL “ | 15 |
| DYNAMIC AND STATIC MODES OF OPERATION | 16 |
| MODE “TURBO” | 17 |
| MODE “ECONOMY” | 17 |
| MODE S ALGORITHM | 17 |
| MULTI-FREQUENCY | 18 |
| PARAMETER MENU | 19 |
| ADDITIONAL MENU (ADD. MENU) | 22 |
| USER PROGRAMS | 23 |
| USING THE HODOGRAPH FOR IDENTIFICATION | 25 |
| SEARCHCOIL REPLACEMENT | 26 |
| SEARCH AND IDENTIFICATION METHODS | 26 |
| SEARCHING FOR LARGE/ FLAT NON FERROUS TARGETS WITH A HIGH VDI ANGLE | 30 |
| EXAMPLES OF SOME COMMON TARGET VDI's | 32 |
| WARRANTY INFORMATION | 33 |
| QA/QC CERTIFICATE | 34 |

GENERAL INFORMATION

Metal detector SIGNUM MFT 7272M is designed to search for and identify metal objects in the dielectric (dry sand, wood, etc.) and low conducting media (soil, brick walls, etc.).

Some applications of use are:

- Criminal;
- Engineering;
- Housing and community services, construction and fire-fighters to search for underground utilities, pipelines, cables, manhole wells etc.
- Archaeology and treasure search.

The device is designed to operate under the following conditions:

- Ambient temperature from -20 up to +50°c (-4 to 122 F);
- Relative humidity up to 98 per cent at temperature of 25°c (77 F);
- Atmospheric pressure from 630 to 800 mm Hg.

GENERAL DESCRIPTION

The Signum MFT 7272M is an eddy current selective metal detector that works on the principle of induction balance. The main distinguishing feature of this model is the use of its original software and hardware. Our multi-frequency technology (MFT) allows the use of any search coils manufactured by us, regardless of their operating frequency (Hz). That is, the device itself will make adjustments and calibrate to the selected coil.

The device uses the original technology of signal processing sensor-technology space and harmonic filtering (SFT), minimizing the hindering effect of ferrous soil (salinity) and, thereby, increasing the reliability of the identification of deep and small objects.

Basic search mode – Dynamic search mode, i.e. detection of an object occurs with constant motion of the search coil.

To pinpoint the exact location of the detected object the device has a static mode of operation (Pinpoint).

The device has 2 methods for identifying the object detected:

- Audio programmable multi-mode,
- Visual (Hodograph, VDI value, rating (level) signal-RS).

The device has two independent search channels: RT and ST.

The RT channel (real time) works in real time, i.e. sound indication is given simultaneously with the movement of the search coil over the object. Sound indication in this channel is a single-tone signal, volume and frequency of which can change when an object approaches the search coil. Also using the duration of the tone we can get an estimate of size of the target detected.

When the received signal from an object exceeds the specified RT threshold, the channel generates the ST audio or short tone.

Channel ST (short tone) is the audio identification channel for the type of object detected. When the received signal exceeds the threshold of the RT channel the detector issues a short audio tone (ST), and the screen displays the hodograph (vector time curve) of the detected object.

The frequency of the short tone indicates the type of object detected (high tones – non ferrous metal, low tone - ferrous metal). The number of tones can be specified by the user (the default is 4 tones).

Each channel has an independent adjustment of its sensitivity. The sensitivity of the RT and the sensitivity of ST.

The RT channel has a higher sensitivity than the ST channel and its main objective is to locate the object and alert the operator that there is something there.

The Signum MFT 7272M is equipped with mode (Turbo). This is a high coil current mode, which is used to improve response from good signals at depth.

There are also 4 custom user programs.

The detector is equipped with a manual or automatic ground balance system with the ability to adjust auto track rate (APB).

PACKAGE CONTENTS

| | |
|---|-------|
| • The electronic unit with a telescopic pole | 1 ea. |
| • Search coil - eddy current transducer (ECT) | 1 ea. |
| • Magazine for 6 batteries (type AA)* | 1 ea. |
| • Operators Manual | 1 ea. |
| • Headphones** | 1 ea. |
| • Carrying Bag** | 1 ea. |

*) batteries sold separately

**) purchased separately or as an option.

TECHNICAL SPECIFICATIONS

The maximum detection range of metal objects

(air test with coil Ø260mm DD) via RT:

- 25 mm dia. coin - 60 cm (23.5 in);
- Helmet - 150 cm (59 in);

Display modes:

- Audio, 5 modes (RT, RT-M, RT-ST, RTL-ST, STP);
- visual (LCD display with a resolution of 128x64 pixels).

Search modes:

- All metals;
- sectored discrimination with 2 ° step.

Control modes:

- Dynamic programmable;
- Static with adjustable threshold.

Power Supply: - 6 batteries (type AA (LR6));

Continuous operation time: - 16-18 hours in normal mode, 6-7 hours in Turbo mode

(Rechargeable batteries 2500 mAh) - up to 40 hours in economy mode

Overall dimensions, mm:

- Telescopic rod - 1200 (Max.);
- Electronic unit - 120x70x115;
- Search coils - Ø 260 mm, Ø 380 mm, 150x260 mm, 240x320 mm

Weight of the device: - 1300 g (without battery)

The device allows the ability to work in water depths of up to 15 meters, without submerging the control box.

GETTING STARTED

Assemble the metal detector. To do this:

- install the appliance in a metal bar;
- tighten the Collet Chuck;
- install the inner (plastic rod) sensor;
- install the rod with the sensor in a metal bar to desired length, using the tabs and holes in the rod
- tightly and evenly wrap the sensor cable around the rod. Freely hanging cables can Cause falsing;
- connect the sensor connector to the electronic unit.

WARNING! *Do not over tighten the attachments and fittings for the telescopic shaft. This applies in particular to the plastic bolt for the search coil and shaft collets.*

Thanks to a specially designed three-knee construction shafts do not need to be disassembled for transportation, simply push the knee shafts into each other all the way and the device is ready to be carried compactly (fig. 1)



fig 1

POWER SUPPLY

The device is powered using 6 AA batteries or 6 rechargeable NIMH. Rechargeable batteries and charger are not included and must be purchased separately. We recommend that you use NIMH batteries from SANYO, ANSMANN 2500 capacity-VARTA or 2850 Ma/h. The use of standard alkaline batteries is possible but not cost effective as the rechargeable batteries pay off after 4-5 recharges.



When using batteries, with a capacity of 2500 Ma/h, continuous operation is approximately 16 hours in the main mode and 6-7 hours in Turbo mode.

Several recommendations on the use of nickel-metal hydride batteries:

-Avoid fully discharging the batteries with each cycle use as this shortens their lifespan. Slight "memory effect" is eliminated by one complete discharge approximately once a month.

-After extended periods, of storing the device, it is usually good practice to fully discharge and charge the batteries a total of 4-5 times.

-Remember that due to the self-discharge nature of the batter capacity falls (by About 5% per day, so it is advisable to charge batteries before each use.

-DO NOT use rechargeable batteries that have different capacities in the same set.

WARNING! *When connecting the battery magazine to the device connector insure the battery is properly connected (polarity is indicated on the battery cartridge) and insure the voltage source is correct. In the case of incorrect polarity or improper voltage the device can be damaged*

CONTROLS AND CONNECTIONS

Appearance of the device is shown in Figure 2.

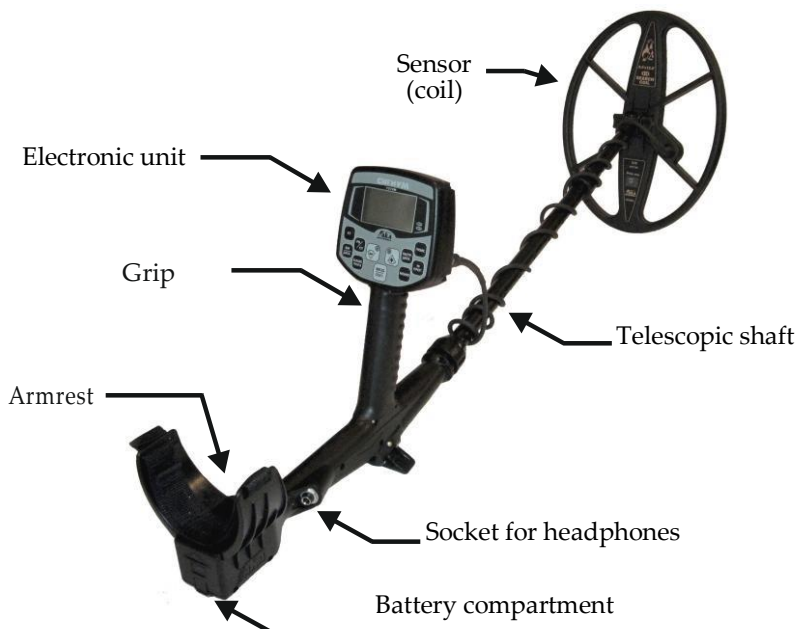

Fig. 2

On the rear panel of the device are the coil connector, on/off switch and the serial number of the device (fig. 3).

Located on the front panel are the LCD graphic display (with a resolution of 128 x 64 dots) and 11 touchpad controls (fig. 4).



Fig.3



Fig. 4



Sets the sensitivity of the ST (short tone) channel



Sets the sensitivity of the threshold RT channel (Real Time)



Sets the volume of the audio



Select the Discrimination edit mode



Switch between all metals/discrimination



Navigate through the menu and change the settings, also turns the Turbo mode on/off.



Move through the menu and change the settings, as well as turn on/off the S Algorithm



Switches between User Programs



Access the Ground Balance modes



Confirms the selected settings. Selects a menu item. In search mode switches between Static and dynamic (Pinpoint) modes. In ground balance mode switches between Auto and Manual GB.



Button to enter the Main Menu

DISPLAY SCREEN

In search mode the display device displays the Hodograph information of detected objects and information about the current operation modes (Fig. 5).

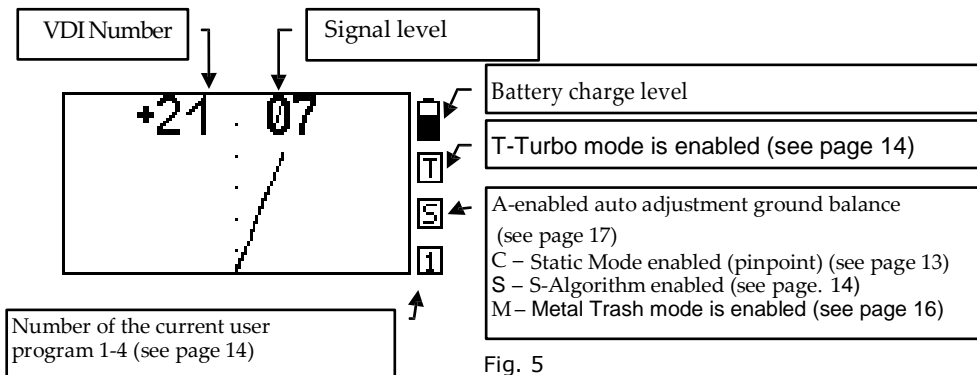

Fig. 5

VDI-number “**Visual Discrimination Indication**”. This is the index of electrical conductivity of the object or the angle between the vertical axis and the predominant direction of the hodograph (time curve). In this case, hodographs which are on the left side of the screen have a negative VDI, and the right - have a positive VDI number. The amplitude of the signal, from detected objects, is displayed in standard numerical units

ST SENSITIVITY, RT SENSITIVITY / VOLUME

This section introduces the three main parameters that you'll use most often. For each of these settings there is an individual button on the control panel.

SENSITIVITY ST [1 .. 14]. Increasing this setting allows you to increase the depth of targets you're searching for, but it reduces the accuracy of identification and increases the risk of false positives. The recommended value is 9-10.

Warning! Setting of the ST sensitivity above 11, and especially 14 can lead to a significant increase in the amount of false positives from the soil in high salinity or when bumping the search coil.

SENSITIVITY RT [0 .. 9]. Adjusts the sensitivity of the threshold or RT channel you hear constantly during the search. The value of this parameter is set as a compromise between sensitivity and comfort. Increasing this value increases sensitivity in the threshold channel. However this can reduce the comfort in searching. Recommended settings are 6-7.

VOLUME [1 .. 9]. This setting adjusts the overall volume of the audio response from detected objects. Select the value based upon individual comfort preference. The current values of these parameters are displayed on the screen above the relative buttons (Fig. 6).

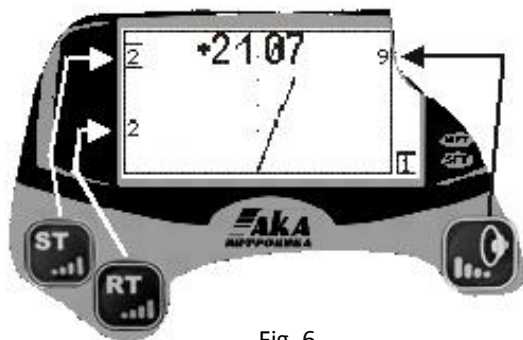



Fig. 6



To change any of these settings press the appropriate button. The value of the selected option is highlighted on the screen with a rectangle around the appropriate value.

Press the button 

Or  to set the required

value. In order to exit the

parameters simply click the button again. When neither the RT, ST or Volume

values are displayed on screen - the buttons  and  will now act as

on / off modes for the Turbo and S-algorithm, (see below)

GROUND BALANCE

Balancing the device to the ground is the single most important part of the device settings for accurate search results. Improper ground balancing can result in decreased responses to targets and may result in instability as well as an increase in false ground signals.

To explain the basic physics behind the ground balance procedure. Every object has its own shape, conductivity and magnetic component, which together are called the VDI (Visual Digital Index). Remember that the VDI is the angular response that is numerically equal to the angle of deflection of the signal vector time curve (hodograph display) on the vertical axis. The soil, or ground, depending on the degree of mineralization (presence of iron oxides) imposes its signal on the target signal thus changing the VDI upscale. This is especially true on small or deep targets, as well as large highly conductive targets (copper, silver, aluminum). This can actually push these high VDI targets up and over into the high negative VDI range known as “VDI wrap around”. To minimize this effect, it is crucial to perform a proper and accurate ground balance procedure.

The basic objectives of balancing:

1. **Make the soil 'invisible' to the instrument, i.e. exclude false signals from the ground where there is no target.**
2. **Install the correct (standardized) reference system number for the VDI. When receiving a signal from both the ground and a detected object the detector must subtract mathematically the signal from the ground in order to display a correct VDI indication of the detected target**

Keep in mind that when performing “air tests” inside after the detector has been previously balanced in soil may result in incorrect VDI readings. This is due to the correction factor for the VDI previously set in the last ground balance. This may result in the loss or “invisibility” of large aluminum, silver and copper targets. If the ground setting is too positive the VDI will be offset positive and vice versa if the ground balance is negative.

This may also lead to targets air testing as iron, as well as a false increase in sensitivity when air testing.

Remember that for every 1 degree of ground balance offset from the 0 or neutral point we get a corresponding increase or decrease in the VDI scale for a given target. IE a 1 degree+ ground balance will increase the VDI by +1.

For example, if you are air testing a large copper coin that would normally give a VDI of +82 to +84 but is now air testing with a VDI of -86. The result is that the device ground balance is set +10 to +12 degrees too positive for performing an accurate air test.

Balancing with a piece of ferrite is required before performing an "air test" of the device. Put the device on a non-metal surface, turn on automatic ground balance mode, count to three, then bring the ferrite to the center surface of the coil from a distance of 25-30 cm (10"to12") to complete the balancing procedure. Puzzled? Let's make it easier: Take a CD and pass it flatwise in front of the search coil.

If the CD gives a vertical hodograph and VDI of 0 (+1 or -1), then the device is ready for "air" tests.

If the VDI of the CD differs from these values, then in auto GB click  (to enter manual GB) and adjust the phase of the ground balance in the desired direction. When the VDI of the CD is at 0 (+1 or -1) your device is ready for air testing.

BALANCING PROCEDURE.

We would like to bring your attention to the automatic balancing procedure developed by experienced users.

1. Find a metal-free area. You can find it by the threshold tone response in RT mode. On an unbalanced device there will be a response to the clean ground, however the sound will be soft and "diffused", without a strong localization. While the sound would be sharp and with a strong increase in sound above a metal object. Select an area with no localized sharp threshold tone increase while swinging the search coil 5-10 cm to the left and to the right above the ground. If there is no localized sharp threshold tone increase then the area is suitable for balancing.
2. Having found the metal-free area, raise the coil 30-40 cm above the ground

press  wait for 3 seconds, and move the coil to the ground smoothly but not too slow.

Warning! Do not move the coil to the ground closer than 10% of the search coil diameter (for the searchcoil $\varnothing 26$ cm – 2-3 cm). This is related to the change in the pattern of the search coils physical interaction with the ground in what is called the "Close Zone" and it may impact balancing accuracy resulting in false responses in clean areas with high levels of sensitivity.

A short tone (Hum) signifies the completed balancing procedure. If there is no tone or it does not sound during lowering, but sounds when moving up, repeat the procedure with the same formula: 30-40 cm above the ground, 3 seconds, and then lower the coil to the ground. Follow the ground vector on the screen during the process. Its shape should be a strait, slightly trembling line, on the horizontal axis of the ground scale.

If it makes sharp angles or is “chaotic” on the screen, this means that you are trying to balance near a metal object in the ground. In this case, the device may perform a ground balance, however it will be incorrect and you will notice multiple false signals from the ground. If this occurs, simply re-balance the detector in an area clear of any metal targets.

Once you have chosen a clean location to balance the detector and have done so, note the value in the lower left hand corner of the ground balance screen. Now, should you chose to ground balance again later on and there is a sharp difference between this value now, as compared to the previous ground balance, there is good reason to suspect that there was metal close by and you will need to ground balance again.

If the coil all the same was a metal object, giving an automatic balance (items with VDI close to 0, e.g. foil), the device will give two consecutive tones, similar in tone to that of iron in the search mode, while at the same time the screen will display an exclamation point within a triangle. Accordingly, you will need to ground balance again on a clean spot of land.

After balancing, in the lower left corner of the screen will display a numerical value of balance (phase), this is the amount by which the device will adjust the VDI, excluding the effect of the soil.

In the right corner of the screen it should be noted that the average phase angle ground balance is different for each instance of the device and can also depend on the technological variability in parameters of the coil and the ambient temperature.



However do not forget that your device remains in the automatic balancing mode and at any moment may deem it was time to rebalance to your shovel, boots, or hunting partner. If you want to review the results and values of the current automatic

ground balance procedure press  to enter manual mode and disable automatic

balancing. In the upper right corner of the screen will appear M instead of the letter A. To

exit the ground balancing, click  on the instrument panel. Switching between modes

is as simple as performing successive clicks of  While in the manual balance

mode by pressing  or  one is able to adjust

the ground balance in the proper direction. Bob the coil vertically above the ground (rising to 20 -30cm / dropping by 3-5cm), making sure that the vector of the soil is along the horizontal axis and that the hum is gone when raising or lowering the coil.

Vector of improperly balanced soil (fig 7)

Vector of properly balanced soil (fig 8)

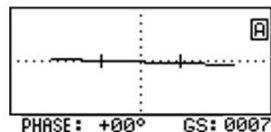

fig. 7

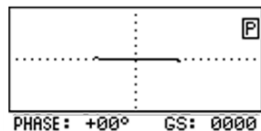



Fig. 8

When working on the ground with uneven salinity, such as arable land, it is not always possible to accurately ground balance the unit in automatic mode. This can be due to the uneven or lumpy nature of the soil. This can sometimes leads to false responses from the identification channel. In this situation the phase of the ground balance can vary by more than 3

degrees. If you encounter this problem then perform the ground balance procedure as follows.

Find a clean patch of ground with a width of 60 centimeters. Switch to manual ground balance and making short horizontal search sweeps with a width of 50cm at a height 3-5cm above the ground, you will see a straight line on the ground the screen (if the line jumps, then there is metal present). In this case, if the balance is wrong, you will hear a buzz from the soil and the soil line on the on the screen will not be horizontal.

Press  and  until the line is horizontal and the buzz disappears.

Your device is fine-tuned to the ground.

For a small increase in the depth of the identification of large silver and copper coins (kettles, basins and other large pieces of highly conductive metals) it is possible, after performing automatic ground balancing, to enter the manual balance mode and set the GB point from -1 to -2 from the automatic GB reference point.

Care should be taken when setting the ground balance point either negative or positive. When set negative it increases the possibility of receiving false positive responses when bumping the coil on vegetation or the ground. When set positive you risk the chance of losing sensitivity to large silver or copper coins that will either become “invisible” or ID as iron.

In the event that a “clean” patch of ground is not found you can excavate a small amount of local soil (1-1.5 kg), removing all metal objects, and place in a bag for convenience. Now lean the detector with the coil facing up against a bush or tree with the coil at least 40-50cm off the ground. With the bag of soil in hand you can now and press

 and count 1,2,3. Then smooth and slow, (starting from a distance of 30-40 cm) present the soil to coil. (As if doing auto balance on the ground in the normal mode, but now you are moving the soil to the coil instead of vice versa)

Placing the excavated soil on the ground is not desirable. Since you were not able to perform a ground balance previously, due to the presence of metal in ground, placing the bag of soil on the ground may cause an incorrect ground balance.

Attention! If the signal from the ground is too small (such as quartz sand) and the auto balance cannot be performed then the balancing procedure can be performed either by using a piece of ferrite or a piece of red brick. These can be placed on the ground and the auto balance procedure performed. In principle, using the procedure for balancing for “an air test” will also work and you may set the balance point 1 or 2 degrees negative if you are searching for large objects.

Sharp temperature changes on the search coil may impact balancing accuracy, the balance may shift and become incorrect with such changes. That is why, if you take the device from a heated car and start working in a low temperature conditions (early spring, late fall), rebalance one or two times while the coil adapts to the ambient temperature.

In case of large temperature drops of more, than 15°C (compared to a normal air temp of 20C), we recommend that you perform electronic module and search coil

adaptation procedure one more time (see Search coil Replacement). In this case the processor of your detector will choose the optimum frequency of the excitation current for the current temperature conditions.



In saltwater beach operations and other complicated soils with high conductivity we recommend you use the "Economy Mode" option for better ground balance accuracy. Sometimes decreasing sensitivity will allow for a more accurate ground balance especially on beaches.

In rare cases, such as after replacement of the coil or attempting to balance on a metal object, a situation may arise when you cannot perform an automatic ground balance.

This occurs because the current value of the phase vector moves out of the locked system acquisition sheet (such as a significant change in ambient temperature).

You can solve the problem by balancing in manual mode. To do this, while

in the automatic balancing press the  to go to the

manual mode and using the buttons  and  get the vector of the ground signal moving from left to right in strictly the horizontal direction. After that, the balancing procedure will operate normally.

DISCRIMINATION SEARCH MODE AND SETUP

Discrimination is the ability of the device to respond to certain types of objects and ignore the others. For example, you can configure the appliance so that it will respond only to objects of non-ferrous metals while ignoring everything else. In some cases, this allows you to increase the comfort of the search. Be aware, however, that the more discrimination that is used there is an increased risk in missing valuable objects. In any event, the choice is yours.

The discrimination range is set to the position and width of the search sector.

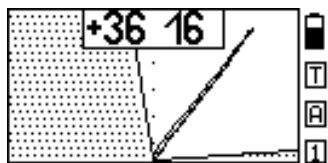

fig.9

The metal detector will respond only to those objects that have travel time curves (Hodographs) which fall between the left and Right border sector. For example, to search for non-ferrous objects your sector search screen may look like that in Fig. 9.

Pressing Button  allows the user to quickly switch between modes "All Metal" and "Discrimination" and then back again.

The sector on the screen indicates that you are in a discriminatory setup. An Audio response will occur only on those objects that fall in the clear Hodograph area while targets that fall within the hatched area will not generate an audio response.



To configure the discrimination, click. Now, by positioning the left and right edges of the search sector you can set the desired area (level) of discrimination.



At the top left and top right of the screen are the current values of the search sector. These are in degrees of inclination relative to the vertical axis of the screen.

The currently selected border sector is highlighted by a rectangular frame (fig. 10).



fig. 10

To change the position of the border sector

use the search buttons  and 

To set up another border sector

Click. 

As already noted in the discrimination mode, due to the influence of the soil, there is a risk of missing objects if the search sector borders are set too narrow.



To exit discrimination click

SEARCH MODE “All Metal”

Using the search mode "all metal" as opposed to "discrimination" mode you can detect any metal objects whether they be ferrous or non-ferrous.

Which mode is best to use is a personal preference.

However, it should be noted that searching in the discrimination setup can miss some of the weaker signals from good targets. This is due to the effect of the soil on the vector signal of the target and causes the signal to go beyond the search vector boundary.

The disadvantages of the "all metal" mode can include difficulty working in trashy areas due to the extreme amount of signals and sounds received. Since the sector boundaries in the "all metal" mode are fully open, it may be full of signals from so called "hot rocks". The detector will issue high-pitched signals from these objects. This is useful for finding stones of meteorite origin. Identifying these "hot rocks" can be done by noting the high ratings from the VDI (+86) and the stretching of the signal. If these are bothersome you may use the discrimination mode and set your sector boundaries at -86 to +86 respectively. This will act much the same as "all metal" accept with the elimination of the "hot rocks". You may also use the algorithm suppression "Disc. of Hot rocks" (see page 15).

DYNAMIC AND STATIC MODES

Dynamic mode is the main mode of operation of the detector. It is characterized in that the processor constantly adjusts to relatively slow changes in ground conditions. Therefore, in this mode, the instrument responds to the desired objects only when moving the coil. If the coil is stationary over an object, then after a while the sound will disappear. This is the primary mode your detector is in every time you turn it on.

Static mode is used as an additional and serves mainly to clarify the location of the found object (Pinpoint). Unlike dynamic mode there is no constant adjusting and therefore, it is not intended for

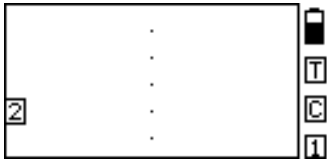



Fig. 11

a lengthy search. To switch the appliance from the basic search mode to static mode (Pinpoint)

Click.  In the right-hand side of the

Screen there will appear the letter "C", and on the left the value of the gain for the static mode along with the ability to change this parameter by using the buttons

 and  (fig. 11).

The gain of the static mode is selected experimentally depending on the specific conditions. The choice of this parameter will depend on the relief of the ground, littered area, temperature changes, etc. We recommend starting values of 6-7.

As already mentioned, the active mode (pinpoint) is used to determine the the exact location of the object.

Let us give some practical tips on how to Use this mode.

After locating an object, in the static mode, and deciding it is worth digging it is time to define its exact location. To do this, move the search coil off of the approximate center of the target either left or right (line A see Figure 12). Then turn on the static mode (Pinpoint).

As accurately as possible, while maintaining the distance between the ground and the coil, scan the object backwards.

Determine on line A the location (coordinate) where the tone of the sound was the highest.

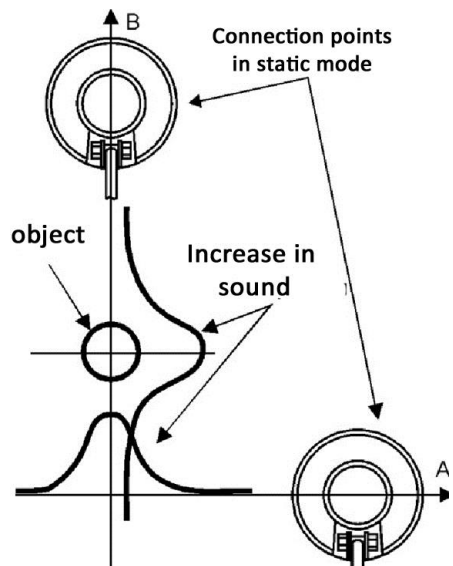

Fig.12

Then move the coil away from the target perpendicular to the primary direction (A) scanning (e.g. forward) along this line.

This retraction of the coil in this direction must pass through the original coordinate. Re-enable the static mode. Scan the object along the line as accurately as possible keeping a minimum distance between the ground and the sensor. The recorded coordinate of the maximum frequency tones sound on line B, will determine the exact location of the object.

To return to the dynamic mode press the button again



MODE “TURBO”

In the "Turbo" mode the search coil operates at the forced excitation current. This mode allows you to increase the sensitivity of the device and to improve the immunity of the device from external electromagnetic interference.

Attention! The “Turbo” mode greatly increases current consumption and as such battery operating time is greatly reduced!

Switch to TURBO and back by using the button



while in search mode. It is necessary to ensure that the settings ST/RT sensitivity and volume on the display screen are not displayed.

MODE “ECONOMY”

In the "Economy" the sensor operates at the minimum excitation current. This mode allows you to improve the comfort of your search on soils with a complex and variable salinity (for example in the surf of the beach), or at locations with extreme iron debris.

Attention! After switching to “Economy” mode it is advised to ground balance the device.

For reference, the detection range in this mode, when air testing a large 43cm copper coin, such as a Victorian Penny, is approximately 35cm (10” DD coil @ 6,5-7 kHz).

Thanks to the significant reduction in the consumption of power in this mode you can run up to 40 hours on a set of fully charged batteries.

Switching to the turbo is made through the "Extras" Menu, section "Extra Settings""(see below).

MODE S ALGORITHM

From our experience we know that the majority of metal detectors react to flat iron objects as nonferrous. To assist in solving this problem the specially developed S algorithm is used to assist in properly identifying these targets.

The most effective use of this algorithm is in identifying small flat iron objects (15 cm2), such as beer caps, rusted pieces roof tin, etc., with a signal rating greater than 10.

If the device detects an object with a "questionable" non-ferrous signal (high tone) and it has a rating over 10 then using the S-Algorithm can help to identify these type targets.

There is no need to use this algorithm for a definitive low-pitched signal, i.e. when the subject is clearly iron. Remember though, to monitor the signal rating level of the target.

It should be pointed out that this mode does not apply to general searching, but only to help clarify the type of metal of a non-ferrous response and to decide on the need to dig.

The S Algorithm has virtually no effect on the hodograph display of non-ferrous targets

It should also be noted that when increasing the surface area of iron objects the effectiveness of the S-algorithm decreases.

To switch to this mode, use the button , the values of the parameters RT and ST sensitivity and volume should be displayed.

To return to the main search mode press the button again. 

MULTI-FREQUENCY

You may be interested to know that most of the detectors manufactured in the world will have a comparable sensitivity, for example, a brass disk with a diameter $\varnothing 25$ mm and copper disc at $\varnothing 50$ mm, despite the fact that the second object is much larger. It is also known that small targets (coins) are detected better at higher coil excitation frequencies.

The fact is that by the virtue of certain physical laws each target class has its own optimal frequency at which the sensitivity to these targets are maximized. In order to give the unit the opportunity to search effectively for both large and small targets, many manufacturers produce 2, 3 or 4-frequency metal detectors. The Signum MFT 7272M allows you to work with coils with the operating frequencies from 1 to 30 kHz, thus maintaining acceptable sensitivity to almost any type of target.

The metal detector can be equipped with the following sensors: 15DD -3 (7) kHz, 9.5 x12, 5DD - 7 (3, 14) kHz, 10DD - 7 (3) kHz 6h10DD - 7 (14) KHz.

What could be the practical guidelines for choosing a coil with a different operating frequency?

3 kHz can be successfully used on non-trashy areas to search for both ferrous and non-ferrous targets as well as the spoils of war.

7 kHz –Is the average universal frequency for a wide range of applications. You can search for both medium and small coins as well as the spoils of war. This frequency is convenient for terrain reconnaissance.

14 kHz - Frequency optimized for small and medium-sized coins especially when the latter are located on edge. This frequency is the best choice for hunting on the saltwater beach.

PARAMETER MENU

By pressing the button  you have access to a number of additional parameters, which are divided into 3 groups (Fig. 13). Navigating the menu

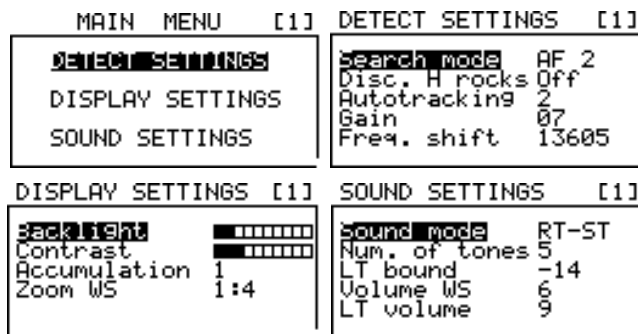

Fig. 13

By using the buttons ,  and 

The value in the upper-right corner of the screen indicates the user program number that you are currently editing.

SEARCH OPTIONS

Conv. Search. [Normal. (Normal), MM (metal trash), AF1 (Filtering algorithm), AF2, AF3] These options are designed to optimize the operation of the device under normal conditions, under various degrees of trash within the search area, as well as under various amounts of electromagnetic interference.

Trashy is defined as an area where the distance between small metal objects (nails) is 1/2 the diameter of the coil.

To work in these areas use the MM. Otherwise, we recommend you use the mode "Normal."

Mode MM is characterized by a fast algorithm for the signal processing, although there is a nominal loss in sensitivity (30%).

When searching in areas of tall vegetation or in plowed fields with an uneven surface it is inevitable that bumping of the coil will occur. In these situations, it is recommended that you use the search modes "AF1, AF2, AF3", where "AF" indicates the presence of an additional filtering algorithm of the signal. These modes can also be useful in areas with high levels of electromagnetic interference (EMI). However, it should be remembered that such filters may slow down the detector process speed. Which AF mode is best will depend on user experimentation in the local area.

DHR (Discrimination of "hot rocks") [On. / Off.]. This option includes the ability to suppress the sound response in the (ST) channel to the hot rocks (HR). We can describe these as rocks with a high ferrous content. Because of the physical features of the interaction of the Coil with the "HR", the reaction to them is often confused with the reaction to large copper or silver coins. This algorithm helps to distinguish between these two types of responses and to eliminate the audio response to the Hot Rocks.

Optionally the software can be switched off. The inclusion of DHR is reflected on the screen in the form of an inscription of "HR" in the upper right-hand corner under the low-battery indicator. Reaction to these in the RT channel remains.

Attention! The algorithm is turned off automatically in the program "MM1" and "MM2"

Speed of Auto tracking AGT [off/1 .. 6]. This option allows you to set the speed limit of the auto tracking of the ground (not to be confused with balancing on a ground). Auto tracking allows the device to automatically adjust to the slow changes of temperature and salinity of the soil. It should be noted that this action should in no way replace the procedure for ground balancing, and only adjusts the balance of soil in small amounts during the search. In some cases (large amounts of metal trash or a cluster of hot stones) APB may not work properly. In these circumstances, you should disable the APB.

Attention! If the device has not been used for a long time, for correct operation of APB it is necessary to ground balance

Gain [1..10] This parameter is used to set the sensitivity of the device in the Real Time and Identification channels at the same time. In most cases, we recommend that this value is not set to more than 7. Smaller values can be useful, for example, to search for large objects that are not deep or in trashy areas.

Shift Frequency [-5. .. the Central frequency of the device. +5]. This parameter adjusts the operating frequency shift and is designed to reduce the effect of the mutual influence of devices operating in close proximity to each other. By adjusting this parameter, on both instruments, the users can achieve a minimum influence on each other and improve the comfort of working together at close distances without significant loss of sensitivity and identification.

For a more effective suppression of the mutual influence of two nearby detectors it is recommended to spread their operating frequencies.

Always remember that nearby operating instruments can significantly reduce the search depth.

It is best to choose the level of difference between the operating frequencies experimentally by setting the distance between the devices and testing the sensitivity of the devices.

Remember that the detectors must be located in the same plane, which corresponds to their actual relative position during the search.

Attention! After adjusting the frequency shift of the device remember to perform the ground balance procedure

DISPLAY SETTINGS

Backlight. Allows you to change the brightness of the screen. The far left light indicator corresponds to the complete shutdown of the backlight. Remember that too much backlight level reduces the operating time of the battery life.

Contrast. Sets the desired level of contrast of the display.

Accumulation [1..4]. Option allows you to store the display from 1 to 4 hodograph images simultaneously. Displaying multiple hodographs may be useful, for example, in the analysis of responses from the same target while scanning from different angles or directions.

Zoom WS (Zoom weak signals) [1:2/1:4/1:7]. This option was designed to increase the capabilities of visual hodographic identification. It allows to increase sizes of weak signal hodographs as well as to evaluate the signal level by the size of the hodographic picture. For instance, setting to the 1:2 scale you can increase and thoroughly examine a low-signal hodograph. Scaling 1:7 you can evaluate signal levels in a wider range by the size of the picture respectively.

SOUND SETTINGS

Sound Mode [RT/RT-M/RTL-ST/RT-ST/ST-P] There are 5 types of sound modes.

RT [Real Time]. In this mode the audio output is in sync with the movement of the coil. As the coil approaches the target the audio rises and as it leaves the audio falls respectively. This type of display allows for a maximum depth of detection without any type of audio of the type of the object (all targets of a single tone). Real-Time is used when you want to search for deep targets, for example to search for military items.

RT-M [Real time-Multifrequency] This is a single channel (RT) search mode with tone or audio ID. This differs from other audio ID modes in that the ST channel is not used. We can think of this as Threshold tone ID. Audio response is in real time while searching and can provide more target information than may be available in the ST modes especially under certain target rich environments. The number of tones can be set in “No. of tones”, and may be set from 2 to 4.

RT-ST [Real-Time - Short tone]. This is the preferred sound setting. Sound indication of the object occurs in 2 stages. Real time sound appears first (RT) with a medium tone, and then, after the object is identified the RT threshold tone is replaced by the ST tone of an appropriate frequency. The duration of the tone can be changed using the **Duration ST**.

RTL-ST [Real time before the threshold - Short tone]. Along with RT-ST this is the other main type of sound indication. Different from the RT-ST this setting is characterized by the fact that when the ST tone is generated the RT tone drops out. This setting will help with audio overload to the user when detecting in trash or in areas with many targets.

ST-P {Short Tone Polyphonic} Ability to give both a low tone and high tones at the same time. For example, when giving a signal from the small flat iron targets (beer bottle caps, small pieces of sheet metal, etc.).

Num. of tones [2, 3, 4, 5]. Sets the number of tones for audio identification.

LT Boundary (The boundary for the low tone (iron)) This option allows the user to set the boundary for the low tone. In areas of mineralized soil as well as areas with small iron nails, targets such as small shallow gold and other low VDI targets will indicate a negative VDI. Usually these give a signal between the medium-large iron VDI range and foil VDI range. These will not fall completely within the range of iron but also not quite at the range of foil. For example medium wrought iron targets such as wrought iron nails will have a VDI vector of -45 to -40. Foil will have a VDI vector of 0 or close to this. Therefore those targets with a VDI from 0 to -35 are considered “suspicious” and subject to research when looking for small gold jewelry, small medieval daggers or coins within debris. When setting the boundary of the LT remember these facts in order to not miss valuable targets when searching under these conditions. So, if we receive a good tone, even if the hodograph indicates a loop, with 95% confidence we can say that this is possibly a good non ferrous target. Together with the separation rate of the MM search mode this setting will increase your chances of not missing a non ferrous target mixed in the iron. Try to set the border for

these lower tones appropriately. If you perform a search in places where the medium/large iron can be interesting (Arrowheads, knives, medieval items etc.) you can move the non-ferrous tone to the sector border where the majority of large iron indicates at -45 (-50 possible maximum).

Volume WS [Volume of weak signals 1-9] Adjusting this parameter allows you to change the volume of the ST from weak signals from small or deep targets. Smaller values of this parameter can control the level of the volume signal for a wider range of target depths. However, at very low settings signals from small or extremely deep objects can be too quiet. Very high settings will reduce the differential volume level between deep and shallow targets. Therefore, the value of this parameter is selected experimentally, to individual user preferences.





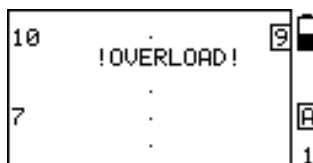





Volume LT [1..9]. Parameter adjusts the volume of targets within the setting of the LT border (iron). Sometimes it is useful to reduce the volume or even mute the sound from iron in order to make the search more comfortable. This parameter value is selected based on the personal preference of the user. The value of Fe-9 Volume adjusts the volume levels of iron and non-ferrous objects.

In the case of overloading the electronic circuit due to large or shallow targets under the coil the device will issue an audible and visual alarm overload.



ADDITIONAL MENU (ADD. Menu)

The menu is in addition to the main options menu, this sub-menu extends the capabilities of the sound and the display options as well as an option to adjust the auto-tuning of the balance to the soil.

To enter the sub-menu, press and hold down  Navigate the sub menu options by using the buttons  and . Selecting a menu item and enter the submenu by pressing the button . Navigate the parameters of the selected sub-menu by the buttons  and  to select an option use the button.  To change the values in the selected parameter use buttons  and . To exit the sub menu press. 

MENU OPTIONS:

1. Tones Settings RT (**Border 2, Border 3, Border 4, Freq. RT**);
2. Tones settings ST (**Frequency LT, Freq. 2, Freq. 3, Freq. 4, Freq. 5**);

3. Other Settings (*Duration ST, Economy Mode, GS Filter, Rate MM, EMI Filter MM*).

TONE SETTINGS RT

In this menu you can adjust the audio VDI boundaries for the RT tones to suit your particular needs. As well as adjusting the frequency of the audible threshold. You can narrow or spread out the audio range to fit any particular detecting needs.

TONE SETTINGS ST

In this menu you can change the frequency of the ST border tones to fit your personal preferences. The higher the number, the higher the pitch. The lowest tone corresponds to iron, while the highest to the highly conductive metals. Please consider when changing the lower ST tone, that the tone of the channel RT has its own distinct value (adjustable via menu "SETTING TONE "). It is recommended to try and not set the ST tones to the same or similar value as the RT tone as it will become indistinguishable from the latter.

OTHER SETTINGS

Duration ST. This parameter sets the level of the duration of the tone bursts in the Sound Modes RT-ST and RTL-ST. The far left position corresponds to the shortest tone duration.

Economy Mode [On. / Off.] This parameter switches the current excitation level in the coil and allows you to adjust the sensitivity and power consumption to fit different search conditions (see above)

GS FILTER {OFF/1-20} This option allows you to choose the level of suppression of false alarms caused by soil with high electrical conductivity. (saline soils, sea beach, etc.).

This is especially important when using a large-size (10' and 12.5' x9, 5') search coils operating at high frequencies (14-20 kHz) due to the characteristics of the interaction of these coils with highly conductive soils.

It should be remembered that increasing the value of the filtering level increases the comfort of the search, but it can lead to missing deep or highly conductive targets.

The value of the filtering level should be selected experimentally for each particular detecting situation as it is desirable to keep this setting as low as possible while still maintaining a comfortable search level.

RATE MM-Not fully described. This adjusts the setting for the algorithm for targets spaced close together. This may be set experimentally. Current setting of 5 is recommended.

EMI FILTER MM- not fully described. However it appears to be self-explanatory.

USER PROGRAMS

The device provides the ability to edit and save 4 independent search programs. In each program, the user may choose to set the value of any of the available options.

To switch between user programs press button . The currently selected program is displayed in the lower right hand corner of the display. The factory setting values for all 4 programs are shown in Table 1:

Table 1.

| Settings | Prog. 1 | Prog. 2 | Prog. 3 | Prog.4 |
|---------------------|---------|---------|---------|--------|
| Sensitivity ST | 10 | 10 | 11 | 12 |
| Sensitivity RT | 7 | 7 | 8 | 9 |
| Volume | 9 | 9 | 9 | 9 |
| Turbo Mode | Off | Off | Off | On |
| Search mode | AF2 | MM | Norm | AF1 |
| Sound Mode | RT-ST | RT-ST | RT-ST | RT-ST |
| DHR | Off | Off | Off | Off |
| Speed AT (Autotrak) | 2 | Off | Off | Off |
| Gain | 7 | 7 | 7 | 7 |
| Accumulation | 1 | 3 | 3 | 3 |
| Scale of the screen | 1:4 | 1:7 | 1:7 | 1:2 |
| Number of tones | 5 | 5 | 5 | 5 |
| Border LT | -14 | -24 | -24 | -24 |
| Vol. WS | 6 | 6 | 6 | 8 |
| Volume LT | 9 | 6 | 9 | 9 |
| Shift Freq. | Center | Center | Center | Center |

Settings: Backlight, Contrast and Cont. CT directly with the search capabilities of the device are not affected, and can be chosen based on the preferences of the particular user.

However, one should pay attention to two points:

- Unless absolutely necessary, do not place a high value for the Backlight setting, Doing so may reduce the operation time with one set of batteries.
- It is also not recommended to set too high a level for the parameter Duration ST when working in trashy areas, for a clearer separation of closely spaced targets.

Factory default values for all parameters are stored in memory and the user can always go back to them. To perform this you must first turn on the device while at the



Same time holding down the button and hold it until the end of the melody.

Program 1 is designed for easy and comfortable search of shallow objects

Program 2 designed to search in trashy areas. Has a good response, but slightly inferior in sensitivity.

Program 3 is the main program of research, combining the best combinations for a comfortable search with near maximum sensitivity.

Program 4 - for when you want to search at slightly greater depths, however, it is worth remembering that it reduces the comfort of searching, identifying deteriorating properties of the device, as well as the time from one set of batteries is reduced by 2-3 times.

Remember that the default settings are not an absolute, but offered only as a starting point to assist your search. Experiment and we hope that in the near future you will make your own comfortable and effective program.

As we gain experience the company reserves the right, without notice, to change the value of the factory settings.

A very useful practice is to switch between user modes to access changes in menu options. A good example of this is changing “Backlight” settings. To do this there are a pair of identical search programs (1 and 2, 3 and 4) the only difference is the value of the backlight (one pair of programs is on, the other is off). Further, if you need to change the current state of the backlight, no need to go to the menu and look for the desired setting. You can just toggle the search program.

USING THE HODOGRAPH FOR IDENTIFICATION

We have previously mentioned about using the hodograph for identifying targets. But what is the hodograph and what it is for? The received signal is characterized not only by its amplitude and phase, but it is also a vector quantity. Amplitude and phase depend on the electro physical parameters of objects such as conductivity, magnetic permeability, depth, geometry, etc. To accurately describe the nature of the received signal from an object is very

difficult, given the variety of influencing factors. However, it is possible to point out some general patterns. Earlier, we mentioned that the signal is a vector quantity characterized by amplitude and phase. If you hold any metal object to the coil it is evident that the magnitude of this vector will vary. The end of the vector will describe, on a coordinate plane, some shapes (lines, loops, etc.). These shapes are called Hodographs. The latter most closely describes the complex interactions of the coil with metal objects.

When analyzing the hodographs should be remember a few general rules:

- hodographs of small and medium-sized ferromagnetic objects are in the left quadrant (i.e. have a negative vector angle);
- hodographs of objects of non-ferrous metals and large ferromagnetic objects lie in the right quadrant (positive vector angle);
- the larger the area of the surface of an object the higher the electrical conductivity, hence the greater the slope of the hodograph to the right;
- travel times of medium and large ferrous objects, as a rule, have the shape of a loop;
- hodographs of non-ferrous metal objects are mainly straight;
- a properly ground balanced unit will have a vector along the horizontal axis. Examples of the hodographs of some objects are shown in Fig. 14. Thus, analyzing the shape and position of the hodograph, along the coordinate plane, there can be a certain degree of probability as to the identity of the object type. It should be noted that the hodograph examples given are idealized and do not take into account the effect ground mineralization.

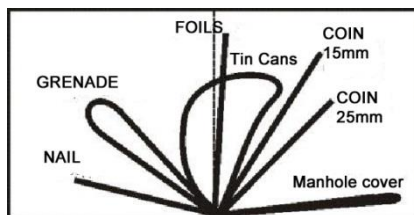

Fig. 14

REPLACING THE COIL

Attention! Before you replace the coil, find a clean section of ground, because after a coil replacement a ground balance is required.

Or, if a clean place cannot be found, have a piece of ferrite, or use a piece of red brick. Secure the desired coil on the rod, wrap the wire around the rod and plug the connector into the control box.

Hold the device at a distance of half a meter between the coil and the ground and away

from metal objects, turn on the unit while holding down the button  on the

instrument panel. Keep the button pressed until the detector stops playing the melody, and the screen for a short time will display the value of the working frequency of the coil.

Attention! The exact frequency displayed can vary depending on the coil and software and is automatically calculated by the device. For example a Coil with a frequency 7.0 kHz, can vary ± 20 Hz.

After this, your device will automatically navigate into the ground balancing mode. (Fig. 15) Perform the auto ground balance on the clean area of ground you located prior to changing the coil. Refer to appropriate paragraph under section "Ground Balance". Alternatively if a section of clean ground cannot be located perform the balance procedure using a piece of ferrite or red brick. Refer to the instruction pertaining to this under the section "Ground Balance"

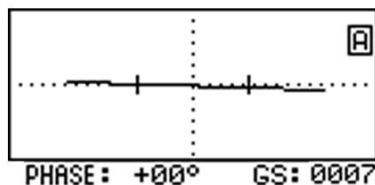



Fig. 15

Pressing  exits the balancing mode. Your device is now ready to work with the new coil.

Attention! All of the above procedures are necessary when making changes to the software version (flashing).

If your unit is equipped with several periodically used coils we recommend that you in the case of a shutdown (e.g. seasonal), before starting the search to restart the detector, i.e., to avoid confusion, to adapt the electronic unit to the sensor (coil).

SEARCH AND IDENTIFICATION METHODS

When scanning the ground move the coil smoothly over the surface of the ground while maintaining a constant distance of 2-3 cm This distance is optimal from the viewpoint of suppressing the influence of ground mineralization, and hence, for the proper identification of the metal objects. Avoid touching the ground with the coil. It is important that the distance between the coil and the ground remain constant (see Figure 16). Keep in mind that the quality of this operation has a direct impact on the correct identification of desired targets. Also try not to make sudden movements of the coil horizontally. Optimal scanning speed is 40-50 cm/s. Each pass of the sensor should overlap the previous one.

Use additional scans to more accurately identify the type of object by centering above the target. Sweep the coil through the maximum signal area as accurately as possible maintaining a constant distance between the coil and ground. For the same reason scan the target with coil in the direction of the least amount of surface change in the ground. In this case, the effect of soil will be minimal.

When the search coil interacts with a metal object there may be a single tone burst or possibly several tone bursts in rapid succession. Therefore one should pay attention to the following. When the detector responds with a single short high tone and the signal level is rather stable it is a good probability that the targets is not very large and of a non ferrous nature at a depth of more than 5cm.

On the other hand if the detector gives a series of short high tones (usually 3) then the targets is shallow and in the so called near zone (less than 5cm). The Signal level will also display a value of 50 or greater.

A series of two short low-pitched sounds indicates that in the area of the coil is an extended ferrous object (like a nail) located along the scanning direction. If the object is located along the perpendicular plane of the scan or the coil, the device will issue a single low-frequency short tone.



Fig. 16

It is important to note that the DD sensor is characterized by a complex pattern when interacting with metal objects close to the coil or the near zone (signal levels greater than 80). Therefore when trying to determine the target ID adjust the coil height to a level that will give a signal strength of 30 to 60 in the Turbo mode and from 15 to 30 in the normal search mode.

In other words, if conditions allow, try to identify objects above the near the zone.

Let's us discuss some of the challenges with the so-called "hot rocks", (VDI greater than +84). In order to better differentiate between "hot rocks" and relatively large flat non ferromagnetic objects (Large copper or silver coins) with a VDI range of +78 to +86, the device uses a special high pitched tone which is different from the usual tone indicated on such non ferrous targets. If you desire the signal from "hot rocks" can be deleted by setting the discriminator sector value with the right edge of the +86. However, the most effective means of suppressing the audible reaction on hot rocks is to use the DHR algorithm (Disc. of hot rocks). The risk from using discrimination settings to eliminate an audio response to hot rocks is this. Due to effect of the ground valuable targets, whose vector angle is close to that of hot rocks, can being missed. This risk is virtually eliminated by using the algorithm DHR instead.

As you know, a particular problem for induction metal detectors is the identification of flat

ferromagnetic objects such as steel caps/stoppers, lids, cans, etc., objects with a relatively large diameter of the eddy currents. This is largely helped out by using our proprietary development – The Hodograph Display (see Fig. 19).

In the interaction of such objects with the coil (assuming that the level of the signal is above 20) then time curves of these objects, as a rule, are twisted or looped in nature and "scattered" around the screen depending on the direction of the scan. Fig. 17 shows the travel times of these types of signals from an iron bottle cap/stopper.

Normal operating mode

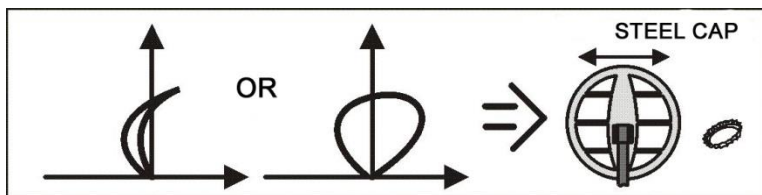

Fig.17

To solve the problem with identifying steel caps/stoppers, you can use the S-algorithm, which greatly simplifies the process of identification of small (up to 40-50 mm) flat iron objects.

If you have received a questionable audio response of an object, check using the S-algorithm to see if it is a cap. Do not forget to monitor the signal level. This algorithm works effectively only when the signal level is 10 or higher.

Analyzing these types of questionable targets is made much easier and does not require as much user experience. The main job of identifying is performed by the processor. Examples of the hodographs for the same cap/stopper using the S-mode algorithm is shown in Fig. 18.

S-Mode Algorithm

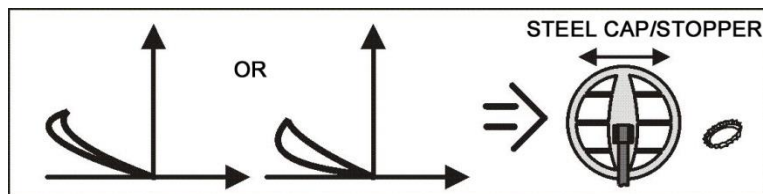
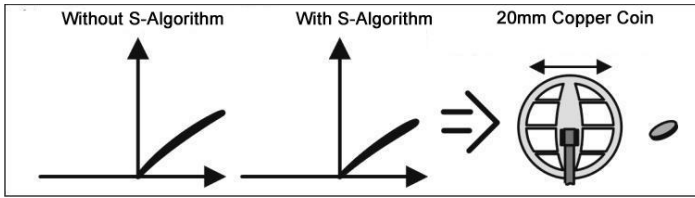

Fig. 18

As can be seen in Figure 19, the S-type algorithm curve has hardly changed.

Fig. 19



Examples of hodographs for some objects are shown in Fig. 20-25.

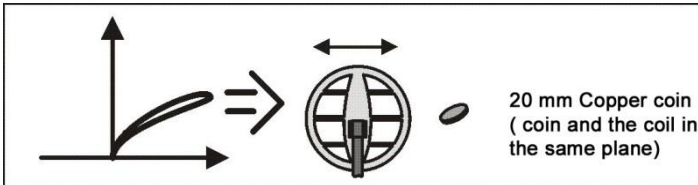

Fig. 20

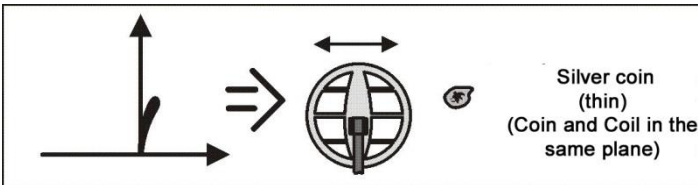

Fig. 21

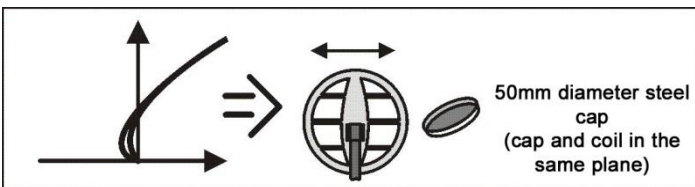

Fig. 22

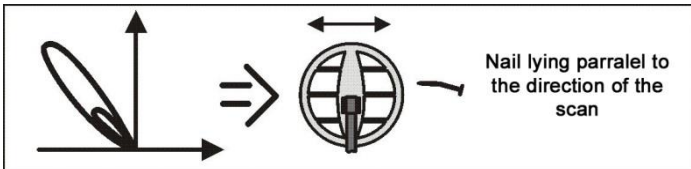

Fig. 23

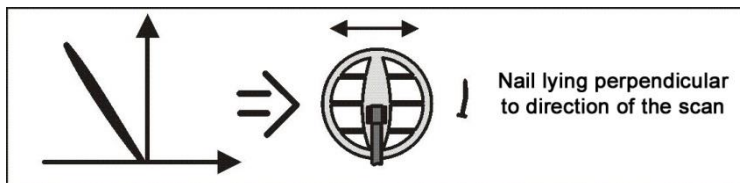

Fig. 24

The example in Fig. 25 shows a hodograph for two nearby objects. Dimensions of the Hodograph loops will depend on the ratio of the size of these objects and the distance between them.

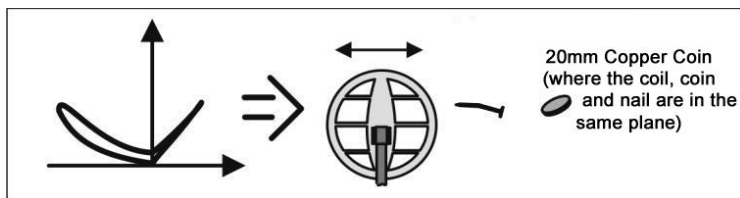

Fig. 25

SEARCHING FOR METAL OBJECTS WITH LARGE EDDY CURRENT LOOPS.

These types of objects include, for example, large copper/silver coins, and other large planar objects of non-ferrous metals with a diameter greater than 40 mm.

Due to the particular interaction between the search coil and these types of targets certain difficulties arise.

This is due to the very narrow difference between the vector angle of these targets and those of the ground signal.

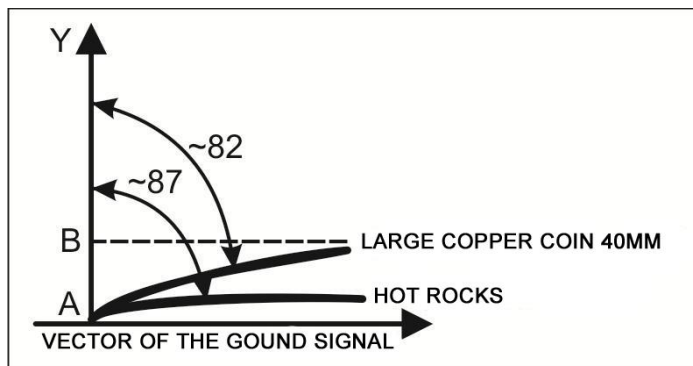

Fig. 26

This useful component of the vector is the projection of AB to the vertical Y axis. The smaller the angle difference between the ground signal vector and the vector of the coin the less useful part of the projection of the signal and the less sensitivity. More important is the fact that the angular difference becomes even less with the so-called "hot-stone" (see fig. 26).

In these cases, even a minor incorrect setting of the ground balance can lead to a significant loss of sensitivity to the large copper/silver coins or an undesirable (annoying) response to "hot rocks" if the algorithm DHR is not used.

Note that when setting the ground balance, such as on loam, the angular difference between the signal and the signal of large copper/silver coins is about 7-8 degrees. At the same time, the angular difference between hot rocks is only 4-5 degrees which leads to difficulties in the identification of such targets.

In view of the above, it is possible to give some practical recommendations.

1. As accurately as possible carry out Ground Balance.
2. In areas with little to no metal trash use the AGT.
3. In the presence of hot stones, when not using the DHR algorithm, carefully open up the right border of the sector discrimination to minimize the risk of missing these types of coins.
4. Try to adjust the vector phase of the soil by 2-3 degrees in the counterclockwise direction (specific value selected experimentally in Depending on the type of soil). To do this, perform the automatic ground balance procedure.

Then press the button  to enter into manual ground balance mode

and adjust the balance value 2-3 times by pressing  and then check the

response of the detector when scanning area clean. This procedure requires a more careful scanning of the soil. In the case of false positives channel identification (ST) reduce the angle of the phase by pressing

button  until their disappearance.

When searching on the wet grass (dew, rain) there is an increased risk of false signals in the ST channel. This effect manifests itself mainly due to the setting of high values of sensitivity in the ST channel and to the presence of a weak electric conductivity in the dew and plant liquids. To a large extent (almost completely), this effect can be eliminated by placing the search coil in a protective plastic case (plastic bag, full-time protection, etc.). In the case of searching in trashy areas it is sufficient to reduce the sensitivity of the ST channel.

EXAMPLES OF SOME COMMON TARGET VDI's

VDI data are for units with a 7 kHz, Normal mode, Turbo and Economy off and DHR off.

| Scale Of VDI | Items |
|-----------------|---|
| From -90 to -86 | Hot rocks, improperly configured ground. |
| From -86 to -70 | small nails and other small iron trash. |
| From -70 to -50 | medium wrought nails, small arrowheads. |
| From -70 to -35 | large wrought nails, medieval knives, flat arrowheads, horseshoes, locks, and other fairly large iron articles. |
| From -35 to -10 | In this sector there is little iron except those targets that may be "masked" by iron, small objects of irregular shape of the low conductivity of non-ferrous alloys (bronze crosses, thin gold serpentine chain). Pay particular attention to the arrow and narrow loop-travel times in this sector. |
| From -10 to +10 | foil, small crosses of bronze, very small lead, fine gold, small .22 shell casings. |
| From +10 to +30 | Hammered short cross silver cut half (+22), Roman minim (+14), some small thin hammered silver coins, US 5 cent nickel, 50 pence (+24), 20 pence (+28), small lead shot. |
| From +30 to +50 | Hammered short cross silver penny +47, Celtic gold stator +46-+50, larger lead shot(i.e. musket balls, Minnie balls) also lead seals, Aluminum tabs, larger 14K gold rings. |
| From +50 to +70 | AE antonianus + 64, US copper penny, US zinc Penny, UK pound coin |
| From +70 to +86 | Large copper coins (cartwheel penny, King George coppers, Victorian penny,) UK pound coin, US dime, Quarter, Half dollar and dollars, as well as large Planar or spherical iron objects (helmets, , plows, axes, etc.) |
| From +86 to +90 | ground response from an unbalanced device, "hot rocks", as well as very large objects from deep highly conductive metal (e.g. aluminum basin, a large silver tray). "Hot Stone" signals differ in that they sound stretched, while the signal from the metal target is usually concentrated in a small point. |

As we can see, even in the good VDI sectors we have targets that are trash. That is, there will always be trash items mixed in with the more desirable targets with very similar characteristics.

Also, do not forget that the purpose of VDI is only true in the area of consistent definition of the instrument and in the absence of other metal objects nearby. For example, a piece of iron underlying a gold ring will cause the normal VDI of +37 to now read 18/22. And at the limit of sensitivity in the ground, it may suddenly sound like a deep copper coin with VDI +85. This is not unique to your device, but for all other devices of this type.

Thus, any decision to dig or not dig a likely trash target is a compromise between comfort versus the loss of valuable finds. And who knows, maybe 99 times you dig a trash target but on the 100th time the same VDI rated target will turn out to be a valuable find.

Attention! When using a search coil with a low frequency excitation current VDI readings will have lower values. Conversely, for higher frequency the VDI readings will be higher.

WARRANTY INFORMATION

Manufacturer guarantees operational capability of the metal detector provided that the consumer follows operation conditions.

Warranty period 24 months starting from the sale date. Manufacturing defects shall be repaired by the Manufacturer during the warranty period free of charge provided that there is no damages in electronic module and searchcoil.

This Operating Manual with the sale date mark should be provided together with the device in case of warranty repair.

Warranty period is calculated from the date of manufacture in case there is no sale date mark

.Address for claims:

