

GasCheck 5000is



Instrument User Manual V2.2



Register
your instrument
online to receive
your extended
warranty.

Unrivalled Detection.

www.ionscience.com

Register your instrument online for extended warranty

Thank you for purchasing your Ion Science product.

The standard warranty of your instrument can be extended to up to five years on the Tiger and two years on other Ion Science instruments.

To receive your extended warranty, you must register your instrument online within one month of purchase (terms and conditions apply.)

Visit www.ionscience.com/instrument-registration

Declaration of conformity

Manufacturer: Ion Science Ltd, The Way, Fowlmere, Cambridge, England SG8 7UJ

Declare that the products **Gas Check 5000is** comply with the requirements of :

Directives 89/336/EEC EMC Directive
76/117/EEC Equipment and protective systems intended for use in potentially explosive atmospheres in conformity with the following standards and specifications

Standards: BS EN 13908:2002 ATEX – Application of quality systems
BS EN 50014:1998 ATEX - general requirements
BS EN 50020:2002 ATEX – Intrinsic safety “i”
BS EN 61010-1:2010 Safety reqs. for measurement, control & lab equipment use
BS EN ISO 9001:2008 Quality management systems
BS EN 61326-1:1997 EMC – Equipment for measurement, control and laboratory

Product marking is as follows:

Gas Check 5000is carries the Intrinsic Safety Marking to class

 II 2 G Ex ia IIC T4 (-20°C ≤ Ta ≤ +60°C)
Certificate Number Baseefa 02ATEX0093

Gas Check 5000is carries the CE-mark  1180.

On behalf of Ion Science Ltd, I declare that, on the date this product accompanied by this declaration is placed on the market, the product conforms to all technical and regulatory requirements of the above listed directives.

Name: Mark Stockdale

Position: Technical Director

Signature:



Date: 20th January 2010

Contents

| | |
|---|-----------|
| Declaration of conformity | 3 |
| Introduction | 5 |
| Scope and definitions | 5 |
| Applications | 6 |
| Technical Data | 7 |
| General | 7 |
| Performance | 8 |
| Battery data | 9 |
| Operation | 12 |
| Controls | 12 |
| Control Keys | 13 |
| Menu topics and corresponding displays..... | 14 |
| Main menu | 14 |
| ABC | 15 |
| Alarm Level..... | 15 |
| Audio..... | 16 |
| Backlight | 16 |
| Clock..... | 17 |
| Data Control..... | 19 |
| Gas Group | 23 |
| Language..... | 23 |
| Nozzle..... | 24 |
| Peak Hold | 24 |
| Power off..... | 24 |
| Range | 26 |
| Display | 27 |
| Leak rate indication..... | 27 |
| Other display symbols | 28 |
| Audio and visual outputs..... | 29 |
| Prepare the Gas Check | 29 |
| Program | 31 |
| Switch on the Gas Check | 31 |
| Recommended leak search procedure..... | 31 |
| Leak detection along seams | 32 |
| Leak detection at pipe joints | 32 |
| Data logging – interruption for menu access | 32 |
| Switch off the Gas Check | 32 |
| Auto Shut Down..... | 32 |
| Inspect and clean the Gas Check..... | 33 |
| Maintenance | 34 |
| Replace the batteries | 34 |
| Fault finding | 36 |
| Storage | 37 |
| Disposal | 37 |
| Spares | 38 |
| Accessories | 38 |
| Calibration..... | 38 |
| Refurbish program | 38 |
| Instrument warranty and service | 39 |
| Warranty | 39 |
| Service..... | 39 |
| Contact Details: | 39 |
| Manual log | 40 |

Introduction

Scope and definitions

This manual provides installation, operation and maintenance instructions for the Gas Check 5000is. You must use the Gas Check as specified in this manual.

Read this manual before you install and operate the Gas Check. Important safety information is highlighted as WARNING and CAUTION instructions; you must obey these instructions. The use of WARNINGS and CAUTIONS is defined below.

WARNING

Warnings are given where failure to observe the instruction could result in injury or death to people.

CAUTION

Cautions are given where failure to observe the instruction could result in damage to the equipment, associated equipment and process.

The units of measurement used throughout this manual conform to the SI international system of units of measurement

Description

Refer to Figure 1. The Gas Check is a portable, battery-powered, hand-held gas leak detector. Indications of a leak are shown on the digital display (2) and are also given by a front panel mounted LED flasher (3) and as audible clicks from the rear panel loud speaker (6).

The Gas Check 5000is is intrinsically safe and is suitable for leak detection of hydrogen and other flammable gases, and for leak detection in hazardous areas of Ex ia IIC T4 rating.

The Gas Check has a convenient storage and carrying case, together with a spare battery holder, a long flexible probe (for leak detection in areas where access is restricted) and a box-spanner for probe changing.

Principal of operation

When the Gas Check is switched on, a small internal fan draws gas samples through the probe and into the Gas Check. The Gas Check measures the thermal conductivity of the gas samples.

When you first switch on the Gas Check (using the power I/O key) or when you press the zero key : The Gas



Check zeros the leak rate display. If further samples have a different thermal conductivity from the zeroed sample, the Gas Check calculates and displays the difference as a leak rate. This means that you can use the Gas Check to detect any gas other than that in which the Gas Check is zeroed.

Introduction

Applications

You can use the Gas Check on many types of applications, including those listed below.

Quality assurance testing on manufactured component seals.

Laboratory applications, such as the detection of leaks from gas chromatographs, from mass spectrometers, from gas cylinders and fittings.

Industrial applications, such as the detection of leaks from gas installations, in cylinder receiving rooms, from pipeline assemblies, the detection of leaks from stored gases and the detection of vapours released from stored chemicals.

Medical applications, such as the detection of leaks from anaesthetic gas bottles and pipelines and leak testing of membrane materials, glove boxes and so forth.

Valve emission evaluation to EPA (Environmental Protection Agency) method 2.1

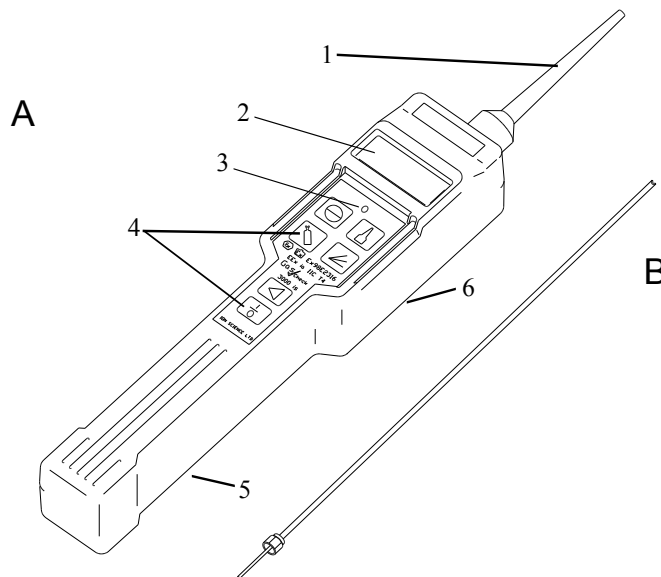

Figure 1 – The Gas Check 5000is

Leak testing of pipeline joints, gaskets, chamber windows and so forth

A Gas Check with short probe and nozzle fitted

B Long probe

- | | | | |
|---|-------------|---|---------------------|
| 1 | Nozzle | 4 | Tactile keys |
| 2 | Display | 5 | Battery compartment |
| 3 | LED flasher | 6 | Loudspeaker |

Technical Data

General

Operating temperature range

Gas Check 5000is 0 to 40 °C 32 to 104 °F.

Storage temperature range

-25 to 70 °C -13 to 158 °F.

Materials of construction

Storage case Polypropylene with polyester foam insert
 Gas Check Polyurethane casing with a metal bracket

Dimensions

Storage case 420 x 320 x 97 mm 16.5" x 12.5" x 3.75 "
 Gas Check see Figure 2

Mass

Complete storage case 1.6 kg 3.5 lb.
 Gas Check 0.5 kg 1.0 lb.

Ingress ratings

Minimum IP20

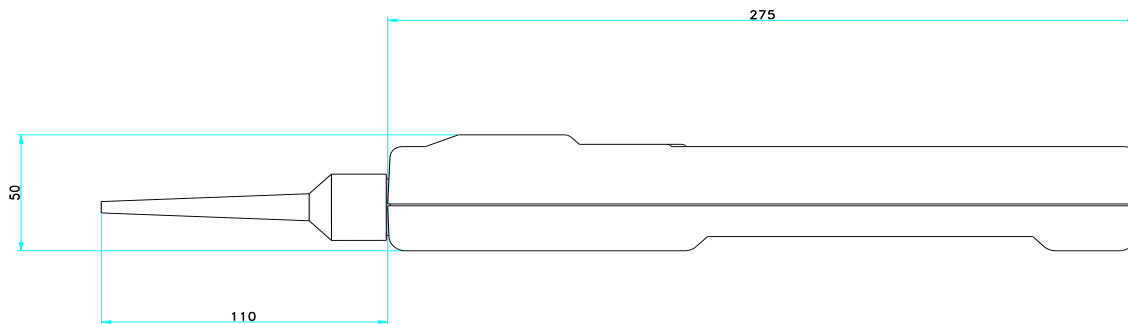

* Length of short probe and nozzle. Length of long probe = 300 mm (12")

Figure 2 – Dimensions (mm)

Technical Data

Performance

Detector type Dual micro-volume thermal conductivity cell

Gases Detected:

All gases and vapours having a different thermal conductivity to the ambient air on which it was zeroed. The larger the difference the greater the sensitivity, so that Gas Check is not highly sensitive to the gases normally found in large concentrations in the ambient air, e.g. N₂ (nitrogen) and O₂ (oxygen).

For ease of use the Gas Check groups gases having similar thermal conductivity into one of the 5 gas groups shown in Table 1. Each group has a calibration curve stored in memory. Although the Gas Check will detect ALL gases with a different thermal conductivity to air, Table 1 lists those 12 common tracer gases that have been tested and assigned gas groups. If the gas or gas mixture that you seek is not included in these groups, select group 0 (which is the most sensitive). The Gas Check will then still find leaks quickly even though the measured values will not be displayed accurately. Some gases give a negative response.

Minimum response time

| | |
|--------------------|--------------------|
| Short probe fitted | Less than 1 second |
| Long probe fitted | About 9 seconds |

Recovery time About 1 second

Maximum detection level with the short probe and nozzle fitted 20 ml/sec

Data logging RTC This is a nominal device for convenience and can be reset by a user if more accurate timings are required.

Note: If the probe has been changed then the instrument should be recalibrated for more accurate measurements. The readings given by the long probe can only be considered as indicative.

Technical data

Minimum detection levels

see Table 1

The nozzle when fitted provides automatic 10-fold dilution of the gas stream entering the Gas Check TCD, except when the ppm display is selected. The Gas Check nozzle should always be removed for assessing gas concentration levels in volume spaces smaller than about 1 litre when you are using the ppm display.

Note1: the minimum detection levels given in Table 1 apply when the Gas Check is used in clean laboratory air conditions. When used in conditions where the ambient atmosphere contains clouds of the gas for which you leak test, the minimum detection levels may be obscured.

Note2: An offset of up to 10 times the detection levels given in Table 1 may be experienced in the presence of electromagnetic interference @ 320 +/- 30 MHz at the levels specified in EN 50082-1.

Table 1- Smallest Leak Detection Levels

| Gas | Gas Group | Positive/Negative | Smallest Leak Detection Level in ml/sec |
|-----------------|-----------|-------------------|---|
| H ₂ | 0 | Positive | 1.5 x 10 ⁻⁵ ml/sec |
| He | 0 | Positive | 2.0 x 10 ⁻⁵ ml/sec |
| R12 | 1 | Negative | 5.4 x 10 ⁻⁵ ml/sec |
| R1301 | 1 | Positive | 4.9 x 10 ⁻⁵ ml/sec |
| R134a | 1 | Negative | 2.1 x 10 ⁻⁴ ml/sec |
| R22 | 1 | Negative | 5.1 x 10 ⁻⁵ ml/sec |
| SF ₆ | 1 | Negative | 4.4 x 10 ⁻⁵ ml/sec |
| CO ₂ | 2 | Negative | 8.0 x 10 ⁻⁵ ml/sec |
| CH ₄ | 2 | Positive | 5.8 x 10 ⁻⁵ ml/sec |
| Ar | 2 | Negative | 7.0 x 10 ⁻⁵ ml/sec |
| R11 | 3 | Positive | 6.3 x 10 ⁻⁵ ml/sec |
| O ₂ | 4 | Positive | 5.7 x 10 ⁻⁴ ml/sec |

Battery data

Note1: the energy storage capacity of batteries and even their T4 intrinsic safety rating is affected by ambient temperature. The data in Table 2 is for an ambient temperature of 20 °C (68 °F).

Note2: the use of the back light and the IR Data Port will dramatically shorten the battery life.

Technical data

WARNING

For GasCheck 5000is

Do not modify the GasCheck 5000is equipment to allow any recharging in the instrument.

AAA Rechargeable Battery Pack (part No. A-31117)

This battery pack has been specially designed to be used with Ion Science's intrinsically safe gas detection instruments for example PhoCheck's, GasCheck's, FirstCheck's and Hydrosteel 6000 is ATEX approved.

Please refer to the AAA Rechargeable Battery Pack User Instructions supplied with the batteries.

For Intrinsic Safety T4 Rating in the Gas Check 5000is AA rechargeable batteries must not be used in the battery holder.

There is no provision for the recharging of batteries within the GasCheck 5000is therefore please use the Ion Science charger supplied with the **AAA Rechargeable Battery Pack (part No. A-31117)**

For alkaline types (MN1500 or LR6) type use only Duracell (Standard, Procell or Ultra) or Ever Ready (Energiser) batteries. Alternatively use any zinc carbon types R6PP or R6S

| | |
|-------------------------------|--------------------|
| Number of batteries required | 4 |
| Battery type | Alkaline, size AA |
| Recommended batteries | LR6 (R6) or MN1500 |
| Average operating life | see Table 2 |
| AAA Rechargeable Battery Pack | 1 |
| Average operating life | see Table 2 |

| Battery type | Battery life (hours) |
|-------------------------------|----------------------|
| | Gas Check 5000is |
| LR6 (R6) * | 20 |
| MN1500 * | 20 |
| R6S | 10 |
| R6PP | 10 |
| AAA Rechargeable Battery Pack | 12 |

* Preferred battery types Table 2 – Average battery life

The use of the back light will dramatically shorten the battery life.

Do not change batteries in a hazardous area.

Installation

Remove all packaging materials, then open the storage case and inspect the equipment. If the storage case or any other item is damaged, notify your supplier and the carrier in writing within three days; state the Item Number and the Serial Number stamped on rear case of the Gas Check (refer to Figure6), together with your order number and your supplier's invoice number. Do not attempt to use the Gas Check if any item is damaged.

The batteries if provided are shipped in the spare battery clip and not inside the GasCheck instrument itself.

Refer to Figure 3 and check that the storage case contains the items listed in Table 3. If any item is missing, notify your supplier in writing within three days.

| Qty | Description | Check () |
|-----|---|-----------|
| 1 | Gas Check (with short probe and nozzle fitted) | |
| 1 | Long probe | |
| 1 | Box-spanner | |
| 1 | Special screwdriver for access to battery compartment | |
| 1 | Spare battery holder with 4 batteries | |

Table 3 – Checklist of items in the storage case

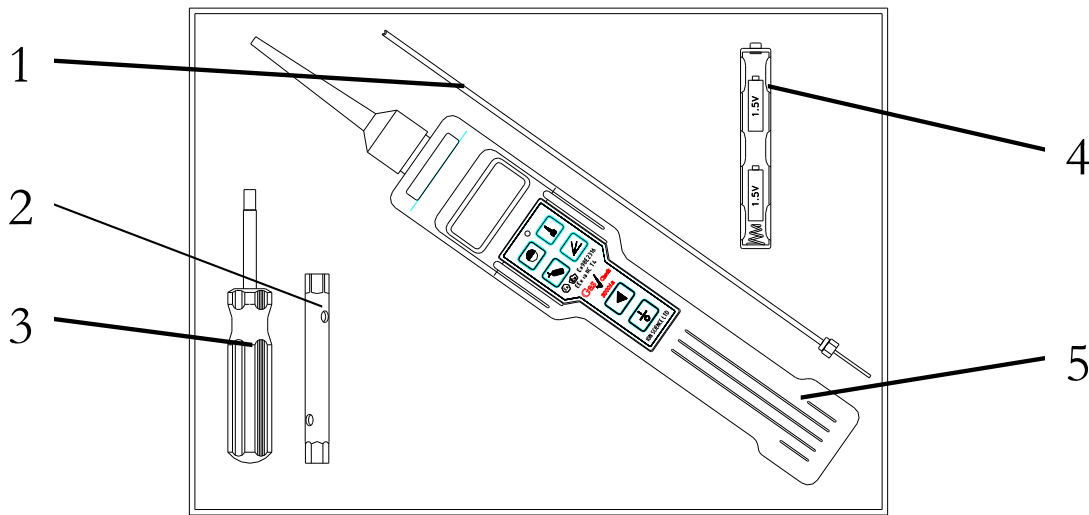

- | | | | |
|----|---------------------|----|--|
| 1. | Long probe | 4. | Spare battery holder |
| 2. | Box-spanner | 5. | Gas Check (with short probe and nozzle fitted) |
| 3. | Special screwdriver | | |

Figure 3 – Items in the storage case

Operation

Gas Check 5000is both have menu keys for user accessible settings. However normal use of the Gas Check would not involve any menus, because these are only needed to set up the instrument for your application, after which the instrument stores the settings internally when the instrument is switched off.

The display of information on the Gas Check 5000is depends on whether the instrument has been keyed into the set up menus or is simply being used for leak detection. The Gas Check 5000is menu displays utilise 3 lines of information while the normal display uses 2 or 3 lines; in each case the lowest line is for status information while the upper line(s) show(s) the menu topics or the leak rate values.

You may like to gain some confidence in the operation by simply using the control keys although if it has not yet been used you should carefully fit the battery clip. Please take note of the warnings and cautions when fitting batteries or when in potentially hazardous areas.

Controls

In normal use there is only one key to press, beyond the power ON/OFF control, and that is the ZERO key.

Refer to Figure 4. Use the control keys as described on next page.

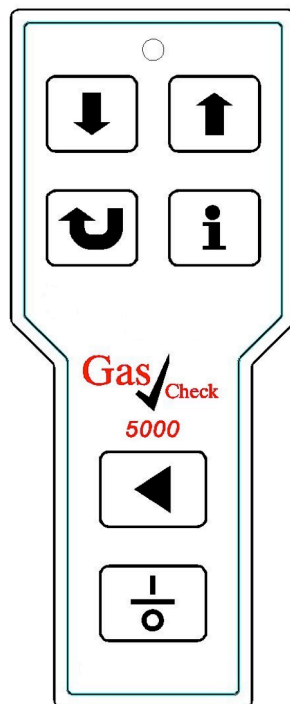

Operation

Control Keys

POWER



Press this key to switch the Gas Check POWER on for use. When this key is pressed from normal display, Gas Check will turn its POWER off, remembering all last settings (except back light reverts to OFF state). When in menus, pressing this key brings Gas Check straight back into the normal display WITHOUT any of the settings changes being implemented.

ZERO/BACK



Just press zero to adjust for background levels, reset the peak hold memory or after changing a gas group. In menus, successive presses of this key provides a simple step by step route BACK to the normal display.

PROCEED



Press the proceed key to reach the menus that allow you to control special settings of the Gas Check 5000is.

DOWN



Press or hold the Down key to scroll up through menus or to raise a numerical value. Release when desired.

UP



Press or hold the Up key to scroll down through menus or to lower a numerical value. Release when desired.

INFO



Press the Info key to start data logging as per the parameters last set via the data control menu.

Operation

Menu topics and corresponding displays

The first pressing of the PROCEED key switches the display into the Gas Check 5000is menus. These menus are shown by the relevant menu topic on the top line and the available choice and the current settings on the middle and bottom display lines. The UP and DOWN keys scroll round the menu choices. Some of the menus show a tick or cross at the right hand side to indicate the current settings or choices. The PROCEED key selects the current topic, and in some menus pressing this will change the tick for a cross or a cross for a tick and also alter the instrument running status symbols displayed on the lowest line. This has been found to help customers readily understand the menu selection for new instrument settings.

Basic Display Details:

| | | | |
|--------------|---------------------------|---|-----------------------------|
| Top Line: | Name of Menu or Topic |  | Back |
| Middle Line: | Operation. Keys | | Currently user adjustable |
| Bottom Line: | Instrument running status | | or Current Setting of Topic |

Where the menu structure has an underlying sub-menu structure for settings, the bottom line is blanked.

Main menu

| | |
|--------------|--|
| ABC | Automatic Background Compensation (not normally used) |
| Alarm Level | Setting for the Audible/Visual Alarm |
| Audio | Mute the leak rate Audible/Visual |
| Backlight | Controls for the Back light display |
| Clock | Data logging clock functions |
| Data Control | Functions for data control including download via IR Link |
| Display | Bar graph or numeric display functions |
| Gas Group | Choice of Gas Group or named Gases |
| Language | Specialist option instead of English etc. |
| Nozzle | Switch for whether nozzle is fitted or not, for leak rate calibration purposes |
| Peak Hold | Switch for storing maximum reading on display between each zero key press |
| Power off | Controls whether or not Gas Check shuts down automatically after fixed time |
| Program | Specialist functions to set up Gas Check 5000is via IR Link and software |
| Range | Autoranging or fixed range displays |
| Units | Leak rate units |

At this level the following key functions are available

Select the subsequent topic from the main menu by the PROCEED key. 

Leave the menu and go back to normal operation by the Zero/Back key 

Scroll through the menu by use of the up and down keys.

Escape back to the normal display without implementing any menu changes by pressing the 1/0 key once.

Operation

ABC

Display:

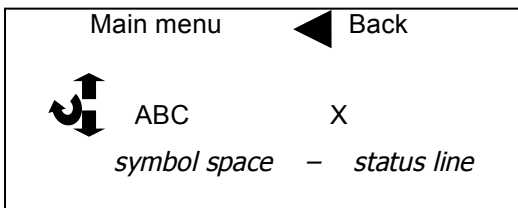

The X indicates that it hasn't been selected – The status line doesn't have the < symbol. If the Proceed key is pressed then the X turns to a ✓ and the < symbol appears on the status line. Press Proceed to reverse.

Alarm Level

The alarm level format is in the same style as the display type (see below for display style options). The alarm level is linked to gas group setting such that if the Gas Group changes the alarm is not set, the



status symbol is removed from the display, although the last alarm level value is retained for reconfirmation. This is to ensure the Gas Check avoids incorrect alarm levels on a Gas Group change.

Press  to jump down into Alarm Level setting.

Display:

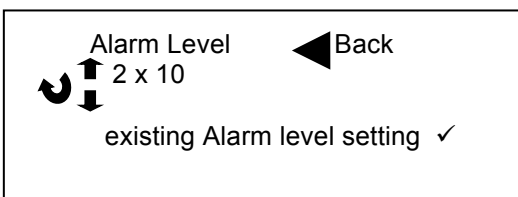

Note: When the alarm is set to maximum, the alarm function is disabled and the Main menu Alarm level display will show Not set and no bell will shown once the Gas Check is put back in the normal display.

Operation

Audio

When the audio feature is selected, the tick frequency of the Audio and Visual indicators is linked to the size of the leak rate displayed; when Audio is not selected there is no link.

Display

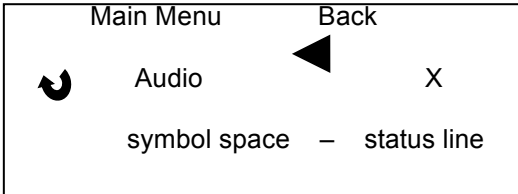

The X indicates that it hasn't been selected – The status bar doesn't have the < symbol. If Proceed key is pressed then the X turns to a ✓ and the loudspeaker symbol is placed down onto the third row.

Backlight

The backlight control allows the user to switch on the backlight or select a TIME setting.

Press to jump down into Backlight setting and then the PROCEED key or the UP and DOWN keys.

Display:

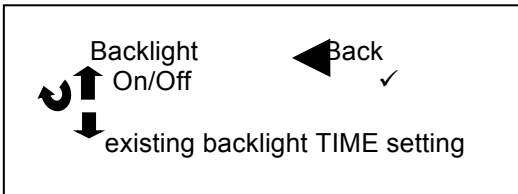

Status shown ✓ will put the Backlight ON

If the scroll up or down keys are used from this start point, then the following options are shown:-
20s 1min 3min 10min 30min

Note: If time displayed = the existing backlight time then a ✓ is shown at the end of the 2nd row, else a X .

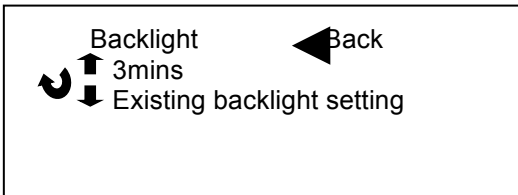

Operation

Clock

Press  to jump down into Clock setting.

Display:

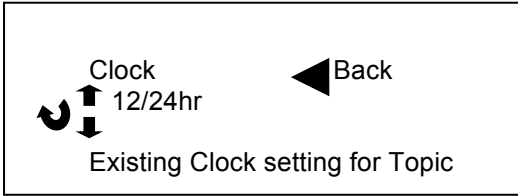

Note: No X or ✓ at this level because we are not at the end of the tree. The full clock settings are shown.

Operation of the up or down keys give access to the other topics at this level.

- Date format
- Set time
- Set date

The following frames show the CLOCK sub-menus accessed by the  key.

Clock - 12/24hr

Display

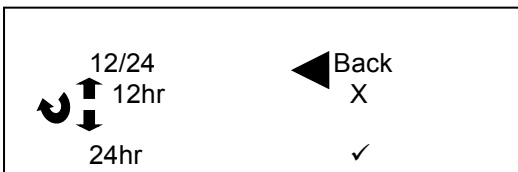

Note: X because 12hr not selected but a ✓ always in the bottom row to show that this is currently selected.

Clock - Date Format

Display

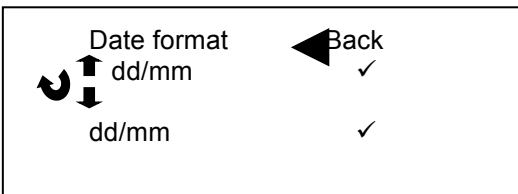

Note: Both ✓ in this example because of the same setting. This also denotes the end of the tree.

Other option within this topic is:- mm/dd

Operation

Clock - Set Time

Display

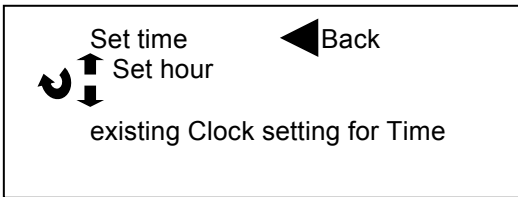

Other options within this topic are

Set min

Synch RTC

Clock - Set Time - Set hour

A press on the  takes us down into this next level. Use UP and DOWN keys to change hour value. Press PROCEED when this is what you require, and the clock will proceed to minutes then to seconds. If you are only changing hours for Daylight Saving Time changes then once PROCEED has been actioned the Back key can be used to return towards the normal display mode with the required changes stored.

Display

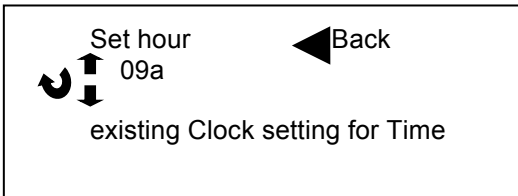

Clock - Set Time - Set min

As per Set hour

Clock - Set Time – Synch RTC

This allows users to confirm that the minutes setting conforms to expectations and allows set to 0 seconds. When the synchronisation time is shown and the minutes are incorrect, press Back to revert to set minutes. Pressing PROCEED will action the synchronisation to the displayed time and then revert to set time frame.

Operation

Data Control

This sub-menu has the following topics and are accessed by pressing the  key.

- Clear data
- Data transfer
- Logging settings (only accessible in continuous logging mode)
- Memory used
single/cont.

In most of these menus the third line shows current settings or values and also ✓ or X on the middle line.

Data Control - Clear Data

Enter this by a  press.

Display

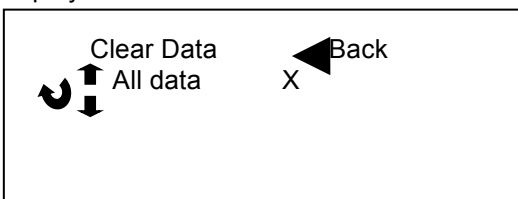

Note: An X or ✓ will be required following usual convention on the 2nd line.

Use the up or down scroll keys for other end tree selections:-

Last data X

Data Control – Data Transfer

Display

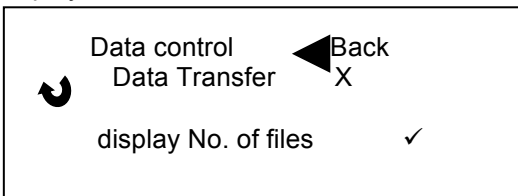

Note: An X or ✓ will be required following usual convention on the 2nd line.

When Data is being transferred, the X changes to a ✓ and then the Gas Check changes to a blank display but with the words 'Data transfer' for the duration of the transfer or time-out.

Operation

Data Control – Logging settings

Enter this by a  press.

Display

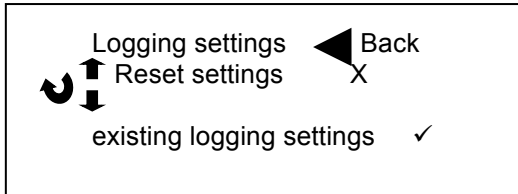

Only if you want to return to default

No. Samples x Interval s ✓

Use the up or down scroll keys for other Topic selections:-

Interval

No. Samples

Data Control – Logging settings- Interval

Enter this by a  press and use the UP and DOWN keys to select a new repeat interval for data logging. Press PROCEED key to enter this value in seconds, BACK key to move back towards the normal display.

Display

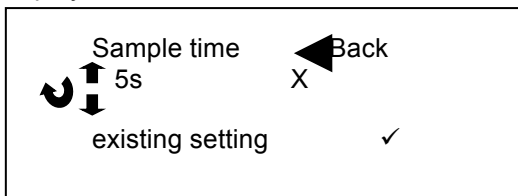

Data Control - Logging settings – No. Samples

As per Interval above. This sets up the total number of samples per record for each press of the INFO key. When the Single mode of data logging is used, this menu is NOT accessible, as only ONE sample is taken.

Operation

Data Control - Memory Used

Display

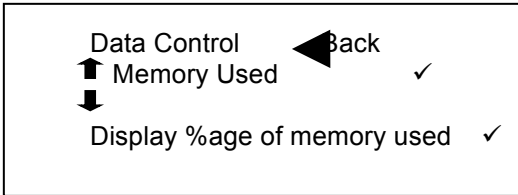

Note: This is an unusual case but we are still trying to follow the same format. This is just an information menu only but the ✓ serves as an indicator that it is an end tree situation. Also notice how the ↻ has been removed for this item.

Data Control - Single/cont.

Enter this by a ↻ press.

Display

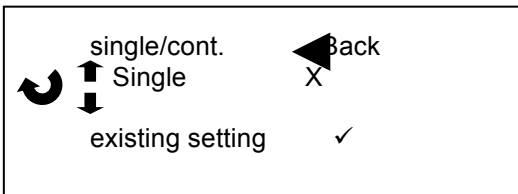

The choice is given to toggle the 'Single' or Continuous mode of data taking (using the Logging Settings).

CAUTION

Please reset the Gas Check clock date and time settings required for data acquisition before proceeding to take data if this is to be used as a real time record rather than a logging sheet.

Display - Style

Gas Check 5000is allows the user to select a preferred style of presentation – either a bar graph with an exponent range indicated or a digital display with a similar exponent range. The style applies to both the normal display mode and the menu settings for alarm level.

Enter this by a ↻ press.

Display

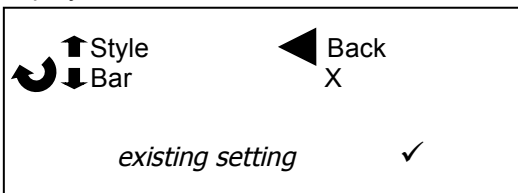

Operation

The option is given here (as per clearing Last data or All data) is for information purposes, to aid selection. The choice is given to toggle the 'Bar' at this level or to scroll through to see the other option: Numerals.

Display - Size

Gas Check 5000is allows the user to select a preferred size of the display style presentation as a larger or a smaller size for the bar graph or numerals and the exponent range value. The size only refers to the normal display settings not to the menu settings for the alarms.

Enter this by a  press.

Display

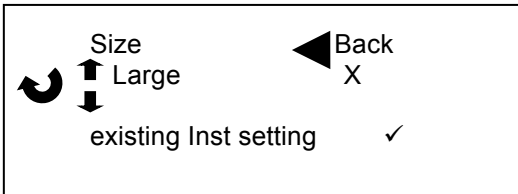

The option is given here (as per clearing Last data or All data) is for information purposes, to aid selection. The choice is given to toggle the 'Large' at this level or to scroll through to see the other option: Small

Note: Similar X and ✓ indications are followed in both Size and Style.

Operation

Gas Group

Enter this by a  press.

- Ar
- +CH4
- CO2
- H2
- He
- O2
- R11
- R12
- R22
- R134a
- R1301
- SF6
- Group 0
- Group 1
- Group 2
- Group 3
- Group 4

Named gases have a polarity feature that is NOT available for the Gas Groups on Gas Check 5000is: the response after zeroing is ONLY allowed to be in the same sense as the polarity of the named gas.

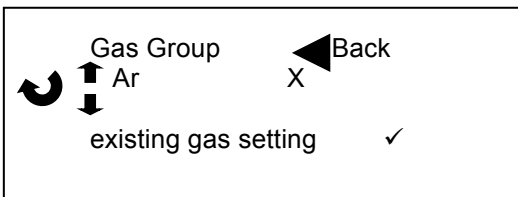

Note: Similar X and ✓ convention is followed.

Language

Enter this by a  press.

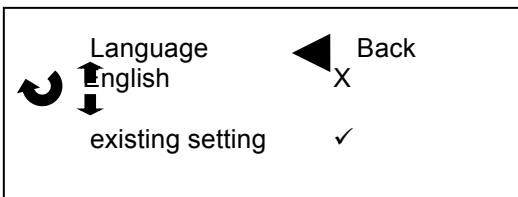

The option is given here (as per clearing Last data or All data) is for information purposes, to aid selection. The choice is given to toggle the 'English' at this level or to scroll through to see what the other options are - which in the instance is one! 2nd Programmed Language English (this is the normal factory alternative). Note: Similar X and ✓ convention is followed.

Operation

Nozzle

Display

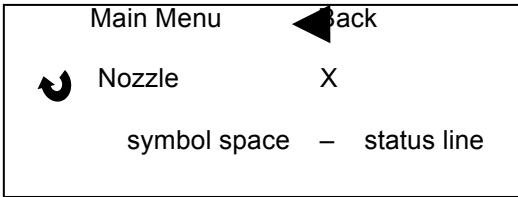

The X indicates that it hasn't been selected – The status line doesn't have the nozzle symbol. If the PROCEED key pressed then the X turns to a ✓ and the nozzle symbol is placed down onto the third row

Peak Hold

Display

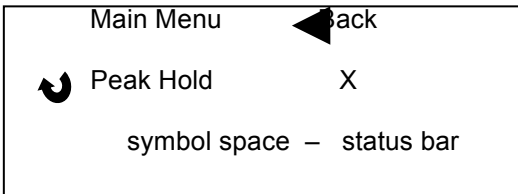

The X indicates that it hasn't been selected – The status bar doesn't have the Peak Hold symbol. If PROCEED key pressed then the X turns to a ✓ and the Peak Hold symbol is displayed in the third row.

Power off

This sub-menu has the following topics accessed by pressing the  key.

Manual
Automatic

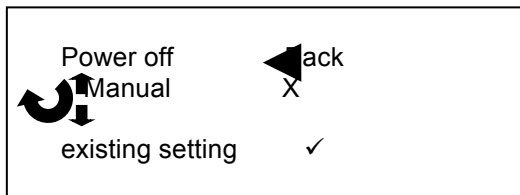

Manual will ensure the user has to press the I/O key to turn off Gas Check. Automatic waits approximately 10 minutes from last key press with signal below 50% of selected range before switching off Gas Check.

Manual will be useful for those users requiring continual operation for data logging purposes or leak ups.

Similar X and ✓ convention is followed as for other menus.

Program

This sub-menu has the following topics and are accessed by pressing the  key.

Language
Menu
Zone

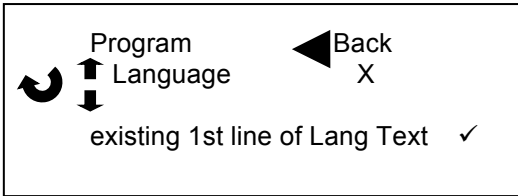

Note: Similar X and ✓ convention is followed.

Pressing the PROCEED key without an IR Link communication will result in a delayed reset of the unit. The other two selections will also be displayed because of different information content on the third line.

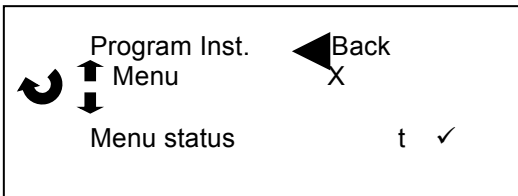

Menu status will only have a S/W test to indicate whether it is in the non programmed (normal default settings) or has any of these settings changed. THUS: the bottom line will have one of two messages:-

Factory Menu ✓
 Custom Menu ✓

Pressing the PROCEED key without an IR Link communication will result in a delayed reset of the unit.

Note: Similar X and ✓ convention is followed.

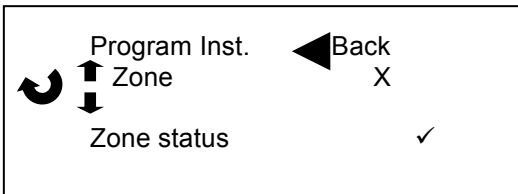

Zone status will only have a S/W test to indicate whether it is in the non programmed zone or has the zone option programmed within it.

THUS: the bottom line will have one of two messages:-

Zone Set
 No zone ✓

Pressing the PROCEED key without an IR Link communication will result in a timed our rest of the unit.

Note: Similar X and ✓ convention is followed.

Program

Range

Press  to jump down into the range topic.

Display:

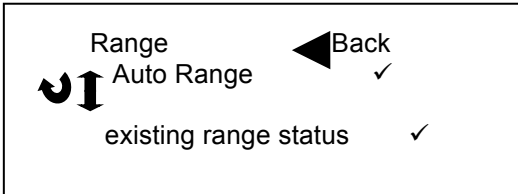

Existing status shown ✓

This is Auto Range for ✓ above

If the scroll up or down keys are used from this start point, then the following options are shown:-

Manual x103

Manual x102

Manual x101

Note: The exponents are only an example for the units of ppm selected.

Units

Press  to jump down into the units topic.

Display:

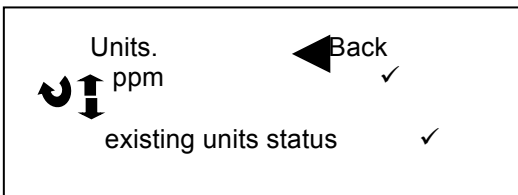

Existing status shown ✓

This is ppm for ✓ above

If the scroll up or down keys are used from this start point, then the following options are shown:-

ml/min

ml/s

ft³/yr

ppm

sccm

mm³/s

mm³/min

Some Gas Check versions have a language selection where the units of ml are shown as cc instead, because this cc unit is more familiar than the SI based ml unit of identical volume.

Program

Display

General

The Gas Check LCD matrix display is arranged to show the leak rate and other relevant status information in a consistent fashion during the normal use and also during user changes to the settings of the application.

In normal use the upper portion of the LCD matrix is used for a large size digital representation of the leak rate and status information is shown as symbols appearing in the lower portion.

In response to Gas Check key presses, written text will appear across the middle of the matrix display, giving user confirmation of the changes to settings, while status symbols will also change consistently.

Examples are

Zeroing detector
Nozzle On
Peak hold On

Leak rate indication

Leakage is displayed as a single (signed) digit x 10 (signed) range for ease of interpretation and calibration. [Note that some gases (eg CO₂) may cause a negative leak indication after Gas Check zeroing in clean air.]

Examples are

Leak rate for a positive gas: 5×10^{-5} ml/s
Leak rate for a negative gas: -3×10^{-4} ml/s

| Gas | Gas Group | Positive/Negative |
|-----------------|-----------|-------------------|
| H ₂ | 0 | Positive |
| He | 0 | Positive |
| R12 | 1 | Negative |
| R1301 | 1 | Positive |
| R134a | 1 | Negative |
| SF ₆ | 1 | Negative |
| R22 | 1 | Negative |
| CO ₂ | 2 | Negative |
| CH ₄ | 2 | Positive |
| Ar | 2 | Negative |
| R11 | 3 | Positive |
| O ₂ | 4 | Positive |

Note that for the named gases the response of the Gas Check 5000is series after zeroing will be only permitted in the same sense as for that named gas, ie positive for helium, negative for R134a.

Program

Other display symbols

Small display indicators show zeroing, nozzle fitted, peak hold and low battery voltage.

Zeroing This symbol appears whilst the Gas Check is zeroing then it disappears.



Nozzle This symbol indicates that the Gas Check is being used with the Nozzle on.



Peak hold This symbol indicates that the Gas Check display is held to the maximum.



Low battery This symbol indicates that the battery pack is lower than required for use.



Alarm bell This symbol shows that the alarm level has been set up for use.



ABC This symbol shows that the Automatic Background Compensation is applied



Auto Range This symbol shows when the Gas Check leak rate is not in a fixed range.



Data Logging This symbol shows continuous Data Logging is in progress



Data Logged This symbol shows continuous Data Logging was completed (each dash =10%)



Audio This shows that the audible/visual leak rate indication is ON



Exponent This symbol lies below the leak range exponent in the bar graph mode



Negative This shows the leak rate is negative



Bar graph The leak reading shown below is $2 \times 10^{-}$ (Exponent range shown)

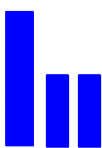

Program

Audio and visual outputs

The Gas Check 5000is series have an internal audio sounder and a flashing LED indicator. They both operate together when the detected leak rate climbs from the zero indication towards the maximum on the leak rate range. They also operate once to confirm a key press.

Prepare the Gas Check

Select which probe to use

Note: Whenever possible, use the Gas Check with the nozzle fitted. The nozzle helps to protect the short probe from blockage or damage. You cannot use the nozzle with the long probe.

Open the storage case and remove the Gas Check. The Gas Check is supplied with the short probe fitted and the nozzle fitted; a long probe is supplied in the storage case. Determine whether you want to use the short probe or the long probe and whether you want the nozzle fitted, as follows:

Use the Gas Check with the short probe and without the nozzle to detect small leak rates of approximately 1 x 10⁻⁴ ml/sec and lower. Press the nozzle key to clear the nozzle fitted indicator.

For large leaks, use the Gas Check with the short probe and the nozzle fitted. The nozzle extends the detection range for more accurate measurement of large leaks. Press the nozzle key to set the nozzle fitted indicator.

If the area you want to leak check has restricted access, remove the nozzle and the short probe and fit the long probe. The long probe is flexible and can be bent in a gentle arc so that it can reach areas that would otherwise be difficult to reach. Press the nozzle button to tell the Gas Check that the nozzle is not fitted when you fit the long probe. Note that response time increases significantly when the long probe is fitted.

The nozzle simply pulls off and pushes onto the end of the Gas Check.

Program

Remove the Gas Check nozzle or change the probe (if required)

In some applications the grey probe cover may restrict access to the area under test, the grey probe cover can be removed by pulling it off way from the instrument ❶. When the grey cover is removed great care should be taken when using the instrument and the following precautions noted:-

- * Do not remove the semi transparent probe sleeve, this sleeve ensure the metal inner probe remains 1 mm from the surface of the test area avoiding accidental dirt and moisture ingress.
- * Do not touch the probe and especially the brass sensor housing. Heat from fingers can result in significant changes in signal causing false readings.
- * Avoid placing the probe on wet or dirty surfaces, blockage of the probe will result in instrument failure.

Some application may require a longer probe to gain access to pneumatic joints and seams to be tested, the GasCheck is also supplied with a 300mm probe that can be changed by the user. To change probes carefully follow the following steps:-

- * Switch the instrument OFF
- * Remove the outer grey probe cover ❶
- * Place the box spanner (supplied with the instrument) over the existing probe so the spanner fits over the brass nut ❷, unscrew the probe counter-clockwise direction. ❸
- * Withdraw the spanner and probe assembly ❹

To refit the short or the long probe follow the steps above but in reverse order.

CAUTION: When using the box spanner to tighten the probe nut, ensure the nut is firmly tightened only by the hand. Do not use additional tools as the tread may become damaged.

Should a probe become blocked, use dry, clean compressed air to blow out the blockage from the instrument end of the probe (when the probe has been first removed off the instrument)

Cautionary Note: The instrument has been factory calibrated using the standard short capillary which sets a certain flow rate into the detector.

The long capillary by nature of its construction has a different flow to improve the time response in detection. This will change the calibration of the instrument when the long probe is used instead of the short capillary. Thus the long probe is only to be used in finding leaks in difficult places where the standard short probe cannot reach. The readings given by the long probe are only qualitative and the reading given by the display is only to be taken as being relative to another value given by another leak site while using the long probe.

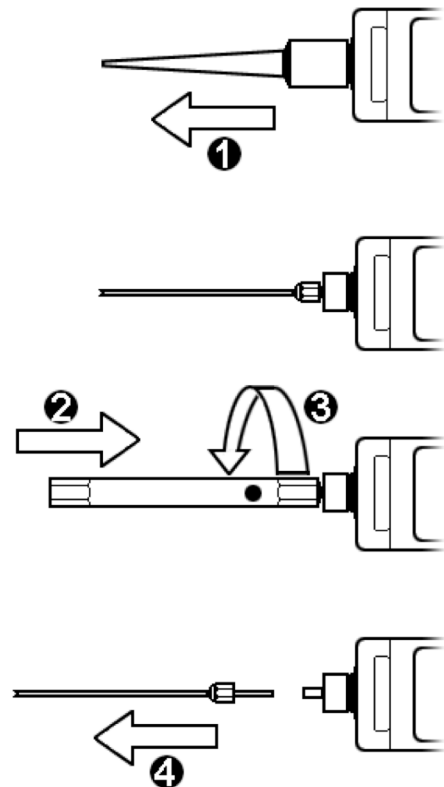

Program

WARNING: Ensure safety guidelines are adhered to when using compressed air.
(Ion Science Ltd takes no responsibility for injury or damage caused by misuse of compressed air equipment)

Switch on the Gas Check

Press I/O key and wait for Gas Check to bleep & flash, the LCD to light up and show

Ion Science Ltd
Cambridge
England

Then show
Gascheck 5000is
SW Version 1.49
Text Version 1.00

Then show
Zeroing Detector

After a short while the LCD display will then revert to the display format previously set up for the leak rate, which can be either the bar graph or the digital display, the latter in normal or large numeric display format.

When not detecting leaking gas, Gas Check still flashes and beeps periodically to indicate that it is ON. Gas Check remembers the settings on instrument power off so that the operator rarely if ever has to alter any of them. The settings for gas groups, range, audio bleep, peak hold and nozzle are shown on the LCD.

The response of Gas Check can readily be checked against an Ion Science CalCheck. Alternatively the tracer gas supply can be suitably fitted with an Ion Science Ltd Standard Calibrated Leak.

Recommended leak search procedure

General procedure

Note: When you use the Gas Check, do not allow dirt or debris to enter the end of the probe or nozzle. If the probe or nozzle is blocked, the Gas Check will not operate correctly.

The following test procedures assume that you have fitted the short probe. The response time of the Gas Check increases from about 1 second or less when the short probe is fitted to about 9 seconds when the long probe is fitted. If you use the long probe for leak detection, ensure that you move the end of the probe much more slowly along the area you leak test.

Ensure the unit under test contains a reasonable percentage of a trace gas that is different from normal air!

Program

Move the end of the probe (or nozzle) around the area of a suspected leak and look at the display (or listen to the audible clicks or note the visual LED flash rate on the Gas Check) to identify the location of a leak. Specific procedures for leak detection along seams and around pipe joints are described in the following sections.

When required:

Use the peak hold and Auto-Ranging modes to continue to check for leaks, but to display the largest leak detected

If you want to zero the Gas Check, move the end of the probe (or nozzle) away from any possible leak, into a clean air zone, then press the manual zero key.

Note that leak sensitivity depends on the ambient conditions. If you want to accurately measure a leak, compare the indicated leak with a calibration standard, such as a portable reference leak.

When the Gas Check indicates that a leak has been found, move the probe (or nozzle) back to determine the precise location of the leak. The leak is located where the largest leak size is indicated on the display and where highest frequency clicks and visual flashing rate are emitted by the Gas Check, on the current range.

Leak detection along seams

Move the end of the Gas Check probe (or nozzle) along the length of the seam, so that it just rests on the seam. The speed at which you move along the seam depends upon the size of the leak that you search for:

If the leak is large, you can move fairly fast along the seam, at approximately 25 mm per second.

If the leak is small, move slowly along the seam, at approximately 10 mm per second.

Leak detection at pipe joints

Use the same procedure as for leak detection along seams, however move the probe (or nozzle) around the joint at approximately half the speed. Light gases (such as hydrogen and helium) diffuse quickly into air, so an apparent leak on the side or top of a joint may actually be a leak at the bottom of the joint.

Data logging – interruption for menu access

Gas Check 5000is settings are protected during data logging. Press the INFO key to enter a menu dialogue.

Switch off the Gas Check

When the Gas Check 5000is has been left for a few seconds without any key press, then press the I/O key. The Gas Check will ignore I/O presses during the instrument power up sequence and during any zeroing.

Auto Shut Down

The unit will auto shut down after approximately 10 minutes (if the keys have not been pressed and the signal has been less than half full scale of the range selected)

Maintenance

Inspect and clean the Gas Check

CAUTION

Do not clean the probe while it is attached to the Gas Check and do not try to clean the sample hole inside the probe/nozzle fitting which leads to the detector. If you do, you can damage the Gas Check.

Switch off the Gas Check.

Refer to Figure 5. If the nozzle is fitted, hold the nozzle (1) by its wide base and gently twist and pull it to remove it from the Gas Check.

With the small end of the box spanner towards the Gas Check, guide the end of the probe (2 or 7) through the middle of the box spanner. Push the box spanner onto the nut (3) and turn the box spanner anticlockwise to undo and remove the probe.

Inspect the Gas Check. If the case of the Gas Check is cracked or dented, we recommend that you do not continue maintenance, but return the Gas Check to your supplier for inspection and calibration.

Wipe the Gas Check with a clean, lint-free cloth moistened with a weak solution of detergent.

Carefully wipe the outer faces of the probe/nozzle fitting to remove any small particles of dirt or debris.

Use a suitable tool to push any blockage out of the end of the nozzle, then wipe the outside of and the inner face of the wide part of the nozzle.

Inspect the probe:

The hole in the short probe is approximately 0.47mm (0.0185inches) in diameter. We recommend that you push stiff wire of 0.25mm (0.01inches) diameter or less into the hole in the probe to remove any blockage. The long probe is too long to be effectively cleaned. If the probe is blocked, we recommend that you obtain a new probe, available as a spare.

Refit the required probe to the Gas Check.

Place a light wipe of thin petroleum jelly around the inner face of the wide part of the nozzle, then fit the nozzle to the Gas Check.

Place the Gas Check and nozzle (and the long probe, if just removed) in its storage case. Store the case in suitable conditions.

Maintenance

Replace the batteries

WARNING

Replace the batteries in the Gas Check 5000is in a safe area where there are no flammable gases. If you do not, there may be a risk of fire or explosion.

WARNING

Use only dry cell (non-rechargeable AA) batteries or Ion Science AAA Rechargeable Battery Pack (part No. A-31117) in the GasCheck 5000is. The internal resistance of unpotted rechargeable batteries is too low to maintain a T4 safety rating. The recommended batteries are specified in Battery Data.

CAUTION

The Gas Check 5000is will blow a factory fitted internal protection fuse if the battery clip is reverse connected. The complete instrument will have to be returned to the supplier for fuse replacement.

Ensure that the rubber sleeve on the female part of the battery holder is correctly fitted when you fit new batteries. If you do not, you could refit the holder in the Gas Check 5000is with incorrect polarity, which will blow an internal fuse and make it inoperative.

Note: A spare battery holder is supplied in the case.

Refer to Figure 6. Turn over the Gas Check so that the battery compartment is at the top: see detail A.

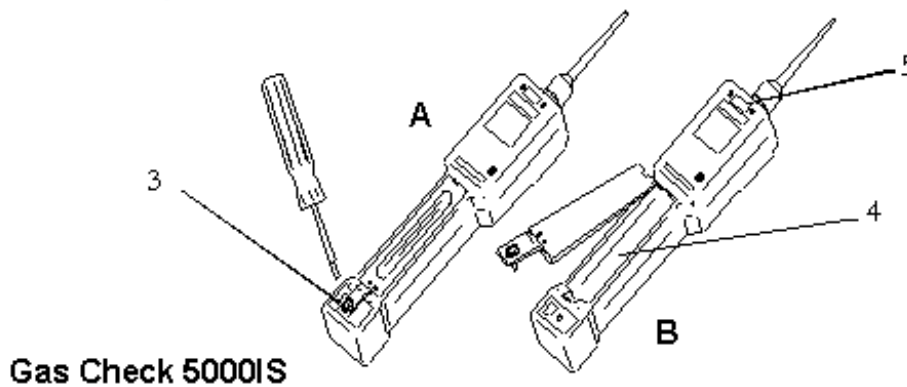

- | | | | |
|---|---------------------------|---|---------------------|
| 1 | Catch | 4 | Battery compartment |
| 2 | Battery compartment cover | 5 | Serial number |
| 3 | Captive screw | | |

Figure 6 – Replace the batteries

Maintenance

On the Gas Check 5000is, use the special screwdriver supplied to undo the captive screw on the battery compartment cover and remove the cover. This is located at the end of the Gas Check at position (5).

Remove the battery holder. If required, you can carefully unplug the battery holder so that you can detach the holder from the Gas Check.

Remove the old batteries (4) from the battery holder. Dispose of the batteries. Inspect the inside of the battery compartment and battery holder. If the batteries have leaked, use a cloth dampened with a weak solution of detergent to clean the battery compartment and battery holder.

CAUTION

The Gas Check 5000is will blow a factory fitted internal protection fuse if the battery clip is inadvertently reverse connected. The complete instrument will have to be returned to the supplier for fuse replacement.

Fit four new batteries in the battery holder. Ensure that you fit the batteries in the correct orientation. Refit the battery holder to the Gas Check.

.On the Gas Check 5000is, refit the battery compartment cover and use the special screwdriver to tighten the captive screw and secure the cover in place.

CAUTION

Ensure that the screw is located squarely to the threaded insert before tightening else the battery compartment cover may not be properly secured due to cross threading. The instrument will then have to be returned to the supplier for replacement of the Gas Check case and new serial number.

Switch on the Gas Check to ensure that the batteries are correctly fitted. If the display remains blank when you switch on the Gas Check.

Maintenance

Fault finding

| Fault symptom | Diagnosis | Action |
|--------------------------------|----------------------------------|---|
| Unit will not switch on | No/dead batteries fitted | Try another battery set (safely) |
| Unit will not switch off | Software locked out | Remove & replace battery clip (safely) |
| Battery symbol appears | Battery state low | Replace batteries (safely) |
| Back light drains battery life | Excessive use of backlight | Avoid or reduce use of backlight |
| Unit will not zero | Software locked out by hardware | Remove & replace batteries (safely) |
| LCD appears blank/dim | Contrast control setting wrong | Turn off & on; press & hold contrast |
| Bar graph/number do not change | Peak hold selected | Press zero or change Peak Hold state |
| Range does not change | Range not set in Auto-range | Press & hold Range until Auto-range |
| He range will not show -5 | Unit with nozzle ON and/or range | Reset via Nozzle and Range keys |
| Gas group is wrong | Gas Group not set correctly | Press & hold Gases until shown OK |
| Nozzle/Peak not showing | Nozzle/Peak is not set correctly | Press & hold Nozzle until both correct |
| Calibration due message | Unit has exceeded 1 year on cal | Return to Ion Science for recalibration |
| Unit will not zero correctly | Sensor contaminated | Leave to stabilise |
| Blocked probe | Probe blocked by solid or liquid | Remove probe; clean; check now OK |
| Stalled motor | Motor failed & probe not blocked | Return to supplier for repair |
| Instrument readings noisy | Loose probe | Tighten nut slightly |
| Instrument readings noisy | Test environment contaminated | Move test into clean area |
| 5000is will not switch on | Internal fuse blown | Return to supplier for repair |

Table 5 – Fault finding

Storage and Disposal

Storage

If you will store the Gas Check for a long time, we recommend that you remove the batteries.

Refit the Gas Check in its storage case and store in dry, cool conditions. When required for use, unpack.

Disposal

Dispose of the Gas Check, components and used batteries safely in accordance with all local and national safety and environmental requirements. Some of the Gas Check carry case plastic material is recyclable.

Spares and accessories

Order spare parts from your local agent or distributor. When you order, please state for each part required:

Serial Number on the back of your Gas Check - refer to Figure 6.

Item Number and description of part.

Spares

| Spare | Item Number |
|----------------------------|-------------|
| Long probe | A-8045 |
| Short probe | A-8043 |
| Replacement battery holder | A-08139 |
| Nozzle 5000is | 08024CPC0 |
| Box spanner | A-08029 |
| 5000is screwdriver | 4/TS-01 |
| Case | 31164 |
| Manual | 28053 |

Accessories

| Accessories | Item Number |
|--|--------------------|
| CalCheck -Specifying: Gas, Leak rate and pressure | A-21500 |
| IR Data Link -AAA Rechargeable Battery Pack | A-28170 A-31117 |

-Specifying: voltage: A=USA, K=UK , E=Euro, U=Universal and C=Car.

Calibration

Ion Science offer a calibration service including issue of traceable certification to National Standards.

Refurbish program

Ion Science offer a refurbishment service for all customer repairs

Instrument warranty and service

Warranty

Standard Warranty can be extended to up to 2 years on the GasCheck 5000 when registering your instrument via our website: <http://www.ionscience.com/instrument-registration>

To receive your Extended Warranty, you need to register within one month of purchase (Terms and Conditions apply). You will then receive a confirmation email that your Extended Warranty Period has been activated and processed.

Full details, along with a copy of our Warranty Statement can be found by visiting:
<http://www.ionscience.com/instrument-registration>

Service

At Ion Science we recommend that all of our gas detection instruments be returned for service and factory calibration once every 12 months.

Contact Ion Science or your local distributor for service options in your area.

[Find](http://www.ionscience.com) your local distributor by visiting: www.ionscience.com

Contact Details:

UK Head Office

Ion Science Ltd
The Way, Fowlmere
Cambridge
SG8 7UJ
UK

Tel: +44 (0)1763 207206

Fax: +44 (0) 1763 208814

Email: info@ionscience.com

Web: www.ionscience.com

USA Office

Ion Science LLC
33 Commercial Drive
Waterbury
VT 05676
USA

Tel: +1 802 244 5153

Fax: +1 802 244 8942

Email: info@ionscienceusa.com

Web: www.ionscience.com

German Office

Ion Science Messtechnik GMBH
Laubach 30
Metmann-Neandertal
40822
GERMANY

Tel: +49 2104 14480

Fax: +49 2104 144825

Email: info@ism-d.de

Web: www.ism-d.de

Manual log

| Manual Version | Amendment | Date updated | Instrument Firmware | PC Software |
|--------------------|---|--------------|---------------------|-------------|
| GasCheck 5000 V1.4 | Gas Table updated | 16/7/08 | V4.16 | V3.26 |
| GasCheck 5000 V1.5 | Update log added to back of manual | 9/1/09 | V4.16 | V3.26 |
| GasCheck 5000 V1.6 | Warranty added on cover Declaration of Conformity updated Contents updated Warranty and Service added page 40 | 23/07/10 | V4.16 | V3.26 |
| Gascheck 5000 V1.7 | Cautionary note added page 2/ | 19/9/10 | V4.16 | V3.26 |
| Gascheck 5000 V1.8 | AAA Rechargeable Battery information added. Pages 11,12,37 & 40 | 3/12/10 | V4.16 | V3.26 |
| Gascheck 5000 V1.9 | Reformatted | 7/6/11 | V4.16 | V3.26 |
| GasCheck 5000 V2.0 | Outer front cover updated. Instrument registration note added to inside front cover. Font and layout also updated | 24/04/13 | V4.16 | V3.26 |
| GasCheck 5000 V2.1 | Changed Baseefa No on Pages 3 and 5 | 3/7/14 | V4.16 | V3.26 |
| GasCheck 5000 V2.2 | Certification report updated | 11/12/14 | V4.16 | V3.26 |