

User Manual

Tektronix

**DDS200
Digital Demodulation System**

070-9952-00

CE

Copyright © Tektronix, Inc. All rights reserved.

Tektronix products are covered by U.S. and foreign patents, issued and pending. Information in this publication supercedes that in all previously published material. Specifications and price change privileges reserved.

Printed in the U.S.A.

Tektronix, Inc., P.O. Box 1000, Wilsonville, OR 97070-1000

TEKTRONIX and TEK are registered trademarks of Tektronix, Inc.

WARRANTY

Tektronix warrants that the products that it manufactures and sells will be free from defects in materials and workmanship for a period of one (1) year from the date of shipment. If a product proves defective during this warranty period, Tektronix, at its option, either will repair the defective product without charge for parts and labor, or will provide a replacement in exchange for the defective product.

In order to obtain service under this warranty, Customer must notify Tektronix of the defect before the expiration of the warranty period and make suitable arrangements for the performance of service. Customer shall be responsible for packaging and shipping the defective product to the service center designated by Tektronix, with shipping charges prepaid. Tektronix shall pay for the return of the product to Customer if the shipment is to a location within the country in which the Tektronix service center is located. Customer shall be responsible for paying all shipping charges, duties, taxes, and any other charges for products returned to any other locations.

This warranty shall not apply to any defect, failure or damage caused by improper use or improper or inadequate maintenance and care. Tektronix shall not be obligated to furnish service under this warranty a) to repair damage resulting from attempts by personnel other than Tektronix representatives to install, repair or service the product; b) to repair damage resulting from improper use or connection to incompatible equipment; c) to repair any damage or malfunction caused by the use of non-Tektronix supplies; or d) to service a product that has been modified or integrated with other products when the effect of such modification or integration increases the time or difficulty of servicing the product.

THIS WARRANTY IS GIVEN BY TEKTRONIX IN LIEU OF ANY OTHER WARRANTIES, EXPRESS OR IMPLIED. TEKTRONIX AND ITS VENDORS DISCLAIM ANY IMPLIED WARRANTIES OF MERCHANTABILITY OR FITNESS FOR A PARTICULAR PURPOSE. TEKTRONIX' RESPONSIBILITY TO REPAIR OR REPLACE DEFECTIVE PRODUCTS IS THE SOLE AND EXCLUSIVE REMEDY PROVIDED TO THE CUSTOMER FOR BREACH OF THIS WARRANTY. TEKTRONIX AND ITS VENDORS WILL NOT BE LIABLE FOR ANY INDIRECT, SPECIAL, INCIDENTAL, OR CONSEQUENTIAL DAMAGES IRRESPECTIVE OF WHETHER TEKTRONIX OR THE VENDOR HAS ADVANCE NOTICE OF THE POSSIBILITY OF SUCH DAMAGES.

Contacting Tektronix

Product Support	<p>For application-oriented questions about a Tektronix measurement product, call toll free in North America: 1-800-TEK-WIDE (1-800-835-9433 ext. 2400) 6:00 a.m. – 5:00 p.m. Pacific time</p> <p>Or contact us by e-mail: tm_app_supp@tek.com</p> <p>For product support outside of North America, contact your local Tektronix distributor or sales office.</p>
Service Support	<p>Contact your local Tektronix distributor or sales office. Or visit our web site for a listing of worldwide service locations.</p> <p>http://www.tek.com</p>
For other information	<p>In North America: 1-800-TEK-WIDE (1-800-835-9433) An operator will direct your call.</p>
To write us	<p>Tektronix, Inc. P.O. Box 1000 Wilsonville, OR 97070-1000</p>

Table of Contents

General Safety Summary	xi
Preface	xiii
Preparation for Use	
Legends for the Front and Rear View	1-1
Front Panel	1-2
Rear Panel	1-5
Unpacking the Unit	1-8
Accessories	1-8
Standard Accessories	1-8
Options	1-8
Optional Accessories	1-9
Installation	1-9
Positioning the Unit	1-10
Connecting the Unit to the AC Supply	1-11
Replacing Fuses	1-11
EMC Protective Measures	1-11
Powering On	1-12
Setting the Contrast of the Display	1-13
Installing Firmware	1-13
Connecting Input and Output Signal	1-15
Battery-Backed Memory	1-15
Functional Test	1-15
Installing Options	1-16
Installing a printer	1-16
Serial Interface	1-16
IEC/IEEE-Bus Connector	1-17
Manual Operation	
Sample Setting	2-2
Powering on the Unit	2-2
Using the main menu MODE hard key	2-3
Selecting the Mode	2-3
Using the main menu INPUT hard key	2-4
Selecting the Input	2-4
Setting the RF Frequency	2-6
Basic Operation	2-8
Overview	2-8
Display	2-9
LEDs	2-11
Soft Keys	2-12
Cursor Keys	2-13
Numeric Keypad	2-14
Selecting Settings	2-14
Editing Text and Numerals	2-15
Presetting the Unit	2-16

Hardcopy Key	2-17
STO/RCL – Storing Device Settings	2-17
Hard Keys	2-18
General Device Settings	2-19
Introduction	2-19
SETUP Menu	2-19
Operation as Demodulator for Quadrature-Amplitude-Modulated (QAM) Signals	2-26
Overview	2-26
INPUT Menu / Input Selection	2-27
RF Menu	2-29
STATUS Menu	2-30
SPECIAL FUNCTION Menu	2-34
ALARM Menu	2-38
MEASURE Menu	2-46
Preset Values and Menu Overview	2-58
Examples of Application	2-62

Remote Control

Brief Instructions	3-1
Switching to Remote Control	3-2
Setting the Device Address	3-2
Displays in Remote Control	3-2
Return to Manual Control	3-3
IEC/IEEE-Bus Messages	3-4
Interface Messages	3-4
Device-Dependent Messages (Commands and Responses)	3-4
Structure and Syntax of Device-Dependent Messages	3-5
SCPI Introduction	3-5
Command Structure	3-5
Structure of a Command Line	3-8
Responses to Queries	3-9
Parameters	3-9
Overview of Syntax Elements	3-11
Description of Commands	3-11
Notation	3-11
Common Commands	3-12
Instrument Model and Command Processing	3-16
Input Unit	3-16
Command Identification	3-16
Data Set and Device Hardware	3-17
Status Reporting System	3-17
Output Unit	3-18
Command Sequence and Command Synchronization	3-18
Status Reporting System	3-19
Structure of a SCPI Status Register	3-19
Overview of Status Registers	3-22
Description of Status Registers	3-23
Use of the Status Reporting System	3-26

Resetting the Status Reporting System	3–28
---	------

Maintenance and Troubleshooting

Maintenance	4–1
Troubleshooting	4–2
Self Test (QAM)	4–3

Appendices

Appendix A: Specifications	A–1
Appendix B: IEC/IEEE-Bus Interface	B–1
Interface Characteristics	B–1
Bus Lines	B–1
Interface Functions	B–3
Interface Messages	B–3
Common Commands	B–3
Addressed Commands	B–4
Appendix C: List of Error Messages	C–1
SCPI-Specific Error Messages	C–1
Appendix D: List of Commands	D–1
Common Commands	D–1
STATus Subsystem	D–2
SYSTem Subsystem	D–4
ROUTe Subsystem	D–5
INPut Subsystem	D–6
SENSe Subsystem	D–7
MEMory Subsystem	D–11
UNIT Subsystem	D–11
READ Subsystem	D–12
CONFigure Subsystem	D–15
Hcopy Subsystem	D–19
Appendix E: Programming Examples	E–1
Incorporating IEC/IEEE-Bus Library for QuickBASIC	E–1
Initialization and Initial Status	E–1
Sending Device Setting Commands	E–2
Switchover to Manual Control	E–2
Readout of Device Settings	E–2
List Management	E–2
Command Synchronization	E–2
Service Request	E–4
Appendix F: Remote Control via RS-232-C Interface	F–1
Setting the Transmission Parameters	F–1
Displays in Remote Control	F–1
Return to Manual Control	F–1
Characteristics of Interface	F–2
Signalling Lines	F–2
Transmission Parameters	F–3
Interface Functions	F–4
Handshake	F–5
Software Handshake	F–5

Local controller connection for Software Handshake	F-6
Hardware Handshake	F-6
Local Controller Connection for Hardware Handshake	F-7

Index

List of Figures

Figure 2–1: Front-panel controls	2–1
Figure 2–2: QAM MEASURE menu	2–3
Figure 2–3: MODE menu	2–4
Figure 2–4: INPUT menu	2–5
Figure 2–5: INPUT:RECEIVER ATTENUATION menu	2–6
Figure 2–6: RF menu	2–7
Figure 2–7: MEASURE menu	2–10
Figure 2–8: RF menu	2–10
Figure 2–9: RF menu	2–12
Figure 2–10: RF:STO RF:EDIT TEXT menu	2–15
Figure 2–11: PRESET Menu	2–16
Figure 2–12: PRESET menu	2–16
Figure 2–13: STORE menu	2–17
Figure 2–14: RECALL menu	2–18
Figure 2–15: Menu SETUP	2–19
Figure 2–16: SETUP: TIME DATE Menu	2–20
Figure 2–17: SETUP:REMOTE menu	2–21
Figure 2–18: SETUP:REMOTE:IEC625-IEEE488 menu	2–22
Figure 2–19: SETUP:REMOTE:RS232 menu	2–22
Figure 2–20: SETUP: PRINTER menu	2–23
Figure 2–21: SETUP:LEVEL UNITS menu	2–24
Figure 2–22: Mode menu	2–25
Figure 2–23: INPUT menu	2–27
Figure 2–24: INPUT: ATTENUATION menu	2–28
Figure 2–25: RF menu	2–29
Figure 2–26: STO: EDIT TEXT menu	2–30
Figure 2–27: STATUS menu	2–31
Figure 2–28: STATUS: SYMBOL RATE menu	2–32
Figure 2–29: SPECIAL FUNCTION menu	2–34
Figure 2–30: SPECIAL FUNCTION: MPEG DATA OUTPUT menu	2–36
Figure 2–31: ALARM: CONFIG menu	2–38
Figure 2–32: ALARM Register menu	2–40
Figure 2–33: ALARM TRESH menu	2–41
Figure 2–34: ALARM: STATISTICS menu	2–42

Figure 2–35: ALARM: PRINT menu in the QAM demodulator mode	2–43
Figure 2–36: ALARM: PRINT: LAST LINES... menu	2–44
Figure 2–37: MEASURE menu	2–46
Figure 2–38: Recording the BER: running BER calculation over 10 samples	2–49
Figure 2–39: Noise at input, no QAM signal	2–50
Figure 2–40: QAM signal with unsynchronized carrier and symbol rate	2–51
Figure 2–41: QAM signal with unsynchronized carrier	2–51
Figure 2–42: Correctly synchronized 64QAM signal	2–52
Figure 2–43: MEASURE: CONSTELLATION DIAGRAM menu	2–52
Figure 2–44: Function of GATE TIME and GATE CNT	2–53
Figure 2–45: MEASURE: SPECTRUM menu	2–56
Figure 2–46: MEASURE: ECHO PATTERN menu in the QAM demodulator mode	2–57
Figure 2–47: Constellation diagram of ideal 64QAM signal	2–63
Figure 2–48: Constellation diagram of 64QAM signal with 20% amplitude imbalance	2–64
Figure 2–49: Constellation diagram of 64QAM signal with 85 phase error	2–64
Figure 2–50: Constellation diagram of 64QAM signal with interferer ($C/I = 25.0$ dB)	2–65
Figure 2–51: Constellation diagram of 64QAM signal with residual carrier in I component ($CS = 17.6$ dB)	2–66
Figure 2–52: Constellation diagram of 64QAM signal with additive noise ($SNR = 30.0$ dB)	2–67
Figure 2–53: Constellation diagram of 64QAM signal with phase jitter: $PJRMS = 1.735$	2–68
Figure 2–54: Sectional view for ideal signal (a) and signal with interferer (b)	2–70
Figure 2–55: Frequencies of occurrence shown by sectional views: superimposed Gaussian curves at various noise levels and with same interferer for 64QAM	2–71
Figure 2–56: Improvement of accuracy with superimposed noise ($SNR = 45$ dB)	2–73
Figure 2–57: Positions of vectors used for determining the modulation error (64QAM, first quadrant only)	2–75
Figure 2–58: Intermodulation due to 2nd-order nonlinearities	2–77
Figure 2–59: Intermodulation due to 3rd-order nonlinearity	2–78

Figure 2–60: Setup for external BER measurement	2–80
Figure 2–61: BER as a function of C/N ratio	2–83
Figure 2–62: Effect of receive filter on C/N value C/Nrec: C/N after receive filter. C/NC: C/N ahead of receive filter (in channel)	2–84
Figure 2–63: Assignment of parallel MPEG data interface (X31)	2–86
Figure 2–64: Signals at parallel interface in 188-byte mode (STATUS: SER/PAR MPEG FRAME SIZE)	2–87
Figure 2–65: Signals at parallel interface in 204-byte mode (STATUS: SER/PAR MPEG FRAME SIZE)	2–87
Figure 2–66: Cascading of two DDS200s	2–88
Figure 3–1: Tree structure of SCPI command system using SENSE as an example	3–6
Figure 3–2: Instrument model with remote control via IEC/IEEE bus	3–16
Figure 3–3: Status Register Model	3–19
Figure 3–4: Overview of status registers	3–22
Figure F–1: Transmission of character A in 7-bit ASCII code, even parity, 2 stop bits	F–3
Figure F–2: Wiring for software handshake	F–6
Figure F–3: Wiring for hardware handshake	F–7

List of Tables

Table 1–1: Legend for front view	1–2
Table 1–2: Legend for rear view	1–5
Table 2–1: SETUP REMOTE menu selections	2–21
Table 2–2: Messages displayed in the MEASURE menu	2–47
Table 2–3: Suitable limit values for QAM parameters	2–55
Table 2–4: DDS200 Preset Values	2–58
Table 2–5: Theoretical maximum and minimum values of calculated parameters for various orders of QAM	2–74
Table 2–6: Limit values for modulation error	2–75
Table 2–7: Limit values for modulation error	2–76
Table 2–8: Assignment of parallel MPEG data interface	2–86
Table 2–9: Cascading of two DDS200s	2–88
Table 3–1: Synchronization with *OPC, *OPC? and *WAI	3–18
Table 3–2: Definition of bits in the Status Byte Register	3–23
Table 3–3: Definition of bits used in the Event Status Register	3–24
Table 3–4: Definition of bits used in the STATUS:OPERation Register	3–25
Table 3–5: Definition of bits used in the STATUS:QUEStionable Register	3–26
Table 3–6: Resetting the device functions	3–28
Table 4–1: Assignment of error message numbers to binary error code	4–4
Table 4–2: Conversion of displayed hexadecimal code into binary code	4–4
Table A–1: Electrical Specifications	A–1
Table A–2: Certifications and compliances	A–4
Table A–3: Power Characteristics	A–5
Table A–4: Environmental Characteristics	A–5
Table A–5: Physical Characteristics	A–5
Table B–1: Bus Lines	B–2
Table B–2: Interface functions	B–3
Table B–3: Common commands	B–3

Table B-4: Addressed commands	B-4
Table C-1: No error	C-1
Table C-2: Command errors	C-1
Table C-3: Execution errors	C-4
Table C-4: Device-specific error	C-8
Table C-5: Query errors	C-8
Table D-1: Common Commands	D-1
Table D-2: STATus Commands	D-2
Table D-3: SYSTem Commands	D-4
Table D-4: ROUTe Commands	D-5
Table D-5: INPut Commands	D-6
Table D-6: SENSE Commands	D-7
Table D-7: MEMory Commands	D-11
Table D-8: UNIT Commands	D-11
Table D-9: READ Commands	D-12
Table D-10: CONFigure Commands	D-15
Table D-11: HCOPy Commands	D-19
Table F-1: Pin assignment of RS-232-C interface	F-2
Table F-2: Control characters of RS-232 Interface	F-4

General Safety Summary

Review the following safety precautions to avoid injury and prevent damage to this product or any products connected to it. To avoid potential hazards, use this product only as specified.

Only qualified personnel should perform service procedures.

To Avoid Fire or Personal Injury

Use Proper Power Cord. Use only the power cord specified for this product and certified for the country of use.

Use Proper Voltage Setting. Before applying power, ensure that the line selector is in the proper position for the power source being used.

Connect and Disconnect Properly. Do not connect or disconnect probes or test leads while they are connected to a voltage source.

Ground the Product. This product is grounded through the grounding conductor of the power cord. To avoid electric shock, the grounding conductor must be connected to earth ground. Before making connections to the input or output terminals of the product, ensure that the product is properly grounded.

Observe All Terminal Ratings. To avoid fire or shock hazard, observe all ratings and markings on the product. Consult the product manual for further ratings information before making connections to the product.

Do not apply a potential to any terminal, including the common terminal, that exceeds the maximum rating of that terminal.

Replace Batteries Properly. Replace batteries only with the proper type and rating specified.

Do Not Operate Without Covers. Do not operate this product with covers or panels removed.

Use Proper Fuse. Use only the fuse type and rating specified for this product.

Avoid Exposed Circuitry. Do not touch exposed connections and components when power is present.

Wear Eye Protection. Wear eye protection if exposure to high-intensity rays or laser radiation exists.

Do Not Operate With Suspected Failures. If you suspect there is damage to this product, have it inspected by qualified service personnel.

Do Not Operate in Wet/Damp Conditions.

Do Not Operate in an Explosive Atmosphere.

Keep Product Surfaces Clean and Dry.

Provide Proper Ventilation. Refer to the manual's installation instructions for details on installing the product so it has proper ventilation.

Symbols and Terms

Terms in this Manual. These terms may appear in this manual:



WARNING. Warning statements identify conditions or practices that could result in injury or loss of life.



CAUTION. Caution statements identify conditions or practices that could result in damage to this product or other property.

Terms on the Product. These terms may appear on the product:

DANGER indicates an injury hazard immediately accessible as you read the marking.

WARNING indicates an injury hazard not immediately accessible as you read the marking.

CAUTION indicates a hazard to property including the product.

Symbols on the Product. The following symbols may appear on the product:



WARNING
High Voltage



Protective Ground
(Earth) Terminal



CAUTION
Refer to Manual



Double
Insulated

Preface

This manual is divided into sections. The sections contain the following information:

- Section 1 describes the front- and rear-panel controls of the DDS200 Digital Demodulation System. Section 1 also provides information about operating the digital demodulation system for the first time. In addition, it contains a brief description of the external interfaces and the units that can be connected to them.
- Section 2 describes the basic manual operation of the digital demodulation system, explaining how to use the hard and soft keys to control the unit. This section also contains detailed descriptions of the menus and submenus.
- Section 3 explains the remote control of the digital demodulation system using the IEC-625/IEEE-488 bus and the RS232 interface.
- Section 4 discusses maintenance and troubleshooting procedures that an operator can perform.
- Section 5 has the following appendices:
 - Appendix A provides the specifications, certifications, and compliances for the DDS200.
 - Appendix B contains information about the IEC/IEEE-bus interface.
 - Appendix C lists the error messages that you may encounter while using the digital demodulation system.
 - Appendix D lists all the commands that can be used to remotely operate the digital demodulation system.
 - Appendix E provides programming examples that you can use as an aid to solving complex programming tasks.
 - Appendix F provides information about the RS-232-C interface.
- Section 6 is the index.



Preparation for Use

This section discusses general instructions on the preparation for use and the operation of the DDS200 Digital Demodulation System. It contains brief explanations of the controls and connectors on the front and rear panels. This section also provides instructions on operating the DDS200 for the first time.

Legends for the Front and Rear View

The controls and indicators of the DDS200 are combined into color-coded functional groups. The individual groups of control elements are described in Table 1-1 (front panel) on page 1-2 and Table 1-2 (rear panel) on page 1-5.

Front Panel

Front view of DDS200

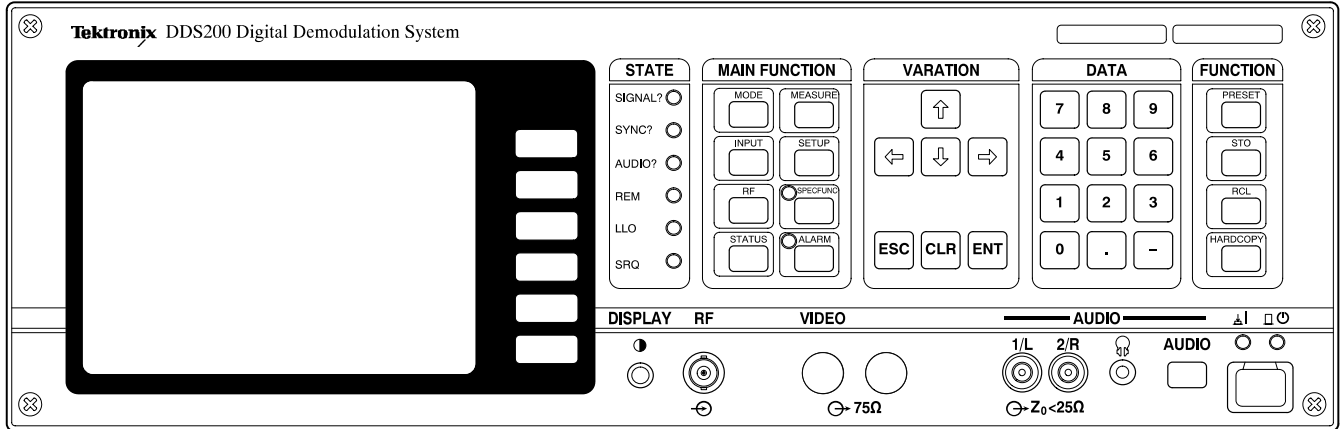

Table 1-1: Legend for front view



Controls/Connectors	Description
	<p>POWER</p> <p>When the DDS200 is connected to an AC supply and the power key on the rear panel is pressed, the yellow standby LED lights. On pressing the standby key, the standby LED turns off, and the green LED lights, indicating that the unit is now ready for operation.</p>
	<p>LCD DISPLAY</p> <p>Black-and-white LCD display (320 × 240 pixels) with back lighting.</p> <p>SOFTKEYS</p> <p>The displayed softkey labeling depends on the key pressed in the MAIN FUNCTION control section or on the submenu selected. The softkeys are used to activate menu-dependent functions.</p>
<p>DISPLAY</p> 	<p>DISPLAY</p> <p>With the rotary control, it is possible to set the optimum contrast of the display to suit the ambient temperature and viewing angle.</p>

Table 1-1: Legend for front view (Cont.)



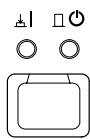
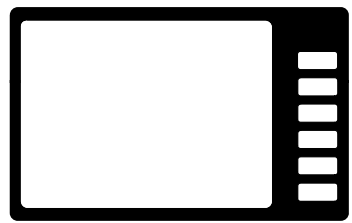

Controls/Connectors	Description
	<p>STATE</p> <p>SIGNAL? Indicates that the input signal is absent or too weak.</p> <p>SYNC? Signals synchronization problems</p> <p>AUDIO? For future use</p> <p>REM Signals that the unit is remote controlled</p> <p>LLO Indicates IEC/IEEE-bus local lockout</p> <p>SRQ Indicates IEC/IEEE-bus service request</p>
	<p>MAIN FUNCTION The following hard keys display corresponding menus when pressed:</p> <p>MODE</p> <p>MEASURE</p> <p>INPUT</p> <p>SETUP</p> <p>RF</p> <p>SPEC FUNC*</p> <p>STATUS</p> <p>ALARM†</p> <p>* LED lights when a special function is selected.</p> <p>† LED lights when there is an alarm.</p>
	<p>VARIATION</p> <p>Cursor keys Used to modify data entries step by step</p> <p>ESC key Displays the previously selected menu or submenu each time it is pressed</p> <p>CLR key Clears an entry to allow the correction of entered data</p> <p>ENT key Terminates the data entry when pressed</p>
	<p>DATA</p> <p>The DATA group consists of a keyboard for numeric data input. The function and effect depend on the menu selected.</p> <p>The entry is terminated with the ENT key.</p>

Table 1-1: Legend for front view (Cont.)

Controls/Connectors	Description	
	<p>FUNCTION</p>	<p>PRESET This key is used to reset the unit to the factory-default settings.</p> <p>STO This key stores device configurations.</p> <p>RCL This key loads device configurations.</p> <p>HARDCOPY This key prints the screen display to the connected print.</p>
<p>RF</p> 	<p>RF</p>	<p>This front-panel, 75 Ω, RF input connector is provided as an alternative to the rear-panel RF input connector (customer-specific); the actual configuration is indicated in the INPUT menu.</p>
<p>VIDEO</p>  <p>↻ 75Ω</p>	<p>VIDEO</p>	<p>This connector location is for future use.</p>
<p>AUDIO</p>  <p>↻ Z₀ < 25Ω</p>	<p>AUDIO</p>	<p>1 / L This connector is for future use.</p> <p>2 / R This connector is for future use.</p> <p> This connector is for future use.</p> <p>AUDIO This pushbutton is for future use.</p>

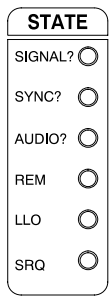
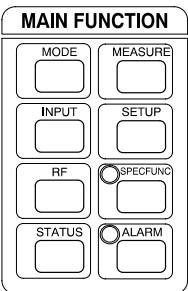
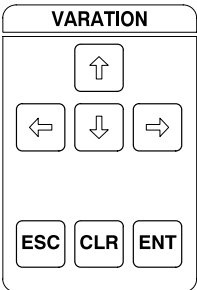
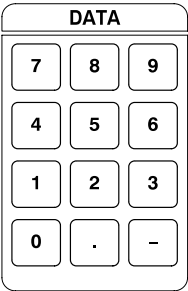
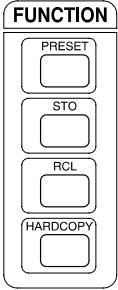
Rear Panel

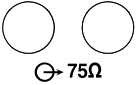
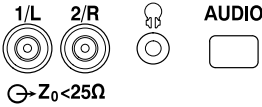
Rear view of DDS200

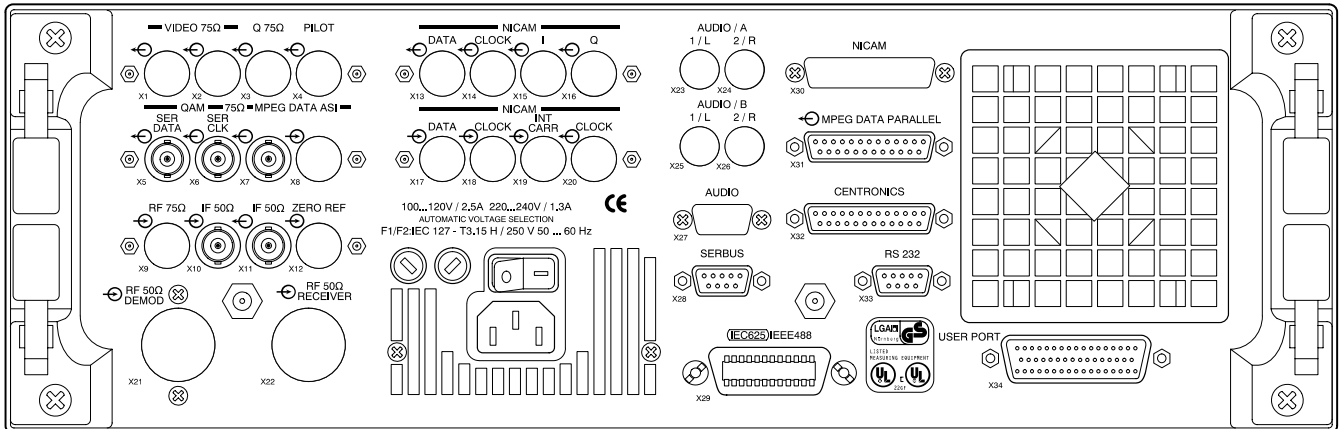

Table 1-2: Legend for rear view

Connectors	Description
<p>100...120V / 2.5A 220...240V / 1.3A AUTOMATIC VOLTAGE SELECTION F1/F2:IEC 127 - T3.15 H / 250 V 50 ... 60 Hz</p>	<p>AC supply connector</p> <p>AC supply switch and fuses:</p> <p>100 V/120 V: IEC127-T3.15 H / 250 V, 50 Hz to 60 Hz</p> <p>220/230 V : IEC127-T3.15 H / 250 V, 50 Hz to 60 Hz</p> <p>Automatic voltage selection</p>
	<p>BLOWER</p> <p><i>Caution:</i> To prevent damage caused by overheating, do not block the airflow of the blower.</p> <p>Temperature-regulated blower</p> <p>Internal temperature protection is provided in the unit if the blower fails; If the temperature rises higher than 80° C, the unit switches to standby operation.</p>
<p>VIDEO 75Ω Q 75Ω PILOT</p>	<p>X1 to X4</p> <p>These connector locations are for future use.</p>

Table 1-2: Legend for rear view (Cont.)



Connectors	Description	
	<p>X5 to X8</p>	<p>X5 QAM serial data output (75 Ω)</p> <p>X6 QAM serial clock output (75 Ω)</p> <p>X7 MPEG transport stream serial output (75 Ω)</p> <p>X8 This connector location is for future use.</p>
	<p>X9 to X12</p>	<p>X9 RF input 75 Ω (Option)</p> <p>Note: The instrument can have only one RF input. The RF connector is located either on the front panel or the rear panel. The customer selects the location of the connector.</p> <p>X10 IF input 50 Ω 200 mVpp</p> <p>X11 IF output 50 Ω 200 mVpp</p> <p>X12 This connector location is for future use.</p>
	<p>X13 to X20</p>	<p>These connector locations are for future use.</p>
	<p>X23 to X26 (AUDIO A / AUDIO B)</p>	<p>These connector locations are for future use.</p>
	<p>X27 (AUDIO)</p>	<p>This connector location is for future use.</p>
	<p>X28 (SERBUS)</p>	<p>Internal series data buses Serbus and I2C bus—only for maintenance and future external extensions.</p>
	<p>X29 (IEC 625)</p>	<p>This is the interface connector for the remote control of the unit. All device functions can be operated via the IEC/IEEE bus. All device states can also be queried.</p>
	<p>X30 (NICAM)</p>	<p>This connector location is for future use.</p>

Table 1-2: Legend for rear view (Cont.)

Connectors	Description	
 <p>MPEG DATA PARALLEL X31</p>	<p>X31 (TS PARALLEL)</p>	<p>This connector is MPEG transport stream parallel output.</p>
 <p>RF 50Ω DEMOD X21</p>	<p>X21 (RF 50 Ω DEMOD)</p>	<p>This connector location is for future use.</p>
 <p>RF 50Ω RECEIVER X22</p>	<p>X22 (RF 50 Ω RECEIVER)</p>	<p>This connector location is for future use.</p>
 <p>CENTRONICS X32</p>	<p>X32 CENTRON- ICS</p>	<p>This connector is a PC-compatible parallel printer interface.</p>
 <p>RS 232 X33</p>	<p>X33 (RS 232)</p>	<p>This connector is a serial, remote-control interface; it is also used to update firmware.</p>
 <p>USER PORT X34</p>	<p>X 34 (USER PORT)</p>	<p>This connector location is for future use.</p>

Unpacking the Unit

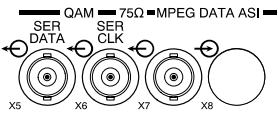
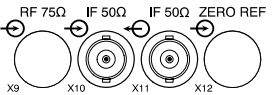
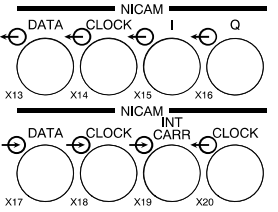
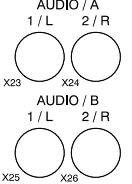
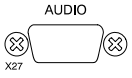
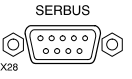
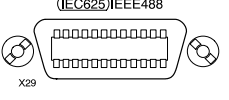
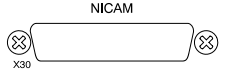
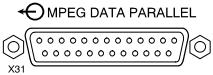
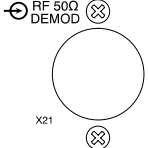
After removing the DDS200 Digital Demodulation System from the package, check it carefully for mechanical damage. If you find any damage, immediately contact the forwarding company concerned. In such a case, keep the cardboard box, packing material, and shipping documentation.

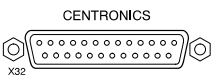
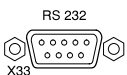
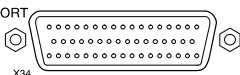
Accessories

The DDS200 Digital Demodulation System is shipped with several standard accessories. These accessories and any optional accessories are described below.

Standard Accessories

The following accessories are included with this product.

- User Manual, this manual (070–9952–00)
- Power cord: North America (161–0066–00)
- Fuse (0099.6729.00)

Options

The following options are orderable when you purchase the DDS200 Digital Demodulation System.

- Option 1R. Rackmount adapter for a 19 inch rack, with handles

Power Cord Options. If you do not specify a power cord option, the demodulator is shipped with a North American 125V power cord. The following power cord options are available when purchasing your DDS200 Digital Demodulation System.

- Option A1. Power, Universal Europe, 220 V/16 A (Locking Power Cord) (161-0066-09)
- Option A2. Power, United Kingdom, 240 V/15 A (Power Cord) (161-0066-10)
- Option A3. Power, Australia, 240 V/10 A (Power Cord) (161-0066-11)

Optional Accessories

The DDS200 Digital Demodulation System has a number of optional accessories that you can order to customize your instrument for your application.

- Service Manual (2068.0950.22–03)
- 75 Ω male type N to female type BNC adapter (103–0045–00)
- 42 in. RF cable, 75 Ω (012–0159–00)
- 72 in. RF cable, 75 Ω (012–0159–01)
- 42 in. RF cable, 50 Ω BNC–BNC (012–0057–01)
- 72 in. RF cable, 50 Ω BNC–BNC (012–0113–00)
- Rackmount adapter w/handles for a 19 in. rack (ZZA93)
- Rackmount adapter w/o handles for a 19 in. rack (ZZA931)
- Option A4. Power, North America, 250 V/10 A (Power Cord) (161-0066-12)
- Option A5. Power, Swiss, 240 V/6 A (Power Cord) (161-0154-00)

Installation

The following section describes how to prepare the DDS200 for operation.



CAUTION. To prevent damage to the instrument, make sure that the following conditions are true prior to operating the instrument:

- The covers are fastened in place
- The vents on the right at the side (as viewed from the front) and the blowers in the rear are not covered
- The AC supply voltage is within 100 V to 120 V or 220 V to 240 (+10%, –15%)
- Voltages applied to the inputs do not exceed the permissible limits (even in the switched-off state)
- The outputs of the instrument are not overloaded or incorrectly connected
- EMC protective measures (see page 1–11) are met

Failure to observe the above Caution may cause damage or malfunction of the instrument. The switching power supply automatically selects the correct voltage range (100 V to 120 V or 220 V to 240 V (+10%, –15%).

Positioning the Unit

The DDS200 is designed for use indoors. The location must meet the following requirements:

- Ambient temperature must be between 0 and +50° C.
- The vents (on the right at the side as viewed from the front) and the air outlet at the rear must not be covered. The minimum distance to the nearest wall must be four inches (ten centimeters).
- The unit must be placed on a flat surface.

Positioning the unit flat. The bottom of the unit is fitted with feet. To obtain an optimum viewing angle, lift the unit at its front and fold the feet down until they lock in position.

Positioning the unit upright. The unit also has four feet on the rear panel so that the unit can be positioned upright. To position the unit upright, perform the following steps:

1. Fold out the rear feet until they lock in position. The feet prevent the panel-mounted connectors from being damaged.
2. Place the unit on its rear feet. Ensure that any cables connected to the rear panel will not be damaged.
3. Check that the air outlet openings at the rear of the unit are not blocked.

Mounting the unit in a 19 inch Rack.



CAUTION. *To prevent damage to the unit when rackmounting, make sure that the inlet air can flow freely to the vents at the right hand side and that the outlet air is not blocked at the rear panel.*

The unit can be mounted in a 19 inch rack by means of Rack Adapter ZZA93. The mounting instructions are enclosed with the adapter.

Connecting the Unit to the AC Supply

Since the unit has a switching power supply, it can be operated in the range of 100 V to 120 V (+10%, -15%) or 220 V to 240 V (+10%, -15%) at 47 Hz to 63 Hz without switch over. The power supply has two primary fuses which are accessible on the rear panel.

Depending on the configuration of the unit, the current drain is rated at 2.5 A in the range 100 to 120 V and 1.3 A in the range 220 to 240 V (approximately 100 W at the secondary).

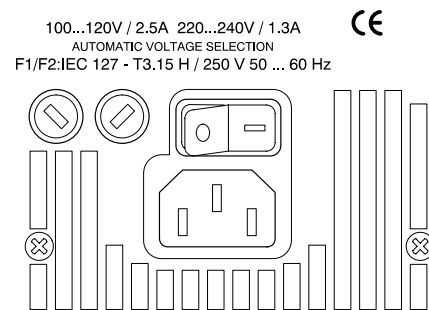

Replacing Fuses

To replace the fuses, perform the following procedure:

1. Unplug the power cable
2. Turn the fuse holders counterclockwise with a screwdriver and remove the fuse holders and fuses.
3. Check the two fuses.
4. Replace the defective fuse(s) with a fuse (or fuses) of the same type.
5. Install the fuse holders and fuses, using a screwdriver to lock into place.
6. Plug in the power cable.

Fuses: F1/F2 IEC12T – T3.15H/250V

EMC Protective Measures

To avoid impairment from electromagnetic interference, the unit must be operated completely enclosed with all internal shielding covers fitted. Suitably shielded signal and control cables are to be exclusively used. Make sure that the control cables (IEC/IEEE bus or RS-232) are fastened to the rear panel with the locking screws, since control cables with loose connections can cause the EMI limit values to be exceeded. Similarly, make sure that the control cables are properly connected at the PC end.

Powering On

Connect the unit to the AC supply (refer to *Connecting the Unit to the AC Supply* on page 1–11). Switch on the power at the rear panel (above the AC supply connector). The yellow standby LED (above the standby key) lights up on the front panel. Press the standby key. The green power-on LED lights up and the display back lighting is also on.

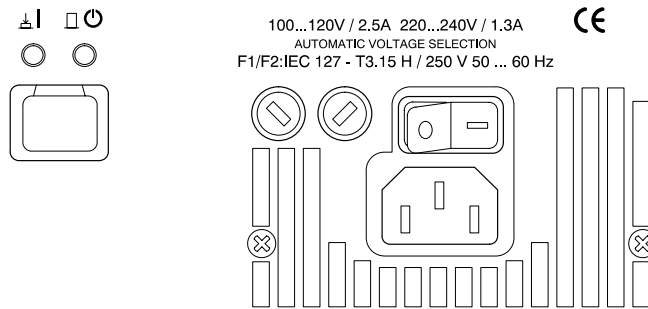

The following operations take place during switch-on:

- LED test
- Power on display that specifies the unit designation and firmware version; refer to the following example.

```

TV TESTRECEIVER EFA
FIRMWARE VERSION
V2.02
2.1.96 12:00
DATE: 2.1.96
TIME: 12:00
IEC 625 / IEEE488 BUS ADDR: 6
RS232: 9600,8,N,1
    
```

- Status display listing installed hardware assemblies
- Measurement display (MEASURE menu); the unit is now ready for operation.

Observe error messages, if any, during the power-on process.

NOTE. When powering on the unit for the first time, the factory default settings are loaded. The unit can also be reset to the default settings with a preset in the **PRESET** menu.

During start-up, all hardware modules are tested briefly and checked for their presence. In addition, all relays are actuated (input attenuator).

Setting the Contrast of the Display

The built-in LCD display has a limited viewing angle. It can be vertically adjusted within certain limits and optimally adapted to the working conditions. Setting is by performed with the control on the right below the LCD display. The contrast depends on the temperature and the viewing angle.

DISPLAY



Installing Firmware

Virtually all the firmware and software for the unit are stored in a flash EPROM, which can be erased and rewritten without opening the unit and replacing components. In case of a firmware update, the new firmware version can be loaded via the series interface (RS-232 connector on the rear panel) from a PC.

Proceed as follows for a firmware update:

1. Connect the unit to the PC COM1 or COM2 using a null-modem cable.
2. Power on the unit and the PC.
3. Press the PRESET key.
4. Select the submenu SERVICE/FIRMWARE UPDATE.
5. Confirm the firmware update with YES. The update is started as soon as the connection to the PC has been established. At this stage, the procedure can be aborted without losing data by powering the unit off and on.
6. Start the flashup software on the PC with “flashup <ENT>”. The firmware update is running and must not be interrupted.

Initial update - No executable firmware in the unit. If the unit does not have firmware, remove the rear panel as described in *Installing Options* on page 1–16.

The Main Processor board is located on the right at the bottom side (as viewed from the rear panel). The board can be recognized by the flat cable connected between it and the rear panel. Several jumpers are provided in front of the flat cable. The one at the right is normally in position 1-2. To release an initial firmware update, change this jumper into position 2-3 (right), and switch on the unit.

If the flashup software is started on the PC, the firmware is loaded into the unit, even if the unit has no executable firmware. At the end, set the jumper to position 1-2, and close the unit.

Firmware in modules. Most modules (options) are provided with a certain amount of firmware in OTPs (similar to EPROMs but not ultraviolet erasable) that must be replaced only in rare cases. If, however, replacement is necessary, installation instructions are supplied with the new OTP.

Basically, an OTP is replaced on a module as follows:

1. Loosen the rear panel as described in *Installing Options* on page 1–16, and fold it down.
2. Loosen all connections between the rear panel and module concerned.
3. Remove the module from the rear.
4. Remove the upper cover from the module.
5. Remove the OTP, using an appropriate tool. For the position of the OTP, refer to the instructions that are packaged with the OTP.
6. Insert the new OTP.
7. Re-assemble the parts in reverse order.
8. Observe if there are any messages displayed when powering on the unit.

Connecting Input and Output Signal

Apply an RF signal (40 dB μ V to 117 dB μ V) to the 75 Ω RF input connector using a BNC cable. The 75 Ω RF input connector may be located on the front or the rear panel, depending on the option. On the rear panel, the 75- Ω female connector (X9) is also a BNC type.

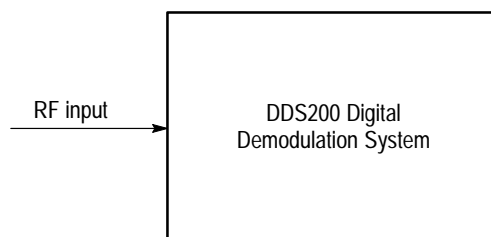

Battery-Backed Memory

The DDS200 Digital Demodulation System stores the current setup in a nonvolatile memory. On power on, the instrument reinstates the same configuration as before power off. The ten setups stored with STO/RCL are also saved in this memory. The battery status is indicated on power on. If the lithium battery, which also supplies the built-in clock, is discharged (approximately after five years), it should be replaced as described in *Replacing the Battery* on page 4-2.

Functional Test

Opon power on, the unit carries out a self test to check that all installed assemblies are present and that the instrument is functional. Errors found are indicated on the initial display. Minor errors in the hardware can only be detected by means of measurements requiring a special setup.

Installing Options

Various options (hardware modules) are available to expand the DDS200. Detailed instructions describing the installation steps are enclosed with each option. The options can be inserted in the guide rails from the rear after removing the covers (top and bottom) and the rear panel.

Proceed as follows:

1. Power off the unit, and disconnect all external connections, especially the AC supply connector.
2. Remove rear blue feet (two screws each).
3. Push the covers (top and bottom) to the rear, and remove them.
4. Remove the four Phillips screws at the left and right on the side.
5. Fold down the rear panel assembly.
6. Install the option according to the instructions that are packaged with it.
7. Reassemble the unit in reverse order.
8. Do a software update, if necessary (see page 1–13).
9. Perform a test according to the enclosed instructions and the functional test described in *Functional Test* on page 1–15.

Installing a printer

The DDS200 has a Centronics print interface connector (X32) on the rear panel. The 25-pin, D-type, female connector is PC-compatible. The type of printer can be selected in the setup menu (refer to *printer Menu – Selecting the Type of printers* on page 2–23). The **HARDCOPY** key makes a print-out of the current display. Commercial PC printer cables can be used for connecting the DDS200 to the printer.

Serial Interface

The unit is provided with a serial RS232 interface connector (X33) on the rear panel. Via this interface, the unit can be remote-controlled from a PC. A firmware update can also be carried out via the RS232 interface. For detailed information about configuring the interface, refer to *RS232 Menu – Setting the RS232-Interface Parameters* on page 2–22. The remote command set is explained in *Remote Control* and in *Appendix B: IEC/IEEE-Bus Interface*. A three-core shielded cable with crossed transmit and receive lines is sufficient for remote control; for updating the firmware, a null modem cable is required.

IEC/IEEE-Bus Connector

The DDS200 can be connected to the IEC/IEEE bus by means of connector X29 on the rear panel and remote-controlled. The bus address can be set in the setup menu (refer to *IEC-IEEE488 Menu — Setting the IEC/IEEE-Bus Address* on page 2–21). The set of remote-control commands is described in *Remote Control* and in *Appendix B: IEC/IEEE-Bus Interface*. The interface meets the requirements of standards IEC-625-2 and IEEE 488.2.

A shielded cable PK can be ordered as an accessory using the following part numbers:

Length (m)	Order No.
0.5	292.2013.05
1	292.2013.10
2	292.2013.20
4	292.2013.40

Manual Operation

This section provides information about the basic manual operation of the DDS200 Digital Demodulation System. The section describes how to use the soft keys and hard keys to control the instrument.

The control elements of the DDS200 are arranged on the front panel in separate functional groups, each in a different color for better distinction (see Figure 2–1). Also, refer to *Front Panel* on page 1–2 for descriptions of the controls.

Front view of DDS200

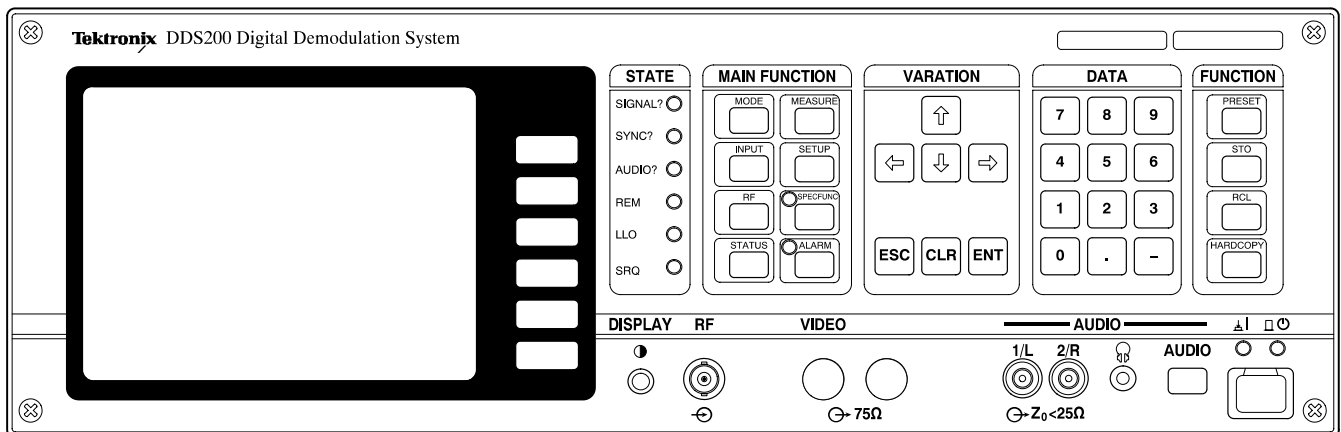

Figure 2–1: Front-panel controls

The following key information is provided in this section:

- *Sample Setting* on page 2–2 provides a sample setup of the unit. This setup is intended to quickly familiarize the user with the operation and the basic functions of the DDS200.
- *Basic Operation* on page 2–8 lists the different functional groups on the front panel and provides references to further information about each group. This subsection also provides an overview of basic operation.
- *General Device Settings* on page 2–19 contains information about settings that are independent of installed hardware or the selected mode.
- *Operation as Demodulator for Quadrature-Amplitude-Modulated (QAM) Signals* on page 2–26 describes the operation of the DDS200 as a QAM demodulator for DVB signals.

Sample Setting

This sample-setting procedure quickly familiarizes the user with the operation and basic functions of the DDS200.

The device settings are described in detail in the subsections referenced in each step:

1. Powering on the unit page 2-2
2. Selecting the mode page 2-3
3. Selecting the input page 2-4
4. Setting the RF Channel page 2-6

Powering on the Unit

Prior to powering on, check that the unit is connected to the AC supply. If the power supply is correct, the yellow (standby) LED lights above the power key on the lower right of the front panel (refer to *POWER* in Table 1-1 on page 1-2).

Power on the unit by pressing the power key. The green LED lights.

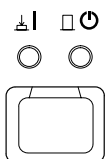

After power on, the DDS200 executes the following procedures:

1. An LED test is performed after power on to ensure that all the LEDs operate correctly.
2. A start-up display appears on the LCD display showing the unit description, the firmware version, the IEC/IEEE-bus address, and the parameters of the RS-232 interface.
3. The status of the installed hardware modules is displayed next. The display shows the firmware version, the hardware version and the model.
4. After the test of the hardware modules, the unit is ready for operation and the QAM MEASURE Menu appears on the LCD display (see Figure 2-2).

QAM MEASURE			
SET RF		RF-LEVEL	
330.000 MHz		66.7 dBuV	
LEVEL	66.7 dBuV	CONSTELL	DIAGRAM...
BER	6.5E-6 (7/10)	SPECTRUM...	
SYMBOL RATE	6.900 MSPS	ECHO	PATTERN...
ORDER OF QAM	64 (MAN)	QAM PARA-	METERS...
SELFTEST ERROR CODE: 000000 (HEX)			ADD. NOISE
			OFF

Figure 2-2: QAM MEASURE menu

Selecting the Mode

Using the main menu MODE hard key, the MODE menu is entered. After pressing the soft key on the right (next to menu line Nyquist Demodulator FM Sound), select the mode “QAM Demodulator”. All the parameters stored last in this mode are restored (refer also to *Mode Key / Selecting the Mode* on page 2-25).

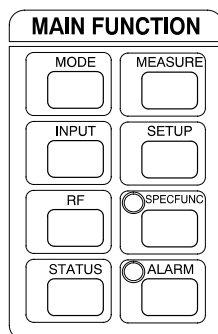

The selected mode is highlighted (see Figure 2-3).

MODE			
RF 48.250 MHz	CHANNEL 2	RF-LEVEL 67.4 dBuV	STANDARD B/G
NYQUIST DEMODULATOR FM SOUND			
<i>NYQUIST DEMODULATOR NICAM SOUND</i>			
QAM DEMODULATOR			
<i>DVB RECEIVER / MPEG2</i>			
<i>NYQUIST DEMODULATOR FM SOUND</i>			

Figure 2-3: MODE menu

Selecting the Input

Using the main menu INPUT hard key, the INPUT menu is entered. Press the soft key on the right next to the menu line RECEIVER to select the RF input. Depending on the unit configuration, the connector used as input is indicated next to the RECEIVER soft key.

MAIN FUNCTION	
MODE <input type="button" value="MODE"/>	MEASURE <input type="button" value="MEASURE"/>
INPUT <input type="button" value="INPUT"/>	SETUP <input type="button" value="SETUP"/>
RF <input type="button" value="RF"/>	<input checked="" type="radio"/> SPECFUNC <input type="button" value="SPECFUNC"/>
STATUS <input type="button" value="STATUS"/>	<input checked="" type="radio"/> ALARM <input type="button" value="ALARM"/>

In the example below, the front-panel RF connector on the DDS200 is selected with a 75 Ω termination. This is indicated by the display INPUT 75 OHM FRONT on the left of the highlighted RECEIVER menu box.

INPUT			
RF 45.250 MHz	CHANNEL 2	RF-LEVEL 14.5 dBuV	STANDARD B/G
INPUT 75 OHM FRONT			RECEIVER
			<i>DEMOD</i>
			IF
			RECEIVER ATTEN. . .

Figure 2-4: INPUT menu

Feed the RF input signal into the RF connector located on the front panel (to the right of the contrast control for the LCD display). Refer also to *RF* in Table 1-1 on page 1-4.

RF

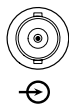

Press the RECEIVER ATTEN... soft key to match the input attenuation to the signal feed. This provides access to another submenu in which the following can be selected via the AUTO soft key:

INPUT : RECEIVER ATTENUATION			
SET RF		RF-LEVEL	
330.000 MHz		66.7 dBuV	
ATTENUATION : 0 dB			AUTO
			AUTO LOW NOISE
			AUTO LOW DIST
			AUTO LOWEST DIST
			MANUAL
			10dB PREAMP

Figure 2-5: INPUT:RECEIVER ATTENUATION menu

Setting the RF Frequency

Press the Main Function RF hard key to display the RF menu.

MAIN FUNCTION	
MODE	MEASURE
INPUT	SETUP
RF	SPECFUNC
STATUS	ALARM

Enter a frequency via the numeric keypad. Confirm the frequency using the ENT (Enter) key of the cursor keypad. The entry is accepted only if the frequency value is within the valid range.

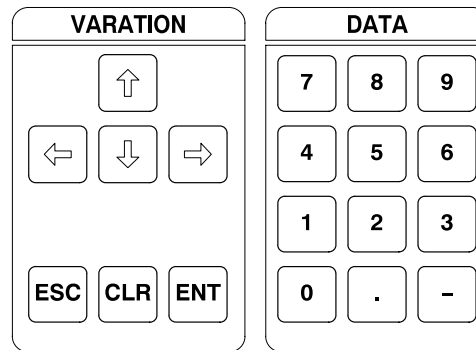

Optionally, the frequency can also be modified with the two cursor keypad keys ↑ and ↓.

The RF frequency is also indicated on the status line above the menu box (see Figure 2–6)d. It is thus possible to see the current RF frequency setting after changing to another menu.

QAM RF			
SET RF		RF-LEVEL	
330.000 MHz		66.7 dBuV	
RF = 330.000000 MHz			RF
			RCL RF
			STO RF...

Figure 2–6: RF menu

Basic Operation

The different functional groups of the front panel and the basic operating steps are described in the following subsections:

<i>Overview</i>	page 2–8
<i>Display</i>	page 2–9
<i>LEDs</i>	page 2–11
<i>Soft Keys</i>	page 2–12
<i>Cursor Keys</i>	page 2–13
<i>Numeric Keypad</i>	page 2–14
<i>Selecting Settings</i>	page 2–14
<i>Editing Text and Numerals</i>	page 2–15
<i>Presetting the Unit</i>	page 2–16
<i>Hardcopy Key</i>	page 2–17
<i>Storing Device Settings</i>	page 2–17
<i>Hard Keys</i>	page 2–18

- Overview**
- After power on, measurement is performed with the settings that were active before the unit was powered off. The MEASURE menu is always shown on the display. This menu shows the results and the test parameters relevant to the current measurement function.
 - The hard keys are used to change to the setting menus. This allows the display and setting of all the parameters of the current measurement function.
 - Special operating states are signalled via the LEDs on the front panel.
 - The display also indicates the allocation of soft keys, depending on the menu selected.
 - With the cursor keys, it is possible to modify text in the menus stepwise. Figures entered via the numeric keypad are confirmed with the ENT key. Press the ESC key to access the next higher menu level.
 - Settings are selected in the setting menus via the hard keys, the soft keys and, for variable parameters, via the numeric keypad and the cursor keypad.

- The PRESET key enables the unit to be set to a defined default state. All the parameters or sub-ranges can be reset. The firmware update can also be obtained with this key.
- The HARDCOPY key prints out of the display information.
- Keys STO and RCL are used to store and to recall (reload) device settings.
- The hard keys select the different menus, which enable all the settings to be carried out.
- The settings are displayed and set in the menus, depending on the mode selected.

Display

The display indicates various test results, test parameters, and configuration settings, depending on the menu selected. The upper line always shows the title of the selected menu.

MEASURE Menu. The MEASURE menu is divided into three parts (see Figure 2-7):

- The menu title appears in the top line.
- The status line is shown below the menu title. Important parameters, which help to interpret the test results, are permanently displayed.
- The main part of the screen is used to display the test results. Parameters related to each other are shown in a logical sequence. Test results are cyclically refreshed; they are always up-to-date and always show the current values.

In the QAM demodulator mode, it is possible to display different measurement menus. Selection is by means of soft keys displayed on the right of the screen (refer to *Soft Keys* on page 2-12).

QAM MEASURE			
SET RF		RF-LEVEL	
330.000 MHz		66.7 dBuV	
LEVEL	66.7 dBuV	CONSTELL	DIAGRAM...
BER	6.5E-6 (7/10)	SPECTRUM...	
SYMBOL RATE	6.900 MSPS	ECHO	PATTERN...
ORDER OF QAM	64 (MAN)	QAM PARA-	METERS...
		ADD. NOISE	OFF

Figure 2-7: MEASURE menu

Setting Menus. The menu title is again displayed in the top line of these menus (see Figure 2-8). As in the MEASURE menu, a status line is displayed. In this way, important information and measured values can be read while setting parameters.

The allocation of soft keys is shown on the left in the current menu (soft key bar). If parameters can be varied by selecting soft keys, these are inserted next to the soft keys on the screen. Variable parameters are highlighted.

QAM RF			
SET RF		RF-LEVEL	
330.000 MHz		66.7 dBuV	
RF =	330.000000 MHz	RF	
		RCL RF	
		STO RF...	

Figure 2-8: RF menu

LEDs Special operating states are signalled by LEDs on the front-panel of the DDS200. The following LEDs are available:

- Status LEDs next to the display to indicate input signal errors (signal and sync)
- Status LEDs next to the display to indicate remote-control operation (REM, LLO, SRQ)
- LED next to the SPEC FUNC key lights when a special function is selected
- LED next to the ALARM key lights when there is an alarm

The SIGNAL? LED signals the absence of an appropriate input signal at the corresponding receive frequency (RF level too low or too high, RF squelch). The SYNC? LED indicates synchronization problems. With these two LEDs, it is possible to have a general overview of the test signal applied.

The REM LED signals that the unit is remote controlled. SRQ and LLO are status messages for the IEC-625/IEEE-488-bus (refer to *Remote Control*).

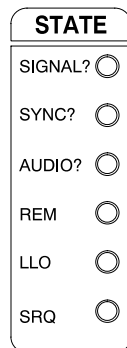

The LED located above the SPEC FUNC key lights up when a special function is activated in this menu. The unit may not be in normal operation.

The LED next to the ALARM key signals the presence of an alarm.

Soft Keys The soft keys on the right of the display are allocated different functions depending on the menu selected.

OAM RF			
SET RF		RF-LEVEL	
330.000 MHz		66.7 dBuV	
RF = 330.000000 MHz			RF
			RCL RF
			STO RF...

Figure 2-9: RF menu

The type of representation and selection for a soft key can vary depending on the unit setting.

soft key text highlighted	Function active
soft key text not highlighted	Function inactive but can be activated
soft key text in italics and not highlighted	Function inactive and cannot be activated

When you press an available soft key (unavailable keys are italicized), the associated function is selected and another submenu, if any, is pulled down. To quit a submenu, press the ESC key in the cursor keypad (see page 2-13). The previous menu is displayed.

The width and type of representation of the soft key bar vary, depending on the parameters to be selected and displayed.

NOTE. *If a parameter can also be varied in the setting selected, the parameter is displayed next to it on the screen.*

Cursor Keys

The numeric keypad and the cursor keypad can be used to vary parameters. The two keys ▲ and ▼ are for increasing or decreasing the value. The two keys ◀ and ▶ are for shifting the cursor below the parameter to the left or right. The cursor is placed under the figure which is to be modified with the other two keys. The overflow of a digit is automatically taken into account.

In contrast to a direct entry, the value is modified stepwise via the numeric keypad.

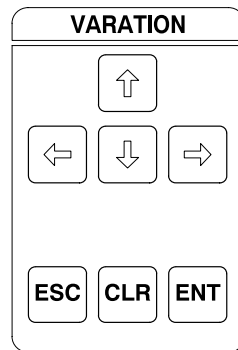

The cursor keypad also contains the keys ESC, ENT, and CLR.

- Use the ESC key to return to a submenu (refer to *Soft Keys* on page 2–12).
- Use the ENT key to confirm a numerical entry (refer to *Numeric Keypad* on page 2–14).
- Use the CLR key to erase a numerical entry (refer to *Numeric Keypad* on page 2–14).

Numeric Keypad

Selected parameters can be directly modified via the numeric keypad in contrast to the cursor keys. Enter the value with the numeric keys and confirm it with the ENT key on the cursor keypad (refer to *Cursor Keys* on page 2–13). If a correction is necessary during entry, the figure in front of the cursor can be erased or overwritten with the CLR key on the cursor keypad. For this purpose, the cursor can be shifted with the keys ◀ and ▶ from the end to the required position.

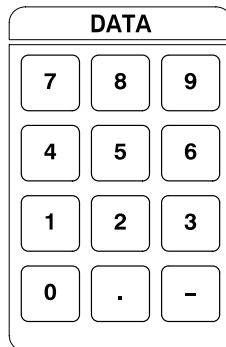

This entry facility is for making modifications that otherwise can only be made stepwise with the cursor keys.

NOTE. The entry is terminated after it has been confirmed with the ENT key. Erroneous entries are rejected and do not modify the previously set value.

Selecting Settings

In most cases, settings are performed by selecting a menu via the MAIN Function hard keys. The required setting is selected by pressing the soft key next to the corresponding soft key text on the screen. Some parameters require additional entries of numerals or text (see *Editing Text and Numerals* on page 2–15).

Depending on the menu, the settings can be selected in a lower menu level. A submenu is displayed by pressing the soft key. For example, several settings can be directly performed in the INPUT menu. Other settings (for example, in RECEIVER ATTEN...) are carried out at a lower menu level. In this case, additional parameters can be set.

Press the ESC key to display the next higher menu level from a submenu; press the corresponding hard key to display to the uppermost menu level.

Editing Text and Numerals

Editing Numerals. As described in *Numeric Keypad* on page 2–14, the parameters selected via the numeric keypad can be directly modified. To select the parameters, enter the figure and then confirm it by pressing the ENT key on the cursor keypad. If a correction is required during entry, the figure in front of the cursor can be erased and overwritten by means of the CLR key on the cursor keypad. For this purpose, the cursor can be shifted with the keys ◀ and ▶ from the end to the required position.

Editing Text. Text entries (for example, in the RF:STO RF menu under EDIT TEXT...) are possible using the cursor keys and the soft keys.

A box with the characters available is shown under the text to be modified. The required character can be selected by means of cursor keys ◀, ▶, ▲ and ▼ and inserted in the entry line with the GETCHAR soft key. The cursor automatically moves to the next position. If a character is to be inserted in the text, the cursor can be moved to the position using the RIGHT and LEFT soft keys. Insert a new character inserted by pressing the GETCHAR soft key.

A character in front of the cursor can be erased by means of the DELCHAR soft key.

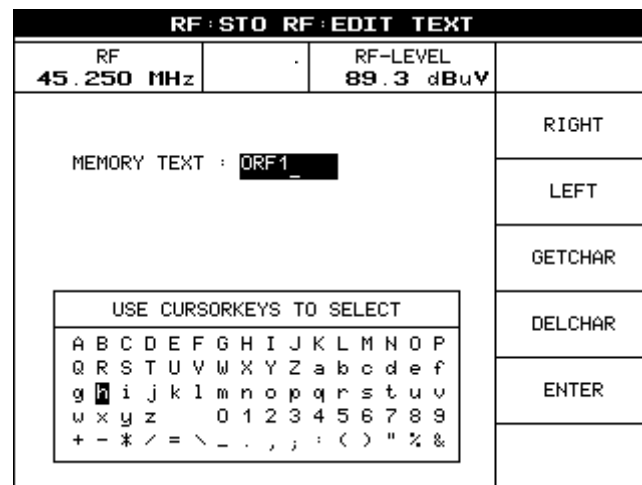

Figure 2–10: RF:STO RF:EDIT TEXT menu

The entry is terminated by pressing the ENTER soft key.

Presetting the Unit The PRESET key restores the factory-set default setting.

PRESET			
RF	CHANNEL	RF-LEVEL	STANDARD
45.250 MHz	2	113.2 dBuV	B/G
FIRMWARE		14.01.96 00:12:10	PRESET...
V2.02 13.09.1995 17:59:57			
IEC-625/IEEE488			PRESET QAM
ADRESS 6			
RS232			
9600,8,N,1			
PRINTER			
EPSON COMPATIBLE			SERVICE
TESTING SYSTEM : NO ERROR FOUND			

Figure 2-11: PRESET Menu

Types of presetting the unit:

- PRESET = Preset for the whole unit
- PRESET QAM = Preset for the QAM demodulator mode

PRESET			
RF	CHANNEL	RF-LEVEL	STANDARD
45.250 MHz	2	79.3 dBuV	B/G
FIRMWARE		15.01.96 08:11:18	
V2.02 13.09.1995 17:59:57			
IEC-625/IEEE488			
ADRESS 6			
RS232			
9600,8,N,1			
PRINTER			YES
EPSON COMPATIBLE			
TESTING SYSTEM : NO ERROR FOUND			NO

Figure 2-12: PRESET menu

After selection of a preset key, the unit queries if the settings are to be reset. If this is confirmed by the **YES** soft key, the unit is reset with the factory-set settings.

Press the **PRESET** key after a new power-up of the DDS200 if the settings of the previous session are not exactly known.

Hardcopy Key

On pressing the Hardcopy key, the current screen contents is output on the printer. The selection of the type of printer is described in *Printer Menu – Selecting the Type of Printer* on page 2–23.

STO/RCL – Storing Device Settings

The user can store or recall up to 10 specific device settings with the **STO** and **RCL** keys. Thus, he can retain his own settings even after the unit has been used by other persons.

Press the **STO** key to store the current overall device setting (see Figure 2–13).

STORE			
RF	.	RF-LEVEL	
45.250 MHz		50.2 dBuV	
STORE SETUP TO SETUP-MEMORY 0			

Figure 2–13: STORE menu

For storing, enter a memory location number under which the setup can be recalled later. Use the numeric keys for this purpose. The range of values is 0 to 9. After pressing the **ENT** key, the setup is stored and the unit returns to the measurement display.

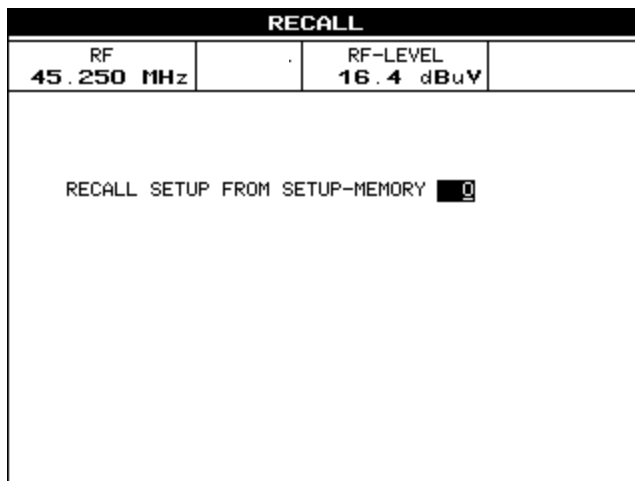

Figure 2-14: RECALL menu

The contents of a memory location can be recalled in a similar way. Press the **RCL** key and enter the number of the memory location required. The overall device setting available under the memory location number selected is recalled after pressing the ENT key. The unit returns to the measurement display with the overall device setting restored.

Hard Keys

The Main Function hard keys allow the access to the following menus:

MODE	Refer to <i>Mode Key/Selecting the Mode</i> on page 2-25.
INPUT	Refer to <i>INPUT Menu/Input Selection</i> on page 2-27.
RF	Refer to <i>RF Menu</i> on page 2-29.
STATUS	Refer to <i>STATUS Menu</i> on page 2-30.
MEASURE	Refer to <i>MEASURE Menu</i> on page 2-46.
SETUP	Refer to <i>SETUP Menu</i> on page 2-19.
ALARM	Refer to <i>ALARM Menu</i> on page 2-38.
SPEC FC	Refer to <i>SPECIAL FUNCTION Menu</i> on page 2-34.

General Device Settings

Introduction The general device settings are settings which are independent of the installed hardware or the mode selected and are accessed through the **SETUP** menu.

SETUP Menu In the **SETUP** menu, the following basic device settings are performed:

Setting time and date	Menu: SETUP:TIME AND DATE
Setting the IEC-bus address	Menu: SETUP:REMOTE:IEC625-IEEE488
Setting the serial interface parameters	Menu: SETUP:REMOTE:RS232
Selecting the type of printer	Menu: SETUP: PRINTER
Selection of level units	Menu: SETUP:LEVEL UNITS
Selection of the LCD display mode	Menu: SETUP

All the basic device settings are displayed in the basic setup menu (see Figure 2–15). From this menu the corresponding submenus can be accessed by pressing the associated soft key.

SETUP			
RF	.	RF-LEVEL	
583.250 MHz		37.4 dBuV	
FIRMWARE		08.01.96	TIME
V2.02	13.09.1995	10:44:36	DATE
IEC-625/IEEE488			REMOTE
ADDRESS 6			PRINTER
RS232			LEVEL UNITS
9600,8,N,1			
PRINTER			
EPSON COMPATIBLE			LCD INVERS
TESTING SYSTEM : NO ERROR FOUND			ON OFF

Figure 2–15: Menu SETUP

With the LCD INVERS ON/OFF soft key, it is possible to change between two display modes:

LCD INVERS ON	Dark letters on white background
LCD INVERS OFF	White letters on dark background

The display mode does not affect hardcopy or print functions.

Time/Date Menu – Setting Date and Time. On pressing the TIME/DATE soft key, the setup menu for the time and date is displayed (see Figure 2–16). The time and date of the built-in, battery-backed, crystal clock can now be set. The time is for storing alarm messages together with the time of an event and for specifying the time on printed reports.

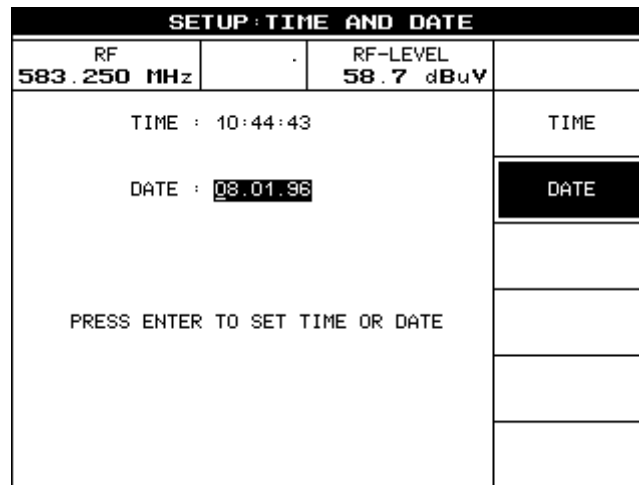

Figure 2–16: SETUP: TIME DATE Menu

Press the **TIME** soft key to set the time. The time indicated is the system time at the moment of key actuation. To change the time, enter the time via the numeric keypad. The new time is set after confirmation with the ENT key. To change the date, press the **DATE** soft key and proceed in the same way.

Remote. This menu enables the remote-control interfaces of the unit to be configured (see Figure 2–17). This menu is entered by pressing the **REMOTE** soft key in the main setup menu.

SETUP:REMOTE			
RF	.	RF-LEVEL	
583.250 MHz		64.3 dBuV	
			IEC625 IEEE488
			RS232

Figure 2-17: SETUP:REMOTE menu

Table 2-1 lists the SETUP:REMOTE menu choices.

Table 2-1: SETUP REMOTE menu selections

Menu	Function
:IEC625 IEEE488	Setting the IEC/IEEE-bus address
:RS232	Setting the RS232-interface parameters

■ IEC625-IEEE488 Menu

The address for the IEC/IEEE-bus interface is entered here. This address must correspond to the address used for the IEC/IEEE-bus controller to enable the remote control of the unit via the bus (refer to *Remote Control*).

The entry is performed using either the cursor keys or the numeric keypad. Values must be in the range of 0 to 30.

SETUP : IEC625-IEEE488			
RF	.	RF-LEVEL	
583.250 MHz		25.4 dBuV	
IEC BUS ADDRESS : <input type="text" value="8"/>			

Figure 2-18: SETUP:REMOTE:IEC625-IEEE488 menu

■ RS232 Menu

The RS232-interface parameters are entered here (see Figure 2-19). The interface parameters must correspond to the parameters used for the controller (PC) to enable the remote control of the unit via RS-232.

SETUP : REMOTE : RS232					
RF	.	RF-LEVEL			
583.250 MHz		16.4 dBuV			
1200	2400	4800	<input type="text" value="9600"/>	19200	BAUDRATE
				7BIT	<input type="text" value="8BIT"/>
				<input type="text" value="NO"/>	EVEN ODD
				<input type="text" value="1BIT"/>	2BIT
NO	<input type="text" value="XON/XOFF"/>	HARDWARE		HANDSHAKE	

Figure 2-19: SETUP:REMOTE:RS232 menu

After pressing one of the five soft keys, the associated parameter is directly set.

- BAUDRATE: Data transfer rate in bits/s.
- DATABITS: Number of data bits transferred per byte without parity bit.
- PARITY: Check of data transfer by means of the parity bit. If NO is selected, no check will take place (since no parity bit is transferred). With EVEN selected, even parity is checked; With ODD selected, odd parity is checked.
- STOPBITS: Number of stop bits set during transfer.
- HANDSHAKE: With NO selected, there is no handshake. XON/XOFF is set if the additional signal lines (RTS, CTS, DTR) are not used, and software handshake is used. If HARDWARE is set, these additional lines are used.

Printer Menu – Selecting the Type of Printer. The type of printer connected to the Centronics interface (X32) can be indicated in this menu (see Figure 2–20).

SETUP : PRINTER			
RF 583.250 MHz	.	RF-LEVEL 19.3 dBuV	
EPSON COMP HP COMP R&S PUD COMP			PRINTER TYPE
			FORMFEED
			PRINTER RESET

Figure 2–20: SETUP: PRINTER menu

The type of printer is selected using the **PRINTER TYPE** soft key. The following types of printer are supported:

EPSON COMP	For all Epson RX80 compatible printers
HP COMP	For all HP compatible printers (including DeskJet and LaserJet)
R&S PUD COMP	For the ink-jet printer PUD3 from Rohde & Schwarz

With the **FORMFEED** soft key it is possible to select whether an automatic form feed should take place or not after a print-out.

Level Units Menu. The unit for level indication is selected in this menu (see Figure 2–21).

SETUP: LEVEL UNITS			
RF		RF-LEVEL	
583.250 MHz		42.7 dBuV	
			dBpW
			dBuW
			dBm
			dBuV
			uV/mV

Figure 2-21: SETUP:LEVEL UNITS menu

The measurement display offers five level units:

- dBpW** (dB, referred to the power of 1 pW)
- dBuW** (dB, referred to the power of 1 uW)
- dBm** (dB, referred to the power of 1 mW)
- dBuV** (dB, referred to the voltage of 1 V)
- uV/mV** (direct voltage indication)

The conversion is as follows:

Unit	Impedance 75 Ω
μV	1 $\mu\text{V} = 10^{-6} \text{V}$
mV	1 mV = 1000 μV
dBuV	0 dBuV = 1 μV
dBm	0 dBm = 108.8 dB μV
dBpw	0 dBpw = 18.8 dB μV
dB uW	0 dBuW = 78.8 dB μV

Mode Key. The mode key is pressed to display the MODE menu (see Figure 2–22). The basic mode of the unit can be set by pressing the corresponding soft key. All modes that can be set are represented in normal characters. Whether or not a mode can be set depends on the hardware installed in the unit. Modes which are not available are displayed in italics and cannot be selected.

MODE			
RF 48.250 MHz	.	RF-LEVEL 67.4 dBuV	
<i>NYQUIST DEMODULATOR FM SOUND</i>			
<i>NYQUIST DEMODULATOR NICAM SOUND</i>			
QAM DEMODULATOR			
<i>DVB RECEIVER / MPEG2</i>			

Figure 2–22: Mode menu

NOTE. The default setting selected in the MODE menu determines the overall operation of the unit and largely defines the presentation and the function of many menus.

Operation as Demodulator for Quadrature-Amplitude-Modulated (QAM) Signals

The DDS200 Digital Demodulation System measures QAM signals used in digital video broadcasting (DVB). A number of special characteristics for measuring DVB signals make this instrument especially suitable for accurate analysis and measurements of all main parameters (refer to *MEASURE Menu* on page 2–46). Such characteristics are the newly developed steep-edge channel filters, which were especially developed for use in cable channels, the powerful equalizer, and the DVB-specific Nyquist filters.

The input signal is processed in compliance with DVB specifications. This includes demapping, the Reed-Solomon decoder, deinterleaving, and energy dispersal. Decoded MPEG data is available in serial or parallel form.

Extremely powerful digital signal processing provides accurate analysis of the applied QAM signal. A newly-developed data storage technique allows a very flexible and efficient collection of measurement results for all relevant signal parameters, providing valuable information on problems that may occur during transmission. In addition, the display of constellation diagrams on the LCD can be individually configured, and variable result hold times (up to ∞) can be set. Thus signal events lasting an extended period of time can be displayed. Another benefit is the automatic storage of messages in the alarm register.

This powerful unit can be used any time for applications in development laboratories, quality assurance, and production monitoring of TV consumer electronics.

This section presents and describes the different functions in their logical order. To take full advantage of the instrument capabilities, particular attention should be paid to the characteristics mentioned in Examples of Application on page 2–62. The following discussions of the DDS200 menus provide information about interpreting the measurement results obtained with the DDS200.

Overview

For users already familiar with basic DDS200 characteristics, the steps required for the direct synchronization of a QAM signal are listed below in their sequence:

1. Switch on instrument and establish RF (IF) connection.
2. Press PRESET.
3. Select input frequency (RF) and input (INPUT).
4. Select order of QAM (STATUS menu).
5. Select symbol rate (STATUS: SYMBOL RATE menu).

After the previous selections, the calculated parameters or the constellation diagram can be displayed in the MEASURE menu.

INPUT Menu / Input Selection

In the INPUT menu (see Figure 2–23), the input selection, attenuator, and preamplifier settings can be made.

INPUT			
SET RF		RF-LEVEL	
330.000 MHz		66.7 dBuV	
INPUT 75 OHM REAR			RECEIVER
			IF
			ATTEN. . .

Figure 2–23: INPUT menu

When the DDS200 used as a selective test receiver, the RF input is reported in the INPUT menu using the RECEIVER soft key. After pressing this key, the input impedance and the active RF input are indicated in the display. The message INPUT 75 OHM REAR indicates the X9 rear BNC connector is being used as the input connector. With the message INPUT 75 OHM FRONT displayed, the BNC connector on the front panel is used.

The IF input of the test receiver/demodulator is activated with the IF key. The input impedance is 50 Ω . The input is located at the rear of the instrument and marked X10.

The INPUT: ATTENUATION menu is displayed with the ATTEN... key. In the INPUT: ATTENUATION menu (see Figure 2–24), the input attenuation, the tuner and mixer leveling, as well as the preamplifier, can be selected and set.

INPUT : RECEIVER ATTENUATION			
SET RF		RF-LEVEL	
330.000 MHz		66.7 dBuV	
ATTENUATION : 0 dB			AUTO
			AUTO LOW NOISE
			AUTO LOW DIST
			AUTO LOWEST DIST
			MANUAL
			10dB PREAMP

Figure 2-24: INPUT: ATTENUATION menu

When the AUTO, AUTO LOW NOISE, AUTO LOW DIST or AUTO LOWEST DIST key is pressed, the attenuator in the receiver input is set as follows:

- With AUTO LOW NOISE selected, the input attenuation is reduced by 5 dB below the setting under AUTO. This improves the signal-to-noise ratio of the receiver.
- With AUTO LOW DIST selected, the input attenuation is increased by 5 dB above the setting under AUTO. This improves the signal-to-intermodulation ratio of the receiver.
- With AUTO LOWEST DIST selected, the input attenuation is increased by 10 dB above the setting under AUTO. This is only useful if, for instance, the level in the adjacent channel is considerably higher than that of the signal channel.

With MANUAL selected, the attenuator can be set manually in 5 dB steps from 0 to 55 dB. Settings can be made using the up ▲ and down ▼ cursor keys or by direct entry via the numeric keypad and confirmation with ENTER. In the case of direct entry, the entered numerals are rounded to a value that can be divided by 5.

With the 10 dB PREAMP key, a low-noise preamplifier can be switched into the signal path to improve the noise figure of the receiver. This is useful when low-level signals are received. The attenuator is correctly set in automatic operation. In the AUTO LOW DIST and AUTO LOWEST DIST modes, the 10-dB preamplifier cannot be switched on as preamplification of the TV signal in these modes is not useful. In this case the label *10 dB PREAMP* is in italics.

RF Menu Select the RF menu using the RF key in the MAIN FUNCTION block. In this menu (see Figure 2–25), the center frequency of the QAM signal (carrier frequency) can be set.

QAM RF			
SET RF		RF-LEVEL	
330.000 MHz		66.7 dBuV	
RF = 330.000000 MHz			RF
			RCL RF
			STO RF...

Figure 2–25: RF menu

Pressing the RF key causes the currently set center frequency to be displayed. This frequency can be changed with a 1-kHz resolution directly using either the numeric keypad or by using the cursor keys.

When the RCL RF key is pressed and the RF memory number entered, a receive frequency previously stored with STO RF in the RF MEMORY can be recalled. The RF memory number can be selected using the keypad or the cursor keys. If the receive frequency is selected with the aid of the RCL RF function, the RF memory number and the associated text are displayed in the header.

The currently set frequency can be stored in the RF memory with the aid of the STO RF key. When the STO RF key is pressed, the desired RF memory number can be entered on the keypad and confirmed with the ENT key. After pressing the EDIT TEXT key, the text assigned to the previously selected RF memory number can be edited (see Figure 2–26).

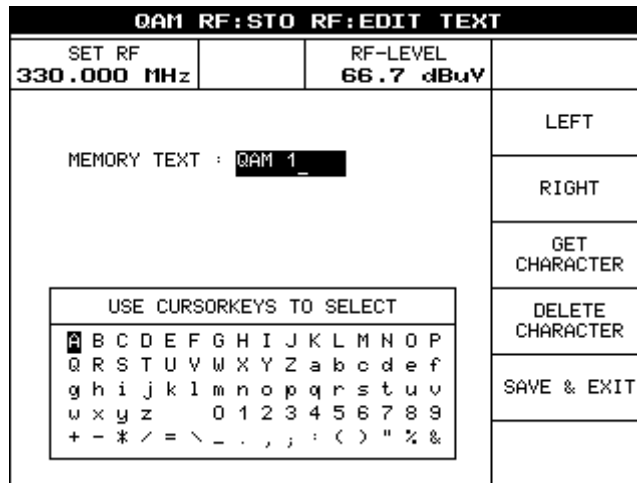

Figure 2-26: STO: EDIT TEXT menu

When the EDIT TEXT key is pressed, the available characters are displayed. Characters can be selected using the cursor keys. Pressing the GET CHARACTER key adds the selected character to the MEMORY TEXT. The cursor can be moved in the MEMORY TEXT to the right or left using the RIGHT and LEFT cursor keys. The DELETE CHARACTER soft key clears the character in front of the cursor. A maximum of eight characters is allowed for RF memory number identification. When the SAVE & EXIT key is pressed, the MEMORY TEXT is assigned to the selected RF memory number is displayed at the top right of the display.

STATUS Menu

Select the STATUS menu using the STATUS key in the MAIN FUNCTION block (see Figure 2-27). In this menu, all main device settings are displayed. This particularly applies to the order of QAM parameters, the symbol rate, and the selected SAW filter. Settings that affect input selection or attenuator and preamplifier settings must be made in the INPUT menu.

QAM STATUS				
SET RF		RF-LEVEL		
330.000 MHz		66.7 dBuV		
2MHz	<i>4MHz</i>	8MHz	OFF	SAW FILTER BW
				SYMBOL RATE...
AUTO	4	16	32	64
			128	256
				ORDER OF QAM
				BEEPER...

Figure 2-27: STATUS menu

SAW FILTER. The DDS200 has three slots for accommodating SAW filters. One or two filters can be inserted in addition to the 8-MHz filter, which is standard. The required filter is selected by pressing the SAW FILTER BW soft key several times. Unused slots are automatically identified. They are displayed in italics and cannot be selected. When the internal noise generator is active (refer to *MEASURE Menu* on page 2-46), the noise power is automatically increased so that a constant noise level is obtained in the selected filter bandwidth.

SYMBOL RATE. The SYMBOL RATE... soft key is used for configuring the symbol rate of the QAM demodulator. The rate is calculated from the net data rate D according to the formula

$$\text{Symbol Rate} = D \cdot \frac{204}{188} \cdot \frac{1}{\log_2(M)},$$

with M being the order of QAM (M = 4, 16, 32, 64, 128, 256). The factor of 204/188 is the result of the Reed-Solomon error protection. This can be seen in the following diagram.

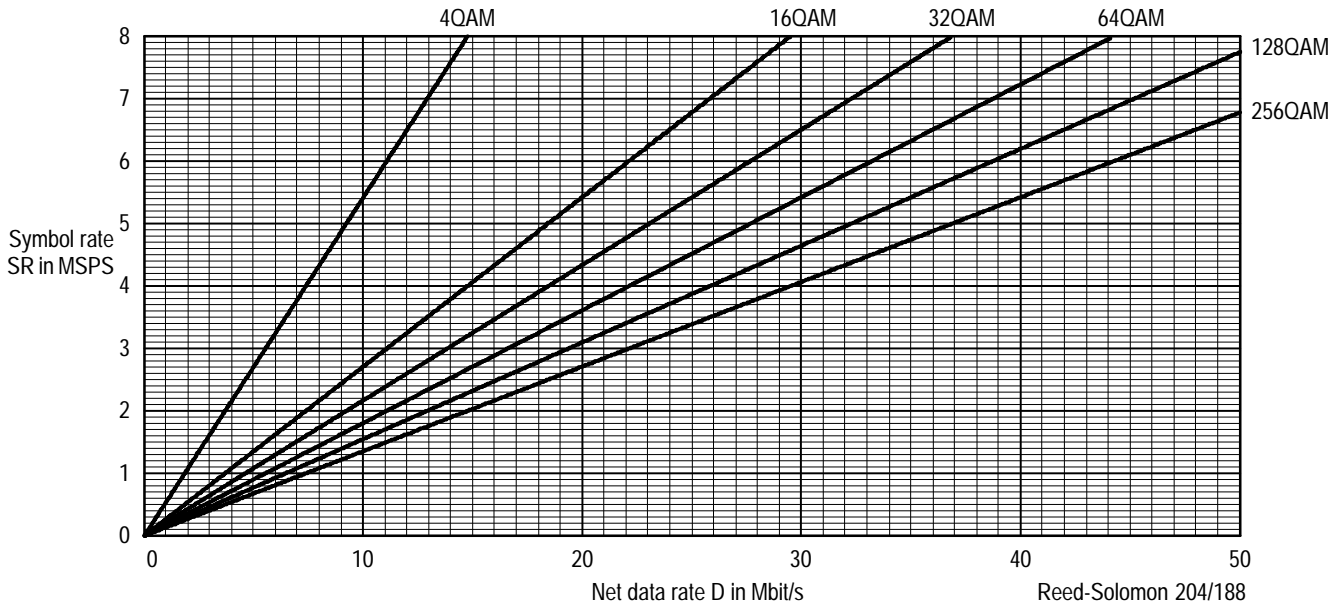

To ensure proper function of the instrument, the symbol rate has to be accurately set. Refer to Figure 2–28.

QAM STATUS:SYMBOL RATE			
SET RF		RF-LEVEL	
330.000 MHz		66.7 dBuV	
SYMBOLRATE SYNC			
		7.000 MSPS	UPPER SEARCH LIMIT
		1.000 MSPS	LOWER SEARCH LIMIT
		6.900 MSPS	SYMBOL RATE VALUE
			START AUTO SEARCH
			STOP AUTO SEARCH

Figure 2–28: STATUS: SYMBOL RATE menu

Press the SYMBOL RATE VALUE soft key and enter a value between 1.5 and 7.0 MSPS (mega symbols per second) The value should be accurate to within three decimal digits.

If the accurate symbol rate is not known, an automatic search routine can be started. To do so, set the search range with the aid of the UPPER / LOWER SEARCH LIMIT keys (the UPPER LIMIT must always be higher than the LOWER LIMIT).

The search itself is started with START AUTO SEARCH. Since up to five minutes is needed to search through the whole range, it is advisable to set narrow range limits so that the setting can be made quickly.

A search run may be stopped any time with the STOP AUTO SEARCH key. In this case the previous, manually-set values will be used again. After the symbol rate of the modulator has been changed, a new search run must be started, since the search is only performed once.

Information on the progress of the search is displayed in the SYMBOL RATE VALUE field where the current symbol rate is indicated at regular intervals (approximately every five seconds). Once the instrument has synchronized to the symbol rate, no search is started when the START AUTO SEARCH key is pressed, even if the set search range limits are outside the actual symbol rate.

NOTE. *If the automatic symbol rate search is active, setting commands other than the STOP AUTO SEARCH command cannot be processed.*

Order of QAM. The order of QAM is determined in the modulator and must be set accordingly in the QAM receiver. All common methods (4-, 16-, 32-, 64-, 128- and 256QAM) are available and can be selected by means of the ORDER OF QAM key (toggle function). 64QAM is the default value.

BEEPER. The internal acoustic signal generator can be configured in the BEEPER... submenu. With the different kinds of error that may occur, the generator is active when the corresponding parameter has been set to ENABLED, or inactive when the corresponding parameter is set to DISABLED. The following errors may be acoustically signaled:

1. Recovery of symbol clock rate not synchronized.
2. Equalizer not synchronized.
3. Carrier recovery not synchronized.
4. Sync byte of MPEG frame not found.
5. At least one faulty byte in the 188-byte MPEG frame could not be corrected.
6. At least one faulty byte was corrected in the 188-byte MPEG frame.

SPECIAL FUNCTION Menu

In the SPECIAL FUNCTION menu that is selected in the MAIN FUNCTION block, special settings can be made for values that need not be changed in normal operation (see Figure 2–29). In this menu, the instrument can be set to a state where normal operation is not always guaranteed. If a special function has been selected, the yellow LED next to the key lights and turns off only after all functions have been reset to standard values. In the menu, default values are marked in bold (refer to *Preset Values and Menu Overview* on page 2–58). Default values are selected in the following example.

QAM SPECIAL FUNCTION					
SET RF		RF-LEVEL			
330.000 MHz		66.7 dBuV			
EQUALIZER...					
0.15	0.20	0.25	0.30	ROLLOFF FACTOR	
BER EXT	1	10	100	1000	MIN BER INTEGRATION (SAMPLES)
	HI	MED	LO	LOOP BANDWIDTH	
MPEG DATA OUTPUT...					

Figure 2–29: SPECIAL FUNCTION menu

EQUALIZER. The operating mode of the channel equalizer is set with the EQUALIZER... key.

1. EQUALIZER MODE:

In the EQUALIZER MODE submenu, the equalizer can be frozen (FREEZE) in the adaptive mode. The equalizer can also be completely switched off (OFF).

2. CENTRAL TAP POSITION:

The equalizer is a complex 24-stage FIR filter giving 48 coefficients as a result of the real and the imaginary parts. The processing of high-order QAM signals places considerable demands on the equalizer capability. Considering the mentioned length, the type of equalizer used here is more complex than most other types. For simulating a shorter equalizer, the position of the central coefficient (CENTRAL TAP) may be set between 0 and 23.

When selecting the position of the central tap, the following should be considered:

- An equalizer with the central tap below 11 should be used for compensating a signal subject to considerable post-echoes (for example, caused by reflections). In this case a maximum range is available for echo compensation. However, only in exceptional cases should the coefficient be set to a value below 6. A value below 2 is not useful at all.
- A signal generated under laboratory conditions should be measured with the central coefficient in position 11 or 12. Thus the equalizer can adapt symmetrically to given conditions.
- If the receiving conditions are known and a shorter equalizer should be simulated, the central coefficient may be set to a position above 12.

Generally, the yellow LED next to the SPECIAL FUNCTION key comes on if a central coefficient outside the range 6 to 18 is selected. The preset value is 12.

ROLLOFF FACTOR. The ROLLOFF FACTOR key is pressed to define the root cosine pulse shaping of the digital input filter. For compliance with the first Nyquist condition, pulse shaping in the whole transmission path must be symmetrical to the -6 -dB point at the Nyquist frequencies. According to DVB specifications, the rolloff factor in the modulator is 0.15. The same rolloff factor must be set in the receiver. Another factor may be chosen for laboratory tests.

MIN BER INTEGRATION. With the MIN BER INTEGRATION key, the BER measurement can be influenced. For details on operation and usefulness of this setting, refer to *Selection of Integration Time for BER Measurement* on page 2–79. For details on the BER EXTERN mode, refer to *BER Measurement with External Equipment* on page 2–80. Note that in this case, the serial and parallel MPEG outputs are disabled and only the female connectors X6 (serial clock) and X5 (serial data) are active. Using the integrated PLL, any jitter can be removed from the signals. When the MIN BER INTEGRATION setting is changed, the ALARM register is cleared. The preset value is 10 samples.

LOOP BANDWIDTH. When the LOOP BANDWIDTH key is pressed, the loop bandwidth for carrier recovery can be configured. The typical capture range for carrier recovery is more than 5% of the symbol rate. This corresponds to approximately 350 kHz in the case of standard DVB signals. This wide (permanently set) capture range is sufficient for any kind of application. The dynamic characteristic can be changed with the aid of the LOOP BANDWIDTH function.

The choices for changing the dynamic characteristic using the LOOP BANDWIDTH function are as follows:

- A wide loop bandwidth (HI) should be chosen if the phase of the input signal is has considerable jitter. In this case, most of the phase jitter of the signal to be analyzed can be compensated for.
- The medium loop bandwidth (MED) is ideal for general applications.
- The narrow bandwidth (LOW) can be chosen when the jitter in the signal is exceptionally low.

The lower the loop bandwidth, the more reliable the recovery of the transmitted signal. In the case of problems, refer to the constellation diagram and the calculated parameters (particularly phase jitter).

Selected loop bandwidth	High	Med	Low
Set loop bandwidth/Symbol rate	10^{-2}	5×10^{-3}	10^{-3}

The specified loop bandwidths are normalized to the symbol rate. In the position HI and a symbol rate of, for instance, 6.900 MSPS, the bandwidth of the loop filter is 69 kHz.

MPEG DATA OUTPUT. The MPEG DATA OUTPUT key opens a submenu where the serial and parallel MPEG outputs can be configured with the following main parameters (see Figure 2–30):

QAM SPECIAL FUNCTION: MPEG DATA OUTPUT			
SET RF 330.000 MHz		RF-LEVEL 66.7 dBuV	
<input checked="" type="checkbox"/> ON	OFF	REED SOLOMON DECODER	
<input checked="" type="checkbox"/> ENABLED	DISABLED	ERROR INDICATION BIT IN MPEG FRAME	
<input checked="" type="checkbox"/> ON	OFF	PARALLEL MPEG DATA PLL	
204 BYTES	<input checked="" type="checkbox"/> 188 BYTES	SER/PAR MPEG FRAME SIZE	
<input checked="" type="checkbox"/> AUTO	NORMAL	INVERTED	IQ INVERSION

Figure 2–30: SPECIAL FUNCTION: MPEG DATA OUTPUT menu

REED SOLOMON DECODER: This decoder forms the main part of the error protection in the MPEG-2 transport stream. With a BER of 1E-4 in front of the decoder (in the DDS200 the BER is always measured in front of the decoder), a

BER of 1E-11 is obtained after the decoder, which corresponds to a practically error-free transmission. For demonstration purposes, the error protection can be switched off. In this case, the uncorrected data are available at the MPEG output.

ERROR BIT IN MPEG FRAME: With this key, a selection can be made whether this software indication for a whole MPEG frame should be set or not in the event of uncorrectable data errors. In practice, this function is not very important, since a connected decoder must evaluate the received data.

PARALLEL MPEG DATA PLL: Here the integrated phase-lock loop (PLL) eliminating the jitter in the data and clock lines can be switched on and off. With certain symbol rates, switching the PLL off may be advantageous.

NOTE. *The PLL configuration also affects the serial output for external BER measurements (X6 and X5). If the serial MPEG data interface (X7) is mainly used, the PLL should be switched off. If it is on, incorrect BER measurements or loss of synchronization may occur at low temperatures or immediately after the instrument has been powered up.*

SER / PAR MPEG DATA FRAME SIZE: With the aid of this key a selection can be made whether the serial and parallel MPEG outputs should use the whole information (including the 16 error-protection bytes per frame) for data transmission or whether only the 188 relevant data bytes should be transmitted. This makes no difference for the error protection function. However, some of the MPEG decoders accept only one data format. The MTD200 MPEG Test Decoder can handle both formats, and switch over is automatic. The 188-byte mode is preferred for the MTD200 MPEG Test Decoder. For more detailed information, refer to *Assignment and Functions of Parallel and Serial MPEG-2 Outputs* on page 2–85.

I/Q INVERSION: The DDS200 continuously monitors the transmitted data stream for MPEG-2 sync words. If a synchronization is not possible, the instrument inverts the I and Q data streams and restarts the procedure (provided AUTO has been selected). With NORMAL and INVERTED, this automatic switch over can be disabled and the signal decoded in the normal or the inverted mode.

NOTE. *Switching off the automatic function is particularly important when the instrument is to receive signals that are not coded to MPEG-2 standard.*

ALARM Menu This subsection comprises the following topics:

Configuring the Alarm Register page 2–38

Alarm Register page 2–39

Setting Limit Values page 2–41

Statistics page 2–41

Printing the Register page 2–43

Clearing the Register page 2–45

When lighted, the LED next to the ALARM key signals that at least one new alarm message has been registered since the register was called up last. The LED turns off when the alarm register is called up with the ALARM key.

Configuring the Alarm Register. Any of the alarm messages can be disabled so that it is not entered into the alarm register. To do so, press the ALARM key in the MAIN FUNCTION block and then the ALARM CONFIG soft key. The menu shown in Figure 2–31 is displayed.

QAM ALARM: CONFIG			
SET RF		RF-LEVEL	
330.000 MHz		66.7 dBuV	
ENABLED DISABLED			LEVEL
ENABLED DISABLED			SYNC
ENABLED DISABLED			BER
ENABLED DISABLED			MPEG DATA

Figure 2–31: ALARM: CONFIG menu

By pressing the respective key, each one of the alarm modes can be individually configured. If an alarm should not be signalled, select DISABLED. Another keystroke switches back to ENABLED. Any change of the configuration is stored in the alarm register. If an alarm is disabled, the DDS200 enters “* *” in the respective column. An enabled alarm is indicated by “– –”.

NOTE. *A disabled alarm is not stored in the alarm register.*

Disabling the MPEG data alarm is only useful if you are not interested in the data errors (DE). If you disable the MPEG data alarm, fewer errors are generated and you can keep longer logs of other errors.

Alarm Register. The alarm register is an internal memory where alarm messages are stored together with their respective date and time. The memory has a depth of 1000 lines and is in the form of a ring register. Every second, the DDS200 checks whether any of the following errors has occurred in the QAM signal:

- Input level (LV): level at the analog RF or IF inputs is below the threshold (see page 2–41)
- Synchronization (SY): frame synchronization of MPEG transport stream
- Bit-error rate (BE) is above the threshold (see page 2–41)
- Data error caused by uncorrectable events (DE)

If one of the above-mentioned errors is identified, it is entered in the register with the abbreviation in brackets. (For disabling messages, refer to page 2–38). Please note the following:

- If several data errors occur within one second, the error messages (DE) are combined into one entry.
- Alarm messages are not registered every second in the alarm register. An alarm is recorded once at the time when it first occurs and at the time when it disappears for the first time (“–”).
- When an alarm has been DISABLED in the ALARM CONFIG... menu, two asterisks (“*”) are entered in the respective column. These asterisks indicate that the alarm has been masked and cannot trigger an alarm message.

Pressing the ALARM key in the MAIN FUNCTION block causes the alarm register to be displayed (see Figure 2–32).

QAM ALARM			
SET RF 330.000 MHz		RF-LEVEL 66.7 dBuV	
NO	DATE/TIME	ALARM	
997			REGISTER CLEAR ...
998			ALARM THRESH ...
999			ALARM CONFIG ...
0	17.06.96 17:20:15	REG. CLEARED	
1	17.06.96 17:20:16	LV SY -- --	
2	17.06.96 17:20:17	LV -- -- DE	LINE
3	17.06.96 17:20:18	-- SY BE DE	NEWEST MAN
4	17.06.96 17:20:20	-- SY BE --	PRINT ...
5	17.06.96 17:20:21	-- -- BE --	
6	17.06.96 17:20:23	-- -- -- DE	STATISTICS ...
	17.06.96 17:20:24	-- -- -- --	

Figure 2–32: ALARM Register menu

Alarm messages are entered in the register in chronological order. The latest entry is entered in the lowest line. The display mode is such that the line entered last is displayed at the bottom of the screen when the LINE NEWEST soft key is pressed. The number at the beginning of each line indicates the currently used line of the alarm register. Any line of the alarm register can be displayed by entering a number (terminate with ENT) or by means of the cursor keys (provided LINE MAN is first selected). In this case, the NEWEST LINE field is blanked. Newly arriving messages continue to be entered. The current alarm message is displayed when the LINE NEWEST soft key is pressed again. The indication is switched back to the current alarm message. The register contains 1000 lines. If this number is attained, entered messages are automatically overwritten starting at line 0. In this case, the entry in line 0 is no longer the oldest but the latest entry.

Three entries in the alarm register are made automatically by the DDS200 without an alarm message being received:

- Date and time when the register was cleared (REG. CLEARED).
- Date and time to which the internal system clock was changed last (TIME CHANGED).
- Date and time at which the user disabled or enabled an alarm.

Setting Limit Values. The DDS200 continuously monitors the applied QAM signal for compliance with set thresholds. These limit values are error thresholds. If one of these limits is exceeded, the ALARM LED on the front panel lights and a message with data and time is entered in the alarm register provided this type of alarm is not disabled (see page 2–38 and 2–39). This applies to the following parameters:

- LEVEL: Monitoring of input level
- BER: Monitoring of bit-error rate (preset value is 1.0 E–4)

For changing thresholds, press the **ALARM THRESH...** key in the **ALARM** menu. The following menu shown in Figure 2–33 is displayed.

QAM ALARM: THRESHOLD			
SET RF		RF-LEVEL	
330.000 MHz		--- dBuV	
LEVEL <	40.0 dBuV	LEVEL	
BER >	3.1E-6	BER	

Figure 2–33: ALARM TRESH menu

For setting the BER limit value the **BER** key has to be pressed. A numeric value can now be directly entered. The lowest useful threshold that can be entered is 0.1 E-09. In this case, an alarm is triggered whenever the BER is not 0.0 E-09. If 0.0 E-09 is entered (that is, the alarm is continuously triggered), 0.0 E-00 is displayed after confirmation with ENTER, which is mathematically the same.

Statistics. Messages in the alarm register of the DDS200 can be statistically evaluated. The whole monitoring period is considered in the evaluation; this includes all alarm messages that occurred between the last entry of REG. WAS CLEARED or TIME WAS CHANGED and the calling up of the statistics function. The evaluated period is indicated (**MONITORING TIME**). The statistics function is called up by first pressing the **ALARM** function key and then the **STATISTICS...** soft key. In this case, the menu shown in Figure 2–34 is displayed.

QAM ALARM: STATISTICS			
SET RF		RF-LEVEL	
330.000 MHz		66.7 dBuV	
MONITORING TIME: 00:00:10			
LEVEL:	LV = 00:00:02	20.00 %	
SYNCHRONISATION:	SY = 00:00:04	40.00 %	
BIT ERROR RATE:	BE = 00:00:05	50.00 %	
MPEG DATA ERROR TIME:	DE = 4 s	40.00 %	
MPEG DATA ERROR CNT:	N = 55		
MPEG DATA CORR CNT:	N = 1452		
			PRINT

Figure 2-34: ALARM: STATISTICS menu

The displayed times are the sums of times during which an alarm was active over the monitoring time. In the case of a data error (DE), the number of events (to be more exact, the duration of the error in seconds) is summed up.

Statistical values are calculated in addition and indicated as an error in %. The percentage values are always referenced to the elapsed monitoring time. A 0.13% for MPEG DATA ERROR TIME would mean that faulty MPEG data were received for 0.13% of the seconds of the monitoring period. At this point, it cannot be distinguished whether the error lasted for one second or whether it occurred several times within this period.

Detailed error information can be obtained from the MPEG DATA ERROR CNT and MPEG DATA CORR CNT counters, which indicate the absolute number of faulty MPEG frames detected (MPEG DATA ERROR CNT, 1 frame comprises 188 information-bearing bytes) or the absolute number of corrected bytes (MPEG DATA CORR CNT). When the alarm register is cleared, both counters are reset to 0. The counting limit is 4 294 836 225. When this number is reached, the counter stops. In the worst case, an overflow of the ERROR counter occurs after 5.88 hours of continuous errors at a symbol rate of 6.9 MSPS with 64QAM modulation. In practice, the number of faulty MPEG frames is below 1%, which makes the measurement time of the ERROR counter to be more than three weeks.

NOTE. The two counters, *MPEG DATA ERROR CNT* and *MPEG DATA CORR CNT*, are reset to 0 when the alarm register is cleared. If in the course of time more than 1000 entries are made in the alarm register; the *MONITORING TIME* in the register and the statistical calculation are referred to the period indicated in the register; but the counters are not reset. They show the total count since the register was cleared last, even if there are more than 1000 entries in the alarm register.

With the aid of the statistics, the user is able to assess the QAM signal over an extended period of time. The error indication in % is important as a proof for the correct functioning of a transmission link.

Printing the Register. The currently displayed screen content can be printed any time by pressing the **HARDCOPY** key. A precondition is that the printer driver in the **SETUP: PRINTER** menu has been set correctly.

Since the alarm register (or parts thereof) can be printed in so many ways, the selectable modes are offered in a separate menu. This menu can be displayed by pressing the **ALARM** key in the **MAIN FUNCTION** block and then the **PRINT** soft key. The menu shown in Figure 2–35 is displayed.

QAM ALARM: PRINT			
SET RF		RF-LEVEL	
330.000 MHz		66.7 dBuV	
			LAST LINES
			LINE
			ACTUAL

Figure 2–35: ALARM: PRINT menu in the QAM demodulator mode

The alarm register continues to be displayed, only the soft keys have changed. Now the desired printout can be selected. Pressing the ACTUAL key once switches the DDS200 to a status where the head of the hardcopy with the most important settings is printed first. Each subsequently arriving alarm message is then output separately to the printer. In this case, the ACTUAL field is in inverse video. When the ACTUAL key is pressed again, this function is disabled. It serves for recording of incoming alarm messages. Date and time are indicated in each printed line.

NOTE. *With no printer connected or if a connected printer has run out of paper, an error message is displayed briefly, and printing is interrupted. This also happens when the actual line is printed (PRINT: ACTUAL). After the error has been eliminated (for example, a printer is connected), the setting must be selected again.*

When the LAST LINES... key is pressed, any number of lines can be printed, starting from the alarm message received last. When the LAST LINES... soft key is pressed, the menu shown in Figure 2–36 is displayed.

OAM ALARM: PRINT LAST			
SET RF		RF-LEVEL	
330.000 MHz		66.7 dBuV	
LAST LINES = 5			LAST LINES
			PRINT

Figure 2–36: ALARM: PRINT: LAST LINES... menu

The value can be varied by an entry on the numeric keypad (terminate with ENT) or by means of the cursor keys. The entered numeral indicates the number of lines to be printed, starting from the last line. Once the correct number has been entered, printing can be started by pressing PRINT.

Printing of alarm messages with LINE... is performed in a similar way. Contrary to the printout selected with LAST LINES..., any group of lines in the alarm register can be printed. The DDS200 asks for the start- and end-line numbers, which can be entered separately. Entries are made in the same way as described for the printout selected with LAST LINES... . When the PRINT key is pressed, the alarm messages associated with the selected line numbers are printed. If the start-line number is higher than the stop-line number, an error message is output. An exception is if there are exactly 1000 entries in the alarm register, printing can be continued beyond line 000.

Example:

```
START LINE = 995
STOP LINE = 005
PRINT: ⇒11 lines from 995 to 005 are printed
```

A started printing procedure can be aborted with the ABORT key.

Clearing the Register. The alarm register of the DDS200 is automatically cleared when one of the following conditions occurs:

- The supply voltage is switched on.
- The RF is changed.
- Another input or input filter (SAW filter) is selected.
- A new QAM order or symbol rate is selected.
- The equalizer setting or the loop bandwidth is changed.
- MPEG data outputs are newly configured.
- The constellation diagram or the parameter calculation is activated.
- The external BER measurement is disabled.
- The PRESET key is pressed.

The register can also be manually cleared. This is done by pressing first the ALARM function key and then the REG. CLR... (Register Clear) soft key. The instrument queries whether the register should really be cleared. When YES is pressed, the register is cleared completely and date and time of the clearing are entered in line 0 of the register. The register is now ready for entering new alarm messages.

MEASURE Menu

The DDS200 has a measurement menu in which all main parameters are displayed. To activate this menu, press the MEASURE key in the MAIN FUNCTION block. The menu shown in Figure 2–37 is displayed,

QAM MEASURE			
SET RF		RF-LEVEL	
330.000 MHz		66.7 dBuV	
LEVEL	66.7 dBuV	CONSTELL	DIAGRAM...
BER	6.5E-6 (7/10)	SPECTRUM...	
SYMBOL RATE	6.900 MSPS	ECHO	PATTERN...
ORDER OF QAM	64 (MAN)	QAM PARA-	METERS...
		ADD. NOISE	OFF

Figure 2–37: MEASURE menu

The LEVEL and BER parameters are shown in the upper section of the display. These values are continually updated. The level unit is configured in the SETUP: LEVEL UNITS menu and automatically converted.

If applicable, the following messages are displayed:

- FRAME UNSYNC
- SYMBOL RATE UNSYNC
- CARRIER RECOVERY UNSYNC
- I/Q INTERCHANGED
- EQUALIZER UNLOCKED / OFF / FREEZE

If none of the messages is displayed, the corresponding synchronizations are in order.

Table 2–2 provides more detailed information about the messages.

Table 2–2: Messages displayed in the MEASURE menu

Message	Meaning	Possible sources
BER EXTERN	External BER measurement mode selected (SPECIAL FUNCTION menu).	
SYMBOL RATE UNSYNC	Symbol rate recovery not synchronized.	The set symbol rate is not correct (STATUS menu).
CARRIER RECOVERY UNSYNC	Carrier recovery not synchronized.	The set frequency is not correct or the jitter in the signal too high.
FRAME UNSYNC	No MPEG sync word found.	The signal to be measured does not include an MPEG transport stream. This is the case if the BER is too high. See also <i>I/Q INVERSION</i> on page 2–36. EXT BER measurement mode selected (SPECIAL FUNCTION menu)
I/Q INTERCHANGED	Recovery of MPEG transport stream correct but data resulting from demapping were inverted.	If the QAM signal is converted to another frequency, the spectrum is inverted if the conversion oscillator frequency is higher than the signal frequency. The DDS200 identifies this inversion and automatically corrects the decoded data information so that a valid MPEG data stream is available at the MPEG outputs. See also <i>I/Q INVERSION</i> on page 2–36.
EQUALIZER UNLOCKED / OFF / FREEZE	Equalizer unable to adapt to channel.	OFF or FREEZE: set equalizer to AUTO (refer to <i>EQUALIZER MODE</i> on page 2–34). UNSYNC: Conditions at the instrument input are so unstable that the equalizer cannot synchronize. This happens in the case of considerable level variations or when the transmission path of the QAM channel has been changed.

If a hardware-relevant error occurs, the SELFTEST ERROR CODE is displayed in the bottom line of the MEASURE menu. For evaluation of the SELFTEST ERROR CODE, refer to *Selftest (QAM)* on page 4–3.

Common to all MEASURE menus is that a noise generator can be connected. The noise generator in the OFF condition is activated with the ADD. NOISE key. The desired value for the C/N ratio can now be entered in dB. When a noise signal is added to the information signal, conclusions can be made about the system characteristics.

For further information, refer to *BER as a Function of C/N, Calculation of Further Parameters* on page 2–82. The noise power is always derived from the noise power set in the instrument in connection with the selected channel bandwidth (refer to *SAW Filter* on page 2–31).

BER Measurement. During normal reception, the BER is continuously calculated in the DDS200. The raw BER (BER before any error correction is made) is indicated. The BER measurement is fully automatic. The instrument selects the required integration rate, depending on the error rate measured. The integration rate is indicated in brackets after the measured value. It is always specified in samples; the duration of a sample depends on the selected order of QAM and on the symbol rate.

With 64 QAM and 6.900 MSPS, the BER events occurring in 241.55 ms are combined to one sample. The second value in brackets states the number of samples collected by the instrument after the measurement is completed (last count). The first value indicates the recorded samples. The indication (133/1000) means that 133 of the 1000 desired measurement results (last count) have already been collected and stored. Of course, the BER can be evaluated now, but the accuracy is not of optimum value. The first value is regularly increased until the last count is reached.

At this stage a switch over is made to a running BER calculation: the last 1000 samples are combined to one measured value so that a new set of values is obtained every 241.55 ms. The great advantage of this method is that indicated BER is always the latest value, since the measured value is continuously updated. The system is flexible enough to immediately reduce the number of integrated samples at a sudden deterioration of the input signal quality, such as when a noise generator is connected.

The running BER calculation can best be explained with an example using 10 as the last count (see Figure 2–38). The other counts can be deducted.

NOTE. *BER, as measured by the DDS200, may be limited by system noise to $\leq 10^{-6}$ in 256 QAM.*

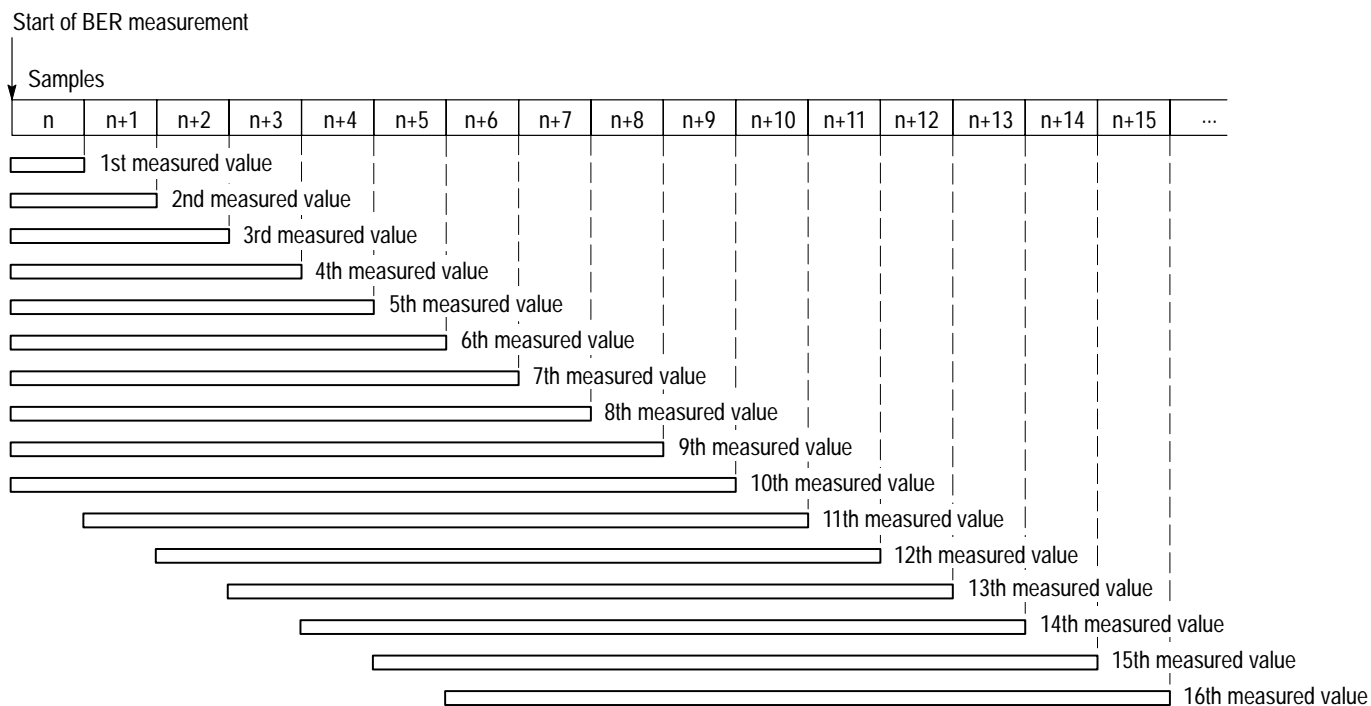

Figure 2–38: Recording the BER: running BER calculation over 10 samples

The BER measurement is restarted each time the alarm register is initialized automatically (refer to *Clearing the Register* on page 2–45). Moreover, a new BER measurement is triggered whenever the attenuator of the DDS200 is manually or automatically set. For further information on BER measurements refer to *Selection of Integration Time for BER Measurement* on page 2–79 and *BER Measurement with External Equipment* on page 2–80.

NOTE. If *FRAME UNSYNC* is displayed in the *MEASURE* menu, the DDS200 has found no MPEG sync word in the transmitted data. This happens when the modulator is operated with PRBS data. In this case, the BER measurement is not useful.

If *MIN BER integration* has been set to *BER EXT* in the *SPECIAL FUNCTION* menu, *EXTERNAL* is displayed instead of the measured BER. In this case, frame synchronization can no longer be identified. Refer to *MIN BER INTEGRATION* on page 2–35.

Constellation Diagram. Using the CONSTELL DIAGRAM... key, the DDS200 is switched to the constellation analyzer mode. The constellation diagram is an extremely useful tool for assessing the quality of the transmitted signal. In this mode, no BER measurement (via the IEC/IEEE bus) can be performed, and all MPEG outputs are disabled. Before the other keys for configuring the diagram will be described, the basic diagrams are explained.

Figure 2–39 shows a constellation diagram with no input signal present; only the noise is displayed. Noticeable is the gradually decreasing density of measured values towards the outside. Figure 2–40 shows a QAM signal with unsynchronized symbol clock. The characteristic here is the clear spatial limitation of measured values. For a correct synchronization of this signal, the order of QAM and/or the symbol rate should be checked (refer to *SYMBOL RATE* on page 2–30).

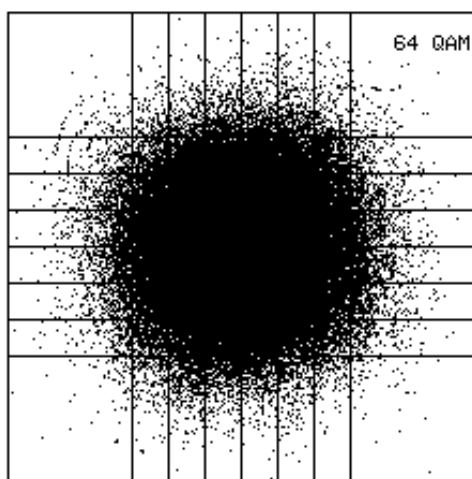

Figure 2–39: Noise at input, no QAM signal

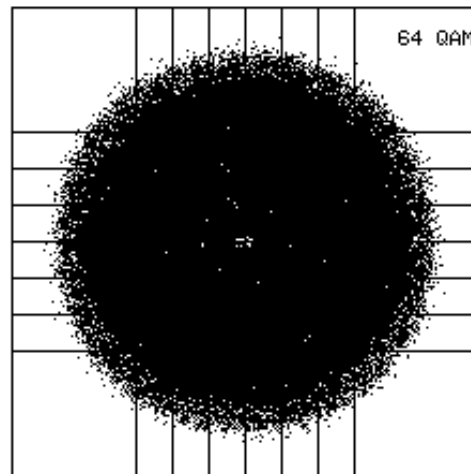

Figure 2-40: QAM signal with unsynchronized carrier and symbol rate

Figure 2-41 shows a 64QAM signal with synchronized symbol clock rate. However, the constellation diagram rotates about its center because the carrier is not synchronized (CARRIER RECOVERY). This may happen, for instance, when the set frequency is not correct.

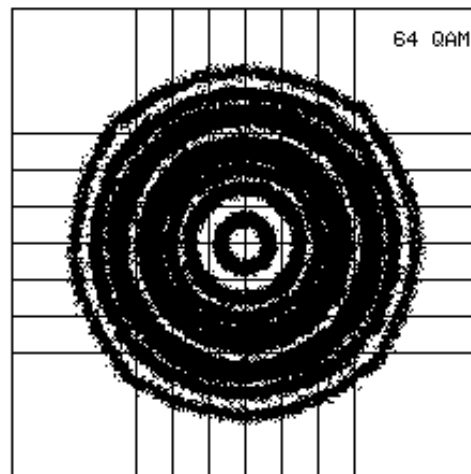

Figure 2-41: QAM signal with unsynchronized carrier

Figure 2–42 shows a constellation diagram with correct synchronization.

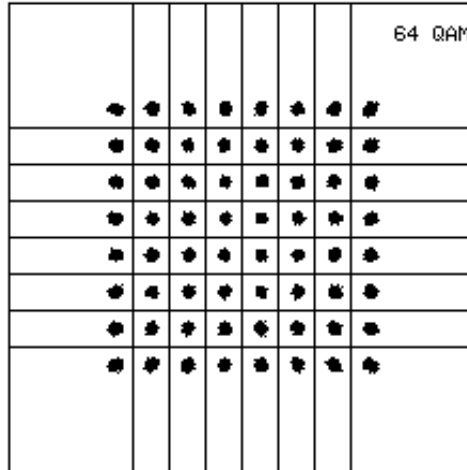

Figure 2–42: Correctly synchronized 64QAM signal

Figure 2–43 shows the CONSTELLATION DIAGRAM menu.

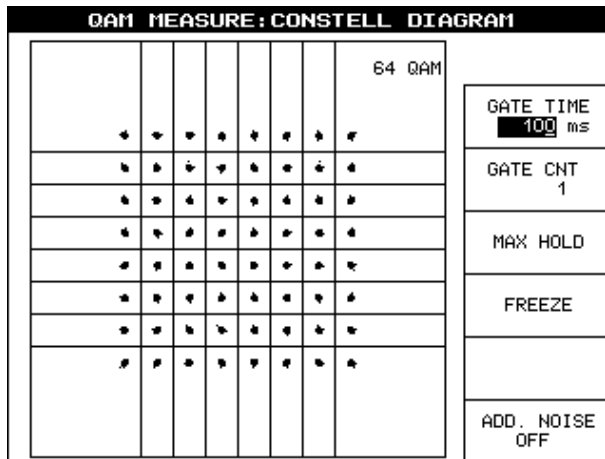

Figure 2–43: MEASURE: CONSTELLATION DIAGRAM menu

For further examples and a description of individual errors parameters, refer to *Application and Interpretation of Constellation Diagram* on page 2–62.

Using the GATE TIME, GATE CNT, MAX HOLD and FREEZE keys, you may adapt the constellation diagram to your special requirements. Operation in the constellation analyzer mode is illustrated in Figure 2–44.

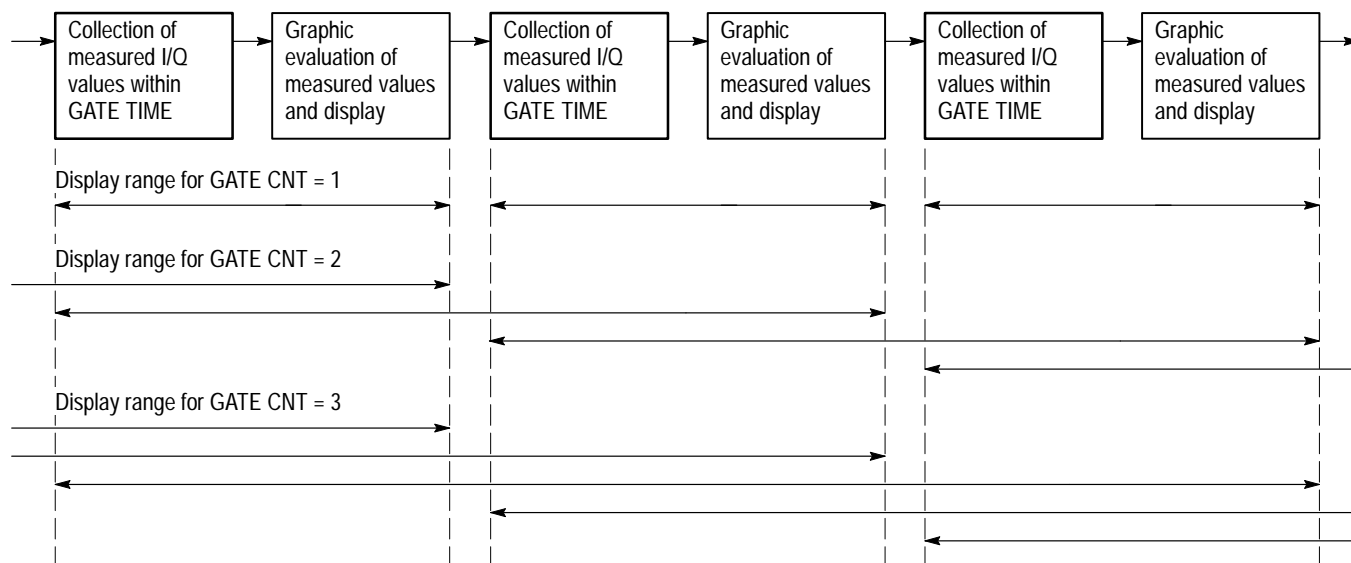

Figure 2–44: Function of GATE TIME and GATE CNT

Using the GATE TIME key, a collection time between 2 ms and 1000 ms can be set. Within this period, the DDS200 stores the received I/Q value pairs every 740 ns. Thus 1.351 million I/Q values are available every second. Subsequently, the data are read again from the memory and displayed. This procedure takes approximately 250 ms. If GATE CNT = 1 has been selected, a new cycle with new I/Q values is started when a cycle is completed independent of the previous values and is then displayed.

With GATE CNT = 3 selected, a collected I/Q value remains in the display over 3 complete cycles. During this time, new cycles are started the measured data of which are again displayed for 3 cycles. This display is still being updated, although the integration time is now three times as long as before. The setting range for GATE CNT is 1 to 99999.

A special function is offered by the MAX HOLD key. In this case, the GATE TIME is set to 1000 ms and the value of GATE CNT is set to infinite. Using this function, long-term monitoring can be performed, since displayed I/Q values are only cleared when the function is terminated.

With the aid of the FREEZE key, the currently displayed constellation diagram can be frozen. This function is useful when a particular event should be retained on the screen for printing.

QAM Parameters. When the QAM PARAMETERS key is pressed, the DDS200 is switched to parameter calculation. The parameters selectable in the constellation analyzer mode are now preset and can no longer be varied:

GATE TIME = 750 ms,
GATE CNT = 1.

During the set gate time of 750 ms, approximately 840,000 I/Q values are stored in the internal data memory and used for statistical evaluation. A specified value is completely independent of all others. Using suitable computation, a value can be completely separated from the effects of other values. The signal to be measured should comprise a minimum of errors (phase error, amplitude imbalance, carrier suppression) so that available margins are free for disturbances (for example, noise) that cannot be avoided.

A list of parameters is given in Table 2–3. Provided the listed parameters do not occur at the same time, the set limit values should not be exceeded to afford useful transmission. In the case of combined parameters, limits are correspondingly reduced. As the variety of combinations is almost infinite, no values can be specified for such a case. Specified values are based on experience, simulation, and measurements on the QAM modulators.

Table 2-3: Suitable limit values for QAM parameters

Order of QAM	C/N for BER $< 10^{-4}$	Phase ripple and PE in the passband range (max)	Amplitude ripple and AI in the passband range (max)	Intermodulation products (max)	Discrete and general interference and CS (max)	Linearity (3rd order mode)
4	12 dB	$< 10^\circ$	$< \pm 1$ dB	27 dB	27 dB	$< -$ dB
16	18.5 dB	$< 4^\circ$	$< \pm 0.4$ dB	34 dB	34 dB	< 1 dB
32	21.5 dB	$< 3^\circ$	$< \pm 0.3$ dB	37 dB	37 dB	< 0.5 dB
64	24.5 dB	$< 2^\circ$	$< \pm 0.2$ dB	40 dB	40 dB	< 0.3 dB
128	27.5 dB	$< 1.5^\circ$	$< \pm 0.15$ dB	43 dB	43 dB	< 0.2 dB
256	30.5 dB	$< 1^\circ$	$< \pm 0.1$ dB	46 dB	46 dB	< 0.1 dB

Conditions:

1. Abbreviations: PE = phase error (modulator), AI = amplitude imbalance (modulator), CS = carrier suppression
2. Deviation from linear phase; depends on whether an equalizer is used.
3. Deviation from ideal amplitude-frequency response; depends on whether an equalizer is used.
4. The C/N ratio only applies if all other conditions are ideal.
5. For the specified linearity, the level drop for a basic signal constellation is specified.
6. All values are based on experience, calculation and simulation. Specified limit values guarantee acceptable reception, provided no other types of error occur.

Valuable information on the definition of parameters, calculation methods, and interpretation are given in *Explanation of Calculated Parameters, Formulas and Limit Values* on page 2-68.

Spectrum Measurement and Echo Display. A SPECTRUM and an ECHO PATTERN function are available to help understand the characteristics of your transmission channel. Both functions rely on the capability of the instrument to adapt to receiving conditions via the integrated, self-adapting equalizer. The internal equalizer coefficients are accessible in the instrument are mathematically evaluated to create these displays. With both functions, the calculation is performed only once, since reading out the coefficients takes several seconds. Another press of the SPECTRUM or ECHO PATTERN key causes the display to be updated.

NOTE. For reading out the equalizer coefficient, the equalizer is automatically set to the FREEZE mode using the SPECTRUM and the ECHO PATTERN functions. The BER may deteriorate during the readout. This is particularly noticeable when MPEG data are processed at the same time.

In the SPECTRUM... display (see Figure 2–45), the coefficients are used for calculating the phase- and amplitude-frequency response in the transmission channel.

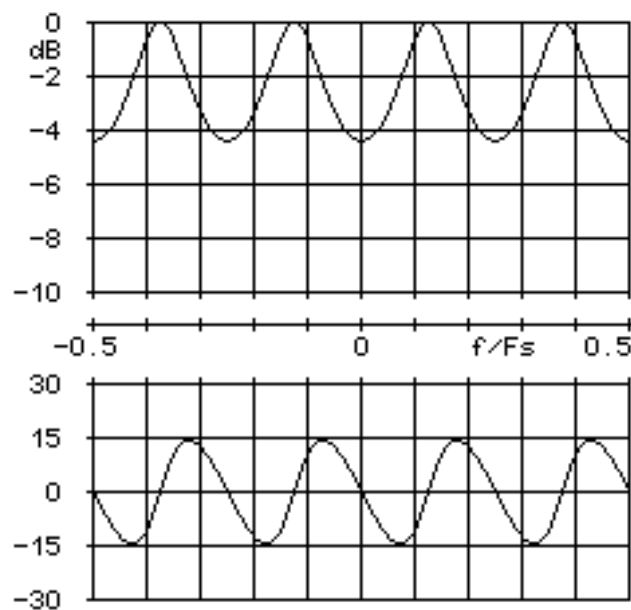

Figure 2–45: MEASURE: SPECTRUM menu

The frequency scale is based on the current symbol rate F_S . Consequently, in the range -0.5 to $+0.5$ the spectrum of the whole signal (including the Nyquist frequencies) is displayed. The unit of the amplitude scale is decibel (dB); the unit of the phase scale is degree ($^\circ$). Spectrum scales are fixed and cannot be varied.

In the ECHO PATTERN... display (see Figure 2–46), the equalizer coefficients are used for calculating the echos or reflections in the receive channel.

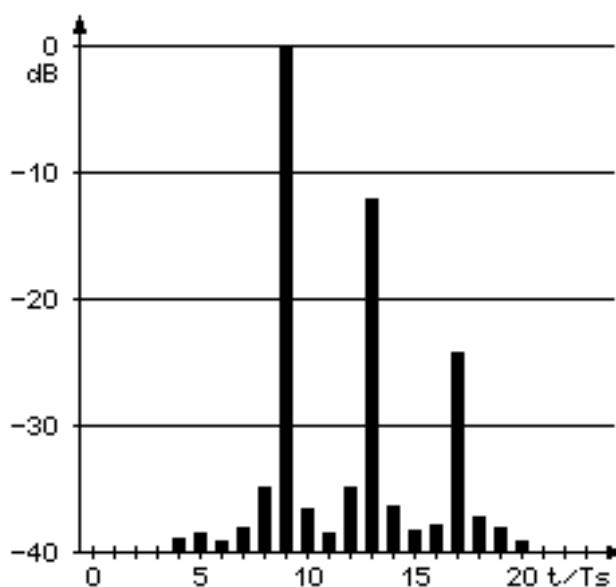

Figure 2-46: MEASURE: ECHO PATTERN menu in the QAM demodulator mode

The echo diagram clearly shows the position of the central tap (in this case, position 9). It can be configured using a special function (see *SPECIAL FUNCTION Menu* on page 2-34). Pre-echoes are at the left of the central tap, post-echoes at the right. Pre-echoes may be caused by cross talk in filters; post-echoes are mainly due to reflections.

The diagram is divided into time intervals of one symbol each. The symbol period T_s is set by means of the reciprocal symbol rate SR in the STATUS: SYMBOL RATE menu (refer to *SYMBOL RATE* on page 2-31). The following applies:

$$T_s = 1 / SR$$

The symbol rate in samples per second should be used in this case. With $SR = 6.900$ MSPS, the symbol period is 144.9 ns. The unit of the level scale is dB. Both scales of the echo diagram are fixed and cannot be varied.

NOTE. The spectrum and echo displays are simply different ways of looking at the linear distortions in the transmission channel and are not completely independent of each other. The only difference is that the equalizer coefficients are interpreted in different ways.

Preset Values and Menu Overview

NOTE. PRESET values are printed in bold.

Table 2–4: DDS200 Preset Values

INPUT page 2–27	RECEIVER		
	DEMOD		
	ATTENUATION...	AUTO AUTO LOW NOISE AUTO LOW DIST AUTO LOWS DIST MANUAL 10dB PREAMPLIFIER	
RF page 2–29	RF (numeric entry)	330 MHz	
	RCL RF		
	STO RF...	RIGHT LEFT GET CHAR DEL CHAR ENTER	
STATUS page 2–30	SAW FILTER BW page 2–31	OFF 8 MHz	
	SYMBOL RATE... page 2–31	UPPER SEARCH LIMIT	(numeric entry) 7.000
		LOWER SEARCH LIMIT	(numeric entry) 1.000
		SYMBOL RATE VALUE	(numeric entry) 6.900
		START AUTO SEARCH	
	STOP AUTO SEARCH		
ORDER OF QAM page 2–33	AUTO 4 16 32 64 128 256		

Table 2-4: DDS200 Preset Values (cont.)

	BEEPER... page 2-33	CLOCK SYNC LOST	ENABLED DISABLED
		EQUALIZER SYNC LOST	ENABLED DISABLED
		CARRIER SYNC LOST	ENABLED DISABLED
		FRAME SYNC LOST	ENABLED DISABLED
		MPEG DATA ERROR	ENABLED DISABLED
		MPEG DATA CORRECTION	ENABLED DISABLED
SPECIAL FUNCTION page 2-34	EQUALIZER... page 2-34	EQUALIZER MODE	AUTO FREEZE OFF
		CENTRAL TAP POSITION	(numeric entry) 9
	ROLLOFF FACTOR page 2-35	0.15	
		0.20	
		0.25	
		0.30	
MIN BER INTEGRATION page 2-35	BER EXT	Connectors X5 / X6 active	
	1 (SAMPLE)		
	10 (SAMPLES)		
	100 (SAMPLES)		
LOOP BANDWIDTH page 2-35	HIGH		
	MED		
	LOW		
MPEG DATA OUTPUT... page 2-36 (2.5.5.5)	REED SOLOMON DECODER	ON OFF	
	ERROR INDICATION BIT IN MPEG FRAME	ENABLED DISABLED	

Table 2-4: DDS200 Preset Values (cont.)

		PARALLEL MPEG DATA PLL	ON OFF	
		SER / PAR MPEG DATA FRAME SIZE	188 BYTES 204 BYTES	
ALARM page 2-38	REGISTER CLEAR... page 2-45	YES NO		
	ALARM THRESHOLDS... page 2-41	LEVEL	(numeric entry), -60 dBm	
		BER	(numeric entry), 1,0E-4	
	ALARM CONFIG... page 2-38	LEVEL	ENABLED DISABLED	
		SYNC	ENABLED DISABLED	
		BER	ENABLED DISABLED	
		MPEG DATA	ENABLED DISABLED	
	NEWEST LINE			
	PRINT... page 2-43	LAST LINES...	Entry of number of last lines to be printed, start with PRINT, 5	
		LINES...	Entry of range of lines to be printed, start with PRINT	
ACTUAL ALARM		(toggle key)		
STATISTICS... page 2-41				
MEASURE page 2-46	CONSTELL DIAGRAM... page 2-50	GATE TIME	(numeric entry), 100 ms	
		GATE COUNT	(numeric entry), 1	
		MAX HOLD	(toggle key)	
		FREEZE	(toggle key)	
	ECHO PATTERN... page 2-55			
	SPECTRUM... page 2-55			
	QAM PARAMETERS... page 2-54			
	ADDITIONAL NOISE page 2-46	Toggle key for switch over between numeric value and OFF	(numeric entry) C/N=62dB	

Table 2-4: DDS200 Preset Values (cont.)

SETUP	TIME & DATE...	TIME	(numeric entry)
		DATE	(numeric entry)
	REMOTE...	IEC625 / IEEE488	(numeric entry) 6
	PRINTER...	PRINTER TYPE	EPSON COMP. R&S PUD COMP. HP COMP.
		FORMFEED	NO AFTER PRINTOUT
	LEVEL UNITS...	dBpW dBuW dBm dBuV uV/mV	
	LCD INVERS	ON	
		OFF	

Examples of Application

This section is divided into the following subsections:

<i>Application and Interpretation of Constellation Diagram</i>	page 2–62
<i>Explanation of Calculated Parameters, Formulas and Limit Values</i>	page 2–68
<i>Selection of Integration Time for BER Measurements</i>	page 2–79
<i>BER Measurements with External Equipment</i>	page 2–80
<i>BER as a function of C/N, Calculation of Further Parameters</i>	page 2–82
<i>Assignment and Functions of Parallel and Serial MPEG-2 Outputs</i>	page 2–85
<i>Analog and Digital Cascading of Two Digital Demodulation Systems</i>	page 2–88

Application and Interpretation of Constellation Diagram. In this subsection, the basic causes of specific modulation errors are described with the aid of simulated constellation diagrams. Using simulated data is instructive, especially because it allows different effects to be demonstrated separately. In the examples shown below, the following basic settings were used:

A maximum possible DVB data transmission rate of 6.92 MSPS (mega symbols per second) or 41.73 Mbit/s (with 64QAM)

Cosine roll-off filtering with roll-off factor $r = 0.15$

PRBS (pseudo random binary sequence) data stream; no coding

In practice, there is always a combination of various modulation errors that may be difficult to separate and identify. To this end, the DDS200 Digital Demodulation System evaluates the measured constellation diagram using mathematical and statistical methods and furnishes a quantitative representation of results (refer to *Explanation of Calculated Parameters, Formulas and Limit Values* on page 2–68).

All constellation diagrams shown are based on 64QAM modulation. The effects of the modulation errors shown, however, apply to all other orders of QAM.

First, a constellation diagram is shown, representing a very clean 64QAM signal (see Figure 2–47).

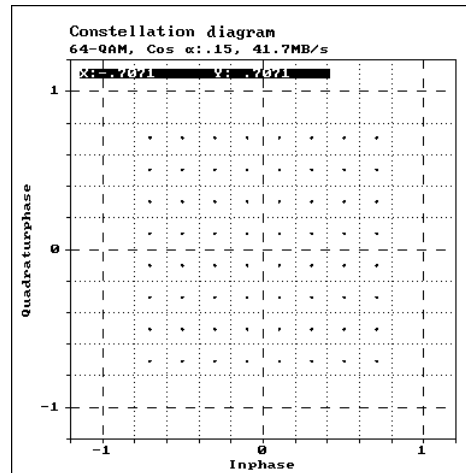

Figure 2–47: Constellation diagram of ideal 64QAM signal

The following are examples of modulation errors and the resulting constellation diagrams:

- Amplitude Imbalance

Amplitude imbalance describes the different gains of the I and Q components of a signal. Such a difference in amplitude is caused by different gain in the two signal paths (I and Q) of the transmitter. In a constellation diagram, amplitude imbalance shows by one signal component being expanded and the other one being compressed. This is due to the fact that the receiver AGC makes for a constant average signal level. See Figure 2–48.

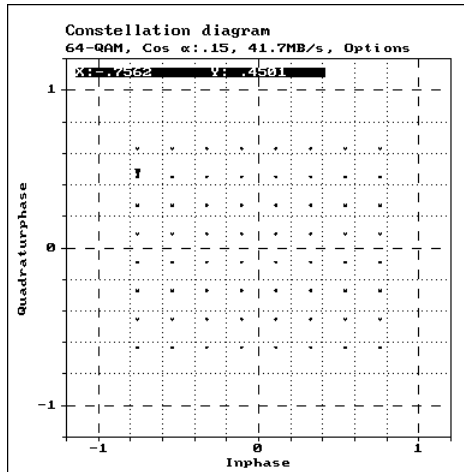

Figure 2-48: Constellation diagram of 64QAM signal with 20% amplitude imbalance

■ Phase Error

The phase error (frequently also referred to as quadrature offset or quadrature error) is the difference between the phase angles of the I and Q components, referenced to 90° . A phase error is caused by an error of the phase shifter of the I/Q modulator. The I and Q components are, in this case, not orthogonal to each other after demodulation. In the constellation diagram, a phase error shows up by the signal states being arranged in a rhombus rather than a square. See Figure 2-49.

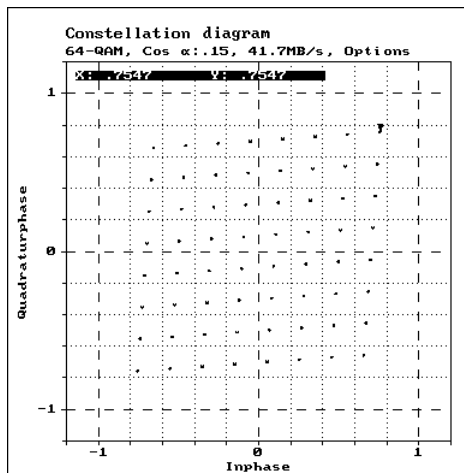

Figure 2-49: Constellation diagram of 64QAM signal with 8° phase error

■ Interferer

Interferers are sinusoidal spurious signals occurring in the transmission frequency range and superimposed on the QAM signal at some point in the transmission path. After demodulation, the interferer is contained in the baseband in the form of low-frequency sinusoidal spurious signals. The frequency of these signals corresponds to the difference between the frequency of the original sinusoidal interference and the carrier frequency in the RF band. In the constellation diagram, an interferer shows up in the form of a rotating phasor superimposed on each constellation point. Figure 2–50 is an example constellation when there is single interferer, and other impairments. The constellation diagram shows the path of the phasor as a circle around each ideal constellation point.

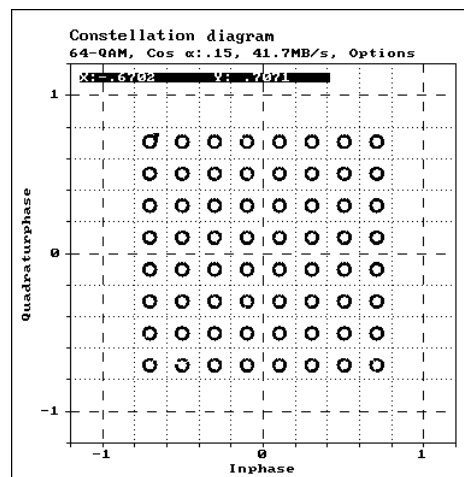

Figure 2–50: Constellation diagram of 64QAM signal with interferer (C/I = 25.0 dB)

NOTE. When using a self-adapting channel equalizer, as in the DDS200 Digital Demodulation System, a partial compensation of the sinusoidal interference takes place. The equalizer must be switched off to enable correct assessment of the interference.

■ Carrier Suppression

The residual carrier gives rise to a special type of interference, whose frequency equals the carrier frequency in the RF channel. A residual carrier is superimposed on the QAM signal in the I/Q modulator. Since the interference and the carrier have the same frequency, a DC component is obtained in the baseband. The distribution of this DC component to the I and the Q component depends on the phase difference between the residual carrier and the recovered carrier.

The magnitude of the DC component is equal to the radius of a circle that would be obtained in the event of a frequency offset of the interference relative to the carrier signal. In the constellation diagram, a residual carrier shows up as a shifting of the signal states corresponding to the DC components of the I and Q components. See Figure 2–51.

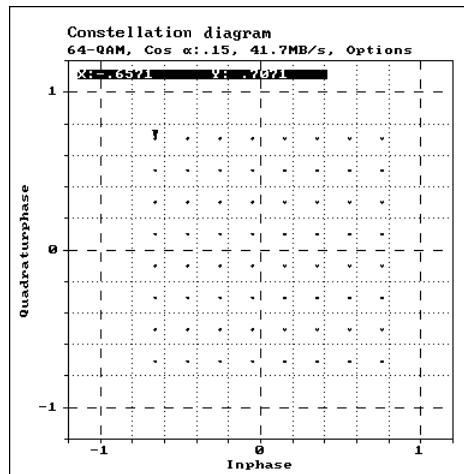

Figure 2–51: Constellation diagram of 64QAM signal with residual carrier in I component (CS = 17.6 dB)

■ Additive Gaussian Noise

Noise can disturb the digitally modulated signal during analog transmission. Additive superimposed noise normally has a constant power density and a Gaussian amplitude distribution throughout the bandwidth of a channel. If no other error is present at the same time, the points representing the ideal signal status are expanded to form circular “clouds.” See Figure 2–52.

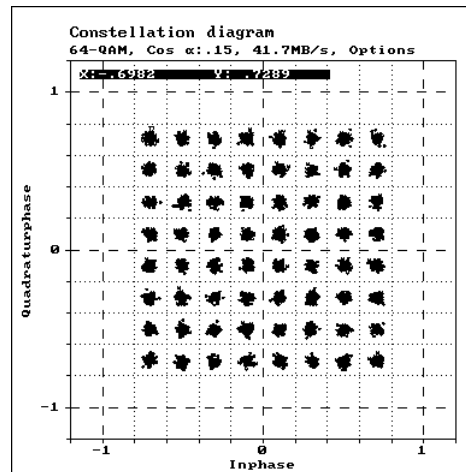

Figure 2–52: Constellation diagram of 64QAM signal with additive noise (SNR = 30.0 dB)

When interpreting the constellation diagram in Figure 2–52, note that a similar diagram may also be obtained for other types of interference so that a distinction from noise-produced patterns cannot be made. The following are types of interference that can cause constellation diagrams similar to Figure 2–52:

- Impulsive noise
- Nonlinearities in amplifiers
- Intermodulation
- Errors from uncompensated echoes and non-flat frequency response.
- Phase Jitter

Phase jitter or phase noise in the QAM signal is caused by frequency translators in the transmission path, or by the I/Q modulator. It may also be produced in carrier recovery, but this effect is small in the DDS200 demodulator and is ignored here. In contrast to the phase error described above, phase jitter is a statistical quantity that affects the I and the Q path equally. In the constellation diagram, phase jitter shows by the signal states being rotated about their coordinate origin (see Figure 2–53).

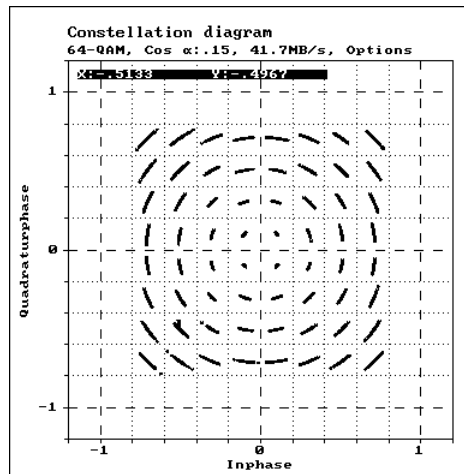

Figure 2-53: Constellation diagram of 64QAM signal with phase jitter: $PJ_{RMS} = 1.73^\circ$

Explanation of Calculated Parameters, Formulas and Limit Values. The constellation diagram of a demodulated QAM signal is an excellent tool also for a quantitative assessment of the above-named transmission parameters, allowing fast and accurate conclusions to be drawn about interference in transmission. The constellation diagram as a graphical tool for the qualitative assessment of a signal is described in *Application and Interpretation of Constellation Diagram* on page 2-62. This subsection deals with some basic algorithms that the instrument uses to provide a quantitative assessment of the parameters named above. The calculations are based on the I/Q values that make up the constellation diagram.

- Amplitude Imbalance

The amplitude imbalance (AI) can be determined by two-dimensional averaging for all points of a decision field. By evaluating the center points thus formed separately for the I and Q components, the distances between the points are obtained for each component. Next, the distances between the points are averaged separately for I and Q, resulting in an average I and an average Q distance (expressed as v_I and v_Q). From this, the amplitude imbalance is determined:

$$AI = \left(\frac{v_2}{v_1} - 1 \right) \cdot 100\%$$

where

$$v_1 = \min(v_I, v_Q) \text{ and } v_2 = \max(v_I, v_Q)$$

The result will always be ≥ 0 because the I and Q paths of the demodulator cannot be unambiguously assigned to the corresponding paths of the

modulator, since it is not known if the phase locks at $n \cdot 90^\circ$. For all calculations described below, the previous results are modified such that the effect of amplitude imbalance is eliminated. In other words, the center points are calculated that would be obtained if there was no amplitude imbalance.

- Phase Error

The phase error (PE) can be determined from the modified center points. The gradients of the regression lines drawn through the center points in the I and Q directions are calculated by separate evaluation of the I and Q components. From the gradients, angles θ_1 and θ_2 are obtained directly using the *arcsin* function:

$$PE = \frac{180^\circ}{\pi} \cdot |\Phi_1 + \Phi_2| [^\circ]$$

Again, for all further calculations, the center points are determined that would be obtained if no phase error was present.

- Carrier Suppression

To calculate the carrier suppression (CS), the distance between the calculated and the ideal center points is determined. From this, the residual carrier power P_{RC} is obtained. Moreover, the effective signal power P_{Sig} can easily be determined from the constellation diagram. It depends on the order of the QAM.

$$CS = -10 \cdot \log \left(P_{RC} / P_{Sig} \right) [dB]$$

- S/N Ratio and Interferer

To determine the signal-to-noise ratio (SNR) and the suppression of a sinusoidal interferer (C/I), only the four innermost decision fields of the constellation diagram are used. From the two-dimensional frequency distribution, it is determined if it is a pure Gaussian distribution or if a sinusoidal interferer is present additionally or exclusively. If the latter is the case, the component P_I is determined from the frequency distribution and from this the C/I ratio is obtained.

$$C/I = -10 \cdot \log \left(P_{Sig} / P_I \right) [dB]$$

To determine the amplitude of the interferer, the frequency of occurrence along a line running through the center point of a decision field is read out. Sectional views of a signal free from noise and phase jitter are shown in Figure 2-54.

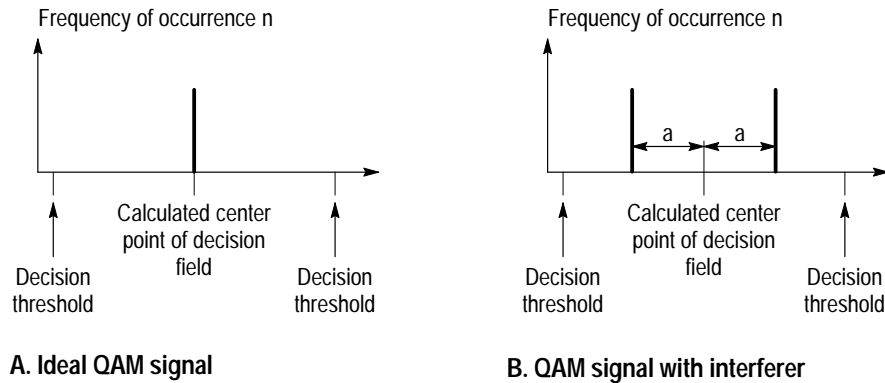

Figure 2-54: Sectional view for ideal signal (a) and signal with interferer (b)

Along this section, the local maxima of the frequency-of-occurrence characteristic are determined on both sides of the calculated center point. To reliably identify an interferer, the frequency of occurrence at the center point must be clearly smaller than at the local maxima. The distance between the local maxima and the center point obtained for the four decision fields and then averaged corresponds to amplitude a , of the interferer.

If noise ($\text{SNR} < 38 \text{ dB}$) is present in the signal, a number of additional considerations apply. For these, additive noise with a Gaussian distribution is assumed. The sectional view in this case shows two Gaussian curves more or less superimposed on each other. This is demonstrated in Figure 2-55 by a few examples showing the single curves as well as the overall curve (continuous line), which can be determined by means of the sectional view.

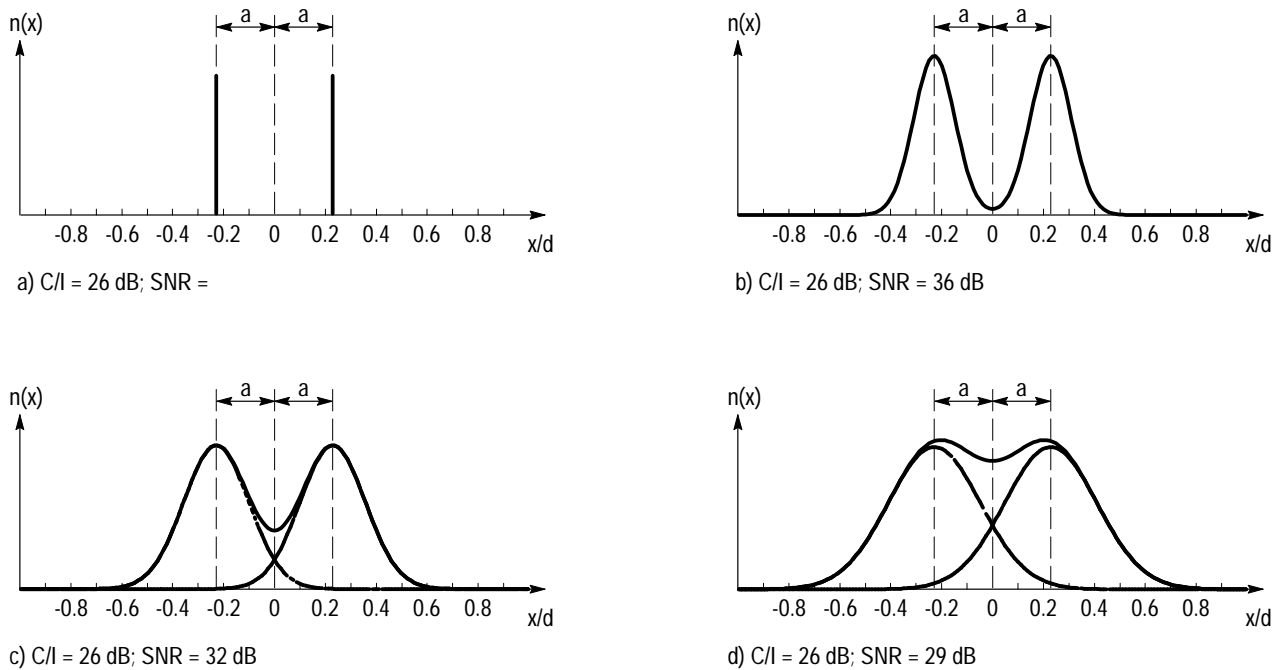

Figure 2-55: Frequencies of occurrence shown by sectional views: superimposed Gaussian curves at various noise levels and with same interferer for 64QAM

If it is required that for a reliable identification of an interferer the frequency of occurrence at the calculated center point must not exceed 90% of the frequency at the maxima, it can be shown that the condition

$$C/I < SNR - 3 \text{ dB}$$

must be fulfilled. Otherwise, it is not possible to draw any conclusions as to the presence of an interferer by means of this analysis method. The “clouds” visible in the constellation diagram will then be interpreted exclusively as additive Gaussian noise superimposed on the QAM signal.

The standard deviation σ_N can be calculated by means of statistical methods. This is done with the interferer present, using only the ranges outside the maxima since these ranges are largely unaffected by the other type of noise.

From the standard deviation σ_N , the RMS value of the noise power (N) and the signal to noise ratio (SNR) are obtained directly as follows:

$$SNR = 10 \cdot \log(P_{Sig}/N) [dB]$$

where

$$N = Q \cdot \sigma_N^2$$

According to the definition of the DVB Measurement Group, the SNR value is a pure baseband quantity. This means that the calculated SNR cannot be compared directly with the C/N value of the transmission channel. The difference between SNR and C/N lies in peaking in the constellation diagram (3 dB) and in the root-cosine roll-off filtering (0.441 dB for $r = 0.15$).

■ Phase Jitter

As a last step, the RMS value of the phase jitter must be determined. The four outer corners of the constellation diagram are assessed, since this is where phase jitter has the strongest effect. Now the frequency distribution is determined for each decision field along the four circular paths farthest away from the center point, which is the coordinate origin of the constellation diagram. Here, too, the standard deviation σ_{PJ+N} can be calculated, which is in addition affected by noise. The effect of a sinusoidal interferer, which may be present at the same time, is eliminated by way of calculation prior to determining the RMS phase jitter. According to the addition theorem of the Gaussian distribution, the following applies:

$$\sigma_{PJ} = \sqrt{\sigma_{PJ+N}^2 - \sigma_N^2}$$

The RMS phase jitter can thus be obtained by means of trigonometric conversion.

With an ideal QAM signal, all measured I/Q values lie exactly in the centers of the decision fields. If a signal is distorted, eg through amplitude imbalance, a phase error or a residual carrier, the measured I/Q values will not be in the centers of the decision fields but still concentrated on a single point in each field. The measured values are available in discrete form as a result of digital processing of the I/Q coordinates. The resolution of the measured values can be considerably increased by superimposing a small noise component ($SNR < 45$ dB) on the signal to be analyzed and, using the method described above, forming an average over several discrete values and the above-named frequency distribution. This effect is shown in Figure 2–56 for a signal distorted by amplitude imbalance.

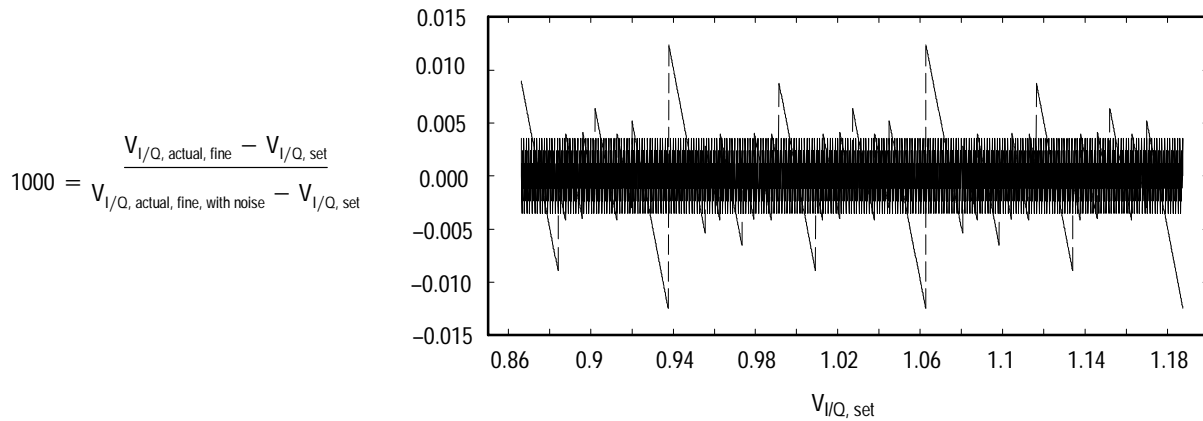

Figure 2-56: Improvement of accuracy with superimposed noise (SNR = 45 dB)

In Figure 2-56, the scaling for the gain calculated from the measured values containing noise is increased by a factor of 1000. Thus the resolution for the analysis is improved by a factor of approximately 1000. The same applies to the calculation of the other parameters. The background noise is present on every real transmission path and results in a drastic improvement of the resolution of the calculated parameters. To achieve meaningful results, a sufficiently large number of measured I/Q values are needed to form the basis for calculating the parameters in question (law of large numbers). With the DDS200, parameter calculation is based on almost 1,000,000 measured values shown on the display, which affords the necessary confidence level. With this data acquisition rate, a typical refresh rate of results of approximately 1 s is obtained.

For calculation of the parameters, there are limit values that are listed in Table 2-5. The limits result from the quantization of the measured I/Q values and from the location of the decision fields (their distance from the center point). For each limit value specified, all other interfering quantities are assumed to be zero.

Table 2-5: Theoretical maximum and minimum values of calculated parameters for various orders of QAM

Order of	AI_{\max}	PE_{\max}	CI_{\max}	CI_{\min}	CS_{\max}	CS_{\min}^*	SNR_{\max}	PJ_{\max}
4	25441%	90.0°	39.13 dB	3.15 dB	0.14 dB	36.12 dB	46.0 dB	11.26°
16	190.80 %	36.15°	40.10 dB	10.27 dB	7.26 dB	37.09 dB	46.0 dB	4.17°
32	61.54 %	23.06°	37.09 dB	13.57 dB	10.56 dB	34.08 dB	43.0 dB	2.59°
64	37.10 %	15.39°	40.31 dB	16.79 dB	13.78 dB	37.30 dB	46.0 dB	1.85°
128	19.19 %	9.82°	37.20 dB	20.29 dB	17.28 dB	34.19 dB	43.0 dB	1.22°
256	13.34 %	6.73°	40.37 dB	23.46 dB	20.45 dB	37.36 dB	46.0 dB	0.86°

* With slight noise present in the signal (SNR <45 dB), a limit value of 70 dB is obtained.

■ Modulation Error (Vector Error)

The modulation error is the combination of all interfering quantities that occur. The modulation error is a calculated quantity indicating the mean or maximum deviation of the I/Q values from ideal signal states and thus provides a measure of signal quality. The modulation error is specified as RMS and as peak value. To calculate the modulation error, all decision fields are investigated one after the other:

To obtain the peak modulation error, the maximum magnitude of the difference vector (error vector) formed by the vectors of the ideal and the actual signal status is determined for each decision field. From the maximum value of these results, the peak MER (modulation error ratio) is calculated using the following formula:

$$MER_{PEAK} = 100 \cdot \max \frac{\{|error\ vector\ |}\}}{\overline{VM}} [\%]$$

where \overline{VM} is the RMS value of the amplitudes of all ideal signal states.

To obtain the RMS modulation error, the squares of the magnitudes of all differential vectors formed by the ideal- and actual-status vectors are added up, and the number of symbols is counted. Then the RMS modulation error is calculated as follows:

$$MER_{RMS} = 100 \cdot \frac{\sqrt{\frac{1}{n} \sum |error\ vector|^2}}{\overline{VM}} [\%]$$

Figure 2–57 shows the vectors used for calculating the modulation error:

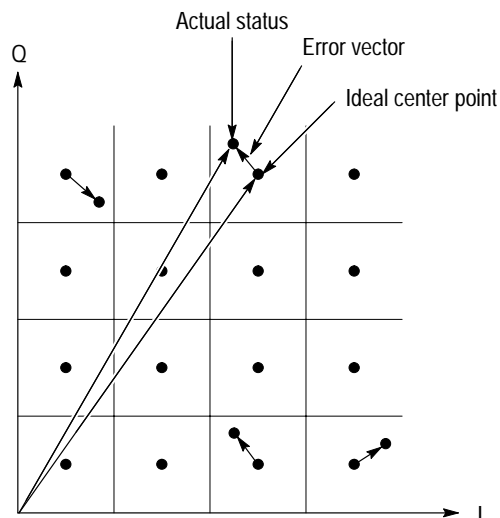

Figure 2–57: Positions of vectors used for determining the modulation error (64QAM, first quadrant only)

The peak and RMS modulation error can also be specified on a logarithmic scale. Conversion is done using the following formula:

$$MER_{dB} = 20 \cdot \log \left(\frac{MER[\%]}{100} \right) [dB]$$

For quantized I/Q values, the peak value is output in discrete form only, since no averaging is performed in the calculation. The RMS modulation error can be calculated within the limit values specified in Table 2–6, which lists the limit values obtained for quantized I/Q values.

Table 2–6: Limit values for modulation error

Order of QAM	MER _{RMS,min}	MER _{PK,min}	MER _{PK,max}	MER _{dB,max}
4	0.5%	1.563%	98.44%	46dB
16	0.5%	1.398%	43.32%	46dB
32	0.7%	1.976%	29.33%	43dB
64	0.5%	1.364%	20.46%	46dB
128	0.7%	1.952%	13.66%	43dB
256	0.5%	1.356%	9.471%	46dB

The term “modulation error ratio” and the prescribed method of calculation were declared international standard by the DVB Measurement Group. Some test systems, however, specify the “error vector magnitude,” so the conversion rule for the two quantities is given in Table 2–7. The two quantities differ only in the reference used. The modulation error ratio is referenced to the RMS value of the baseband signal; the error vector magnitude is referenced to the peak value.

Table 2–7: Limit values for modulation error

Order	MER EVM [%]	EVM MER [%]	MER EVM [dB]	EVM MER [dB]
4	$EVM = MER$	$MER = EVM$	$EVM = MER$	$MER = EVM$
16	$EVM = MER / 1,342$	$MER = EVM * 1,342$	$EVM = MER - 2,56dB$	$MER = EVM + 2,56dB$
32	$EVM = MER / 1,304$	$MER = EVM * 1,304$	$EVM = MER - 2,31dB$	$MER = EVM + 2,31dB$
64	$EVM = MER / 1,527$	$MER = EVM * 1,527$	$EVM = MER - 3,68dB$	$MER = EVM + 3,68dB$
128	$EVM = MER / 1,440$	$MER = EVM * 1,440$	$EVM = MER - 3,17dB$	$MER = EVM + 3,17dB$
256	$EVM = MER / 1,627$	$MER = EVM * 1,627$	$EVM = MER - 4,23dB$	$MER = EVM + 4,23dB$

■ Other Errors

This subsection describes the effects of errors on the QAM signal that have not been investigated before.

Impulse noise: Impulse noise is caused by switching and ignition processes. The pulses are very short and of widely differing shapes. Since the analysis of the constellation diagram is based on approximately 1,000,000 symbols, the time characteristic of the QAM signal and the information regarding any superimposed noise is lost. Moreover, there is no information as to what symbols were incorrectly demodulated. It is, therefore, not possible to evaluate impulse noise separately from Gaussian noise.

Nonlinearities of amplifiers: Nonlinearities of amplifiers cause amplitude and phase distortion of modulated signals. Since linear QAM modulation is employed mainly in cable systems where signal levels are relatively low, feedback amplifiers can be used. These amplifiers are sufficiently linear so that the effect on the QAM signal is negligibly small.

Intermodulation: For multichannel cable transmission, much greater demands are made on amplifier linearity. Intermodulation between adjacent channels is critical, especially with higher-order QAM modulation. It is second- and third-order nonlinearities that are of practical relevance. For example, intermodulation on a DVB channel C_N with a carrier frequency of ω_N ($\omega_N = \omega_1 - \omega_2$) is obtained for the channel configuration shown in Figure 2–58.

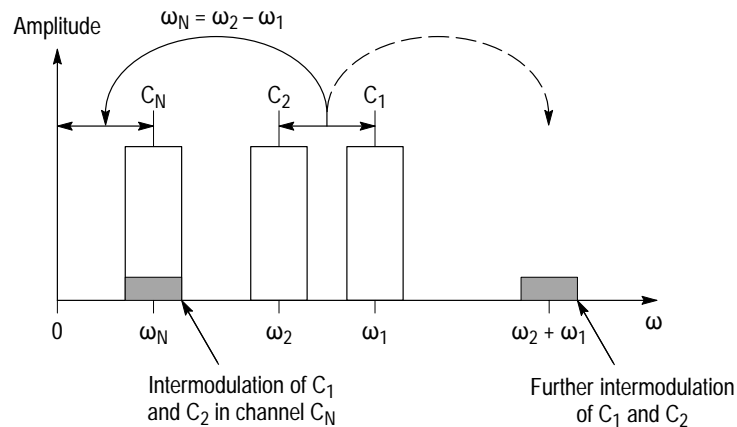

Figure 2–58: Intermodulation due to 2nd-order nonlinearities

3rd-order nonlinearity:

A third-order nonlinearity is caused by the cubic component of the amplifier characteristic. For example, intermodulation on a DVB channel C_N with a carrier frequency ω_N is obtained for the channel configuration ($\omega_N = 2\omega_4 - \omega_3$) shown in Figure 2–59.

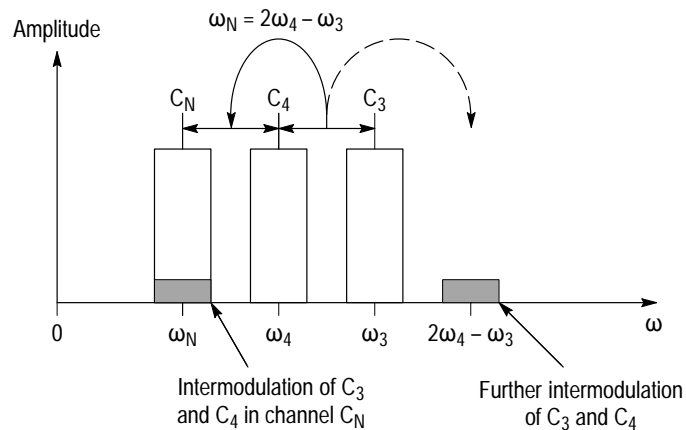

Figure 2-59: Intermodulation due to 3rd-order nonlinearity

Intermodulation between digital channels can be regarded as additive random noise, since it has the effect of additive noise. Therefore, special requirements must be fulfilled with higher-order QAM modulation.

Intermodulation between analog channels tends to be more like an interferor with some additional noise. Intermodulation cannot be analyzed by means of the constellation diagram. For the analysis methods described so far, intermodulation is interpreted as noise, possibly with some interference, and covered by the S/N (and C/I) ratio information.

Frequency and phase errors, echoes. Possible causes:

- Reflections in cables (echoes) caused by mismatched cable terminations and return loss from the equipment connected
- Tolerances of the pulse shaping filters resulting in inter-symbol interference (ISI) because the first Nyquist criterion is not fulfilled
- Amplitude frequency response and group-delay distortion resulting from the lowpass characteristics of cables and amplifiers and from amplitude and phase ripple from channel filters

In contrast to the errors described previously, the three types of errors listed here can be compensated well by the test receiver. This is possible using a self-adapting FIR filter (equalizer) integrated in the instrument. For a compensation of errors by the equalizer, the following main requirements must be fulfilled:

- The noise ripple must not exceed a certain frequency limit.
- The amplitude of the ripple must not be too high.

- Echoes must not exceed -6 dB after 100 ns and -20 dB after 2.5 μ s. Any echoes occurring after 2.5 μ s will not be compensated.

Selection of Integration Time for BER Measurement. For BER measurements, the measurement speed and stability of display can be modified. To illustrate this, the principle of BER measurement is briefly described below.

The DDS200 continuously evaluates the error-correction events of the incoming DVB data stream. This is accomplished using bit-by-bit comparison of the nominal and the actual data streams. All bits of a 204-byte (1632-bit) frame are checked for coincidence. Every deviation is counted. The counter is read after 6127 frames and the count stored in a dynamic memory of 1000 locations. Depending on the BER rate, the test depth must be adjusted. This is done by using only the last value stored for calculating the BER or by carrying out an integration over 10, 100 or 1000 measured values. In BER calculation, the unit automatically switches to a longer integration time if this is expedient. The unit switches back automatically to a shorter integration time if this is desired by the user.

You can define a minimum number of BER samples to be taken in a measurement. If 1000 samples are selected, for example, the test receiver operates exclusively in the 1000-sample mode. This also means that sufficient time must be allowed for a measurement to obtain a useful result. A very stable indication is obtained with this mode, which is suitable especially for stationary applications where the operating conditions for the demodulator remain the same.

If a minimum integration time of 1 sample is selected, the receiver switches the measurement time to 1 sample when a high BER ($>1E-6$) is measured. In calibration, for example, this allows a change of the BER value to be detected immediately; however, the indication is relatively unstable due to the short measurement time. In practice, a minimum integration time of 10 samples has proven expedient for normal applications. Information on the status of integration is useful, especially with a high number of samples. Two figures are therefore specified together with the BER value. The first figure indicates the number of samples actually used for the BER value displayed; the second figure indicates the total number of samples to be achieved (for example, BER = 7.2E-9 (144/1000)).

With a typical DVB symbol rate of 6.9 Msps and 64QAM modulation, the bit rate is 41.4 Mbit/s, corresponding to 25367.6 frames per second. If the bit errors of 6127 frames are represented by one sample, a time of 241.5 ms per sample is obtained. At the maximum integration level (1000 samples), a measurement thus takes 241.5 s. In this case, a resolution of $0.1E-9$ can be achieved for the BER value.

BER Measurement with External Equipment. The DDS200 has an internal BER measurement function which does not require any interruption of the program, since the error control mechanisms of the DVB signal are used for calculating the BER (refer to *Selection of Integration Time for BER Measurement* page on page 2–79). This method has its limitations when very high bit error rates are involved ($>10^{-3}$). For measuring high bit error rates (or for checking the internal BER measurement function), the setup shown in Figure 2–60 can be used.

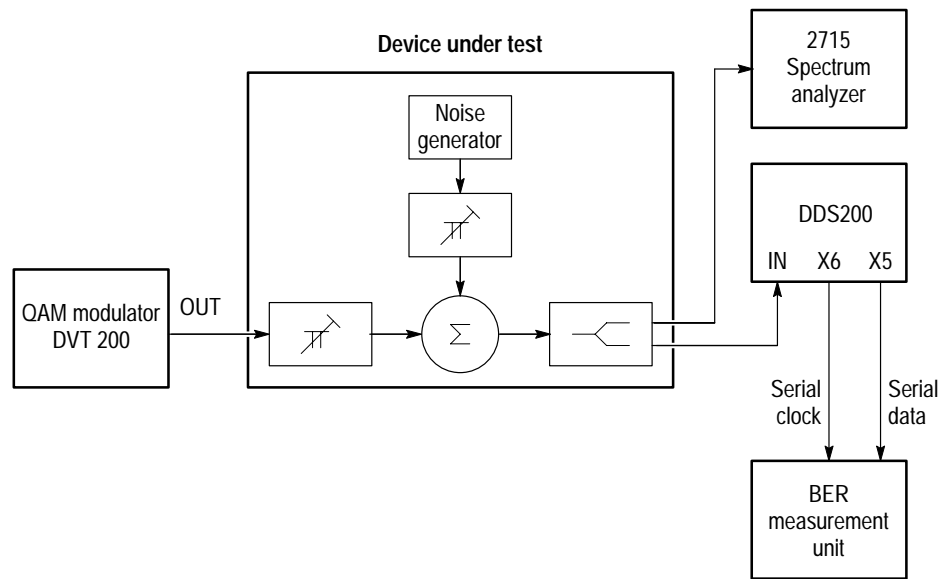

Figure 2–60: Setup for external BER measurement

Equipment settings:

DVT 200 Digital Video Transmitter:	DDS200 Digital Demodulation System:
Modulation with built-in PRBS generator (length of sequence: $2^{23} - 1$ bit)	SPECIAL FUNCTION: BER INTEGRATION: BER EXT
	SPECIAL FUNCTION: MPEG DATA OUTPUT: I/Q-INVERSION: NORMAL or INVERTED (not AUTO).

Description of external BER measurement: The DVT 200 Digital Video Transmitter provides a signal which is modulated by means of an internal PRBS (pseudo random bit sequence) generator. The QAM output signal is taken via an attenuator to a coupler, where a signal of the same frequency from a noise generator is added. The resulting signal can be displayed on a spectrum analyzer (for example, a 2715 Spectrum Analyzer) for determining the C/N value (see below). The signal is then taken to the DDS200 where it is demodulated. Of

course, the noise generator integrated in the DDS200 can be used instead of the external noise generator.

The received signal is synchronized in terms of carrier and symbol clock; the built-in equalizer is adapted automatically. The serial data are taken from connectors SERIAL CLOCK and SERIAL DATA (valid with rising clock edge) on the rear of the DDS200.

The data is taken immediately after the demapping block (before the Reed Solomon decoder, the deinterleaver, and the energy dispersal section). At this point the data have not undergone any error protection measures and are available in their original form. The external BER measurement unit recognizes the data sequence and synchronizes to it. The BER is determined by bit-by-bit nominal/actual-value comparison.

NOTE. *In normal DVB operation, the DDS200 Digital Demodulation System automatically detects inversion of the received signal from the incorrect frame sync word and compensates the error by interchanging the I and Q data. This condition is indicated by a warning on the display (I/Q INTERCHANGED). In the above example, there are no sync words and the unit cannot detect an inverted spectrum. It must therefore be ensured that the transmitting spectrum is set correctly in the DDS200 (otherwise the BER measurement unit cannot synchronize to the data sequence). This setting is made in the menu SPECIAL FUNCTION: MPEG DATA OUTPUT: I/Q-INVERSION. An inverted spectrum is always obtained with an odd number of down conversions with the frequency of the oscillator being higher than that of the carrier.*

Instead of the noise generator and attenuator shown in the above diagram, any DVB transmission line can be connected. The effect of very long lines (attenuation) or reflections, for example, can be examined in this way.

The DVB signal can be deteriorated by adding noise, thus increasing the BER. The increased BER can well be discerned from the constellation diagram. The decisive criterion for the BER is the C/N ratio of a signal. If the internal noise generator is not used, the C/N ratio can be measured with a spectrum analyzer. For this, the following steps are to be carried out:

- Select a high resolution bandwidth (for example, 300 kHz) and a low video bandwidth on the spectrum analyzer so that signals are represented as lines and not as noise bars.
- Switch the noise generator off and measure the signal of the DVT 200 Digital Video transmitter on the spectrum analyzer. For this, set marker to the same frequency as the QAM carrier and select the NOISE marker mode. The signal power density C' is given in dBm/Hz by the analyzer; the filter bandwidth and the characteristics of the logarithmic amplifier of the analyzer

are taken into account automatically. To refer C' to the Nyquist bandwidth B_N of the DVB signal, the signal power C is to be calculated as follows:

$$C = C' + 10 \lg B_N = C' + 10 \lg(\text{symbol rate/Hz}) \cdot \text{dB [dBm]}$$

- Switch the signal of the DVT 200 Digital Video Transmitter off, switch the noise generator on, and measure the noise power density on the spectrum analyzer. For this, set a marker again to the same frequency as the QAM carrier and select the NOISE marker mode. The noise power density N' is indicated by the analyzer. To refer N' to the channel bandwidth B_C of the DVB channel used, the noise power N is to be calculated as follows:

$$N = N' + 10 \lg B_C = N' + 10 \lg(\text{channel bandwidth/Hz}) \cdot \text{dB [dBm]}$$

From this the C/N ratio is obtained as follows:

$$C / N[\text{dB}] = C_{[\text{dBm}]} - N_{[\text{dBm}]}$$

The noise level and thus the BER can be changed by modifying the attenuator. The relationship between the BER and the signal-to-noise ratio C/N will be examined in the next section.

BER as a Function of C/N, Calculation of Further Parameters. If a QAM signal is disturbed by additive Gaussian noise, error-free demodulation is not possible. The error frequency is indicated by the bit error rate. Figure 2–61 shows the theoretical relationship between the C/N ratio and the bit error rate. Any additional errors that may occur cause a shifting of the displayed curves corresponding to the magnitude of the error and thus an increase of the bit error rate.

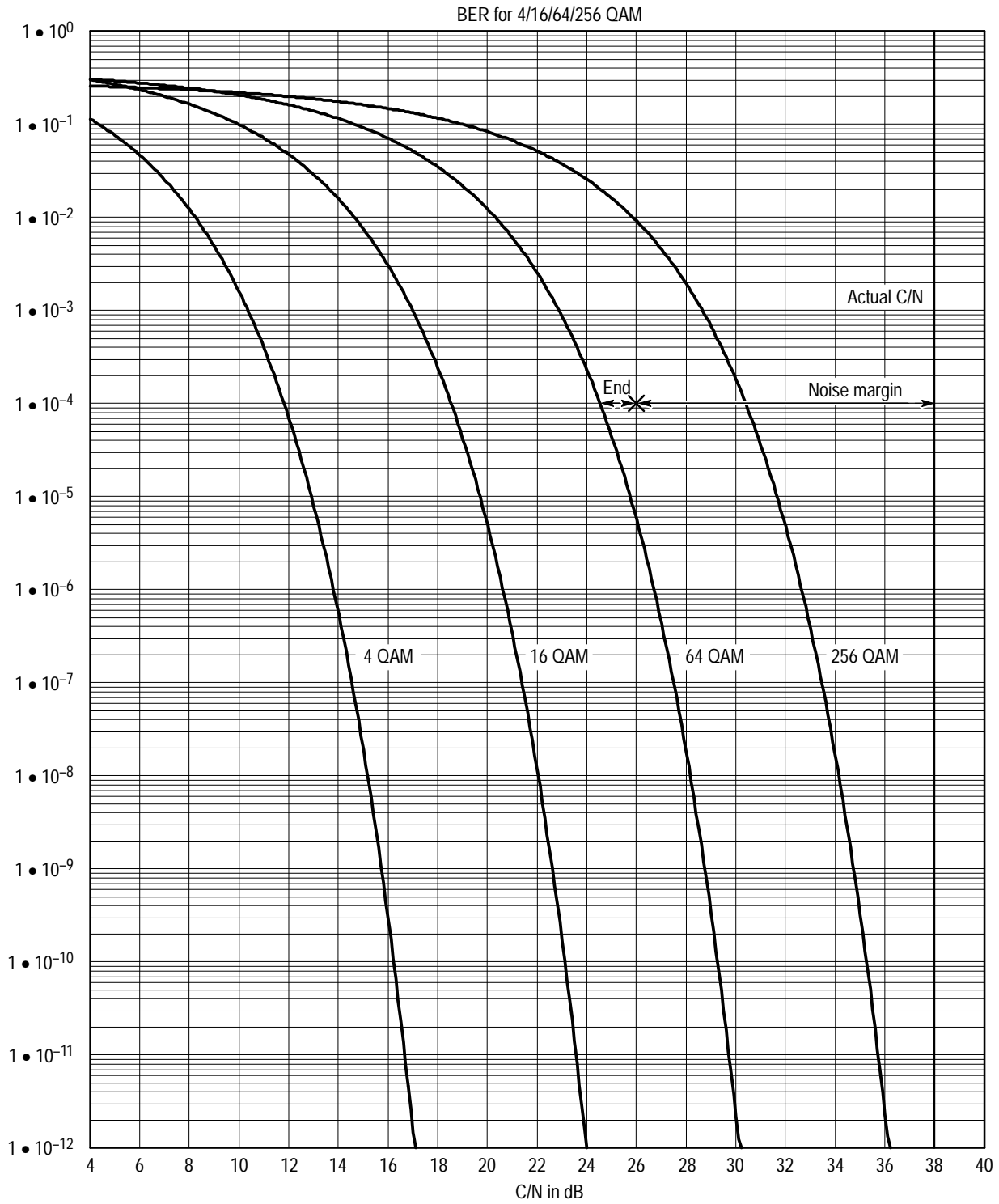

Figure 2-61: BER as a function of C/N ratio

It should be noted that the C/N ratio shown in Figure 2–61 was measured after the receive filter (1st Nyquist condition fulfilled). Therefore, when comparing the curves with curves obtained for a channel, a correction of the C/N values has to be made. The C/N value of a channel increases at the output of the receiver filter, since the white noise is decreased to a greater extent than the useful signal, which is filtered in the transmitter. Moreover, both the C/N ratio determined by the method (described page 2–80) and the C/N ratio of the internal noise generator are referred to the bandwidth of the receive channel (for example, 8 MHz if the 8-MHz filter is selected).

For an exact value, the C/N ratio must be corrected in accordance with Figure 2–62. However, the method described is appropriate for practical purposes where the C/N value is to be determined for a real channel, and the test point after the receiver Nyquist filter is not accessible.

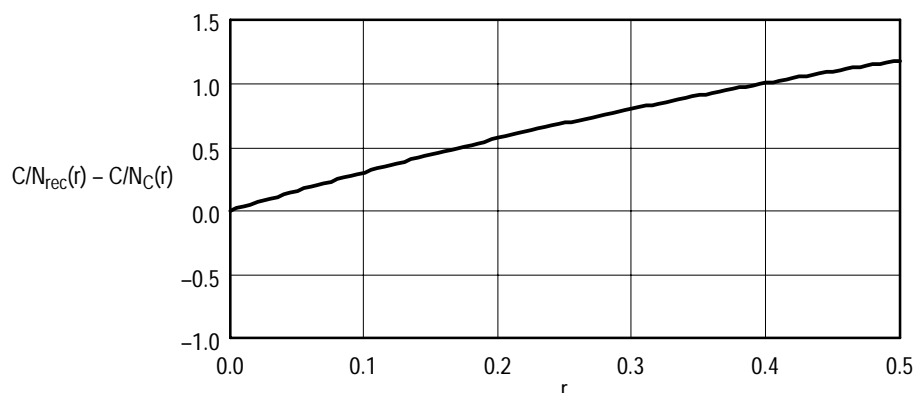

Figure 2–62: Effect of receive filter on C/N value

C/N_{rec}: C/N after receive filter.

C/N_C: C/N ahead of receive filter (in channel)

Example:

With the roll-off factor of 0.15 used for DVB signals and a symbol rate of 6.95 Msps, the 8-MHz receive channel is utilized fully. A C/N value of 24.0 dB is set with the internal noise generator of the DDS200. This value is increased by 0.441 dB after the receive filter (see Figure 2–62). The theoretical BER for the described receiving conditions can be seen from Figure 2–61; for C/N = 24.4 dB, a BER of approx. 1.1E-4 is obtained. For the described relationship between the noise generator and the BER, all BER values are shifted to the left by 0.441 dB.

If the BER has been determined for a given C/N value, this rate can be used for indicating various parameters defined by the DVB Measurement Group. This definition of parameters allows direct comparisons to be made between different test systems and is of international relevance. The two most important parameters are briefly explained below for a C/N ratio with a BER of $1E-4$ and with the two corrections of the C/N value described above already made.

- Equivalent noise degradation (END):

The equivalent noise degradation is a measure of the transmission loss of the complete system from the modulator via the cable link to the demodulator. The equivalent noise degradation indicates the deviation of the real from the ideal C/N ratio in dB for a BER of 10^{-4} . In practice, values of approx. 1 dB are obtained.

- Noise margin:

The noise margin is understood to be the difference between the C/N resulting in a BER of 10^{-4} and the C/N value of the cable system (actual C/N). For measuring the C/N of the cable system, the symbol rate of the QAM signal is taken as the noise bandwidth. The following values are obtained for the example shown in Figure 2–61 for 64QAM:

Equivalent noise degradation: 1.6 dB

Noise margin: 12.0 dB

Assignment and Functions of Parallel and Serial MPEG-2 Outputs. The DDS200 has three different interfaces for the output of transmitted data:

- Parallel MPEG-2 interface
- Serial MPEG-2 interface
- Serial interface.

The serial interface is described on page 2–80 and is not suitable for the output of transmitted MPEG-2 data. In this section, the other two interfaces are described. They were internationally standardized by the “DVB-TM Ad Hoc Group Physical Interfaces”. For both interfaces you can select if the 16 error protection bytes are to be transmitted in addition to the 188 data bytes of the MPEG-2 frame (yielding a total of 204 bytes). The selection is made in the STATUS: SER/PAR MPEG FRAME SIZE menu.

The parallel MPEG-2 interface (X31) operates according to the LVDS (low voltage differential signaling) standard, which provides symmetrical data.

The key characteristics are:

- Source impedance: 100 Ω
- DC component: +1.25 V
- Signal amplitude: 247 to 454 mV
- Maximum length of transmission link: approximately 5 meters

The parallel interface has the following assignment (front view):

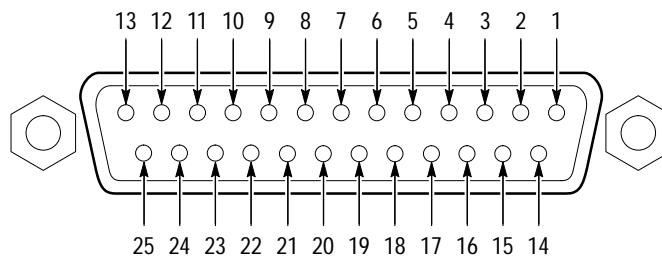

Figure 2-63: Assignment of parallel MPEG data interface (X31)

Table 2-8: Assignment of parallel MPEG data interface

Signal	Noninverting output (pin number)	Inverting output (pin number)
Clock	1	14
GND	2	15
DATA 7	3	16
DATA 6	4	17
DATA 5	5	18
DATA 4	6	19
DATA 3	7	20
DATA 2	8	21
DATA 1	9	22
DATA 0	10	23
DATA VALID	11	24
PSYNC	12	25
GND	13	-

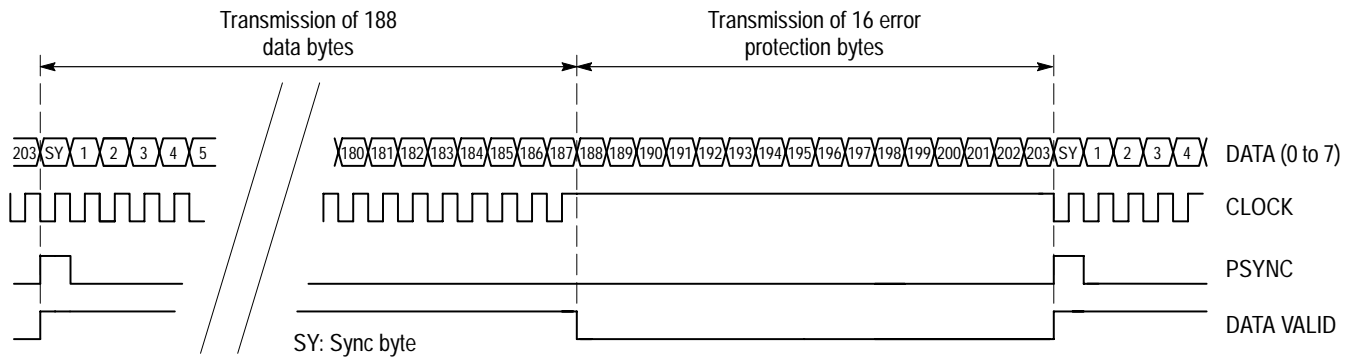

Figure 2–64: Signals at parallel interface in 188-byte mode (STATUS: SER/PAR MPEG FRAME SIZE)

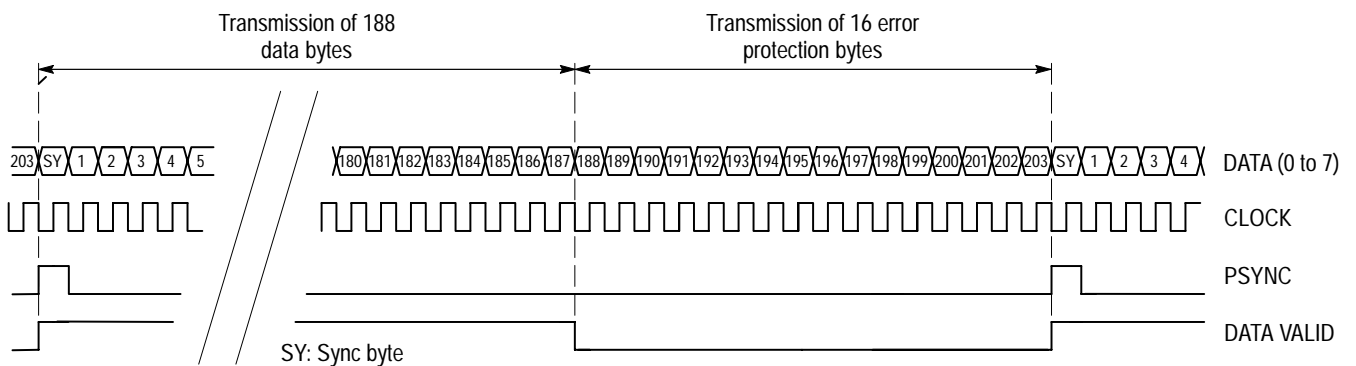

Figure 2–65: Signals at parallel interface in 204-byte mode (STATUS: SER/PAR MPEG FRAME SIZE)

The serial MPEG-2 interface (X7) uses asynchronous data transmission (asynchronous serial interface, ASI). Asynchronous means that the data transmission rate is fixed, irrespective of the data rate of the transmitted MPEG-2 signal. To this end, padding bits are inserted where no valid information is present. With the serial MPEG-2 interface, very long transmission links (several hundred meters) can be realized. The switch SER/PAR MPEG FRAME SIZE: 188/204 bytes has the same function for the parallel and the serial interface: in the 204-byte mode, the error protection bits are transmitted, in the 188-bytes mode, padding bits are transmitted instead of the error protection bits.

The key characteristics are:

- Transmission rate (fixed): 270 Mbit/s
- Source impedance: 75 Ω , unbalanced (BNC)
- DC component: 0 V
- Signal amplitude: 0.08 V to 0.8 V into 75 Ω
- Length of transmission link: Depends on cable type; cable attenuation must not exceed 12 dB at 70 MHz

Simultaneous display of constellation and MPEG output. Two DDS200s can be coupled via an IF connection to allow the simultaneous generation of a constellation diagram and MPEG-2 output. For this, the following setup can be used:

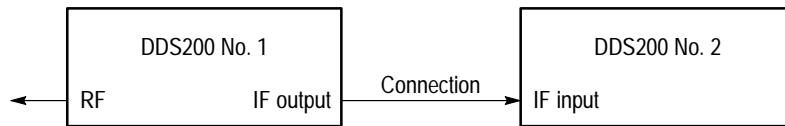

Figure 2–66: Cascading of two DDS200s

The two units can be connected as shown in Table 2–9.

Table 2–9: Cascading of two DDS200s

DDS200 (No. 1) Application	Connection	DDS200 (No. 2) Application
MPEG data or constellation diagram	X11 (IF output) X10 (IF input)	MPEG data or constellation diagram
MPEG data	X7 (SER MPEG DATA OUT)	MPEG data

Remote Control

NOTE. Appendix D: List of Commands contains a complete list of commands for the DDS200 Digital Demodulation System.

The standard DDS200 Digital Demodulation System has an IEC/IEEE-bus interface that complies with the IEC 625.1/IEEE 488.2 standard. The connector is located on the rear panel. A controller can be connected for remote control. The DDS200 supports the Standard Commands for Programmable Instruments (SCPI) version 1993.0. The SCPI standard is based on the IEEE 488.2 standard and its goal is a standardization of the device-specific commands, error handling, and status registers (refer to *Structure and Syntax of Device-Dependent Messages* on page 3–5).

Basic knowledge of IEC/IEEE-bus programming and operation of the controller is required for a clear understanding of this chapter. A description of the interface commands can be found in the relevant manuals.

The effects of the SCPI requirements on the command syntax, error handling, and configuration of the status registers are described in detail in the relevant subsections. Tables provide a quick overview of the commands implemented in the instrument and the assignment of the bits in the status registers. The tables are supplemented by a detailed description of commands and status registers. Detailed program examples for all essential functions are given in *Appendix E: Program Examples*. All program examples are written in QuickBASIC.

Brief Instructions

The following brief operating instructions allow the instrument to be quickly put into operation and to set the basic functions. It is assumed that the IEC/IEEE-bus address, which is set at the factory to 6, has not been changed.

1. Connect the DDS200 and controller using the IEC/IEEE-bus cable.
2. Generate and start the following program on the controller:

```
'$INCLUDE: 'c:\qbasic\qbdecl.bas'           'Insert driver
CALL IBFIND("DEV1", efa%)                  'Open channel to device
CALL IBPAD(efa%, 6)                        'Send device address
                                           'to controller
CALL IBTMO(efa%, 12)                       'Response time to 3 sec
CALL IBWRT(efa%, "*RST")                   'Reset device
CALL IBWRT(efa%, "*CLS")                   'Reset SCPI register
CALL IBWRT(efa%, "SENSE:FREQ:CHAN 56")     'Set RF receive
                                           'frequency to channel 56
CALL IBWRT(efa%, "INP:ATT:AUTO ON")        'Set RF level control to
```



```

'automatic mode
CALL IBWRT(efa%, "AUD:SPE OFF")      'Switch off loudspeaker
Attenuation$ = SPACE$(10)           'Provide text variable
                                     '(10 characters)
CALL IBWRT(efa%, "INP:ATT?")        'Query position of
                                     'attenuator
CALL IBRD(efa%, Attenuation$)       'Read in value
CALL IBWRT(efa%, "UNIT:LEV:POW DBM") 'Level unit dBm
PEge1$ = SPACE$(10)                 'Provide text variable
                                     '(10 characters)
CALL IBWRT(efa%, "READ:RF:LEV?")    'Query input level
CALL IBRD(efa%, PEge1$)             'Read in value
PRINT "Pege1 (dBm): ";PEge1$        'Output values on
PRINT "Attenuation: ";Attenuation$  'controller screen

```

3. Press any key on the front panel to return to manual control. Then press the [LOCAL] softkey.

Switching to Remote Control

On power up, the DDS200 is always in the manual control mode (LOCAL state) and can be operated from the front panel. Switch over to remote control (REMOTE state) happens as soon as the DDS200 receives an addressed command from a controller. In the remote-control mode, operation from the front panel is inhibited. The DDS200 remains in the REMOTE state until it is switched back to the manual control mode, either from the front panel or via the IEC/IEEE bus (see *Return to Manual Control* page 3–3). Switch over from the manual mode to remote control and vice versa has no effect on the instrument settings.

Setting the Device Address

The factory-set IEC/IEEE-bus address is 6. The address can be changed manually in the SETUP \ REMOTE \ IEC625-IEEE488 menu (refer to *SETUP Menu* on page 2–19). Addresses between 0 and 30 can be selected.

Manually:

1. Select the SETUP \ REMOTE \ IEC625-IEEE488 menu.
2. Enter the desired address.
3. Terminate the address entry with [1x ENTER] key.

Displays in Remote Control

The remote-control status is indicated by the REM and LLO LEDs on the STATE signal field. In this status, all readouts appear on the screen.

Return to Manual Control

Return to manual control can be made via the front panel or via the IEC/IEEE bus.

Manually:

1. Press any key on the front panel. Then actuate the [LOCAL] softkey.

NOTE. Prior to the switch over, the commands must have been fully processed, since remote control is immediately switched on again.

The return to LOCAL key can be locked by the universal command LLO (see Appendix A) in order to prevent inadvertent switch over. It is then only possible to switch to manual control via the IEC/IEEE bus.

Locking of the [LOCAL] key can be cancelled by deactivating the “REN” line of the IEC/IEEE bus (refer to Appendix A: IEC/IEEE-Bus Interface).

Via IEC/IEEE bus:

CALL IBLOC(efa%) Set instrument to manual control

IEC/IEEE-Bus Messages

The messages transmitted on the data lines of the IEC/IEEE bus (refer to *Appendix A: IEC/IEEE-Bus Interface*) can be subdivided into two groups:

- Interface messages
- Device-dependent messages

Interface Messages

Interface messages are transmitted on the data lines of the IEC/IEEE bus, with the control line “ATN” active. They are used for communication between the controller and the instrument and can only be sent by a controller with controller function on the IEC/IEEE bus.

There are two groups of interface messages:

- Common commands
- Addressed commands

Common commands affect all devices connected to the IEC/IEEE bus without any addressing being required, whereas addressed commands only affect devices addressed as a listener. The relevant interface messages are listed in *Appendix A: IEC/IEEE-Bus Interface*.

Device-Dependent Messages (Commands and Responses)

The device-dependent messages are transmitted on the data lines of the IEC/IEEE bus with the control line “ATN” not active. The ASCII code is used for data transmission. Device-dependent messages are differentiated according to the direction in which they are sent via the IEC/IEEE bus.

Commands. Commands are messages sent by the controller to the device. They control the device functions and request information. The commands are differentiated according to two criteria:

1. According to the effect they have on the device:

Setting commands trigger device settings (for example, resetting the instrument or setting the receive frequency).

Queries cause data to be provided for output via the IEC/IEEE bus (for example, for device identification or query of the receive frequency).

2. According to their definition in the IEEE 488.2 standard:

Common commands are precisely defined in their function and notation in the IEEE 488.2 standard. They refer to functions such as the management of the standardized status registers, resetting, and selftest.

Device-specific refers to functions that depend on the device commands characteristics, such as frequency setting. A large number of these commands has also been standardized by the SCPI Consortium.

Responses. Responses are messages sent by the device to the controller following a query. They may contain results, device settings, or information about the device status (refer to *Responses to Queries* on page 3–9).

Structure and syntax of the device-dependent messages are described on page 3–5. The commands are listed and explained in *Description of Commands* on page 3–11.

Structure and Syntax of Device-Dependent Messages

SCPI Introduction

Standard Commands for Programmable Instruments (SCPI) describes a standardized command set for the programming of instruments, regardless of the type of instrument or manufacturer. The goal of the SCPI Consortium is to standardize device-specific commands as much as possible. For this purpose, an instrument model has been developed which defines identical functions within an instrument or of different instruments. Command systems have been generated and assigned to these functions so that it is possible to address identical functions by the same commands. The command systems have a hierarchical structure. Figure 3–1 shows this tree structure, using a detail from the SOURce command system for controlling the signal sources of the instrument. The other examples of syntax and structure of the commands are mainly taken from this command system.

SCPI uses the same syntax elements as well as the common commands defined in the IEEE 488.2 standard. The syntax of the responses is partly subjected to stricter rules than laid down in the IEEE 488.2 standard (refer to *Responses to Queries* on page 3–9).

Command Structure

The commands consist of a header and usually one or more parameters. Header and parameters are separated by a white space (ASCII code 0 to 9, 11 to 32 decimal). The headers may be composed of several keywords. The query form is generated by appending a question mark directly to the header.

NOTE. *The commands used in the examples below are not necessarily implemented in the instrument.*

Common commands. Common commands consist of a header to which an asterisk “*” is prefixed and one or more parameters.

Examples:

```
*RST
RESET (resets the device)

*ESE 253
EVENT STATUS ENABLE (sets the bits of the Event Status Enable
Register)

*ESR?
EVENT STATUS QUERY (queries the contents of the Event Status
Register)
```

Device-specific commands.

- **Hierarchy:**
 Device-specific commands have a hierarchical structure (see Figure 3–1). The various levels are represented by compound headers. Headers of the highest level (root level) have one keyword only. This keyword stands for a whole command system.

Example:

```
SENSe
This keyword denotes the command system SENSe.
```

For lower-level commands the full path must be specified, starting with the highest level in the left-most position. The individual keywords are separated by a colon (:).

Example:

```
SENSe:FREQuency:CENTer 100.0 MHz
```

This command is at the third level of the SENSe system. It sets the receive frequency to 100.0 MHz.

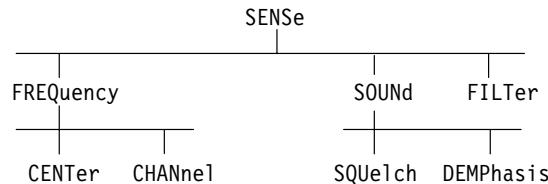

Figure 3–1: Tree structure of SCPI command system using SENSe as an example

- **Optional keywords:**

In some command systems it is possible to insert or to omit certain keywords. These keywords are shown in the instrument manual in square brackets. For compatibility with the SCPI standard, the instrument must be able to recognize the full command length. Some of the commands become considerably shorter when the optional keywords are omitted.

Example:

```
READ[:POWer] [:RATio]:VISion:SOUNd1
```

This command queries the vision/sound1/power ratio measured by the DDS200. The following command has the same effect:

```
READ:VISion:SOUNd1
```

NOTE. An optional keyword may not be omitted if its effect is specified in more detail by a numeric suffix.

- **Long and short form:**

The keywords have a long and a short form. The keyword may be entered in short or in long form; other abbreviations are not allowed.

Example:

```
READ:VISion:SOUNd1 = READ:VIS:SOUN1
```

NOTE. The short form uses uppercase characters; the long form gives the whole keyword. Uppercase and lowercase letters are only used for identification in the instrument manual; the instrument does not differentiate between the two types of characters.

- **Parameter:**

The parameter must be separated from the header by a white space. If a command contains several parameters, these must be separated by a comma (.). Some of the queries allow the specification of the parameter Default. For a description of the various types of parameter, refer to *Parameters* on page 3–9.

Example:

```
READ:FM:DEVIation? Sound1
```

Response:

```
50.000 kHz
```

This query returns the FM frequency deviation for the left channel (sound 1).

- **Numeric suffix:**

If an instrument has several identical functions or features (for example, inputs), the desired function can be selected by a suffix to the command. Commands given without suffix are interpreted as having suffix 1. The suffix is appended without a space.

Example:

```
SENSe:SOUNd:SQUElch1 ON
```

This command switches on the squelch for sound 1.

Structure of a Command Line

A command line may contain one or more commands. It is terminated by a <New Line>, a <New Line> with EOI, or an EOI together with the last data byte. QuickBASIC automatically generates an EOI together with the last data byte.

Multiple commands in a command line are separated by a semicolon (;). If the next command belongs to a different command system, the semicolon is followed by a colon.

Example:

```
CALL IBWRT(efa%, "ROUte:ISElect IF;:AUDio:SPEaker ON")
```

This command line contains two commands. The first command belongs to the ROUte system. The second command belongs to the AUDio system and turns on the loudspeaker.

If the successive commands belong to the same system and have one or more common levels, the command line may be shortened. The second command following the semicolon then starts at the level that is below the common levels (see also Figure 3–1). The colon after the semicolon must be omitted.

Example:

```
CALL IBWRT(efa%, "AUDio:MODE AUTO;:AUDio:SOURce NICAM")
```

This command line is shown in full length and contains two commands separated by a colon. Both commands belong to AUDio command system (that is, they have two common levels).

In the shortened command line, the second command starts at the level below AUDio. The colon after the semicolon must be omitted.

The shortened form of the command line is:

```
CALL IBWRT(efa%, "AUDio:MODE AUTO;SOURce NICAM")
```

However, a new command line always starts with the full path.

Example:

```
CALL IBWRT(efa%, "AUDio:MODE AUTO")
CALL IBWRT(efa%, "AUDio:SOURce NICAM")
```

Responses to Queries

Unless otherwise expressly specified, a query is defined for each setting command. The query is generated by appending a question mark to the associated setting command. The SCPI rules imposed on the query responses are somewhat stricter than those of the IEEE 488.2 standard.

1. The required parameter is sent without header.

```
Example:  AUDio:MODE?
Response:  AUTO
```

2. Numeric values are output without unit. Physical quantities refer to the basic units or to the units set with the Unit command.

```
Example:  SENSE:REQuency:CENTer?
Response:  118.0 for 118 MHz
```

3. Boolean values are returned as 0 (OFF) and 1 (ON).

4. Character data are returned in short form (refer to *Structure of a Command Line* on page 3–8).

```
Example:  ROUTe:ISElect?
Response:  RF
```

Parameters

Most commands require the specification of a parameter. The parameters must be separated from the header by a white space. Parameters may be specified as numeric values, Boolean parameters, character data, character strings, and block data. The type of parameter required for the specific command as well as the permitted range of values are described together with the commands (refer to *Description of Commands* on page 3–11).

Numeric values. Numeric values may be entered in any customary form (using sign, decimal point, and exponent). If the values exceed the resolution of the instrument, they will be rounded off. The mantissa may comprise up to 255 characters; the exponent must be in the range between –32 000 and 32 000. The exponent is denoted by an “E” or “e”. The exponent alone must not be used. Physical quantities may be stated with the unit. Permissible prefixes for the unit are G (Giga), MA (Mega, MOHM and MHZ are also allowed), K (Kilo), M (Milli), U (Micro) and N (Nano). If no unit is specified, the basic unit will be used.

Example:

```
SENSe:FREQuency:CENTer 118MHz = SENSe:FREQuency:CENTer 118
```

Special numeric values. The parameters DEFault, UP and DOWN are interpreted as special numeric values.

- DEF
DEFault denotes a preset value stored in the EPROM. This value coincides with the basic setting called up by the *RST command.
- UP/DOWN
UP or DOWN increments or decrements the numeric value by one step.
- INF/NINF
INFinity, Negative INFinity (NINF) represent the numeric values $-9.9E37$ or $9.9E37$. INF and NINF are sent as device responses only.
- NAN
Not A Number (NAN) represents the value $9.91E37$. NAN is emitted as device response only. This value is not defined. Possible causes are the division of zero by zero, the subtraction of infinity with infinity and the representation of missing values.

Boolean parameters. Boolean parameters represent two states. The ON state (true condition) is represented by ON or a nonzero numeric value. The OFF state (false condition) is represented by OFF or the value of 0. Queries always return 0 or 1.

Example:

```
Setting command:    AUDio:SPEaker ON
Query:              AUDio:SPEaker?
Response:           1
```

Character data. Character data follow the syntax rules for keywords and have a short and a long form. Similar to other parameter, they must be separated from the header by a white space. A query returns the short form of the character data.

```
Setting command:    AUDio:SOURce MPEG
Query:              AUDio:SOURce?
Response:           MPEG
```

Block data. Block data is a format suitable for the transmission of large data volumes. A command with a block data parameter has the structure shown in the following example.

Example:

```
HEADer:HEADer #45168xxxxxxxx
```

The ASCII character # denotes the beginning of the data block. The next number specifies the number of subsequent digits defining the length of the data block. In the example above, the four digits specify a length of 5168 bytes. The data bytes follow next. During the transmission of these data bytes all terminators and other control characters are ignored until all bytes have been transmitted. In case of data elements comprising more than one byte, the byte defined by the SCPI command "FORMat:BORDER" will be transmitted first.

Overview of Syntax Elements

The following list provides an overview of the syntax elements.

- ‘ : ’ The colon separates the keywords of a command. In a command line, the colon following a semicolon identifies the highest command level.
- ‘ ; ’ The semicolon separates two commands in a command line. It does not change the path.
- ‘ , ’ The comma separates several parameters of a command.
- ‘ ? ’ The question mark forms a query.
- ‘ * ’ The asterisk identifies a common command.
- ‘ ” ’ Quotation marks denote the beginning of a character string and terminate it.
- ‘ # ’ The double cross(pound symbol) denotes the beginning of block data.
- ‘ ’ A white space (ASCII code 0 to 9, 11 to 32 decimal) separates header and parameters. An example of a white space is the space character.

Description of Commands

Notation In *Appendix D: List of Commands*, all commands implemented in the DDS200 are tabulated according to the command system and described in detail. The notation largely conforms to the SCPI standard.

Command table.

- Command:
In the command column the table shows an overview of the commands and their hierarchical relationships (see indentations).

- **Parameter:**
In the parameter column the required parameters and their range of values are stated.
- **Unit:**
The unit column shows the basic unit of the physical parameters.

Indentations. The various levels of the SCPI command hierarchy are shown in the table by indentations to the right. The lower the level, the greater the indentation to the right. It should be noted that the complete notation of the command includes the higher levels too.

In the individual command description, the hierarchy is represented accordingly. This means that for each command all keywords above up to the left-most position have to be considered too.

Upper/lower case. Uppercase/lowercase characters are used to differentiate between the long form and the short form of the keywords of a command in the command description (refer to *Command Structure* on page 3–5). The instrument does not differentiate between uppercase and lowercase characters.

Special characters.

- | A vertical bar in the notation of the parameters is used to separate alternative options and is to be understood as an “or”. The effect of the command differs according to the parameter stated.
- [] Keywords in square brackets may be omitted in compound headers (refer to *Optional keywords* on page 3–7). For compatibility with the SCPI standard, the instrument must be able to recognize the full length of the command.
Parameters in square brackets may also be optionally inserted into the command or omitted.

Common Commands

The common commands are based on the IEEE 488.2 (IEC 625.2) standard. A specific command has the same effect in different instruments. The headers of these commands consist of an asterisk (*) followed by three letters. Many common commands refer to the status reporting system described in detail on page 3–19.

Command	Parameter	Unit	Notes
*CLS	--		Clear Status Data Structures
*ESE	0..255		Set Event Status Reg.
*ESE?			Event Status Enable Query
*ESR?	--		Standard Event Status Query
*IDN?	--		Identification Query
*IST?	--		Individual Status Query
*OPC	--		Operation Complete Command
*OPC?	--		Operation Complete Query
*PRE	0..65535		Set Parallel Poll Enable Register
*PRE?	--		Parallel Poll Enable Query
*PSC	-32767..32767		Set Power On Status Clear: == 0 OFF <> 0 ON
*PSC?	--		Power On Status Clear Query
*RCL	0..9		Recall Store 0..9
*RST	--		Reset Instrument
*SAV	0..9		Save Current State To Store 0..9
*SRE	0..255		Set / Read Service Request
*SRE?	--		Enable Register
*STB?	--		Status Byte Query
*TST?			Self-Test Query
*WAI			Wait For End Of Action

*CLS	CLEAR STATUS sets the status byte (STB), the Standard Event Register (ESR), and the EVENT part of the QUESTIONABLE and of the OPERATION Register to zero. The command has no effect on the mask and transition parts of the register. The output buffer is cleared.
*ESE 0 to 255	EVENT STATUS ENABLE sets the Event Status Enable Register to the defined value. The query *ESE? returns the contents of the Event Status Enable Register in decimal form.
*ESR?	STANDARD EVENT STATUS QUERY returns the contents of the Event Status Register in decimal form (0 to 255), and then clears the register.
*IDN?	IDENTIFICATION QUERY for identification of the instrument. The response is for example: "Rohde&Schwarz, EFA,0,2.00" 0 = the serial number (not coded in the DDS200) 2.00 = the firmware version
*IST?	INDIVIDUAL STATUS QUERY returns the contents of the IST flag in decimal form (0 1). The IST flag is the status bit sent during a Parallel Poll (refer to <i>IST Flag and Parallel Poll Enable Register (PPE)</i> on page 3–24).
*OPC	OPERATION COMPLETE sets bit 0 in the Event Status Register if all preceding commands have been executed. This bit may be used to assert a Service Request.
*OPC?	OPERATION COMPLETE QUERY places an ASCII character 1 into the output buffer as soon as all preceding commands have been executed.
*PRE 0 to 255	PARALLEL POLL REGISTER ENABLE sets the Parallel Poll Enable Register to the defined value. The query *PRE? returns the contents of the Parallel Poll Enable Register in decimal form.
*PSC 0 1	POWER ON STATUS CLEAR determines whether on power on the contents of the ENABLE Register is retained or cleared.

*PSC = 0 Causes the status register to retain its contents. With a corresponding configuration of the status registers ESE and SRE, a Service Request may be asserted at power on.

*PSC $\bar{1}$ 0 Clears the register.

The query *PSC? reads out the contents of the power-on-status-clear flags. The response may be 0 or 1.

- *RCL 0 to 9 RECALL calls the device state which has been stored with the command *SAV under the number indicated. *SAV enables 10 device states (0 to 9) to be stored.
- *RST RESET sets the device to a defined default state. This command mainly corresponds to a stroke on the [PRESET] key. The default state is indicated in the description of the command (refer to *Presetting the Unit* on page 2–16).
- *SAV 0 to 9 SAVE stores the current device state under the number indicated (see also *RCL).
- *SRE 0 to 255 SERVICE REQUEST ENABLE sets the Service Request Enable Register to the defined value. Bit 6 (MSS mask bit) remains 0. This command determines the conditions under which a Service Request will be asserted. The query *SRE? outputs the contents of the Service Request Enable Register in decimal form. Bit 6 is always 0.
- *STB? READ STATUS BYTE QUERY outputs the contents of the status byte in decimal form.
- *TST? SELF TEST QUERY causes all selftests of the device and outputs an error code in hexadecimal form.
- *WAI WAIT-to-CONTINUE allows processing of commands only after all preceding commands have been executed and all signals are settled (see also *OPC).

Instrument Model and Command Processing

The instrument model shown in Figure 3–2 is configured under the aspect of processing IEC/IEEE-bus commands. The individual components operate independently of each other and simultaneously. They communicate with each other by means of messages.

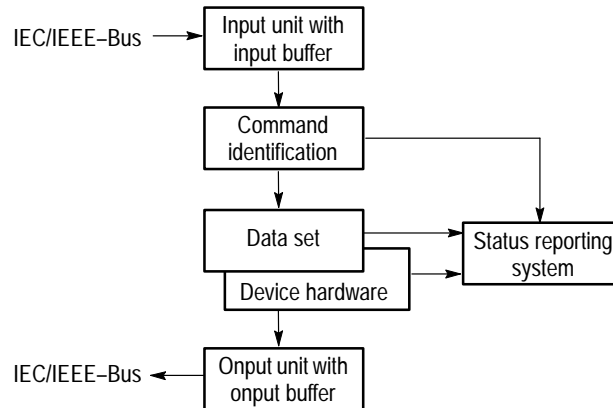

Figure 3–2: Instrument model with remote control via IEC/IEEE bus

Input Unit

The input unit receives the commands in the form of characters from the IEC/IEEE bus and collects them in the input buffer. The input buffer has a capacity of 1024 characters. The input unit sends a message to the command identification as soon as the input buffer is full or as soon as it receives a terminator <PROGRAM MESSAGE TERMINATOR> as defined by IEEE 488.2 or the interface message DCL.

If the input buffer is full, the data transfer from the IEC/IEEE bus is stopped and the data received so far are processed. Data transfer from the IEC/IEEE bus is then continued. If the buffer is not yet full when a terminator is received, the input unit can receive the next command while the previous command is identified and executed. Reception of a DCL command clears the input buffer and immediately causes a message to be sent to the command identification.

Command Identification

The command identification analyzes the data received from the input unit, proceeding in the order in which the data are received. Only a DCL command will be given priority, whereas a GET (Group Execute Trigger) command will be processed when the previous commands have been executed. Each identified command will immediately be transferred to the data set, however, without being immediately executed there.

Syntax errors in the command are recognized and passed on to the status reporting system. The remaining part of a command line after a syntax error will be further analyzed as far as possible and processed.

If a terminator or a DCL is identified, the command identification requests the data set to execute the setting commands in the device hardware. The command identification is then immediately ready to process a new command. This means that additional commands can be processed while settings are being made in the hardware (overlapping execution).

Data Set and Device Hardware

The term “device hardware” refers to the part of the instrument that performs the instrument function proper, such as signal generation and measurements. This does not include the controller.

The data set exactly represents the hardware functions in the software. IEC/IEEE-bus setting commands cause a modification in the data set. The data set management enters the new values (for example, frequency) into the data set, but passes them on to the hardware only when requested by the command identification to do so. Since this request is always made at the end of a command line, the sequence of the setting commands in the command line is irrelevant.

Immediately before the data are passed on to the device hardware, they are verified for compatibility both with the other data and with the device hardware. If execution of the setting commands is not possible, an execution error message will be sent to the status reporting system. All modifications to the data set will be ignored and no new setting made in the device hardware. Due to the delayed verification and hardware setting, illegal device states may temporarily be set within a command line without causing an error message. At the end of the command line, a legal device status must be restored.

Prior to the data transfer to the hardware, the settling bit is set in the STATus:OPERation Register (refer to *STATus:OPERation Register* on page 3–25). The hardware carries out the setting and the bit is reset as soon as settled state is reached. This mechanism can be used for synchronization of the command processing.

IEC/IEEE-bus queries cause the data set management to send the desired data to the output unit.

Status Reporting System

The status reporting system collects information about the device status and makes it available to the output unit on request. Structure and function are described in detail in *Status Reporting System* on page 3–19.

Output Unit The output unit collects the information requested by the controller from the data set management. It processes the information in conformance with the SCPI rules and makes it available in the output buffer. The output buffer has a capacity of 1024 characters. If the requested information is longer, it will be made available in portions in a way that is not noticeable to the controller.

If the device is addressed as a talker and the output buffer does not contain any data or expect data from the data set management, the output unit sends the error message “Query UNTERMINATED” to the status reporting system. No data will be sent on the IEC/IEEE bus and the controller will wait for timeout. This procedure is prescribed by SCPI.

The output unit is cleared as soon as the command line has reached the output unit. It is written with the new data resulting from this line. The output unit is cleared in particular when there is a line between the command for reading the output unit (for example, “FREQ?”) and fetching this value.

Command Sequence and Command Synchronization

It is evident from the discussions above that overlapping execution is possible with all commands. Setting commands within a command line are not necessarily executed in the sequence that the commands are received.

To ensure that commands will be executed in a certain sequence, each command must be sent in its own command line with an IBWRT() request.

To avoid overlapping execution of commands, one of the commands *OPC, *OPC? or *WAI must be used. All three commands have the effect that a certain action will only be triggered after the hardware has been set and has settled. By suitable programming the controller can be forced to wait for the respective action (see Table 3–1).

Table 3–1: Synchronization with *OPC, *OPC? and *WAI

Command	Action after hardware settling	Programming of controller
*OPC	Setting the Operation-Complete bit in the ESR	<ul style="list-style-type: none"> - Setting bit 0 in the ESE - Setting bit 5 in the SRE - Waiting for service request (SRQ)
*OPC?	Writing a “1” into the output buffer	Addressing the device as a talker
*WAI	Continuing the IEC/IEEE-bus handshake	Sending the next command

An example of command synchronization is given in *Appendix D: Program Examples*.

Status Reporting System

The status reporting system stores all information on the current operating status of the instrument and on errors (see Figure 3–4 on page 3–22). Such information is stored in the status registers and in the error queue. The contents of the status registers and of the error queue can be queried via the IEC/IEEE bus.

The information is hierarchically structured. The topmost level is formed by the Status Byte Register (STB) defined by IEEE 488.2 and the associated mask register Service Request Enable (SRE). The STB receives its information from the Standard Event Status Register (ESR), also defined in IEEE 488.2, and the associated mask register Standard Event Status Enable (ESE) as well as from the SCPI-defined STATus:OPERation and STATus:QUESTionable registers, which contain detailed information on the instrument.

The status reporting system also includes the IST flag (Individual STatus) and the Parallel Poll Enable Register (PPE) assigned to it. The IST flag, just as SRQ, combines the complete device status in a single bit. The PPE for the IST flag has an analog function like the SRE has for the Service Request.

The output buffer contains the messages returned by the device to the controller. It is not part of the status reporting system, but since it determines the value of the MAV bit in the STB, it is also shown in Figure 3–4 on page 3–22.

Structure of a SCPI Status Register

Each SCPI register consists of five registers of 16 bits each and with different functions (see Figure 3–3) The individual bits are independent of each other; each hardware status is assigned a bit number which is the same for all five registers. Bit 15 (the most-significant bit) is set to zero in all registers. Thus the contents of the registers can be processed by the controller as a positive integer.

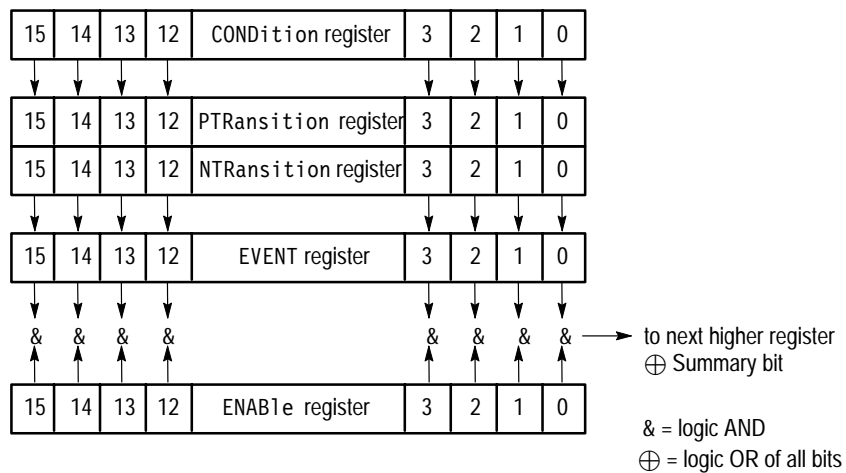

Figure 3–3: Status Register Model

CONDition register. The CONDition register is directly written to by the hardware or the summary bit of the next lower register. Its contents reflects the current device status. This register can be read but not written or cleared. Reading the register does not change its contents.

PTRansition register. The Positive TRansition register acts as a transition filter. Upon transition of a bit of the CONDition register from 0 to 1, the associated PTR bit decides whether the EVENT bit will be set to 1.

PTR bit = 1: the EVENT bit is set.

PTR bit = 0: the EVENT bit is not set.

This register can be written and read. Reading the register does not change its contents.

NTRansition register. The Negative TRansition register also acts as a transition filter. Upon transition of a bit of the CONDition register from 1 to 0, the associated NTR bit decides whether the EVENT bit is set to 1.

NTR bit = 1: the EVENT bit is set.

NTR bit = 0: the EVENT bit is not set.

This register can be written and read. Reading the register does not change its contents.

With the aid of these two transition filter registers, the user can define the status change of the CONDition register (none, 0 to 1, 1 to 0 or both) that is to be reported in the EVENT register.

EVENT register. The EVENT register reports whether an event has occurred since its last reading; it is the memory of the CONDition register. It only registers events that have been reported by the transition filters. The EVENT register is continuously updated by the instrument. It can only be read by the user. Reading this register clears its contents. This register is frequently referred to as the overall register.

ENABLE register. The ENABLE register determines whether the EVENT bit affects the summary bit (refer to *Summary bit* on page 3–21). Each bit of the EVENT register is ANDed (symbol '&') with the associated ENABLE bit. The events of all logical operations of this register are ORed (symbol '+') and passed on to the summary bit.

ENAB bit = 0: the associated EVENT bit does not affect the summary bit.

ENAB bit = 1: if the associated EVENT is "1", the summary bit is also set to "1".

This register can be written and read by the user. Reading the register does not change its contents.

Summary bit. As stated above, the summary bit for each register is derived from the EVENT and the ENABLE registers. The result is entered into a bit of the CONDITION register of the next higher register.

The instrument automatically generates the summary bit for each register. An event, such as a non-locking PLL, may thus cause a service request through all hierarchical levels.

***NOTE.** The Service Request Enable Register SRE defined in IEEE 488.2 may be considered as the ENABLE register of the STB provided that the STB is configured in conformance with SCPI. Accordingly, the ESE may be considered as the ENABLE register of the ESR.*

Overview of Status Registers

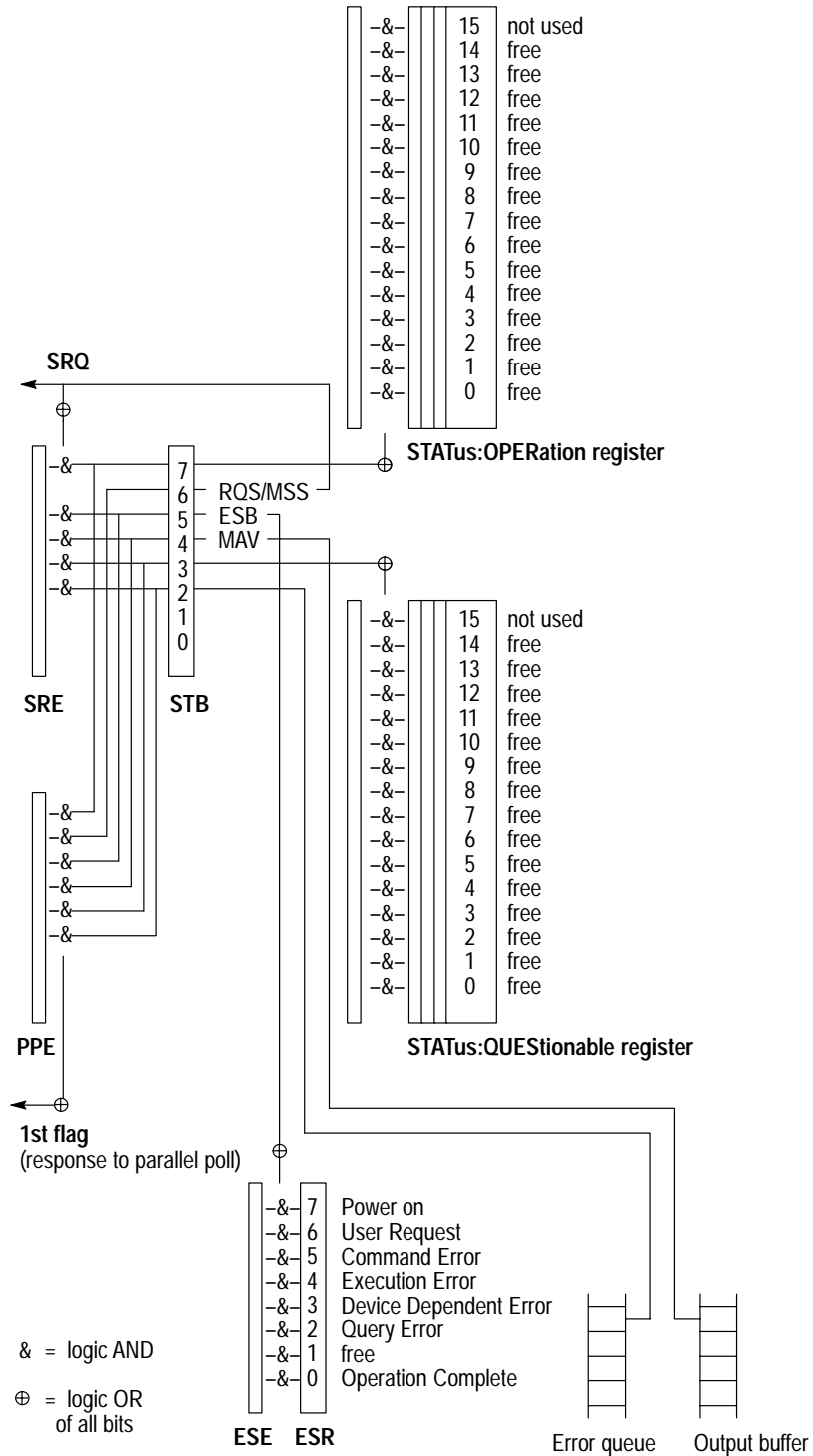

Figure 3-4: Overview of status registers

Description of Status Registers

Status Byte (STB) and Service Request Enable Registers (SRE). The STB is already defined in IEEE 488.2. It provides a rough overview of the device status, collecting information from the lower-level registers. It is comparable with the CONDition register of a SCPI-defined register and is at the highest level of the SCPI hierarchy. Its special feature is that bit 6 acts as the summary bit of all other bits of the Status Byte Register.

The Status Byte Register is read out by the query `*STB?` or a Serial Poll.

The SRE is associated with the STB. The function of the SRE corresponds to that of the ENABLE register of the SCPI registers. Each bit of the STB is assigned a bit in the SRE. Bit 6 of the SRE is ignored. If a bit is set in the SRE and the associated bit in the STB changes from 0 to 1, a Service Request (SRQ) will be generated on the IEC/IEEE bus, which triggers an interrupt in the controller configured for this purpose, and can be further processed by the controller.

The SRE can be set by the command `*SRE` and read out by the query `*SRE?`.

Table 3-2: Definition of bits in the Status Byte Register

Bit No.	Definition
2	<p>Error Queue not empty</p> <p>This bit is set when the Error Queue receives an entry. If this bit is enabled by the SRE, each entry of the Error Queue will generate a Service Request. An error can thus be recognized and specified in detail by querying the Error Queue. The query returns an informative error message. This procedure is recommended since it considerably reduces the problems of IEC/IEEE-bus control.</p>
3	<p>QUESTionable Status Summary Bit</p> <p>This bit is set if in the QUESTionable Status Register an EVENT bit is set and the associated ENABLE bit is set to 1. A set bit denotes a questionable device status which can be specified in greater detail by querying the QUESTionable Status Register.</p>
4	<p>MAV Bit (message available)</p> <p>This bit is set if a readable message is in the output buffer. This bit may be used to automate reading of data from the device into the controller (see Appendix D, Programming Examples)</p>
5	<p>ESB Bit</p> <p>Summary bit of the Event Status Register. This bit is set if one of the bits in the Event Status Register is set and enabled in the Event Status Enable Register. Setting of this bit denotes a serious error which can be specified in greater detail by querying the Event Status Register.</p>

Table 3–2: Definition of bits in the Status Byte Register (Cont.)

Bit No.	Definition
6	<p>MSS Bit (Master-Status-Summary-Bit)</p> <p>This bit is set if the instrument causes a service request. This is the case if one of the other bits of this register is set together with its mask bit in the Service Request Enable Register SRE.</p>
7	<p>OPERation Status Register Summary Bit</p> <p>This bit is set if an EVENT bit is set in the OPERation Status Register and the associated ENABLE bit is set to 1. A set bit denotes that an action is just being performed by the instrument. Information on the type of action can be obtained by querying the OPERation Status Register.</p>

IST Flag and Parallel Poll Enable Register (PPE). Similar to the SRQ, the IST flag combines the complete status information in a single bit. It can be queried by Parallel Poll (see page 3–27) or by *IST?.

The Parallel Poll Enable Register (PPE) determines which bits of the STB affect the IST flag. The bits of the STB are ANDed with the corresponding bits of the PPE, bit 6 – in contrast to the SRE – being used too. The IST flag is obtained by ORing all results together. The PPE can be set by the command *PRE and read by the query *PRE?.

Event Status Register (ESR) and Event Status Enable Register (ESE). The ESR is already defined in the IEEE 488.2 standard. It is comparable to the EVENT register of an SCPI register. The Event Status Register can be read out by the query *ESR?.

The ESE forms the associated ENABLE register. It can be set by the command *ESE and read out by the query *ESE?.

Table 3–3: Definition of bits used in the Event Status Register

Bit No.	Definition
0	<p>Operation Complete</p> <p>Upon reception of the *OPC command this bit is set when all previous commands have been executed.</p>
2	<p>Query Error</p> <p>This bit is set if the controller wants to read data from the instrument but has not sent a data request command, or if the controller does not fetch the requested data but sends instead a new command to the instrument. A frequent cause is a faulty query which cannot be executed.</p>

Table 3-3: Definition of bits used in the Event Status Register (Cont.)

Bit No.	Definition
3	Device-dependent Error This bit is set if a device-dependent error occurs. An error message with a number between -300 and -399 or a positive error number denoting the error in greater detail (see Appendix B, Error Messages) will be entered into the Error Queue.
4	Execution Error This bit is set if the syntax of the command received is correct but the command cannot be executed due to various marginal conditions. An error message with a number between -200 and -300 describing the error in greater detail (see Appendix B, Error Messages) will be entered into the Error Queue.
5	Command Error This bit is set if an undefined command or a command with incorrect syntax is received. An error message with a number between -100 and -200 describing the error in greater detail (see Appendix B, Error Messages) will be entered into the Error Queue.
6	User Request This bit is set upon pressing the [LOCAL] key, ie when the instrument is switched to manual control.
7	Power On This bit is set upon switching on the instrument

STATUS:OPERation Register. The CONDition part of this register contains information on the operations currently performed by the instrument and the EVENT part on the operations performed by the instrument since the last readout of the register. The register can be read by the queries STATUS:OPERation:CONDition? or STATUS:OPERation[:EVENT]?

Table 3-4: Definition of bits used in the STATUS:OPERation Register

Bit No.	Definition
	This register is not used

STATUS:QUESTionable Register. This register contains information on questionable device states. These may for instance occur if the instrument is operated out of specifications. The register can be read by the queries STATUS:QUESTionable:CONDition? or STATUS:QUESTionable[:EVENT]?

Table 3–5: Definition of bits used in the STATUS:QUESTIONABLE Register

Bit No.	Definition
	This register is not used

Use of the Status Reporting System

For an efficient use of the status reporting system, the information contained therein has to be transferred to the controller and further processed. There are various methods which are described in the following. Detailed program examples are given in *Appendix D: Program Examples*.

Service Request, Use of Hierarchical Structure. Under certain conditions, the instrument may send a service request (SRQ) to the controller. This service request usually causes an interrupt at the controller to which the controller program can respond by suitable actions. As shown in Figure 3–4 on page 3–22), a SRQ will always be triggered if one or several of the bits 2, 3, 4, 5 or 7 have been set in the Status Byte Register and enabled in the SRE. Each of these bits combines the information from a further status register, from the error queue or the output buffer. By setting the ENABLE registers of the status registers accordingly, any bit in any status register will be able to trigger a SRQ. To utilize the possibilities of the service request, all bits in the enable registers SRE and ESE should be set to “1”.

Example (see also Figure 3–4 on page 3–22 and *Appendix D: Program Examples*):

Use the *OPC command to generate a SRQ:

1. Set bit 0 (Operation Complete) in the ESE.
2. Set bit 5 (ESB) in the SRE.
3. The instrument generates a SRQ upon completion of its settings.

The SRQ is the only way for the instrument to become active on its own. A controller program should set the instrument so that a service request will be generated in case of malfunctions. The program should suitably respond to the service request. A detailed example of a service request routine is given in *Appendix D: Program Examples*.

Serial Poll. Similar to the *STB command, the serial poll is used to query the status byte register of a device. Querying is implemented by interface messages and is therefore much quicker. The serial poll method has already been defined in the IEEE 488.1 standard and used to be the only standard method of querying the status byte register. This method also works with instruments which neither conform to SCPI nor to IEEE 488.2.

The QuickBASIC command for the execution of a serial poll is IBRSP(). Serial poll is mainly used to get a quick overview of the device status of several devices connected to the IEC/IEEE bus.

Parallel Poll. In the parallel poll mode up to eight devices are simultaneously requested by a command from the controller to transmit 1 bit of information on the assigned data line, ie to pull the assigned data line to logic 0 or 1. Similar to the SRE register which defines the conditions under which a SRQ will be generated, there is a Parallel Poll Enable Register (PPE), which is also ANDed bit by bit with the STB under consideration of bit 6. The result is ORed and is then returned (possibly inverted) as a reply to a parallel poll of the controller. The result can also be read out without parallel poll by the query *IST.

First the device must be set for the parallel poll by the QuickBASIC command IBPPC(). This command assigns a data line to the device and determines whether the reply has to be inverted. The parallel poll itself is made by IBRPP().

The parallel poll mode is mainly used to find out quickly which of the many devices connected to the IEC/IEEE bus has caused a SRQ. For this SRE and PPE must be set to the same value.

Queries. Each individual register of a status register can be read out by queries. The individual queries are given in the detailed description of the registers on page 3–23. The queries always return a number representing the bit pattern of the queried register. This number is evaluated by the controller program.

Queries are mainly used after a SRQ to obtain detailed information on the cause for the SRQ.

Error Queue Query. Each error condition in the instrument causes an entry in the error queue. The entries in the error queue are detailed error messages in plain text which can be read out via manual control in the ERROR menu or via IEC/IEEE bus by the query SYSTem:ERRor?. Each query SYSTem:ERRor? returns an entry from the error queue. If there are no more error messages in the error queue, 0 = “No error” is returned by the instrument.

The error queue should be queried in the controller program after each SRQ since the queue entries provide a more precise description of the error cause than the status registers. In particular in the test phase of a controller program the error queue should be queried at regular intervals since it also registers faulty commands from the controller to the instrument.

Resetting the Status Reporting System

Table 3–6 contains the various commands and events causing a reset of the status reporting system. None of the commands, with the exception of *RST and SYSTem:PRESet, affects the functional device settings. In particular, DCL does not clear the device settings.

Table 3–6: Resetting the device functions

Effect	Switching on AC supply voltages		DCL, SDC (Device Clear, Selected Device Clear)	*RST or SYSTem :PRESet	STATus :PRESet	*CLS
	Power On Status Clear					
	0	1				
Clears STB, ESR		yes				yes
Clears SRE, ESE		yes				
Clears PPE		yes				
Clears EVENT registers		yes				yes
Clears ENABLE registers of all OPERATION and QUESTIONable Registers, fills the ENABLE registers of all other registers with "1".		yes			yes	
Fills PTRansition registers with "1", clears NTRansition registers		yes			yes	
Clears error queue	yes	yes				yes
Clears output buffer	yes	yes	yes	*	*	*
Clears command processing and input buffer	yes	yes	yes			yes

* Any command that is the first in a command line, that is, immediately follows a <PROGRAM MESSAGE TERMINATOR>, clears the output buffer.

Maintenance and Troubleshooting

This section discusses the maintenance and troubleshooting that an operator can perform on the DDS200 Digital Demodulation System. For a more thorough discussion of maintenance and troubleshooting, refer to the service manual

Maintenance

The unit does not require regular maintenance. Cleaning is basically all the maintenance the unit requires. In particular, care should be taken that the inlet and outlet vents are kept clean. Check the nominal data from time to time. Refer to the data sheet for data and tolerances as well as information on appropriate calibration intervals.

Cleaning the Outside

Use a soft, lint-free duster or brush for cleaning the unit on the outside. If the unit is soiled, mild or mild detergents may be used. Do not use any nitro thinners, acetone, etc. since these solvents may damage the front-panel labelling or plastic parts. Clean and check above all the inlet and outlet vents.



WARNING. *Disconnect the power cord from the rear-panel of the DDS200 before opening the instrument. Failure to do so could expose you to risk of injury or even death.*

Cleaning the Inside

For cleaning the interior, remove the covers. Remove dust by means of a brush or grease-free compressed air. Do not open the internal shield covers since the risk of breaking a component during cleaning is high and an enclosed assembly will not be soiled that much. The inlet and outlet vents are the most affected by dirt.

Storage

The unit can be stored at temperatures between -40 and $+70$ °C. If stored for a longer period, the unit should be protected against dust.

Replacing the Battery



WARNING. To prevent injury, avoid short circuiting or charging the battery. Short circuiting the battery can cause the battery to explode. Do not open discharged batteries; dispose of batteries as hazardous waste.

The instrument has a lithium battery for storing the selected status and for operation of the real-time clock. The battery has a lifetime of approximately five years and should be replaced as required (for example, after a long storage period at high temperature). Replace the discharged battery with one of the same type.



WARNING. Disconnect the power cord from the rear-panel of the DDS200 before opening the instrument. Failure to do so could expose you to risk of injury or even death.

The battery is located on the processor board. With the unit open, that is, after folding down the rear panel, the processor board is located at the bottom right, as viewed from the rear panel. the processor board can be recognized by the flat cable connected to the rear panel.

Disassembling and opening the processor board:

- Disconnect the flat cable.
- Release the locking bracket on the right of the processor assembly using a Phillips screwdriver.
- Pull the processor board to the rear.
- Open the upper shield cover of the processor board using a Phillips screwdriver.
- The battery is located on the left front near the large multi-way connector.

To install the battery properly, solder its terminal lugs and fix it by means of cable ties. Make sure to get the polarities right. Polarity is indicated with “+” and “-” on the battery and also on the processor board. The symbols on the battery have to match with those on the processor board.

Troubleshooting

On power-up, all assemblies are coarsely checked for their presence and their operation (power-up screen mask). If a failure is detected, it will be signaled on power-up. It is therefore necessary to observe the power-up sequence.

Self Test (QAM)

The results of the continuously running selftest can be directly queried. Press the **PRESET** key, then the **SERVICE** key appearing on the screen and finally the **SELFTEST** key. By pressing the **UP** or **DOWN** key the screen can be scrolled to read the information about the individual module states. If in the MODE menu the QAM–DEMODULATOR module has been selected, the following parameters will be checked in detail:

A): MICROPROCESSOR:

0) BATTERY CHECK: OK/FAILURE. #

B): CONVERTER: (selftest messages of the converter):

1) POWER SUPPLY: OK/FAILURE; #

2) SYNTHESIZER PLL: OK/FAILURE; #

3) SAW TEMPERATURE: OK/FAILURE; #

4) 5V REFERENCE: OK/FAILURE; #

5) 33/24V REFERENCE: OK/FAILURE; #

6) TUNER TEMPERATURE: OK/FAILURE. #

C): QAM DEMODULATOR: (selftest messages of the QAM demodulator QD):

8) POWER SUPPLY: OK/FAILURE; #

9) OSCILLATOR LVL: OK/FAILURE; #

10) AGC: OK/OUT OF RANGE;

11) NOISE AGC: OK/OUT OF RANGE;

12) DIG AGC: OK/OUT OF RANGE;

13) TEMPERATURE: OK/FAILURE; #

14) SYMBOL CLOCK: OK/UNLOCKED;

15) EQUALIZER SYNC: OK/UNLOCKED;

16) CARRIER SYNC: OK/UNLOCKED;

17) FRAME SYNC: OK/UNLOCKED;

18) I2C EEPROM: OK/FAILURE; #

19) I2C BUS: OK/FAILURE; #

20) 28MHZ CLOCK: OK/FAILURE; #

21) I2C DEMODULATOR: OK/FAILURE. #

Error Messages

The EFA–Q continuously checks the main operating parameters. If one of these parameters fails or is detected as faulty, an error message is displayed in the bottom line of the screen. This error message is derived from the self test, the messages being positioned in the following scheme according to their number. An error causes a “1” to be entered into the corresponding error number; if there is no error, “0” will be entered. Only the messages marked by # are used for the selftest error code.

Table 4-1: Assignment of error message numbers to binary error code

Error number	23	22	21	20	19	18	17	16	15	14	13	12	11	10	9	8	7	6	5	4	3	2	1	0
Binary code	0	0	#	#	#	#	0	0	0	0	#	0	0	0	#	#	0	#	#	#	#	#	#	#
	MSB																						LSB	

”#” means that the test value is entered into the corresponding position (0 or 1),
 “0” means that the associated bit is always set to 0, this error number is not used.
 The resulting bit sequence is considered as a digital number and displayed in hexadecimal format on the screen as soon as it is not “0”. This number can be reconverted by replacing each individual hexadecimal digit by the associated binary value according to the following table:

Table 4-2: Conversion of displayed hexadecimal code into binary code

Hex	f	e	d	c	b	a	9	8	7	6	5	4	3	2	1	0
Bin	1111	1110	1101	1100	1011	1010	1001	1000	0111	0110	0101	0100	0011	0010	0001	0000

Example: message on display:

"SELFTEST ERROR CODE: 000300 (Hex)"

⇒ Binary: 0000 0000 0000 0011_{↑↑} 0000 0000
 Error No. 9, Error No. 8

(conversion of hexadecimal display acc. to Table 2)

⇒ Error No. 8 (power supply) and No. 9 (oscillator level) occurred in the QAM demodulator module because there is a "1" at the relevant positions of the binary word (Table 1). The error numbers are assigned to the errors occurring in the instrument as shown in the above list (eg No. 8: power supply).

Appendix A: Specifications

This section contains the specifications for the DDS200 Digital Demodulation System. All specifications are guaranteed unless labeled “typical.” Typical specifications are provided for your convenience and are not guaranteed. Specifications labeled with the ✓ symbol are checked in the Performance Test (PT) procedure in the service manual.

NOTE. Performance requirements are valid provided that the instruments are operating within environmental parameters and have warmed up for at least one hour.

Table A-1: Electrical Specifications

Characteristics	Requirements	Supplemental information
Overvoltage category		CAT II
RF Input		Connector: front-panel female type BNC
✓ Frequency range	47 to 862 MHz	
Level	100 μ V to 700 mV	
Accuracy, typical	\pm 3 dB	
Impedance, typical	75 Ω	
✓ Return loss	\geq 12 dB	
Channel bandwidth, typical	8 MHz	
IF Input		
Level, typical	10 to 100 mV (80 to 100 dBuV)	
Impedance, typical	50 Ω	
✓ Return loss (33 to 40 MHz)	\geq 20 dB	
IF Output		
Level, typical	45 mV (93 dBuV)	
Impedance, typical	50 Ω	
Frequency, typical	36 MHz	
Demodulator		
✓ Modulation modes ¹	4, 16, 32, 64, 128, 256 QAM	
Pulse response roll-off factors	0.15, 0.20, 0.25, 0.30	

¹ Operation at 4, 128, and 256 QAM is not specified.

Table A-1: Electrical Specifications (cont.)

Characteristics	Requirements	Supplemental information
Insertion loss (64 QAM)	≤ 1.5 dB	
Symbol rate, typical	1.5 to 7.0 MBaud	When setting the symbol rate value, the accuracy should be to three decimal places
✓ Symbol rate	6.9 MBaud	
Equalizer		Self adapting, selectable with freeze mode
Reed-Solomon decoder	204, 188 byte	t=8, selectable
Bit error rate display range	10^{-3} to 10^{-10}	
Interleaving		Forney, L=12
Energy dispersal		IESS 309 to DVB specification
Internal Noise Generator (Option B5)		
Signal/Noise ratio, typical	12 to 62 dB	
Resolution	0.1 dB	
Filter selection		Automatic conversion and correct setting of S/N ratio based on selected filter.
Outputs		
Parallel MPEG2 transport stream		Connector: rear-panel 25-pin
Standard		LVDS (188 or 204 bytes), DVB-A010
Source impedance, typical	100 Ω	
DC component, typical	1.25 V	
Signal amplitude, typical	247 mV to 454 mV	
Transmission link length (Max)		Approximately 5 meters
Serial MPEG2 transport stream		Connector: rear-panel female type BNC
Standard		ASI
Source impedance, typical	75 Ω	
DC component, typical	0 V	
Signal amplitude, typical	0.9 V _{p-p}	
Transmission rate, typical	270 Mbit/s	Fixed
QAM serial data (before Reed-Solomon)		Connector: rear-panel female type BNC
Source impedance, typical	75 Ω	
QAM serial clock output		Connector: rear-panel female type BNC
Source impedance, typical	75 Ω	

Table A-1: Electrical Specifications (cont.)

Characteristics	Requirements	Supplemental information
Measurement Displays		
Graphic		
Constellation display		
Calculated		
Bit error rate (BER)		
Frequency offset		
Level		
I/Q phase error		In degrees
I/Q amplitude imbalance		As a percentage
Carrier suppression		
Residual carrier		In dB
Sinusoidal interference (C/I)		In dB
Signal/noise ratio (SNR)		In dB
Phase jitter		In degrees
Modulation error ratio (MER)		As RMS or peak value
Synchronization Information		
Symbol rate		
Carrier recovery		
Equalizer		
MPEG2 frame		

Table A-2: Certifications and compliances

EC Declaration of Conformity – EMC	<p>Meets intent of Directive 89/336/EEC for Electromagnetic Compatibility. Compliance was demonstrated to the following specifications as listed in the Official Journal of the European Communities:</p> <p>EN 55011 Class A Radiated and Conducted Emissions</p> <p>EN 55011 Class B Radiated and Conducted Emissions</p> <p>EN 50081-1 Emissions:</p> <p> EN 55022 Class B Radiated and Conducted Emissions</p> <p> EN 60555-2 AC Power Line Harmonic Emissions</p> <p>EN 50082-1 Immunity:</p> <p> IEC 801-2 Electrostatic Discharge Immunity</p> <p> IEC 801-3 RF Electromagnetic Field Immunity</p> <p> IEC 801-4 Electrical Fast Transient/Burst Immunity</p> <p> IEC 801-5 Power Line Surge Immunity</p>
EMC Compliance	<p>Meets the intent of Directive 89/336/EEC—Amended by 91/263/EEC, 92/31/EEC, 93/68/EEC— for Electromagnetic Compatibility when it is used with the product(s) stated in the specifications table. Refer to the EMC specification published for the stated products. May not meet the intent of the Directive if used with other products.</p>
FCC Compliance	<p>Emissions comply with FCC Code of Federal Regulations 47, Part 15, Subpart B, Class A Limits</p>
EC Declaration of Conformity – Low Voltage	<p>Compliance was demonstrated to the following specification as listed in the Official Journal of the European Communities:</p> <p>Low Voltage Directive 73/23/EEC, Amended by 93/68/EEC</p> <p>EN 61010-1:1993 Safety requirements for electrical equipment for measurement, control, and laboratory use</p>
Approvals	<p>UL3111-1 – Standard for electrical measuring and test equipment</p> <p>CAN/CSA C22.2 No. 1010.1 – Safety requirements for electrical equipment for measurement, control and laboratory use</p>
Installation Category Descriptions	<p>Terminals on this product may have different installation category designations. The installation categories are:</p> <p>CAT III Distribution-level mains (usually permanently connected). Equipment at this level is typically in a fixed industrial location</p> <p>CAT II Local-level mains (wall sockets). Equipment at this level includes appliances, portable tools, and similar products. Equipment is usually cord-connected</p> <p>CAT I Secondary (signal level) or battery operated circuits of electronic equipment</p>

Table A-3: Power Characteristics

Characteristic	Description
Line Voltage (automatic selection)	85 to 132 VAC 187 to 264 VAC
Line Frequency	50 to 60 Hz
Power Consumption	< 100 VA

Table A-4: Environmental Characteristics

Characteristic	Description
Operating temperature range	0° C to +50° C
Rated temperature range	+5° C to +45° C
Storage temperature range	-40° C to +70° C

Table A-5: Physical Characteristics

Dimension	mm	in
Height	147	5.8
Width	450	17.7
Depth	460	18.1
Weight	kg	lb
Net	12	26.5

Appendix B: IEC/IEEE-Bus Interface

The DDS200 Digital Demodulation System is fitted with an IEC/IEEE-bus interface as standard. The connector for the IEEE-488 bus is located on the rear panel. A controller can be connected for remote control, using a shielded cable for the connection.

Interface Characteristics

The EC/IEEE-bus interface has the following characteristics:

- 8-bit parallel data transmission
- Bi-directional data transmission
- Three-wire handshake
- High data transmission rate, max. 350 Kbyte/s
- Connection of up to 15 devices
- Maximum length of connecting cables: 49 feet (15 m); length of single cable: 6 feet (2 m)
- Wired OR links when several devices are connected in parallel

Bus Lines

The following are descriptions for each of the bus lines for the IEC/IEEE interface (see Table B-1):

- Data bus with 8 lines, DIO 1 to DIO 8
Transmission is bit-parallel and byte-serial in ASCII/ISO code. DIO 1 is the lowest-significant and DIO 8 the highest-significant bit.
- Control bus with 5 lines
 - IFC (Interface Clear)
Active LOW resets the interfaces of connected devices to a defined initial condition.
 - ATN (Attention)
Active LOW signals the transmission of interface messages; inactive HIGH signals the transmission of device-dependent messages.

- SRQ (Service Request),
Active LOW enables a device to send a service request to the controller.
- REN (Remote Enable)
Active LOW allows switchover to the remote-control mode.
- EOI (End or Identify)
In conjunction with ATN, this line has two functions: active LOW denotes the end of data transmission with ATN = HIGH and active LOW triggers a parallel poll with ATN = LOW.
- Handshake bus with three lines
 - DAV (Data Valid)
Active LOW signals that a valid data byte is on the bus.
 - NRFD (Not Ready For Data)
Active LOW signals that one of the connected devices is not ready to accept data.
 - NDAC (Not Data Accepted),
Active LOW until the connected device has accepted the data on the bus.

Table B-1: Bus Lines

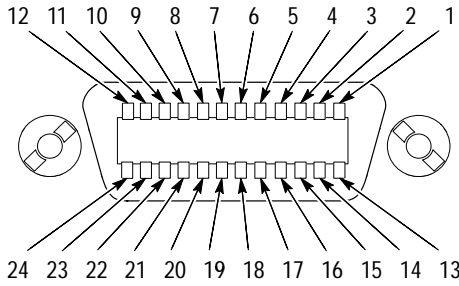
IEC/IEEE-488 Connector	Pin No.	Bus Line	Pin No.	Bus Line
	1	DIO1	13	DIO5
	2	DIO2	14	DIO6
	3	DIO3	15	DIO7
	4	DIO4	16	DIO8
	5	EOI	17	REN
	6	DAV	18	GND(6)
	7	NRFD	19	GND(7)
	8	NDAC	20	GND(8)
	9	IFC	21	GND(9)
	10	SRQ	22	GND(10)
	11	ATN	23	GND(11)
	12	Shield	24	Logic GND

Interface Functions

Devices controlled via IEC/IEEE bus may be provided with different interface functions. The interface functions of the DDS200 are listed in Table B–2.

Table B–2: Interface functions

Control character	Interface function
SH1	Source handshake
AH1	Acceptor handshake
L3..L4/LE3..LE4	Listener
T5..T8/TE5..TE8	Talker, capability to answer serial poll
SR1	Service request
PP1	Parallel poll
RL1	Remote/ local switchover
DC1	Device clear
DT1	Device trigger
C1...C27	Controller function

Interface Messages

Interface messages are transmitted to the device on data lines with the attention line being active LOW. They are used for communication between device and controller.

Common Commands

Common commands are in the code range 10 to 1F hex. They affect all devices on the bus without any addressing required.

Table B–3: Common commands

Command	QuickBASIC command	Function in the device
DCL (Device Clear)	IBCMD (controller%, CHR\$(20))	Interrupts processing of received commands and sets the command processing software to a defined initial state. The device setup remains unchanged.
IFC (Interface Clear)	IBSIC (controller%)	Resets the interfaces to their initial condition.
LLO (Local Lockout)	IBCMD (controller%, CHR\$(17))	Locks the LOC/IEC ADDR key

Table B-3: Common commands (Cont.)

Command	QuickBASIC command	Function in the device
SPE (Serial Poll Enable)	IBCMD (controller%, CHR\$(24))	Ready for serial poll
SPD (Serial Poll Disable)	IBCMD (controller%, CHR\$(25))	End of serial poll
PPU (Parallel Poll Unconfigure)	IBCMD (controller%, CHR\$(21))	End of parallel poll query status

Addressed Commands

The addressed commands are in the code range 00 to 0F hex. They only affect devices addressed as a listener.

Table B-4: Addressed commands

Command	QuickBASIC command	Function in the device
SDC (Selected Device Clear)	IBCLR (efa%)	Interrupts processing of received commands and sets the command processing software to a defined initial state. The device setup remains unchanged.
GTL (Go to Local)	IBLOC (efa%)	Change to local mode (manual control).
PPC (Parallel Poll Configure)	IBPPC (efa%, data%)	Configure device for parallel poll. The QuickBASIC command executes PPE/PPD in addition.

Appendix C: List of Error Messages

Table C-1 through Table C-5 contain all the error messages that may occur in the DDS200 Digital Demodulation System. Negative error numbers are defined in the SCPI standard; positive error numbers identify device-specific errors.

The error code is queried by means of the **SYSTem:ERR?** command.

The left column of the tables gives the error code number. In the right column, the text of the error message that will be entered into the error/event queue or shown on the display is written in bold with an explanation following the error message.

SCPI-Specific Error Messages

No error

Table C-1: No error

Error number	Test displayed upon an error queue query Explanations
0	No error This message is displayed when there are no entries in the error queue.

Command Errors; cause bit 5 in the ESR register to be set

Table C-2: Command errors

Error number	Test displayed upon an error queue query Explanations
-100	Command Error Command faulty or invalid.
-101	Invalid Character The command contains a character which is invalid for that type. Example: a header containing an ampersand , "SOURCE&"
-102	Syntax error Command invalid. Example: the command contains block data which the device does not accept.
-103	Invalid separator Command contains an illegal character where a separator is expected. Example: the semicolon omitted after the command.

Table C-2: Command errors (Cont.)

Error number	Test displayed upon an error queue query Explanations
-104	Data type error Command contains an invalid data element. Example: numeric data for frequency setting were expected and ON was encountered.
-105	GET not allowed A Group Execute Trigger (GET) was received within a program message.
-108	Parameter not allowed The command contains too many parameters. Example: the command SENSE:FREQuency allows only one frequency specification.
-109	Missing parameter The command contains fewer parameters than required. Example: the command SENSE:FREQuency requires a frequency specification.
-110	Command header error The header of this command contains an error.
-111	Header separator error The header contains an illegal separator. Example: the header is not followed by a "white space", "*ESE255"
-112	Program mnemonic too long The header contains more than 12 characters.
-113	Undefined header The header is undefined for this specific device. Example: *XYZ is not defined for any device.
-114	Header suffix out of range The header contains a numeric suffix which makes the header invalid. Example: INPut3 does not exist in the device.
-120	Numeric data error Command contains a faulty numeric parameter.
-121	Invalid character in number A numeric contains an invalid character. Example: "A" in a decimal numeric or "9" in an octal data.
-123	Exponent too large The magnitude of the exponent is larger than 32000.
-124	Too many digits Numeric contains too many digits.
-128	Numeric data not allowed The command contains a numeric data element in a position where it is not allowed.
-130	Suffix error The command contains an incorrect suffix.

Table C-2: Command errors (Cont.)

Error number	Test displayed upon an error queue query Explanations
-131	Invalid suffix The suffix is inappropriate for this device. Example: nHz is not defined.
-134	Suffix too long The suffix contains more than 12 characters.
-138	Suffix not allowed A suffix is not allowed for this command or at this position in the command. Example: the command *RCL does not allow a suffix to be specified.
-140	Character data error The command contains a faulty character data element.
-141	Invalid character data Either the character data contain an invalid character or the particular data are not valid for this command. Example: spelling mistake in parameter specification.
-144	Character data too long The character data element contains more than 12 characters.
-148	Character data not allowed The character data element is not allowed for this command or at this position of the command. Example: the command *RCL requires the specification of a number.
-150	String data error The command contains invalid string data.
-151	Invalid string data The command contains invalid string data. Example: an END message was received before the terminal quote character.
-158	String data not allowed The command contains a legal character string at a position where it is not allowed. Example: character data in quotation marks.
-160	Block data error The command contains invalid block data.
-161	Invalid block data The command contains invalid block data. Example: an END message was received before the expected number of data was received.
-168	Block data not allowed The command contains legal block data at a position where they are not allowed. Example:
-170	Expression error The command contains an invalid mathematical expression. Example:

Table C-2: Command errors (Cont.)

Error number	Test displayed upon an error queue query Explanations
-171	Invalid expression The command contains an invalid mathematical expression. Example: the expression contains unmatched parentheses
-178	Expression data not allowed The command contains a mathematical expression at a position where it is not allowed. Example:
-180	Macro error An invalid macro was defined or an error occurred during the execution of the command.
-181	Invalid outside macro definition A wild card character for a macro element is outside of the macro definition. Example:
-183	Invalid inside macro definition The macro definition contains a syntax error. Example:
-184	Macro parameter error A command within the macro definition had the invalid number or the wrong element type. Example:

Execution Errors; cause bit 4 in the ESR register to be set

Table C-3: Execution errors

Error number	Test displayed upon an error queue query Explanations
-200	Execution error Error occurred in the execution of the command.(eg no paper in the printer).
-201	Invalid while in local The command cannot be executed in the device local state because of a control. Example: the device receives a command which would modify the position of the rotating knob and cannot be executed since the device is in the local state.
-202	Settings lost due to rtl A setting related to a control gets lost when the device is switched from LOCS to REMS or LWLS to RWLS.
-210	Trigger error Error on triggering the device.

Table C-3: Execution errors (Cont.)

Error number	Test displayed upon an error queue query Explanations
-211	Trigger ignored The trigger (GET, *TRG or trigger signal) was ignored because of the device time control. Example: the device was not ready to answer.
-212	Arm ignored An arming signal was ignored by the device.
-213	Init ignored the initialization of a measurement was ignored since another measurement was already being carried out.
-214	Trigger deadlock The trigger cannot be processed. (The trigger source for releasing a measurement is set to GET and the subsequent query is received. The measurement cannot be started if GET is not received, GET die darauf folgende Query wird empfangen. Die Messung kann ohne den Empfang von GET nicht gestartet werden, GET, however, generates an interrupted error.)
-215	Arm deadlock The arming signal cannot be processed.
-220	Parameter error The command contains a faulty or invalid parameter. Example:
-221	Settings conflict There is a setting conflict between two parameters. Example: FM1 and PM1 cannot be switched on simultaneously.
-222	Data out of range The parameter value is outside the legal range as defined by the device. Example: the command *RCL only allows entries in the range 0 to 49.
-223	Too much data The command contains too many data. Example: the device has not enough storage capacity.
-224	Illegal parameter value The parameter value is invalid. Example: an invalid character data element is specified.
-230	Data corrupt or stale Data are incomplete or invalid. Example: the device has aborted a measurement.
-231	Data questionable The measurement accuracy is suspect.
-240	Hardware error The command cannot be executed because of a hardware problem in the device.

Table C-3: Execution errors (Cont.)

Error number	Test displayed upon an error queue query Explanations
-241	Hardware missing The command cannot be executed because of missing device hardware. Example: an option is not installed.
-250	Mass storage error Error in the mass storage.
-251	Missing mass storage The command cannot be executed because of missing mass storage. Example: an option is not installed.
-252	Missing media The command cannot be executed because of a missing data media. Example: no disk in drive.
-253	Corrupt media Data media is corrupt. Example: wrong format of a disk.
-254	Media full Data media is full. Example: no room on the disk.
-255	Directory full The media directory is full.
-256	File name not found The specified file name cannot be found.
-257	File name error The file name is in error. Example: attempt to copy to a duplicate file name.
-258	Media protected The data media is protected. Example: the disk has a write-protect tab.
-260	Expression error The command contains a faulty mathematical expression.
-261	Math error in expression The expression contains a mathematical error. Example: division by zero.
-270	Macro error Error in the execution of a macro.
-271	Macro syntax error The macro definition contains a syntax error.
-272	Macro execution error The macro definition contains an error.

Table C-3: Execution errors (Cont.)

Error number	Test displayed upon an error queue query Explanations
-273	illegal macro label The macro label defined in the DMC* command is not allowed. Example: the label is too long. The label is identical to the Common Command Header or contains an invalid header syntax.
-274	Macro parameter error The macro parameter wild card character is wrong. Example:
-275	Macro definition too long The macro definition is too long.
-276	Macro recursion error The command sequence defined by the macro is trapped in a loop. Example: the event which would cause the macro to leave the loop does not occur.
-277	Macro redefinition not allowed The macro label in the *DMC command has already been defined elsewhere.
-278	Macro header not found The header of the macro label in the *GMC? Query has not already been defined.
-280	Program error Error in the execution of a remote-loaded program.
-281	Cannot create program The attempt to create the program failed.
-282	illegal program name The program name is invalid. Example: the name refers to a program which is not available.
-283	illegal variable name The variable is not available in the program.
-284	Program currently running The desired operation is not possible while the program is running.
-285	Program syntax error The remote-loaded program contains a syntax error.
-286	Program runtime error Program runtime error

Device Specific Error; cause bit 3 in the ESR register to be set

Table C-4: Device-specific error

Error number	Test displayed upon an error queue query Explanations
-300	Device-specific error EFA-specific error that cannot be defined more precisely.
-310	System error This error message signals a device-specific error. Please, contact the R&S service.
-311	Memory error Error in the device memory.
-350	Queue overflow This error code is entered into the queue in lieu of the code that caused the error when the queue is full. It indicates that an error occurred but was not recorded. Five of these codes are accepted by the queue.

Query Errors; cause bit 2 in the ESR register to be set

Table C-5: Query errors

Error number	Test displayed upon an error queue query Explanations
-400	Query error Generic query error that cannot be defined more precisely.
-410	Query INTERRUPTED The query was interrupted. Example: the device receives new data after a query before the response was completely sent.
-420	Query UNTERMINATED The query is incomplete. Example: the device is addressed as a talker and receives incomplete data.
-430	Query DEADLOCKED The query cannot be processed. Example: both input and output buffer are full and the device cannot continue.
-440	Query UNTERMINATED after indefinite response A query is received in the same command line after a query requesting an indefinite response.

Appendix D: List of Commands

The DDS200 Digital Demodulation System supports SCPI version 1995.0.

The instrument is remote-controlled using mostly commands defined or recognized in this SCPI version. Command systems not included in the SCPI standard are indicated.

Common Commands

Table D-1: Common Commands

Command	Data	Meaning
*CLS	--	Clear Status Data Structures
*ESE	0 to 255	Set Event Status Reg.
*ESE?		Event Status Enable Query
*ESR?	--	Standard Event Status Query
*IDN?	--	Identification Query
*IST?	--	Individual Status Query
*OPC	--	Operation Complete Command
*OPC?	--	Operation Complete Query
*PRE	0 to 65535	Set Parallel Poll Enable Register
*PRE?	--	Parallel Poll Enable Query
*PSC	-32767 to 32767	Set Power On Status Clear: == 0 OFF <> 0 ON
*PSC?	--	Power On Status Clear Query
*RCL	0 to 9	Recall Store 0 to 9
*RST	--	Reset Instrument
*SAV	0 to 9	Save Current State To Store 0 to 9
*SRE	0 to 255	Set / Read Service Request
*SRE?	--	Enable Register
*STB?	--	Status Byte Query
*TST?		Self-Test Query
*WAI		Wait For End Of Action

STATus Subsystem

NOTE. The commands listed below refer to the *OPERation* register. The commands can be used for the *QUEStionable* register as well by replacing “*OPERation*” by “*QUEStionable*”.

Table D-2: STATus Commands

Command	Data	Reply data	Meaning
STATus: QUEue [:NEXT]?	–	–	Returns the next item from the error/event queue and removes it from the queue (identical to that of SYST:ERR)
STATus:PRESet	–	–	Configures the SCPI and device-dependent Status Data structures
STATus: OPERation: [EVENT]?	–	–	Returns the contents of the OPERation:EVENT-status register
STATus: OPERation: CONDition?	–	–	Returns the contents of the OPERation:CONDition status register
STATus: OPERation: ENABLE STATus: OPERation: ENABLE?	ddd –	– ddd	Sets/Returns the enable mask which allows true conditions in the event register to be reported in the summary bit.

Table D-2: STATus Commands (Cont.)

Command	Data	Reply data	Meaning
STATus: OPERation: PTRansion STATus: OPERation: PTRansion?	ddd -	- ddd	Sets/Returns the positive transition filter
STATus: OPERation: NTRansion STATus: OPERation: NTRansion?	ddd -	- ddd	Sets/Returns the negative transition filter

SYSTEM Subsystem

Table D-3: SYSTEM Commands

Command	Data	Reply data	Meaning
SYSTem:TIME	0 to 23,0 to 59,0 to 59	–	System time.
SYSTem:TIME?	–	0 to 23,0 to 59,0 to 59	See page 2–20.
SYSTem:DATE	<Year>,1 to 12,1 to 31	–	System date
SYSTem:DATE?	–	<Year>,1 to 12,1 to 31	See page 2–20.
SYSTem:ERRor?	–	Error No., "Error description, device-specific description"	Error queries, see <i>Appendix C: List of Error Messages</i>
SYSTem:VERsion?	–	YYYY.V (Y = year ; V = version)	SCPI version (1995.0)
SYSTem:COMMunicate: GPIB[:SELF]:ADDRess	dd	–	Modifies the set IEC/IEEE address See page 2–20.
SYSTem:COMMunicate: SERial:BAUD	dddd	–	Sets the transfer rate for the serial interface (1200 to 19200)
SYSTem:COMMunicate: SERial:BAUD?	–	dddd	See page 2–20.
SYSTem:COMMunicate: SERial:BITS	d	–	Sets the number of bits for the serial interface (7, 8)
SYSTem:COMMunicate: SERial:BITS?	–	d	See page 2–20.
SYSTem:COMMunicate: SERial:PARity[:TYPE]	NONE EVEN ODD	–	Sets the parity check for the serial interface.
SYSTem:COMMunicate: SERial:PARity[:TYPE]?	–	NONE EVEN ODD	See page 2–20.
SYSTem:COMMunicate: SERial:SBITS	d	–	Sets the number of stop bits for the serial interface (1, 2)
SYSTem:COMMunicate: SERial:SBITS?	–	d	See page 2–20.

Table D-3: SYSTem Commands (Cont.)

Command	Data	Reply data	Meaning
SYSTem:COMMunicate: SERial:PACE	NONE XON ACK	–	Sets the handshake mode for the serial interface.
SYSTem:COMMunicate: SERial:PACE?	–	NONE XON ACK	See page 2–20.
SYSTem:PRINter:FORMfeed	–	–	Releases a from feed when the printer is connected.
SYSTem:PRINter:RESet	–	–	Releases a reset when the printer is connected.
SYSTem:PRINter: SElect	EPSon HPLaserjet RSPud2_3	–	Adapts the printer interface to the corresponding printer.
SYSTem:PRINter: SElect?	–	EPS HPL RSP	See page 2–23.
SYSTem:PRESet	–	–	Sets instrument to same status as obtained with PRESET key on front panel. See page 2–16.
SYSTem:MODE	QAM	–	Selection of basic operating modes:
SYSTem:MODE?	–	QAM	QAM Demodulator

ROUTE Subsystem

Table D-4: ROUTe Commands

Command	Data	Reply data	Meaning
ROUTE:ISElect	RF IF	–	Input selection.
ROUTE:ISElect?	–	RF IF	

INPut Subsystem

Table D-5: INPut Commands

Command	Data	Reply data	Meaning
INPut:ATTenuation: AUTO	ON OFF	–	Automatic mode / manual mode for EA-module in RF input. ON: normal automatic mode OFF: manual mode
INPut:ATTenuation: AUTO?	–	ON OFF	
INPut:ATTenuation: MODE	LNOise LDISortion LSDistortion	–	Automatic mode for EA module in RF input. IGN: Manual or normal automatic mode LNO: Autom. low noise LDIS: Autom. low Distortion LSD: Autom. lowest distortion
INPut:ATTenuation: MODE?	–	IGN LNO LDIS LSD	
INPut:ATTenuation	dd {dB}	–	Entry of data for RF attenuator. Useful only if INP:ATT:AUTO = OFF (0 to 55 dB, step width 5 dB).
INPut:ATTenuation?	–	dd {dB} *	
INPut:GAIN: STATE	ON OFF bzw. 1 0	–	RF preamplifier. Useful only with INP:ATT:AUTO = OFF.
INPut:GAIN: STATE?	–	1 0	

* Data are sent without unit.

SENSe Subsystem

Table D–6: SENSe Commands

Command	Data	Reply data	Meaning
SENSe:FREQuency: CENTer	ddd.d {Hz} (Hz kHz MHz GHz)	– ddd.d {Hz}	Setting of RF frequency 30.0 to 900.0 (default unit Hz)
SENSe:FREQuency: CENTer?	–	*	Query in Hz, data not being sent with unit
SENSe:FREQuency:SEARch LEVel	dd.d {dB} –	– dd.d {dB}	Entry of threshold for RF search
SENSe:FREQuency:SEARch LEVel?	–	*	
SENSe:QAM: BERate	INTern EXTern –	– INT EXT	Selection of the source for the BER integration interval: internal/external See page 2–34.
SENSe:QAM: BERate: INTegration	dddd –	– dddd	Selection of the BER integration over 1, 10, 100, 1000 samples. See page 2–34.
SENSe:QAM: BERate: INTegration?	–	–	
SENSe:QAM:FILTer: SAW	MHZ2 MHZ4 MHZ8 OFF –	– MHZ2 MHZ4 MHZ8 OFF	Filter selection for QAM SAW-filter See page 2–30.
SENSe:QAM:FILTer: SAW?	–	–	
SENSe: QAM:MEASure	CDiagram SPECtrum EPattern IMPairments NORMal –	– CD SPEC EPAT IMP NORM	Selection of measurement type in QAM mode: Normal Constellation Diagram Spectrum Echo Pattern Impairments See page 2–46.
SENSe: QAM:MEASure?	–	–	

* Data are sent without unit.

Table D-6: SENSE Commands (Cont.)

Command	Data	Reply data	Meaning
SENSe:QAM: NOISe:MODE	ON OFF	–	QAM mode ADD NOISE on/off
SENSe:QAM: NOISe:MODE?	–	ON OFF	See page 2-46.
SENSe:QAM: NOISe	dd.d {dB}	–	QAM mode ADD NOISE
SENSe:QAM: NOISe?	–	dd.d {dB}	Set value (6.0 to 62.0 dB)
		*	See page 2-46.
SENSe:QAM: CD:INTEgration	NORMal MAXH FREeze	–	Setting the type of integration for the QAM constellation diagram.
SENSe:QAM: CD:INTEgration?	–	NORM MAXH FRE	See page 2-46.
SENSe:QAM: CD:INTEgration:TIME	dddd.dd (s)	–	Setting the integration time for the QAM constellation diagram.
SENSe:QAM: CD:INTEgration:TIME?	–	dddd.dd {s}	(2 to 1000 ms)
		*	See page 2-46.
SENSe:QAM: CD:INTEgration:COUNT	dddd	–	Setting the integration time for the QAM constellation diagram.
SENSe:QAM: CD:INTEgration:COUNT?	–	dddd	(2 to 1000 ms)
		*	See page 2-46.
SENSe:QAM: EQUalizer: MODE	AUTO FREeze OFF	–	Setting the equalizer for QAM
SENSe:QAM: EQUalizer: MODE?	–	AUTO FRE OFF	See page 2-34.
SENSe:QAM: EQUalizer: CENTral:TAB	dd	–	Position of central coefficient
SENSe:QAM: EQUalizer: CENTral:TAB?	–	dd	(Ranch 0 to 23)
			See page 2-34.

* Data are sent without unit.

Table D-6: SENSE Commands (Cont.)

Command	Data	Reply data	Meaning
SENSe:QAM: ROLLoff	R015 R020 R025 R030	–	Setting the rolloff factor for QAM.
SENSe:QAM: ROLLoff?	–	R015 R020 R025 R030	See page 2–34.
SENSe:QAM:ORDER: MODE	AUTO MANUAL	–	Setting the QAM mode (order)
SENSe:QAM:ORDER: MODE?	–	AUTO MAN	See page 2–30.
SENSe:QAM: ORDER	ddd	–	Setting the QAM order:
SENSe:QAM: ORDER?	–	ddd	4, 16, 32, 64, 128, 256 (setting the AUTO mode not useful) See page 2–30.
SENSe:QAM: SYMBOLrate:VALue	d.ddd {MSPS}	–	Setting the symbol rate that can be received
SENSe:QAM: SYMBOLrate:VALue?	–	d.ddd {MSPS} *	(1.000 to 7.000 MSPS) See page 2–30.
SENSe:QAM: SYMBOLrate:UPPer_limit	d.ddd {MSPS}	–	Setting the upper limit of the symbol rate that can be received
SENSe:QAM: SYMBOLrate:UPPer_limit?	–	d.ddd {MSPS} *	(1.000 to 7.000 MSPS) See page 2–30.
SENSe:QAM: SYMBOLrate:LOWer_limit	d.ddd {MSPS}	–	Setting the lower limit of the symbol rate that can be received
SENSe:QAM: SYMBOLrate:LOWer_limit?	–	d.ddd {MSPS} *	(1.000 to 7.000 MSPS) See page 2–30.
SENSe:QAM: SYMBOLrate:AUTO:START	–	–	One-time call at the conclusion of the automatic symbol rate received
SENSe:QAM: SYMBOLrate:AUTO:START?	–	ON OFF	Within the UPPer, LOWer – limit See page 2–31.

* Data are sent without unit.

Table D-6: SENSE Commands (Cont.)

Command	Data	Reply data	Meaning
SENSe:QAM: SYMBOLrate:AUTO:STOP	-	-	Interrupt of the automatic symbol rate received
SENSe:QAM: SYMBOLrate:AUTO:STOP?	-	-	(1.000 ... 7.000 MSPS) See page 2-31.
SENSe:QAM: LOOP:BWIDTh	HI MED LO	-	Setting the QAM loop bandwidth
SENSe:QAM: LOOP:BWIDTh?	-	HI MED LO	See page 2-34.
SENSe:QAM: RSDecoder	ON OFF	-	Setting the QAM-Reed Solomon decoder
SENSe:QAM: RSDecoder?	-	ON OFF	See page 2-34.
SENSe:QAM:MPEG	188 204	-	Selecting whether the MPEG transport stream output is made of 188 or 204 bytes incl. The 16 protection bytes.
SENSe:QAM:MPEG?	-	188 204	See page 2-30.
SENSe:QAM: ERRor:INDication	ON OFF	-	Validation of the error indication bit in the MPEG frame
SENSe:QAM: ERRor:INDication?	-	1 0	See page 2-34.
SENSe:QAM: IQ:INVersion	NORMAL INVerted AUTO	-	Exchange of the I/Q data stream in dependence on the MPEG2 sync word
SENSe:QAM: IQ:INVersion?	-	NORM INV AUTO	
SENSe:QAM: MPEG:PLL	ON OFF	-	
SENSe:QAM: MPEG:PLL?	-	1 0	

MEMory Subsystem

Table D-7: MEMory Commands

Command	Data	Reply data	Meaning
MEMory:FREQuency: STO	ddd,TTTTTTTT	–	Storing the RF frequency (0 to 99) with text (8 characters, upper case letters or numbers)
MEMory:FREQuency: RCL	ddd	–	Calling a stored RF frequency (0 to 99)

UNIT Subsystem

Table D-8: UNIT Commands

Command	Data	Reply data	Meaning
UNIT:LEVel: POWer	DBPW DBM DBUV MV –	– DBPW DBM DBUV MV	Selection of level unit See page 2-19.
UNIT:LEVel: POWer?			Query of level unit

READ Subsystem

Table D-9: READ Commands

Command	Data	Reply data	Meaning
READ:RF:LEVel?	–	ddd.d (Unit as UNIT:LEV: POW)	Query of the RF level measured value.
READ:FREQuency: RF[:CARRier]?	–	ddd.d {Hz} *	QAM: Center frequency
READ:FREQuency: RF:OFFSet?	–	ddd.d {Hz} *	Query of the carrier frequency offset (0.0 ... 50.0 kHz) of QAM See page 2-46.
READ:LEVel:IF?	–	ddd.d {PCT}	Query of the IF level
READ:SIGNal:RF?	–	NORF UND OVER OK	Query if RF signal is applied. See page 2-11.
READ:QAM: BERate?	–	d.d E-d	Query of the bit error rate with QAM See page 2-31 .
READ:QAM: FRAMe:LOCKed?	–	1 0	Query whether MPEG frame sync word has been found. See page 2-46.
READ:QAM: CLOCK:LOCKed?	–	1 0	Query whether symbol clock recovery has locked. See page 2-46.
READ:QAM: CARRier:LOCKed?	–	1 0	Query whether carrier recovery has locked. See page 2-46.
READ:QAM: SRATe?	–	dd.dd {MSPS} *	Query of the symbol rate with QAM See page 2-31.
READ:QAM: EAQualizer:LOCKed?	–	1 0	Query if the equalizer is locked with QAM (locked / unlocked) See page 2-31.
READ:QAM: IMResponse?	–	1 0	Query of the receive position with QAM (inverted / not inverted) See page 2-31.

* Data are sent without unit.

Table D-9: READ Commands (Cont.)

Command	Data	Reply data	Meaning
READ:QAM: MER?	EFF PEAK DB	dd.d {PCT/db} *	Query of the effective / maximum vector error amplitude with QAM (measured value available only with setting: SENS:QAM:MEAS = IMP) See page 2-46.
READ:QAM: IQ:IMBalance?	-	dd.dd {PCT} *	Query of the I / Q imbalance with QAM (measured value available only with setting: SENS:QAM:MEAS = IMP) See page 2-46.
READ:QAM: IQ:PHError?	-	dd.dd {grd} *	Query of the I / Q Phase error with QAM (measured value available only with setting: SENS:QAM:MEAS = IMP) See page 2-46.
READ:QAM: CARRier:SUPPRession?	-	dd.d {dB} *	Query of the carrier suppression with QAM (measured value available only with setting: SENS:QAM:MEAS = IMP) See page 2-46.
READ:QAM: SIGNal:INTerference?	-	dd.d {dB} *	Query of the signal interference with QAM (measured value available only with setting: SENS:QAM:MEAS = IMP) See page 2-46.

* Data are sent without unit.

Table D-9: READ Commands (Cont.)

Command	Data	Reply data	Meaning
READ:QAM: PNOise?	–	dd.d {grd RMS} *	Query of the average phase noise with QAM (measured value available only with setting: SENS:QAM:MEAS = IMP) See page 2-46.
READ:QAM: SIGNal:NOISe?	–	dd.d {dB} *	Query of the QAM signal / noise ratio (measured value available only with setting: SENS:QAM:MEAS = IMP) See page 2-46.
READ:QAM: COMPression?	–	dd.dd {PCT}	Query of amplitude non-linearity of the the total transmission path. See page 2-46.
READ:ALARm: QAM:RF:LEVel?	–	1 0	Indication if failure threshold for QAM RF-level alarm is presently underranged See page 2-38.
READ:ALARm: QAM:BERate?	–	1 0	Indication if error threshold for BER-QAM is presently overranged See page 2-38.
READ:ALARm: QAM:SYNChron?	–	1 0	Indication if QAM synchronization has presently failed See section 2.5.7.
READ:ALARm: QAM:DERRor?	–	1 0	Indication if a QAM data error has presently occurred See .page 2-38
READ:ALARm: QAM:RF:LEVel?	–	1 0	Response whether RF level is below error threshold. See page 2-38.
READ:ALARm: LINE?	ddd	40 ASCII characters	Output of line ddd of alarm register to IEC/IEEE-bus controller. See page 2-38.

* Data are sent without unit.

Table D-9: READ Commands (Cont.)

Command	Data	Reply data	Meaning
READ:ALARm: LINE: ACTual?	–	ddd	Output of number of line last entered in alarm register. See page 2–38.
READ:ALARm:STATISTICS?	–	8 lines with 40 ASCII characters each	Output of statistical information. See page 2–38.

* Data are sent without unit.

CONFigure Subsystem

Table D-10: CONFigure Commands

Command	Data	Reply data	Meaning
CONFigure:ALARm: QAM:RF:LEVel: STATe	ON OFF –	– 1 0	Mask for QAM RF-level alarm on / off. See page 2–38.
CONFigure:ALARm: QAM:RF:LEVel: STATe?			
CONFigure:ALARm: QAM:BERate: STATe	ON OFF –	– 1 0	Mask for QAM BER on / off. See page 2–38.
CONFigure:ALARm: QAM:BERate: STATe?			
CONFigure:ALARm: QAM:SYNChron: STATe	ON OFF –	– 1 0	Mask for QAM synchronization alarm on / off. See page 2–38.
CONFigure:ALARm: QAM:SYNChron: STATe?			

Table D-10: CONFigure Commands (Cont.)

Command	Data	Reply data	Meaning
CONFigure:ALARm: QAM:DERRor: STATE	ON OFF -	- 1 0	Mask for data error alarm with QAM on / off. See page 2-38.
CONFigure:ALARm: QAM:DERRor: STATE?			
CONFigure:ALARm: QAM:RF:LEVel: STATE	ON OFF -	- 1 0	Mask for RF level threshold in QAM mode on/off. See page 2-38.
CONFigure:ALARm: QAM: RF:LEVel: STATE?			
CONFigure:ALARm: QAM:BEEP: SYNc:CLOCK: STATE	ON OFF -	- 1 0	Mask for beeper clock sync lost on / off. See page 2-30.
CONFigure:ALARm: QAM:BEEP: SYNc:CLOCK: STATE?			
CONFigure:ALARm: QAM:BEEP: SYNc:EQUalizer: STATE	ON OFF -	- 1 0	Mask for beeper equalizer sync lost on / off. See page 2-30.
CONFigure:ALARm: QAM:BEEP: SYNc:EQUalizer: STATE?			

Table D-10: CONFigure Commands (Cont.)

Command	Data	Reply data	Meaning
CONFigure:ALARm: QAM:BEEP: SYNc:CARRier: STATe	ON OFF –	– 1 0	Mask for beeper carrier sync lost on / off. See page 2-30.
CONFigure:ALARm: QAM:BEEP: SYNc:CARRier: STATe?	ON OFF –	– 1 0	Mask for beeper frame sync lost on / off. See page 2-30.
CONFigure:ALARm: QAM:BEEP: DERRor: STATe	ON OFF –	– 1 0	Mask for beeper MPEG data error on / off. See page 2-30.
CONFigure:ALARm: QAM:BEEP: DERRor: STATe?	ON OFF –	– 1 0	Mask for beeper MPEG data error on / off. See page 2-30.

Table D-10: CONFigure Commands (Cont.)

Command	Data	Reply data	Meaning
CONFigure:ALARm: QAM:BEEP: CORRection: STATe	ON OFF –	– 1 0	Mask for beeper MPEG data correction on / off. See page 2-30.
CONFigure:ALARm: QAM:BEEP: CORRection: STATe?			
CONFigure:ALARm: QAM:RF:LEVel	ddd.dd (Unit as UNIT:LEV:POW)	– ddd.dd	Failure threshold for QAM RF-level alarm
CONFigure:ALARm: QAM:RF:LEVel?	–	(Unit as UNIT:LEV:POW) *	See page 2-38. (command not complying with SCPI)
CONFigure:ALARm: QAM:BERate	ddE-d –	– ddE-d	Failure threshold for QAM BER
CONFigure:ALARm: QAM:BERate?			See page 2-38.
CONFigure:ALARm:RESet	–	–	Erasing the alarm register and the statistical information.

* Data are sent without unit.

HCOPy Subsystem

Table D–11: HCOPy Commands

Command	Data	Reply data	Meaning
HCOPy[:IMMEDIATE]	–	–	Releasing the printing operation See page 2–17.
HCOPy:ABORT	–	–	Termination of printing See page 2–17.
HCOPy:ALARM: STATISTICS	–	–	Printing of statistical information. See page 2–38.
HCOPy:ALARM: LAST	ddd	–	Printing of last lines ddd of alarm register. See page 2–38.
HCOPy:ALARM: LINES	ddd,eee	–	Printing of lines ddd to eee of alarm register. See page 2–38.
HCOPy:ALARM: ACTUAL HCOPy:ALARM: ACTUAL?	ON OFF bzw. 1 0 –	– 1 0	Continuous output of current alarm lines. See page 2–38.

Appendix E: Programming Examples

The following examples can be used as a basis for solving complex programming tasks.

The programming language used is QuickBASIC. It is also possible to translate the programs into other programming languages.

QuickBasic must be started from the directory in which it is installed using the following command:

```
QB /L QBIB.QLB
```

Incorporating IEC/IEEE-Bus Library for QuickBASIC

```
REM ***** IEC-Bus-Bibliothek für QuickBASIC einbinden *****  
'$INCLUDE: 'c:\qbasic\qbdecl.bas'
```

Initialization and Initial Status

When a program is started, both the IEC/IEEE bus and the device settings are set to a defined status using the subroutines InitController and InitDevice.

Initialization of Controller

```
REM ***** Initializes controller *****  
REM InitController  
iecaddress% = 6           'IEC/IEEE-bus address of  
                           device  
CALL IBFIND("DEV1", efa%) 'Opens channel to device  
CALL IBPAD(efa%, iecaddress%) 'Transfers device address to  
                               controller  
CALL IBTMO(efa%, 13)      'Sets response time to 10 s  
REM *****
```

Initialization of Device

IEC/IEEE-bus Status Register and DDS200 settings are brought to a defined status.

```
REM ***** Initializes device *****  
REM InitDevice  
CALL IBWRT(efa%, "*CLS")  'Resets Status Register  
CALL IBWRT(efa%, "*RST")  'Resets device  
REM *****
```

Sending Device Setting Commands

In this example, the input frequency and RF-level control are set.

```
REM ***** Device setting commands *****
CALL IBWRT(efa%, "SENS:FREQ:CENT 454.25")      'RF frequency to
                                                454.25 MHz
CALL IBWRT(efa%, "INP:ATT:AUTO ON")           'Attenuator control
                                                'automatic
REM *****
```

Switchover to Manual Control

```
REM ***** Switches device to manual control *****
CALL IBLOC(efa%)                              'Sets device to local
REM *****
```

Readout of Device Settings

The settings of example 3 are read out using commands in short form.

```
REM ***** Reads out device settings *****
FRequenz$ = SPACE$(20)                        'Activates text variable
                                                (20 characters)
CALL IBWRT(efa%, " SENS:FREQ:CENT?")         'Calls for frequency
                                                setting
CALL IBRD(efa%, FRequenz$)                   'Reads in value
EAmode$ = SPACE$(20)                          'Activates text variable
                                                (20 characters)
CALL IBWRT(efa%, " INP:ATT:AUTO?")           'Calls for attenuator
                                                control mode
CALL IBRD(efa%, EAmode$)                     'Reads in value
REM ***** Displays values on screen *****
PRINT "RF-Frequenz (MHz): ";FRequenz$
PRINT "RF-Regl-Mode:      ";EAmode$,
REM*****
```

List Management

Not used in the DDS200 Digital Demodulation System.

Command Synchronization

The different synchronization modes stated in the following example are described in *Command Sequence and Synchronization* on page 3–18.

```

REM ***** Examples of command synchronization *****
REM The execution time of command INP:ATT:AUTO is relatively long
REM (more than 3 s). This delay shall guarantee that the next command is
REM only executed after the settling time of the attenuator is over.

REM ***** Mode 1: Use of *WAI *****
CALL IBWRT(efa%, "INP:ATT:AUTO ON; *WAI; :SENS:FREQ:CENT 100MHZ")

REM ***** Mode 2: Use of *OPC? *****
OpcOk$ = SPACE$(2)           'Provides space for *OPC? response
CALL IBWRT(efa%, "INP:ATT:AUTO ON; *OPC?")
REM ***** Here, the controller may control other devices *****
CALL IBRD(efa%, OpcOk$)      'Waits for "1" from *OPC?

REM ***** Mode 3: Use of *OPC *****
REM To enable the Service Request function when using a GPIB driver from
REM National Instruments, the "Disable Auto Serial Poll" setting has to be
REM changed to "yes" by means of IBCONF.

CALL IBWRT(efa%, "*SRE 32")  'Enables Service Request for ESR
CALL IBWRT(efa%, "*ESE 1")  'Sets Event Enable bit for
                             'Operation Complete bit
ON PEN GOSUB OpcReady       'Initializes Operation Complete routine
PEN ON
CALL IBWRT(efa%, "INP:ATT:AUTO ON; *OPC")
REM Continues main program in an endless loop.
STOP                        'End of program

OpcReady:
REM When the attenuator is settled, this subroutine is branched to.
REM Programming of suitable response to OPC Service Request.
RETURN
REM *****

```

Service Request

The Service Request routine requires an extended device initialization during which the corresponding bits of the Transition and Enable Registers are set. To enable the Service Request function when using a GPIB driver from National Instruments, the "Disable Auto Serial Poll" setting of the driver has to be changed to "yes" by means of IBCONF. In this example the commands are used in short form.

```
'$INCLUDE: 'c:\qbasic\qbdecl.bas'      'Includes driver
CLS                                     'Clears controller screen
CALL IBFIND("DEV1", efa%)              'Opens channel to device
CALL IBPAD(efa%, 6)                     'Transfers device address to
                                         'controller
CALL IBTMO(efa%, 12)                    'Sets response time to 3 s

REM ***** Example of SRQ initialization for messages *****
CALL IBWRT(efa%, "*CLS")                'Resets Status Reporting
                                         'System and clears output
                                         'buffer
CALL IBWRT(efa%, "*SRE 168")            'Enables Service Request
                                         'for 'STAT:OPER,STAT:QUES
                                         'and ESR Registers
CALL IBWRT(efa%, "*ESE 60")             'Sets Event Enable bit for
                                         'Command Execution,
                                         'Device-Dependent
                                         'and Query Error
CALL IBWRT(efa%, "STAT:OPER:ENAB 32767") 'Sets OPERATION Enable
                                         'bit for all events
CALL IBWRT(efa%, "STAT:OPER:PTR 32767") 'Sets associated bits of
                                         'OPERation
                                         'PTRansition and
CALL IBWRT(efa%, "STAT:OPER:NTR 32767") 'Ntransition
CALL IBWRT(efa%, "STAT:QUES:ENAB 32767") 'Sets Questionable
                                         'Enable bits for all
                                         'events
CALL IBWRT(efa%, "STAT:QUES:PTR 32767") 'Sets associated bits of
                                         'Questionable
                                         'PTRansition
GOSUB Srq                               'Changes to Service
PEN ON                                   'Request Routine
DO
LOOP                                     'Endless loop
REM Continues main program using endless loop. The srq subroutine
REM waits for an interrupt and, in this case, starts automatically.
STOP
```

A Service Request is then processed in the Service Request Routine.

NOTE. The variables *EFA%* and *EFAN%* must be assigned meaningful values.

```

REM ***** Service Request Routine *****
Srq:
CLS                                     'Clears controller screen
DO
  SRQFOUND% = 0
  FOR I% = EFA% TO EFAN%               'Queries all bus users
    ON ERROR GOTO noTeilnehmer         'No bus user available
    GOSUB Operationstatus
    CALL IBRSP(I%, STB%)               'Reads Serial Poll, Status
                                        'Byte
    IF STB% > 0 THEN                   'This device has bits set
                                        'in STB
      SRQFOUND% = 1
      IF (STB% AND 16) > 0 THEN GOSUB Outputqueue
      IF (STB% AND 4) > 0 THEN GOSUB Failure
      IF (STB% AND 8) > 0 THEN GOSUB Questionablestatus
      IF (STB% AND 128) > 0 THEN GOSUB Operationstatus
      IF (STB% AND 32) > 0 THEN GOSUB Esrread
    END IF
  noTeilnehmer:
  NEXT I%
  LOOP UNTIL SRQFOUND% = 0
  ON ERROR GOTO Fehlerbehandlung
  ON PEN GOSUB Srq: RETURN              'Reactivates SRQ Routine
                                        'End of SRQ Routine

```

Readout of Status Event Registers, output buffer and error/event queue is carried out in subroutines.

```

REM ***** Subroutines for single STB bits *****
Outputqueue:                             'Reads output buffer
Nachricht$ = SPACE$(100)                 'Provides space for response
CALL IBRD(efa%, Nachricht$)
PRINT " Message in output buffer :"; message$
RETURN

Failure:                                  'Reads error queue
ERROR$ = SPACE$(100)                     'Provides space for error variable
CALL IBWRT(efa%, "SYST:ERR?")
CALL IBRD(efa%, ERROR$)
PRINT "Fehlertext :"; ERROR$
RETURN

Questionablestatus:                       'Reads Questionable Status Register
Ques$ = SPACE$(20)                        'Preallocates text variable using
                                        'spaces

CALL IBWRT(efa%, "STAT:QUES:EVEN?")
CALL IBRD(efa%, Ques$)
IF (VAL(Ques$) AND 16384) > 0 THEN PRINT "STAT-QUES-REG 14"
IF (VAL(Ques$) AND 8192) > 0 THEN PRINT " STAT-QUES-REG 13"
IF (VAL(Ques$) AND 4096) > 0 THEN PRINT " STAT-QUES-REG 12"
IF (VAL(Ques$) AND 2048) > 0 THEN PRINT " STAT-QUES-REG 11"

```

```

IF (VAL(Ques$) AND 1024) > 0 THEN PRINT " STAT-QUES-REG 10"
IF (VAL(Ques$) AND 512) > 0 THEN PRINT " STAT-QUES-REG 9"
RETURN

Operationstatus:                                'Reads Operation Status Register
Oper$ = SPACE$(20)                              'Preallocates text variable using
                                                'spaces
CALL IBWRT(efa%, "STAT:OPER:EVENT?")           'Clears register on
                                                'reading
CALL IBRD(efa%, Oper$)                          'and rejects value
Oper$ = SPACE$(20)                              'Preallocates text variable using
                                                'spaces

CALL IBWRT(efa%, "STAT:OPER:COND?")
CALL IBRD(efa%, Oper$)
IF (VAL(Oper$) AND 16) > 0 THEN PRINT "Event STAT-OPER-REG not yet
terminated."
IF (VAL(Oper$) AND 16) = 0 THEN PRINT " Event STAT-OPER-REG not yet
terminated."
RETURN

Esrread:                                         'Reads Event Status Register
Esr$ = SPACE$(20)                               'Preallocates text variable using
                                                'spaces
CALL IBWRT(efa%, "*ESR?")                       'Reads ESR
CALL IBRD(efa%, Esr$)
IF (VAL(Esr$) AND 1) > 0 THEN PRINT "Operation complete"
IF (VAL(Esr$) AND 4) > 0 THEN GOTO Failure
IF (VAL(Esr$) AND 8) > 0 THEN PRINT "Device-dependent error"
IF (VAL(Esr$) AND 16) > 0 THEN GOTO Failure
IF (VAL(Esr$) AND 32) > 0 THEN GOTO Failure
IF (VAL(Esr$) AND 64) > 0 THEN PRINT "User request"
IF (VAL(Esr$) AND 128) > 0 THEN PRINT "Power on"
RETURN

REM ***** Error routine *****
Fehlerbehandlung:
PRINT "ERROR"                                  ' Outputs error message
STOP                                           ' Stops software
REM *****

```

Appendix F: Remote Control via RS-232-C Interface

Setting the Transmission Parameters

To ensure error-free and correct data transmission, the parameters of the DDS200 Digital Demodulation System and the controller must be set to the same values. They can be varied manually in the SETUP\REMOTE\RS232 menu.

Transmission parameters of the interface are factory-set to the following configuration:

Baud rate	= 9600,
bits	= 8,
parity	= NONE,
stop bits	= 1
printout	= NONE

Displays in Remote Control

The remote-control status can be seen by the LEDs REM and LLO in the STATE signal field. In the REMOTE status, all readouts appear on the screen.

Return to Manual Control

Manual control can be selected again from the front panel or via the RS-232 interface.

Manual:

1. Press any key: The LOCAL / REMOTE menu appears.
2. Press **LOCAL** softkey.

NOTE. Command processing must be completed prior to the switchover as otherwise the device would be switched back immediately to remote control.

To prevent unintended switchover to LOCAL, switchover can be disabled by the control character <CTRL L> (= 0C hex) sent via the RS-232 interface. In this case switchover to manual operation is only possible via the RS-232 interface. LLO is displayed on the screen.

Lock-out of the LOCAL switchover can be cleared by sending <Ctrl L> (= 0C hex) again via the RS-232-C interface.

Set device to manual operation via RS-232-C interface:

```
v24putc(port,0x12)
```

Characteristics of Interface

- Serial data transmission in asynchronous mode
- Bidirectional data transmission via two separate lines
- Transmission rate selectable between 1200 and 19200 bauds
- Signal level logic '0' from +3 to +15 V
- Signal level logic '1' from -15 to -3 V
- Connection of external device (controller) possible
- Software handshake (XON, XOFF)
- Hardware handshake (RTS, CTS)

Table F-1: Pin assignment of RS-232-C interface

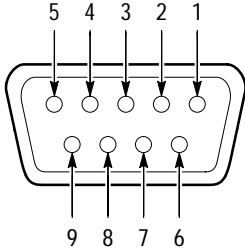
	Pin No.	Signal Line
	1	DCD
	2	RxD
	3	TxD
	4	DTR
	5	GND
	6	DSR
	7	RTS
	8	CTS
	9	RI

Signalling Lines

- RxD (Receive Data),
Data line; transmission from controller to EFA.
- TxD (Transmit Data),
Data line; transmission from EFA to controller.

DTR	(Data terminal ready), Output (logic '0' = active); controller informs EFA via DTR that RS-232 interface is active. DTR remains active as long as interface is switched for remote control.
GND	(Ground), Interface ground connected to instrument ground.
DSR	(Data set ready), Input (logic '0' = active); DSR not used in EFA.
RTS	(Request to send), Output (logic '0' = active); EFA informs the controller via RTS that it is ready to accept data. If RTS is active, EFA is ready to receive a character.
CTS	(Clear to send), Input (logic '0' = active); CTS controls the data output of EFA. If CTS is active, EFA is ready to output data.

Transmission Parameters

To ensure error-free and correct data transmission, the parameters of the DDS200 and the controller must be set to the same values. Setting is made in the `SETUP \ REMOTE \ RS232` menu. Parameters in bold type indicate the basic setting made at the factory.

Transmission rate (baud rate)	The DDS200 has 5 different baud rates: 1200, 2400, 4800, 9600, 19200.
Data bits	Data are transmitted in 7- or 8-bit ASCII code. The LSB (least significant bit) is the first bit transmitted.
Start bit	Each data byte begins with a start bit. The trailing edge of the start bit indicates the beginning of the data byte.
Parity bit	A parity bit can be transmitted for error correction. There are three possibilities: no, even or odd parity. In addition, the parity bit can be set to logic '0' or logic '1'.
Stop bits	The transmission of a data byte can be terminated by one or two stop bits.

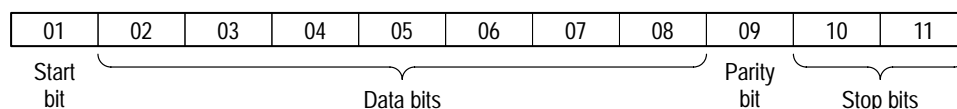

Figure F-1: Transmission of character **A** in 7-bit ASCII code, even parity, 2 stop bits

Interface Functions

The interface is controlled by means of several control characters from the ASCII code range 0 to 20 hex. These control characters are transmitted via the interface (see Table F-2).

Table F-2: Control characters of RS-232 Interface

Designation	Control character	Function
REMC_char	<Ctrl R> 12 hex	Remote/local switchover This character enables switchover between the modes LOCAL and REMOTE.
LOKC_char	<Ctrl L> 0C hex	Local Lockout Switchover This character enables or disables switchover to the LOCAL state.
SRQ_char	<Ctrl B> 02 hex	Service Request (SRQ) This character is sent if bit 6 of the status byte is set. Should the character SRQ_char be received, it will be ignored.
GET_char	<Ctrl G> 07 hex	Group Execute Trigger (GET) This character is not permitted within a data string and will cause an error message. Outside a data string, ie after a terminator or after DCL, GET_char will produce DEVICE TRIGGER. DEVICE TRIGGER is not supported.
DCL_char	<Ctrl C> 03 hex	Device Clear (DCL) Upon reception of this character, processing of the commands just received is stopped and the command processing software is set to a defined status. This character does not change the device setup.
XON_char	<Ctrl Q> 11 hex	Enables character output This character enables data transmission from the DDS200.
XOFF_char	<Ctrl S> 13 hex	Disables character output This character disables data transmission from the DDS200.
END_char	0Dhex, 0Ahex	Terminator <CR><LF>

NOTE. When block data are transmitted via the serial interface, control characters are not recognized, as it is not possible to distinguish between block data and control characters in the data stream (for block data see section 3.5.5) This means that control characters are interpreted as data bytes of the block data.

Handshake

Software Handshake

With software handshake, data transmission is controlled by the two control characters XON_char / XOFF_char:

The DDS200 signals via the control character XON_char that it is ready to receive data.

If the receive buffer is filled to capacity, the DDS200 prevents the controller from further data transmission by sending the control character XOFF_char. The controller interrupts data transmission until it receives again XON_char from the DDS200 and signals to the DDS200 that it is ready to receive data.

When block data are transmitted, software handshake is impossible due to the above reasons.

Local controller connection for Software Handshake

For software handshake, the DDS200 must be connected to the controller according to the following wiring diagram, which is applicable to controllers with 9-pin or 25-pin connectors.

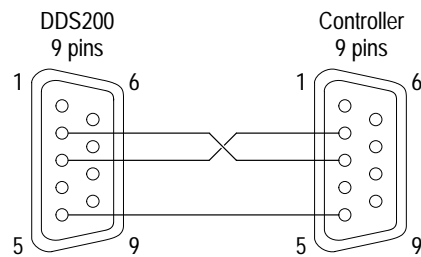

DDS200 decoder pin	Signal	Controller pin
2	RxD / TxD	3
3	TxD / RxD	2
5	GND / GND	5

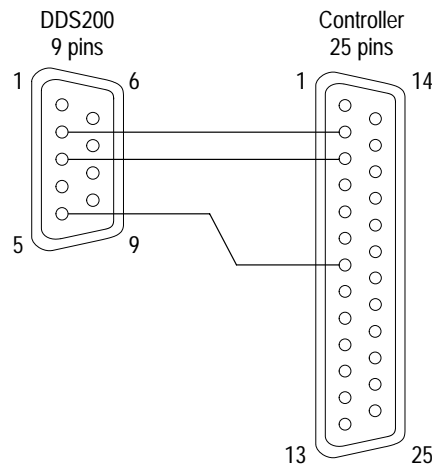

DDS200 decoder pin	Signal	Controller pin
2	RxD / TxD	3
3	TxD / RxD	2
5	GND / GND	7

Figure F-2: Wiring for software handshake

Hardware Handshake

In the case of hardware handshake, the DDS200 signals via the RTS lines that it is ready to receive data. A logic ‘0’ (active) signifies “ready”, a logic ‘1’ means “not ready”.

Via the CTS line the controller informs the DDS200 that it is ready to receive data. A logic ‘0’ activates data output whereas a logic ‘1’ commands the DDS200 to stop data transmission. The DTR line remains active (logic ‘0’) until the serial interface is switched for remote control.

Local Controller Connection for Hardware Handshake

The DDS200 is connected to a controller using a zero-modem cable. The data, control and signalling lines of this cable must be cross-connected. The following wiring diagram is applicable to controllers with 9-pin or 25-pin connectors.

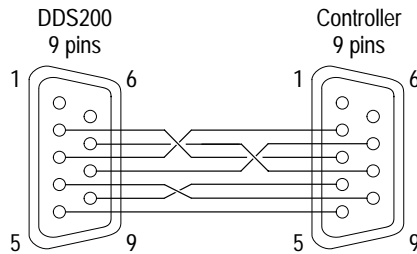

DDS200 decoder pin	Signal	Controller pin
2	RxD / TxD	3
3	TxD / RxD	2
4	DTR / DSR	6
5	GND / GND	5
6	DSR / DTR	4
7	RTS / CTS	8
8	CTS / RTS	7

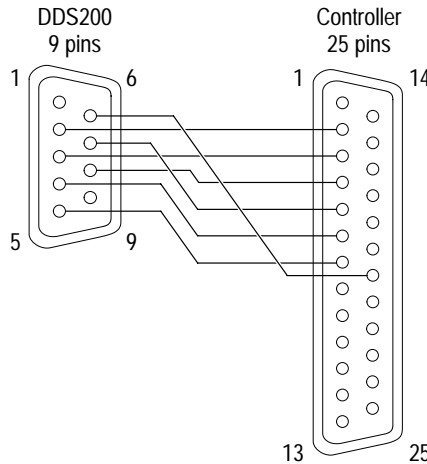

DDS200 decoder pin	Signal	Controller pin
2	RxD / TxD	2
3	TxD / RxD	3
4	DTR / DSR	6
5	GND / GND	7
6	DSR / DTR	20
7	RTS / CTS	5
8	CTS / RTS	4

Figure F-3: Wiring for hardware handshake

Index

A

- Alarm
 - clearing register, 2–45
 - configuring, 2–38
 - printing register, 2–43
 - register, 2–39
 - setting limit values, 2–41
 - statistics, 2–41
- Alarm messages, order, 2–40
- Ambient temperature, 1–2
- Application examples, manual operation, 2–62

B

- Bandwidth, loop, 2–35
- Basic operation, overview, 2–8
- Battery, replacing, 4–2
- BER
 - calculations, 2–48
 - external equipment, 2–80
 - measurement, 2–48
 - selecting integration time, 2–79
- BER integration, 2–35
- Bit Error Rate, 2–48
- Bus lines, description, B–1

C

- Carrier suppression, 2–69
- Cascading, analog and digital two demodulation systems, 2–88
- Central coefficient, 2–34
- Certifications and compliances, A–4
- Channel equalizer mode, 2–34
- Cleaning, 4–1
- Command, sequence and synchronization, 3–18
- Command identification, remote control, 3–16
- Command line structure, 3–8
- Common commands, remote control, 3–12
- CONFigure, commands, D–15
- Connecting, input and output signals, 1–15
- Constellation diagram, 2–50
 - application, 2–62
 - formulas and limit values, 2–68
 - Gate Time and Gate CNT, 2–53
 - QAM parameters, 2–54

- Contrast, 1–2
 - setting, 1–13
- Cursor keys, description, 2–13

D

- Data frame, size, 2–37
- Data output, MPEG, 2–36
- Data set, 3–17
- Date/Time menu, 2–20
- Default settings, 2–16
- Demodulator, QAM, 2–26
- Device address, setting, 3–2
- Device hardware, 3–17
- Display, overview, 2–9

E

- Echo diagram, 2–57
- Editing, text and numerals, 2–15
- Equalizer mode, 2–34
- Error bit, 2–37
- Error messages, descriptions, C–1
- Examples, programming, E–1
- Examples of Application, 2–62

F

- Factory defaults, 2–16
- Filter
 - FIR, 2–34
 - SAW, 2–31
- Firmware
 - in modules, 1–14
 - installing, 1–13
- Fuses, 1–11
 - replacing, 1–11

G

- General device settings, 2–19

H

Handshake, RS232, F-5
Hard keys, 1-3
 description, 2-18
Hardcopy key, 2-17
HCOPY, commands, D-19

I

I/Q inversion, 2-37
Initialization, programming example, E-1
INPut, commands, D-6
Input, selecting, 2-4
Input and output signals, connecting, 1-15
Installation, 1-9
Installing
 firmware, 1-13
 options, 1-16
Instrument settings, description, 2-19
Interface
 IEC/IEEE bus connector, 1-17
 RS232, 1-16
Interface characteristics, B-1
Interface functions, B-3
Interferer
 in phase jitter, 2-72
 sinusoidal, 2-69

K

Keyboard for digital data input, 1-3
Keys
 cursor, 2-13
 hard, 2-18
 hardcopy, 2-17
 mode, 2-25
 numeric, 2-14
 soft, 2-12

L

LEDs, description, 2-11
Limits, alarm, 2-41
List management, programming example, E-2
LLO, 1-3
Loop bandwidth, 2-35

M

Maintenance, 4-1
 battery, 4-2
Manual operation, 2-1
Measure menu, 2-46
MEMory, commands, D-11
memory, battery-backed, 1-15
Menu
 alarm, 2-38
 beeper, 2-33
 IEC625 IEEE488, 2-21
 input attenuation selection, 2-27
 input selection, 2-27
 measure, 2-46
 MPEG data outputs, 2-36
 printer selection, 2-23
 remote, 2-20
 RF, 2-29
 RS232, 2-22
 special function, 2-34
 status, 2-30
 symbol rate, 2-31
 Time/Date, 2-20
 units, 2-24
Menus, setting, 2-10
Messages, error, C-1
Mode, selecting, 2-3
Mode key, 2-25
Modulation error, 2-74
 limit values, 2-75
MPEG
 data frame size, 2-37
 error bit, 2-37
 outputs assignment and functions, 2-85
 parallel data PLL, 2-37
MPEG outputs, configure, 2-36

N

NICAM, 1-6
Numbers, error descriptions, C-1
Numeric keypad, description, 2-14

O

Operation, manual, 2-1
Options, installing, 1-16
Output buffer, 3-19

P

- Parallel data, frame size, 2–37
- Parallel poll, 3–27
- Parameters, remote control, 3–9
- Phase error, 2–69
- Phase Jitter, 2–72
- Power key, 1–2
- Powering on, 1–12
 - procedure, 2–2
- Preparation for use, 1–1
- Preset values, MTD200, 2–58
- Presetting, 2–16
- Printer, 1–4, 1–16
 - hardcopy key, 2–17
- Programming examples, E–1
 - initialization, E–1
 - list management, E–2
 - readout of device settings, E–2
 - sending device settings, E–2
 - service request, E–4
 - switchover to manual control, E–2

Q**QAM**

- calculated max and min values, 2–74
- default value, 2–33
- miscellaneous errors, 2–76
- order, 2–33
- selftest, 4–3

QAM demodulator, description, 2–26

Queries, 3–9

QuickBASIC, incorporating, E–1

R

READ, commands, D–12

Readout device settings, programming example, E–2

Real-time clock, 4–2

Reed Solomon decoder, 2–36

Register, SCPI status, 3–19

Remote control

- buffer, 3–16
- command identification, 3–16
- commands, 3–4
- common commands, 3–12
- CONFigure subsystem, D–15
- data set, 3–17
- device hardware, 3–17
- displays, 3–2
- HCOPy subsystem, D–19

- input, 3–16
- INPut subsystem, D–6
- interface messages, 3–4
- MEMory subsystem, D–11
- overlapping commands, 3–18
- overview, 3–1
- parameters, 3–9
- programming examples, E–1
- queries, 3–9
- READ subsystem, D–12
- return to manual control, 3–3
- ROUte subsystem, D–5
- SCPI standards, 3–11
- SCPI structure and syntax, 3–5
- SENSe subsystem, D–7
- status reporting system, 3–17
- STATus subsystem, D–2
- SYSTem subsystem, D–4
- UNIT subsystem, D–11

Resetting, status reporting system, 3–28

RF frequency, setting, 2–6

Roll off factor, 2–35

ROUte, commands, D–5

RS 232, 1–7

RS232, 1–12

- hardware and software handshake, F–5
- interface, F–2
- interface functions, F–4
- transmission parameters, F–3

RS232 interface, description, 1–16

S

S/N ratio, 2–69

SAW filter, 2–31

SCPI

- introduction, 3–5
- status register, 3–19

SCPI error messages, C–1

SCPI standard, remote control, 3–11

Selecting the input, procedure, 2–4

Selecting the mode, procedure, 2–3

Selftest, QAM, 4–3

Sending device settings, programming example, E–2

SENSe, commands, D–7

SERBUS, 1–6

Serial data, frame size, 2–37

Serial interface, RS232, 1–16

Serial poll, 3–26

Service request, programming example, E–4

Service request (SEQ), 3–26

Setting contrast, 1–13

- Setting device address, 3–2
- Setting menus, procedure, 2–10
- Setting the RF frequency, procedure, 2–6
- Settings
 - general device, 2–19
 - storing, 2–17
- Soft keys, description, 2–12
- Spectrum display, coefficients, 2–56
- STATus, commands, D–2
- Status, remote control reporting system, 3–17
- Status register
 - description, 3–23
 - diagram, 3–22
 - queries, 3–27
- Status reporting system
 - description, 3–19
 - resetting, 3–28
 - using, 3–26
- Storage, temperatures, 4–1
- Store device settings, 2–17
- Structure
 - command line, 3–8
 - remote commands, 3–5

- Subroutines, examples, E–1
- Switchover to manual control, programming, E–2
- Symbol rate, 2–31
- Syntax, remote commands, 3–5
- SYSTEM, commands, D–4

T

- Time/Date menu, 2–20
- Troubleshooting, 4–1
 - error messages, 4–3
 - selftest, 4–3
- Two digital demodulating systems, cascading, 2–88

U

- UNIT, commands, D–11

V

- Vector error, 2–74
 - limit values, 2–75

