



Yes, you can.®



## Invacare® TDX SP

**Power wheelchair  
User manual**





## How can you get in touch with Invacare®?

If you have any questions or need support, please contact your authorised Invacare® Dealer, who has the necessary know-how and equipment plus the special knowledge concerning your Invacare® product, and can offer you all-round satisfactory service. Should you wish to contact Invacare® directly, you can reach us in Europe at the following addresses and phone numbers.

<b>A</b>	<b>Invacare Austria GmbH</b> Herzog Odilostrasse 101 A-5310 Mondsee Austria	☎: Fax: @: WWW:	+43 6232 5 53 50 +43 6232 5 53 54 info@invacare-austria.com www.invacare.at
<b>B</b>	<b>Invacare n.v.</b> Autobaan 22 B-8210 Loppem (Brugge)	☎: Fax: @: WWW:	+32 (0)50 83 10 10 +32 (0)50 83 10 11 belgium@invacare.com www.invacare.be
<b>L</b>	<b>Belgium</b>		
<b>CH</b>	<b>Invacare AG</b> Benkenstraße 260 CH-4108 Witterswil Switzerland	☎: Fax: @: WWW:	+41 (0)61487 70 80 +41 (0)61487 70 81 switzerland@invacare.com www.invacare.ch
<b>D</b>	<b>Invacare GmbH</b> Alemannenstraße 10 88316 Isny Deutschland	☎: Fax: @: WWW:	+49 (0)7562 70 00 +49 (0)7562 7 00 66 kontakt@invacare.com www.invacare.de
<b>DK</b>	<b>Invacare A/S</b> Sdr. Ringvej 37 DK-2605 Brøndby Danmark	☎ (Kundeservice): Fax (Kundeservice): @: WWW:	+45 (0)36 90 00 00 +45 (0)36 90 00 01 denmark@invacare.com www.invacare.dk
<b>E</b>	<b>Invacare® SA</b> c/ Areny s/n Polígon Industrial de Celrà E-17460 Celrà (Girona) ESPAÑA	☎: Fax: @: WWW:	+34 (0)972 49 32 00 +34 (0)972 49 32 20 contactsp@invacare.com www.invacare.es

<b>F</b>	<b>Invacare® Poirier SAS</b> Route de St Roch F-37230 Fondettes <b>France</b>	☎: Fax: @: WWW:	+33 (0)247 62 64 66 +33 (0)247 42 12 24 contactfr@invacare.com www.invacare.fr
<b>GB</b>	<b>Invacare® Ltd</b> Pencoed Technology Park Pencoed Bridgend CF35 5AQ United Kingdom	☎ (Customer services): Fax (Customer services): @: WWW:	+44 (0)1656 77 62 22 +44 (0)1656 77 62 20 uk@invacare.com www.invacare.co.uk
<b>I</b>	<b>Invacare Mecc San s.r.l.</b> Via dei Pini, 62 I - 36016 Thiene (VI) <b>ITALIA</b>	☎: Fax: @: WWW:	+39 0445 38 00 59 +39 0445 38 00 34 italia@invacare.com www.invacare.it
<b>IE</b>	<b>Invacare Ireland Ltd.</b> Unit 5 Seatown Business Campus Seatown Rd, Swords County Dublin <b>Ireland</b>	☎: Fax: @: WWW:	+353 18 10 70 84 +353 18 10 70 85 ireland@invacare.com www.invacare.ie
<b>N</b>	<b>Invacare® AS</b> Grensesvingen 9 Postboks 6230 Etterstad N-0603 Oslo <b>Norge</b>	☎ (Kundeservice): Fax (Kundeservice): @: @: WWW:	+47 (0)22 57 95 00 +47 (0)22 57 95 01 norway@invacare.com island@invacare.com www.invacare.no
<b>NL</b>	<b>Invacare® B.V.</b> Celsiusstraat 46 NL-6716 BZ Ede <b>Nederland</b>	☎: Fax: @: @: WWW:	+31 (0)318 69 57 57 +31 (0)318 69 57 58 nederland@invacare.com csede@invacare.com www.invacare.nl
<b>P</b>	<b>Invacare Lda</b> Rua Estrada Velha, 949 P-4465-784 Leça do Balio Portugal	☎: ☎: Fax: @: WWW:	+351 225 10 59 46 +351 225 10 59 47 +351 225 10 57 39 portugal@invacare.com www.invacare.pt



**Aterförsäljare:**  
**Invacare® AB**  
Fagerstagatan 9  
S-163 91 Spånga  
**Sverige**

☎ (Kundtjänst): +46 (0)8 761 70 90  
Fax (Kundtjänst): +46 (0)8 761 81 08  
@: sweden@invacare.com  
@: finland@invacare.com  
WWW: www.invacare.se



**Tillverkare:**  
**Invacare® Deutschland GmbH**  
Kleiststraße 49  
D-32457 Porta Westfalica  
**Deutschland**

MÖLNDAL  
☎: +46 (0)31 86 36 00  
Fax: +46 (0)31 86 36 06  
@: ginvacare@invacare.com

LANDSKRONA  
☎: +46 (0)418 2 85 40  
Fax: +46 (0)418 1 80 89  
@: linvacare@invacare.com

OSKARSHAMN  
☎: +46 (0)491 1 01 40  
Fax: +46 (0)491 1 01 80  
@: oinvacare@invacare.com

---

**Eastern  
european  
countries**

**European Distributor  
Organisation (EDO)**  
Kleiststraße 49  
D-32457 Porta Westfalica  
**Deutschland**

☎: +49 (0)5731 75 45 40  
Fax: +49 (0)5731 75 45 41  
@: edo@invacare.com  
WWW: www.invacare.de

---

# Table of Contents

Chapter		Page
<b>1</b>	<b>Introduction</b>	<b>12</b>
1.1	Important symbols in this manual .....	13
1.2	Important symbols found on the vehicle .....	15
1.2.1	Explanation of symbols on lifter warning sticker .....	17
1.3	Type classification and permissible use .....	18
1.4	Indications .....	18
1.5	Usability .....	19
1.6	Warranty .....	20
1.7	Life expectancy .....	20
<b>2</b>	<b>Safety notes</b>	<b>21</b>
2.1	General safety notes .....	21
2.2	Safety information with regard to care and maintenance .....	24
2.3	Safety information on electromagnetic interference .....	25
2.4	Safety information on driving and freewheel mode .....	26
2.5	Safety information on maintenance work and alterations to the wheelchair .....	28
2.6	Safety information on wheelchairs with a lifter .....	30
<b>3</b>	<b>Key features</b>	<b>32</b>
<b>4</b>	<b>Getting in and out of the wheelchair</b>	<b>33</b>
4.1	Remove the standard armrest in order to side transfer .....	33
4.2	Raise the parallel sliding armrest / remove the skirtguard (optional) .....	34
<b>5</b>	<b>Driving</b>	<b>36</b>

5.1	<b>Before driving for the first time</b> .....	<b>36</b>
5.2	<b>Parking and stationary</b> .....	<b>37</b>
5.3	<b>Taking Obstacles</b> .....	<b>37</b>
5.3.1	The "SureStep" System.....	37
5.3.2	Maximum obstacle height.....	37
5.3.3	Safety information when ascending obstacles.....	38
5.3.4	The correct way to overcome obstacles.....	39
5.4	<b>Driving up and down gradients</b> .....	<b>39</b>
5.5	<b>Use on public roads</b> .....	<b>40</b>
<b>6</b>	<b>Pushing the wheelchair in freewheel mode</b>	<b>41</b>
6.1	Disengaging motors.....	41
<b>7</b>	<b>Remotes</b>	<b>42</b>
<b>8</b>	<b>Adjusting the wheelchair to the user's seating posture</b>	<b>43</b>
8.1	<b>Adjusting the armrests and the control panel</b> .....	<b>44</b>
8.1.1	Adapting the control panel to the length of the user's arm.....	44
8.1.2	Setting the height of the remote.....	45
8.1.3	Setting the height of the remote.....	46
8.1.4	Setting the height of the armrests.....	47
8.1.5	Setting the height of the parallel sliding armrests.....	48
8.1.6	Adjusting the angle of the armpad on the parallel sliding armrests.....	49
8.1.7	Adjusting the width of the armrests.....	50
8.2	<b>Adjusting the seat angle</b> .....	<b>52</b>
8.2.1	Electric.....	52
8.2.2	Manual.....	52
8.3	<b>Adjusting the backrest</b> .....	<b>53</b>
8.3.1	Electrically adjusting the backrest angle.....	53
8.3.2	Adjusting backrest angle using perforated plate.....	54
8.3.3	Flex and Contour seats.....	55

8.3.4	Adjusting the backrest using the gas pressure spring.....	56
8.3.5	Adjusting the tension adjustable backrest upholstery .....	57
8.3.6	Adjusting the VIC AIR Cushion.....	58
<b>8.4</b>	<b>The Lifter .....</b>	<b>60</b>
8.4.1	Explanation of symbols on lifter warning sticker.....	61
<b>8.5</b>	<b>Adjusting the headrest.....</b>	<b>62</b>
<b>8.6</b>	<b>Postural belts.....</b>	<b>63</b>
8.6.1	Types of postural belts.....	63
8.6.2	Adjusting the postural belt correctly.....	64
<b>8.7</b>	<b>Adjusting the trunk supports .....</b>	<b>65</b>
8.7.1	Adjusting the width.....	65
8.7.2	Adjusting the height .....	66
8.7.3	Adjusting the depth .....	67
<b>8.8</b>	<b>Adjusting the height-adjustable push-handle .....</b>	<b>68</b>
<b>8.9</b>	<b>Adjusting and removing the tray .....</b>	<b>69</b>
8.9.1	Laterally adjusting the tray.....	69
8.9.2	Adjusting the depth of the tray / removing the tray.....	70
8.9.3	Swinging the tray away to the side .....	70
<b>8.10</b>	<b>Child seat (option) .....</b>	<b>71</b>
8.10.1	The headrest of the child seat .....	71
8.10.1.1	Adjusting the angle / depth of the headrest.....	71
8.10.1.2	Adjusting the height of the headrest.....	72
8.10.2	The armrests / setting the angle .....	73
8.10.3	The backrest.....	74
8.10.3.1	Adjusting the height of the sliding handles (option).....	74
8.10.3.2	Adjusting the angle of the backrest electrically .....	75
8.10.3.3	Adjusting the angle of the backrest manually.....	75
8.10.4	The legrest of the child seat.....	76
8.10.4.1	Setting the angle of the footrest.....	76
8.10.4.2	Swivelling the footrest upward / removing the legrest.....	77
8.10.4.3	Adjusting the width of the legrest.....	79



8.10.4.4	Adjusting the length of the legrest .....	85
8.10.4.5	Adjusting the angle of the legrest .....	86
<b>8.11</b>	<b>Using the KLICKfix adapter .....</b>	<b>88</b>

## **9 Adjusting footrests and legrests 89**

<b>9.1</b>	<b>Centre-mounted legrests .....</b>	<b>89</b>
9.1.1	Electric legrest .....	89
9.1.2	Manually adjustable leg rest .....	89
9.1.2.1	Removing the leg rest.....	89
9.1.2.2	Setting the angle of the leg rest.....	91
9.1.2.3	Setting the length of the leg rest.....	92
9.1.2.4	Setting the angle of the footplate.....	93
9.1.2.5	Setting the angle and height of the calf pad .....	94
<b>9.2</b>	<b>Laterally mounted legrests .....</b>	<b>95</b>
9.2.1	Vari-F footrest .....	95
9.2.1.1	Swivelling the footrest outward and/or removing.....	95
9.2.1.2	Setting the angle.....	96
9.2.1.3	Setting the end stop of the footrest .....	98
9.2.1.4	Adjusting the length of the footrest.....	101
9.2.2	Vari-A legrests .....	102
9.2.2.1	Swivelling the legrest outward and/or removing.....	102
9.2.2.2	Setting the angle.....	103
9.2.2.3	Setting the end stop of the legrest.....	106
9.2.2.4	Adjusting the length of the legrest .....	110
9.2.2.5	Adjusting the depth of the calf plate .....	111
9.2.2.6	Adjusting the height of the calf pad .....	112
9.2.2.7	Unlocking and swivelling the calf plate backward when alighting .....	113
9.2.2.8	Adjusting the angle adjustable foot plate.....	114
9.2.2.9	Adjusting the angle and depth adjustable foot plate .....	115
9.2.3	ADM legrests .....	116
9.2.3.1	Swivelling the legrest outward and/or removing.....	116

9.2.3.2	Setting the angle.....	117
9.2.3.3	Adjusting the length of the legrest.....	119
9.2.3.4	Adjusting the depth of the calf plate.....	120
9.2.3.5	Adjusting the height of the calf pad.....	121
9.2.3.6	Unlocking and swivelling the calf plate backward when alighting.....	122
9.2.3.7	Adjusting the angle adjustable foot plate.....	123
9.2.3.8	Adjusting the angle and depth adjustable foot plate.....	124
9.2.4	ADE legrests.....	125
9.2.4.1	Swivelling the legrest outward and/or removing.....	125
9.2.4.2	Setting the angle.....	126
9.2.4.3	Adjusting the length of the legrest.....	127
9.2.4.4	Adjusting the depth of the calf plate.....	128
9.2.4.5	Adjusting the height of the calf pad.....	129
9.2.4.6	Unlocking and swivelling the calf plate backward when alighting.....	130
9.2.4.7	Adjusting the angle adjustable foot plate.....	131
9.2.4.8	Adjusting the angle and depth adjustable foot plate.....	132
9.2.5	Adjusting the width of side-mounted legrests.....	133

<b>10</b>	<b>Electrical system</b>	<b>134</b>
<b>10.1</b>	<b>Electronics protection system.....</b>	<b>134</b>
10.1.1	The main fuse.....	135
<b>10.2</b>	<b>Batteries.....</b>	<b>136</b>
10.2.1	Charging the batteries.....	136
10.2.1.1	General information on charging.....	136
10.2.1.2	General instructions on charging.....	136
10.2.1.3	How to charge the batteries.....	137
10.2.1.4	How to disconnect the batteries after charging.....	138
10.2.2	Storage and Maintenance.....	139
10.2.3	Instructions on using the batteries.....	139
10.2.4	Transporting batteries.....	141
10.2.5	Handling batteries.....	141

10.2.5.1	General instructions on handling the batteries .....	141
10.2.5.2	How to handle damaged batteries correctly .....	141
10.2.5.3	Removing the batteries.....	143
<b>11</b>	<b>Care and maintenance</b>	<b>147</b>
<b>12</b>	<b>Transport</b>	<b>150</b>
12.1	Transferring the wheelchair to a vehicle.....	150
12.2	Use of the wheelchair as a seat in a vehicle.....	151
12.2.1	How the wheelchair is anchored in a vehicle for use as a vehicle seat .....	154
12.2.2	How the user is secured within the wheelchair.....	155
12.3	Securing the wheelchair for transport without passengers .....	159
<b>13</b>	<b>Refurbishment</b>	<b>160</b>
<b>14</b>	<b>Disposal</b>	<b>161</b>
<b>15</b>	<b>Technical specifications</b>	<b>162</b>
<b>16</b>	<b>Inspections Performed</b>	<b>169</b>

# 1 Introduction

**Dear user,**

First we would like to thank you for purchasing our product! We hope that you will have a great deal of pleasure with your new power wheelchair.

**This operating manual contains important information and notes about:**

- **Safety**
- **Operation**
- **Care and maintenance**

**Please take care to read the operating manual thoroughly before starting out on your first journey.**

This wheelchair has been constructed for a large circle of users with different requirements.

The decision whether the model is suitable for the user may only be taken by medical specialists with appropriate expertise.

Invacare® or their statutory representatives can accept no liability in cases in which the wheelchair has not been adapted to suit the users' handicaps.

Some maintenance and settings can be performed by the user or his/hers attendants. Certain adjustments do however require technical training and may only be carried out by your Invacare® specialist dealer. Damages and errors caused by nonobservance of the user manual or as a result of incorrect maintenance are excluded from all guarantees.

This manual contains copyrighted information. This manual may not be reproduced or reprinted either partly or completely without previous written consent from Invacare® or its statutory representatives. We reserve the right to make any necessary alterations on the grounds of technical improvements.

## 1.1 Important symbols in this manual

---



### General risks

**This symbol warns you of general hazards!**

- *Always follow the instructions to avoid injury to the user or damage to the product.*
- 



### EXPLOSION HAZARD!

**This symbol warns you of an explosion hazard, which can be caused by excessive tyre pressure in a pneumatic tyre.**

- *Always follow the instructions to avoid injury to the user or damage to the product.*
- 



### BURN HAZARD!

**This symbol warns you of the danger of chemical burns, for example due to the discharge of battery acids!**

- *Always follow the instructions to avoid injury to the user or damage to the product.*
- 



### BURN Risk!

**This symbol warns of the risk of burns, for example, as a result of hot motor surfaces.**

- *Follow the instructions in order to avoid injury or damage to the product.*
-



---

### **RISK OF CRUSHING!**

This symbol warns of a risk of crushing caused by being careless with heavy components.

- *Always follow the instructions to avoid injury to the user or damage to the product.*
- 



---

### **Wear eye protection**

This symbol refers to the requirement for wearing eye protection, for example when working with batteries.

- *You must wear safety goggles when this symbol is displayed.*
- 



---

### **Wear protective gloves**

This symbol indicates the requirement to wear protective gloves, for example when working with batteries.

*You must wear protective gloves when this symbol is displayed.*

---



---

### **NOTE:**

This symbol identifies general information which is intended to simplify working with your product and which refers to special functions.

---



---

### **Requirements:**

- This symbol identifies a list of various tools, components and items which you will need in order to carry out certain work. Please do not attempt to carry out the work if you do not have the listed tools available.
- 



---

### **READ WELL BEFORE OPERATION!**

This symbol advises you to read information carefully.

---

## 1.2 Important symbols found on the vehicle



---

This product has been supplied from an environmentally aware manufacturer. This product may contain substances that could be harmful to the environment if disposed of in places (landfills) that are not appropriate according to legislation.

- *The 'crossed out wheelie bin' symbol is placed on this product to encourage you to recycle wherever possible.*
  - *Please be environmentally responsible and recycle this product through your recycling facility at its end of life.*
- 



---

This symbol indicates the “Drive” position of the coupling lever. In this position the motor is engaged and the motor brakes are operational. You can drive the wheelchair.

- *Please note that for driving purposes both motors must always be engaged.*



This symbol indicates the “Push” position of the coupling lever. In this position the motor is disengaged and the motor brakes are not operational. The wheelchair can be pushed by an attendant and the wheels turn freely.

- *Please note that the control panel must be switched off.*
  - *Please also note the information provided in section "**Pushing the wheelchair in freewheel mode**" on page 41.*
-



---

This symbol indicates the position of an anchor point when using a lashing system during transport.

---



---

If the symbol appears on a bright yellow sticker, the anchoring point is suitable for fixation of the wheelchair in a vehicle for use as a vehicle seat.

---



---

This wheelchair may be used as a vehicle seat, but only if it is equipped with a headrest that has been approved by Invacare for this purpose!

- *Please always make sure that the wheelchair is equipped with a headrest approved by Invacare before using it as a vehicle seat!*
- 



---

This symbol indicates the maximum width to which an armrest may be adjusted. Pulling the armrest out further can cause it to fall out of its fixation. For further information, see chapter "Adjusting the width of the armrests" on page 50.

---





If the power wheelchair is fitted with a table, it is imperative that it is removed and safely stowed when transporting the wheelchair in a vehicle!

### 1.2.1 Explanation of symbols on lifter warning sticker



Do not lean out when the lifter is raised!

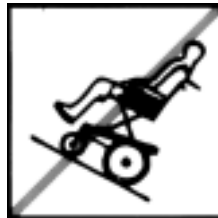

Do not drive up or down slopes when the lifter is raised!



Do not allow any body parts to get under a raised seat!



Never drive with two people!



Never drive over uneven surfaces when the lifter is raised!

## 1.3 Type classification and permissible use

This vehicle was designed for persons whose ability to walk is impaired, but who are still in terms of their eyesight and physically and mentally able to operate an electric vehicle. It has been classified according to EN 12184 as a **class B mobility product** (for indoor and outdoor areas). It is therefore compact and agile enough for indoor areas, but also able to overcome many obstacles in outdoor areas.

You can find precise information about speed, turning radius, driving range, maximum safe slope, maximum obstacle height and permissible operating conditions in chapter "Technical specifications" starting from page 162.

Please also pay attention to all safety information in chapter "Safety notes" starting from page 21.

The vehicle was successfully tested according to German and international standards as to its safety. It satisfies the requirements according to DIN EN 12184 including EN 1021-1/-2. It was also tested successfully according to EN60529 IPX4 as to its resistance to spray water, and is therefore well suited for typical middle European weather conditions. When equipped with an appropriate lighting system, the vehicle is suitable for use on public roads.

## 1.4 Indications

The use of this mobility product is recommended for the following indications:

The inability or a greatly restricted ability to walk within the scope of the basic requirement to be able to move within one's own four walls. The need to leave the dwelling place in order to get some fresh air during a short walk or to reach those places generally to be found at close distance to the dwelling and where everyday business is carried out.

Provision of power wheelchairs for interior and exterior areas is advisable if the use of hand-operated wheelchairs is no longer possible on account of the disability, yet proper operation of an electromotive drive unit is still practicable.

## 1.5 Usability

Only use a power wheelchair when it is in perfect working order. Otherwise, you might put yourself and others at risk.

The following list does not claim to be exhaustive. It is only intended to show some of the situations that could affect the usability of your power wheelchair.

In certain situations, you should immediately stop using your wheelchair. Other situations allow you to use the wheelchair to get to your dealer.

- You should immediately stop using your power wheelchair if its usability is restricted due to:
  - brake failure
- You should immediately contact an authorised Invacare® dealer if the usability of your power wheelchair is restricted due to:
  - the lighting system failing or being defective
  - reflectors falling off
  - worn thread or insufficient tyre pressure
  - damage to the armrests (e.g. torn armrest padding)
  - damage to the legrest hangers (e.g. missing or torn heel loops)
  - damage to the postural belt
  - damage to the joystick (joystick cannot be moved into the neutral position)
  - cables that are damaged, kinked, pinched or have come loose from the holder
  - the wheelchair drifting when braking
  - the wheelchair pulling to one side when moving

- unusual sounds developing or occurring

Or if you have the feeling that something is wrong with your wheelchair.

## **1.6 Warranty**

The terms and conditions of the warranty are part of the general terms and conditions particular to the individual countries in which this product is sold.

## **1.7 Life expectancy**

We estimate a life expectancy of five years for this product, provided it is used in strict accordance with the intended use as set out in this document and all maintenance and service requirements are met. The estimated life expectancy can be exceeded if the product is carefully used and properly maintained, and provided technical and scientific advances do not result in technical limitations. The life expectancy can also be considerably reduced by extreme or incorrect usage. The fact that we estimate a life expectancy for this product does not constitute an additional warranty.

## 2 Safety notes



---

**READ WELL BEFORE OPERATION!**

---

### 2.1 General safety notes

---



**Danger of injury if mobility device is used in any other way than the purpose described in this manual!**

- *Only ever use the mobility device in accordance with the instructions in this User's Manual (see chapter "Type classification and permissible use" on page 18).*
- *Pay strict attention to the safety information.*

**Danger of injury if the mobility device is driven when ability to operate a vehicle is impaired by medication or alcohol!**

- *Never drive the mobility device under the influence of medication or alcohol. If necessary, the mobility device must be operated by an attendant who is physically and mentally able.*

**Danger of damage or injury if mobility device is accidentally set into motion!**

- *Switch the mobility device off before you get in, get out or handle unwieldy objects.*
  - *When the drive is disengaged, the brake inside the drive is deactivated. For this reason, pushing the mobility device by an attendant is only recommended on flat surfaces, never on gradients. Never leave your mobility device on a gradient with its motors disengaged. Always re-engage the motors immediately after pushing the mobility device (see chapter "Pushing the wheelchair in freewheel mode" on page 41).*
-



---

**Danger of injury if the mobility device is switched off while driving, for example by pressing the On/Off Button or disconnecting a cable, due to it coming to an abrupt, sharp stop!**

- *If you have to brake in an emergency, simply release the joystick which will bring you to a halt. (refer to the joystick operating manual for more information).*

**Danger of injury when transferring mobility device to a vehicle for transport with the occupant seated in it!**

- *It is always better to transfer the mobility device to a vehicle without the occupant seated in it.*
- *If the mobility device needs to be loaded up a ramp together with its driver, ensure that the ramp does not exceed the maximum safe slope (see chapter "Technical specifications" from page 162).*
- *If the mobility device does need to be loaded using a ramp which exceeds the maximum safe slope (see chapter "Technical specifications" from page 162), then you must use a winch. An attendant can safely monitor and assist the loading process.*
- *As an alternative you can use a platform lift. Ensure that the total weight of the mobility device including the user does not exceed the maximum permissible weight for the platform lift or winch if you are using.*

**Danger of injury if maximum permissible load is exceeded!**

- *Do not exceed the maximum permissible load (see chapter "Technical specifications" from page 162).*
  - *The mobility device is only designed for use by a single occupant whose maximum weight does not exceed the maximum permissible load of the device. Never use the mobility device to transport more than one person.*
-



---

**Danger of injury due to wrong lifting or dropping of heavy components!**

- *When maintaining, servicing or lifting any part of your mobility device, take into account the weight of the individual components especially the batteries. Be sure at all times to adopt the correct lifting posture and ask for assistance if necessary.*

**Danger of falling out of the mobility device.**

- *Do not slide forward on the seat, do not lean forward between your knees, do not lean backwards out over the top of the backrest, for example to reach an object.*
- *If a posture belt is installed, it should be correctly adjusted and used each time you use the mobility device.*
- *When transferring to a different seat, position the mobility device as close as possible to the new seat.*

**Danger of injury by moving parts!**

- *Make sure that no injury is incurred by moving parts of the mobility device, like wheels or one of the Lifter Modules (if fitted), especially when children are around.*

**Risk of injury from hot surfaces!**

- *Do not leave the wheelchair in direct sunlight for prolonged periods. Metal parts and surfaces such as the seat and armrests can become very hot.*

**Danger of fire or breaking down due to electric devices being connected!**

- *Do not connect any electric devices to your mobility device that are not expressly certified by Invacare® for this purpose. Have all electrical installations done by your authorised Invacare® Dealer.*
-

## 2.2 Safety information with regard to care and maintenance

---



### **Danger of accident and loss of guarantee if maintenance is insufficient!**

- *For reasons of safety and in order to avoid accidents which result from unnoticed wear, it is important that this electric mobility product undergoes an inspection once every year under normal operating conditions (see inspection plan contained in service instructions).*
  - *Under difficult operating conditions such as daily travel on steep slopes, or in the case of use in medical care cases with frequently changing wheelchair users, it would be expedient to carry out intermediate checks on the brakes, accessories and running gear.*
  - *If the mobility product is to be operated on public roads, the vehicle driver is responsible for ensuring that it is in an operationally reliable condition. Inadequate or neglected care and maintenance of the mobility product will result in a limitation of the manufacturer's liability.*
-



## 2.3 Safety information on electromagnetic interference

This electric vehicle was successfully tested in accordance with International standards as to its compliance with Electromagnetic Interference (EMI) regulations. However, electromagnetic fields, such as those generated by radio and television transmitters, and cellular phones can influence the functions of electric vehicles. Also, the electronics used in our vehicles can generate a low level of electromagnetic interference, which however will remain within the tolerance permitted by law. For these reasons we ask you to please observe the following precautions:



---

**WARNING: Danger of malfunction due to electromagnetic interference!**

- *Do not switch on or operate portable transceivers or communication devices (such as radio transceivers or cellular phones) when the vehicle is switched on.*
  - *Avoid getting near strong radio and television transmitters.*
  - *In case the vehicle should be set in motion unintentionally or the brakes are released, switch it off immediately.*
  - *Adding electrical accessories and other components or modifying the vehicle in any way can make it susceptible to electromagnetic interference. Keep in mind that there is no sure way to determine the effect such modifications will have on the overall immunity of the electronic system.*
  - *Report all occurrences of unintentional movement of the vehicle, or release of the electric brakes to the manufacturer.*
-

## 2.4 Safety information on driving and freewheel mode

---



### **Danger of injury if the wheelchair tips over!**

- *Inclines and declines can only be travelled up to the maximum safe slope (see chapter "Technical specifications" from page 162).*
  - *Always return the backrest of your seat or the seat tilt to an upright position before ascending slopes. We recommend that you position the seat backrest and the seat tilt (if fitted) slightly to the rear before descending slopes.*
  - *Only ever drive downhill at a maximum of 2/3 of the top speed. Avoid abrupt braking or accelerating on gradients.*
  - *If at all possible, avoid driving on slippery surfaces (such as snow, gravel, ice etc.) where there is a danger of you losing control over the vehicle, especially on a gradient. If driving on such a surface is inevitable, then always drive slowly and with the utmost caution.*
  - *Never attempt to overcome an obstacle when on an uphill or downhill gradient.*
  - *Never attempt to drive up or down a flight of steps with your wheelchair.*
  - *When overcoming obstacles, always observe the maximum obstacle height (see chapter "Technical specifications" from page 162 and information about overcoming obstacles in chapter "Taking Obstacles" from page 37).*
  - *Avoid shifting your centre of gravity as well as abrupt joystick movements and changes of direction when the wheelchair is in motion.*
  - *Never use the wheelchair to transport more than one person.*
  - *Do not exceed the overall maximum permissible load or the maximum load per axle (see chapter "Technical specifications" on page 162).*
  - *Note that the wheelchair will brake or accelerate if you change the Driving Mode whilst the wheelchair is in motion.*
-



---

**Danger of breaking down in adverse weather conditions, i.e. extreme cold, in an isolated area!**

- *If you are a user with severely limited mobility, we advise that in the case of adverse weather conditions DO NOT attempt a journey without an accompanying attendant!*

**Danger of injury if your foot slides off the footrest and gets caught underneath the wheelchair when it is in motion!**

- *Make sure each time before you drive the wheelchair that your feet are squarely and securely in place on the footplates, and that both legrests are properly locked into place.*

**Danger of injury if you collide with an obstacle when driving through narrow passages such as doorways and entrances!**

- *Drive through narrow passages in the lowest driving mode and with due caution.*

**If your power wheelchair has been fitted with angle-adjustable legrests, there is a danger of personal injury and damage to the wheelchair if you drive the wheelchair with the legrests raised!**

- *To avoid unwanted displacement of the wheelchair centre of gravity to the front (especially when travelling downhill) and in order to avoid damage to the wheelchair, angle-adjustable legrests must always be lowered during normal travelling.*
-

## 2.5 Safety information on maintenance work and alterations to the wheelchair

---



**WARNING: Danger of injuries and damage to the wheelchair, in case the suspension is adjusted without the immobilisation mechanism of the front anti-tippers being re-adjusted!**

- *When the hardness of the suspension is adjusted, the immobilisation mechanism of the front anti-tippers must without fail be checked and, if necessary, also re-adjusted!*
- 



### **Important information about maintenance work tools!**

Some maintenance work which is described in this manual and can be carried out by the user without problems require the correct tools for proper work. If you do not have the correct tool available we do not recommend that you try to carry out the relevant work. In this case, we urgently recommend that you contact an authorised specialist workshop.

---



### **CE marking of the wheelchair**

The conformity assessment/ CE marking was carried out in accordance with Directive 93/42 EEC / MPG (Medical Devices Act) and only applies to the complete product.

The CE marking is invalidated if components or accessories are replaced or added that have not been approved for this product by Invacare.

In this case, the company that adds or replaces the components or accessories is responsible for the conformity assessment/ CE marking or for registering the wheelchair as a special design and for the relevant documentation.

---



---

**CAUTION: Danger of injuries and damage to mobility aid due to unapproved components and accessory parts!**

**Seating systems, additions and accessory parts which have not been approved by Invacare® for use with this mobility aid can affect the tipping stability and increase tipping hazards!**

- *Only ever use seating systems, additions and accessory parts which have been approved by Invacare® for this mobility aid!*

**Seating systems which are not approved by Invacare® for use with this power wheelchair do not, under certain circumstances, comply with the valid standards and could increase the flammability and the risk of skin irritation.**

- *Only use seating systems that have been approved by Invacare® for this power wheelchair.*

**Electrical and electronic components which have not been approved by Invacare® for use with this mobility aid can cause fire hazards and lead to electromagnetic damage!**

- *Only ever use electrical and electronic components which have been approved by Invacare® for this mobility aid!*

**Batteries which have not been approved by Invacare® for use with this mobility aid can cause chemical burns!**

- *Only ever use batteries which have been approved by Invacare® for this mobility aid!*
-

## 2.6 Safety information on wheelchairs with a lifter

---



### **WARNING! Danger of injury by moving parts!**

- *Never let objects get caught in the space underneath a raised lifter!*
  - *Make sure that neither you nor anyone else is injured by placing hands, feet other body extremities under the raised seat!*
  - *Should you not be able to view under the seat, e.g. due to limited manoeuvrability, turn the wheelchair once on its own axle before you lower the seat. This will allow you to make sure that nobody is located in the danger zone.*
- 



### **CAUTION!**

#### **Danger of injury if the wheelchair tips over!**

- *Never exceed the maximum permissible load (see chapter "Technical specifications" from page 162)!*
- *Avoid dangerous driving situations when the lifter is in a raised position, such as trying to overcome obstacles like kerbs or driving up or down steep gradients!*
- *Never lean out of the seat when the lifter is raised!*
- *Inspect the lifter module at least once a month to make sure the automatic speed reduction function, which reduces the speed of the wheelchair when the lifter is raised, is working properly (see chapter "The Lifter" from page 60)! Notify your authorised dealership immediately if it is not working properly!*

#### **Danger of malfunction of the Lifter Module!**

- *Inspect the lifter module at regular intervals to make sure there are no foreign objects or visible damage, and to make sure the electric plugs are firmly inserted into their sockets!*
-



---

**CAUTION! Damage to mobility aid caused by one-sided loading on lifter pillar!**

- *One-sided loading occurs if the seat is raised and/or tilted. Always return your seat backrest to the upright position and the seat tilting to the horizontal position before ascending slopes! ! Never subject the lifter pillar to continuous single-sided loading! The raising and tilting function of the seat only provides additional rest positions.*
- 



---

**Important information regarding speed reduction with raised lifter!**

If the lifter has been raised above a certain point, the drive electronics considerably reduces the speed of the mobility aid. If speed reduction has been activated, drive mode can only be used to carry out minor movements of the mobility aid and not for regular driving! To drive normally, please lower the lifter until the speed reduction has been deactivated again!

---

### 3 Key features

- 1) Push handle
- 2) Armrest
- 3) Lever for disengaging a motor (only visible on right-hand side of picture)
- 4) Drive wheel
- 5) Remote
- 6) Legrests





## 4 Getting in and out of the wheelchair



### **Important information when side transferring in and out of the wheelchair**

In order to side transfer it is necessary for the armrest to either be raised or removed completely depending on the model. A skirtguard can be installed as an option in connection with the parallel sliding armrest. This is attached in the same way as the standard armrest and must also be removed when transferring.

### 4.1 Remove the standard armrest in order to side transfer

#### **Removing the armrest:**

- The remote cable (1) can be removed from remote depending on the remote version.
- Loosen wing nut (2)
- Remove the side panel from the receptacle



## 4.2 Raise the parallel sliding armrest / remove the skirtguard (optional)

### Swivelling the armrest up

- Swivel the armrest up to access from the side.



### Removing the skirtguard (optional) to get on:

- Release wing nut (1) .
- Remove the skirtguard from the receptacle.



### **Getting into the wheelchair:**

- Position your wheelchair as close as possible to your seat. This might have to be done by an attendant.
- Switch your wheelchair off.
- Apply the manual wheel lock of your wheelchair (if existing).
- Detach the skirt guard of your wheelchair or swivel it up.
- Now slide into the wheelchair.



### **Getting out of the wheelchair:**

- Drive your wheelchair as close as possible to your seat.
- Switch your wheelchair off.
- Apply the manual wheel lock of your wheelchair (if existing).
- Detach the skirt guard of your wheelchair or swivel it up.
- Now slide onto your new seat.



---

#### **NOTE:**

If you do not have sufficient muscle strength, you should ask other persons for help. Use a sliding board, if possible.

---

## 5 Driving

---



### NOTE

The maximum load capacity that is stated in the technical data only states that the system is designed for this mass in total. However, this does not mean that one can sit a person with this body weight in the wheelchair without restrictions. Attention must be paid to the body proportions, such as height, weight distribution, abdominal girth, leg and calf girth and seat depth. These factors have a strong influence on driving features such as tilt stability and traction. The permissible axle loads in particular must be adhered to (see chapter "**Technical specifications**" as from page **162**)! It may possibly be necessary to carry out adaptations to the seat system.

---

### 5.1 Before driving for the first time...

Before you take your first trip, you should familiarise yourself well with the operation of the vehicle and with all operating elements. Take your time to test all functions and driving modes.

---



### NOTE:

If installed, make sure to properly adjust and use the postural belt each time you use the wheelchair.

---

### Sitting Comfortably = Driving Safely

Before each trip, make sure that:

- You are within easy reach of all operating controls.
- The battery charge is sufficient for the distance intended to be covered.
- The postural belt (if installed) is in perfect order.

- The rear mirror (if installed) is adjusted so you can look behind at all times without having to bend forward or shift your seating position.

## **5.2 Parking and stationary**

**When parking your vehicle or if your vehicle is stationary for a prolonged period:**

- Switch the vehicle's power system off (ON-/OFF key).
- Activate your anti-theft lock, if existing.

## **5.3 Taking Obstacles**

### **5.3.1 The "SureStep" System**

This power wheelchair is fitted with "SureStep" technology. When climbing over obstacles, the front steering wheels are raised using the torque generated by the drive wheels.

### **5.3.2 Maximum obstacle height**

You can find information about maximum obstacle heights in the chapter entitled "**Technical specifications**" from page **162**.

### 5.3.3 Safety information when ascending obstacles

---



**CAUTION: Danger of Tipping Over!**

- *Never approach obstacles at an angle but at 90 degrees as shown below.*
  - *Put your backrest into an upright position before climbing an obstacle.*
- 



**ATTENTION: Risk of falling out of the chair and damage to the power wheelchair such as broken castors!**

- *Never approach obstacles that are higher than the maximum climbable obstacle height. For the maximum climbable obstacle height, see "Technical specifications" on page 162.*
  - *If unsure whether the kerb climb is possible or not, move away from the obstacle and if possible find another location.*
- 



**CAUTION: The wheelchair can be damaged if an obstacle is approached at excessive speed.**

- *Always approach obstacles at low speed! As soon as the front wheels come into contact with the obstacle, stop for a short period before driving over the obstacle! Wheelchairs fitted with centre drive have a special mechanism (Walking Beam) for overcoming obstacles. Approaching at speed can actually lead to mechanical damage.*
-

### 5.3.4 The correct way to overcome obstacles

#### Ascending

- Approach the obstacle or the kerb slowly, head-on and at a right angle.
- Depending on the wheel drive type, stop in one of the following positions:
  - In the case of centrally driven wheelchairs: 5 - 10 cm before the obstacle.
  - For all other drives: approx. 30 - 50 cm in front of the obstacle.
- Check the position of the front wheels. They must be in driving direction and at right angles to the obstacle.
- Approach slowly and keep at a consistent speed until the rear wheels have also passed over the obstacle.

#### Descending

The approach to descend an obstacle is the same as to ascend it with the difference that you need not stop before descending.

- Descend the obstacle very slowly.

### 5.4 Driving up and down gradients

For information concerning the maximum safe slope, please see chapter "**Technical specifications**" starting on page **162**.

**Right**



**Wrong**





---

**WARNING: Danger of tipping over!**

- *Only ever drive downhill at a maximum of 2/3 of the top speed. Avoid sudden changes of direction or abrupt braking when driving on slopes.*
  - *Always return the backrest of your seat or the seat tilt (if adjustable seat tilt is available) to an upright position before ascending slopes. We recommend that you position the seat backrest or the seat tilt slightly to the rear before descending slopes.*
  - *Always lower the lifter (if fitted) to its lowest position before ascending or descending a slope.*
  - *Never attempt to ascend or descend a slope on slippery surfaces or where there is a danger of skidding (such as wet pavement, ice etc).*
  - *Avoid trying to get out of the vehicle on an incline or a gradient.*
  - *Always drive straight in the direction the road or path you are on goes, rather than attempting to zigzag.*
  - *Never attempt to turn around on an incline or a slope.*
- 



---

**Braking distance is much longer on a downhill slope than on even terrain!**

- *Never drive down a slope that exceeds the maximum safe slope (see chapter "**Technical specifications**" on page 162).*
- 

## 5.5 Use on public roads

If you wish to use your wheelchair on public roads and lighting is required by national legislation, then your wheelchair needs to be equipped with an appropriate lighting system.

Please contact your Invacare ® dealer if you have any questions.



## 6 Pushing the wheelchair in freewheel mode

The motors of the wheelchair are equipped with automatic brakes, preventing that the wheelchair starts rolling out of control when the joystick box is switched off. When pushing the wheelchair manually whilst freewheeling, the magnetic brakes must be disengaged.

---



**NOTE:**

Pushing the wheelchair by hand may require more physical force than expected (more than 100 N). The necessary force nevertheless complies with the requirements of ISO 7176-14:2008.

---

### 6.1 Disengaging motors

---



**Danger of the vehicle running away!**

- *When the motors are disengaged (for push operation whilst freewheeling), the electromagnetic motor brakes are deactivated! When the vehicle is parked, the levers for engaging and disengaging the motors must without fail be locked firmly into the "DRIVE" position (electromagnetic motor brakes activated)!*
- 



**NOTE:**

The motors may only be disengaged by an attendant, not by the user!

This ensures that the motors are only disengaged if an attendant is available to secure the wheelchair and prevent unintended rolling.

---

The lever for disengaging the motors is located behind the motors.

**Disengaging motors:**

- Switch off remote.
- Push the engaging lever down (1). The motors are now disengaged.

**Re-engaging motors**

- Pull the engaging lever (1) upwards. The motors are now re-engaged.

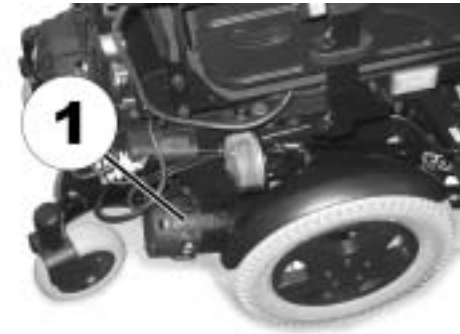

## 7 Remotes

Your wheelchair may be equipped with one of several different remotes. For information on the different functions and how to operate a particular remote, please see its corresponding User Manual (enclosed).

## 8 Adjusting the wheelchair to the user's seating posture

---



**CAUTION: Damage to wheelchair and accident hazard! It is possible that collisions can occur between wheelchair components due to various combinations of adjustment options and their individual settings!**

- *The wheelchair is fitted with an individual, multiply adjustable seating system including adjustable legrests, armrests, a headrest or other options. These adjustment options are described in the following chapters. They are used to adapt the seat to the physical requirements and the condition of the user. When adapting the seating system and the seat functions to the user, ensure that no wheelchair components collide.*
-

## 8.1 Adjusting the armrests and the control panel

### 8.1.1 Adapting the control panel to the length of the user's arm



---

**Requirements:**

- Allen key 3 mm
- 

- Loosen the socket head screw (1).
- Set remote to the desired length by pushing forward or backward.
- Tighten screw.

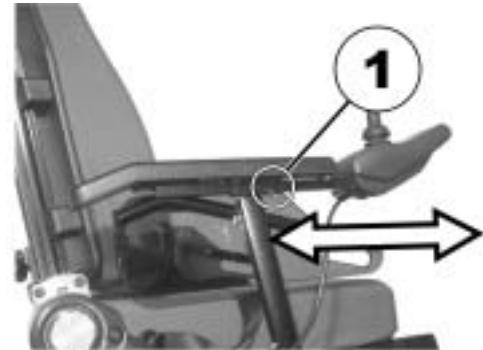

## 8.1.2 Setting the height of the remote



---

### Pre-requisites:

- 1x 6 mm Allen key
- 

- Loosen the Allen screw (1).
- Adjust the remote to the desired height.
- Re-tighten the Allen screw.



### 8.1.3 Setting the height of the remote

If your wheelchair is fitted with a swing-away remote bracket, then the remote can be moved away to the side, for example to drive up close to a table.



## 8.1.4 Setting the height of the armrests

- Loosen the bolt (1).
- Set the armrest at the desired height.
- Retighten the bolt.



## 8.1.5 Setting the height of the parallel sliding armrests



---

### Requirements:

- Allen key 2 mm
- 

- Loosen the screws (1) with the 2 mm Allen key on both sides of the spindle.
- Turn the spindle clockwise (A). The armrest is raised.
- Turn the spindle anticlockwise (B). The armrest is lowered.
- Retighten the wing nuts.

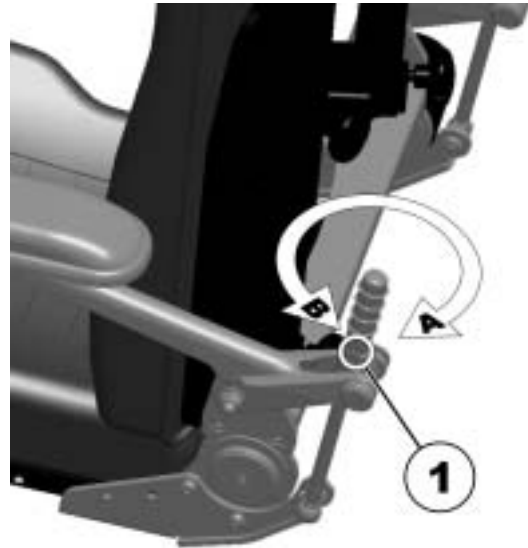



## 8.1.6 Adjusting the angle of the armpad on the parallel sliding armrests



### Requirements:

- Allen key 4 mm
- Open-end spanner 10 mm

- Loosen the screw (1, on the inner side of the armrest), which allows adjustment of the angle of the armpad, while countering the nut (2, outer side of the armrest) with the open-end spanner, if necessary.



- Adjust the angle of the armpad.
- Re-tighten the screw (1), while countering the nut (2).



## 8.1.7 Adjusting the width of the armrests

The distance between the side sections can be adjusted by 5.5 cm on both sides (11 cm in total).



### Requirements:

- Allen key 8 mm

### Where to find the adjustment screws

The figure below shows the position of the screws (1) which allow armrest width adjustment (only the left side is shown in the illustration).

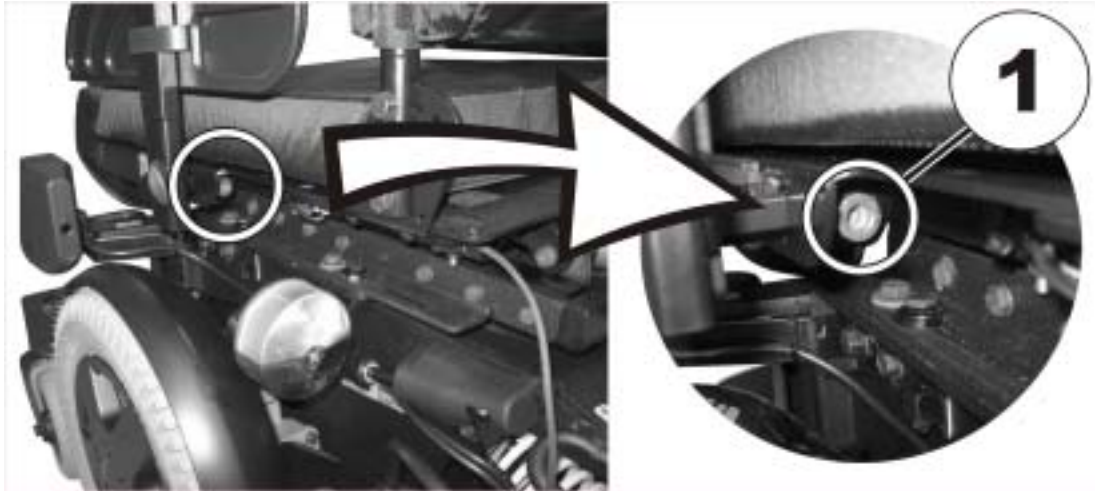

### Doing the adjustment

- Loosen screw (1)
- Adjust armrest to required position.
- Retighten the screw.
- Repeat this procedure for the second armrest.

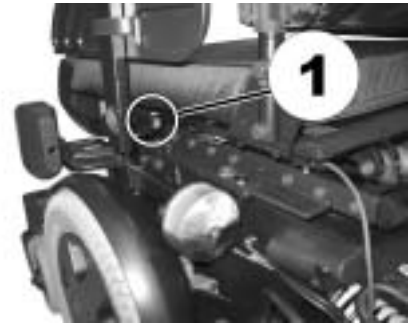

## 8.2 Adjusting the seat angle

### 8.2.1 Electric

Please consult the user manual for your remote for information about electrical adjustment.

### 8.2.2 Manual

The seat angle is adjusted using two perforated plates which are located right and left under the seat frames.



---

#### Requirements:

- 1x jaw spanner 1/2 inch
- 

The figure to the right shows the position of the bolts (1) for manual seat angle adjustment.

- Loosen all bolts on both sides.
- Set the required angle.
- Retighten the bolts.

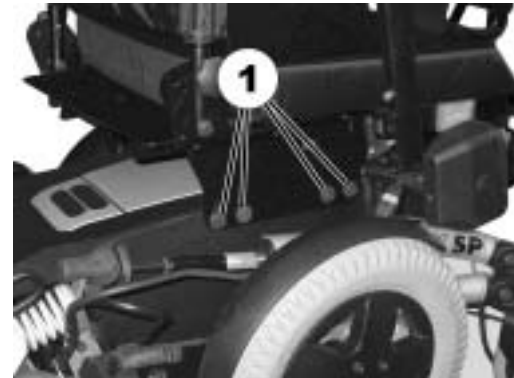

## 8.3 Adjusting the backrest

### 8.3.1 Electrically adjusting the backrest angle

Please consult the user manual for your remote for information about electrical adjustment.

---



#### **Information on models with electrical backrest adjustment**

If your wheelchair is fitted with electrical backrest adjustment, the maximum adjustment to the rear is limited either by a microswitch or an angular sensor (depending on seating system and seat depth).

If limiting is carried out by an angular sensor, both the backrest angle and the seat angle affect the actual switch-off angle measured by the actuator.

In order to achieve maximum backrest adjustment, it may be necessary to bring the seat angle into a neutral (upright) position.

---

### 8.3.2 Adjusting backrest angle using perforated plate

- Unscrew the hand screws (1) on both sides.
- The backrest is adjusted by choosing a combination of one of the two bore holes in the backrest frame and one of the six bore holes in the fixing plate.
- Re-position the screws and tighten.



### 8.3.3 Flex and Contour seats

- Set the angle by turning the hand wheel (1).



### 8.3.4 Adjusting the backrest using the gas pressure spring

The lever for adjusting the backrest is located on the opposite side from the Joystick Box under the armrest.

#### Adjusting angle of the backrest

- Pull lever (1) upward.
- Adjust backrest angle by leaning forward or backward.
- Release the lever again. The backrest is locked at the desired angle.



---

#### NOTE

If the lever is pulled upwards and inwards at the same time, it will latch into a notch at the top. Push the lever out of the notch to release it, and allow it to be moved down again.

---



### 8.3.5 Adjusting the tension adjustable backrest upholstery

- Remove the backrest cushion (attached with Velcro strips) by pulling it up and off to access the adjustment straps.



- Adjust the tension of the individual straps as desired.
- Replace the backrest cushion.



### 8.3.6 Adjusting the VIC AIR Cushion

- Remove the VIC AIR cushion (attached with Velcro strips) by pulling it forward.



- Zip open the cover of the cushion.



- Pull the inner cushion out.



The inner cushion comprises five individual compartments filled with air-filled tetrahedrons (1). These can be added, removed or redistributed in the different compartments to adjust hardness and positioning.

- To access the inner compartments, open the zipper.
- Adjust the cushion by adding or removing air-filled tetrahedrons from the individual compartments, until the cushion has the desired hardness and shape.
- Close the inner cushion again.
- Place the inner cushion back in it's cover again and zip shut.
- Reposition the cushion on the backrest board, and press firmly onto the Velcro fastening material.



## 8.4 The Lifter

The electric lifter is operated from the remote. Please refer to the remote manual for more information.



---

### **Information regarding operation of the lifter at temperatures of less than 0 °C**

Invacare® mobility aids are fitted with safety mechanisms that prevent capacity overload of the electronic components. At operating temperatures below freezing point this can, in particular, lead to the lifter actuator being shut down after approx. 1 second operating time.

The lifter can be raised or lowered gradually by repeatedly operating the joystick. In many cases this generates sufficient heat for the actuator to operate as normal.

---



---

### **Note - speed limiter**

The lifter is fitted with sensors which reduce the mobility device speed as soon as the lifter is raised above a certain point.

This takes place to guarantee the tipping stability of the mobility device and to avoid damage to the legrests.

If the speed limit is activated, a corresponding blink code is displayed on the remote or a reduced drive level is set automatically. Please refer to the remote manual for more information.

To reapply normal speed, run the lifter down until the status display stops blinking.

---

### 8.4.1 Explanation of symbols on lifter warning sticker



**Do not lean out when the lifter is raised!**



**Do not drive up or down slopes when the lifter is raised!**



**Do not allow any body parts to get under a raised seat!**



**Never drive with two people!**



**Never drive over uneven surfaces when the lifter is raised!**

## 8.5 Adjusting the headrest



**CAUTION:** Injury hazard during use of the mobility aid as a vehicle seat if a headrest is wrongly adjusted or not installed! This can cause the neck to be hyperextended during collisions!

- *A headrest must be installed! The headrest optionally supplied for this mobility device by Invacare® is perfectly suitable for use during transport.*
- *The headrest must be adjusted to the user's ear height.*



- Loosen the clamping lever (1, 2 or 3).
- Adjust the headrest to the required position.
- Retighten clamping lever.



## 8.6 Postural belts

A postural belt is an option which can either be fixed to the wheelchair ex-works or can be retrofitted by your specialist dealer. If your wheelchair is fitted with a postural belt, your specialist dealer will have informed you about fitting and usage.

The postural belt is used to help the wheelchair user keep an optimum sitting position. Correct use of the belt assists the user in sitting securely, comfortably and well-positioned in the wheelchair, especially for such users who do not have such a good sense of balance while sitting.



---

**NOTE:**

We recommend using the postural belt whenever the wheelchair is used. The belt should be tight enough to ensure that you are sitting comfortably and that your body is in the correct sitting position.

---

### 8.6.1 Types of postural belts

Your wheelchair can be fitted with the following postural belt types ex-works. If your wheelchair has been fitted with a different belt to those listed below, please ensure that you have received the manufacturer's documentation with regard to correct fitting and use.

**Belt with metal buckle, adjustable one side**

Belt can only be adjusted on one side which can result in the buckle not sitting centrally.



### **Belt with metal buckle, adjustable both sides**

Belt can be adjusted on both sides. This means that the buckle can be centrally positioned.



## **8.6.2 Adjusting the postural belt correctly**

- Ensure that you are sitting correctly, which means that you are sitting right at the back of the seat, your pelvis is positioned erect and as symmetrically as possible, not to the front, to the side or at one edge of the seat.
- Position the postural belt so that your hipbones can be easily felt above the belt.
- Adjust the belt length using one of the adjustment aids described above. The belt should be adjusted so that you can fit a flat hand between the belt and your body.
- The buckle should be positioned as centrally as possible. In doing so, please carry out adjustments on both sides as much as possible.
- Please check your belt every week to ensure that it is still in good working condition; to ensure it has no damage or wear, and that it is fixed properly to the wheelchair. If the belt is only fastened with a bolted connection, ensure that the connection has not loosened or undone. You can find more information about maintenance work on belts in the service manual, which is available from Invacare®.



## 8.7 Adjusting the trunk supports

The trunk supports can be adjusted in three different ways:

- Width
- Height
- Depth

### 8.7.1 Adjusting the width

- Loosen the knobs (1) that hold the lateral supports.
- Adjust the supports to the desired width.
- Re-tighten the knobs.



## 8.7.2 Adjusting the height



---

**Requirements:**

- Allen key 5 mm
- 
- Loosen the screws (1) that allow height adjustment of the lateral supports.
  - Adjust the supports to the desired height.
  - Re-tighten the screws.

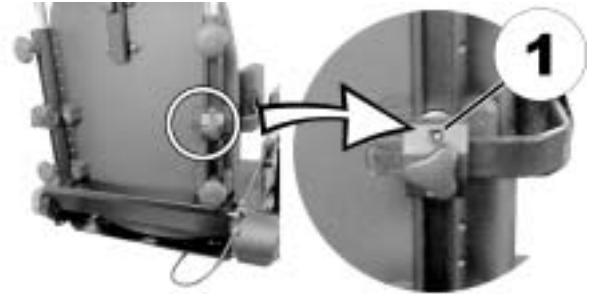

### 8.7.3 Adjusting the depth



---

**Requirements:**

- Allen key 5 mm
- 

- Loosen the screws (1) that allows the support pads to slide forwards and backwards.
- Adjust the supports to the desired position.
- Re-tighten the screws.



## 8.8 Adjusting the height-adjustable push-handle

- Loosen the knobs (1) that hold the push-handle.
- Adjust the handle to the desired height.
- Re-tighten the knobs.



## 8.9 Adjusting and removing the tray



**CAUTION:** Injury hazard or material damage if a power wheelchair which is fitted with a table is transported in a vehicle!

- *If a table is fitted, always remove it before transporting the wheelchair.*



### 8.9.1 Laterally adjusting the tray

- Loosen the wing-screw (1).
- Adjust the tray towards the left or right.
- Re-tighten wing-screw.

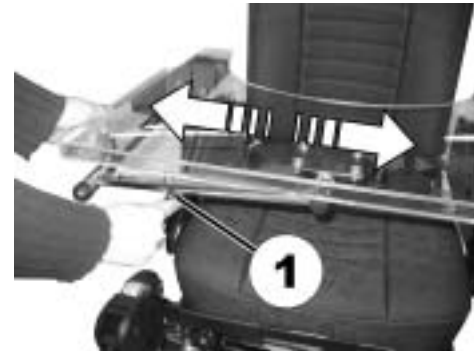

## 8.9.2 Adjusting the depth of the tray / removing the tray

- Loosen the wing-screw (1).
- Adjust the table to the desired depth (or remove it entirely).
- Re-tighten the screw.



## 8.9.3 Swinging the tray away to the side



---

**CAUTION! Risk of injury! When the tray is raised it does not lock in place in this position!**

- *Do not tilt the tray up and leave it leaning in this position.*
  - *Never attempt to drive with the tray tilted up.*
  - *Always lower the tray in a controlled manner.*
- 

The tray can be swivelled upwards and pushed to the side as illustrated to enable getting on and off.



## 8.10 Child seat (option)

The child seat consists of the actual seat, a headrest and a laterally-mounted footrest. The following describes how these options can be adapted to the sitting posture of the user.

### 8.10.1 The headrest of the child seat

#### 8.10.1.1 Adjusting the angle / depth of the headrest

- Loosen the release handle (1, 2 or 3).
- Move the headrest to the desired position.
- Tighten the release handle.

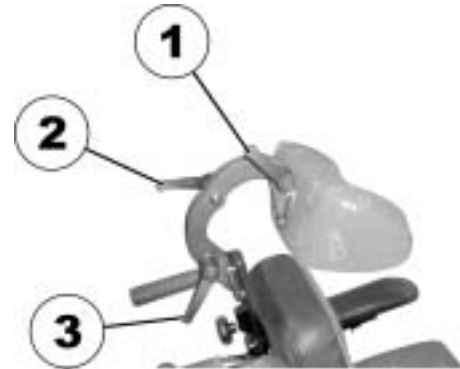

### 8.10.1.2 Adjusting the height of the headrest

- Loosen the clamping screw (1).
- Move the headrest to the desired height.
- Tighten the clamping screw.

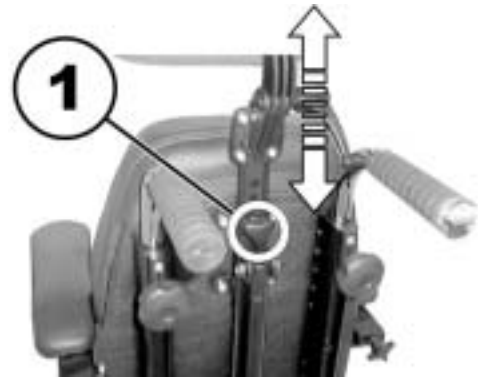



## 8.10.2 The armrests / setting the angle



---

### Pre-requisites:

- 13 mm open-ended spanner
- 

The adjusting screw for adjusting the angle of the armrest is to be found at the rear end of the armrest (A).



- Loosen the counternut (1) using the open-ended spanner.
- Adjust the limit stop/angle of the armrest by turning the adjusting screws (2).
- Tighten the counternut.

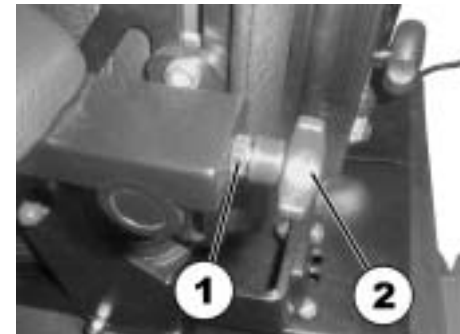

## 8.10.3 The backrest

### 8.10.3.1 Adjusting the height of the sliding handles (option)

- Loosen the hand wheel (1 or 2).
- Move the sliding handle to the desired position.
- Tighten the hand wheel.

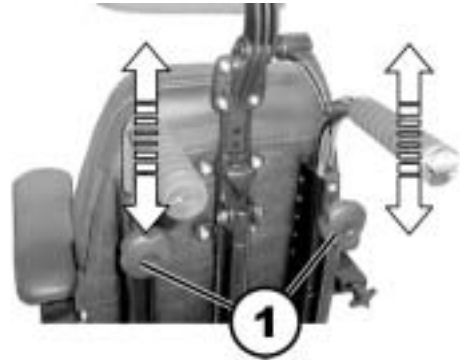

### 8.10.3.2 Adjusting the angle of the backrest electrically

The backrest can be optionally adjusted using an electric actuator. Please consult the instruction manual for your remote for information about electrical adjustment.

### 8.10.3.3 Adjusting the angle of the backrest manually

- Loosen the hand wheel (1).
- Move the backrest into the desired position.
- Tighten the hand wheel.

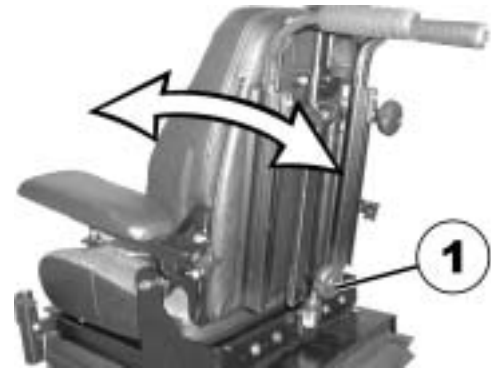

## 8.10.4 The legrest of the child seat

### 8.10.4.1 Setting the angle of the footrest



---

**Pre-requisites:**

- 5 mm Allen key
- 

- Loosen the Allen screws at both ends of the footrest (1) (only one side is shown in the illustration).
- Move the footrest to the desired position.
- Re-tighten the screws.

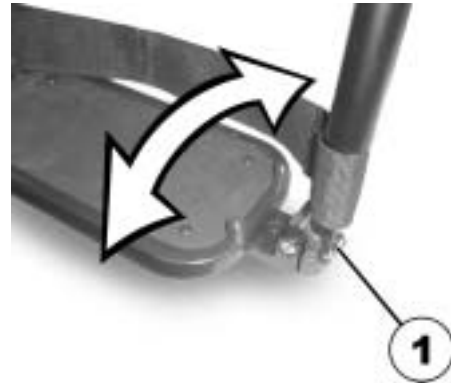

### 8.10.4.2 Swivelling the footrest upward / removing the legrest

In order to simplify getting into the vehicle and alighting, the footrest can be swivelled upward. The footrest must also be swivelled upward so that the width of the legrest can be adjusted or the legrest dismantled.



---

**Pre-requisites:**

- 5 mm Allen key
- 
- Loosen the Allen screw (1) on the left end of the footrest.
  - Open the belt with Velcro® fastener (2).
  - Swivel the footrest upward.

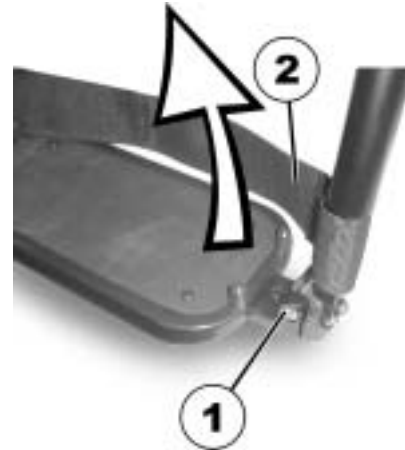

- Press the release button (1) and swivel the legrest outward.
- Remove the legrest in an upward direction.



### 8.10.4.3 Adjusting the width of the legrest

---



#### Pre-requisites:

- Flat screwdriver
  - 5 mm Allen key
  - 3 mm Allen key
  - 13 mm open-ended spanner
- 

- Swivel the footrest upward and dismantle the legrest (see section "**Swivelling the footrest upward / "** on page 77).
- The footrest has a non-slip rubber mat that is fastened at the corners by means of four plastic studs (1). The screws for adjusting the width of the footrest are to be found underneath the rubber mat.



- Remove the plastic studs carefully using a flat screwdriver.



- Remove the rubber mat.





- Remove the screws (1) using the 3 mm Allen key.
- Adjust the footrest bracket (2) to the desired width.
- Re-position and tighten the screws.

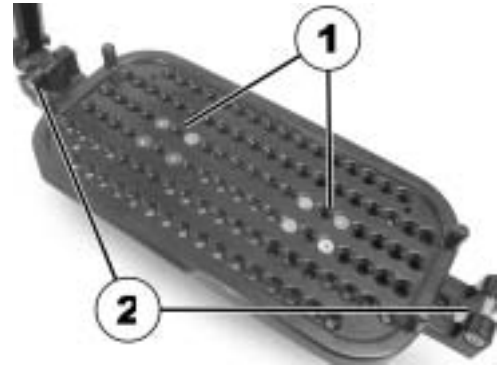

- If the width of the footrest has been altered, the width of the legrest brackets (1) on the wheelchair frame must be adapted appropriately.
- Loosen the four screws (2) using the 13 mm open-ended spanner.



- Swivel the footrest slightly upward so that the **legrest** halves can be turned inward without colliding.
- Hang the **legrest** halves on the left and right and turn inward until the locking mechanisms on both sides lock in place.

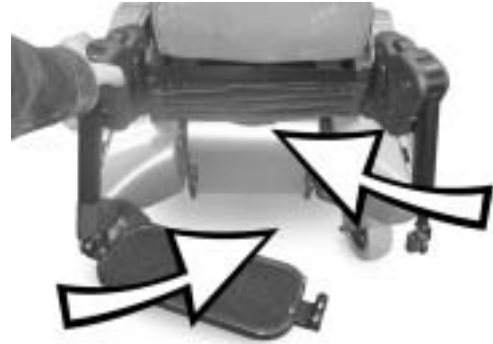

- Swivel the footrest downward. The footrest locking mechanism must fit exactly (1). For this adapt the width of the **legrest** brackets (2).



- Tighten the screw (1).
- Re-close the belt with the Velcro® fastener (2) .

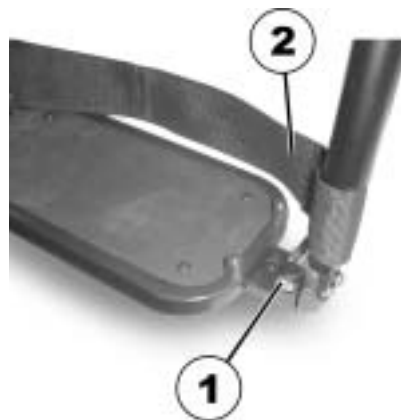

#### 8.10.4.4 Adjusting the length of the legrest



---

**Pre-requisites:**

- 5 mm Allen key
- 
- Loosen the screw (1).
  - Adjust the lower leg length.
  - Tighten the screw.



### 8.10.4.5 Adjusting the angle of the legrest

---



#### Pre-requisites:

- 6 mm Allen key
  - Metal pin 3 mm  $\varnothing$ , approx. 10 cm long
  - Hammer
- 

- Loosen the screw (1).
- Insert the metal pin into the hole (2) and knock lightly with the hammer in order to loosen the halves of the plastic jacket.
- Adjust the angle.
- Tighten the screw.

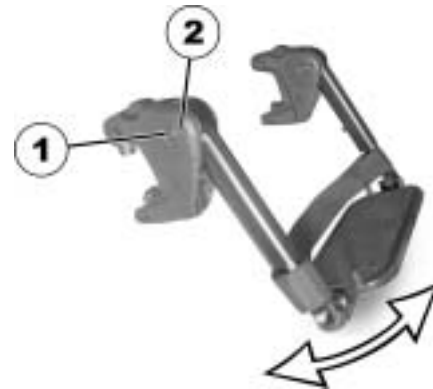

- Loosen the screw (1).
- Insert the metal pin into the hole (2) and knock lightly with the hammer in order to loosen the halves of the plastic jacket.
- Adjust the angle.
- Tighten the screw.

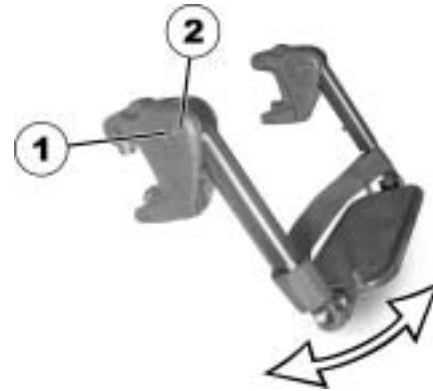

- Loosen the screw (1).
- Insert the metal pin into the hole (2) and knock lightly with the hammer in order to loosen the halves of the plastic jacket.
- Adjust the angle.
- Tighten the screw.

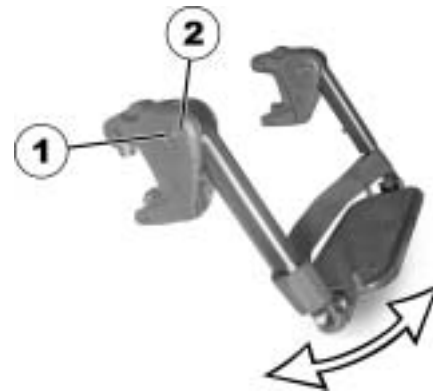

## 8.11 Using the KLICKfix adapter

Your wheelchair can be fitted with the mini-adapter from the Rixen + Kaul KLICKfix system. To this you can attach various accessories such as the cellphone case supplied by Invacare, which you can use to transport your cellphone, sports glasses etc.



---

**CAUTION! Risk posed by unsecured accessories! Accessories can fall off and get lost if they are not properly secured.**

- *Check that the accessory is correctly locked in and seated securely every time you use the wheelchair.*
- 



---

**CAUTION! Risk of breakage due to excessive load! The KLICKfix adapter can break if too great a load is applied.**

- *The maximum permitted load on the KLICKfix adapter is 1 kg.*
- 

### **Securing the accessory:**

- Push the accessory into the KLICKfix adapter.  
The accessory locks in securely.

### **Removing the accessory:**

- Press the red button and remove the accessory.

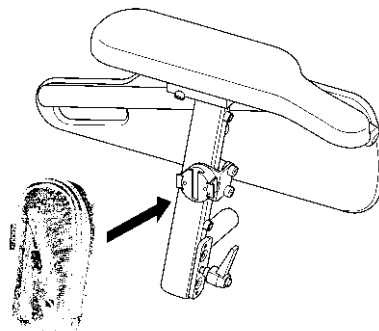



The adapter can turn in 90° steps, allowing you to attach an accessory from any of four different directions. Please refer to the installation instructions which are available from your Invacare® dealer or directly from Invacare®.

More information on the KLICKfix system is available at <http://www.klickfix.com>.

## **9 Adjusting footrests and legrests**

### **9.1 Centre-mounted legrests**

#### **9.1.1 Electric legrest**

Please consult the user manual for your remote for information about electrical adjustment.

#### **9.1.2 Manually adjustable leg rest**

##### **9.1.2.1 Removing the leg rest**

You can remove the central, manually adjustable leg rest completely.

- Remove the removable axle (1).

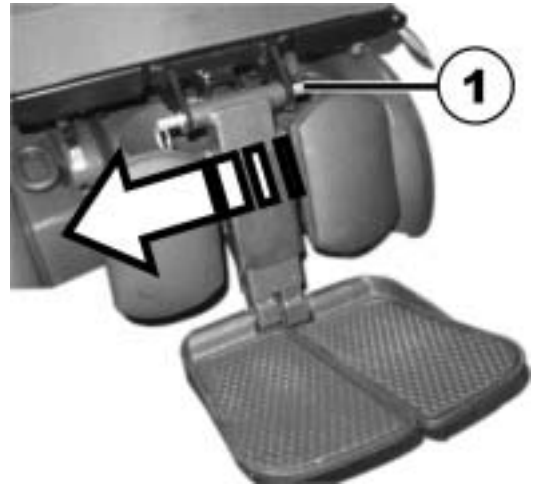

- Hold the leg rest securely and pull the lever (1).
- Remove the leg rest from the holder (2).



### 9.1.2.2 Setting the angle of the leg rest



---

#### **CAUTION!**

If the leg rest is not secured and the lever (1) is removed, the leg rest will drop suddenly, which could cause an injury.

- *Secure the leg rest before you remove the lever to adjust the angle of the leg rest.*
- 

- Hold the leg rest securely.
- Pull the lever (1).
- Push the leg rest into the required position.



### 9.1.2.3 Setting the length of the leg rest



---

**Required items:**

- 1x Allen key 3/16"
- 

You can adjust the length of the leg rests independently of one another.

- Release the bolts (1) on the rear of the leg rest using the Allen key.
- Set the desired length.
- Retighten the bolts.



#### 9.1.2.4 Setting the angle of the footplate



---

**Required items:**

- 1x Allen key 5/32"
- 
- Fold the footplates up in order to access the adjusting screws (1).
  - Set the adjusting screws using the Allen key.
  - Fold the footplate down again.



### 9.1.2.5 Setting the angle and height of the calf pad



---

**Required items:**

- 1x Allen key 3/16"
- 

- Fold the calf pad forward in order to access the bolt (1).
- Loosen the bolt using the Allen key and adjust the calf pad to the required angle and height.
- Retighten the bolt.
- Fold the calf pad back.



## 9.2 Laterally mounted legrests

### 9.2.1 Vari-F footrest

#### 9.2.1.1 Swivelling the footrest outward and/or removing

The small unlocking button is located on the upper section of the footrest. When the footrest is unlocked, it can be swivelled inward or outward when getting into the wheelchair as well as being removed completely.

- Press the unlocking button (1) and swivel the footrest outward.
- Remove the footrest in an upward direction.



### 9.2.1.2 Setting the angle



---

**PLEASE NOTE: Danger of injury due to incorrect adjustment of the footrests and legrests.**

- *Before and during every journey it is imperative to ensure that the legrests contact neither the castor wheels nor the ground!*
- 



**Pre-requisites:**

- 1x 6 mm Allen key
- 

- Loosen the screw (1) using the Allen key.
- If the footrest cannot be moved after loosening the screw, position a metal pin in the designated borehole (2) and use a hammer to knock on this lightly. The clamping mechanism in the interior of the footrest will be released by this. Repeat the procedure from the other side of the footrest if necessary.





- Loosen the screw (1) using the Allen key.
- Set the desired angle.
- Re-tighten the screw.



### 9.2.1.3 Setting the end stop of the footrest



---

**Pre-requisites:**

- 1x 6 mm Allen key
  - 1x 10 mm open-ended spanner
- 

The end position of the footrest is determined by means of a rubber stop (1).



The rubber stop can be screwed in or out (A) or pushed up or down (B).



- Use the Allen key to loosen the screw (1) and swivel the footrest upward in order to access the rubber stop.



- Use the open-ended spanner to loosen the counternut (1).



- Move the rubber stop to the desired position
- Re-tighten the counternut



- Move the footrest to the desired position.
- Re-tighten the screw.



#### 9.2.1.4 Adjusting the length of the footrest



---

**PLEASE NOTE: Danger of injury due to incorrect adjustment of the footrests and legrests.**

- *Before and during every journey it is imperative to ensure that the legrests contact neither the castor wheels nor the ground!*
- 



**Pre-requisites:**

- 1x 5 mm Allen key
- 

- Use the spanner to loosen the screw (1).
- Adjust to the desired length.
- Re-tighten the screw.



## 9.2.2 Vari-A legrests

### 9.2.2.1 Swivelling the legrest outward and/or removing

The small unlocking button is located on the upper section of the legrest. When the legrest is unlocked, it can be swivelled inward or outward when getting into wheelchair as well as being removed completely.

- Press the unlocking button (1) and swivel the legrest outward.
- Remove the legrest in an upward direction.



### 9.2.2.2 Setting the angle



---

**PLEASE NOTE: Danger of injury due to incorrect adjustment of the footrests and legrests.**

- *Before and during every journey it is imperative to ensure that the legrests contact neither the castor wheels nor the ground!*
- 

- Loosen the locking knob (1) counter-clockwise at least one turn.

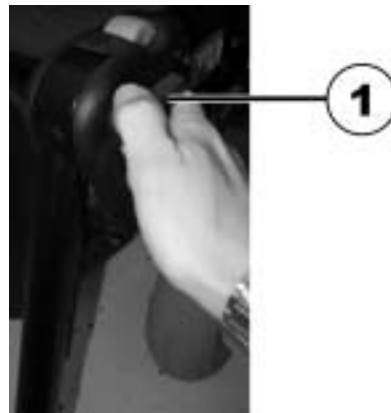

- Hit the knob to release the locking mechanism.



- Set the desired angle.





- Turn the knob clockwise to tighten it.



### 9.2.2.3 Setting the end stop of the legrest



---

#### Pre-requisites:

- 1x 10 mm open-ended spanner
- 

The end position of the legrest is determined by means of a rubber stop (A).



The rubber stop can be screwed in or out (A) or pushed up or down (B).



- Loosen the locking knob (1) counter-clockwise at least one turn.

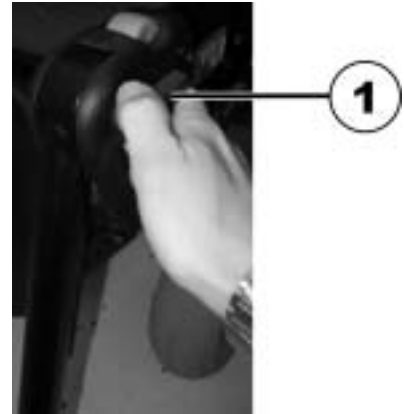

- Hit the knob to release the locking mechanism.



- Swivel the legrest upward in order to access the rubber stop.



- Use the open-ended spanner to loosen the counternut (1).



- Move the rubber stop to the desired position
- Re-tighten the counternut



- Move the legrest to the desired position.
- Re-tighten the locking knob.



#### 9.2.2.4 Adjusting the length of the legrest



---

**PLEASE NOTE: Danger of injury due to incorrect adjustment of the footrests and legrests.**

- *Before and during every journey it is imperative to ensure that the legrests contact neither the castor wheels nor the ground!*
- 



**Pre-requisites:**

- 1x 6 mm Allen key
- 

- Use the spanner to loosen the screw (1).
- Adjust to the desired length.
- Re-tighten the screw.



### 9.2.2.5 Adjusting the depth of the calf plate

The depth of the calf plate can be adjusted via the holding plate. The holding plate hole combinations allow 5 different depth settings.



---

**Pre-requisites:**

- 1x 10 mm open-ended spanner
- 
- Use the open-ended wrench to loosen the nut (1) and remove.
  - Adjust to the desired depth. Please observe that the round holes are intended for the calf plate retaining screw and the oblong holes for the aglet without thread.
  - Screw the nut back on and tighten.



### 9.2.2.6 Adjusting the height of the calf pad



---

**Pre-requisites:**

- 1x 4 mm Allen key
- 
- Use the Allen key to loosen the screws (1).
  - Adjust to the desired position.
  - Re-tighten the screws.





### 9.2.2.7 Unlocking and swivelling the calf plate backward when alighting

- Press the calf plate straight down.



- Unlock the legrest and swivel outward. The calf plate swivels backward on its own.



- Lift leg over the heel strap and place on the ground.



### 9.2.2.8 Adjusting the angle adjustable foot plate



---

**Pre-requisites:**

- 1x 5 mm Allen key
- 

- Use the Allen key to loosen both set screws on the foot plate.
- Adjust to the desired angle.
- Re-tighten the screws.



### 9.2.2.9 Adjusting the angle and depth adjustable foot plate

---



#### Pre-requisites:

- 1x 5 mm Allen key
- 
- Use the Allen key to loosen the set screw on the foot plate (1).
  - Adjust the foot plate to the desired angle or depth.
  - Re-tighten the screw.



## 9.2.3 ADM legrests

### 9.2.3.1 Swivelling the legrest outward and/or removing

The small unlocking button is located on the upper section of the legrest. When the legrest is unlocked, it can be swivelled inward or outward when getting into wheelchair as well as being removed completely.

- Press the unlocking button(1) and swivel the legrest outward.
- Remove the legrest in an upward direction.



### 9.2.3.2 Setting the angle



---

**PLEASE NOTE: Danger of crushing!**

- *Do not reach inside the swivelling range of the legrest!*
- 



---

**PLEASE NOTE: Danger of injury due to incorrect adjustment of the footrests and legrests.**

- *Before and during every journey it is imperative to ensure that the legrests contact neither the castor wheels nor the ground!*
- 

- Raising: Pull the legrest upward until the desired angle has been achieved.



- Lowering: Keep the legrest in the foot plate area, pull the lateral adjusting lever (1) and lower the legrest slowly.



### 9.2.3.3 Adjusting the length of the legrest



---

**PLEASE NOTE: Danger of injury due to incorrect adjustment of the footrests and legrests.**

- *Before and during every journey it is imperative to ensure that the legrests contact neither the castor wheels nor the ground!*
- 



**Pre-requisites:**

- 1x 5 mm Allen key
- 

- Use the spanner to loosen the screw (1).
- Adjust to the desired length.
- Re-tighten the screw.



#### 9.2.3.4 Adjusting the depth of the calf plate

The depth of the calf plate can be adjusted via the holding plate. The holding plate hole combinations allow 5 different depth settings.



---

**Pre-requisites:**

- 1x 10 mm open-ended spanner
- 
- Use the open-ended wrench to loosen the nut (1) and remove.
  - Adjust to the desired depth. Please observe that the round holes are intended for the calf plate retaining screw and the oblong holes for the aglet without thread.
  - Screw the nut back on and tighten.





### 9.2.3.5 Adjusting the height of the calf pad



---

**Pre-requisites:**

- 1x 4 mm Allen key
- 

- Use the Allen key to loosen the screws (1).
- Adjust to the desired position.
- Re-tighten the screws.



### 9.2.3.6 Unlocking and swivelling the calf plate backward when alighting

- Press the calf plate straight down.



- Unlock the legrest and swivel outward. The calf plate swivels backward on its own.



- Lift leg over the heel strap and place on the ground.



### 9.2.3.7 Adjusting the angle adjustable foot plate



---

**Pre-requisites:**

- 1x 5 mm Allen key
- 

- Use the Allen key to loosen both set screws on the foot plate.
- Adjust to the desired angle.
- Re-tighten the screws.



### 9.2.3.8 Adjusting the angle and depth adjustable foot plate



---

**Pre-requisites:**

- 1x 5 mm Allen key
- 
- Use the Allen key to loosen the set screw on the foot plate (1).
  - Adjust the foot plate to the desired angle or depth.
  - Re-tighten the screw.



## 9.2.4 ADE legrests

### 9.2.4.1 Swivelling the legrest outward and/or removing

The small unlocking button is located on the upper section of the legrest. When the legrest is unlocked, it can be swivelled inward or outward when getting into wheelchair as well as being removed completely.

- Press the unlocking button (1) and swivel the legrest outward.
- Remove the legrest in an upward direction.



#### 9.2.4.2 Setting the angle



---

**PLEASE NOTE: Danger of crushing!**

- *Do not reach inside the swivelling range of the legrest!*
- 



---

**PLEASE NOTE: Danger of injury due to incorrect adjustment of the footrests and legrests.**

- *Before and during every journey it is imperative to ensure that the legrests contact neither the castor wheels nor the ground!*
- 

The electrically height-adjustable legrests are operated using the remote. Please see the separate operating manual for your remote for more information.

### 9.2.4.3 Adjusting the length of the legrest



---

**PLEASE NOTE: Danger of injury due to incorrect adjustment of the footrests and legrests.**

- *Before and during every journey it is imperative to ensure that the legrests contact neither the castor wheels nor the ground!*
- 



**Pre-requisites:**

- 1x 10 mm open-ended spanner
- 

- Use the spanner to loosen the screw (1).
- Adjust to the desired length.
- Re-tighten the screw.



#### 9.2.4.4 Adjusting the depth of the calf plate

The depth of the calf plate can be adjusted via the holding plate. The holding plate hole combinations allow 5 different depth settings.



---

**Pre-requisites:**

- 1x 10 mm open-ended spanner
- 

- Use the open-ended wrench to loosen the nut (1) and remove.
- Adjust to the desired depth. Please observe that the round holes are intended for the calf plate retaining screw and the oblong holes for the aglet without thread.
- Screw the nut back on and tighten.





### 9.2.4.5 Adjusting the height of the calf pad



---

**Pre-requisites:**

- 1x 4 mm Allen key
- 

- Use the Allen key to loosen the screws (1).
- Adjust to the desired position.
- Re-tighten the screws.



#### 9.2.4.6 Unlocking and swivelling the calf plate backward when alighting

- Press the calf plate straight down.



- Unlock the legrest and swivel outward. The calf plate swivels backward on its own.



- Lift leg over the heel strap and place on the ground.



#### 9.2.4.7 Adjusting the angle adjustable foot plate



---

**Pre-requisites:**

- 1x 5 mm Allen key
- 

- Use the Allen key to loosen both set screws on the foot plate.
- Adjust to the desired angle.
- Re-tighten the screws.



#### 9.2.4.8 Adjusting the angle and depth adjustable foot plate



---

**Pre-requisites:**

- 1x 5 mm Allen key
- 
- Use the Allen key to loosen the set screw on the foot plate (1).
  - Adjust the foot plate to the desired angle or depth.
  - Re-tighten the screw.



## 9.2.5 Adjusting the width of side-mounted legrests



---

### Pre-requisites:

- 13 mm open-ended spanner
- 

The screws that allow width adjustment of side-mounted legrests are located under the seat (1).

- Loosen the screws using the open-end spanner.
- Adjust the legrest to the desired position.
- Re-tighten the screws.



# 10 Electrical system

## 10.1 Electronics protection system

The vehicle drive electronics is fitted with an overload protection.

If the drive is severely overloaded over a long period (e.g. during steep climbs) and, above all, at simultaneous high external temperatures, the electronic system can overheat. In this case, the vehicle performance is gradually reduced until it comes to a standstill. The status display shows a corresponding blink code (please refer to the user manual for your remote). If you switch the drive electronics off and then on again, the error message is deleted and the electronics can be switched on again. It can however take up to five minutes until the electronics has cooled down enough for the drives to apply their full performance.

If the drive is blocked due to an insurmountable obstacle, for example a kerb or similar which is too high, and the driver attempts to run the drive for more than 20 seconds against this obstacle, the electronic system switches the drives off to avoid damage. The status display shows a corresponding flash code (please refer to the user manual for your remote). If you switch the drive electronics off and then on again, the error message is deleted and the electronics can be switched on again.

## 10.1.1 The main fuse



---

### NOTE

A defective main fuse may be replaced only after checking the entire electric system. An Invacare® specialised dealer must perform the replacement. You can find information on the fuse type in chapter "**Technical specifications**" starting on page **162**.

---

All electrical equipment fitted to the wheelchair is protected against overload by the main fuse.

The main fuse is located beneath the rear central panel to the left of the power module.

In order to access the main fuse, you must first remove the rear panel.

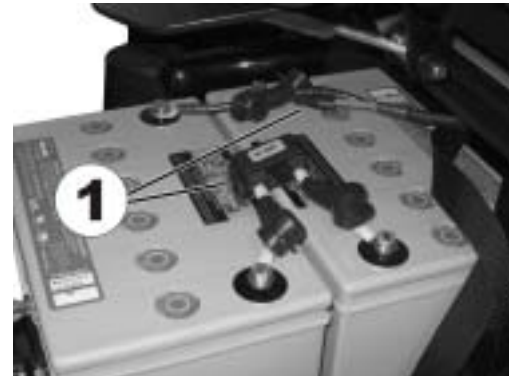

## **10.2 Batteries**

Power is supplied by two 12 V batteries. The batteries are maintenance-free and only need regular charging.

In the following, you find information on how to charge, handle, transport, store, maintain, and use batteries.

### **10.2.1 Charging the batteries**

#### **10.2.1.1 General information on charging**

New batteries should always be fully charged once before their first use. New batteries will be at their full capacity after having run through approx. 10 - 20 charging cycles (break-in period). This break-in period is necessary to fully activate the battery for maximum performance and longevity. Thus, range and running time of your mobility device could initially increase with use.

Gel/AGM lead acid batteries do not have a memory effect as NiCd batteries.

#### **10.2.1.2 General instructions on charging**

Follow the instructions listed below to ensure safe use and longevity of the batteries:

- Charge 12 hours prior to initial usage.
- We recommend charging the batteries daily after every discharge even after partly discharge, as well as each night over night. Depending on the level of discharge, it can take up to 12 hours until the batteries are fully charged again.
- When the battery indicator reached the red LED range, charge the batteries for 16 hours minimum, neglecting the charge complete display!
- Try to provide a 24 hour charge once a week to make sure that both batteries are fully charged.



- Do not cycle your batteries at a low state of charge without regularly recharging them fully.
- Do not charge your batteries under extreme temperatures. High temperatures above 30 °C are not recommended for charging as well as low temperatures below 10 °C.
- Use only charging devices in Class 2. This class of chargers may be left unattended during charging. All charging devices which are supplied by Invacare® comply with these requirements.
- You cannot overcharge the batteries when using the charger supplied with your vehicle, or a charger that has been approved by Invacare®.
- Protect your charger from sources of heat such as heaters and direct sunlight. If the battery charger overheats, charging current will be reduced and the charging process delayed.

### **10.2.1.3 How to charge the batteries**

Please see the instruction manuals for your remote and battery charger for the position of the charging socket and further information about charging the batteries.



---

**WARNING!****Risk of explosion and destruction of batteries if the wrong battery charger is used!**

- *Only ever use the battery charger supplied with your vehicle, or a charger that has been approved by Invacare®.*

**Risk of electric shock and damage to the battery charger if it gets wet!**

- *Protect the battery charger from water.*
- *Always charge in a dry environment.*

**Risk of short circuit and electric shock if the battery charger has been damaged!**

- *Do not use the battery charger if it has been dropped or damaged.*

**Risk of electric shock and damage to the batteries!**

- *NEVER attempt to recharge the batteries by attaching cables directly to the battery terminals.*

**Risk of fire and electric shock if a damaged extension cable is used!**

- *Only ever use an extension cable if it is absolutely necessary. In case you must use one, make sure it is in good condition.*

**Risk of injury if using the wheelchair during charging!**

- *DO NOT attempt to recharge the batteries and operate the wheelchair at the same time.*
  - *DO NOT sit in the wheelchair while charging the batteries.*
- 

- Switch off the mobility device.
- Connect the battery charger to the charger socket.
- Connect the battery charger to the power supply.

**10.2.1.4 How to disconnect the batteries after charging**

- Once charging is complete, first disconnect the battery charger from the power supply, then disconnect the plug from the remote.

## 10.2.2 Storage and Maintenance

Follow the instructions listed below to ensure safe use and longevity of the batteries:

- Always store the batteries fully charged.
- Do not leave the batteries in a low state of charge for an extended length of time. Charge a discharged battery as soon as possible.
- In case your mobility device is not used for a longer period of time (that is more than two weeks), the batteries must be charged at least once a month to maintain a full charge and always be charged before use.
- Avoid hot and cold extremes when storing. We recommend to store batteries at a temperature of 15 °C.
- Gel and AGM batteries are maintenance-free. Any performance issues should be handled by a properly trained mobility device technician.

## 10.2.3 Instructions on using the batteries



---

### **CAUTION! Risk of damaging the batteries.**

- *Avoid ultra-deep discharges and never drain your batteries completely.*
- 

- Pay attention to the Battery Charge Indicator! Charge the batteries when the Battery Charge Indicator shows that battery charge is low.

How fast the batteries discharge depends on many circumstances, such as ambient temperature, condition of the surface of the road, tyre pressure, weight of the driver, way of driving and utilisation of lighting.

- Try to charge the batteries always before you reach the red LED range.

The last 3 LED (two red and one orange) mean a remaining capacity of about 15 %.

- Driving with blinking red LED's means an extreme stress for the battery and should be avoided under normal circumstances.
- When only one red LED is blinking, the Battery Safe feature is enabled. From this time, speed and acceleration is reduced drastically. It will allow you to move the mobility device slowly out of a dangerous situation before the electronic finally cuts off. This is deep discharging and should be avoided.
- Be aware that for temperatures below 20 °C, the nominal battery capacity starts to decline. For example, at -10 °C the capacity is reduced to about 50 % of the nominal battery capacity.
- To avoid damaging the batteries, never allow them to be fully discharged. Do not drive on heavily discharged batteries if it is not absolutely necessary, as this will strain the batteries unduly and shorten their life expectancy.
- The earlier you recharge the batteries, the longer they live.
- The depth of discharge affects the cycle life. The harder a battery has to work, the shorter is its life expectancy.

Examples:

- One deep discharge stresses the same as 6 normal cycles (green /orange display off).
- The battery life is about 300 cycles at 80% discharge (first 7 LED off), or about 3000 cycles at 10% discharge (one LED off).



**NOTE:**

The number of LED can vary depending on the remote type.

---

- Under normal operation, once a month the battery should be discharged until all green and orange LED are off. This should be done within one day. A 16 hour charge afterwards is necessary as reconditioning.

## **10.2.4 Transporting batteries**

The batteries supplied with your electric vehicle are not hazardous goods. This classification is based on the German GGVS Hazardous Goods Road Transport Ordinances, and the IATA/DGR Hazardous Goods Rail Transport / Air Transport Ordinances. Batteries may be transported without restrictions, whether by road, rail or by air. Individual transport companies have, however, guidelines which can possibly restrict or forbid certain transport procedures. Please ask the transport company regarding each individual case.

## **10.2.5 Handling batteries**

### **10.2.5.1 General instructions on handling the batteries**

- Never mix and match different battery manufactures or technologies, or use batteries that do not have similar date codes.
- Never mix gel with AGM batteries.
- Always have your batteries installed by a properly trained mobility device technician. They have the necessary training and tools to do the job safely and correctly.

### **10.2.5.2 How to handle damaged batteries correctly**



---

**WARNING:****Corrosion and burns from acid leakage if batteries are damaged!**

- *Remove clothes that have been soiled by acid immediately.*

**After contact with skin:**

- *Immediately wash affected area with lots of water.*

**After contact with eyes:**

- *Immediately rinse eyes under running water for several minutes; consult a physician.*
- 

- Always wear safety goggles and appropriate safety clothing when handling damaged batteries.
- Place damaged batteries in an acid-resistant receptacle immediately after removing them.
- Only ever transport damaged batteries in an appropriate acid-resistant receptacle.
- Wash all objects that have come into contact with acid with lots of water.

**Disposing of dead or damaged batteries correctly**

Dead or damaged batteries can be given back to your dealer or directly to Invacare®.

### 10.2.5.3 Removing the batteries



---

**CAUTION: Risk of fire and burns if battery poles are bridged!**

- *When replacing the batteries the battery poles MUST NOT come into contact with metal parts of the wheelchair causing bridging.*
  - *Be sure to replace the battery pole caps after the batteries have been replaced.*
- 



---

**WARNING: Risk of fire and burns due to damage to the battery cables!**

- *The battery cables and other cables are positioned in a cable duct above the batteries. The cable duct protects the cables against crushing and other damage. It may not be removed.*
- 



---

**Requirements:**

- Allen key 1/4 inch
  - jaw spanner 11 mm
-

- Remove the side-mounted legrests if fitted. A centrally-fitted, manually adjustable legrest should be put in its top position by turning the spindle (1).



- Remove the screws on the panelling (1) using the 1/4" Allen key.

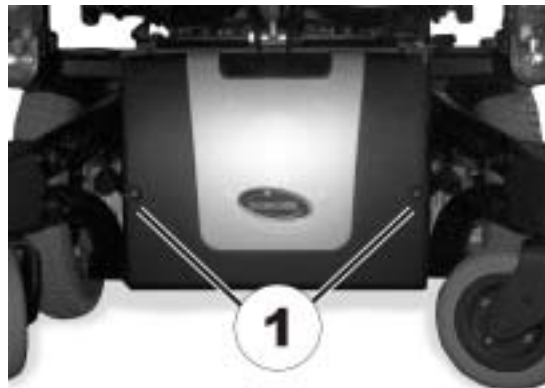



- Remove the panelling.

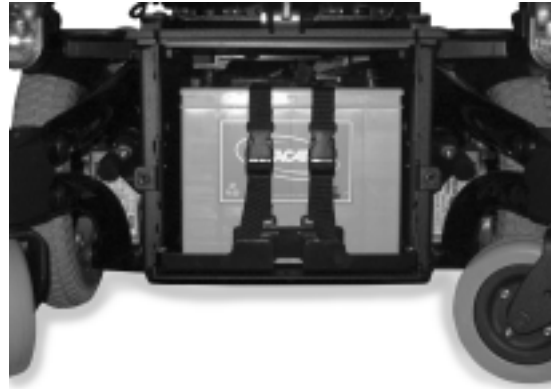

- Pull the batteries forwards out of the slide.



- Remove the terminal cover from the battery terminals (1).
- First undo the bolt on the negative terminal (black cable) with the 11 mm jaw spanner.
- After this, undo the bolt on the positive terminal (red cable).



---

**CAUTION! Danger of crushing!**

- *The batteries are extremely heavy. Please ensure that they do not fall to the ground when they are removed from the chassis.*
- 
- Installation takes place in reverse order.
  - Check all vehicle functions.
  - Check the new battery status and charge completely.

# 11 Care and maintenance

The following are instructions on maintenance and repairs that can be performed by the user. For the specifications of spare parts please see "**Technical specifications**" on page **162**, or consult the Service Manual, available from Invacare® (in this connection please see the addresses and phone numbers in section "**How can you get in touch with Invacare®?**" on page **3**). In case you require assistance, please contact your Invacare® Dealer.



---

## **NOTE:**

Have your vehicle checked once a year by an authorised Invacare® dealer in order to maintain it's driving safety and roadworthiness.

---

## **Cleaning the vehicle**

When cleaning the vehicle, pay attention to the following points:

- Only use a damp cloth and gentle detergent.
- Do not use any abrasive or scouring liquids.
- Do not subject the electronic components to any direct contact with water.
- Do not use high-pressure cleaning devices.

## **Disinfection**

Spray or wipe disinfection using a tested and recognised product is permitted. A list of the current permitted disinfectants is available from the Robert Koch Institute at <http://www.rki.de>.

<b>Maintenance Jobs</b>	On delivery	Weekly	Monthly
<b>Seat and backrest padding:</b>			
- Check for perfect condition.			✓
<b>Side part and armrest:</b>			
- Are all fixing elements installed?	✓	✓	
- Can armrests / side panels be removed and installed without too much physical effort?		✓	
- Are armrests secured in their positions?		✓	
<b>Legrests:</b>			
- Do legrests lock into place without any problem (only applies to detachable legrests)?			✓
- Do the various adjustment functions work without any problem?			✓
<b>Tyres:</b>			
- Check tyres for specified air pressure (see Technical Specifications).	✓	✓	
<b>Anti-tippers</b>			
- Check the anti-tippers for smooth running.		✓	
<b>Anti-tipper blocking mechanism</b>			
- Check the anti-tipper blocking mechanism for correct functioning.		✓	
<b>Front wheel forks / Front wheels</b>			
- Front wheels must be running smoothly.		✓	
- Check fork bearing for tight fitting (torque 15 Nm +/- 1,5 Nm).			✓
<b>Rear wheels:</b>			
- Test wheel for tight fitting on the axle drive shaft.			✓

- Rear wheels must rotate without wobbling			✓
<b>Electronics / Electrical System:</b>			
- Check all plug connections for condition and tight fit.			✓
- Have batteries been fully charged before daily operation?	Before every trip		
- Are all fixings tight and secure?			
- Are all lighting system bulbs in working order?	Before every trip		
<b>Cleaning:</b>			
- Clean all parts carefully.	When necessary		

**To ensure driving safety and roadworthiness, you should have your wheelchair inspected and serviced by your authorised dealer once a year. A complete checklist of necessary maintenance work can be found in the Workshop Manual, which can be obtained from Invacare®.**

## 12 Transport



**CAUTION:** Injury hazard or material damage if a power wheelchair which is fitted with a table is transported in a vehicle!

- *If a table is fitted, always remove it before transporting the wheelchair.*



### 12.1 Transferring the wheelchair to a vehicle



**WARNING:** The wheelchair is in danger of tipping over if it is transferred to a vehicle while the driver is still seated in the wheelchair!

- *Transfer the wheelchair without the driver whenever possible!*
- *If the wheelchair with the driver has to be transferred to a vehicle using a ramp, ensure that the ramp does not exceed the maximum safe slope (see chapter "**Technical specifications**" starting on page 162)!*
- *If the wheelchair has to be transferred to a vehicle using a ramp that does exceed the maximum safe slope (see chapter "**Technical specifications**" starting on page 162), a winch must then be used! An attendant can then safely monitor and assist the transfer process!*
- *Alternatively, a platform lift may be used!*
- *Ensure that the total weight of the power wheelchair including the user does not exceed the maximum permitted total weight for the ramp or platform lift!*
- *The wheelchair should always be transferred to a vehicle with the backrest in an upright position, the seat lifter lowered and the seat tilt in the upright position (see chapter "**Driving up and down gradients**" on page 39)!*

- Drive or push your wheelchair into the transport vehicle using a suitable ramp.

## 12.2 Use of the wheelchair as a seat in a vehicle

---



**WARNING: Danger of death or serious injury to the wheelchair user and potentially any other nearby occupant of the vehicle, if a wheelchair is secured using a 4-point tie-down system available from a third party supplier and the unladen weight of the wheelchair exceeds the maximum weight for which the system is certified!**

- *The actual weight of this wheelchair can exceed 140 kg! A suitably strong and proven 4-point tie-down system is available from Unwin Safety Systems! Please contact Unwin for more information on how to obtain such a system in your country!*

*Unwin Safety Systems*

*Phone: + 44 (0)1935 827740*

*Email: [sales@unwin-safety.co.uk](mailto:sales@unwin-safety.co.uk)*

*Web: [www.unwin-safety.com](http://www.unwin-safety.com)*

- *An alternative way to safely use this wheelchair as a vehicle seat may be by using the Docking Station system if the wheelchair is compatible with that system, available separately! Please contact Invacare if you require the details.*
- 



**WARNING: Danger of injury or damage to the wheelchair or to the transporting vehicle, if the legrests are in a raised position while the wheelchair is used as a vehicle seat!**

- *Always completely lower height-adjustable legrests, if fitted.*
-



---

**Caution: There is a danger of injury if the wheelchair is not properly secured during use as a vehicle seat!**

- *If possible, the user should always leave the wheelchair to use a vehicle seat and the safety belts provided with the vehicle.*
  - *The wheelchair should always be anchored facing in the transport vehicle's intended direction of travel.*
  - *The wheelchair must always be secured in accordance with the wheelchair and anchoring system manufacturers' operating manual.*
  - *Always remove and secure any accessory parts fixed to the wheelchair such as chin controls or tables.*
  - *If your wheelchair is equipped with an angle adjustable backrest, then it must be placed in an upright position.*
  - *Fully lower elevated legrests, if fitted.*
  - *Fully lower the seat lifter, if fitted.*
- 



---

**WARNING: Danger of injury exists if a powerchair that is not equipped spill-proof batteries is transported in a vehicle!**

- *Only ever use spill-proof gel batteries!*
-





---

**Please note**

In order to use a wheelchair as a motor vehicle seat, it needs to be equipped with attachment points to enable anchoring in the motor vehicle. These accessories may be included in the standard scope of wheelchair order and delivery in some countries (UK for example), but may also be obtained from Invacare® as an option in other countries.

---

This power wheelchair complies with the requirements of ISO 7176-19:2001 and may be used as a vehicle seat in connection with an anchoring system that has been checked and approved in accordance with ISO 10542. The wheelchair has undergone a crash test in which it was anchored in the transporting vehicle's direction of travel. Other configurations were not tested. The crash test dummy was secured using pelvic and upper body safety belts. Both types of safety belt should be used in order to minimise the risk of injuries to head or upper body. It is imperative that the wheelchair is inspected by an authorised dealer before being used again after being involved in a crash. Alterations to the wheelchair anchoring points may not be carried out without the manufacturer's permission.

## 12.2.1 How the wheelchair is anchored in a vehicle for use as a vehicle seat

The power wheelchair is fitted with four anchoring points, which are labelled with the symbol shown on the right. Snap hooks or belt loops can be used for fixation.



- Secure the wheelchair at the front (1) and at the rear (2) with the anchoring system belts.
- Secure the wheelchair by tensioning the belts in accordance with the anchoring system manufacturer's operating manual.



## 12.2.2 How the user is secured within the wheelchair

---



**CAUTION: There is a danger of injury if the user is not properly secured within the wheelchair!**

- *Even if the wheelchair is fitted with a postural belt, this is no substitute for a proper safety belt which complies with ISO 10542 in the transport vehicle. Always use the safety belt installed in the transport vehicle.*
  - *Safety belts must be in contact with the user's body. They must not be held at a distance from the user's body using parts of the wheelchair such as armrests or wheels. Refer to the illustration on page 157.*
  - *Safety belts must be pulled as tightly as possible without causing the user discomfort. Refer to the illustration on page 157.*
  - *Safety belts must not be positioned while twisted.*
  - *Ensure that the third seatbelt anchorage point is not fixed directly to the vehicle floor, but to one of the vehicle uprights.*
-



---

**CAUTION: Injury hazard during use of the mobility aid as a vehicle seat if a headrest is wrongly adjusted or not installed! This can cause the neck to be hyperextended during collisions!**

- *A headrest must be installed! The headrest optionally supplied for this mobility device by Invacare® is perfectly suitable for use during transport.*
- *The headrest must be adjusted to the user's ear height.*





Seat belts may not be held at a distance from the user's body using parts of the wheelchair such as armrests or wheels.

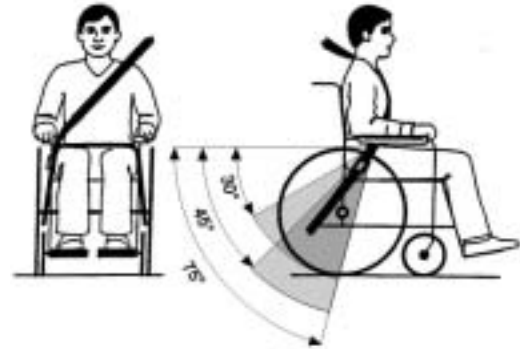

The pelvic belt should be positioned in the area between the user's pelvis and thighs so that it is unobstructed and not too loose. The ideal angle of the pelvic belt to the horizontal is between 45° and 75°. The maximum permissible angle is between 30° and 75°. The angle should never be less than 30°!

The safety belt installed in the transporting vehicle should be applied as shown in the illustration at right.

- 1) Centre line of the body
- 2) Centre of the sternum

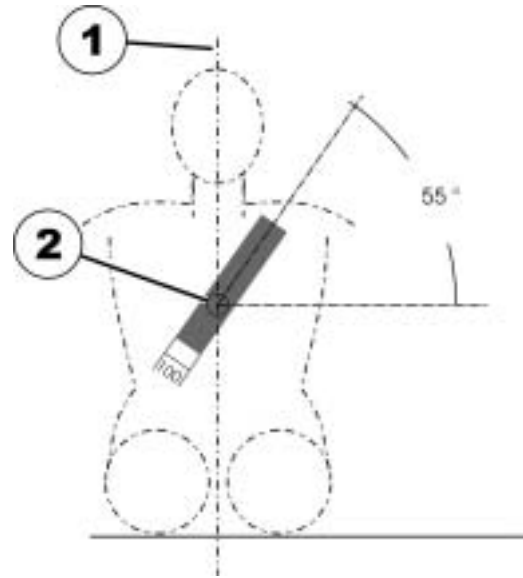

## 12.3 Securing the wheelchair for transport without passengers



---

**CAUTION: Injury hazard!**

- *If you are unable to fasten your electric wheelchair securely in a transport vehicle, Invacare® recommends that you do not transport it!*
- 

- Before transporting your wheelchair, make sure the motors are engaged and that the Joystick Box is switched off.

Invacare® strongly recommends that you additionally disconnect or remove the batteries. See "Removing the batteries" on page **143**.

- Invacare® strongly recommends securing the wheelchair to the floor of the transporting vehicle.

## 13 Refurbishment

The product is suitable for refurbishment. Actions to be carried out:

- Cleaning and disinfection. Please see chapter "Care and maintenance" on page **147**.
- Inspection according to service plan. Please consult service instructions, available from Invacare®.
- Adaptation to the user. Please see chapter "Adjusting the wheelchair to the user's seating posture" on page **43**.



## 14 Disposal

- The equipment wrapping is potentially recyclable.
- The metal parts are used for scrap metal recycling.
- The plastic parts are used for plastic recycling.
- Electric components and printed circuit boards are disposed of as electronic scrap.
- Exhausted or damaged batteries can be returned to your medical equipment supplier or Invacare®.
- Disposal must be carried out in accordance with the respective national legal provisions.
- Ask your city or district council for details of the local waste management companies.

# 15 Technical specifications

The technical information provided hereafter applies to a standard configuration or represents maximum achievable values. These can change if accessories are added. The precise changes to these values are detailed in the sections for the respective accessories.

<b>Permissible operating and storage conditions</b>	
Temperature range for operation according to ISO 7176-9:	• -25° ... +50 °C
Temperature range for storage according to ISO 7176-9:	• -40° ... +65 °C

<b>Electrical system</b>	
Motors	• 2 x 340 W
Batteries	• 2 x 12 V/73.5 Ah (C20) leakproof/gel (TDX SP) • 2 x 12 V/50 Ah (C20) leakproof/gel (TDX SP nb)
Main fuse	• 80 A

<b>Charging device</b>	
Output current	• 8 A ± 8 %
Output voltage	• 24 V nominal (12 cells)
Input voltage	• 200 – 250 V nominal
Operating temperature (surroundings)	• -25° ... +50 °C
Storage temperature	• -40° ... +65 °C

<b>Drive wheel tyres</b>	
Tyre type	• 3.00 - 8 puncture-proof

<b>Driving characteristics</b>	
Speed	<ul style="list-style-type: none"> <li>• 6 km/h (TDX SP and TDX SP nb)</li> <li>• 8 km/h (only TDX SP)</li> <li>• 10 km/h (TDX SP and TDX SP nb)</li> </ul>
Min. braking distance	<ul style="list-style-type: none"> <li>• 1000 mm (6 km/h)</li> <li>• 1500 mm (8 km/h)</li> <li>• 2100 mm (10 km/h)</li> </ul>
Max. safe slope *****:	
without lifter	<ul style="list-style-type: none"> <li>• 9° (15.8 %) according to manufacturer's specifications with 180 kg payload, 4° seat angle, 20° backrest angle</li> </ul>
with lifter (only TDX SP)	<ul style="list-style-type: none"> <li>• 6° (10.5 %) according to manufacturer's specifications with 180 kg payload, 4° seat angle, 20° backrest angle</li> </ul>
Max. climbable obstacle height	<ul style="list-style-type: none"> <li>• 75 mm</li> </ul>
Turning diameter	<ul style="list-style-type: none"> <li>• 1120 mm</li> </ul>
Turning width	<ul style="list-style-type: none"> <li>• 1085 mm</li> </ul>
Drive range in accordance with ISO 7176-4:2008 ***	<ul style="list-style-type: none"> <li>• 32 km (6 km/h TDX SP)</li> <li>• 26 km (6 km/h TDX SP nb)</li> <li>• 39 km (8 km/h)</li> <li>• 28 km (10 km/h)</li> </ul>

<b>Dimensions</b>	<b>Standard</b>	<b>Contour</b>	<b>Flex</b>	<b>Flex Seat depth 48 / Contour Seat depth 51</b>	<b>Junior</b>
Overall height (without seat angle adjustment or lifter)	Without central legrest:				
	• 940 mm	• 1050 mm	• 980 mm	• 980 mm	• 860 mm
	With central legrest:				
	• 970 mm	• 1080 mm	• 1010 mm	• 1010 mm	• 890 mm

Dimensions	Standard	Contour	Flex	Flex Seat depth 48 / Contour Seat depth 51	Junior
Overall height (with 52°-seat angle adjustment)	Without central legrest:				
	• 940 mm	• 1050 mm	• 980 mm	• 980 mm	• 860 mm
Overall height (with 28°-seat angle adjustment)	With central legrest:				
	• 970 mm	• 1080 mm	• 1010 mm	• 1010 mm	• 890 mm
Overall height (with lifter)	Without central legrest:				
	• 980 mm	• 1090 mm	• 1020 mm	• 1020 mm	• 900 mm
Overall height (with lifter)	With central legrest:				
	• 1010 mm	• 1120 mm	• 1050 mm	• 1050 mm	• 930 mm
Max. total width	730 mm (with travelling armrests and seat width 48)				380 mm
	Total length (incl. standard legrests)				
Total length (without standard legrests)	• 1160 mm				
Seat height **** (without seat angle adjustment or lifter)	• 980 mm				
	• 450 mm				
	• 480 mm (with central legrest)				

Dimensions	Standard	Contour	Flex	Flex Seat depth 48 / Contour Seat depth 51	Junior
Seat height **** (with 52° seat angle adjustment, only TDX SP)	<ul style="list-style-type: none"> <li>• 450 mm</li> <li>• 480 mm (with central legrest)</li> </ul>				
Seat height **** (with 28°-seat angle adjustment)	<ul style="list-style-type: none"> <li>• 490 mm</li> <li>• 520 mm (with central legrest)</li> </ul>				
Seat height **** (with lifter, only TDX SP)	<ul style="list-style-type: none"> <li>• 490 - 790 mm</li> <li>• 520 - 820 mm (with central legrest)</li> </ul>				
Seat width (armrest adjustment range in brackets)	<ul style="list-style-type: none"> <li>• 430 mm (440 - 480 mm**)</li> </ul>	<ul style="list-style-type: none"> <li>• 480 mm (490 - 530 mm**)</li> <li>• 430 mm (440 - 480 mm**)</li> </ul>	<ul style="list-style-type: none"> <li>• 380 mm (390 mm)</li> <li>• 430 mm (440 - 480 mm**)</li> <li>• 480 mm (490 - 530 mm**)</li> </ul>	<ul style="list-style-type: none"> <li>• see Flex and Contour</li> </ul>	<ul style="list-style-type: none"> <li>• 300 mm</li> <li>• 350 mm</li> <li>• 380 mm</li> </ul>
Seat depth	<ul style="list-style-type: none"> <li>• 410/460/510 mm</li> </ul>		<ul style="list-style-type: none"> <li>• 380/430/480 mm</li> </ul>	<ul style="list-style-type: none"> <li>• see Flex and Contour</li> </ul>	<ul style="list-style-type: none"> <li>• 320/350/380/410 mm</li> </ul>
Backrest height ****	<ul style="list-style-type: none"> <li>• 480/540 mm</li> </ul>	<ul style="list-style-type: none"> <li>• 640 mm</li> </ul>	<ul style="list-style-type: none"> <li>• 550 mm</li> </ul>		<ul style="list-style-type: none"> <li>• 380/430/460 mm</li> </ul>
Seat cushion thickness	<ul style="list-style-type: none"> <li>• 50 mm</li> </ul>	<ul style="list-style-type: none"> <li>• 70 mm</li> </ul>			

Dimensions	Standard	Contour	Flex	Flex Seat depth 48 / Contour Seat depth 51	Junior
Backrest angle	<ul style="list-style-type: none"> <li>-10°, 0°, +7.5°, +15°, +22.5°, +30° (man.)</li> <li>0° ... +16° (electr.)</li> </ul>	<ul style="list-style-type: none"> <li>-10°...+45°</li> </ul>	<ul style="list-style-type: none"> <li>-10° ... +45°</li> </ul>	<ul style="list-style-type: none"> <li>0°...+35°</li> </ul>	<ul style="list-style-type: none"> <li>+5°...+35° (man.)</li> <li>+2°...+30° (electr.)</li> </ul>
Armrest height TDX SP	<ul style="list-style-type: none"> <li>250 - 350/290 - 390 mm</li> </ul>				<ul style="list-style-type: none"> <li>280 mm</li> </ul>
Armrest height TDX SP nb	<ul style="list-style-type: none"> <li>290 - 360 mm</li> </ul>	<ul style="list-style-type: none"> <li>250 - 350 mm</li> <li>290 - 390 mm</li> </ul>	<ul style="list-style-type: none"> <li>250 - 350 mm</li> <li>290 - 390 mm</li> <li>300 - 380 mm</li> </ul>	<ul style="list-style-type: none"> <li>see Flex and Contour</li> </ul>	<ul style="list-style-type: none"> <li>280 mm</li> </ul>
Legrest lengths: <ul style="list-style-type: none"> <li>Short (for leg length 320 - 380 mm)</li> <li>Medium (for leg length 380 - 440 mm)</li> <li>Long (for leg length 440 - 500 mm)</li> </ul>	<ul style="list-style-type: none"> <li>295 - 355 mm</li> <li>355 - 415 mm</li> <li>415 - 475 mm</li> </ul>				<ul style="list-style-type: none"> <li>-</li> <li>-</li> <li>-</li> </ul>
Seat angle, electronic adjustment (52°, only TDX SP)	<ul style="list-style-type: none"> <li>0° ... +52°</li> </ul>			<ul style="list-style-type: none"> <li>0° ... +40°</li> </ul>	<ul style="list-style-type: none"> <li>0°...+20°</li> </ul>

Dimensions	Standard	Contour	Flex	Flex Seat depth 48 / Contour Seat depth 51	Junior
Seat angle, electrical adjustment (28°)	• 0° ... +28°				
Seat angle, manual adjustment	• 0° ... +8°				

Weight *****	
Kerb weight with fixed seat angle	• 138 kg
Kerb weight with 52° electric seat angle adjuster	• 165 kg
Kerb weight with 28° electric seat angle adjuster	• 155 kg
Kerb weight with lifter	• 165 kg

Component weights	
73.5 Ah batteries	• approx. 24.5 kg per battery
50 Ah batteries	• approx. 16 kg per battery

Payload	Standard / Contour / Flex	Junior
Max. payload *****	<ul style="list-style-type: none"> <li>• 140 kg (6 km/h TDX SP)</li> <li>• 150 kg (6 km/h TDX SP nb)</li> <li>• 180 kg (8 km/h)</li> <li>• 160 kg (28° seat angle adjustment or lifter)</li> <li>• 136 kg (9.5 km/h)</li> </ul>	• 90 kg

Axle loads	
Max. front axle load	• 106 kg

## Axle loads

Max. rear axle load	• 97 kg
Max. centre axle load	• 217 kg

\* Approximate.

\*\* Width adjustable for side panel adjustment.

\*\*\* Note: The drive range of an electric wheelchair is strongly influenced by external factors, such as the charging state of the batteries, surrounding temperature, local topography, road surface characteristics, tyre pressure, weight of driver, drive style and use of batteries for lighting, servos etc.

The specified values are theoretical maximum achievable values measured according to ISO 7176-4:2008.

\*\*\*\* Measured without seat cushion

\*\*\*\*\* The actual kerb weight depends on the fittings your mobility aid has been supplied with. Every Invacare® mobility aid is weighed when leaving the works. Please refer to the nameplate for the kerb weight (including batteries) measured.

\*\*\*\*\* Static stability according to ISO 7176-1 = 9° (15,8 %)  
Dynamic stability according to ISO 7176-2 = 6° (10,5 %)

\*\*\*\*\* If two values are possible the lowest always applies.



# 16 Inspections Performed

It is confirmed by stamp and signature that all jobs listed in the inspection schedule of the Service and Repair Instructions have been properly performed. The list of the inspection jobs to be performed can be found in the Service Manual which is available through Invacare®.

<u>Delivery Inspection</u>	<u>1<sup>st</sup> Annual Inspection</u>
Stamp of authorised Dealer / Date / Signature	Stamp of authorised Dealer / Date / Signature
<u>2<sup>nd</sup> Annual Inspection</u>	<u>3<sup>rd</sup> Annual Inspection</u>
Stamp of authorised Dealer / Date / Signature	Stamp of authorised Dealer / Date / Signature
<u>4<sup>th</sup> Annual Inspection</u>	<u>5<sup>th</sup> Annual Inspection</u>
Stamp of authorised Dealer / Date / Signature	Stamp of authorised Dealer / Date / Signature





Order No. of this Manual: 1521464.DOC  
Release Date: 2012-08-21

**English**