

OKAYO

UHF-PL 16-96 Stationary Transmitter



[USER MANUAL]

Preface

Thank you for purchasing Stationary Transmitter System EJ-770T.
Please read this manual to know further about its functions and proper operation way before use.

INDEX

Each part's name and function.....	1
Installation before use.....	2
Operation & functions of EJ-770T panel.....	3~4
Operation & functions of UHF body pack receiver (EJ-7R).....	5~6
Installation chart — receiver (EJ-7R) and transmitter (EJ-770T).....	7~8
Trouble shooting.....	9
Specifications.....	9~10
MEMO.....	11~12

Each part's name and function

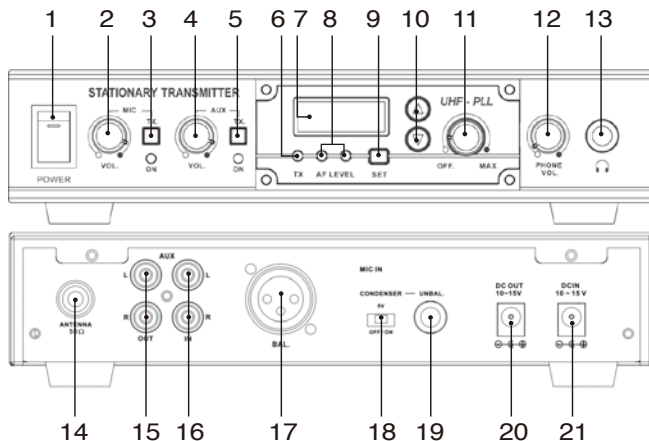

1. Power switch (on/off)
2. MIC/VOL (Wired mic volume control)
3. MIC/TX
(When the light is on, the wired mic signal will be transmitted through EJ-770T)
4. AUX input/VOL (Volume control)
5. AUX/TX
6. Transmitting indicator (for UHF transmitter module)
7. LCD (Showing the transmitting channel)
8. AF transmitting indicator/AF volume level indicator
9. Frequency set
10. Channel selector
11. UHF transmitting module/Power & Volume
12. Earphone volume
13. 6.3 mm stereo phone jack (32 ohm)
14. Antenna hole
15. AUX output
16. AUX input
17. Balanced mic input jack
18. Condenser mic power supply (5 V)
19. Unbalanced 6.3 mm mic Input jack
20. DC out (can connect with maximum one EJ-770T)
21. DC in

Installation before use

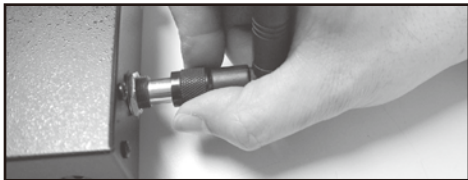

1. Install antenna

Please attach the antenna enclosed in the box onto the antenna hole (14) on the rear panel. Screw it in and adjust the antenna angle.

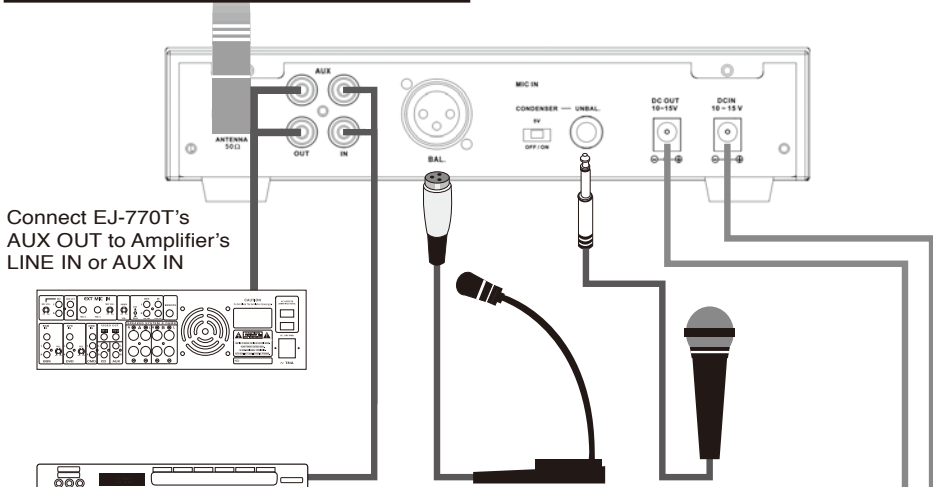

Connect CD PLAYER or other sound source's AUX OUT to EJ-770T's AUX IN

MIC IN
(for balanced XLR mic jack)

MIC IN
(for unbalanced 6.33 mic jack)

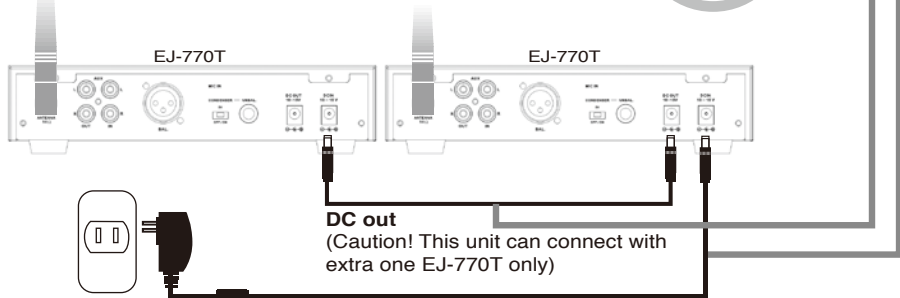

Power supply
please use this product's enclosed AC switching adaptor (100-240 VAC/12 VDC, 1 A).

Operation & functions of the EJ-770T front panel

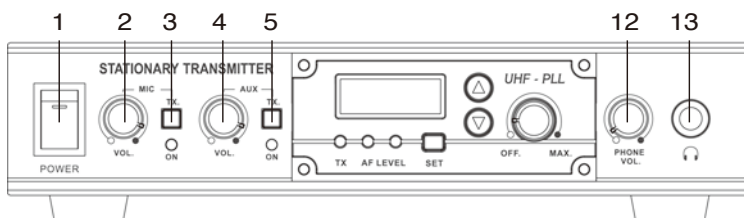

1. Turn on Power Switch (1).
2. Adjust and set preferred UHF transmitting module's channel.

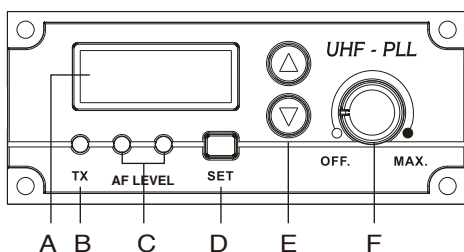

- A. LCD (showing channel/frequency)
- B. TX transmitting indicator
- C. AF transmitting indicator/ AF volume level indicator
- D. Frequency set
- E. Channel selector
- F. EJ-770T UHF transmitting module/ Power & Volume

2-1. Turn (F) clockwise (you will hear a “click”), then LCD will turn on and show the channel number, it means transmitting module is on. You can adjust the volume by keeping turning (F) clockwise. (Vice versa, turn counterclockwise till you hear a click and then LCD will show **OFF** , after 2 to 3 seconds LCD will turn off.)

2-2. Set & Adjust channel:

Turn on transmitting module, LCD will show channel number such as **CH.01** .

To adjust channel number please hold on “SET” (D) for one second, then channel number in LCD will start flashing like **CH.01** , press “channel selector” (E) button and adjust to the channel number you want (1~16 or 1~96). Press “SET” (D) to finish your setting.

Operation & functions of EJ-770T front panel

3. Wired microphone signal being transmitted via TX module

Press “MIC TX (3)” first, if the red light underneath is on that means wired mic’s signal is successfully transmitted. Vice versa.

Note: No matter “MIC TX (3)” is pressed or not, wired mic’s signal will be sent through AUX OUT still.

4. AUX IN signal being transmitted via TX module.

Press AUX TX (5) first, if the red light underneath is on that means AUX IN signal is successfully transmitted. Vice versa.

Note: No matter “AUX TX (5)” is pressed or not, AUX IN signal will be sent still through AUX OUT and also through earphone jack.

5. Stereo phone jack

Insert 6.3 mm earphone into earphone jack (13), adjust volume (12) and then you can monitor AUX IN (16) signals.

Note: Only signals from AUX IN (16) can be sent via earphone jack (13), MIC IN signals can’t.

Operation & functions of the UHF body pack receiver (EJ-7R)

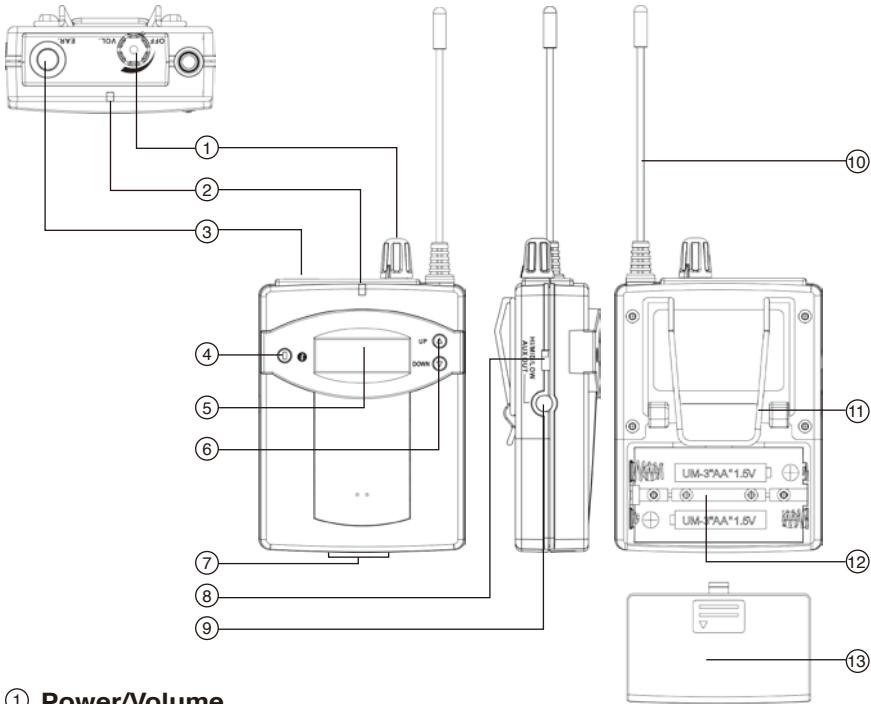

① Power/Volume

- Turn clockwise, if you hear a “click” that means the unit is on. Keep turning clockwise you can adjust its volume. Vice versa.

② Power/Volume

- This light will show red when EJ-7R is on, when EJ-7R is receiving signal this light will show green. Only when EJ-7R is turned off will the light be off.



③ 3.5 mm Earphone jack

- You can use with mono or stereo earphone.
- Volume adjustable.

④ Channel info button

-  Represents “information”, press this button and then LCD will show the channel being used.

⑤ LCD

- LCD backlight will be on when EJ-7R is on. LCD shows the channel number and battery info. If no any actions after 5 seconds backlight will be off, press  or “Channel selector”   to change a channel and the backlight will be on again.

⑥ Channel selector

- Use   to adjust your preferred channel.

Operation & functions of the UHF body pack receiver (EJ-7R)

⑦ Charging end

- To recharge EJ-7R you need its own charging set "HDC-707" (dual-slot, an optional product.)

⑧ 3 levels of volume

- HI, MID and LOW.

⑨ 3.5 mm AUX OUT

⑩ Antenna

- Flexible antenna

⑪ Belt clip

⑫ Battery case (AA battery)

⑬ Battery cover

How to use



Putting in battery

1. Open battery cover.
2. Putting in battery correctly according to polarity \oplus \ominus .
2 pcs of Ni-MH 1,600 mAh batteries are required;
otherwise alkaline batteries are suitable too.

Turn on EJ-7R

1. Turn on the volume control in clockwise direction.
2. Then, the power/reception indicator will become red.
3. The light will turn to green when EJ-7R has received signal. At the same time, LCD display will be active and shows like **00** .
4. The channel number will be shown as well like **CH.08** .
5. Put accessory earphone EM-101 or EM-305 into earphone jack③ and adjust volume.

Channel setup

1. Select a channel by pressing \blacktriangle \blacktriangledown .
2. As soon as the channel is definitely chosen, keep the selected channel number stay on LCD.
3. Channel setup is completed.

AUX OUT volume control

This output can be connected with other amplifiers or speakers.

LCD display instructions

1. **CH.08** 1. 8th channel is selected and batteries are fully charged.
2. **CH.08** 2. Batteries are going to be out of electricity. Please recharge soon.
3. **00** 3. When the battery frame blinks, batteries are out of electricity. The frame will blink until the unit turns off automatically.

※ **low battery will affect reception quality, if you use rechargeable batteries please use AA 1600 mAh Ni-MH battery and its compatible charger HDC-707 (optional product). Or, you can as well use disposable AA 1.5 V alkaline battery.**

Caution!

Do not put EJ-7R into the charger when you are using disposable batteries in case of explosion or leak.

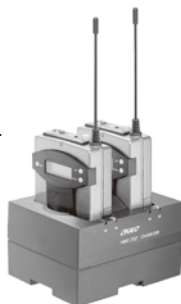

HDC-707

Installation chart — receiver (EJ-7R) and transmitter (EJ-770T)

Turn on receivers and adjust to the same channel as transmitter (EJ-770T).

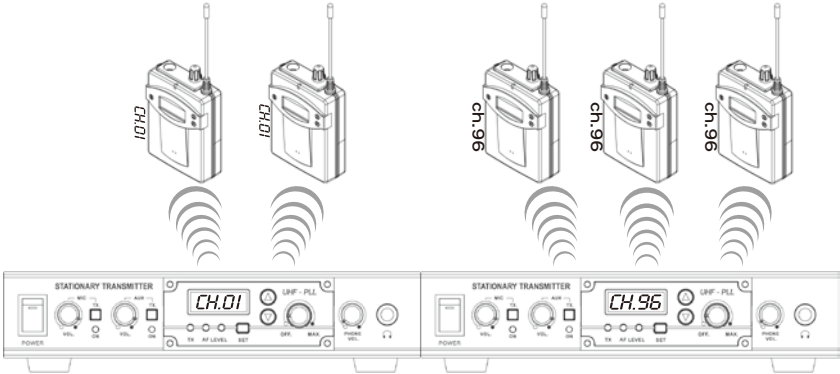

Application to big occasion

Example: In interpretation occasion:
to set up the equipments in multi-language occasion such as seminar or international conference, please refer to the chart below.

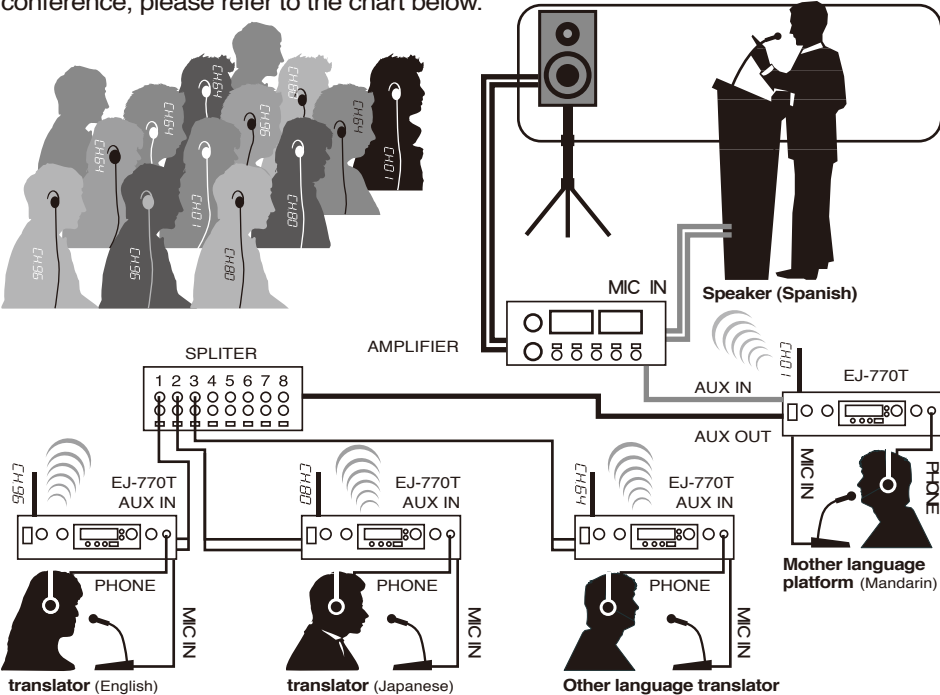

Note: EJ-770T setup has to be: (1) MIC TX switch at ON (2) AUX TX switch at OFF

※ The audience can tune in different language translations by selecting different channels.

Installation chart — receiver (EJ-7R) and transmitter (EJ-770T)

Applications to tour guiding

Example:

Set up different channels for each section in the exhibition.

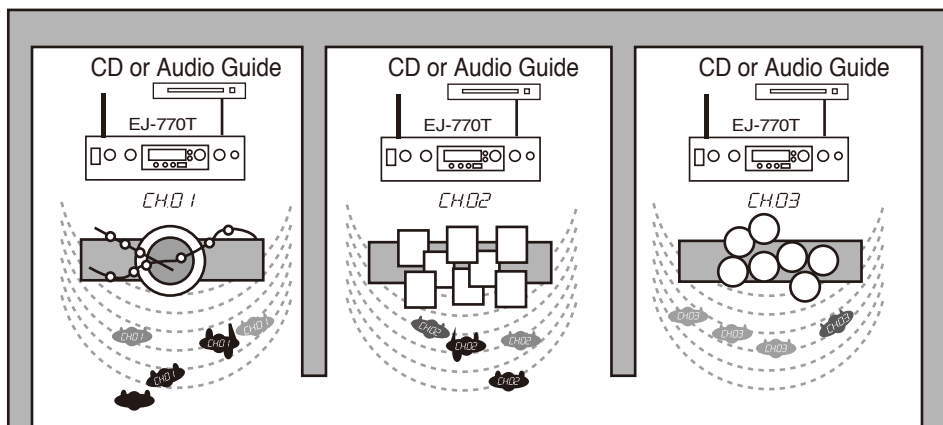

Transmitter Location:

Put away from the wall at least by 1 meter (up, down, depth), clear up any obstacles between transmitters and receivers to obtain the best effect.

Caution!

1. Avoid rain in case of electricity shot.
2. Avoid impact and crash down.
3. Avoid high temperature environment.
4. Do NOT use any power supply with different spec.

TROUBLE SHOOTING

Trouble	Solution
Unable to turn on the unit	<ol style="list-style-type: none"> 1. Be sure you have connected the power supply. 2. Turn on the power switch. 3. Be sure the batteries are inserted in the unit. 4. Be sure the polarities of batteries are correct.
Unable to hear any voice from the receiver	<ol style="list-style-type: none"> 1. Be sure the receiver and the transmitter are at the same frequency. 2. Be sure the receiver is turned on. 3. Be sure the volume is adjusted to the appropriate level. 4. Be sure the distance between the receiver and the transmitter are within reception range.
No signal is transmitted from transmitter.	<ol style="list-style-type: none"> 1. Be sure volume is adjusted to appropriate level. (Button #. 11)
Reception range is too small	<ol style="list-style-type: none"> 1. Be sure that antenna is fixed firmly.
Receiver is interfered when pairing with the transmitter	<ol style="list-style-type: none"> 1. If there are 2 transmitters around users, select another different frequency to avoid potential interferences. If interference still exists, select another frequency again until the problem is solved. 2. Interferences might come from other RF products, such as television or radio. Please select another frequency.
LCD shows "ERR"	<ol style="list-style-type: none"> 1. Turn volume control off in counterclockwise direction, and then turn it on again step by step. 2. If the problem still cannot be solved, please contact with your local supplier for repairing.

Specifications

	EJ-770T
RF output	10~30 mW
AUX input jacks	6.3 Ø-Mic in, XLR-Mic in, RCA-Aux in
AUX input	700 mV
AUX output	1 V
MIC input	Balanced/unbalanced 10 mV
Earphone output	0.5 W/32 ohm
Selectable channels	1~96 channels
Power requirements	100 V~240 V AC/12 V 1 A
Dimensions	214 X 187 X 43 mm
Weight	1.3 kg

Specifications

EJ-770T	
Oscillation mode	PLL synthesized
Receiver frequency range	Group 1. 640~664 MHz (96 ch) Group 2. 740~752 MHz (96 ch) Group 3. 794~806 MHz (96 ch) Group 4. 863~865 MHz (16 ch)
Frequency width	Maxima 24 MHz
Dynamic range	> 80 dB
T.H.D.	< 1 %
Pre/De-Emphasis	< 50 μ S

Antenna	Flexible antenna
RF spurious rejection	58 dB @ 250 kHz
Adjacent channel performance	58 dB @ 250 kHz
IMD rejection	58 dB @ 400 kHz & 800 kHz
Double intermediate	243.95 MHz/10.7 MHz
AUX OUT	-5 dBv/-10 dBv/-20 dBv @ 1 kHz ohm 20 kHz with Hi/Mid/Low switch
Audio level	Max 750 mV
Earphone jack	3.5 mm jack socket for both of mono or stereo earphone
Battery	2 pcs of 1.2 V AA type Ni-MH rechargeable battery (1600 mA) or Alkaline disposable Battery
Ni-HM. Rechargeable Battery life	Up to 14 hours. (1600 mA Type)
Alkaline disposable Battery life	Up to 17 hours.
Dimensions (L * W * H)	26 (D) X 64 (W) X 98 (H) mm
Weight	175 g (including batteries)

MEMO

OKAYO

Sound & Communication

E-J ELECTRONICS CO., LTD.

4F, No.11, Lane 125, Sec 1, Kuo Kwang Rd., Ta Li City,
Taichung Hsien, Taiwan

Tel:886-4-2407-1617 Fax:886-4-2407-1609

e-mail:okayo@okayo.com

www.okayo.com

2008-05-770T