

GSM Alarm Kit User Manual

Ver 1.20 Date Issued: 2010-05-14

Picture for reference only. Actual accessories may differ.



Table of Contents

1.	Brief introduction -----	2
2.	Safety Directions -----	2
3.	Standard Packing list -----	3
4.	Physical Layout -----	3
5.	Features -----	5
6.	Settings -----	7
7.	Operating Instructions -----	17
8.	Installation -----	20
9.	Add wireless sensors -----	24
10.	Technical specifications -----	26
11.	Important information -----	27
12.	Maintenance-----	27
13.	Quality Warranty -----	28
14.	Trouble Shooting Guide-----	28

1. Brief introduction

The GSM Alarm System GSM ALARM KIT 16 is a new security protection solution special for home, house and office and other applications. It based on Wireless GSM Communication network, integrated Lcd Menu display and Computer technology. When any sensor activated, it will Call & Send SMS to owner's telephone immediately.

The GSM Alarm System GSM ALARM KIT 16 with user friendly design idea, all operations and settings are visual and intuitive!.

What you need is a SIMCard which supports Call ID function.

2. Safety Directions



Safe Startup

Do not use GSM Alarm System when using GSM equipment is prohibited or might bring disturbance or danger.



Interference

All wireless equipment might interfere network signals of GSM Alarm System and influences its performance.



Avoid Use at Gas Station

Do not use GSM Alarm System at a gas station. Power off GSM Alarm System it near fuels or chemicals.



Power it off near Blasting Places

Please follow relevant restrictive regulations. Avoid using the device in blasting places.

Reasonable Use



Please install the product at suitable places as described in the product documentation. Avoid signal screening by covering the mainframe.



Use Qualified Maintenance Service

Maintenance can be carried out only by qualified maintainer.



Waterproofness

The product is not waterproof. Please install it at dry places and keep it dry.

3. Standard Packing List

Control Unit X1

Wireless Magnetic Door Sensor X1

Wireless Remote Controls X 2

Wireless PIR Motion Sensor X1

Wired Mini Siren (110dB) X1

Regulated 12VDC Power Supply X1

User Manual X1

GSM Antenna X1

Optional Accessories: (Wireless Sensors only)

PIR Motion Sensor, Glass Break Sensor, Magnetic Window Sensor,

Magnetic Steel Scrolling Door Sensor, Temperature Sensor,

Photoelectric Beams, etc.

4. Physical Layout

4.1 Control Unit physical layout

Tips!

- 1) *In order to power off the alarm system by intruders, we equipped the power switch inside, it is nearby the SIMCard socket, please pay attention to it, and don't tell others*

- of this. Turn it towards inside is switch off, turn it towards outside is switch on.
- 2) We reserved the plastics of the output relay. Because of some of the users needn't this function. If you want to use the output relay, please remove the plastics carefully. Then you can see the output relay connectors inside.
 - 3) The left output relay is independent output relay; the one nearby the power socket is the alarm link output relay. Please pay attention to it.

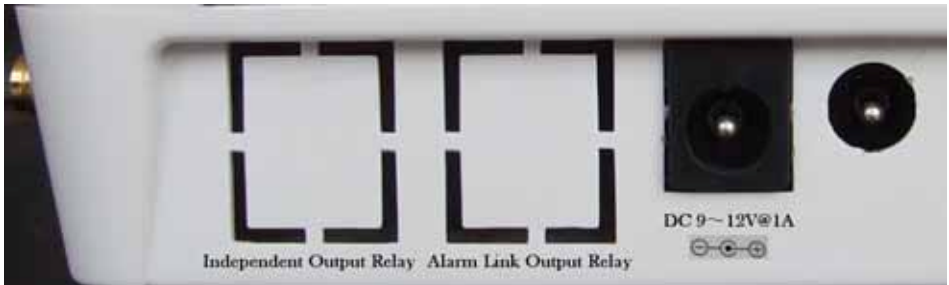

Interface Description

PIN 1	Independent Output Relay, Can switch on or off by SMS Commands. (Rated Voltage: 3A/250VAC), this relay is very useful to switch on light when you can not come back in the evening. Then some hours
PIN2	Link-Output Relay, when the system alarm will close 4minutes. (Rated Voltage: 3A/250VAC), this relay can connect to any other lights or CCTV system as a switch.
PIN3	DC Input 9~12V @ 1000mA, Inner is positive electrode, outer is negative electrode.
PIN4	Siren Socket, 12VDC Output, Inner is positive electrode, outer is negative electrode.
PIN5	GSM Antenna, Gain:2.0dB, (Gain: 2.5dB for 3m GSM ANT)

4.2 Working Principle Drawing

The GSM ALARM KIT 16 works with wireless detectors only. It can switch on or off one appliance by SMS command. Please see below:

Antenna

5. Features

5.1 The advantages of the GSM Alarm System GSM ALARM KIT 16

- 1) Two-way Voice communication or wiretap are available;
- 2) LCD displays the entire setup menu;
- 3) Armed, Partial Armed (At Home or Stay), Disarmed, SOS are available;
- 4) Armed delay, alarm delay, siren work or not, more other functions are Programmable by user;
- 5) Watchdog, 24Hours Zone, SOS zone are available;
- 6) Using ICON to display armed, Partial Armed, Disarmed, Power status, Siren status and GSM Signal status.
- 7) Auto-detect and report, GSM Signal Jammer alarm, SMS Switch is available.

-
- 8) User friendly Icons for LED indicators, LCD and functional Buttons.

5.2 Functions & Features of the GSM Alarm System

- 1) GSM Frequency: Dual-Band(900/1800MHz), Quad-Band is optional(850/900/1800/1900Mhz) ;
- 2) Supports armed, Partial armed(At House or Stay) or disarmed, SOS by remote control or mainframe keyboard;
- 3) Supports armed, disarmed, inquiry mainframe status, switch on or off relay output by SMS Commands;
- 4) Automatically send SMS Alert and dial to the pre-set cell phone when any sensor had been triggered;
- 5) Equips with 16 Wireless Zones, zone attribute (Normal/At House or Stay mode) and Zone Name is editable;
- 6) 3 X 24-Hour zones for smoke and gas leakage sensor, 1XWatchdog zone for monitoring elder or child, 1XSOS zone for emergency help;
- 7) Supports 3 SMS Alert Numbers and 5 Calling alert numbers and 20 Alarm Records for owner review;
- 8) Supports Timer for automatically arm or disarm the system;
- 9) Supports armed delay to give enough time to you go out the home, the delay time is editable by user;
- 10) Equips with 1 Alarm-Link output relay, once the system triggered, the output will switch on for 4minutes;
- 11) Equips with 1 independent output relay, it can be switch on or off by SMS Commands. This is very useful for remote switch on light or off while you're in another city in the night;
- 12) The Keypad can use as a dialer, the functions like the Cell phone;
- 13) The external power failure & recovery alert function is optional ;

-
- 14) Supports wiretap through the internal microphone;
 - 15) Supports internal Speaker to special user for two-way voice communication;
 - 16) It is Compatible with PT2262/2264 and PT2242 wireless IC;
 - 17) Standby internal rechargeable battery which can last 12 hours;
 - 18) Based on the GSM communication network and Operation Menu Display technology, apply to wide range situations.

6. Settings

Tips!

- 1) *Please insert the SIMCard firstly, and install the GSM Antenna then power on it. Also, you can insert the SIMCard after you setup.*
- 2) *All the wireless sensors in the standard package we have assigned to the mainframe already. Needn't to learn it again.*
- 3) *After you power on the mainframe, the mainframe will auto detect and display the process. If it with SIMCard, it will register the GSM Network and display the GSM Signal ICON in the left corner of the LCD.*
- 4) *All of the setup can be done by the LCD except modify the Zone name, if you need to modify the zone name, please see the command list in the related chapter.*
- 5) *Only disarm by keyboard and modify settings requires password, the other operation needn't password. The default password is 1234. Enter password then press Enter button to enter the system.*
- 6) *In standby mode, press #3#6, following UP button. The system will recovery to factory default settings, the password will be 1234. But the registered wireless sensors will remain.*
- 7) *Two way communication:
In standby mode, dial the telephone number, following the Enter Button, the system will dial out; While incoming call, press the Enter Button to answer the incoming. Please note: if the income calling is from the preset number, then before 5 tones, if answered it, will create two way voice communications. After 5 tones, will be*

entering into wiretap status. The user can listen in the alarm around sounds. If the income calling is not from the preset alarm number, after 5 tones, if hasn't been answered, will hang up.

- 8) *If you want to test the two way voice communication, please make sure the other phone is far from the GSM ALARM KIT 16, at least 500meters. Otherwise, the near-cross will make lots of noise interference.*

6.1 Key-Function Descriptions.



6.1.1 Led indicator Description

The GSM ALARM KIT 16 uses the icons to describe the function; it will be more user friendly to user.

: Stay Mode indicator, on is in stay mode;

: Arm Mode indicator, on is in arm mode, off is in disarm mode;

: Alarm Indicator, on is alarming, off is normally;

 GSM Module indicator, registering will quickly flick, registered successful will slowly flick.

 Alarm link output indicator, when alarm, will turn on and last 4minutes, means the alarm link output relay closing.



Independent output relay indicator, when the independent output relay closed, it will be on; when the independent output relay opened, will be

6.1.2 LCD ICONS Description

The GSM ALARM KIT 16 uses the icons to describe the present status; it will be more user friendly.

: Enabled the Timer to arm and disarm function; otherwise, will not display it.

: Timer to Arm, has setup a time point to enter armed mode directly.

: Timer to disarm. Has setup a time point to enter disarmed mode directly.



Enabled the Watchdog zone. In the fixed time range if the sensors in the watchdog zone hasn't been triggered, will alarm.



Enabled the system condition report function. Will automatically send system condition to the user by SMS, otherwise, it will not display.

6.1.3 Keyboard functions

The GSM ALARM KIT 16 uses the icons to mark the buttons; it will be more user friendly to user.

: Disarm, Exit, and Backspace button.

: Arm, Stay, and Up towards button.



: SOS, Down towards button.

: Enter button.

: Turn Left/Right button, in special menu need it to choose the option.

6.2 Main Menu

In standby mode, press the  button, you can see the Menu.

1. View

---To check the settings and event records of the system

2. Setup

---To setup the system functions, requires password, the default password is 1234.

6.2.1 View

1. Alarm Records

---To check the alarm records, up to 20 event records will be saved.

2. Timers

---To check the Timer you have setup.

3. RF Zone Name

---To check the SMS Alert Contents of the Related Zones and its attributes.

4. SMS Phone No.

---To check the SMS Alert Numbers

5. Auto-dial No.

---To check the Auto-dial telephone Numbers

6. Report Time

---To check the report time.

7. RF Code Query

---To check the RF sensor wireless code.

Notice:

- 1) The RF Code Query function is for check the wireless sensor transmission. You can enter this submenu, then triggered the wireless sensor, if in the LCD can display some codes, means the wireless sensor can transmit wireless signal.

6.2.2 Setup

- 1. Add/Del RF Parts
- 2. Basic Setting
- 3. Advanced Setting

--To add or remove wireless sensors or remote controls and edit their attributes.

--To setup basic parameters of the system.

--To setup the advanced parameters of the system.

6.2.2.1 Add/Del RF Parts

- 1. Edit RF Zone
- 2. Edit Remote Ctrl
- 3. Remove All

--To setup the zone's attribute and add new wireless sensors to specificities zone.

--To add new remote controls.

--To remove all registered wireless sensors and remote controls.

Notice:

Zones' Attribute	Definition
Normal	The sensors with this type triggered will alarm in Armed mode and not alarm in disarmed mode.
Stay	In Stay mode, the sensors with Stay type triggered will alarm, th
24-Hour Zone	In any mode, the sensors with this type triggered will alarm.
Watchdog	In the starting time point and ending time point, the sensors with this type triggered will not alarm, if the sensor hasn't been triggered, will make alarm.
SOS Help!	In any mode, the sensors with this type triggered will alarm but not drive the siren.

Alarm Action: when Alarm occurrence, the system will Automatically dial the Pre-set Auto-Dial Tel. Numbers for 3 times one by one, and Send SMS to the Pre-set SMS Alert Numbers, in the meantime, will drive the siren for 60seconds and close the

link-Output relay for 4 minutes.

- 2) *After you enter the menu, the attribute of the zone will be displayed in the LCD, if this zone has been assigned wireless sensor, will display “V”. If hasn’t been assigned wireless sensor, means this zone is empty, you can assign new wireless sensor to this zone. Press Up or down button on the keyboard to check the other Zones. Press Enter to edit it. After you pressed the Enter button, you can select the zone attribute, and then press Enter, you can see “Turn on the device” or “Please trigger the new wireless sensor”. Then following the instruction to add the new wireless sensor to the GSM ALARM KIT 16. For Remote control, it will display VVVV if the unit has been assigned remote control. Both of them you can press Enter to re-assign new wireless sensor or remote control to replace the existence one.*
- 3) *In the Edit RF Parts you can edit the attribute of the sensor as Normal or Stay Type. If the system is under Stay Mode (Also said At House or Partial Armed), the sensor set as Normal triggered will not alarm, the sensor set as Stay triggered will Alarm. If the system is under Armed Mode, then all RF sensors triggered, will alarm. This is very important to remember the sensor types of the system. This function is very useful when you at house and need some sensors in working status (E.g.: the sensor installed outer and gas and smoke detectors, etc.) and some sensors indoor not in working status (e.g.: the sensors installed in the living room, bed room, etc.).*
- 4) *The GSM ALARM KIT 16 can accept total 16 wireless sensors to 16 wireless zones; each zone can be assigned one wireless sensor, and renamed it by SMS Command. And 5 remote controls.*
- 5) *Zone Serial Number, Default Zone Name and Zone Attributes Table.*

Zone SN.	Default Zone Name	Default Zone Attribute
01	Intrusion from Entry Door	Normal
02	Intrusion from Living Room	Normal
03	Intrusion from Bed Room 1	Normal
04	Intrusion from Bed Room 2	Normal
05	Intrusion from Bed Room 3	Normal
06	Intrusion from Front Balcony	Normal

07	Intrusion from Behind Balcony	Normal
08	Intrusion from 1F Window	Normal
09	Intrusion from 2F Window	Normal
10	Intrusion from Left Fence	Normal
11	Intrusion from Right Fence	Normal
12	Medical Button Alarm	24-Hour zones, This attribute can not be modified. In arm or disarm or stay mode, once the sensor in these zones triggered will alarm immediately.
13	Gas Leakage Alarm	
14	Smoke Fire Alarm	
15	Watchdog alarm	Watchdog Zone, the attribute can not be modified. In arm or disarm or stay mode, once the sensor in this zone triggered in the preset time, will not alarm, if the sensor hasn't been triggered in the preset time, will alarm.
16	SOS Help!	SOS zone, The attribute can not be modified. In arm or disarm or stay mode, once the sensor in these zones triggered will alarm immediately. But not drive the siren.
Notice: The SOS button on the Keyboard and remote control is the same attribute with the SOS zone.		

6.2.2.2 Basic Setting

1.SMS Phone No.	--To setup the SMS Alert Number, must be cell phone numbers, total 3.
2. Auto-dial Tel No.	--To setup the Auto-dial telephone number, total is 5.
3. Time & Date	--To setup the time and date information. The Format is Month-Date-Year. Press Up/Down to setup each item, press * move to next item.
4. Sound Alarm	--Switch on or off the siren when Alarm occurrence.
5. Report Time Gap	--Setup the Report time gap, Range: 0~240Hours.deflaut is 0, will not report.
6. Power Failure Alert	--Enable or Disable the alert function while the AC power is failure more than 30 minutes.
7. Arm Delay Time	--Setup the delay time after armed the system by remote control or keyboard. Optional: 0S, 20S, 30S, 60S, 90S. Default is 30S.
8. Alarm delay Time	--Setup the delay time after any sensor triggered. Optional: 0S, 20S, 30S, 60S, 90S. Default is 20S

Notice:

- 1) The SMS Alert number is for receiving the alarm SMS Message. The Auto-Dial Telephone number is for receiving the calling. Please help to try adding country code or removing country code when you can not receive the call or SMS. Because of different GSM Operator with different communication protocols. Our system is with the international communications protocols.*
- 2) The Auto-dial Tel. Number can dial to the GSM ALARM KIT 16, 6 tones later, can wiretap the system site. Before 6 tones, if somebody answers the calling, then can create two-way voice communication. The other telephone number can call in the GSM ALARM KIT 16, if nobody answer the calling, then can not wiretap the system site, if somebody answers the calling, then can create two-way voice communication.*

For example:

In China, the country code is **0086**, please note, do not write **+86**.

The user cell phone number is **13570810254** and has been assigned as a SMS Alert number, the simcard number in the panel is **13512345678**.

Problem 1: Alarm but the user hasn't received the SMS Alert.

Solution: Please plus the country code while you setup the 13570810254 as SMS Alert number, means setup **008613570810254** to instead of the **13570810254**.

Problem 2: The user number can receive the SMS Alert message from alarm panel, but the alarm panel can not receive the commands from the user number.

Solution: Please add country code to the simcard number in the alarm panel. Means send sms commands to **008613512345678** to instead of **13512345678**.

Solution 3: When you use cell phone dial another one, what number it will be displayed then you can set the displayed number as dial numbers; when you use cell phone send SMS to another cell phone, what number it will be displayed then you can set the displayed number as SMS Alert number, just use the 00 to replace the "+".

- 3) *If Switch off the siren, then all alarm raised will not drive the siren, if switch on the siren, then when the system alarm will drive the siren for 1 minute except the SOS help caused. Default is Switch on.*
- 4) *If setup the Report Time Gap, the system will periodically send "GSM Alarm System in good working condition" to the first SMS Alert number. This is very useful for long time use the system. Default is 0. Means will not report the system condition.*
- 5) *If enable the power failure alert function, the system will send SMS "AC Power Failed 30Min." to the first SMS Alert numbers after the AC power failure 30minutes, if the power is recovery then will send SMS "AC Power is OK.". Default is disabled.*
- 6) *There's no delay for Stay Mode.*

6.2.2.3 Advanced Setting

1. Edit Timer	--To setup the starting time to arm and the Ending time to disarm.
2. Watchdog Timer	--To setup the starting and ending time to work.
3. RCO Alert	--To setup the remote control operation report function.
4. GSM Jammer Alert	--To setup the GSM Jammer Alert function.
5. Modify Password	--Modify the system password.
6. Default Set	-- Restore the system settings to factory defaults. All of the remote controls and wireless sensors should be re-assigned again.

Notice:

- 1) The watchdog is special for elder or child or on-duty personnel, in the period (Starting time point to Ending time point) if this sensor hasn't been triggered, the system will alarm. This is very useful to monitor the elder or child goes out the bedroom or enters the kitchen to eat something. Or monitor the on-duty personnel in the polling period have gone to on-site inspection.*
- 2) If enable the RCO alert function, then when use any remote control which has been registered to the system to arm or disarm or stay operation, the system will send SMS to the first SMS number.*
- 3) If enable the GSM Jammer Alert function, when the GSM Signal is 0 for more than 90s, the system will drive the siren for 60seconds and the link-output relay will close 4 minutes.*

6.3 Modify the SMS Alert Content of the Zone (Zone or Sensor Name)

The GSM ALARM KIT 16 accept SMS Command to modify the SMS Alert Content of the zone. The format is: **Password+#+M+Zone Serial**

Number+#+New Zone Name+#, the Max. Character for the zone name is 32. The Zone Serial Number is 01~16 corresponding to the LCD Menu. If setup successful, the system will return OK to confirm the operation.

E.g.: Modify the first wireless zone name as **Front Door Opened by Intruder!** You should edit a SMS Content: **1234#M01# Front Door Opened by Intruder!#**, the 1234 is the password. Then send it to the GSM ALARM KIT 16 Simcard Number.



7. Operating Instructions



Tips!



The user can arm/disarm/Stay (Partial armed) by Remote controls, Keyboard, SMS, also, the user can cancel the alarm by Remote Controls, Keyboard, SMS to Disarm it. Another, the user can switch on or off the independent output relay by SMS Commands.

7.1 Arm or Disarm or Stay (Partial Arm, At House Arm) and Emergency Alarm by remote controls



Press the button “” on the remote control or Press Arm button on the keyboard then select Arm, the Control Unit enters arm status (delay time according to the setting), the  ICON will be on. Under this status, any sensor triggered, the control unit will alarm, if answered the call, the siren will stop and can listen in the alarm area by phone.

Press the button “” on the remote control, or press Disarm button on the Keyboard then input the password, the Control Unit disarms immediately. The  ICON will be off. Under this status, any sensor triggered, the control unit will not alarm. Except the sensor type is the 24-Hour Zones or Watchdog zone or SOS zone.

Press the button “” on the remote control or Press the Arm button on the keyboard then select Stay, the Control Unit enters Stay(Partial Armed) status, the  ICON will be on. In this status, the sensors had been set as Stay Type triggered will alarm, but the sensors had been set as normal Type triggered will not alarm. Please see the menu of the [Edit RF Zone](#).

Press Emergency button (SOS) “!” on the **remote control** or the control unit or Press any **Emergency button**. The Control Unit will enter emergency alarm. The siren will not sound, but will alert the pre-set phone number immediately.

7.2 SMS Commands for Arm or Disarm or Inquiry system status or switch on/off independent output relay.

The User can Arm/Disarm/Inquiry system status/Switch on or off the independent output relay by sending SMS to the Control unit. The SMS Commands are below:

Notice:

The system will carry out the commands immediately (with no delay) after the Control Unit receive this SMS command.

7.2.1 Armed

xxxxAA

“xxxx” stands for the password
(1-4 digits).

Return SMS

All Armed Mode activated.

Example

1234AA

When the Password is 1234

7.2.2 Disarm

xxxxBB

“xxxx” stands for the password
(1-4 digits).

Return SMS

System deactivated.

Example

1111BB

When the Password is 1111

7.2.3 Switch On the independent output relay

xxxxCC

“xxxx” stands for the password
(1-4 digits).

Return SMS

Output Relay Closed.

Example

1111CC

When the Password is 1111

7.2.4 Switch OFF the independent output relay

xxxxDD

“xxxx” stands for the password
(1-4 digits).

Return SMS

Output Relay Opened.

Example

1111DD

When the Password is 1111

7.2.5 Inquiry System Status

xxxxEE

“xxxx” stands for the password (1-4 digits).

Return SMS

Armed or At House or Disarmed

AC Power is Ok or AC Power is failed

GSM Value is 17 or other value

Output Relay is Closed or

Output Relay is opened

Notice:

The Output relay status in the Return SMS is the independent output relay status. It is not the alarm link Output Relay Status.

8. Installation

Before installing the control unit and sensors and sirens, please help to test the system firstly, including wireless sensor, power supply, gsm signal, etc.

Please ensure the wireless sensors and electricity appliances from the mainframe more than 3~5m.

8.1 Insert SIM into Control Unit and install the GSM ANT.

In the backside of the control unit, please install the GSM SIM card. The GSM ANT must be Vertical installation to ensure it in good working condition.

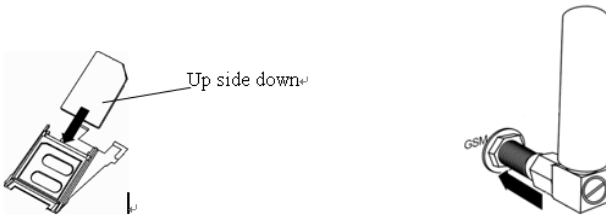

8.2 Install the Magnetic door/window sensors

Magnetic door/window sensors signal the Control Unit when the two parts separate by more than between 1.5 to 3.0cm.

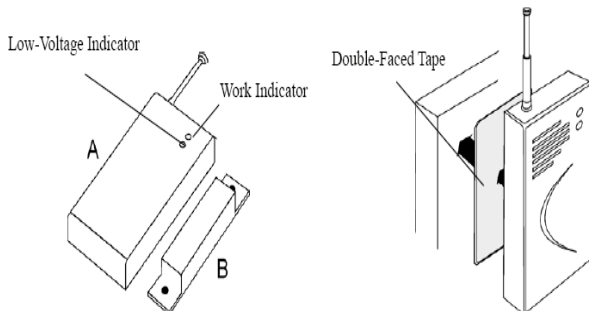

In some circumstances an Infrared beam fence is more appropriate than magnetic sensors. i.e. veranda, picture window balcony, boundary wall e.t.c.



Wireless glass break sensor can also be used (see below)



For a Scrolling Steel Door, a special Wireless Scroll Steel Door magnetic sensor must be used due to interference of the wireless signal caused by the steel door.

Installation: attach the larger half to the floor and attach (rivet or glue) the smaller half to the scroll steel door. An alarm is triggered when the halves are separated by more than three to 5.00 cm.

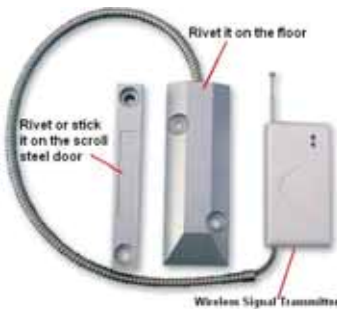

Scroll Steel Door

8.3 Install the wireless PIR Motion Sensor

The PIR sensor will detect a person since human temperature is different to ambient temperature. When triggered, the PIR will signal the Control Unit. Apply the detection area illustration below when installing.

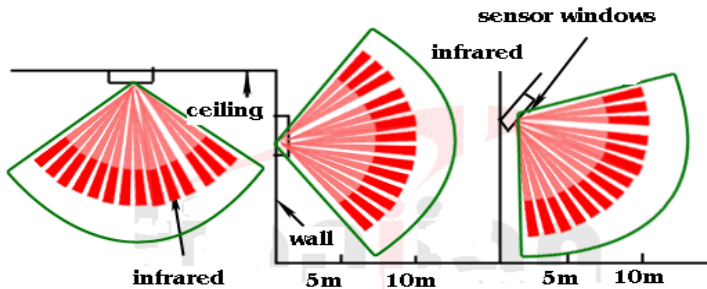

Wireless curtain sensor, detection area illustration below:

8.4 Install other sensors

For smoke, you can use wireless smoke sensor, for gas leakage detection, you can install gas leakage sensor below



8.5 Install the Control Unit

In order to avoid destruction of the Control Unit by intruders, please install it in a concealed location, convenient to the operator.

If applicable, ensure that an uninterruptible AC power outlet is available near the Control Unit. First connect accessories to the Control Unit then the AC adapter.

8.6 Install Siren

Connect the Siren to the Control Unit and fix them in appropriate locations.



Strobe Siren



Siren



Light Siren

8.7 Install output relays.

The GSM ALARM KIT 16 with two output relays, one is for SMS Control, another is for alarm output. Please select the one you required.

The SMS control output relay is useful while you're not at house, then you can send SMS to switch on the light, and then switch it off if you need. This action will stop the intruder to break your house; because of they see the light is on.

The Alarm Link Output Relay is for switching on the light once the alarm system triggered for 4 minutes. For example, when the intruder breaks the door or windows, then the siren sounds, and the light turn on, the criminal

will escape at once.

The connections please see the photo; also, you can use any other electric equipment to instead of the lights.

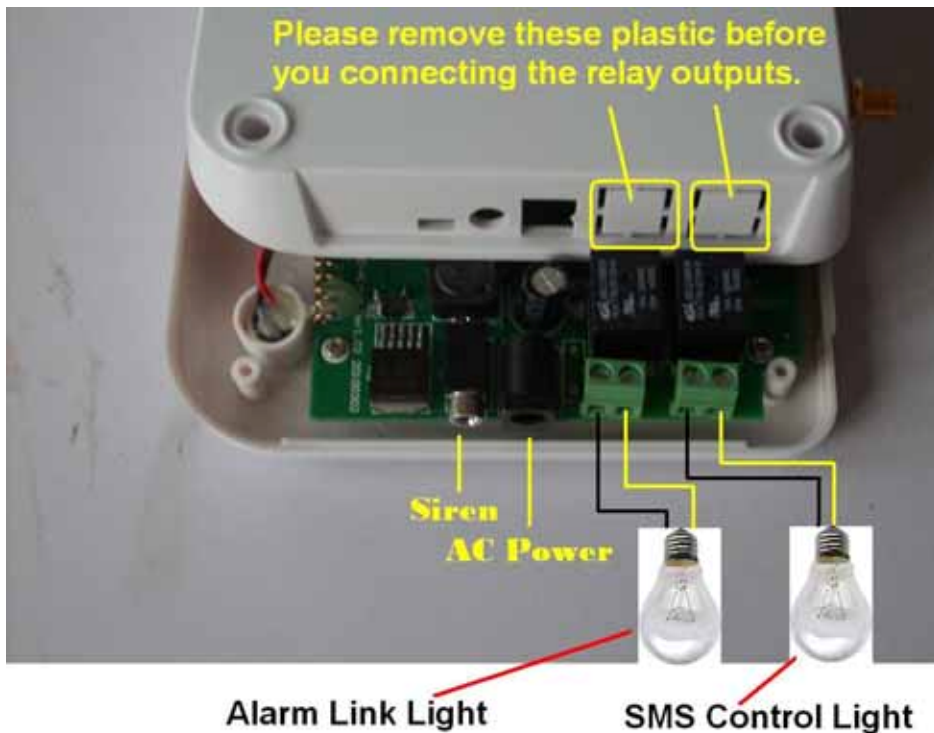

9. Add Wireless Sensors to the Control Unit

Notice:

Some wireless sensors must be coded by manual as below 9.1 step; some wireless sensors needn't coded by manual, because of we will use the learning code sensor. The learning code wireless sensor you can omit the 9.1 step, can be learned to the system directly, like the PIR-100B and DM-100A.

The Wireless sensors in the package box are pre-coded prior to shipping. The Max. Quantity of RF sensors is 16, if you need add more then you can set the wireless sensor with the same jumper. Add additional wireless

sensors to the control units, please help to see below:

9.1 Prepare the RF Sensors of PT2262 IC Code

- 1) Prepare the RF sensors, Open the back cover of the Wireless sensor carefully;
- 2) Locate the IC boards black jumpers, labeled A0-A7 and D0-D3.
- 3) Configured the A0~A7 and D0~D3 different from each wireless sensors(Includes wireless door sensor, wireless smoke sensor, wireless gas leakage sensor, wireless pir motion sensor and so on). If configured the A0~A7 and D0~D3 are the same, the system will treat them as the same one sensor.
- 4) Also, please check the Resistors value is 3.3M Ohm, there're 3 Jumpers, 1.5M,3.3M, and 4.7M. if you select incorrect value, the wireless distance usually very short or can not learn to the alarm panel.

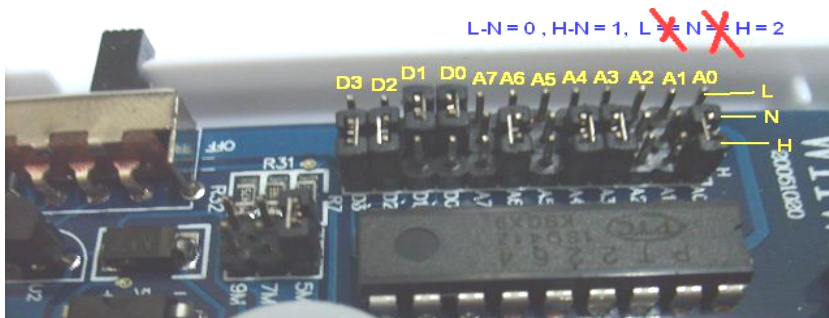

9.2 Enter the RF Sensor Adding Menu.(See 6.2.2.1 Add/Del RF Parts)

Select the Zone number, press Ok, finished it then press OK to select the Normal Type Or Stay Type, then following the instruction: **1.Turn On the Device**, means trigger the RF sensor, the system will show a code, then **press Enter Key** on the Keyboard. The system will ask you repeat the operation, so please trigger RF sensor again, when you see the Code, then press the Enter Button on the Keyboard, the system will display **Saved OK**. It means the wireless sensor added to the system. Repeat this operation to add other wireless sensors.

Notice:

- a) One time can add only 1 wireless sensor;
- b) The Name of the RF sensor can be modified by SMS commands. Please see chapter 6.3.

9.4 Add Remote Controls to the Control unit:

Because of both of the GSM ALARM KIT 16 and its remote controls are with learning code, you can add the remote control to the GSM ALARM KIT 16 directly following the 6.2.2.1

Add/Del RF Parts

- a) Enter the Add/Del RF Parts menu;
- b) Select **2. Edit Remote Ctrl**, then press **Enter** button,
- c) then following the instruction: **1. Turn On the Device**, means trigger the Remote Control, the system will show a code, then **press Enter Key** on the Keyboard. The system will ask you repeat the operation, so please trigger Remote Control again, when you see the Code, then press the Enter Button on the Keyboard, the system will display **Saved OK**. It means the Remote Control added to the system. Repeat this operation to add other remote controls.

Notice:

- 1) VVVV means this serial position saved one remote control already; you can learn a new remote control to replace it.

9.5 Delete all wireless sensors and remote controls.

Go back to the menu, then select the Remove All, select it then the system will alert Are You Sure Æ Press Enter to remove all the RF Parts of the system.

10. Technical specifications of Control Unit

Rated Voltage: 9~12VDC 1.5A Standby current: 30-40mA

Siren Output Voltage: 12VDC

Working temperature: -10□□+60□; Storage temperature:-20□□+60□

Relative humidity: 10-90%, No condensation

Work frequency: 900/1800 MHz or 850/900/1800/1900MHz

Communication protocol: GSM PHASE 2/2+ (include data service)

Wireless sensor receiving frequency: 433.92 MHz

Wireless sensor permission quantity: 16Pcs

Remote Control permission quantity: 5Pcs

Effective distance wireless of remote control: 100 m

Battery: Built-in lithium-ion battery: 1000mAh@3.7V

Standby time Approx.24hours (depending on the network condition)

Size: 180mmX125mmX30mm (LXWXH); Net Weight: 0.32Kg

11. Important information

- 1) Please read the User Manual carefully before you install the Control Unit and set the Control Unit.
- 2) Do not install the system in close vicinity with objects that generate strong interference, such as TV set and computer.
- 3) Install the system in a hidden place.
- 4) Avoid getting water into the Control Unit.
- 5) Have a secure connection to the main power supply.
- 6) This product was designed for the indoor use.
- 7) Opening the control unit cover will void the warranty.
- 8) More information will be available of the GSM ALARM KIT 16, we will not inform you again after we upgraded, please check with your dealers.

12. Maintenance

- 1) If the Control Unit works, while the remote control and other sensors fail, please check and change the battery.
- 2) If the remote control works, but the Control Unit fails to send SMS texts, switch the power of Control Unit off and switch it on after one minute . Test this system after another minute, or check the settings are correct and the GSM Signals are strong enough.

- 3) If the Control Unit can run and sensors work, but cannot send SMS texts, please change SIM Card to check it.
- 4) If the problem cannot be solved, please contact the distributor or manufacturer.

13. Warranty

- 1) This system is warranted to be free of defects in material and workmanship for one year from the date of purchase.
- 2) This warranty does not extend to any defect, malfunction or failure caused by abuse or misuse by the Operating Instructions. In no event shall the manufacturer be liable for any alarm system altered by purchasers.

14. Trouble Shooting Guide

PROBLEM	CAUSE	POSSIBLE SOLUTION
GSM Module initialization failed	<ol style="list-style-type: none"> 1) Backup battery with low voltage;GSM Module connection loose in transportation; 2) GSM Signal is too weak. 	<ol style="list-style-type: none"> 1) Please contact the AC Power; 2) Please help to take the panel to a mobile phone repairmen store, and then ask the engineer to check the GSM Module socket and the GSM Module connection; 3) Please change another position to install the alarm panel.
Automatically Restart	<ol style="list-style-type: none"> 1) Backup battery with low voltage. 	<ol style="list-style-type: none"> 1) When the backup battery voltage is lower than 3.7V, the panel will alert by buzzer sounds. Please help to contact the AC Power.
Wireless Sensor transmission short	<ol style="list-style-type: none"> 1) Wireless sensor with low voltage; 2) Wireless sensor used PT2262 IC, and 	<ol style="list-style-type: none"> 1) Please replace the battery of the wireless sensor, usually once /year; 2) Please correct the resistor value to 3.3M Ohm of the PT2262 Wireless

	<p>incorrect Value;</p> <p>3) Haven't pull out wireless antenna;</p> <p>4) Electromagnetic interference;</p> <p>5) The wireless receiver in the panel with problem.</p>	<p>sensor;</p> <p>3) Please pull out the wireless sensor antenna;</p> <p>4) Please install the wireless sensors or alarm panel away the electric equipments;</p> <p>5) Please contact your distributors or manufacturer to replace it.</p>
False Alarm	<p>1) PIR Motion sensor installation incorrect;</p> <p>2) Used 24H zones or SOS Zones or Watchdog zone.</p>	<p>1) Please see the PIR Motion sensor installation user manual carefully;</p> <p>2) Please check if any sensor assigned to these special zones and made incorrect activated.</p>
Alarm without SMS/ Alarm without Dial/ No action after send SMS command	<p>1) GSM Operator communication protocol;</p> <p>2) Haven't setup SMS Alert/Auto dial Numbers.</p> <p>3) Caps Lock letters in the SMS Commands.</p>	<p>1) Please setup the SMS Alert Numbers;</p> <p>2) Please help to see Page 15, the sample of setup the telephone numbers;</p> <p>3) Please check the commands with CAPS LOCK and correct format.</p> <p>4) Also, please help to change another GSM Operator SIMCard to test it.</p>