

Fire Control and Repeat panels

(Conventional 1, 2, 4 and 8 Zone panel range)



This manual covers the Operating instructions and Log book, and is intended for use by the End User.

The manual should be located in a secure but accessible position close to the panel.

It is the responsibility of the End User to maintain the Log Book.

An Installation and Commissioning guide has been supplied for your installer with this panel.

Operating instructions

Contents

| | Page |
|--------------------------------|------|
| User responsibility | 2 |
| Testing a Manual Call Point | 3 |
| Control & Indications | 4 |
| Operating instructions | 5 |
| Operating instructions for AL2 | 7 |
| Log book | 9 |

User responsibility

Your fire alarm system should have been designed, installed and commissioned to your site specific requirements and in accordance with the requirements of BS5839 Part 1. You should have received instructions about your system during the handover stage and must make arrangement to ensure the system is regularly tested and maintained.

It is recommended that the **person responsible** for the fire alarm system should ensure the system is tested and maintained in accordance with the requirements of BS5839 Part 1 and become familiar with:

- how to operate the controls and interpret the indications given at the control panel and
- keep up to date all documentation associated with the system.

CAUTION: Any servicing work on the fire alarm system must be carried out by a suitably trained person, refer to your servicing organisation.

Daily

BS 5839:Part 1, states that the system should be inspected daily to ensure:

- that a normal indication is given at the control and indicating equipment.
- that any previously indicated **fault** condition has received appropriate attention.
- all the system events are entered into the Log Book for future reference.
- that the use of the area(s) inspected has not changed since the system was designed.

- That no unsafe practices that could lead to fire are being undertaken.

Weekly

When testing the system there may be a need to isolate ancillary outputs and to contact the alarm receiving centre before and after the weekly test.

- A different manual call point of the system should be tested to ensure the system is capable of operating under alarm conditions.
- The operation of the **alarm** should be checked to remind those occupying the premises that there is a fire alarm system with a particular sound.

NOTE: The test should be performed at a regular time to avoid confusion between a test and a genuine fire alarm. The alarm receiving centre must be contacted before and after the test to check alarms are received and also to avoid unwanted alarms.

Quarterly

At quarterly intervals the system should be inspected and any work necessary should be performed by a trained maintenance engineer.

NOTE: For help with service and maintenance please refer to your servicing organisation, see contact details entered in the log book.

Limitation of false alarm

It is recommended that the person responsible for the fire alarm system should arrange for suitable investigation and appropriate action on occasion of every false alarm. For a system having less than 40 automatic fire detectors

installed, an in-depth investigation should be instigated on occurrence of two false alarms in any rolling 12 months. For a system having more than 40 automatic fire detectors an investigation should be instigated if there has been:

- one false alarm for every 20 detectors installed in the system in any rolling 12 months, or
- two or more false alarm occurrence from a single device.

Battery Replacement

NOTE: Any servicing work on the System must be carried out by a servicing organisation.

Under normal operating conditions the maintenance free **lead acid** batteries in the Control and Repeat panels can have a useful life of up to **5 years** from the date of manufacture.

NOTE: It is recommended that these batteries are replaced at 4 Yearly intervals from the date the System is first commissioned.

CAUTION: The batteries should only be replaced by trained service personal.

Testing a Manual Call Point

Testing a Manual call point

To test a manual call point you will need a call point test key.

- Push the test key through the hole in the underside of the call point to engage the test cam mechanism and push to operate the cam mechanism.
- At this point the test key is retained in the call point and pulling it out will reset the glass.

NOTE: The alarm sounders in the system will be activated by this test. To **silence alarms** and **reset the system**, see **operating instructions**.

How to replace broken glass inside a Manual call point

WARNING: Take appropriate precautions when clearing broken glass to prevent injury.

NOTE: A weather resistant version of manual call points will have two gaskets, a Cover/glass gasket and a Spacer/cover gasket, which must be installed in their respective position.

These procedures assume the cover on the manual call point is open and any broken glass has been cleared.

- a) Insert the glass beneath the opaque slider ① and locate bottom of the glass into recess, ensure the thumb wheel is up as shown.
- b) Place the test key on the cam (thumb wheel) ②.
- c) Fit the call point cover by hooking it into the top of the unit. Make sure that the glass is properly seated (held down). Withdraw the test key from the call point ③ and then use it to fit the screw ④ securing the cover to the back box.

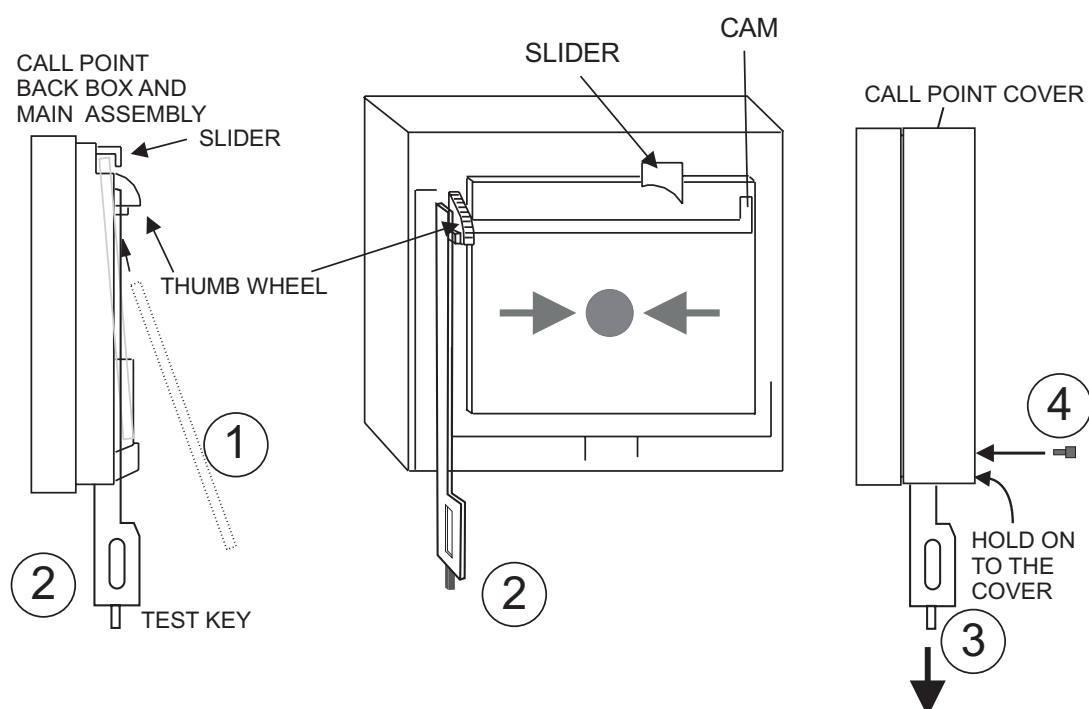

Controls and indicators

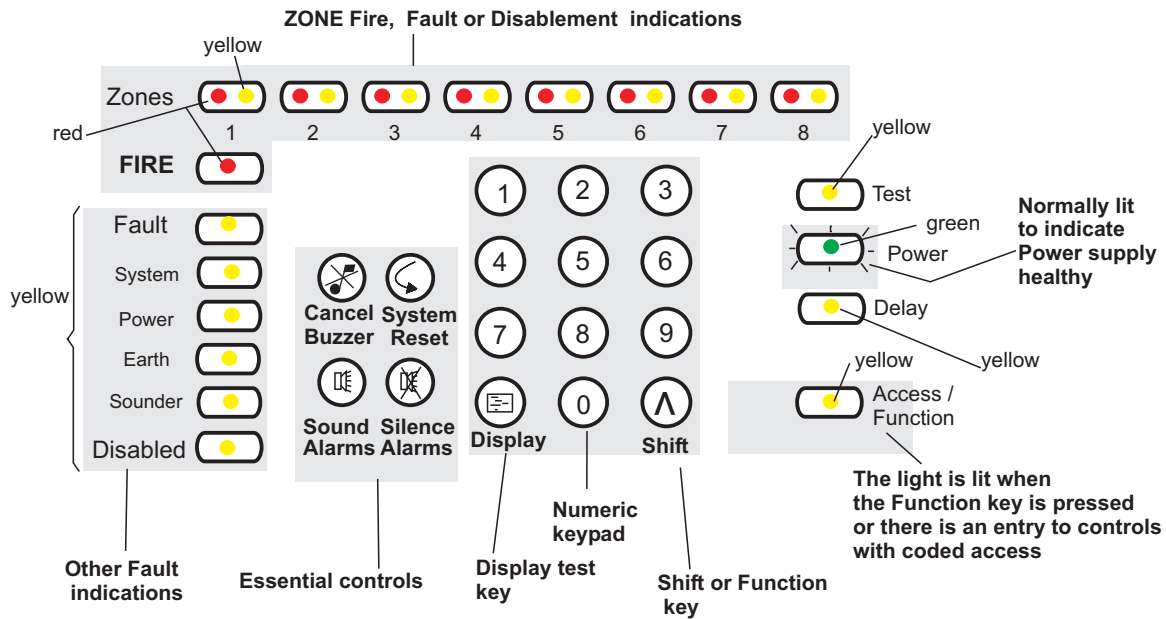

CONTROLS - are only available when an access code is entered.

Numeric keypad. Allows the entry of numeric data.

- Shift key.** The Shift/Function key gives access to the main functions of the panel.
- Display test key.** Pressing the Display Test key after entering access code# will initiate a sequence which illuminates all the indicators in turn enabling them to be checked.

Coded entry is only required if Cancel Buzzer and Display Test functions are configured for operation at Access level 2.

- Cancel Buzzer.** Pressing the Cancel Buzzer button after entering access code# will stop the internal buzzer sounding.
- System Reset.** The system reset key when pressed after entering access code will return the system to its normal operating state. If there are uncleared fires or faults then these conditions will re-occur.
- Sound Alarms.** Pressing the Sound Alarms button after entering access code will sound

all of the system alarms. Should only be pressed in an emergency or at other agreed times, ie for sounder tests etc. Pressing the sound alarms button does not action the auxiliary relay.

- Silence Alarms.** Pressing the Silence Alarms button after entering access code will silence the system alarms. Should only be pressed when the emergency is over.

Indicators

- Fire.** When lit indicates that the system has detected a fire.
- Fault.** When lit or flashing indicates that there is a fault condition on the system which requires rectification.
- Zone Fire/Fault/Disablement.** Red indicator illuminates when there is a zone fire, it can be a steady or flashing indication. For a zone fault the yellow indicator is flashing. A lit zone yellow indicator along with the Disabled indicator is used to show a disabled zone.
- System Fault.** This indicator when lit indicates that there is a fault in the panel's processor.

- Power Fault.** When lit or flashing indicates that there is a power supply fault present.

- Earth Fault.** This indicator when lit or flashing indicates that there is an Earth Fault on the system.

- Sounder Fault.** When flashing in conjunction with a flashing fault indicator indicates a sounder fault. When lit in conjunction with the disabled indicator indicates that the sounders are disabled.

- Disabled.** Illuminates along with the sounder or the zone indicators to show a disabled condition.

- Test.** When lit indicates that the panel is in Test mode.

- Power.** When lit indicates that the panel is powered up.

- Delay.** When lit it indicates that a delay will be effective after detection of a fire before activation of system alarms.

- Access/Function.** The Access/Function lamp will flash when the shift key is pressed and will be lit when the coded functions are accessed.

Operating instructions



Normal indications

Under normal condition the panel should give a healthy indication, with only the **green**  **Power light lit.**

The control panel provides system security by password entry to controls.





Fire Condition

In the event of an automatic fire detection the indications given are:

- FIRE  light is lit.
- Zones-fire  light is lit.
- buzzer sounds continuous tone.
- system alarm sounders are activated
- if applicable, auxiliary equipment is actuated
- if applicable, automatic link to the Fire Brigade is initiated.





After the emergency is over

After the emergency is over silence the alarms and reset the system:

- a) Enter the **3 digit code**    to gain access to the controls.
- b) Press the **Silence Alarms**  button. Notice the system alarm sounders are silenced and local buzzer sounds a continuous tone.
- c) After the cause of the alarm has been investigated, ensure smoke and excess heat have had time to clear from automatic detectors and broken manual call point glasses have been replaced where necessary.
Press the **System Reset**  button. Notice the indications return to their pre fire status.





To Sound Alarms or Resound Alarms

To re-sound the alarm sounders during a fire condition:

- a) Enter the **3 digit code**    to gain access to the controls.
- b) Press the **Sound Alarms**  button. Notice the system alarm Sounders are activated.

To Silence Alarms

To silence system alarm sounders after they have been activated:

- a) Enter the **3 digit code**    to gain access to the controls.
- b) Press the **Silence Alarms**  button. Notice the system alarm Sounders are silenced.

Indications given of various conditions

| | | CONDITIONS | | | | |
|------------|--|------------|--------|---------------------------|------------------------|----------------------|
| | | Normal | Fire | New fire (different zone) | Access level 2, 3 or 4 | Function key pressed |
| Visual | Zone Fire (1-8) - Red | | ON | ON | | |
| | Fire Common - Red | | ON | ON | | |
| | Disabled - Yellow | | | | | |
| | Test - Yellow | | | | | |
| | Power - Green | ON | ON | ON | ON | ON |
| | Access / Function - Yellow | | | | ON | Fast pulse |
| Audible | Buzzer | | ON | ON | | |
| | Sounder circuits | | ON | ON | | |
| Signal Out | Aux Relay contacts Normally de-energised | normal | C/O | C/O | normal | normal |
| | Common fault - Normally active | active | active | active | active | active |
| | Common fire- Normally deactive | de active | active | active | de active | de active |





C/O - Change Over

Fault Conditions

In the event of an automatic fault detection the indications given are:

- Common Fault light is lit and may be accompanied with other fault indicators
- buzzer sounds intermittent, (except for system fault which is a continuous sound).

To Cancel the fault buzzer

- a) #Enter the **3 digit code**    to gain access to the controls.
 - # Coded entry is only required if Cancel Buzzer function is configured for operation at Access level 2.
- b) After investigating fault, press the **Cancel Buzzer**  button. Notice the buzzer is silenced but other indications remain active.

The fault indications are normally automatically extinguished once the fault condition has been rectified.

Action to rectify fault

NOTE: All fault rectification work must be done by suitably qualified personnel.

- The fault indicators may be extinguished during a fire condition.
- The mains failure condition overrides all other fault indications in order to preserve battery standby capacity.

NOTE: A comprehensive fault finding guide is included in the Installation and Commissioning guide.

Other Access level 2 operations

To carry out a display test

- Enter the **3 digit code** (n) (n) (n) to gain access to the controls.
 - Coded entry is only required if Display test function is configured for operation at Access level 2.
- Press the 'shift' (A) button and then the **display** (display icon) button.
 - Ensure that all the LEDs light in sequence and the buzzer sounds.

How to set the panel to operate in Test mode A

Selecting **Test mode A** will cause triggered manual call point or fire detector in the test zone to give Fire indication for 10 seconds duration followed by a system reset.

- Enter the **3 digit code** (n) (n) (n) to gain access to the controls. Check that the Access/function lamp is lit.
- Press the (A) and **3** buttons followed by the **number** of the zone to be placed in test mode.
 - Check that the Test indicator is On and the respective zone fault indicator is lit.
 - The zone can now be tested without an alarm of fire.

How to exit from Access level 2 to Access level 1

- Press the (A) and **0** buttons.- Check that the Access/function lamp is extinguished. The panel is now at access level AL1.

How to set the panel to operate in Test mode B

Selecting **Test mode B** will cause triggered manual call point or fire detector in the test zone to give System alarms for the first 2 seconds and at the same time a Fire indication for 10 seconds duration followed by a system reset.

- Enter the **3 digit code** (n) (n) (n) to gain access to the controls. Check that the Access/function lamp is lit.
- Press the (A) and **4** buttons followed by the **number** of the zone to be placed in test mode.
 - Check that the Test indicator is On and the respective zone fault indicator is lit.
 - The zone can now be tested with 2 seconds alarm of fire.

How to cancel Test mode A/B operation

Selecting cancel Test mode A/B will cause the selected zone to operate normally.

- Enter the **3 digit code** (n) (n) (n) to gain access to the controls. Check that the Access/function lamp is lit.
- Press the (A) and **5** buttons followed by the **number** of the zone to have test mode cleared.
 - The test mode A or B is cancelled.

How to disable a zone

Disabling a zone will prevent fires being detected in the zone.

- Enter the **3 digit code** (n) (n) (n) to gain access to the controls. Check that the Access/function lamp is lit.
- Press the (A) and **1** buttons followed by the **number** of the zone to be disabled.
 - Check that the appropriate Zone fault indicator and the Disabled indicator are lit.
 - A detected fire in the disabled zone will not cause the panel to go into fire condition.

How to enable a zone

Enabling a zone will cause the zone to operate normally.

- Enter the **3 digit code** (n) (n) (n) to gain access to the controls. Check that the Access/function lamp is lit.
- Press the (A) and **2** buttons followed by the **number** of the zone to be re-enabled.
 - The previously disabled zone is re-enabled.

How to disable sounders

Disabling alarm sounders will prevent sounders from operating.

- Enter the **3 digit code** (n) (n) (n) to gain access to the controls. Check that the Access/function lamp is lit.
- Press the (A) and **1** buttons followed by **0**.
 - Check that the Sounder and Disabled indicators are lit.
 - The Sounder circuits are disabled.

How to enable sounders

Enabling alarm sounders will cause sounders to operate normally.

- Enter the **3 digit code** (n) (n) (n) to gain access to the controls. Check that the Access/function lamp is lit.
- Press the (A) and **2** buttons followed by **0**, the previously disabled sounders are now re-enabled.

How to set and unset the Delay mode

When a Delay mode is active there is a delay between detecting a fire and sounding the alarms to allow the fire to be investigated.

- Enter the **3 digit code** (n) (n) (n) to gain access to the controls. Check that the Access/function lamp is lit.
- Press the (A) and **6** buttons, the **Delay mode** toggles between Delay and No Delay each time this operation is performed. When the Delay mode is selected the Delay lamp is lit.

Log Book

Fire Alarm System

In order to satisfy the recommendations of BS 5839 Part 1 there should be a log book to record system events, that is maintained by a responsible person. The following pages provide layout of a log book..

Address of protected premises _____

Responsible person: _____

System designer: _____

System Installer: _____

System commissioned by: _____

System accepted by: _____

Verification undertaken by: _____

The system is maintained under contract by: _____ Until: _____

Telephone number: _____ who should be contacted if maintenance is required

List of component requiring periodic replacement: _____

| |
|--------------|
| AL2 password |
| |

Record zone number and zonal description.

| Zone number | Zonal description (usually name of the location) |
|-------------|--|
| Zone 1 | |
| Zone 2 | |
| Zone 3 | |
| Zone 4 | |
| Zone 5 | |
| Zone 6 | |
| Zone 7 | |
| Zone 8 | |

System configuration record

Record of how the system is configured.

Mark in the table below any deviation(s) from the standard factory settings.

Detection and zone circuit configuration

| Zone number | 1 | 2 | 3 | 8 | 5 | 6 | 7 | 8 |
|--|---|---|---|---|---|---|---|---|
| Normal zone operation (<i>factory setting</i>) | | | | | | | | |
| Non latching zone operation | | | | | | | | |
| First fire to be a pulsing indication (<i>factory setting</i>) | | | | | | | | |
| First fire to be a steady indication | | | | | | | | |
| Zone short circuit to give a fault (<i>factory setting</i>) | | | | | | | | |
| Zone short circuit to give a fire | | | | | | | | |

Sounders and system reset configuration

| | | |
|--|--|--|
| Silence alarms and reset to operate independently (<i>factory setting</i>) | | |
| Silence alarms and reset to operate as per BS5839: Part 4 | | |
| Reset to also action the silence alarms | | |
| Sound alarms to operate in fire condition only (<i>factory setting</i>) | | |
| Sound alarms to operate at any time | | |
| Auxiliary relay to energise with fire (<i>factory setting</i>) | | |
| Auxiliary relay to energise with sound alarms | | |

Access level

| | Access levels | AL1 | AL2 |
|--|---------------|-----|-----|
| Cancel buzzer (AL1 - factory setting) | | | |
| Test A & B mode, Cancel Test (AL2 - factory setting) | | N/A | |
| Display test (AL1 - factory setting) | | | |

Repeat panel information

| Repeat panel | EEPROM location | EEPROM Data (address) | Name of the area where the panel is installed on site |
|------------------|-----------------|-----------------------|---|
| 1st Repeat panel | | | |
| 2nd Repeat panel | | | |
| 3rd Repeat panel | | | |
| 4th Repeat panel | | | |

Delay mode setting: _____ minutes

Location of system devices

Record of devices installed in the system, their locations and zone relationships for reference.

| Type of system device | Location | Zones | | | | | | | |
|-----------------------|----------|-------|---|---|---|---|---|---|---|
| | | 1 | 2 | 3 | 4 | 5 | 6 | 7 | 8 |
| | | | | | | | | | |
| | | | | | | | | | |
| | | | | | | | | | |

Events Log

It is recommended that a Log book is created where a record of system events and work done is kept.

Record events other than false alarms and maintenance work.

| Date | Time | Event (eg test, fire alarm signal, fault) | Zone (where applicable) | Device (where applicable) | Action required (where applicable) | Date completed (where applicable) | Initials |
|---------|------|---|-------------------------|---------------------------|------------------------------------|-----------------------------------|----------|
| 30/8/04 | 9am | Weekly fire test | 1 | 5 | - | - | PH |
| | | | | | | | |
| | | | | | | | |
| | | | | | | | |

Maintenance work

| Date | Time | Zone (where applicable) | Device (where applicable) | Reason for work | Work carried out | Further work required | Signature |
|--------|------|-------------------------|---------------------------|-----------------------|------------------|-----------------------|-----------|
| 5/3/04 | 5pm | - | - | Quarterly maintenance | As per schedule | customer advised | PMH |
| | | | | | | | |
| | | | | | | | |
| | | | | | | | |

False Alarms

Do not record other events and maintenance work details in this log, see respective sections.

Categories: Unwanted - unwanted false alarm, Equipment - equipment false alarm, Good intent - false alarm with good intent, Malicious - malicious false alarm and Unknown - cause of alarm not known.

| Date | Time | Device that triggered the alarm signal | Cause (if known) | Brief circumstances (where cause is unknown, record activities in the area) | Maintenance visit required (Yes/No) | Finding of maintenance technician (where applicable) | Category # | Further action required (where applicable) | Action completed (where applicable) |
|--------|----------|--|---------------------------------|---|-------------------------------------|--|------------|--|-------------------------------------|
| 9/9/04 | 12:30 pm | 17 | fire detected in room 2 floor 1 | Bin content set on fire | Y | Fire damaged detector | Malicious | None | Detector replaced |
| | | | | | | | | | |
| | | | | | | | | | |
| | | | | | | | | | |



0086

Gent by Honeywell
Hamilton Industrial Park, 140 Waterside Road, Leicester LE5 1TN, UK

0086-CPD-553764

Xenex

EN54-2: 1997, A1:2006
Control and Indicating equipment for fire detection and fire alarm systems in buildings

7.8 Output to Fire alarm device(s)
7.10 Test Conditions
7.11 Delays to action outputs

EN54-4: 1997, A1:2002, A2:2006
Power supply equipment for fire detection and fire alarm systems in buildings



WEEE Directive:
At the end of their useful life, the packaging, product and batteries should be disposed of via a suitable recycling centre. Do not dispose of with your normal household waste. Do not burn.



At the end of their useful life, the packaging, product and batteries should be disposed of via a suitable recycling centre and in accordance with national or local legislation.

Gent by Honeywell reserves the right to revise this publication from time to time and make changes to the content hereof without obligation to notify any person of such revisions of changes.

| | | | |
|---|---|---|---|
|  | Hamilton Industrial Park, Waterside Road, Leicester LE5 1TN, UK | | Website: www.gent.co.uk |
| | Telephone: +44 (0) 116 246 2000 | Tech. Support: www.gentexpert.co.uk | Fax (UK): +44 (0)116 246 2300 |