

# Always there to help you

Register your product and get support at  
[www.philips.com/support](http://www.philips.com/support)



HTB3520  
HTB3550  
HTB3580

# User manual

# PHILIPS



# Contents

---

<b>1 Important</b>	2
Safety	2
Care for your product	3
Care of the environment	3
3D health warning	3

---

<b>2 Your home theater</b>	4
Main unit	4
Remote control	5
Connectors	6

---

<b>3 Connect and set up</b>	7
Connect speakers	7
Connect to TV	8
Connect audio from TV and other devices	9
Set up speakers	10
Set up EasyLink (HDMI-CEC control)	10
Connect and set up a home network	11

---

<b>4 Use your home theater</b>	13
Access the home menu	13
Auto play	13
Discs	13
Play audio through Bluetooth	15
Connect Bluetooth via NFC	16
Data files	16
USB storage devices	17
Audio, video, and picture options	17
Radio	19
External audio device	20
Browse PC through DLNA	20
Browse Smart TV	22
Choose sound	23

---

<b>5 Change settings</b>	24
Language settings	24
Picture and video settings	25
Audio settings	25
Parental control settings	25
Display settings	25
Energy saving settings	26
Speaker settings	26
Restore default settings	26

---

<b>6 Update software</b>	27
Check software version	27
Update software through USB	27
Update software through the Internet	28

---

<b>7 Product specifications</b>	28
---------------------------------	----

---

<b>8 Troubleshooting</b>	32
--------------------------	----

---

<b>9 Notice</b>	35
Copyright	35
Open source software	35
Compliance	35

---

<b>10 Language code</b>	36
-------------------------	----

---

<b>11 Index</b>	37
-----------------	----

---

# 1 Important

Read and understand all instructions before you use your product. If damage is caused by failure to follow instructions, the warranty does not apply.

---

## Safety

### Risk of electric shock or fire!

- Never expose the product and accessories to rain or water. Never place liquid containers, such as vases, near the product. If liquids are spilt on or into the product, disconnect it from the power outlet immediately. Contact Philips Consumer Care to have the product checked before use.
- Never place the product and accessories near naked flames or other heat sources, including direct sunlight.
- Never insert objects into the ventilation slots or other openings on the product.
- Where the mains plug or an appliance coupler is used as the disconnect device, the disconnect device shall remain readily operable.
- Batteries (battery pack or batteries installed) shall not be exposed to excessive heat such as sunshine, fire or the like.
- Disconnect the product from the power outlet before lightning storms.
- When you disconnect the power cord, always pull the plug, never the cable.

### Risk of short circuit or fire!

- Before you connect the product to the power outlet, ensure that the power voltage matches the value printed on the back or bottom of the product. Never connect the product to the power outlet if the voltage is different.

### Risk of injury or damage to the home theater!

- For wall-mountable products, use only the supplied wall mount bracket. Secure the wall mount to a wall that can support the combined weight of the product and the wall mount. Koninklijke Philips N.V. bears no responsibility for improper wall mounting that results in accident, injury or damage.
- For speakers with stands, use only the supplied stands. Secure the stands to the speakers tightly. Place the assembled stands on flat, level surfaces that can support the combined weight of the speaker and stand.
- Never place the product or any objects on power cords or on other electrical equipment.
- If the product is transported in temperatures below 5°C, unpack the product and wait until its temperature matches room temperature before connecting it to the power outlet.
- Visible and invisible laser radiation when open. Avoid exposure to beam.
- Do not touch the disc optical lens inside the disc compartment.
- Parts of this product can be made of glass. Handle with care to avoid injury and damage.

### Risk of overheating!

- Never install this product in a confined space. Always leave a space of at least four inches around the product for ventilation. Ensure curtains or other objects never cover the ventilation slots on the product.

### Risk of contamination!

- Do not mix batteries (old and new or carbon and alkaine, etc.).
- Danger of explosion if batteries are incorrectly replaced. Replace only with the same or equivalent type.
- Remove batteries if they are exhausted or if the remote control is not to be used for a long time.
- Batteries contain chemical substances, they should be disposed of properly.

### Risk of swallowing batteries!

- The product/remote control may contain a coin/button type battery, which can be swallowed. Keep the battery out of reach of children at all times! If swallowed, the battery can cause serious injury or death. Severe internal burns can occur within two hours of ingestion.
- If you suspect that a battery has been swallowed or placed inside any part of the body, seek immediate medical attention.
- When you change the batteries, always keep all new and used batteries out of reach of children. Ensure that the battery compartment is completely secure after you replace the battery.
- If the battery compartment cannot be completely secured, discontinue use of the product. Keep out of reach of children and contact the manufacturer.



This is CLASS II apparatus with double insulation, and no protective earth provided.

---

## Care for your product

- Do not insert any objects other than discs into the disc compartment.
- Do not insert warped or cracked discs into the disc compartment.
- Remove discs from the disc compartment if you are not using the product for an extended period of time.
- Use only microfiber cloth to clean the product.

---

## Care of the environment



Your product is designed and manufactured with high quality materials and components, which can be recycled and reused.



When this crossed-out wheeled bin symbol is attached to a product it means that the product is covered by the European Directive 2002/96/EC. Please inform yourself about the local separate collection system for electrical and electronic products.

Please act according to your local rules and do not dispose of your old products with your normal household waste.

Correct disposal of your old product helps to prevent potential negative consequences for the environment and human health.



Your product contains batteries covered by the European Directive 2006/66/EC, which cannot be disposed with normal household waste. Please inform yourself about the local rules on separate collection of batteries because correct disposal helps to prevent negative consequences for the environmental and human health.

---

## 3D health warning

- If you or your family has a history of epilepsy or photosensitive seizures, consult a medical professional before exposing yourself to flashing light sources, rapid image sequences or 3D viewing.

- To avoid discomfort such as dizziness, headache or disorientation, we recommend not watching 3D for extended periods of time. If you experience any discomfort, stop watching 3D and do not immediately engage in any potentially hazardous activity (for example driving a car) until your symptoms have disappeared. If symptoms persist, do not resume watching 3D without consulting a medical professional first.
- Parents should monitor their children during 3D viewing and ensure they do not experience any discomfort as mentioned above. Watching 3D is not recommended for children under six years of age as their visual system is not fully developed yet.

## 2 Your home theater

Congratulations on your purchase, and welcome to Philips! To fully benefit from the support that Philips offers (e.g. notification of product software upgrade), register your product at [www.philips.com/welcome](http://www.philips.com/welcome).

---

### Main unit

This section includes an overview of the main unit.

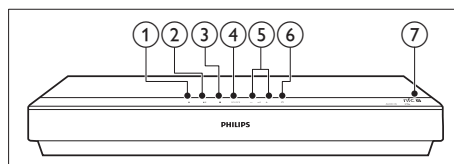

- ① ▲ (Open/Close)  
Open or close the disc compartment.
- ② ▶|| (Play/Pause)  
Start, pause or resume play.
- ③ ■ (Stop)  
Stop play.
- ④ SOURCE  
Select an audio, video, radio source or Bluetooth mode for the home theater.
- ⑤ - 🔊 + (Volume)  
Decrease or increase volume.
- ⑥ ⏻ (Standby-On)  
Switch the home theater on or to standby.
- ⑦ NFC tag  
Tap the NFC-enabled device on the tag for Bluetooth connection.

# Remote control

This section includes an overview of the remote control.

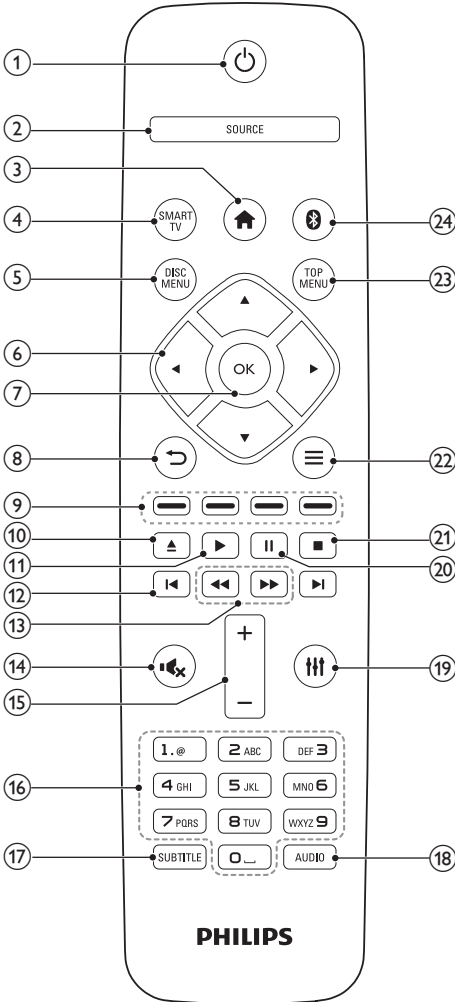

## ① **⏻ (Standby-On)**

- Switch the home theater on or to standby.
- When EasyLink is enabled, press and hold for at least three seconds to switch all connected HDMI CEC compliant devices to standby.

## ② **SOURCE**

Select a source: Radio/HDMI ARC/AUX/OPTICAL/COAXIAL/AUDIO IN for the home theater.

## ③ **🏠 (Home)**

Access the home menu.

## ④ **SMART TV**

Access online SmartTV service.

## ⑤ **DISC MENU**

- Switch to disc source.
- Access or exit the disc menu or pop-up menu when you play a disc.

## ⑥ **Navigation buttons**

- Navigate menus.
- In radio mode, press left or right to start auto search.
- In radio mode, press up or down to tune the radio frequency.

## ⑦ **OK**

Confirm an entry or selection.

## ⑧ **↶**

- Return to a previous menu screen.
- In radio mode, press and hold to erase the current preset radio stations.

## ⑨ **Color buttons**

Select tasks or options for Blu-ray discs.

## ⑩ **▲ (Open/Close)**

Open or close the disc compartment.

## ⑪ **▶ (Play)**

Start or resume play.

## ⑫ **◀ / ▶ (Previous/Next)**

- Skip to the previous or next track, chapter or file.
- In radio mode, select a preset radio station.

## ⑬ **◀◀ / ▶▶ (Fast Backward / Fast Forward)**

Search backwards or forward. Press repeatedly to change the search speed.

## ⑭ **🔇 (Mute)**

Mute or restore volume.

- 15 **+/- (Volume)**  
Increase or decrease volume.
- 16 **Alphanumeric buttons**  
Enter values or letters (using SMS style entry).
- 17 **SUBTITLE**  
Select subtitle language for video.
- 18 **AUDIO**  
Select an audio language or channel.
- 19 **III**  
Access or exit sound options.
- 20 **II (Pause)**  
Pause play.
- 21 **■**  
Stop play.
- 22 **≡**
  - Access more play options while playing a disc or a USB storage device.
  - In radio mode, set a radio station.
- 23 **TOP MENU**  
Access the main menu of a disc.
- 24 **⊗**  
Switch to Bluetooth mode.

## Connectors

This section includes an overview of the connectors available on your home theater.

### Front connectors

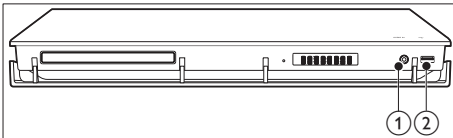

- 1 **AUDIO IN**  
Audio input from an external audio device (3.5mm jack).

- 2 **↔ (USB)**
  - Audio, video or picture input from a USB storage device.
  - Connect a USB mass storage to rent online video or to access BD-Live.

### Rear connectors

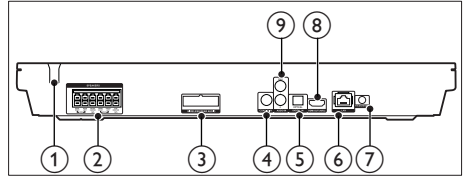

- 1 **AC MAINS~**  
Fixed AC power cable.
- 2 **SPEAKERS**  
Connect to the supplied speakers and subwoofer.
- 3 **WIRELESS REAR AUDIO**  
Connect to a Philips wireless module (Model: Philips RWSS5512, sold separately).
- 4 **COAXIAL IN**  
Connect to a coaxial audio output on the TV or a digital device.
- 5 **DIGITAL IN-OPTICAL**  
Connect to an optical audio output on the TV or a digital device.
- 6 **LAN**  
Connect to the LAN input on a broadband modem or router.
- 7 **FM ANTENNA**  
Connect to the supplied FM antenna.
- 8 **HDMI OUT (ARC)**  
Connect to the HDMI input on the TV.
- 9 **AUDIO IN-AUX**  
Connect to an analog audio output on the TV or an analog device.



# 3 Connect and set up

This section helps you connect your home theater to a TV and other devices, and then set it up.

For information about the basic connections of your home theater and accessories, see the quick start guide.

## Note

- For identification and supply ratings, see the type plate at the back or bottom of the product.
- Before you make or change any connections, make sure that all devices are disconnected from the power outlet.

## Connect speakers

The speaker cables are color-coded for easy connection. To connect a speaker to your home theater, match the color on the speaker cable to the color on the connector.

Speaker position plays a critical role in setting up a surround sound effect. For best effect, position all the speakers towards the seating position and place them close to your ear level (seated).

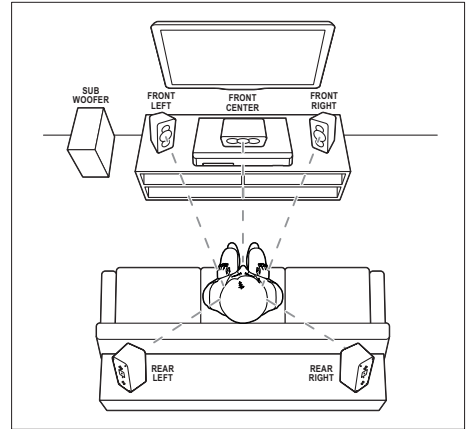

\*The actual speaker shapes may vary from the illustration above.

## Note

- Surround sound depends on factors such as room shape and size, type of wall and ceiling, windows and reflective surfaces, and speaker acoustics. Experiment with the speaker positions to find the optimum setting for you.

Follow these general guidelines for speakers placement.

- 1** Seating position:  
This is the center of your listening area.
- 2** **FRONT CENTER** (front center) speaker:  
Place the center speaker directly in front of the seating position, either above or below your TV.
- 3** **FRONT LEFT** (front left) and **FRONT RIGHT** (front right) speakers:  
Place the left and right speakers in the front, and at equal distance from the center speaker. Make sure that the left, right, and the center speakers are at equal distance from your seating position.
- 4** **REAR LEFT** (rear left) and **REAR RIGHT** (rear right) speakers:  
Place the rear surround speakers to the left and right side of your seating position, either in line with it or slightly behind it.

- 5 SUBWOOFER** (subwoofer):  
Place the subwoofer at least one meter to the left or right of the TV. Leave about 10-centimeter clearance from the wall.

## Make your rear speakers wireless

Connect the rear speakers to your home theater wirelessly using a wireless module accessory. For details, see the wireless module user manual.

### What you need

- A Philips wireless module. (Model: Philips RWSS5512, sold separately)

- 1 Connect the wireless transmitter to the **WIRELESS REAR AUDIO** connector on your home theater:

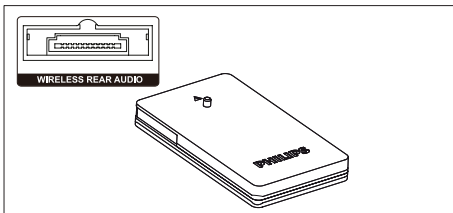

- 2 Connect the rear speakers to the wireless receiver:
- 3 Connect the wireless receiver to the power supply.

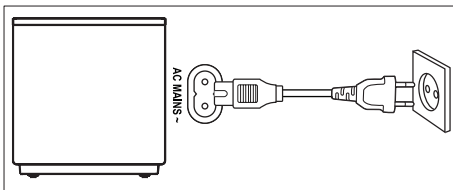

## Connect to TV

Connect your home theater to a TV to watch videos. You can listen to the TV audio through your home theater speakers. Use the best quality connection available on your home theater and TV.

## Option 1: Connect to TV through HDMI (ARC)

### Best quality video

Your home theater supports HDMI version with Audio Return Channel (ARC). If your TV is HDMI ARC compliant, you can hear the TV audio through your home theater by using a single HDMI cable.

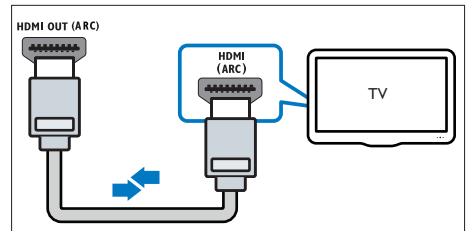

- 1 Using a High Speed HDMI cable, connect the **HDMI OUT (ARC)** connector on your home theater to the **HDMI ARC** connector on the TV.
  - The **HDMI ARC** connector on the TV might be labeled differently. For details, see the TV user manual.
- 2 On your TV, turn on HDMI-CEC operations. For details, see the TV user manual.
  - HDMI-CEC is a feature that enables CEC compliant devices that are connected through HDMI to be controlled by a single remote control, such as volume control for both the TV and the home theater. (see 'Set up EasyLink (HDMI-CEC control)' on page 10)
- 3 If you cannot hear the TV audio through your home theater, set up the audio manually. (see 'Set up the audio' on page 11)

## Option 2: Connect to TV through standard HDMI

### Best quality video

If your TV is not HDMI ARC compliant, connect your home theater to the TV through a standard HDMI connection.

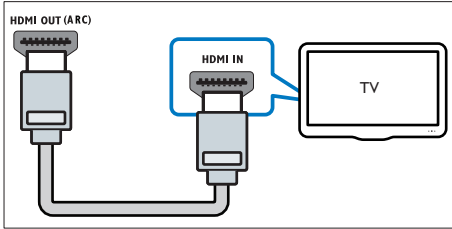

- 1 Using a High Speed HDMI cable, connect the **HDMI OUT (ARC)** connector on your home theater to the **HDMI IN** connector on the TV.
- 2 Connect an audio cable to hear the TV audio through your home theater (see 'Connect audio from TV and other devices' on page 9).
- 3 On your TV, turn on HDMI-CEC operations. For details, see the TV user manual.
  - HDMI-CEC is a feature that enables CEC compliant devices that are connected through HDMI to be controlled by a single remote control, such as volume control for both the TV and the home theater. (see 'Set up EasyLink (HDMI-CEC control)' on page 10)
- 4 If you cannot hear the TV audio through your home theater, set up the audio manually. (see 'Set up the audio' on page 11)

### Note

- If your TV has a DVI connector, you can use an HDMI/DVI adapter to connect to TV. However, some of the features may not be available.

## Connect audio from TV and other devices

Play audio from TV or other devices through your home theater speakers.

Use the best quality connection available on your TV, home theater, and other devices.

### Note

- When your home theater and TV are connected through HDMI ARC, an audio connection is not required (see 'Option 1: Connect to TV through HDMI (ARC)' on page 8).

## Option 1: Connect audio through a digital optical cable

### Best quality audio

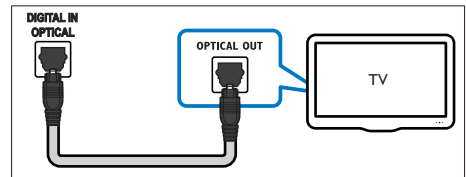

- 1 Using an optical cable, connect the **DIGITAL IN-OPTICAL** connector on your home theater to the **OPTICAL OUT** connector on the TV or other device.
  - The digital optical connector might be labeled **SPDIF** or **SPDIF OUT**.

---

## Option 2: Connect audio through a digital coaxial cable

Good quality audio

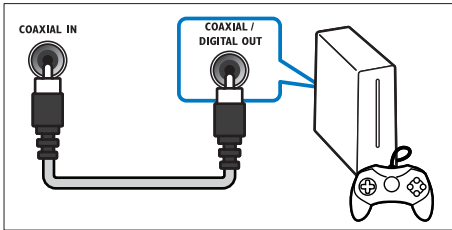

- 1 Using a coaxial cable, connect the **COAXIAL IN** connector on your home theater to the **COAXIAL/DIGITAL OUT** connector on the TV or other device.
  - The digital coaxial connector might be labeled **DIGITAL AUDIO OUT**.

---

## Option 3: Connect audio through analog audio cables

Basic quality audio

- 1 Using an analog cable, connect the **AUDIO IN-AUX** connectors on your home theater to the **AUDIO OUT** connectors on the TV or other device.

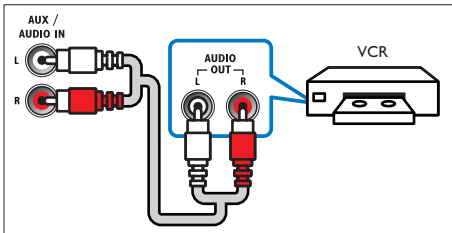

---

## Set up speakers

Set up the speakers manually to experience customized surround sound.

### Before you start

Make the necessary connections described in the quick start guide, and then switch the TV to the correct source for your home theater.

- 1 Press **▲ (Home)**.
- 2 Select **[Setup]**, and then press **OK**.
- 3 Select **[Audio] > [Speaker setup]**.
- 4 Enter the distance for each speaker, and then listen to the test tones and change the volume. Experiment with the speaker positions to find the ideal setting.

---

## Set up EasyLink (HDMI-CEC control)

This home theater supports Philips EasyLink, which uses the HDMI-CEC (Consumer Electronics Control) protocol. EasyLink-compliant devices that are connected through HDMI can be controlled by a single remote control.

### Note

- Depending on the manufacturer, HDMI-CEC is known by many names. For information on your device, see the user manual of the device.
- Philips does not guarantee 100% interoperability with all HDMI-CEC devices.

### Before you start

- Connect your home theater to the HDMI-CEC compliant device through HDMI connection.
- Make the necessary connections described in the quick start guide, and then switch the TV to the correct source for your home theater.

---

## Enable EasyLink

- 1 Press **⬆** (Home).
- 2 Select **[Setup]**, and then press **OK**.
- 3 Select **[EasyLink] > [EasyLink] > [On]**.
- 4 On your TV and other connected devices, turn on HDMI-CEC control. For details, see the user manual of the TV or other devices.
  - On your TV, set the audio output to 'Amplifier' (instead of TV speakers). For details, see the TV user manual.

---

## EasyLink controls

With EasyLink, you can control your home theater, TV, and other connected HDMI-CEC compliant devices with a single remote control.

- **[One Touch Play]** (One-touch play): When a video disc is in the disc compartment, press **▶ (Play)** to wake up the TV from standby, and then play a disc.
- **[One Touch Standby]** (One-touch standby): If one-touch standby is enabled, your home theater can switch to standby with the remote control of the TV or other HDMI-CEC devices.
- **[System Audio Control]** (System audio control): If system audio control is enabled, the audio of the connected device is output through your home theater speakers automatically when you play the device.
- **[Audio Input Mapping]** (Audio input mapping): If system audio control does not work, map the connected device to the correct audio input connector on your home theater. (see 'Set up the audio' on page 11)



### Note

- To change the EasyLink control settings, press **⬆** (Home), select **[Setup] > [EasyLink]**.

---

## Set up the audio

If you cannot hear the audio output of a connected device through your home theater speakers, do the following:

- Check that you have enabled EasyLink on all the devices, (see 'Set up EasyLink (HDMI-CEC control)' on page 10) and
- on your TV, set the audio output to "Amplifier" (instead of TV speakers). For details, see the TV user manual, and
- setup the EasyLink audio control.

- 1 Press **⬆** (Home).
- 2 Select **[Setup]**, and then press **OK**.
- 3 Select **[EasyLink] > [System Audio Control] > [On]**.
  - To play the audio from the TV speakers, select **[Off]**, and skip the following steps.
- 4 Select **[EasyLink] > [Audio Input Mapping]**.
- 5 Follow the onscreen instructions to map the connected device to the audio inputs on your home theater.
  - If you connect your home theater to the TV through an **HDMI ARC** connection, make sure that the TV audio is mapped to the ARC input on your home theater.

---

## Connect and set up a home network

Connect your home theater to a network router for a network setup, and enjoy:

- Streamed multimedia content (see 'Browse PC through DLNA' on page 20)
- Smart TV (see 'Browse Smart TV' on page 22)
- BD Live applications (see 'BD-Live on Blu-ray' on page 15)
- Software update (see 'Update software through the Internet' on page 28)



## Caution

- Familiarize yourself with the network router; media server software and networking principles. If necessary, read documentation that accompanies the network components. Philips is not responsible for lost, damaged, or corrupt data.

### Before you start

- For Smart TV and software updates, make sure that the network router has access to the Internet with high-speed connection and is not restricted by firewalls or other security systems.
- Make the necessary connections described in the quick start guide, and then switch the TV to the correct source for your home theater.

## Set up the wired network

### What you need

- A network cable (RJ45 straight cable).
- A network router (with DHCP enabled).

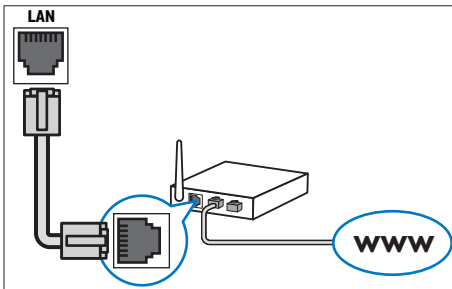

- 1 Using a network cable, connect the **LAN** connector on your home theater to the network router.
- 2 Press **⬆** (**Home**).
- 3 Select **[Setup]**, and then press **OK**.
- 4 Select **[Network]** > **[Network installation]** > **[Wired (Ethernet)]**.
- 5 Follow the onscreen instructions to complete the setup.
  - If connection fails, select **[Retry]**, and then press **OK**.

- 6 Select **[Finish]**, and then press **OK** to exit.
  - To view the network settings, select **[Setup]** > **[Network]** > **[View network settings]**.

## Personalize the network name

Name your home theater to easily identify it on your home network.

- 1 Press **⬆** (**Home**).
- 2 Select **[Setup]**, and then press **OK**.
- 3 Select **[Network]** > **[Name your Product:]**.
- 4 Press the **Alphanumeric buttons** to enter the name.
- 5 Select **[Done]**, and then press **OK** to exit.

## 4 Use your home theater

This section helps you use the home theater to play media from a wide range of sources.

### Before you start

- Make the necessary connections described in the quick start guide and the user manual.
- Complete the first-time setup. First-time setup appears when you turn on your home theater for the first time or if you do not complete the setup.
- Switch the TV to the correct source for your home theater (for example, HDMI, AV IN).

---

## Access the home menu

The home menu provides easy access to connected devices, setup and other useful features in your home theater.

- 1 Press **▲** (Home).  
↳ The home menu is displayed.
- 2 Press the **Navigation buttons** and **OK** to select the following:
  - **[Play disc]**: Start disc play.
  - **[Browse USB]**: Access the USB content browser.
  - **[Smart TV]**: Access Smart TV.
  - **[Browse PC]**: Access the computer content browser.
  - **[Setup]**: Access menus to change video, audio and other settings.
- 3 Press **▲** (Home) to exit.

---

## Auto play

Your home theater can automatically play a disc or a video file.

---

## Auto play disc

When the home theater is switched on, the disc automatically plays.

- 1 Press **▲** (Home).
- 2 Select **[Setup]**, and then press **OK**.
- 3 Select **[Preference] > [Auto play disc]> [On]**.
  - The feature is turned on.
  - To turn off the feature, select **[Off]**. The disc will not automatically play.

---

## Auto play video sequentially

If two or more video files are available in the same folder from a USB storage device or PC (via DLNA connection), the next video file automatically plays after the end of a video.

- 1 Press **▲** (Home).
- 2 Select **[Setup]**, and then press **OK**.
- 3 Select **[Preference] > [Auto play after video]> [On]**.
  - The feature is turned on.
  - To turn off the feature, select **[Off]**. The next video file will not automatically play after the end of a video in the same folder.

---

## Discs

Your home theater can play DVDs, VCDs, CDs, and Blu-ray discs. It can also play discs that you've made at home, such as CD-R discs of photos, videos, and music.

- 1 Insert a disc into the home theater.
- 2 If the disc does not play automatically, press **DISC MENU** to select disc source, or select **[Play disc]** from the home menu.
- 3 Use the remote control to control play.
  - It is normal to hear a little noise when you play a Blu-ray disc. This does not mean that your home theater is faulty.

---

## Play buttons

---

Button	Action
<b>Navigation buttons</b>	Navigate menus. Up/Down: Rotate the picture clockwise or counter-clockwise. Left/Right: Skip to the previous or next picture.
<b>OK</b>	Confirm an entry or selection.
<b>▶ (Play)</b>	Start or resume play.
<b>  </b>	Pause play.
<b>■</b>	Stop play.
<b>◀ / ▶</b>	Skip to the previous or next track, chapter or file.
<b>◀◀ / ▶▶</b>	Search fast backwards or forward. Search slow forward.
<b>AUDIO</b>	Select an audio language or channel.
<b>SUBTITLE</b>	Select subtitle language for video.
<b>DISC MENU</b>	Access or exit the disc menu.
<b>≡</b>	Access the advanced options when you play your audio, video, or media files. (see 'Audio, video, and picture options' on page 17)

---

---

## Synchronize video and sound

If the audio and video are not synchronized, delay the audio to match the video.

- 1 Press **≡**.
  - 2 Press the **Navigation buttons** (left/right) to select **[Audio sync]**, and then press **OK**.
  - 3 Press the **Navigation buttons** (up/down) to synchronize the audio with the video.
  - 4 Press **OK** to confirm.
- 

## Play Blu-ray 3D disc

Your home theater can play Blu-ray 3D video. Read the 3D health warning before playing a 3D disc.

## What you need

- A 3D TV
  - A pair of 3D glasses that are compatible with your 3D TV
  - A 3D Blu-ray video
  - A high speed HDMI cable
- 1 Using the high speed HDMI cable, connect your home theater to a 3D compatible TV.
  - 2 Make sure that the 3D video setting is enabled. Press **▲ (Home)**, select **[Setup] > [Video] > [Watch 3D video] > [Auto]**.
    - To play 3D discs in 2D mode, select **[Off]**.
  - 3 Play a Blu-ray 3D disc and put on the 3D glasses.
    - During video search and in certain play modes, the video is displayed in 2D. The video display returns to 3D when you resume play.

---

### Note

- To avoid flickering, change the brightness of the display.

---

## Bonus View on Blu-ray

On Blu-ray discs that support the Bonus View, enjoy extra content such as commentaries in a small screen window. Bonus View is also known as picture-in-picture.

- 1 Enable Bonus View in the Blu-ray disc menu.
- 2 While you play the movie, press **≡**.  
↳ The options menu is displayed.
- 3 Select **[PIP selection] > [PIP]**.
  - Depending on the video, PIP menu [1] or [2] is displayed.
  - To disable Bonus View, select **[Off]**.
- 4 Select **[2nd audio language]** or **[2nd subtitle language]**.
- 5 Select the language, and then press **OK**.



---



## BD-Live on Blu-ray

Access additional features on the Blu-ray discs with BD-Live content, such as internet chats with the director; the latest movie trailers, games, wallpaper; and ringtones.

BD-Live services and content vary from disc to disc.

### What you need

- Blu-ray disc with BD-Live content
- a USB storage device, with at least 1 GB of memory

- 1 Connect your home theater to a home network with Internet access (see 'Connect and set up a home network' on page 11).
- 2 Connect a USB storage device to the  (USB) connector at the front of your home theater for BD-Live download.
- 3 Press  (Home) and select **[Setup]** > **[Advanced]** > **[BD-Live security]** > **[Off]**.
  - To disable BD-Live, select **[On]**.
- 4 Select the BD-Live icon in the disc menu, and then press **OK**.
  - ↳ BD-Live starts to load. The loading time depends on the disc and your internet connection.
- 5 Press the **Navigation buttons** to navigate BD-Live, and then press **OK** to select an option.

### Note

- To clear the memory on the storage device, press  (Home), select **[Setup]** > **[Advanced]** > **[Clear memory]**.

---

## Play audio through Bluetooth

Through Bluetooth, connect the home theater with your Bluetooth device (such as an iPad, iPhone, iPod touch, Android phone, or laptop), and then you can listen to the audio files stored on the device through your home theater speakers.

### What you need

- A Bluetooth device which supports Bluetooth profile A2DP, and with Bluetooth version as 2.1 + EDR.
- The operational range between the home theater and a Bluetooth device is approximately 10 meters (30 feet).

- 1 Press  to select Bluetooth mode.
  - ↳ **BT** is displayed on the display panel.
- 2 On the Bluetooth device, switch on Bluetooth, search for and select the name of your home theater to start connection (see the user manual of the Bluetooth device on how to enable Bluetooth).
  - If prompted for a password, enter "0000".
- 3 Wait until the speakers of home theater beep.
  - ↳ When the Bluetooth connection succeeds, **BT READY** is displayed on the display panel for two seconds, and then the display comes back to **BT**.
  - ↳ If the connection fails, no beep sound is heard from the home theater, and **BT** is always displayed on the display panel.
- 4 Select and play audio files or music on your Bluetooth device.
  - During play, if a call is coming, music play is paused.
  - If music streaming is interrupted, place the Bluetooth device closer to the home theater.

- To exit Bluetooth, select other source.
  - When your switch back to Bluetooth mode, Bluetooth connection remains active.

#### Note

- The music streaming may be interrupted by obstacles between the device and home theater; such as wall, metallic casing that covers the device, or other devices nearby that operate in the same frequency.
- If you want to connect your home theater with another Bluetooth device, press and hold **▶** on the remote control to disable the currently connected Bluetooth device.
- Philips does not guarantee 100% compatibility with all Bluetooth devices.

## Connect Bluetooth via NFC

NFC (Near Field Communication) is a technology that enables short-range wireless communication between NFC-enabled devices, such as mobile phones.

### What you need

- A Bluetooth device with NFC function.
- For pairing, tap the NFC device onto the **NFC** tag of the home theater.

- Enable NFC on the Bluetooth device (see the device's user manual for details).
- Tap the NFC device onto the **NFC** tag of the home theater until the speakers of the home theater beep.
  - When the Bluetooth connection succeeds, **BT READY** is displayed on the display panel for two seconds, and then the display comes back to **BT**.
  - If the connection fails, no beep sound is heard from the home theater, and **BT** always displayed on the display panel.

- Select and play audio files or music on your NFC device.
  - To break the connection, tap again the **NFC** device onto the **NFC** tag on the home theater.

## Data files

Your home theater can play pictures, audio and video files contained in a disc or a USB storage device. Before you play a file, check that the file format is supported by your home theater (see 'File formats' on page 29).

- Play the files from a disc or USB storage device.
- To stop play, press **■**.
  - To resume the video from where you stopped, press **▶ (Play)**.
  - To play the video from the start, press **OK**.

#### Note

- To play DivX DRM protected files, connect your home theater to a TV through an HDMI cable.

## Subtitles

If your video has subtitles in multiple languages, select a subtitle language.

#### Note

- Make sure that the subtitle file has the exact same name as the video file. For example, if the video file is named 'movie.avi', name the subtitle file as 'movie.srt' or 'movie.sub'.
- Your home theater supports the following file formats: .srt, .sub, .txt, .ssa, .ass, .smi, and .sami. If the subtitles do not appear correctly, change the character set.

- While playing video, press **SUBTITLE** to select a language.

- 2 For DivX videos, if the subtitles do not appear correctly, continue the following steps to change the character set.
- 3 Press .
  - ↳ The options menu is displayed.
- 4 Select [**Character set**], and then select a character set that supports the subtitle.

### Europe, India, LATAM, and Russia

Character Set	Language
[Standard]	English, Albanian, Danish, Dutch, Finnish, French, Gaelic, German, Italian, Kurdish (Latin), Norwegian, Portuguese, Spanish, Swedish and Turkish
[Central Europe]	Albanian, Croat, Czech, Dutch, English, German, Hungarian, Irish, Polish, Romanian, Slovak, Slovene and Serbian
[Cyrillic]	Bulgarian, Belorussian, English, Macedonian, Moldavian, Russian, Serbian and Ukrainian
[Greek]	Greek
[Baltic]	Estonian, Latvian and Lithuanian
[Chinese]	Simplified Chinese
[Chinese-Traditional]	Traditional Chinese
[Korean]	English and Korean

### VOD code for DivX

Before you purchase DivX videos and play them on your home theater, register the home theater on [www.divx.com](http://www.divx.com) using the DivX VOD code.

- 1 Press  (Home).
- 2 Select [**Setup**], and then press **OK**.
- 3 Select [**Advanced**] > [**DivX® VOD Code**].
  - ↳ The DivX VOD registration code for your home theater is displayed.

## USB storage devices



Enjoy pictures, audio, and video stored on a USB storage device such as an MP4 player or digital camera.

### What you need

- A USB storage device that is formatted for FAT or NTFS file systems, and complies with the Mass Storage Class.
- A media file in one of the supported file formats (see 'File formats' on page 29).

### Note

- If you use a USB extension cable, USB HUB, or USB multi-reader, the USB storage device may not be recognized.

- 1 Connect a USB storage device to the  (USB) connector on your home theater.
- 2 Press  (Home).
- 3 Select [**Browse USB**], and then press **OK**.
  - ↳ A content browser is displayed.
- 4 Select a file, and then press **OK**.
- 5 Press the play buttons to control play (see 'Play buttons' on page 14).

## Audio, video, and picture options

Use advanced features when you play pictures, audio and video files from a disc or a USB storage device.

---

## Audio options

While playing audio, repeat an audio track, a disc, or a folder:

- 1 Press **≡** repeatedly to cycle through the following functions:
  - Repeat the current track or file.
  - Repeat all the tracks on the disc or the folder.
  - Turn off the repeat mode.
  - Repeat the tracks randomly.

---

## Video options

While watching video, select options such as subtitles, audio language, time search, and picture settings. Depending on the video source, some options are not available.

- 1 Press **≡**.  
↳ The video options menu is displayed.
- 2 Press the **Navigation buttons** and **OK** to select and change:
  - **[Info]**: Display information about what is playing.
  - **[Audio language]**: Select audio language for video.
  - **[Subtitle language]**: Select subtitle language for video.
  - **[Subtitle shift]**: Change the subtitle position on the screen.
  - **[Character set]**: Select a character set that supports the DivX subtitle.
  - **[Time search]**: Skip to a specific part of the video by entering the time of the scene.
  - **[2nd audio language]**: Select the second audio language for Blu-ray video.
  - **[2nd subtitle language]**: Select the second subtitle language for Blu-ray video.
  - **[Titles]**: Select a specific title.
  - **[Chapters]**: Select a specific chapter.
  - **[Angle list]**: Select a different camera angle.
  - **[Menus]**: Display the disc menu.

- **[PIP selection]**: Display Picture-in-Picture window when playing a Blu-ray disc that supports the Bonus View.
- **[Zoom]**: Zoom into a video scene or picture. Press the **Navigation buttons** (left/right) to select a zoom factor.
- **[Repeat]**: Repeat a chapter or title.
- **[Repeat A-B]**: Mark two points within a chapter or track to repeat play, or turn off the repeat mode.
- **[Picture settings]**: Select a predefined color setting.

---

## Picture options

While viewing a picture, zoom into the picture, rotate it, add animation to a slideshow, and change the picture settings.

- 1 Press **≡**.  
↳ The picture options menu appears.
- 2 Press the **Navigation buttons** and **OK** to select and change the following settings:
  - **[Info]**: Display picture information.
  - **[Rotate +90]**: Rotate the picture 90 degree clockwise.
  - **[Rotate -90]**: Rotate the picture 90 degree counter-clockwise.
  - **[Zoom]**: Zoom into a video scene or picture. Press the **Navigation buttons** (left/right) to select a zoom factor.
  - **[Duration per slide]**: Select the display speed for each picture in a slide show.
  - **[Slide animation]**: Select animation for the slide show.
  - **[Picture settings]**: Select a predefined color setting.
  - **[Repeat]**: Repeat a selected folder.

---

## Musical slideshow

If the picture and audio files are from the same disc or USB storage device, you can create a musical slideshow.

- 1 Select an audio track, and then press **OK**.
- 2 Press **↵**, and go to the picture folder.

- 3 Select a picture, and then press ► (Play) to start the slideshow.
- 4 Press ■ to stop slideshow.
- 5 Press ■ again to stop music.

#### Note

- Make sure that the picture and audio formats are supported by your home theater (see 'File formats' on page 29).

## Radio







Listen to FM radio on your home theater, and store up to 40 radio stations.

#### Note

- AM and digital radio are not supported.
- If no stereo signal is detected, you are prompted to install the radio stations again.

- 1 Connect the FM antenna to the **FM ANTENNA** on your home theater:
  - For the best reception, place the antenna away from your TV or other sources of radiation.
- 2 Press **SOURCE** repeatedly to switch to radio source.
  - ↳ If you have already installed the radio stations, the last channel that you listened to is played.
  - ↳ If you have not installed any radio stations, the message **AUTO INSTALL...PRESS PLAY** appears on the display panel. Press ► (Play) to install radio stations.
- 3 Use the remote control to listen or to change radio stations.

## Play buttons

Button	Action
	Select a preset radio station.
or	
<b>Alphanumeric buttons</b>	
<b>Navigation buttons</b>	Left/Right: Search for a radio station. Up/Down: Fine tune a radio frequency.
	Press to stop the installation of radio stations.
	Press and hold to erase the preset radio station.
	Manual: 1) Press  2) Press  to select your preset. 3) Press  again to store the radio station. Automatic: Press and hold for three seconds to reinstall the radio stations.
<b>SUBTITLE / AUDIO</b>	Toggle between the stereo and mono sounds.

## Tuning grid

In some countries, you can toggle the FM tuning grid between 50 kHz and 100 kHz.

- 1 Press **SOURCE** repeatedly to switch to radio source.
- 2 Press ■.
- 3 Press and hold ► (Play) to toggle between 50 kHz or 100 kHz.

---

## External audio device

Connect an external audio device to play audio files.

### What you need

- An external audio device with 3.5mm jack.
- A 3.5mm stereo audio cable.

- 1 Using the 3.5mm stereo audio cable, connect the external audio device to **AUDIO IN** the connector on your home theater.
- 2 Press **SOURCE** repeatedly until **AUDIO IN** appears on the display panel.
- 3 Press the buttons on the external audio device to select and play audio files.

---

## Browse PC through DLNA

Access and play the pictures, audio and video files from a computer or media server on the home network through your home theater.

### Before you start

- Install a DLNA-compliant media server application on your device. Make sure that you download an application that works best for you. For example,
  - Windows Media Player 11 or higher for PC
  - Twonky Media Server for Mac or PC
- Enable media sharing of files. For ease of use, we have included the steps for the following applications:
  - Windows Media Player 11 (see 'Microsoft Windows Media Player 11' on page 20)
  - Windows Media Player 12 (see 'Microsoft Windows Media Player 12' on page 21)
  - Twonky Media for Mac (see 'Macintosh OS X Twonky Media (v4.4.2)' on page 21)

 **Note**

- For additional help on these applications or other media servers, check the user manual of the media server software.

---

## Set up media server software

To enable media sharing, set up the media server software.

### Before you start

- Connect your home theater to a home network. For better video quality, use wired connection whenever possible.
- Connect the computer and other DLNA-compatible devices to the same home network.
- Make sure that your PC firewall allows you to run Media Player programs (or the firewall's exemption list has the media server software included).
- Switch on your computer and the router.

### Microsoft Windows Media Player 11

- 1 Start Windows Media Player on your PC.
- 2 Click the **Library** tab, and then select **Media Sharing**.
- 3 The first time you select **Media Sharing** on your PC, a pop-up screen appears. Check the **Share my media box** and click **OK**.  
↳ The **Media Sharing** screen is displayed.
- 4 In the **Media Sharing** screen, make sure that you see a device marked as **Unknown Device**.  
↳ If you don't see an unknown device after a minute or so, check that your PC firewall is not blocking the connection.
- 5 Select the unknown device and click **Allow**.  
↳ A green tick appears next to the device.

- 6 By default, Windows Media Player shares from these folders: **My Music**, **My Pictures**, and **My Videos**. If your files are in other folders, select **Library > Add to Library**.
  - ↳ The **Add to Library** screen is displayed.
    - If necessary, select **Advanced options** to display a list of monitored folders.
- 7 Select **My folders and those of others I can access**, and then click **Add**.
- 8 Follow the onscreen instructions to add the other folders that contain your media files.

### Microsoft Windows Media Player 12

- 1 Start Windows Media Player on your PC.
- 2 In Windows Media Player, click the **Stream** tab, and then select **Turn on media streaming**.
  - ↳ The **Media streaming options** screen is displayed.
- 3 Click **Turn on media streaming**.
  - ↳ You return to Windows Media Player screen.
- 4 Click the **Stream** tab and select **More streaming options**.
  - ↳ The **Media streaming options** screen is displayed.
- 5 Make sure that you see a media program in the **Local network** screen.
  - ↳ If you don't see a media program, check that your PC firewall is not blocking the connection.
- 6 Select the media program and click **Allowed**.
  - ↳ A green arrow appears next to the media program.
- 7 By default, Windows Media Player shares from these folders: **My Music**, **My Pictures**, and **My Videos**. If your files are in other folders, click the **Organize** tab and select **Manage libraries > Music**.
  - ↳ The **Music Library Locations** screen is displayed.

- 8 Follow the onscreen instructions to add the other folders that contain your media files.

### Macintosh OS X Twonky Media (v4.4.2)

- 1 Visit [www.twonkymedia.com](http://www.twonkymedia.com) to purchase the software, or download a free 30-day trial to your Macintosh.
- 2 Start Twonky Media on the Macintosh.
- 3 In the Twonky Media Server screen, select **Basic Setup** and **First Steps**.
  - ↳ The **First steps** screen is displayed.
- 4 Type a name for your media server, and then click **Save changes**.
- 5 Back in the Twonky Media screen, select **Basic Setup** and **Sharing**.
  - ↳ The **Sharing** screen is displayed.
- 6 Browse and select folders to share, and then select **Save Changes**.
  - ↳ Your Macintosh rescans the folders automatically so that they are ready to share.

---

### Play files from your PC

#### Note

- Before you play multimedia content from the computer, make sure that the home theater is connected to the home network, and the media server software is properly set up.

- 1 Press **⬆** (**Home**).
- 2 Select **[Browse PC]**, and then press **OK**.
  - ↳ A content browser is displayed.
- 3 Select a device on the network.
  - ↳ The folders in the selected device are displayed. Depending on the media server, the folder names may vary.
    - If you cannot see the folders, check that you have enabled media sharing on the selected device so that the content is available for sharing.

- 4 Select a file, and then press **OK**.
  - Some media files may not play due to compatibility issues. Check the file formats supported by your home theater.
- 5 Press the play buttons to control play (see 'Play buttons' on page 14).

---

## Browse Smart TV

Use Smart TV to access variety of internet applications and specially adapted internet websites.

For interactive discussions on Smart TV services, visit the Smart TV forum at [www.supportforum.philips.com](http://www.supportforum.philips.com)

### Note

- Koninklijke Philips N.V. bears no responsibility for content provided by Smart TV service providers.

- 1 Connect your home theater to a home network with high-speed Internet access (see 'Connect and set up a home network' on page 11).
- 2 Press **⬆️ (Home)**.
- 3 Select **[Smart TV]**, and then press **OK**.
- 4 Follow the onscreen instructions to confirm the onscreen message.
  - ↳ The Smart TV home page is displayed.
- 5 Use the remote control to select applications and enter text (for example, web URL, passwords, etc).

---

## Navigate Smart TV

Button	Action
<b>Navigation buttons</b>	Select an application or navigate.
<b>OK</b>	Confirm an entry or selection.

Button	Action
<b>↶</b>	Return to the previous page. Delete a character in any text entry box.
<b>Alphanumeric buttons</b>	Enter characters in the text entry box.
<b>⬆️ (Home)</b>	Exit Smart TV portal and return to home menu.

---

## Clear browsing history

Clear the browsing history to remove passwords, cookies, and browsing data from your home theater.

- 1 Press **⬆️ (Home)**.
- 2 Select **[Setup]**, and then press **OK**.
- 3 Select **[Network] > [Clear Smart TV memory]**.
- 4 Press **OK** to confirm.

---

## Rent online video

**The function is only available in Smart TV service that has the VOD feature.**

Rent videos from online stores, through your home theater. You can watch them right away or later.

Many online video stores offer a huge choice of video, with different rental prices, periods, and conditions. For some stores, you must create an account before you can rent.

### What you need

- a USB storage device, with at least 8 GB of memory

- 1 Connect your home theater to a home network with high-speed Internet access (see 'Connect and set up a home network' on page 11).
- 2 Insert a blank USB storage device into the **⚡ (USB)** connector at the front of your home theater, and follow the onscreen instructions to format the USB device.



- After formatting, leave the USB storage device in the  (USB) connector.
- After formatting, the USB storage device will no longer be compatible with computers or cameras, unless formatted again using Linux operating system.

- 3 Press  (**Home**).
- 4 Select **[Smart TV]**, and then press **OK**.  
↳ The online services available in your country are displayed.
- 5 Select a video store, and then press **OK**.
- 6 Follow the onscreen instructions to rent or watch a video. If prompted, enter the necessary information to register or log in to the store's account.  
↳ The video is downloaded to your USB storage device. You can watch it only on your home theater.
- 7 Press the playback buttons to control play (see 'Play buttons' on page 14).
  - If you cannot play a video, check the file format to make sure that it is supported by your home theater (see 'File formats' on page 29).

---

## Choose sound

This section helps you choose the ideal sound for your video or music.

- 1 Press **⏏**.
- 2 Press the **Navigation buttons** (left/right) to access the sound options on the display.

Sound options	Description
<b>[Surround]</b>	Select surround sound or stereo sound.
<b>[Sound]</b>	Select a sound mode.
<b>[Audio sync]</b>	Delay the audio to match the video.

Sound options	Description
<b>[Auto volume]</b>	Reduce sudden changes in volume, for example, during TV commercials.

- 3 Select an option, and then press **OK**.
- 4 Press  to exit.
  - If you do not press a button within a minute, the menu exits automatically.

---

## Surround sound mode

Experience an immersive audio experience with surround sound modes.

- 1 Press **⏏**.
- 2 Select **[Surround]**, and then press **OK**.
- 3 Press the **Navigation buttons** (up/down) to select a setting from your display:
  - **[Auto]**: Surround sound based on the audio stream.
  - **[Multi-channel]**: Traditional 5.1 channel for a more relaxing cinematic experience.
  - **[Stereo]**: Two-channel stereo sound. Ideal for listening to music.
- 4 Press **OK** to confirm.

---

## Sound mode

Select predefined sound modes to suit your video or music.

- 1 Make sure that audio post processing is enabled at the speakers (see 'Speaker settings' on page 26).
- 2 Press **⏏**.
- 3 Select **[Sound]**, and then press **OK**.
- 4 Press the **Navigation buttons** (up/down) to select a setting on the display:
  - **[Auto]**: Automatically select a sound setting based on the sound stream.
  - **[Balanced]**: Experience the original sound of your movies and music, without added sound effects.

- **[Powerful]**: Enjoy thrilling arcade sounds, ideal for action-packed videos and loud parties.
- **[Bright]**: Spice up your dull movies and music with added sound effects.
- **[Clear]**: Hear every detail in your music and clear voices in your movies.
- **[Warm]**: Experience spoken words and music vocals in comfort.
- **[Personal]**: Personalize the sound based on your preferences.

5 Press **OK** to confirm.

---

## Equalizer

Change the high frequency (treble), mid frequency (mid), and low frequency (bass) settings of the home theater.

- 1 Press **≡**.
- 2 Select **[Sound]** > **[Personal]**, and then press **Navigation buttons** (right).
- 3 Press the **Navigation buttons** (up/down) to change bass, mid or treble frequency.
- 4 Press **OK** to confirm.

---

## Auto volume

Turn on auto volume to reduce sudden changes in volume, for example, during TV commercials.

- 1 Press **≡**.
- 2 Select **[Auto volume]**, and then press **OK**.
- 3 Press the **Navigation buttons** (up/down) to select **[On]** or **[Off]**.
- 4 Press **OK** to confirm.

# 5 Change settings

The home theater settings are already configured for optimal performance. Unless you have a reason to change a setting, we recommend that you keep the default setting.

### Note

- You cannot change a setting that is grayed out.
- To return to the previous menu, press **↶**. To exit the menu, press **⬆** (**Home**).

---

## Language settings

- 1 Press **⬆** (**Home**).
- 2 Select **[Setup]**, and then press **OK**.
- 3 Select **[Preference]**, and then press **OK**.
- 4 Press the **Navigation buttons** and **OK** to select and change:
  - **[Menu language]**: Select a display language for menu.
  - **[Audio]**: Select an audio language for discs.
  - **[Subtitle]**: Select a subtitle language for discs.
  - **[Disc menu]**: Select a menu language for discs.

### Note

- If your preferred disc language is not available, select **[Others]** from the list, and enter the 4-digit language code found at the end of this user manual (see 'Language code' on page 36).
- If you select a language that is not available on a disc, the home theater uses the default language of the disc.

---

## Picture and video settings

- 1 Press **▲** (Home).
- 2 Select **[Setup]**, and then press **OK**.
- 3 Select **[Video]**, and then press **OK**.
- 4 Press the **Navigation buttons** and **OK** to select and change:
  - **[TV display]**: Select a picture format to fit the TV screen.
  - **[HDMI video]**: Select the resolution of video signal that is output from **HDMI OUT (ARC)** on your home theater. To enjoy the selected resolution, make sure that your TV supports the selected resolution.
  - **[HDMI Deep Color]**: Recreate the natural world on your TV screen by displaying vivid images using billion colors. Your home theater must be connected to a Deep Color enabled TV through an HDMI cable.
  - **[Picture settings]**: Select pre defined color settings for the video display.
  - **[Watch 3D video]**: Set HDMI video to support 3D or 2D video.



### Note

- If you change a setting, make sure that the TV supports the new setting.

---

## Audio settings

- 1 Press **▲** (Home).
- 2 Select **[Setup]**, and then press **OK**.
- 3 Select **[Audio]**, and then press **OK**.
- 4 Press the **Navigation buttons** and **OK** to select and change:
  - **[Night mode]**: For quiet listening, decrease the volume of loud sounds on your home theater. Night mode is only available in DVDs and Blu-ray discs with Dolby Digital, Dolby Digital Plus, and Dolby True HD soundtracks.

- **[HDMI audio]**: Set the HDMI audio output from your TV.
- **[Speaker setup]**: Set up speakers for best surround sound experience.
- **[Default sound settings]**: Restore the equalizer settings of all the sound modes to the default values.

---

## Parental control settings

- 1 Press **▲** (Home).
- 2 Select **[Setup]**, and then press **OK**.
- 3 Select **[Preference]**, and then press **OK**.
- 4 Press the **Navigation buttons** and **OK** to select and change:
  - **[Change password]**: Set or change your password for parental control access. If you do not have a password or have forgotten your password, enter **0000**.
  - **[Parental control]**: Restrict access to discs that are recorded with age ratings. To play all discs, irrespective of the ratings, select **8** or **[Off]**.

---

## Display settings

- 1 Press **▲** (Home).
- 2 Select **[Setup]**, and then press **OK**.
- 3 Select **[Preference]**, and then press **OK**.
- 4 Press the **Navigation buttons** and **OK** to select and change:
  - **[Auto subtitle shift]**: Enable or disable automatic repositioning of subtitles on TVs that support this feature.
  - **[Display panel]**: Set the brightness of the home theater front panel display.
  - **[VCD PBC]**: Enable or disable the content menu navigation of VCD and SVCD discs with Play Back Control feature.

---

## Energy saving settings

- 1 Press **▲** (Home).
- 2 Select **[Setup]**, and then press **OK**.
- 3 Select **[Preference]**, and then press **OK**.
- 4 Press the **Navigation buttons** and **OK** to select and change:
  - **[Screen saver]**: Switch the home theater to screen saver mode after 10 minutes of inactivity.
  - **[Auto standby]**: Switch the home theater to standby after 18 minutes of inactivity. This timer works only when a disc or USB play is paused or stopped.
  - **[Sleep timer]**: Set the duration of the sleep timer so that the home theater is switched to standby after the specified period.

---

## Speaker settings

- 1 Press **▲** (Home).
- 2 Select **[Setup]**, and then press **OK**.
- 3 Select **[Advanced]**, and then press **OK**.
- 4 Press the **Navigation buttons** and **OK** to select and change:
  - **[Enhanced audio]**: Select **[On]** to enable audio post processing at the speaker and enable karaoke settings (if your product supports Karaoke). To play the original audio of the disc, select **[Off]**.



### Tip

- Enable audio post processing before you select a predefined sound mode (see 'Sound mode' on page 23).

---

## Restore default settings

- 1 Press **▲** (Home).
- 2 Select **[Setup]**, and then press **OK**.
- 3 Select **[Advanced]** > **[Restore default settings]**, and then press **OK**.
- 4 Select **[OK]**, and then press **OK** to confirm.
  - ↳ Your home theater is reset to its default settings except for some settings such as parental control and DivX/VOD registration code.

# 6 Update software

Philips continually tries to improve its products. To get the best features and support, update your home theater with the latest software.

Compare the version of your current software with the latest version on [www.philips.com/support](http://www.philips.com/support). If the current version is lower than the latest version available on the Philips support website, upgrade your home theater with the latest software.

## Caution

- Do not install a lower version of software than the current version installed on your product. Philips is not liable for problems caused due to software downgrade.

---

## Check software version

Check the version of the current software installed on your home theater:

- 1 Press **⬆** (**Home**).
- 2 Select **[Setup]**, and then press **OK**.
- 3 Select **[Advanced]** > **[Version information]**.  
↳ The software version is displayed.

---

## Update software through USB

### What you need

- A USB flash drive that is FAT or NTFS-formatted, with at least 256MB of memory. Do not use a USB hard drive.
- A computer with Internet access.
- An archive utility that supports the ZIP file format.

---

## Step 1: Download the latest software

- 1 Connect a USB flash drive to your computer.
- 2 In your web browser, go to [www.philips.com/support](http://www.philips.com/support).
- 3 At the Philips Support website, find your product and locate the **Software and drivers**.  
↳ The software update is available as a zip file.
- 4 Save the zip file in the root directory of your USB flash drive.
- 5 Use the archive utility to extract the software update file in the root directory.  
↳ The files are extracted under the **UPG** folder of your USB flash drive.
- 6 Disconnect the USB flash drive from your computer.

---

## Step 2: Update the software

### Caution

- Do not switch off the home theater or remove the USB flash drive during the update.

- 1 Connect the USB flash drive containing the downloaded file to your home theater.
  - Make sure that the disc compartment is closed and no disc inside.
- 2 Press **⬆** (**Home**).
- 3 Select **[Setup]**, and then press **OK**.
- 4 Select **[Advanced]** > **[Software update]** > **[USB]**.
- 5 Follow the onscreen instructions to confirm the update.  
↳ Update process takes about 5 minutes to complete.

---

## Update software through the Internet

- 1 Connect your home theater to a home network with a high-speed Internet access (see 'Connect and set up a home network' on page 11).
- 2 Press **▲** (Home).
- 3 Select **[Setup]**, and then press **OK**.
- 4 Select **[Advanced]** > **[Software update]** > **[Network]**.
  - ↳ If an upgrade media is detected, you are prompted to start or cancel the update.
  - ↳ Downloading of the upgrading file may take long, depending on your home network condition.
- 5 Follow the onscreen instructions to confirm the update.
  - ↳ Update process takes about 5 minutes to complete.
  - ↳ Once complete, the home theater automatically switches off and restarts. If it does not, disconnect the power cord for a few seconds and then reconnect it.

## 7 Product specifications













### Note

- Specifications and design are subject to change without notice.

---

### Region codes

The type plate on the back or bottom of the home theater shows which regions it supports.

Country	DVD	BD
Europe, United Kingdom		
Asia Pacific, Taiwan, Korea		
Latin America		
Australia, New Zealand		
Russia, India		
China		

---

### Media formats

- AVCHD, BD, BD-R/ BD-RE, BD-Video, DVD-Video, DVD+R/+RW, DVD-R/-RW, DVD+R/-R DL, CD-R/CD-RW, Audio CD, Video CD/SVCD, Picture files, MP3 media, WMA media, DivX Plus HD media, USB storage device

---

## File formats

- Audio:
  - .aac, .mka, .mp3, .wma, .wav, .m4a, .flac, .ogg
- Video:
  - .avi, .divx, .mp4, .m4v, .ts, .mov, .mkv, .asf, .wmv, .m2ts, .mpg, .mpeg, .3gp
- Picture: .jpg, .jpeg, .gif, .png

---

## Bluetooth

- Bluetooth profiles: A2DP
- Bluetooth version: 2.1 + EDR

---

## Audio formats

Your home theater supports the following audio files.

Extension	Container	Audio codec	Bit rate
.mp3	MP3	MP3	Up to 320 kbps
.wma	ASF	WMA WMA Pro	Up to 192 kbps Up to 768kbps
.aac	AAC	AAC, HE-AAC	Up to 192 kbps
.wav	WAV	PCM	27.648 Mbps
.m4a	MKV	AAC ALAC	192 kbps Up to 192kHz sampling rate
.mka	MKA	PCM AC-3 DTS core MPEG MP3 WMA WMA Pro AAC, HE-AAC	27.648 Mbps 640kbps 1.54 Mbps 912 kbps Up to 320 kbps Up to 192 kbps Up to 768kbps Up to 192 kbps
.flac	FLAC	FLAC	Up to 24 bit per sample
.ogg	OGG	Vorbis	Variable bit rate, maximum block size 4096

---

Extension	Container	Audio codec	Bit rate
		FLAC	Up to 192kHz sampling rate
		OGGPCM	No limitation
		MP3	Upto 320 kbps

---

---

## Video formats

If you have a high definition TV, your home theater allows you to play your video files with:

- Resolution: 1920 × 1080 pixels at
- Frame rate: 6 ~ 30 frames per second.

**.avi files in AVI container (or .ts files in TS container)**

---

Audio codec	Video codec	Bit rate
PCM, AC-3, DTS core, MP3, WMA, DD+	DivX 3.11, DivX 4.x, DivX 5.x, DivX 6.x	10 Mbps max
	MPEG 1, MPEG 2	40 Mbps
	MPEG 4 SP / ASP	38.4 Mbps
	H.264/AVC up to HiP@5.1	25 Mbps
	WMV9	45 Mbps

---

**.divx files in AVI container**

---

Audio codec	Video codec	Bit rate
PCM, AC-3, DTS core, MP3, WMA, DD+	DivX 3.11, DivX 4.x, DivX 5.x, DivX 6.x	10 Mbps max

---

**.mp4 or .m4v files in MP4 container**

---

Audio codec	Video codec	Bit rate
AC-3, MPEG, MP3, AAC, HE-AAC, DD+	MPEG 1, MPEG 2	40 Mbps
	MPEG 4 ASP	38.4 Mbps

---

Audio codec	Video codec	Bit rate
	H.264/AVC up to HiP@5.1	25 Mbps

#### .mov files in MOV container

Audio codec	Video codec	Bit rate
AC-3, MPEG, MP3, AAC, HE-AAC	MPEG 1, MPEG 2	40 Mbps
	MPEG 4 ASP	38.4 Mbps
	H.264/AVC up to HiP@5.1	25 Mbps

#### .mkv files in MKV container

Audio codec	Video codec	Bit rate
PCM, AC-3, DTS core, MPEG, MP3, WMA, AAC, HE-AAC, DD+, FLAC	DivX Plus HD	30 Mbps
	MPEG 1, MPEG 2	40 Mbps
	MPEG 4 ASP	38.4 Mbps
	H.264/AVC up to HiP@5.1	25 Mbps
	WMV9	45 Mbps

#### .m2ts files in MKV container

Audio codec	Video codec	Bit rate
PCM, AC-3, DTS core, MPEG, MP3, WMA, AAC, HE-AAC, DD+	MPEG 1, MPEG 2	40 Mbps
	MPEG 4 ASP	38.4 Mbps
	H.264/AVC up to HiP@5.1	25 Mbps
	WMV9	45 Mbps

#### .asf and .wmv files in ASF container

Audio codec	Video codec	Bit rate
PCM, AC-3, MP3, WMA, DD+	MPEG 4 ASP	38.4 Mbps
	H.264/AVC up to HiP@5.1	25 Mbps
	WMV9	45 Mbps

#### .mpg and .mpeg files in PS container

Audio codec	Video codec	Bit rate
PCM, DTS core, MPEG, MP3	MPEG 1, MPEG 2	40 Mbps

#### .3gp files in 3GP container

Audio codec	Video codec	Bit rate
AAC, HE-AAC	MPEG 4 ASP	38.4 Mbps
	H.264/AVC up to HiP@5.1	25 Mbps max

## Amplifier

- Total output power: 1000W RMS (10% THD)
- Frequency response: 20 Hz-20 kHz /  $\pm 3$  dB
- Signal-to-noise ratio: > 65 dB (CCIR) / (A-weighted)
- Input sensitivity:
  - AUX: 2 V
  - AUDIO IN: 1 V

## Video

- Signal system: PAL / NTSC
- HDMI output: 480i/576i, 480p/576p, 720p, 1080i, 1080p, 1080p24

## Audio

- S/PDIF Digital audio input:
  - Coaxial: IEC 60958-3
  - Optical: TOSLINK



- Sampling frequency:
  - MP3: 32 kHz, 44.1 kHz, 48 kHz
  - WMA: 44.1 kHz, 48 kHz
- Constant bit rate:
  - MP3: 32 kbps - 320 kbps
  - WMA: 48 kbps - 192 kbps

---

## Radio

- Tuning range:
  - Europe/Russia/China:  
FM 87.5-108 MHz (50 kHz)
  - Asia Pacific/Latin America:  
FM 87.5-108 MHz (50/100 kHz)
- Signal-to-noise ratio: FM 50 dB
- Frequency response: FM 180 Hz-12.5 kHz /  $\pm 3$  dB

---

## USB

- Compatibility: Hi-Speed USB (2.0)
- Class support: USB Mass Storage Class (MSC)
- File system: FAT16, FAT32, NTFS
- USB port: 5V  $\equiv$ , 1A

---

## Main unit

- Power supply:
  - Europe/China: 220-240V~, 50 Hz
  - Latin America/Asia Pacific:  
110-127/220-240V~, 50-60 Hz
  - Russia/India: 220-240V~, 50 Hz
- Power consumption: 160 W
- Standby power consumption:  $\leq 0.5$  W
- Dimensions (W x H x D):  
435 x 58 x 291 mm
- Weight: 2.66 kg
- Operating temperature and humidity:  
0°C to 45°C, 5% to 90% humidity for all climates
- Storage temperature and humidity:  
-40°C to 70°C, 5% to 95%

---

## Subwoofer

- Output power: 166 W RMS (10%THD)
- Impedance: 3 ohm
- Speaker drivers: 165 mm (6.5") woofer
- Dimensions (WxHxD):  
237 x 293 x 308 mm
- Weight: 3.8 kg
- Cable length: 3 m

---

## Speakers

### Center speaker:

- Output power: 166 W RMS (10%THD)
- Speaker impedance: 3 ohm
- Speaker drivers: 2 x 78 mm (3") full range
- Dimensions (WxHxD):  
314 x 103 x 94 mm
- Weight: 0.97 kg
- Cable length: 2 m

### Front/Rear speaker:

- Output power:  
4 x 166 W RMS (10%THD)
- Speaker impedance: 3 ohm
- Speaker drivers:
  - **HTB3520**: 78 mm (3") full range (front/rear)
  - **HTB3550**:  
2 x 78 mm (3") full range (front);  
78 mm (3") full range (rear)
  - **HTB3580**: 2 x 78 mm (3") full range (front/rear)
- Dimensions (WxHxD):
  - **HTB3520**: 100 x 193 x 125 mm (front/rear)
  - **HTB3550**:  
250 x 1140 x 250 mm (front);  
100 x 193 x 125 mm (rear)
  - **HTB3580**: 250 x 1140 x 250 mm (front/rear)
- Weight:
  - **HTB3520**: 0.65 kg/each (front/rear)
  - **HTB3550**: 3.86 kg/each (front);  
0.65 kg/each (rear)
  - **HTB3580**: 3.86 kg/each (front/rear)
- Cable length (front): 3 m
- Cable length (rear): 10 m

---

## Remote control batteries

- 2 x AAA-R03-1.5 V

---

## Laser

- Laser Type (Diode): InGaN/AlGaIn (BD), AlGaInP (DVD/CD)
- Wave length: 405 +7 nm/-7 nm (BD), 655 +10 nm/-10 nm (DVD), 790 +10 nm/-20 nm (CD)
- Output power (Max. ratings): 20 mW (BD), 6 mW (DVD), 7 mW (CD)

---

## Standby information

- When the product remains inactive for 18 minutes, it automatically switches to standby or networked standby.
- The power consumption in standby or networked standby is less than 0.5W.
- To deactivate Bluetooth connection, press and hold the Bluetooth button on the remote control.
- To activate Bluetooth connection, enable Bluetooth connection on your Bluetooth device, or enable Bluetooth connection via the NFC tag (if available).

# 8 Troubleshooting



### Warning

- Risk of electric shock. Never remove the casing of the product.

To keep the warranty valid, never try to repair the product yourself.

If you have problems using this product, check the following points before you request service. If you still have a problem, get support at [www.philips.com/support](http://www.philips.com/support).

---

## Main unit

### The buttons on the home theater do not work.

- Disconnect the home theater from the power supply for a few minutes, then reconnect.
- Make sure that the touch buttons surface is not in contact with any conductive material, like water drop, metal, etc.

---

## Picture

### No picture.

- Make sure that the TV is switched to the correct source for the home theater.

### No picture on a TV connected through HDMI.

- Make sure that you use a High Speed HDMI cable to connect the home theater and TV. Some Standard HDMI cables do not display properly for some images, 3D video, or Deep Color.
- Make sure that the HDMI cable is not faulty. If it is faulty, replace it with a new cable.
- Press  (Home) and then **731** on the remote control to restore the default picture resolution.
- Change the HDMI video setting, or wait for 10 seconds for auto recovery (see 'Picture and video settings' on page 25).

### Disc does not play high-definition video.

- Make sure that the disc contains high-definition video.
- Make sure that the TV supports high-definition video.
- Use an HDMI cable to connect to the TV.

---

## Sound

### No sound from home theater speakers.

- Connect the audio cable from your home theater to your TV or other devices. However, you do not need a separate audio connection when the home theater and TV are connected through an **HDMI ARC** connection.
- Set up the audio for the connected device (see 'Set up the audio' on page 11).
- Reset your home theater to its factory settings (see 'Restore default settings' on page 26), and then switch it off and switch on again.
- On your home theater, press **SOURCE** repeatedly to select the correct audio input.

### Distorted sound or echo.

- If you play audio from the TV through the home theater, make sure that the TV is muted.

### Audio and video are not synchronized.

- 1) Press **III**.
- 2) Press the **Navigation buttons** (left/right) to select **[Audio sync]**, and then press **OK**.
- 3) Press the **Navigation buttons** (up/down) to synchronize the audio with the video.

---

## Play

### Cannot play a disc.

- Clean the disc.
- Make sure that the home theater supports the type of disc (see 'Media formats' on page 28).

- Make sure that the home theater supports the region code of the disc (see 'Region codes' on page 28).
- If the disc is a DVD±RW or DVD±R disc, make sure that it is finalized.

### Cannot play a DivX file.

- Make sure that the DivX file is encoded according to the 'Home Theater Profile' with the DivX encoder.
- Make sure that the DivX file is complete.

### DivX do not display correctly.

- Make sure that the subtitle file name is the same as the movie file name (see 'Subtitles' on page 16).
- Select the correct character set:
  - 1) Press **III**.
  - 2) Select **[Character set]**.
  - 3) Select the supported character set.
  - 4) Press **OK**.

### Cannot read the contents of a USB storage device.

- Make sure that the format of the USB storage device is compatible with the home theater.
- Make sure that the file system on the USB storage device is supported by the home theater.

### 'No entry' or 'x' sign appears on the TV.

- The operation is not possible.

### EasyLink does not work.

- Make sure that the home theater is connected to a Philips brand EasyLink TV, and the EasyLink option is turned on (see 'Set up EasyLink (HDMI-CEC control)' on page 10).
- For TVs from different manufacturers, the HDMI CEC could be called differently. Check the TV user manual on how to enable it.

### When you switch on the TV, the home theater automatically switches on.

- This behavior is normal when you are using Philips EasyLink (HDMI-CEC). To make the home theater work independently, switch off EasyLink.

### Cannot access BD-Live features.

- Make sure that the home theater is connected to the network (see 'Connect and set up a home network' on page 11).
- Make sure that the network is set up (see 'Connect and set up a home network' on page 11).
- Make sure that the Blu-ray disc supports BD-Live features.
- Clear memory storage (see 'BD-Live on Blu-ray' on page 15).

### My 3D video played in 2D mode.

- Make sure that your home theater is connected to a 3D TV through an HDMI cable.
- Make sure that the disc is a Blu-ray 3D disc, and the Blu-ray 3D video option is on (see 'BD-Live on Blu-ray' on page 15).

### TV screen is black when you play a Blu-ray 3D video or a DivX copy protected video.

- Make sure that the home theater is connected to the TV through an HDMI cable.
- Switch to the correct HDMI source on the TV.

### Cannot download video from an online video store.

- Make sure that your home theater is connected to the TV through an HDMI cable.
- Make sure that the USB storage device is formatted, has enough memory to download the video.
- Make sure that you have paid for the video, and it is within the rental period.
- Make sure that the network connection is good (see 'Connect and set up a home network' on page 11).
- Visit the video store website for more information.

---

## Bluetooth

### A device cannot connect with the home theater.

- The device does not support the compatible profiles required for the home theater.
- You have not enabled the Bluetooth function of the device. See the user manual of the device on how to enable the function.
- The device is not correctly connected. Connect the device correctly. (see 'Play audio through Bluetooth' on page 15)
- The home theater is already connected with another Bluetooth device. Disconnect the connected device, then try again.

### Quality of audio play from a connected Bluetooth device is poor.

- The Bluetooth reception is poor: Move the device closer to the home theater, or remove any obstacle between the device and the home theater.

### The connected Bluetooth device connects and disconnects constantly.

- The Bluetooth reception is poor: Move the device closer to the home theater, or remove any obstacle between the device and the home theater.
- Turn off Wi-Fi function on the Bluetooth device to avoid interference.
- For some Bluetooth, the Bluetooth connection can be deactivated automatically to save power: This does not indicate any malfunction of the home theater.

---

## NFC

### A device cannot connect with the home theater via NFC.

- Make sure that the device is supported by NFC.
- Make sure that NFC is enabled on the device (see the device's user manual for details).
- For pairing, tap the NFC device on the NFC tag of the home theater.

# 9 Notice

This section contains the legal and trademark notices.

---

## Copyright



**Be responsible  
Respect copyrights**

This item incorporates copy protection technology that is protected by U.S. patents and other intellectual property rights of Rovi Corporation. Reverse engineering and disassembly are prohibited.

This product incorporates proprietary technology under license from Verance Corporation and is protected by U.S. Patent 7,369,677 and other U.S. and worldwide patents issued and pending as well as copyright and trade secret protection for certain aspects of such technology. Cinavia is a trademark of Verance Corporation. Copyright 2004-2013 Verance Corporation. All rights reserved by Verance. Reverse engineering or disassembly is prohibited.

### Cinavia notice

This product uses Cinavia technology to limit the use of unauthorized copies of some commercially-produced film and videos and their soundtracks. When a prohibited use of an unauthorized copy is detected, a message will be displayed and playback or copying will be interrupted.

More information about Cinavia technology is provided at the Cinavia Online Consumer Information Center at <http://www.cinavia.com>. To request additional information about Cinavia by mail, send a postcard with your mailing address to: Cinavia Consumer Information Center, P.O. Box 86851, San Diego, CA, 92138, USA.

---

## Open source software

Philips Electronics Singapore hereby offers to deliver; upon request, a copy of the complete corresponding source code for the copyrighted open source software packages used in this product for which such delivery is requested by the respective licenses. This offer is valid up to three years after product purchase to anyone in receipt of this information. To obtain source code, please send your request in English with product type to [open.source@philips.com](mailto:open.source@philips.com). If you prefer not to use email or if you do not receive confirmation receipt within 2 weeks after mailing to this email address, please write in English to "Open Source Team, Philips Intellectual Property & Standards, P.O. Box 220, 5600 AE Eindhoven, The Netherlands". If you do not receive timely confirmation of your letter, please email to the email address above. The texts of the licenses and acknowledgements for open source software used in this product are included on a separate leaflet.

---

## Compliance

# CE 0560

This product complies with the radio interference requirements of the European Community.

Hereby, Philips Consumer Lifestyle, declares that this product is in compliance with the essential requirements and other relevant provisions of Directive 1999/5/EC. You can find the Declaration of Conformity on [www.p4c.philips.com](http://www.p4c.philips.com).

# 10 Language code

Abkhazian	6566	Inupiaq	7375	Pushto	8083
Afar	6565	Irish	7165	Russian	8285
Afrikaans	6570	Íslenska	7383	Quechua	8185
Amharic	6577	Italiano	7384	Raeto-Romance	8277
Arabic	6582	Ivrit	7269	Romanian	8279
Armenian	7289	Japanese	7465	Rundi	8278
Assamese	6583	Javanese	7486	Samoan	8377
Avestan	6569	Kalaallisut	7576	Sango	8371
Aymara	6589	Kannada	7578	Sanskrit	8365
Azerhijani	6590	Kashmiri	7583	Sardinian	8367
Bahasa Melayu	7783	Kazakh	7575	Serbian	8382
Bashkir	6665	Kernewek	7587	Shona	8378
Belarusian	6669	Khmer	7577	Shqip	8381
Bengali	6678	Kinyarwanda	8287	Sindhi	8368
Bihari	6672	Kirghiz	7589	Sinhalese	8373
Bislama	6673	Komi	7586	Slovensky	8373
Bokmål, Norwegian	7866	Korean	7579	Slovenian	8376
Bosanski	6683	Kuanyama; Kwanyama	7574	Somali	8379
Brezhoneg	6682	Kurdish	7585	Sotho; Southern	8384
Bulgarian	6671	Lao	7679	South Ndebele	7882
Burmese	7789	Latina	7665	Sundanese	8385
Castellano, Español	6983	Latvian	7686	Suomi	7073
Catalán	6765	Letzeburgesch;	7666	Swahili	8387
Chamorro	6772	Limburgan; Limburger	7673	Swati	8383
Chechen	6769	Lingala	7678	Svenska	8386
Chewa; Chichewa; Nyanja	7889	Lithuanian	7684	Tagalog	8476
中文	9072	Luxembourgish;	7666	Tahitian	8489
Chuang; Zhuang	9065	Macedonian	7775	Tajik	8471
Church Slavic; Slavonic	6785	Malagasy	7771	Tamil	8465
Chuvash	6786	Magyar	7285	Tatar	8484
Corsican	6779	Malayalam	7776	Telugu	8469
Česky	6783	Maltese	7784	Thai	8472
Dansk	6865	Manx	7186	Tibetan	6679
Deutsch	6869	Maori	7773	Tigrinya	8473
Dzongkha	6890	Marathi	7782	Tonga (Tonga Islands)	8479
English	6978	Marshallese	7772	Tsonga	8483
Esperanto	6979	Moldavian	7779	Tswana	8478
Estonian	6984	Mongolian	7778	Türkçe	8482
Euskara	6985	Nauru	7865	Türkmen	8475
Ελληνικά	6976	Navaho; Navajo	7886	Twí	8487
Faroese	7079	Ndebele, North	7868	Uighur	8571
Français	7082	Ndebele, South	7882	Ukrainian	8575
Frysk	7089	Ndonga	7871	Urdu	8582
Fijian	7074	Nederlands	7876	Uzbek	8590
Gaelic; Scottish Gaelic	7168	Nepali	7869	Vietnamese	8673
Gallegan	7176	Norsk	7879	Volapuk	8679
Georgian	7565	Northern Sami	8369	Walloon	8765
Gikuyu; Kikuyu	7573	North Ndebele	7868	Welsh	6789
Guarani	7178	Norwegian Nynorsk;	7878	Wolof	8779
Gujarati	7185	Occitan; Provençal	7967	Xhosa	8872
Hausa	7265	Old Bulgarian; Old Slavonic	6785	Yiddish	8973
Herero	7290	Oriya	7982	Yoruba	8979
Hindi	7273	Oromo	7977	Zulu	9085
Hiri Motu	7279	Ossetian; Ossetic	7983		
Hrwatski	6779	Pali	8073		
Ido	7379	Panjabi	8065		
Interlingua (International)	7365	Persian	7065		
Interlingue	7365	Polski	8076		
Inuktitut	7385	Português	8084		

# 11 Index

---

## 2

2nd audio language	14
2nd subtitle language	14

---

## 3

3D disc in 2D mode	14
3D safety	3
3D video	14

---

## 5

5.1 speakers	7
--------------	---

---

## A

advanced settings	26
amplifier	30
audio connection (HDMI ARC)	8
audio formats	29
audio from other devices	9
audio language	24
audio options	18
audio post processing	26
audio settings	25
auto standby	26
auto subtitle shift	25
auto volume	24

---

## B

batteries	32
BD-Live	15
Bluetooth	15
Blu-ray	13
Bonus View	14
brightness	25

---

## C

change password	25
character set	16

clear BD-Live memory	15
connect to TV	8
connectors	6
control buttons (disc)	14
control buttons (USB)	14

---

## D

data files	16
deep color	25
default settings	26
device name	12
disc language	24
disc menu	24
display panel	25
disposal	3
DivX	16

---

## E

Easylink (HDMI-CEC)	10
eject disc	4
enhanced audio	26
environment	3

---

## F

factory settings	26
file formats	29

---

## H

HDMI ARC	8
HDMI audio	25
HDMI-CEC	10
home menu	13
home network	11

---

## I

internet	11
----------	----

---

## L

language code	36
---------------	----

<hr/>	
<b>M</b>	
main unit	4
manual setup	10
media formats	28
media sharing	20
menu language	24
musical slideshows	18
<hr/>	
<b>N</b>	
network	11
NFC	16
night mode	25
<hr/>	
<b>O</b>	
one-touch play	11
one-touch standby	11
options	17
<hr/>	
<b>P</b>	
parental control	25
PBC (play back control)	25
picture options	18
picture resolution	25
picture settings	25
picture-in-picture	14
play disc	13
play from PC	21
play USB storage device	17
power settings	26
predefined sound mode	23
preference	24
<hr/>	
<b>R</b>	
radio	19
recycling	3
region codes	28
remote control	5
repeat	18
<hr/>	
<b>S</b>	
shuffle	18
sleep timer	26
slide animation	18
software update	27
software version	27
sound	23
speaker position	7
speaker setup	10
speaker specifications	28
subtitle language	24
subtitle position	25
surround sound	23
synchronize picture and sound	14
<hr/>	
<b>T</b>	
troubleshooting (picture)	32
troubleshooting (play)	33
troubleshooting (sound)	33
tuning grid	19
<hr/>	
<b>U</b>	
update software (through Internet)	28
USB storage device	17
<hr/>	
<b>V</b>	
VCD	25
video connection (HDMI ARC)	8
video connection (standard HDMI)	9
video formats	30
video options	18
video settings	25
VOD code (DivX)	17
<hr/>	
<b>W</b>	
watch 3D	14
wired network	12
wireless rear audio	8
wireless speakers	8





“Blu-ray 3D™” and “Blu-ray 3D™” logo are trademarks of Blu-ray Disc Association.



‘DVD Video’ is a trademark of DVD Format/Logo Licensing Corporation.



Oracle and Java are registered trademarks of Oracle and/or its affiliates. Other names may be trademarks of their respective owners.



For DTS patents, see <http://patents.dts.com>. Manufactured under license from DTS Licensing Limited. DTS, DTS-HD, the Symbol, & DTS and the Symbol together are registered trademarks, and DTS-HD Master Audio | Essential is a trademark of DTS, Inc. © DTS, Inc. All Rights Reserved.



Manufactured under license from Dolby Laboratories. Dolby and the double-D symbol are trademarks of Dolby Laboratories.



DivX®, DivX Certified®, DivX Plus® HD and associated logos are trademarks of Rovi Corporation or its subsidiaries and are used under license.

ABOUT DIVX VIDEO: DivX® is a digital video format created by DivX, LLC, a subsidiary of Rovi Corporation. This is an official DivX Certified® device that plays DivX video. Visit [divx.com](http://divx.com) for more information and software tools to convert your files into DivX videos.

ABOUT DIVX VIDEO-ON-DEMAND: This DivX Certified® device must be registered in order to play purchased DivX Video-on-Demand (VOD) movies. To obtain your registration code, locate the DivX VOD section in your device setup menu. Go to [vod.divx.com](http://vod.divx.com) for more information on how to complete your registration.

DivX Certified® to play DivX® and DivX Plus® HD (H.264/MKV) video up to 1080p HD including premium content.



The terms HDMI and HDMI High-Definition Multimedia Interface, and the HDMI Logo are trademarks or registered trademarks of HDMI Licensing LLC in the United States and other countries.



The Bluetooth® word mark and logos are registered trademarks owned by Bluetooth SIG, Inc. and any use of such marks by Philips is under license. Other trademarks and trade names are those of their respective owners.



The N Mark is a trademark of NFC Forum, Inc. in the United States and in other countries.





Specifications are subject to change without notice  
© 2014 Koninklijke Philips N.V. All rights reserved.  
Trademarks are the property of Koninklijke Philips N.V. or their respective owners.

HTB3520G/3550G/3580G\_12\_UM\_V3.0

