



UNINTERRUPTIBLE POWER SUPPLY (UPS)

R90 Online UPS

20kVA Model

USER & INSTALLATION MANUAL

Table of Contents

IMPORTANT SAFETY INSTRUCTIONS:	6
INTRODUCTION	8
PRODUCT DESCRIPTION	8
Main Features	8
SYSTEM CONFIGURATION	9
Unpacking the UPS.....	9
Installation Notes.....	14
External Protective Devices	14
External Battery	14
UPS Output.....	14
Over-Current Protection	14
Power Cables.....	15
Cable Sizes.....	15
Power Cables Connection	16
Battery Connection	18
UPS Multi-Module Installation.....	20
Cabinet Installation	20
Parallel Cable Installation.....	21
Remote Emergency Power Off (EPO) for Parallel Systems.....	22
Requirements for a Parallel System.....	23
OPERATION	23
Operation Modes.....	23
Normal Mode.....	23
Battery Mode (stored energy mode).....	23
Bypass Mode.....	23
ECO Mode	24
Parallel Redundancy Mode (system expansion).....	24

Turn On / Off the UPS	24
Connecting with Utility	24
Cold Start Procedure	25
Inverter Off.....	25
Disconnecting from Utility	25
Computer Access	26
Parallel Setting	29
Communication Port Definitions (RS232, RS485)	33
The Display.....	34
System LCD Display	34
Parameters setting.....	44
Mode setting.....	44
Output voltage setting	45
Frequency setting.....	46
Battery capacity setting	47
Battery quantity setting	48
Bypass voltage upper limit setting	49
Bypass voltage lower limit setting	50
Parallel ID setting	51
Parallel quantity setting	52
Parallel redundancy quantity setting	53
Display Messages	54
Operational Status and Mode(s).....	54
Alarm Information.....	54
Options.....	55
Troubleshooting.....	57
BATTERIES.....	58
REPLACING THE BATTERY	58

SPECIFICATIONS 59
BATTERY RUN TIMES USING EBP32..... 60
SHIPPING LIST 60
OBTAINING SERVICE..... 61
XTREME POWER CONVERSION CORPORATION LIMITED
WARRANTY 62

Thank you for selecting this uninterruptible power supply (UPS). It provides you with protection for connected equipment. **Please read this manual** before installing the R90-20KVA model as it provides important information that should be followed during installation and maintenance of the UPS and batteries, allowing you to correctly set up your system for the maximum safety and performance. Included is information on customer support and service, if it is required. If you experience a problem with the UPS, please refer to the Troubleshooting section in this manual to correct the problem. If the problem is not corrected, please collect information so that the Technical Support personnel can more effectively assist you.

IMPORTANT SAFETY INSTRUCTIONS:

(SAVE THESE INSTRUCTIONS)

CAUTION! (UPS having Internal Batteries): Risk of electrical shock – Hazardous live parts inside this unit are energized from the battery supply even when the input AC power is disconnected.

CAUTION! (No User serviceable Parts): Risk of electrical shock, do not remove cover. No user serviceable parts inside. Refer servicing to qualified service personnel.

CAUTION! (Non-isolated Battery supply): Risk of electric shock, battery circuit is not isolated from AC input, hazardous voltage may exist between battery terminals and ground. Test before touching.

WARNING! (Fuses): To reduce the risk of fire, replace only with the same type and size of fuse.

WARNING! Unit intended for installation in a controlled environment.

CAUTION! Do not dispose of batteries in a fire, the battery may explode.

CAUTION! Do not open or mutilate the battery, released electrolyte is harmful to the skin and eyes.

CAUTION! A battery can present a risk of electric shock and high short circuit current. The following precaution should be observed when working on batteries:

- Remove watches, rings or other metal objects.
- Use tools with insulated handles.

To reduce the risk of electric shock, disconnect the UPS from the main supply before installing a computer interface signal cable. Reconnect the power cord only after signaling interconnections have been made.

Servicing of batteries should be performed or supervised by personnel with knowledge of batteries and the required precautions. Keep unauthorized personnel away from batteries.

These UPS units are extremely heavy. Caution should be taken in moving and positioning equipment.

The instructions contained within this safety manual are deemed important and should be closely followed at all times during installation and follow-up maintenance of the UPS and batteries.



CAUTION

The unit has a dangerous amount of voltage. If the UPS indicator is on, the unit's outlets may have a dangerous amount of voltage even when not plugged into the wall outlet because the battery may continue to supply power.

Care should be taken to undertake installation indoors, free from electrically-conductive particles which are under temperature and humidity control, in order to reduce the risk of electric shock.

It is best to disconnect the device using the power supply cord. Ensure that the equipment is placed in a position near the outlet where easily accessible.

Except for replacing the batteries, all servicing on this equipment must be carried out by qualified service personnel.

Before conducting any maintenance, repair, or shipment, first ensure that everything is turned off completely and disconnected.

For additional safety instructions, please use the Safety Manual as a reference.

Special Symbols

The following symbols used on the UPS warn you of precautions:



RISK OF ELECTRIC SHOCK - Please observe the warning that a risk of electric shock is present



CAUTION: REFER TO OPERATOR'S MANUAL - Refer to the operator's manual for additional information, such as important operating and maintenance instructions.



SAFE GROUNDING TERMINAL - Indicates primary safe ground



Please do not discard of the UPS or the UPS batteries as the UPS may have valve-regulated lead-acid batteries. Please recycle batteries appropriately.

INTRODUCTION

The information provided in this manual covers three-phase 20kVA uninterruptible power systems, its basic functions, operating procedures, options available and emergency situations. It also includes information on how to ship, store, handle, and install the equipment. Only detailed requirements of the UPS units are described herein, and installation must be carried out in accordance with this manual. Electrical installation must also carefully follow local legislation and regulations. Only qualified personnel should conduct these installations as failure to acknowledge electrical hazards could prove to be fatal.

PRODUCT DESCRIPTION

Many different kinds of sensitive electrical equipment can be protected by an Uninterruptible Power Supply (UPS) including computers, workstations, process control systems, telecommunications systems, sales terminals, other critical instrumentation, etc. The purpose of the UPS is to protect these systems from poor quality utility power, complete loss of power, or other associated problems.

Electrical interference exists in many forms, causing problems in AC power, from lightning, power company accidents and radio transmission motors, air conditioners, and vending machines. Protection of sensitive electrical equipment is vital to protect against power outages, low or high voltage conditions, slow voltage fluctuations, frequency variations, differential and common-mode noise, transients, etc.

To prevent power line problems from reaching critical systems causing damage to software, hardware, and equipment malfunctions, the UPS maintains constant voltage, isolating critical load output and cleaning the utility AC power.

Main Features

This is a three phase input / three phase output high-frequency online UPS. The UPS protects against power failures, power sag, power surge, under-voltage, over-voltage, line noise, frequency variations, switching transients, and harmonic distortion which can all cause critical problems to supported sensitive electronic equipment in the market today.

Functions and Features

- 3 phase input/output high-density UPS
- Digital Control
 - The UPS is controlled by Digital Signal Processor (DSP) which increases reliability, performance, self-protection, self-diagnostics, etc.
- Modular Design
- Battery Configuration
 - The battery voltage can be configured based on needs
- Charging Configuration
 - The charging current can be customized to meet site requirements

- Intelligent Charging Method
 - 1st stage = high current constant current charging to restore batteries to 90% capacity
 - 2nd stage = constant current charging to assure batteries remain fully charged
 - 3rd stage = float charge

The 3-stage charging method extends the life of the batteries and guarantees rapid recharging
- LCD Display
 - Both LED and LCD displays allow for ease of use and availability of critical UPS status and operational parameters, including: input/output voltage, frequency and load %, battery %, ambient temperature, etc.
- EPO Function

SYSTEM CONFIGURATION

The UPS device and the internal batteries make up the system. Depending on the site and load requirements of the installation, certain additional options are available for the solution.

Planning a UPS system, the following should be taken into consideration:

- The total demand of the protected system shall dictate the output power rating (VA). Allow a margin for future expansion or calculation inaccuracies from measured power requirements.
- Backup time required will indicate the battery size needed. If the load is less than the UPS nominal power rating, then actual backup time is longer.
- The following options are available:
 - Connectivity Options –SNMP/WEB card
 - Extended Battery Packs - minimum 1 required

See the Specification section of this manual for additional model information.

Unpacking the UPS

1. Do not lean the UPS against anything when moving it out of the packaging.
2. Check the physical appearance of the UPS to see if it was damaged during transportation. Do not switch on the UPS if damage is found. Please contact your dealer or distributor immediately for assistance.
3. Check the accessories according to the packing list to assure that you have all required pieces.



R90-20KVA FRONT VIEW

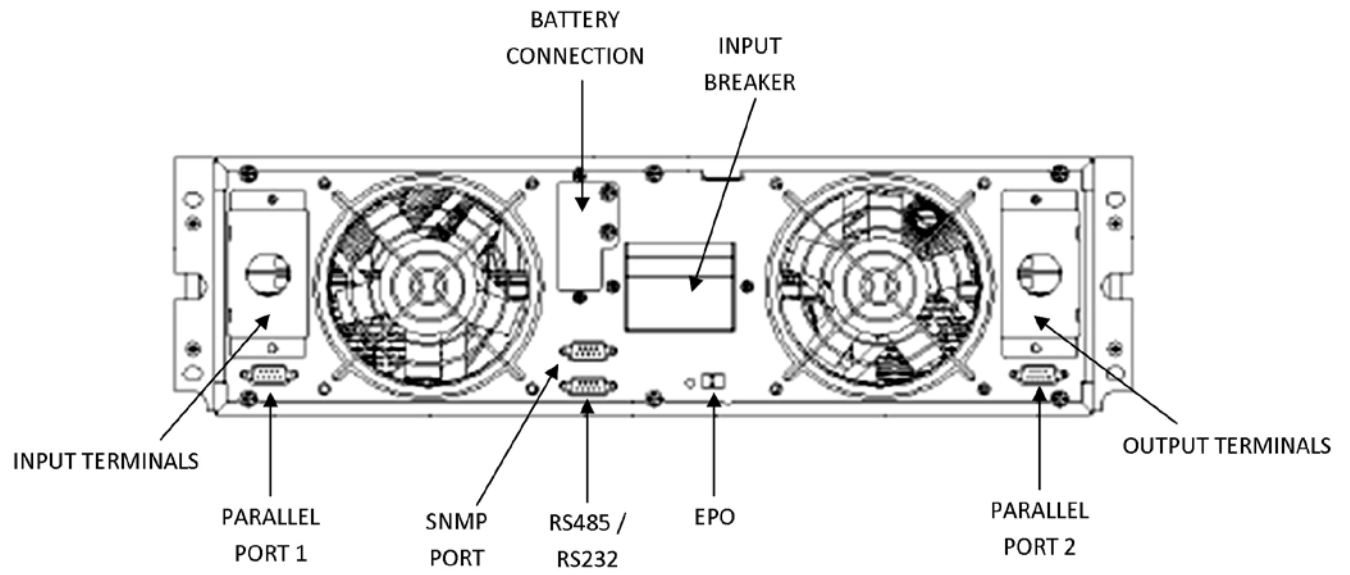

R90-20KVA REAR VIEW DIAGRAM

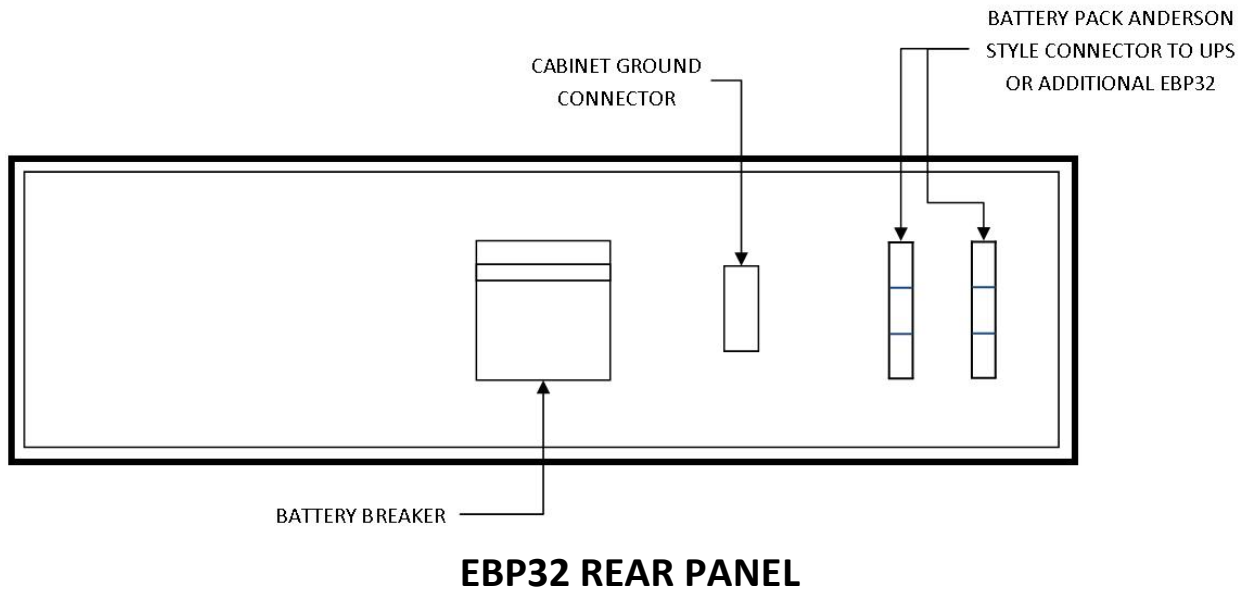

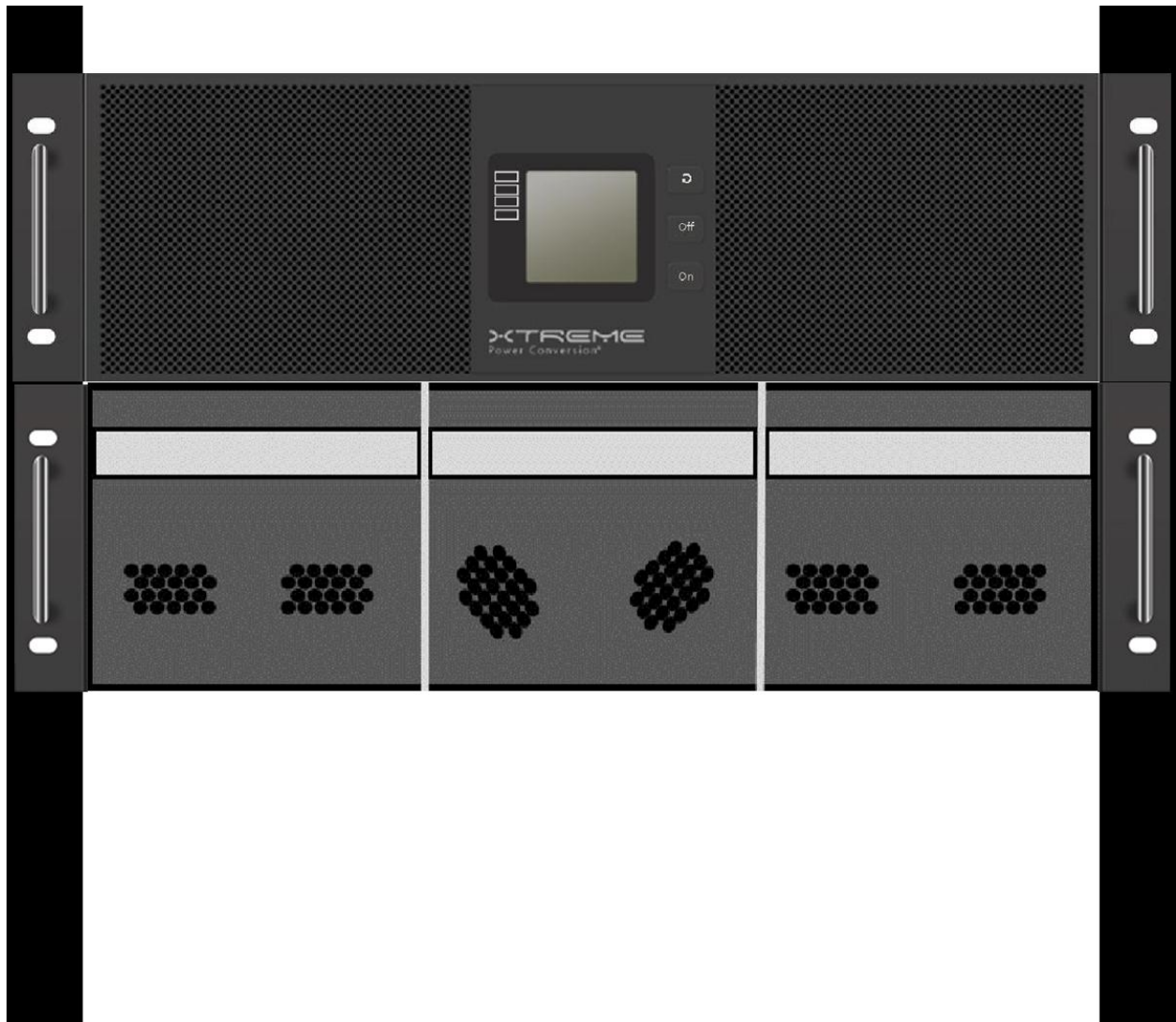

R90-20KVA UPS + R90-EBP32 MOUNTED IN A RACK

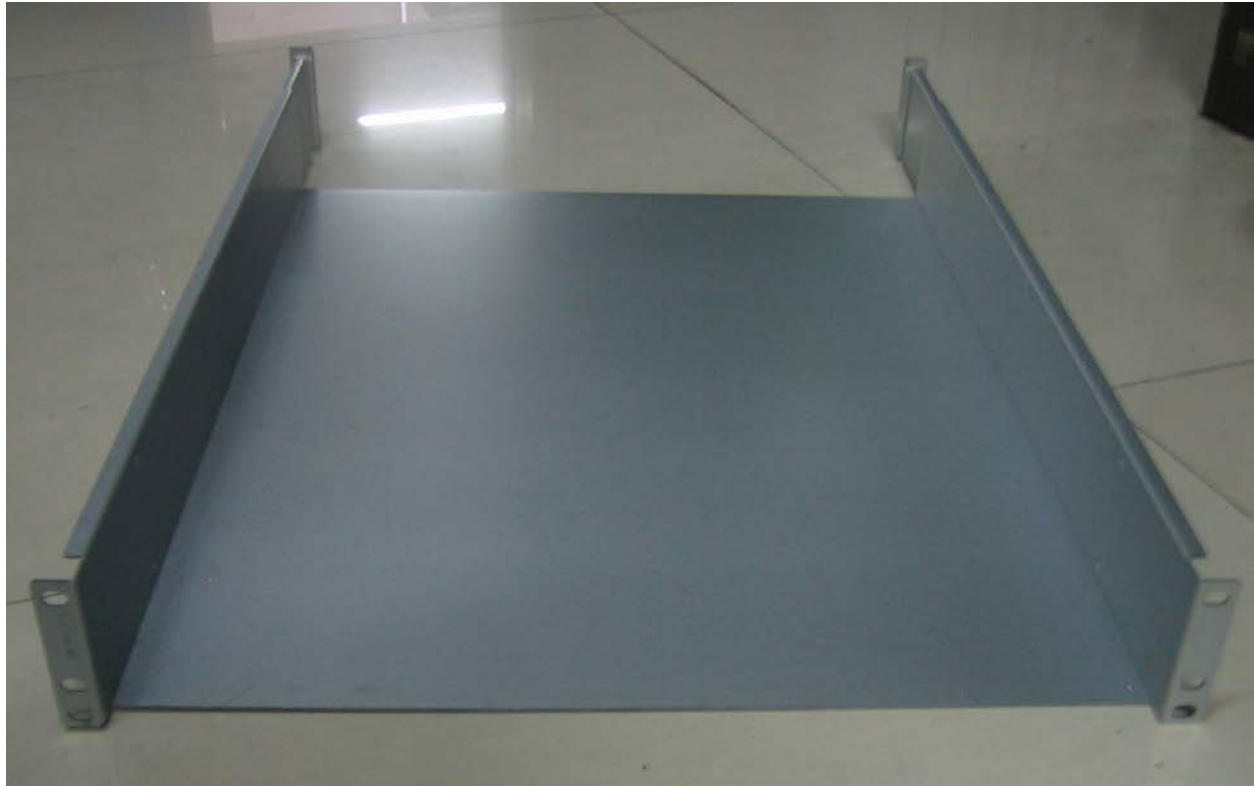

SHELF SHIPPED WITH UPS & EBP32 FOR MOUNTING IN A RACK

Note: this shelf must be used in order to support the weight of the equipment. Do not install UPS or EBP32 into a rack without using this shelf

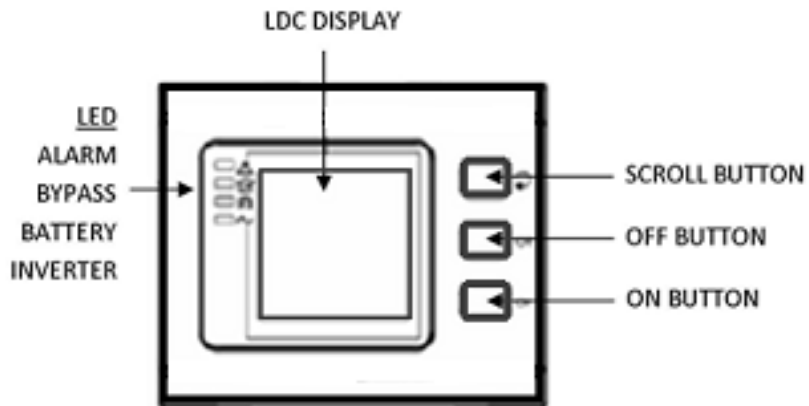

FRONT PANEL

Installation Notes

- Place the UPS in a clean, stable environment, avoiding vibration, dust, humidity, flammable gas and liquid, corrosive objects, etc. Check the operating temperature of the room where the UPS is being installed to assure it is within range of UPS specification.
- Batteries should be installed in an environment where the temperature is within the required specifications of the product. Temperature is a major factor in determining battery life and capacity. Normal battery installation requires the temperature be maintained from 15°C to 25°C. Keep batteries away from heat sources and main air ventilation areas.



WARNING!

Typical battery performance data is quoted for an operating temperature between 20°C and 25°C. Operating above this range will reduce the battery life while operation below this range will reduce the battery capacity.

- If the equipment is not to be installed immediately, it must be stored in a room so as to protect it against excessive heat and humidity sources.



CAUTION!

An unused battery must be recharged every 6 months. Temporarily connecting the UPS to a suitable AC source and activating the UPS for the time required to recharge the batteries is required.

- To monitor the UPS with the software, simply connect the RS232 cable to the UPS and to a computer.

External Protective Devices

For safety reasons, it is necessary to install an external circuit breaker at the input AC utility and to the battery.

External Battery

The UPS and its associated batteries are protected against the effect of over-current through a DC compatible thermo-magnetic circuit breaker located close to the battery.

UPS Output

Any external distribution board used for load distribution shall be fitted with protective devices so as to avoid the risk of UPS overload.

Over-Current Protection

A protection device shall be installed at the distribution panel of the incoming utility power, and should identify the power cables current capacity as well as the overload capacity of the system.

**CAUTION!**

Select a thermo magnetic circuit-breaker with an IEC 60947-2 trip curve C (normal) for 125% of the current as listed below.

40A Input Circuit Breaker required***Power Cables***

The cable design shall comply with the voltages and currents provided in this section, and in accordance with local electrical codes.

**WARNING!**

UPON STARTING, PLEASE ENSURE THAT YOU ARE AWARE OF THE LOCATION AND OPERATION OF THE EXTERNAL ISOLATORS WHICH ARE CONNECTED TO THE UPS INPUT/BYPASS SUPPLY OF THE UTILITY DISTRIBUTION PANEL. CHECK TO SEE IF THESE SUPPLIES ARE ELECTRICALLY ISOLATED, AND POST ANY NECESSARY WARNING SIGNS TO PREVENT ANY INADVERTENT OPERATION

Cable Sizes

UPS MODEL	CABLE SIZES (THHW wiring at 75°C)			
	AC INPUT	AC OUTPUT	DC INPUT	GROUNDING
R90-20KVA	8 awg	8 awg	6 awg	8 awg

**CAUTION!**

Protective earth ground cable: connect each cabinet to an earth ground, following the shortest route possible.

**WARNING!**

FAILURE TO FOLLOW ADEQUATE GROUNDING PROCEDURES MAY RESULT IN ELECTROMAGNETIC INTERFERENCE OR IN HAZARDS INVOLVING ELECTRICAL SHOCK AND FIRE.

Power Cables Connection

After the equipment has been properly positioned and secured, connect the power cables as described below.

Verify the UPS is totally isolated from its external power source and all circuit breakers to the UPS are open. Check to see that everything is electrically isolated, and post any necessary warning signs to prevent inadvertent operation of the breakers.

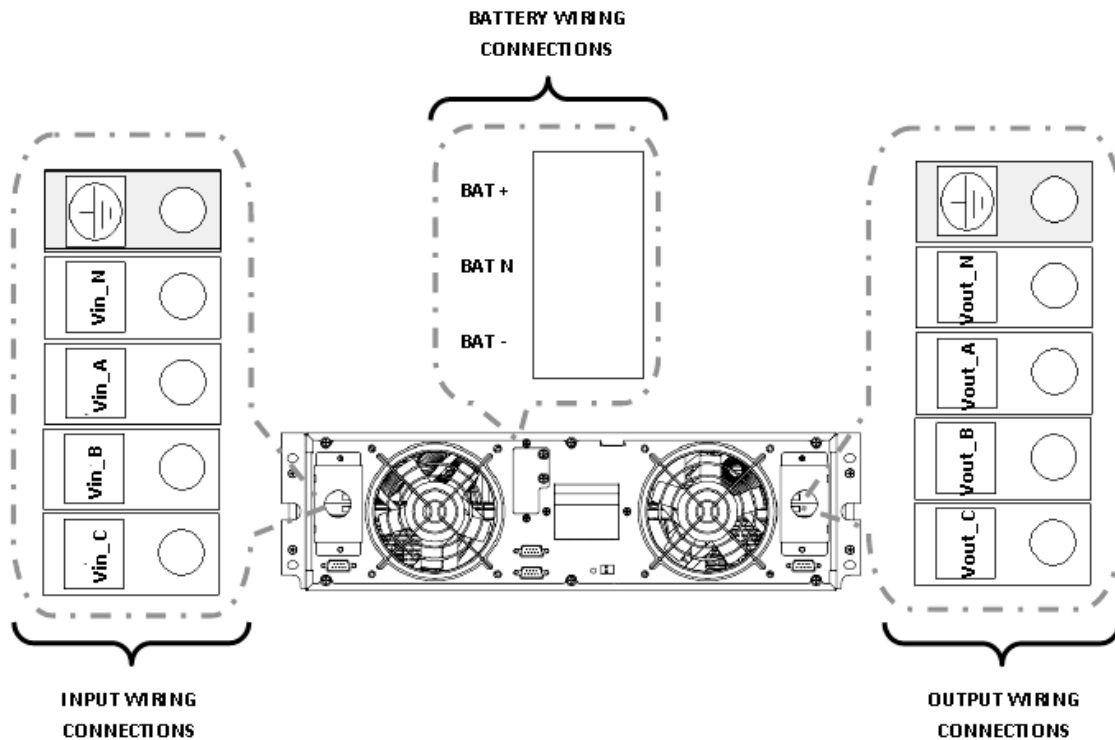

POWER CABLE CONNECTION DIAGRAM

Select the appropriate power cable size, paying attention to the diameter of the connection terminal of the cable, which should be greater than or equal to the connection posts.

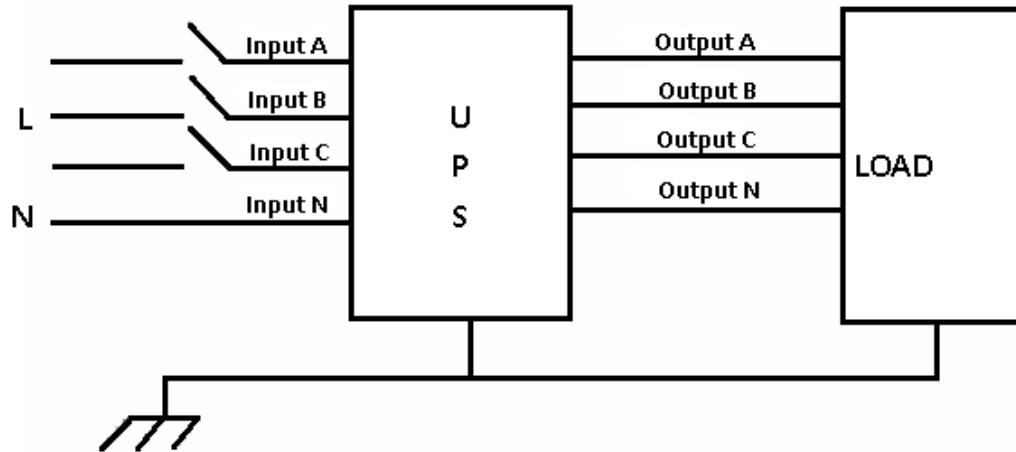

WIRING DIAGRAM

**WARNING!**

IF THE LOAD EQUIPMENT IS NOT READY TO ACCEPT POWER WHEN THE UPS INSTALLATION IS OCCURING, ENSURE THAT THE UPS OUTPUT CABLES ARE SAFELY ISOLATED AT THE CABLE ENDS.

**CAUTION!**

The earth ground and neutral bonding arrangement must be in accordance with local and/or national electrical code practices.

**CAUTION!**

Ensure correct polarity of the battery string series connection (i.e. inter-tier and inter block connections are from (+) to (-) terminals. DO NOT mix batteries with different capacity or different brands, or new or old batteries.

**WARNING!**

ENSURE CORRECT POLARITY OF STRING END CONNECTIONS TO THE BATTERY CIRCUIT BREAKER, AND FROM THE BATTERY CIRCUIT BREAKER TO THE UPS TERMINALS (I.E. (+) TO (+) / (-) TO (-)). DISCONNECT ONE OR MORE BATTERY CELL LINKS IN EACH TIER. DO NOT RECONNECT THESE LINKS AND DO NOT CLOSE THE BATTERY CIRCUIT BREAKER UNLESS ALL CONNECTIONS ARE PROPERLY CHECKED AND APPROVED.

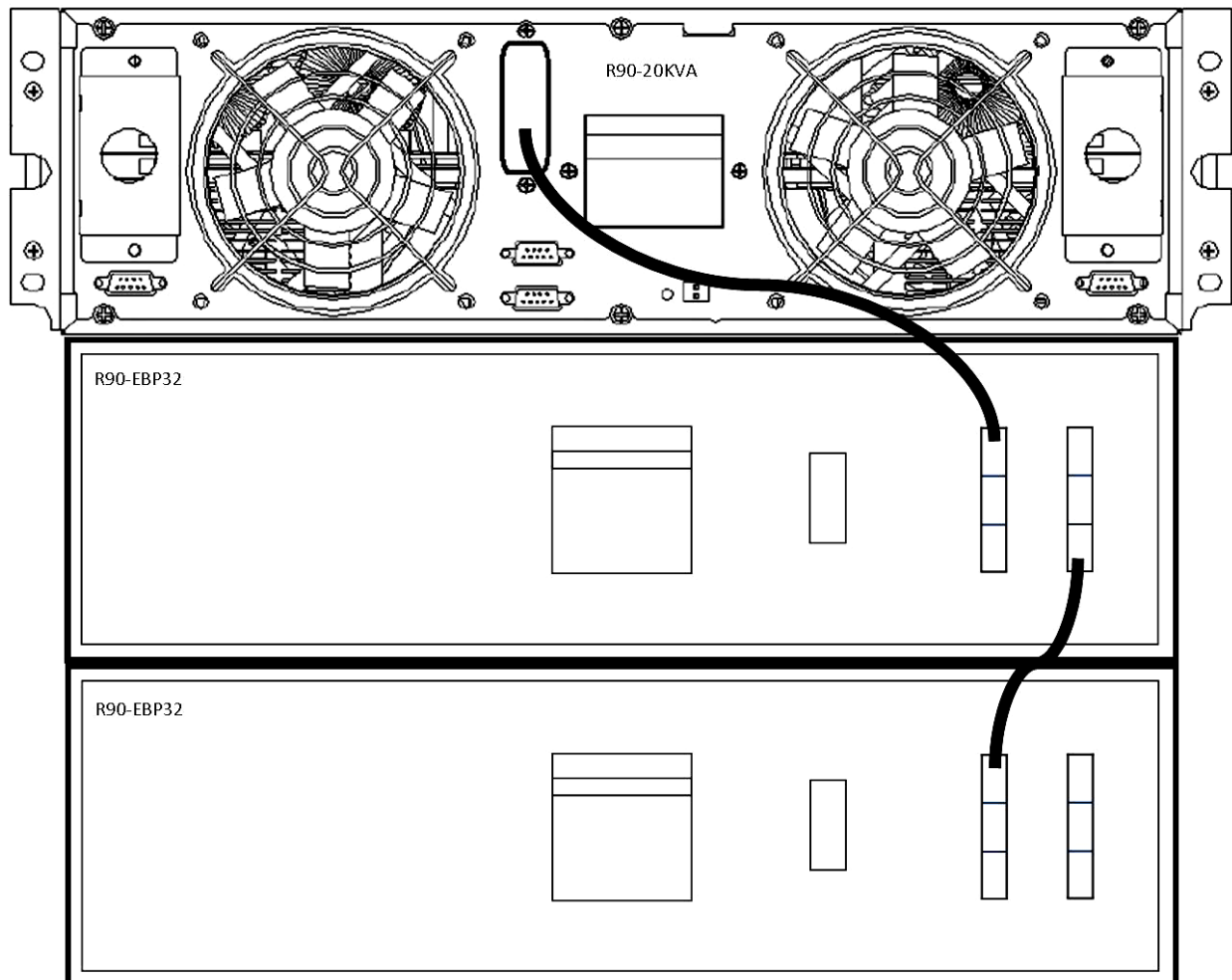

UPS -TO- EBP32 BATTERY CONNECTION

UPS Multi-Module Installation

The basic installation procedure for a parallel system consisting of two or more R90-20KVA modules is that same as that of a single module. The following provides installation procedures related to a parallel system.

Cabinet Installation

Connect all R90-20KVA UPS required in the parallel system as shown in the diagram below.

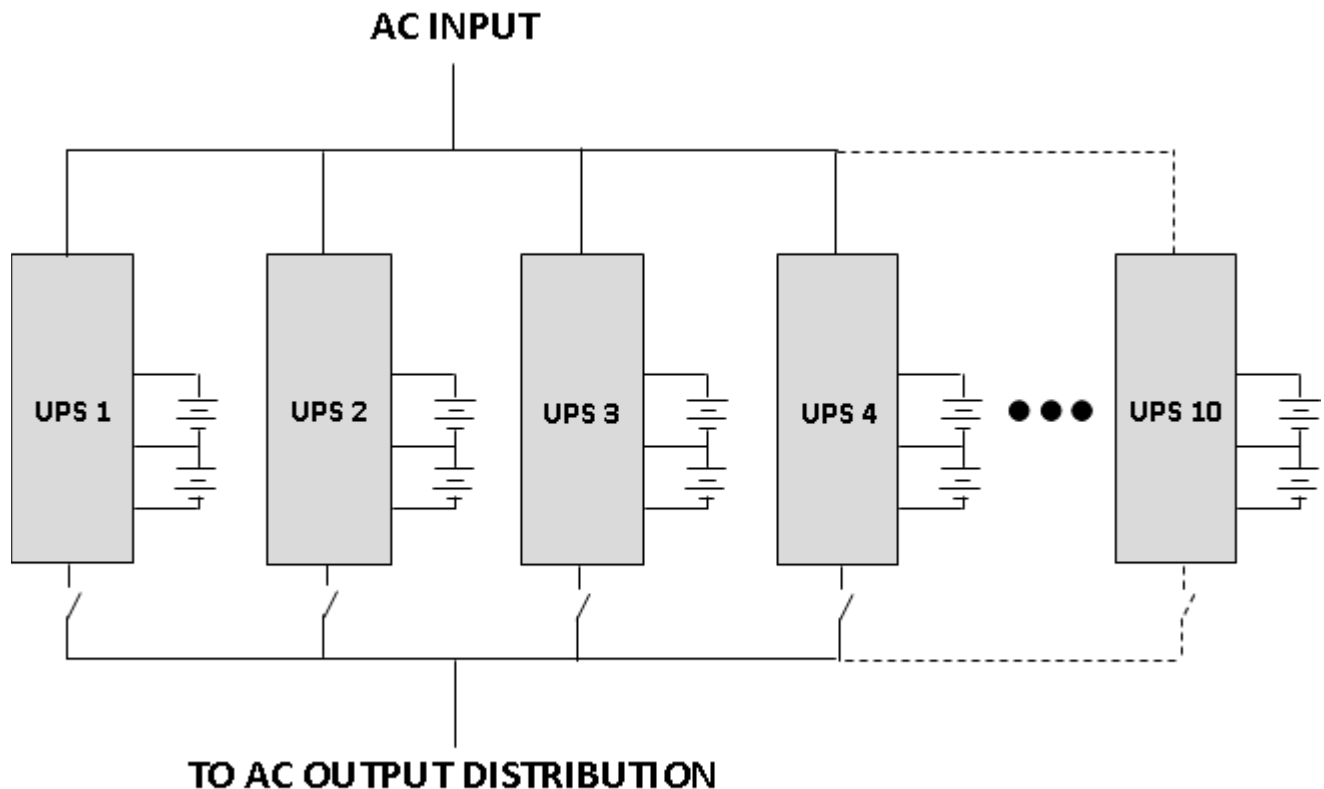

Note: common battery can be engineered for use with multiple UPS if desired.

Note:

If installing 5-6 units in parallel, remove the jumper cap J30 on the control inspection board (MHTBJHR1CU04 in all UPS to be connected in parallel.

If installing 7-10 units in parallel, remove the jumper cap J30/J31 on the control inspection board (MHTBJHR1CU04 in all UPS to be connected in parallel.

Make sure that each UPS input breaker is in the "OFF" position and there is no output from any UPS connected. The battery strings can be connected separately or in parallel.



WARNING!

MAKE SURE THE N, A(L1), B(L2), AND C(L3) WIRING IS CORRECT, AND THAT GROUND IS CONNECTED.

Parallel Cable Installation

The shielded and double insulated control cables must be interconnected in a ring-configuration between UPS modules as shown in the diagram below. The parallel control board is mounted in each UPS module. The ring-configuration ensures high-reliability of the control function.

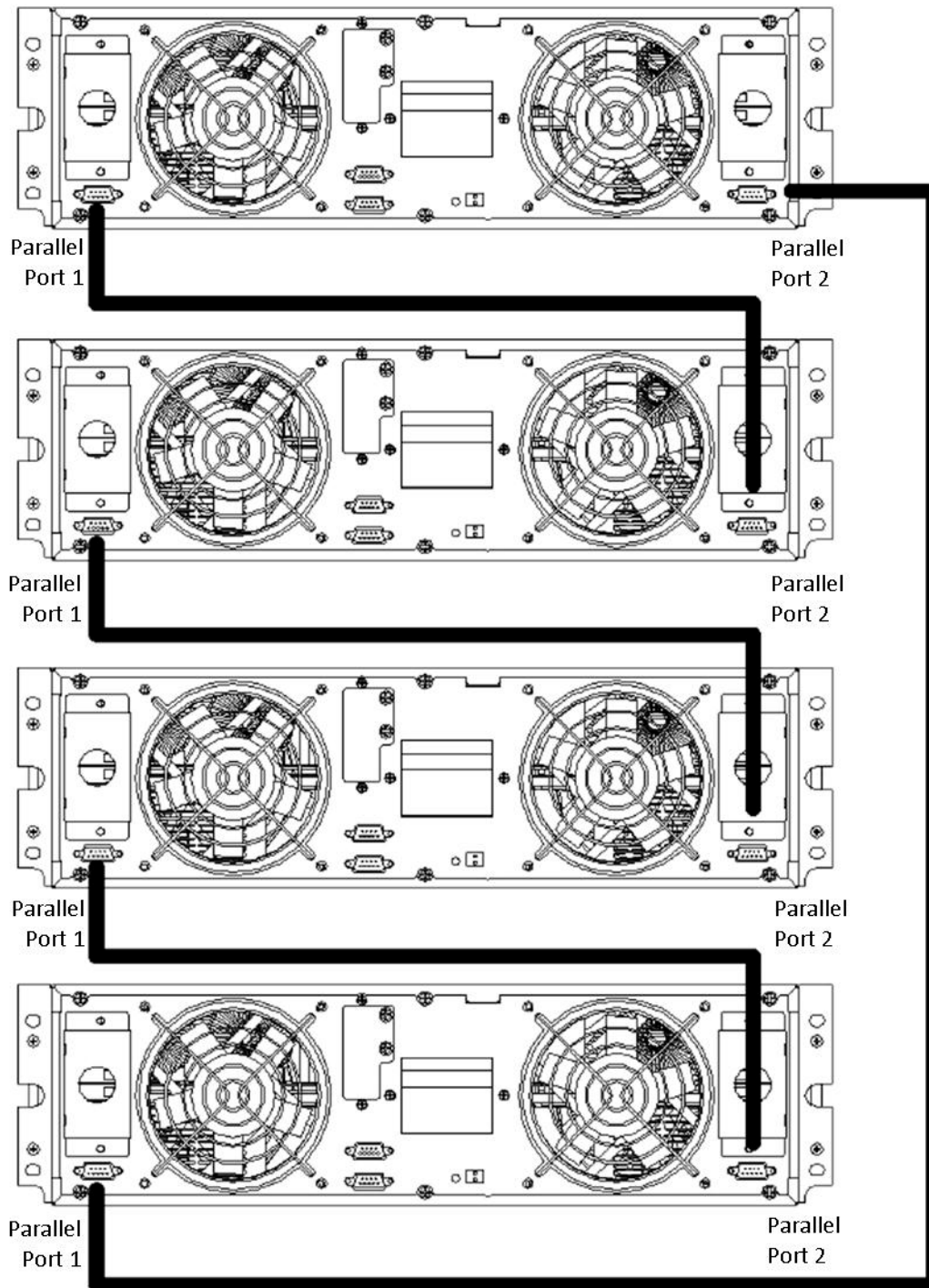

PARALLEL CONNECTION OF UPS

Remote Emergency Power Off (EPO) for Parallel Systems

EPO for parallel systems must be connected in parallel and installed as shown below. Once the EPO function of one of the UPS in the parallel system is activated, the UPS will send out a remote command and shut down the other UPS's in the parallel system.



CAUTION!

The remote emergency kill switch must be voltage-free and “normally open”.

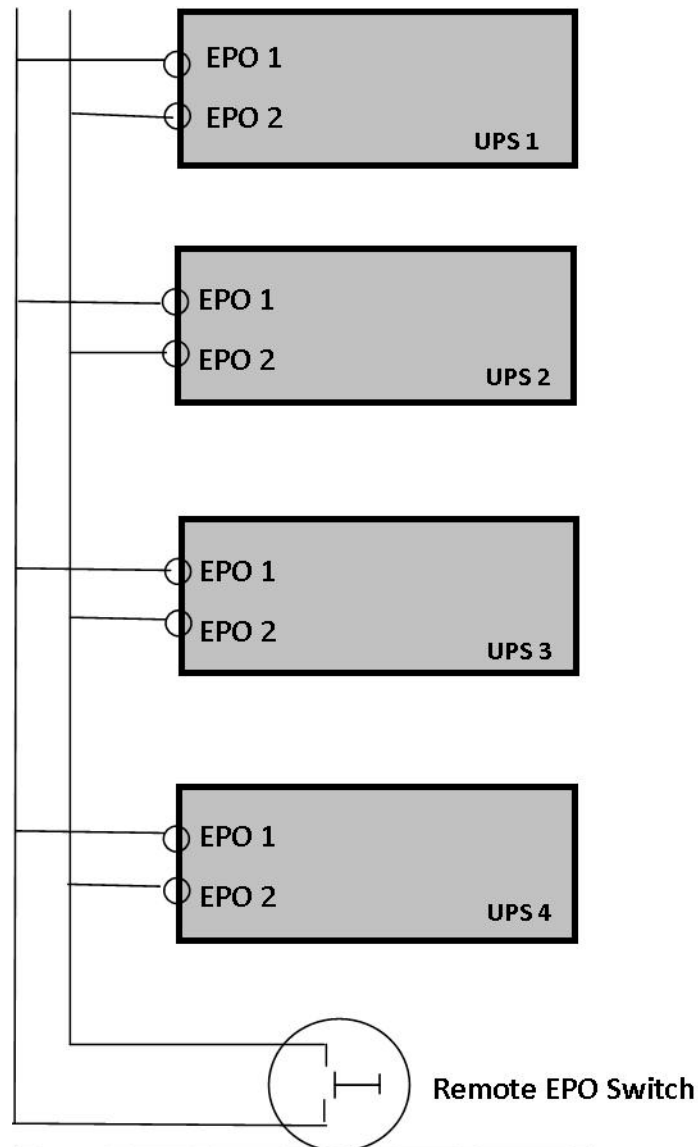

EPO CONNECTIONS FOR PARALLEL SYSTEMS

Requirements for a Parallel System

A group of parallel UPS modules behave as one large UPS system with the advantage of presenting higher reliability. In order to assure that all modules are equally utilized and comply with relevant wiring regulations, please follow the requirements below.

1. All UPS modules must be of the same rating and be connected to the same bypass source.
2. The Bypass and Utility input sources must be referenced to the same neutral potential.
3. The outputs of all the UPS modules must be connected to a common output bus.
4. The length and specification of power cables including the bypass input cables and the UPS output cabinets should be the same size. This facilitates load sharing when operating in bypass mode.
5. Up to 10 UPS modules may be paralleled with common battery if desired

Note:

If installing 5-6 units in parallel, remove the jumper cap J30 on the control inspection board (MHTBJHR1CU04 in all UPS to be connected in parallel.

If installing 7-10 units in parallel, remove the jumper cap J30/J31 on the control inspection board (MHTBJHR1CU04 in all UPS to be connected in parallel.

OPERATION

Operation Modes

The UPS is a double-conversion online UPS that may operate in the following alternative modes.

Normal Mode

The rectifier / charger derives power from the AC input utility and supplies DC power to the inverter while floating and boost charging the battery simultaneously. The inverter then converts the DC power to AC power and supplies the load.

Battery Mode (stored energy mode)

If the AC input utility power fails, the inverter, which is operating from power supplied by the battery, supplies the critical AC loads with power from the batteries. There is no power interruption to the critical load. The UPS will automatically return to Normal Mode when AC input utility recovers.

Bypass Mode

If the inverter is not functioning correctly, or if an overload occurs, the static transfer switch will be activated to transfer the load from the inverter supply to bypass supply without interruption to the critical load. In the event that the inverter output is not synchronized with the bypass AC source, the static switch will perform a transfer of the load from the inverter to the bypass with power interruption to the critical AC loads. This is to avoid paralleling of unsynchronized AC sources. This interruption is

programmable but typically set to be less than one electrical cycle (less than 15ms at 50Hz or less than 13.3ms at 60Hz).

ECO Mode

When the UPS is in AC Model and the requirement to the load is not critical, the UPS can be set to ECO Mode in order to increase the efficiency of the power supplied. In ECO Mode, the UPS works in line-interactive mode, so the UPS will transfer to bypass utility. When the AC is out of the set window, the UPS will transfer from bypass to inverter and supply power from the batteries, with the LCD displaying all related information.

Note: ECO mode is not available in parallel system configurations.

Parallel Redundancy Mode (system expansion)

To achieve higher capacity and / or increase reliability, the output of up to ten (10) UPS modules can be programmed to operate in parallel, with the built-in parallel controller in each UPS ensuring automatic load sharing.

Turn On / Off the UPS

Connecting with Utility

The UPS is a double-conversion online UPS that may operate in the following alternative modes.



CAUTION!

MAKE SURE PROPER GROUNDING IS IN PLACE.

- Set the Battery Breaker to the "ON" position according to the user manual.
- Switch "ON" the UPS



CAUTION!

Check to see if the load is safely connected to the output of the UPS. If the load is not ready to receive power from the UPS, make sure that it is safely isolated from the UPS output terminals.

The internal fan of the UPS will start spinning; the UPS will perform self-diagnostics until the unit beeps twice to show the UPS is normal. The UPS then goes to bypass, Utility LED and Bypass LED turn Green, the inverter is now starting. When the inverter is checked "normal", the UPS goes to Normal Mode and the load is supplied power by the inverter.

Cold Start Procedure

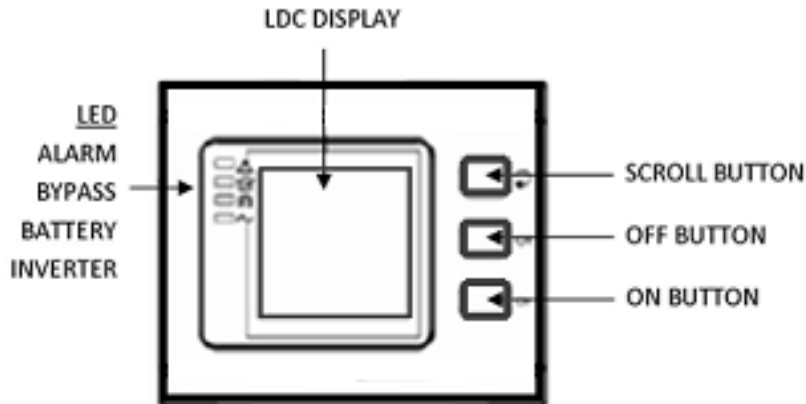

CAUTION!

Follow these procedures when there is an input AC Utility Failure but the batteries are normal.

- Turn on the battery switch.
 - The battery will feed the Auxiliary power board.
- Trigger the Cold Start Buttons of the modules respectively using the ON BUTTON shown in the above diagram.
 - When battery is normal, the rectifier starts operation. 30 seconds later the inverter starts and operates, INV and Output light up.



CAUTION!

Wait for approximately 30 seconds before pressing the ON BUTTON.

Inverter Off

When the Utility is normal, press OFF BUTTON for approximately 1 second until you hear a beep. The INVERTER LED will extinguish, the BYPASS LED will be illuminated, then the UPS turns to bypass supply.

Disconnecting from Utility



CAUTION!

This procedure should be followed to completely shut down the UPS and the LOAD. After all power switches, isolators, and circuit breakers are opened, there will be no output power from the UPS.

- After the inverter is off, turn the Utility and Battery breakers to "OFF". The LCD display will extinguish completely and the fan stops spinning in 60 seconds. If there are external battery packs connected, turn the Battery breakers on each battery pack to the "OFF" position.

WARNING!

Wait about 5 minutes for the internal DC bus bar capacitors to be completely discharged.

Computer Access

- Connect one end of the RS232 communications cable to a computer and the other end to the RS232 port on the UPS
- Open the software Muser4000, and choose “**system**” button



- Choose **“Software Parameter Setting”** and set selections as shown below and then save settings
 - COM = COM1
 - Baud Rate = 9600
 - Protocol = HIP

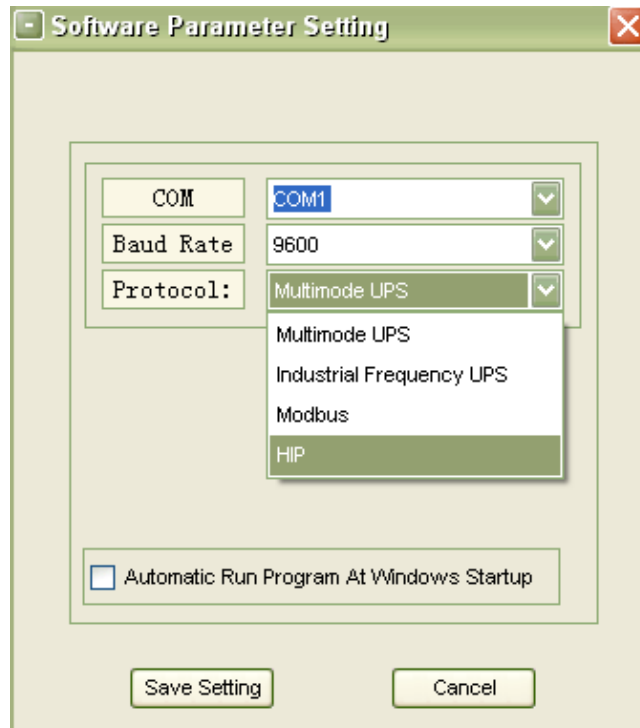

- On the main page of Muser4000, choose the **“Append”** button, place the UPS name into **“Equipment Name”**, and UPS ID address into **“Equipment address”**. Choose the **“Append”** button, then the connection between UPS and computer is complete.

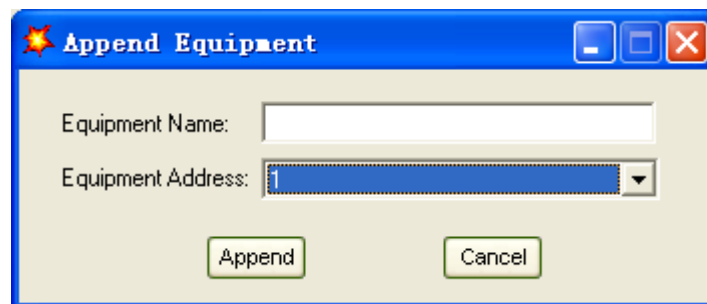

Parallel Setting

- Connect the UPS with a computer. Power ON the UPS.
- Open Muser4000 software and choose “System” > “User Set”



- Select “Set” at “User Set” window

User Set

Work Mode: Parallel

System Voltage Level: 380V

System Frequency Level: 60Hz

Parallel Amount: 4

Bypass lock out: 10

Parallel Redundancy: 0

Bypass Frequency Range: 5%

Bypass Volt Upper Limit: 15%

Bypass Volt lower Limit: -45%

Invert-Volt adjustment: 0%

Ups ID: 1

Output: Enable Disable

Auto Turn-on: Enable Disable

Buzzer: Enable Disable

Battery Set

Battery Number(x2):

Single Battery Volt.(V): 12V

Boost upper limit Volt.(V/Cell): 2.30

EOD Volt(0.01V/Cell): 1.70

Battery Group: 1

Single Battery Capability(AH): 40

Float base Volt.(V/Cell): 2.20

Max Charge current(A): 6

Boost Charge: Enable Disable

Boost Last Time(H): 4



CAUTION!

When powered by inverter, it is necessary to turn off the inverter before setting the voltage and frequency level in PC

At the window of “Data Set”, select “Work Mode” with “Parallel” for the Value, then select “Set” as shown in the figure below. If the UPS “beeps” it means the setting is correct.

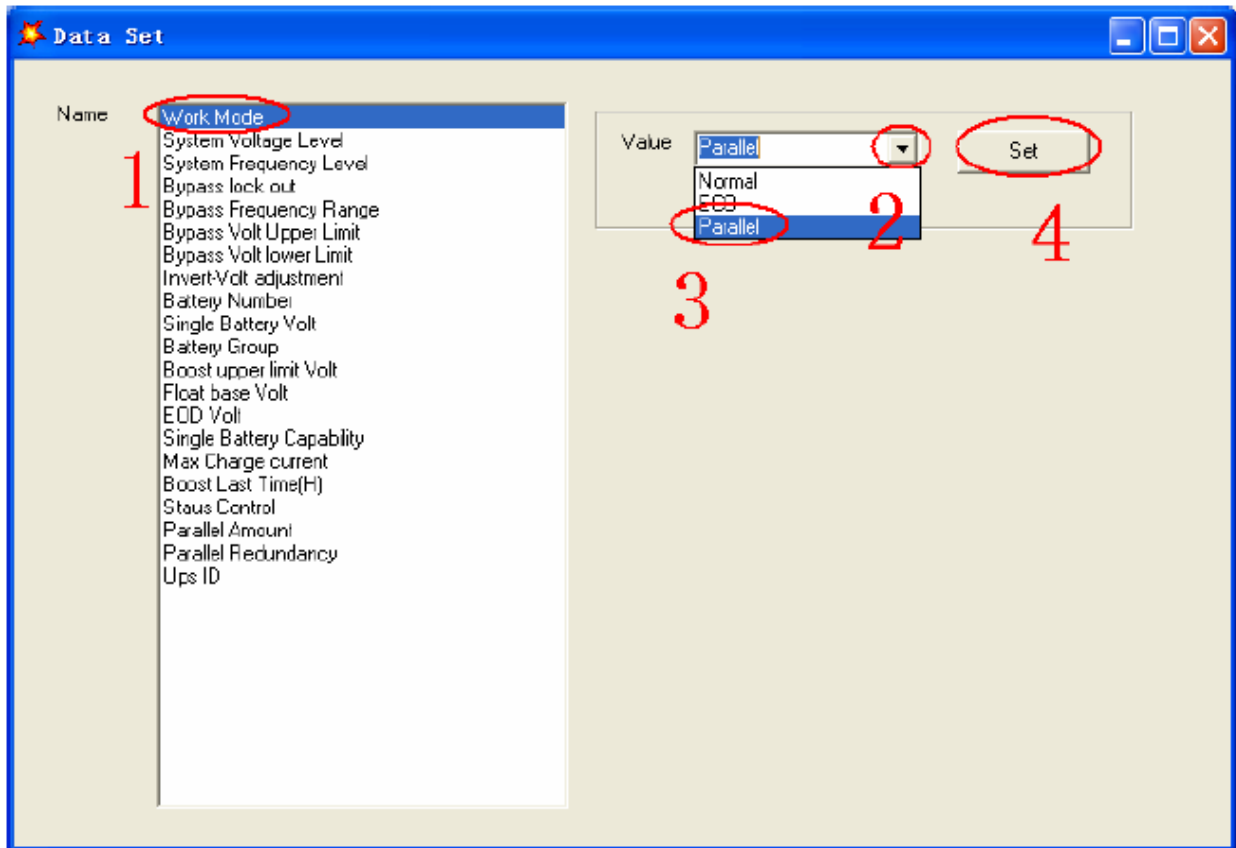

At the window of “Data Set”, select “UPS ID”, enter the Value for the parallel UPS ID at the right side, then select “Set” as shown in the figure below. If the UPS “beeps” it means the setting is correct.

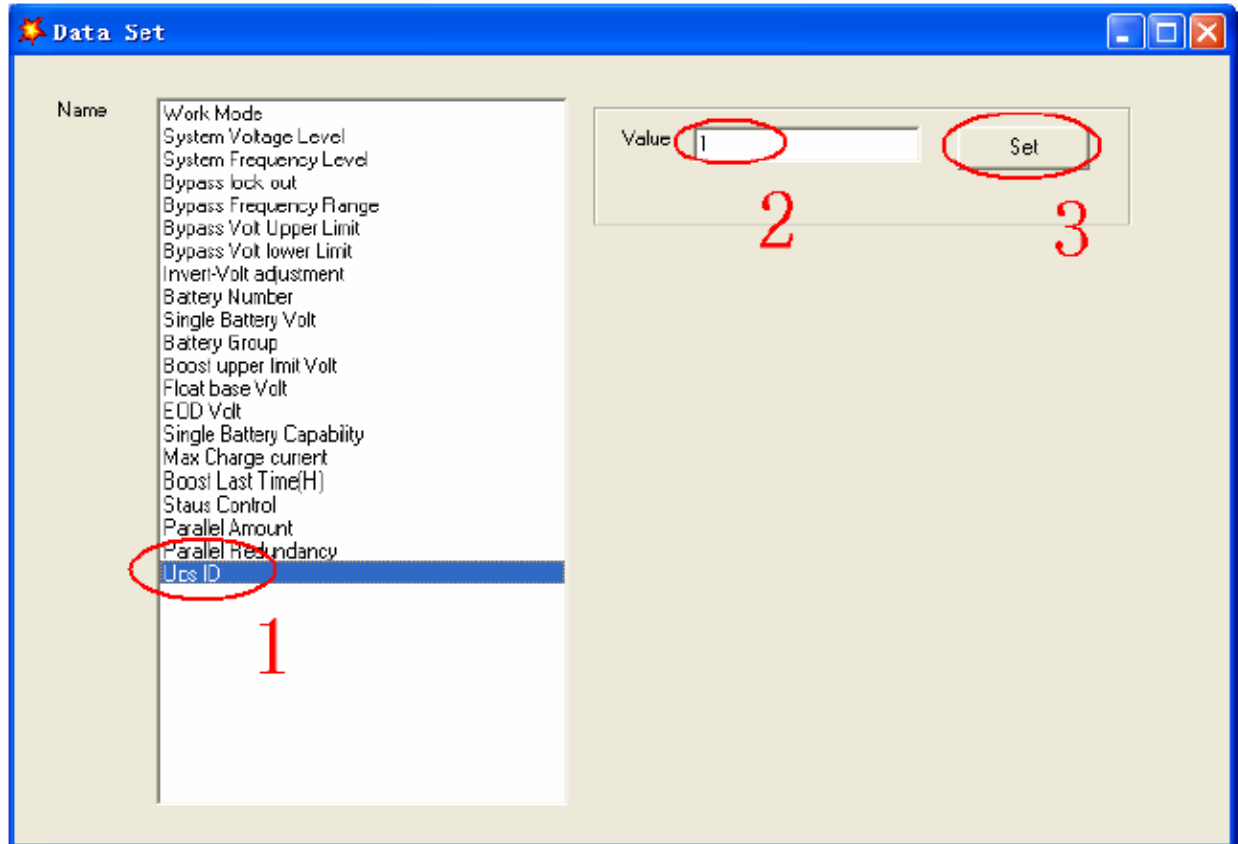

CAUTION!

After changing the parallel system ID, the connection between Muser4000 and equipment might be interrupted. If this occurs, re-connect in accordance with the instructions described earlier in this manual.



CAUTION!

Parallel cable cannot be connected when setting the parallel parameters

- After setting the UPS's that need to be paralleled, power OFF all the UPS's. Connect all the UPS's according to “parallel cable installation”, and then power ON the UPS's.

Note:

If installing 5-6 units in parallel, remove the jumper cap J30 on the control inspection board (MHTBJHR1CU04 in all UPS to be connected in parallel.

If installing 7-10 units in parallel, remove the jumper cap J30/J31 on the control inspection board (MHTBJHR1CU04 in all UPS to be connected in parallel.

Communication Port Definitions (RS232, RS485)

Definition of the Port

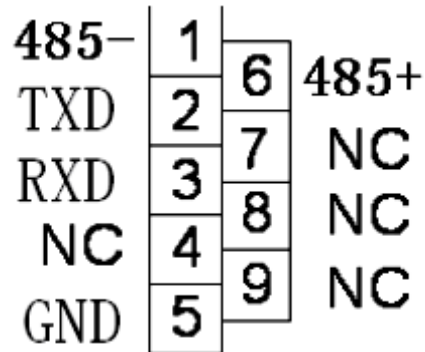

Connection between PC RS232 port and UPS RS232 port

PC RS232 port	UPS RS232 port	Description
Pin 2	Pin 2	UPS send, PC receive
Pin 3	Pin 3	PC send, UPS receive
Pin 5	Pin 5	Ground

Connection between the computer RS485 port and UPS RS485 port

PC (DB9 male)	UPS (DB9 female)	Description
Pin 1	Pin 1	485 “-”
Pin 6	Pin 6	485 “+”

Available function of RS232

- Monitor UPS power status
- Monitor UPS alarm information
- Monitor UPS running parameters
- Timing Off / On setting

RS-232 communication data format

Baud rate = 9600bps

Byte length = 8bit

End bit = 2bit

Parity check = none

The Display

System LCD Display

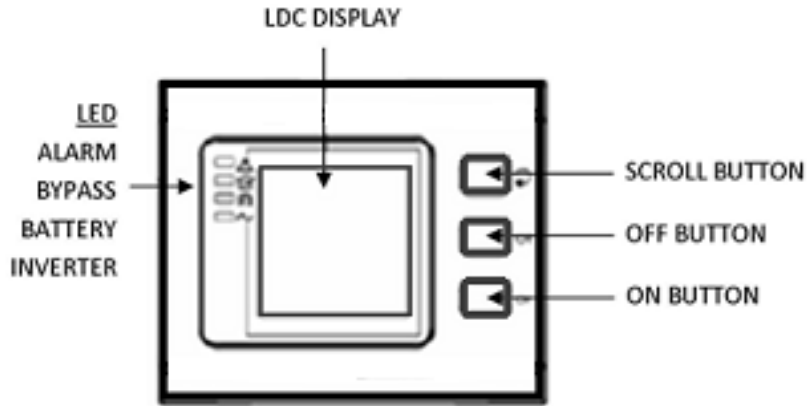

CAUTION!

The display provides more functions than those described in this manual.

There are 15 interfaces available in the LCD display as shown below.

ITEM	INTERFACE DESCRIPTION	CONTENT DISPLAYED
01	CODE	Operational status and mode
02	Input A (Input L1)	Voltage & Frequency
03	Input B (Input L2)	Voltage & Frequency
04	Input C (Input L3)	Voltage & Frequency
05	Bat. +	Voltage & Current
06	Bat. -	Voltage & Current
07	Output A (Output L1)	Voltage, Frequency & Load
08	Output B (Output L2)	Voltage, Frequency & Load
09	Output C (Output L3)	Voltage, Frequency & Load
10	Load A	Load
11	Load B	Load
12	Load C	Load
13	Total Load	Load
14	Temperature	Rectifier / Inverter Temperature
15	CODE	Operational status and mode
	CODE	Alarm Code (Warning Message)

1. When the UPS is connecting with Utility or Battery at Cold Start Mode, the LCD displays shows as below.

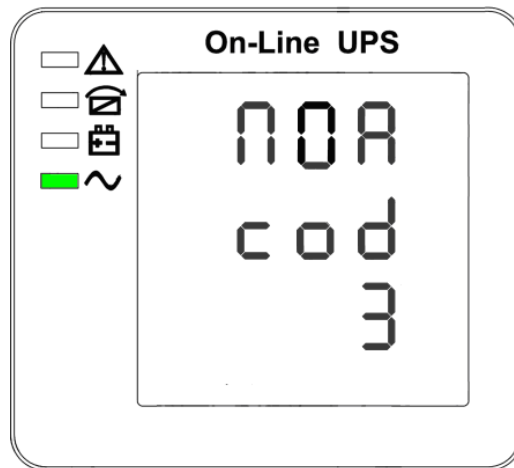

Operational Status and mode

If UPS is in single mode, display shows "NOA" or ECO"

If UPS is in parallel mode, display shows "PAL"

2. Press SCROLL BUTTON, the UPS goes to the next screen as shown below.

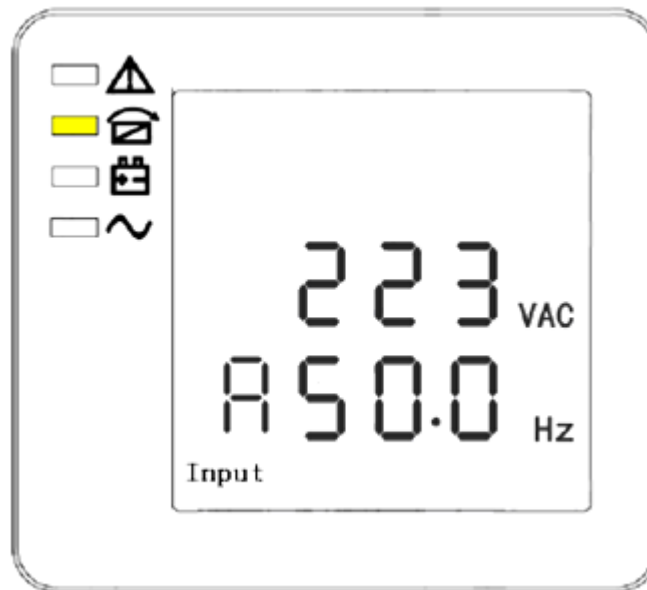

PHASE A (L1) INPUT VOLTAGE / FREQUENCY

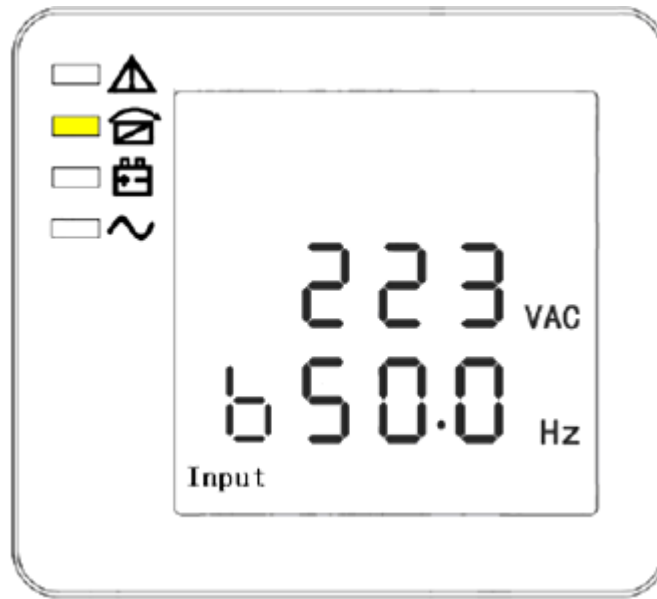

PHASE B (L2) INPUT VOLTAGE / FREQUENCY

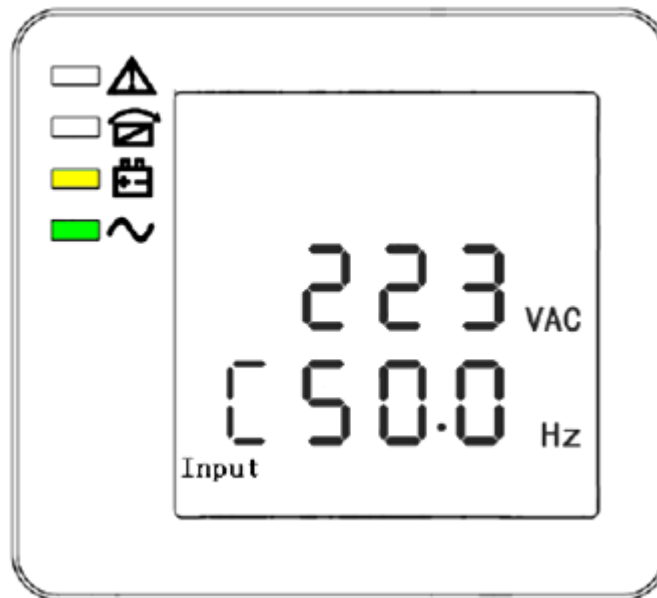

PHASE C (L3) INPUT VOLTAGE / FREQUENCY

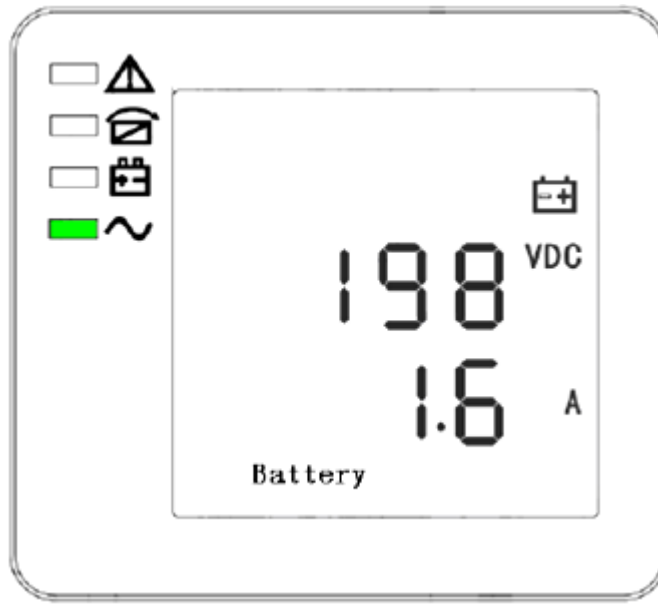

BAT + (POSITIVE)

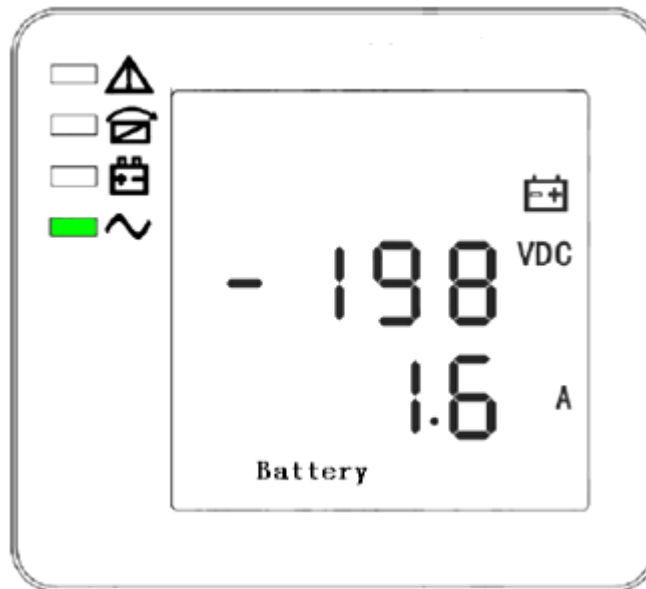

BAT - (NEGATIVE)

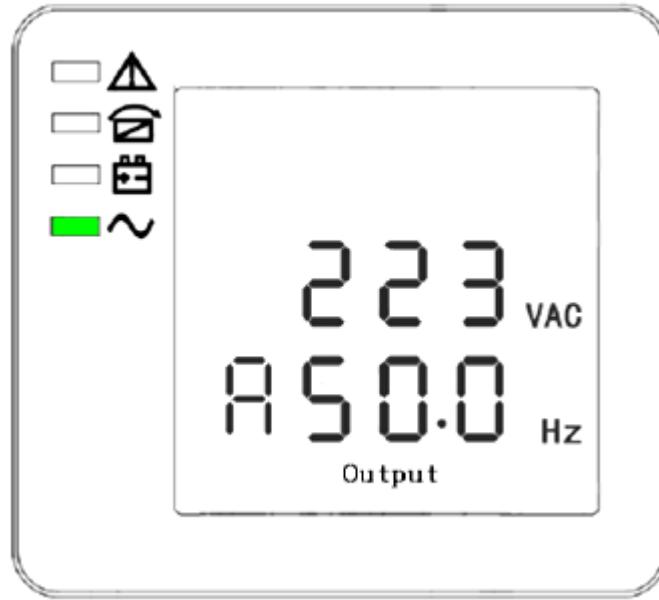

PHASE A (L1) OUTPUT VOLTAGE / FREQUENCY

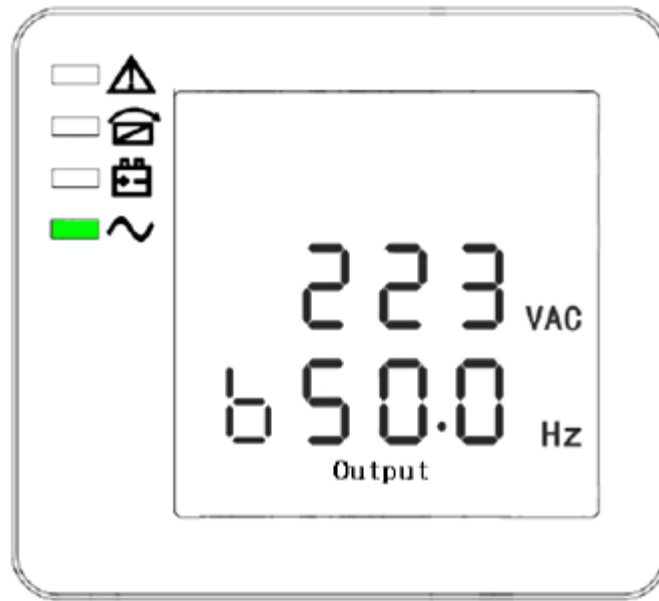

PHASE B (L2) OUTPUT VOLTAGE / FREQUENCY

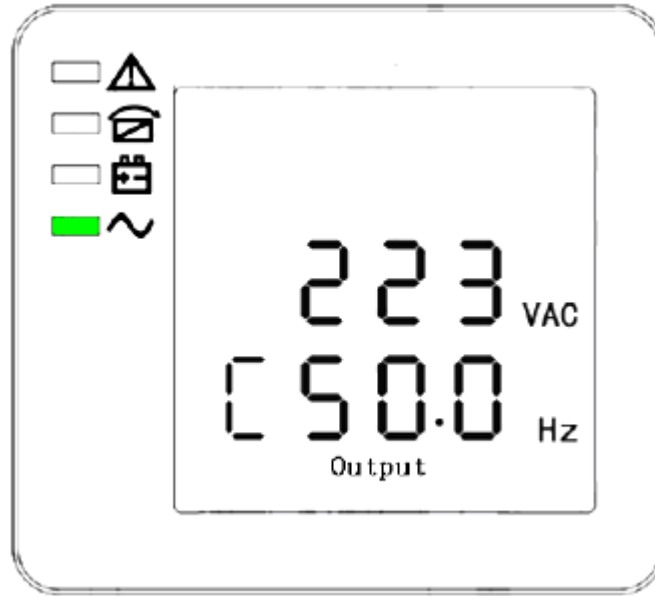

PHASE C (L3) OUTPUT VOLTAGE / FREQUENCY

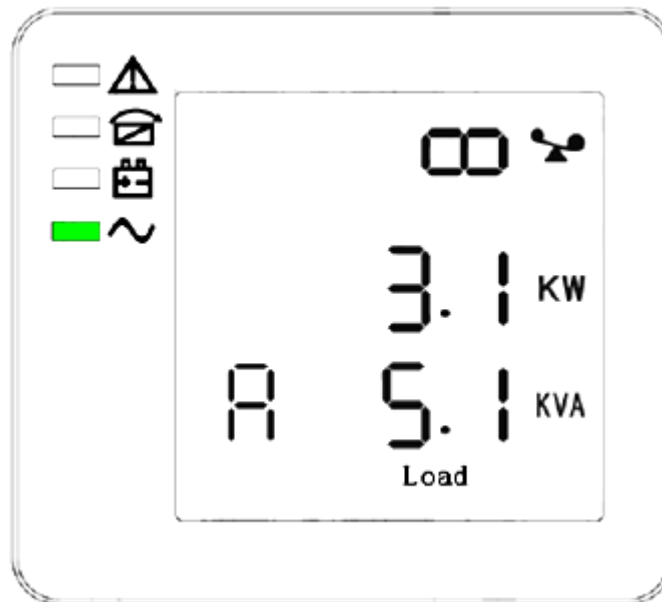

PHASE A (L1) LOAD CAPACITY

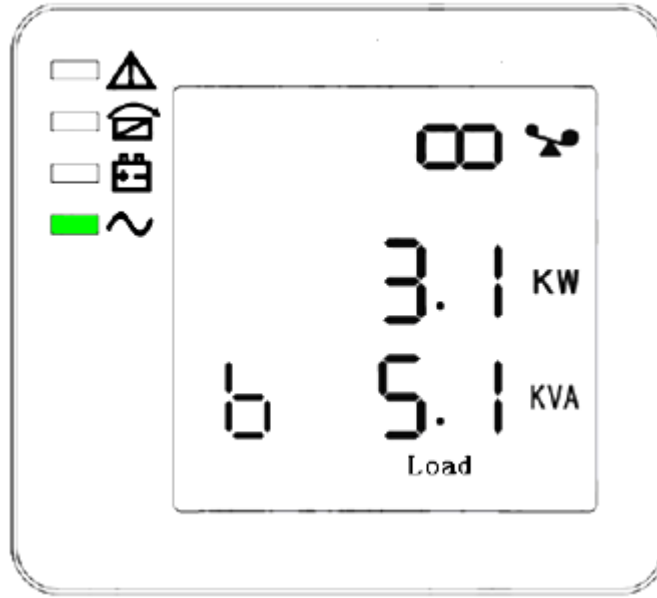

PHASE B (L2) LOAD CAPACITY

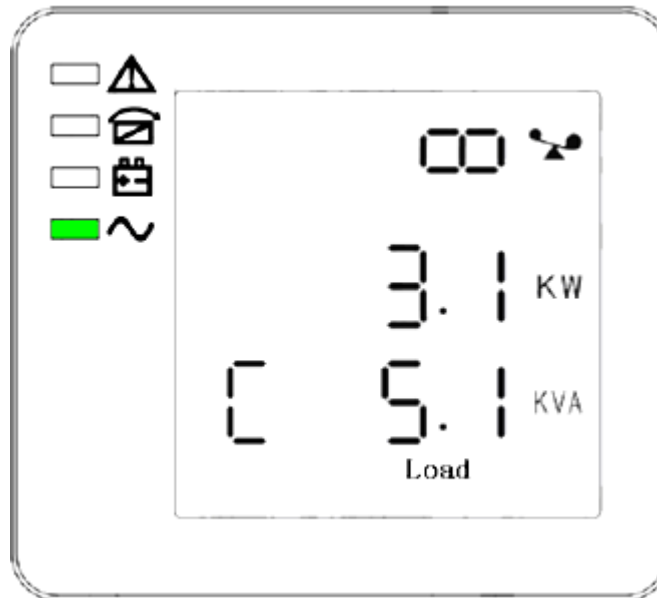

PHASE C (L3) LOAD CAPACITY

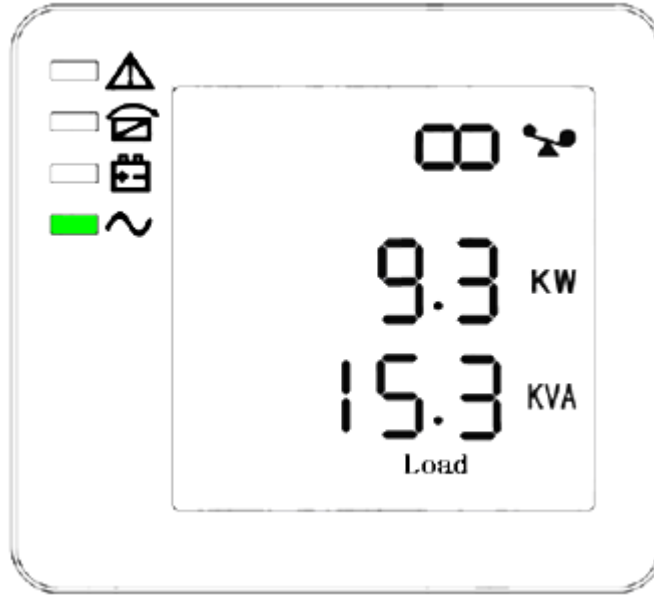

TOTAL LOAD CAPACITY

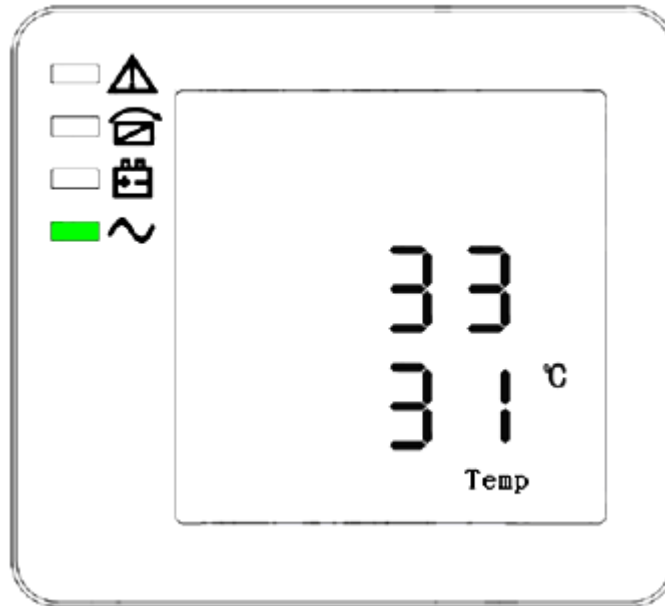

INTERNAL TEMPERATURE AND AMBIENT TEMPERATURE

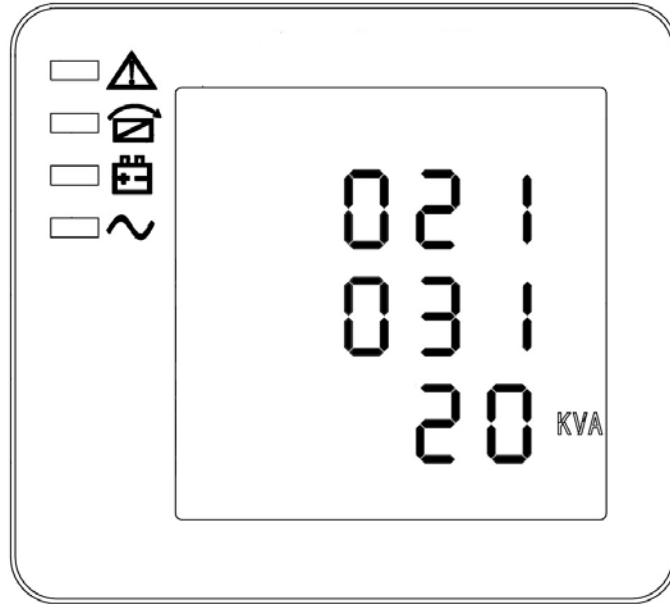

SOFTWARE VERSION & MODEL

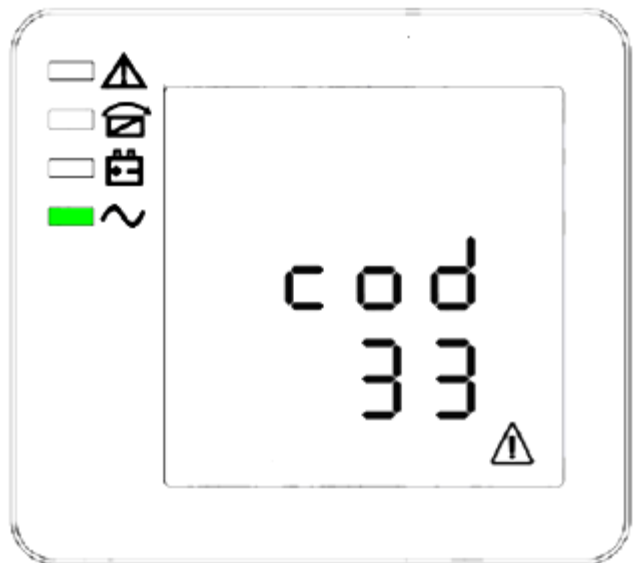

ALARM CODE

The charging status can also be shown on the display as shown below while the charger is operating.

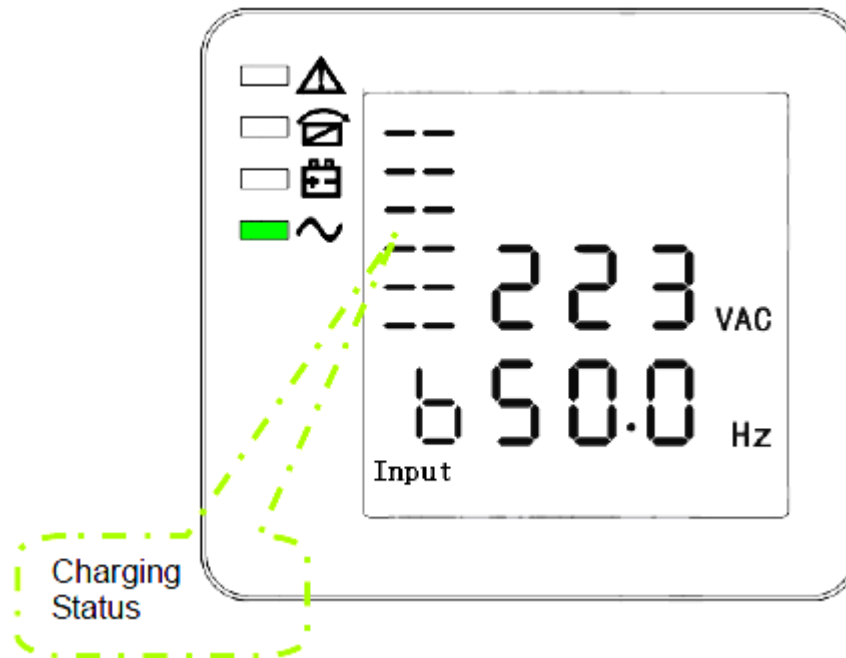

BOOST

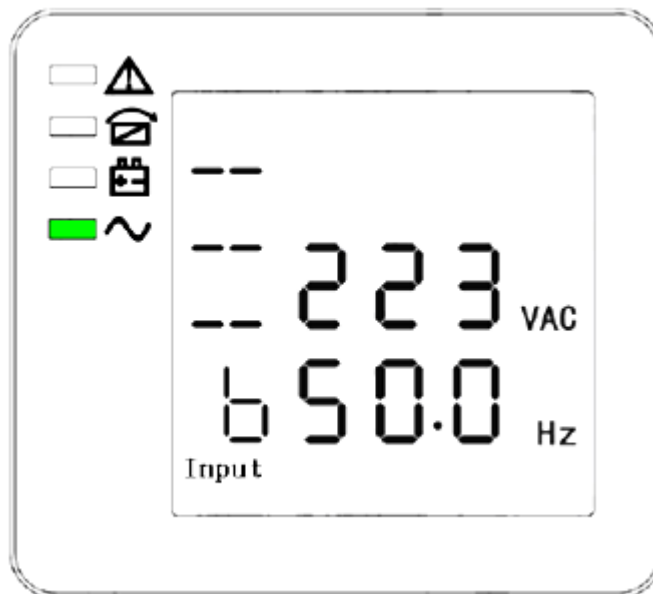

FLOATING

3. Pressing SCROLL BUTTON, steps through all messages from the first to the last, and then returns back to the first message display.
4. All alarm codes are present when abnormal behaviors occur.

Parameters setting

The setting function is controlled by 3 buttons (Enter \hookrightarrow , Off \blacktriangle , On \blacktriangledown)

Enter \hookrightarrow - goes into the setting page and value adjustment

Off \blacktriangle and On \blacktriangledown - is for choosing different pages

Enter setting mode after the UPS is on by pressing \hookrightarrow and \blacktriangle for 2 seconds

Exit setting mode by waiting 30 seconds after last button has been pressed. Settings will not be saved when exiting setting mode in this option.

Save Settings by adjusting parameters on each setting screen as needed. Once the last parameter screen has been reached (parallel redundancy quantity setting) press \blacktriangledown to exit and save all settings.

Mode setting

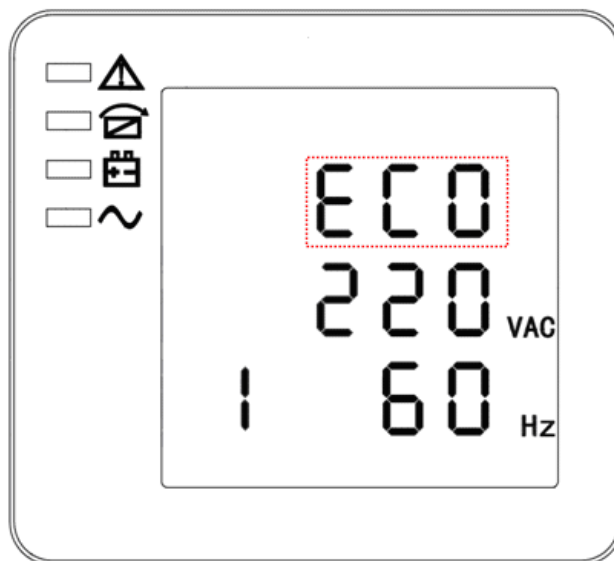

MODE SETTING

(Note: the information in the red box will be flashing)

After entering the setting menu, mode setting is defaulted, and the mode setting line flashes as in above image. Use the Enter \hookrightarrow button to choose different modes. There are 3 different modes for setting: ECO, PAL, and NOR. Press Off \blacktriangle or On \blacktriangledown to exit the mode setting (save the mode setting), and then goes to output voltage setting or parallel redundancy quantity setting.

Output voltage setting

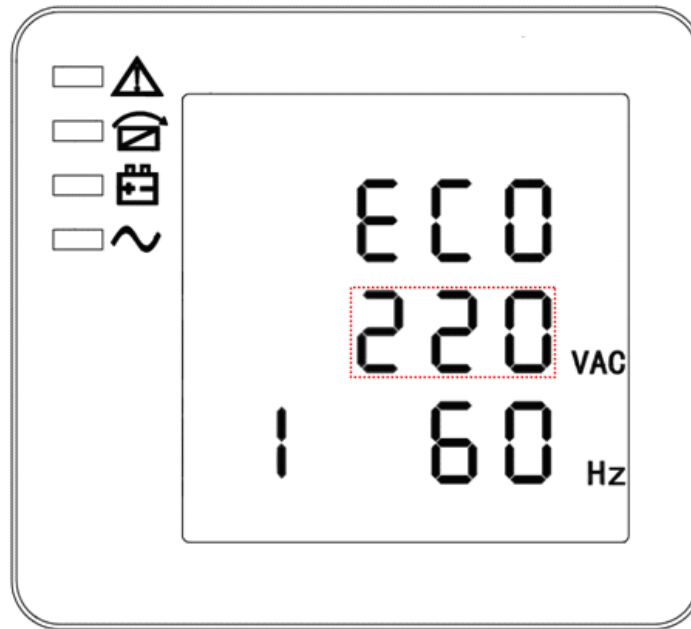

OUTPUT VOLTAGE SETTING

(Note: the information in the red box will be flashing)

When in mode setting press On ▼ or when in frequency setting press Off ▲ to go to the output voltage setting mode. The output voltage line flashes as in the above image. Use the Enter ◀ button to choose different output voltage. There are 3 different voltages - 220, 230, 240. Press Off ▲ or On ▼ to exit the output voltage setting (save the output voltage setting), and then goes to mode setting or frequency setting.

Frequency setting

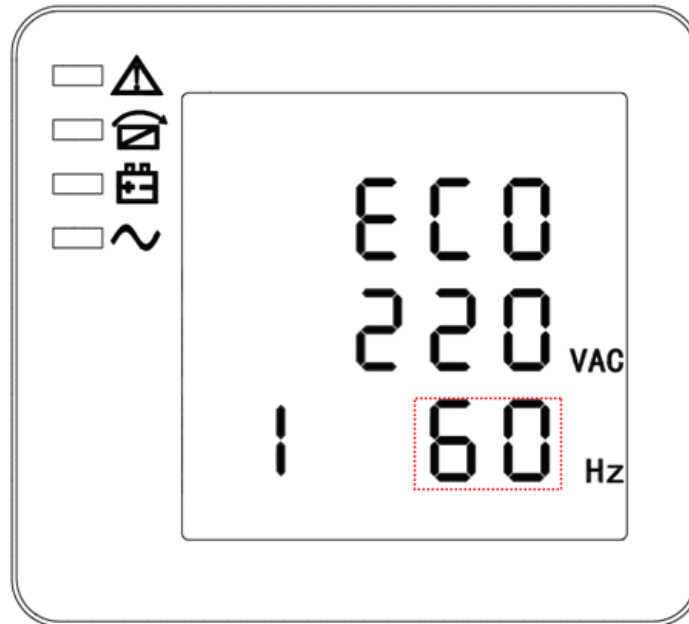

FREQUENCY SETTING

(Note: the information in the red box will be flashing)

When in output voltage setting press On ▼ or when in battery capacity setting press Off ▲ to go to the frequency setting mode. The frequency line flashes as in the above image. Use the Enter ↵ button to choose different frequency. There are 2 different frequencies - 50 or 60 Hz. Press Off ▲ or On ▼ to exit the frequency setting (save the frequency setting), and then goes to output voltage setting or battery capacity setting.

Battery capacity setting

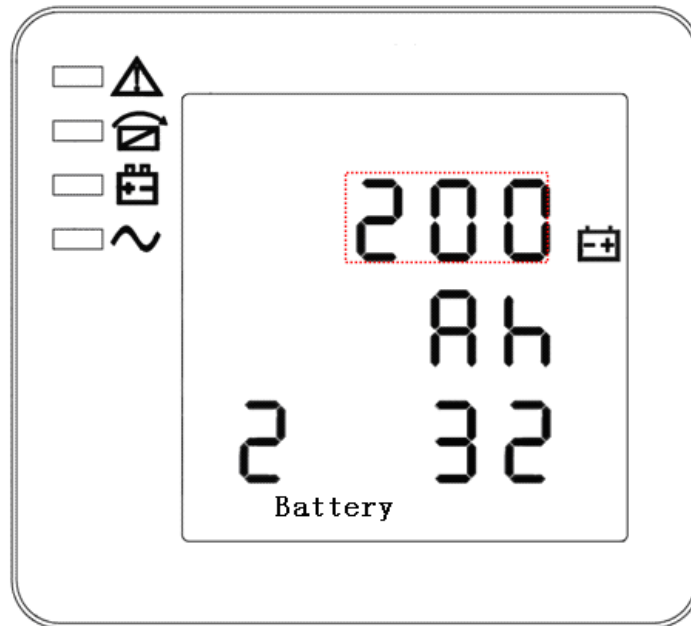

BATTERY CAPACITY SETTING

(Note: the information in the red box will be flashing)

When in frequency setting press On ▼ or when in battery quantity setting press Off ▲ to go to the battery capacity setting mode. The battery capacity line flashes as in the above image. Use the Enter ↵ button to choose different battery capacity. Battery capacity range is 1 – 200 Ah. (Note: long-press of Enter ↵ can adjust battery capacity quickly). Press Off ▲ or On ▼ to exit the battery capacity setting (save the battery capacity setting), and then goes to frequency setting or battery quantity setting.

Battery quantity setting

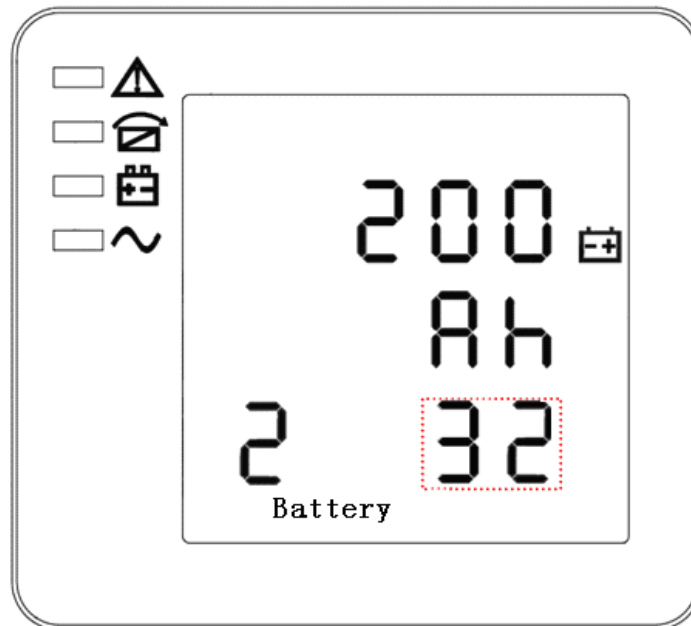

BATTERY QUANTITY SETTING

(Note: the information in the red box will be flashing)

When in battery capacity setting press On ▼ or when in bypass voltage upper limit setting press Off ▲ to go to the battery quantity setting mode. The battery quantity line flashes as in the above image. Use the Enter ↵ button to choose different battery quantity. Battery quantity range is 32, 34, 36, 38, 40. Press Off ▲ or On ▼ to exit the battery quantity setting (save the battery quantity setting), and then goes to battery capacity setting or bypass voltage upper limit setting.

Bypass voltage upper limit setting

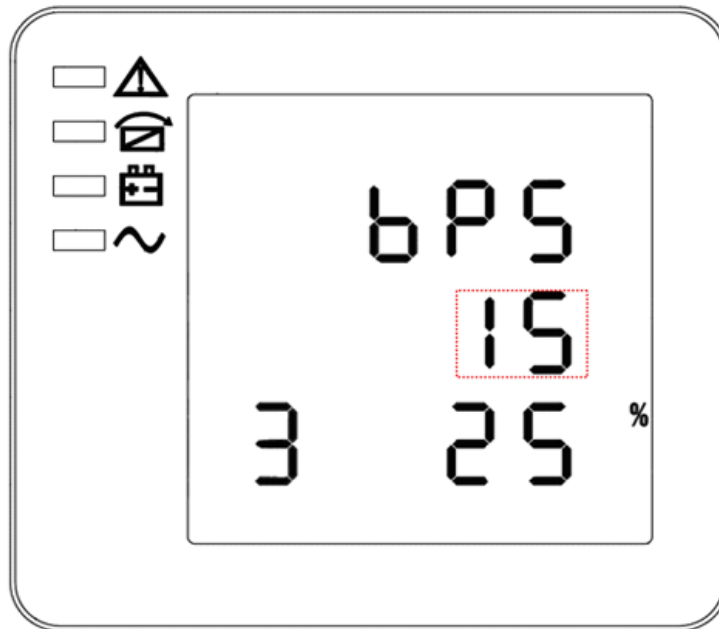

BYPASS VOLTAGE UPPER LIMIT SETTING

(Note: the information in the red box will be flashing)

When in battery quantity setting press On ▼ or when in bypass voltage lower limit setting press Off ▲ to go to the bypass voltage upper limit setting mode. The bypass voltage upper limit line flashes as in the above image. Use the Enter ↵ button to choose different bypass voltage upper limit. Bypass voltage upper limit range is 5%, 10%, 15%, 25% (25% is only available for 220V output). Press Off ▲ or On ▼ to exit the bypass voltage upper limit setting (save the bypass voltage upper limit setting), and then goes to battery quantity setting or bypass voltage lower limit setting.

Bypass voltage lower limit setting

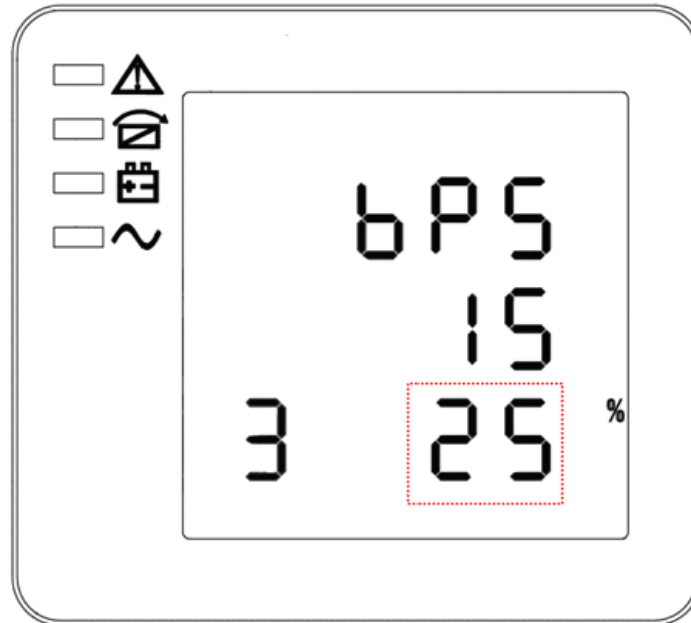

BYPASS VOLTAGE LOWER LIMIT SETTING

(Note: the information in the red box will be flashing)

When in bypass voltage upper limit setting press On ▼ or when in parallel ID setting press Off ▲ to go to the bypass voltage lower limit setting mode. The bypass voltage lower limit line flashes as in the above image. Use the Enter ↵ button to choose different bypass voltage lower limit. Bypass voltage lower limit range is 20%, 30%, 45%. Press Off ▲ or On ▼ to exit the bypass voltage lower limit setting (save the bypass voltage lower limit setting), and then goes to bypass voltage upper limit setting or parallel ID setting.

Parallel ID setting

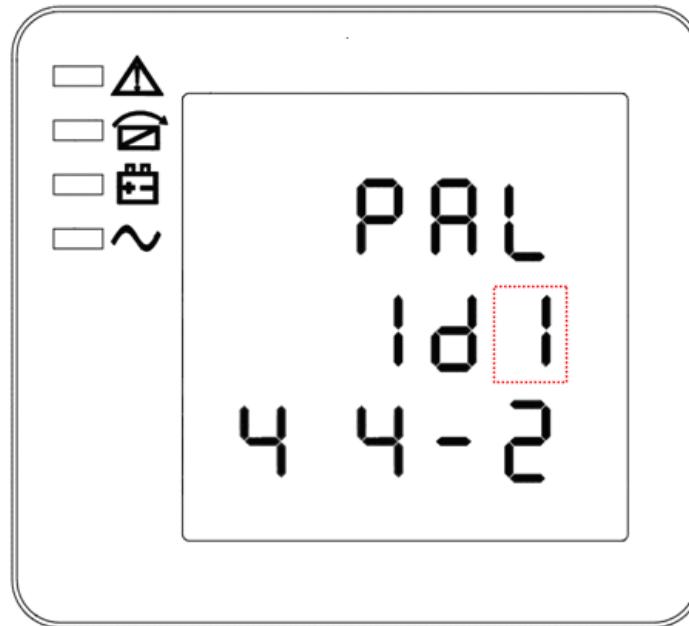

PARALLEL ID SETTING

(Note: the information in the red box will be flashing)

When in bypass voltage lower limit setting press On ▼ or when in parallel quantity setting press Off ▲ to go to the parallel ID setting mode. The parallel ID line flashes as in the above image. Use the Enter ↵ button to choose different parallel ID. Parallel ID range is 1 - 4. Press Off ▲ or On ▼ to exit the parallel ID setting (save the parallel ID setting), and then goes to bypass voltage lower limit setting or parallel quantity setting.



CAUTION!

Parallel cable cannot be connected when setting the parallel parameters

Note:

If installing 5-6 units in parallel, remove the jumper cap J30 on the control inspection board (MHTBJHR1CU04 in all UPS to be connected in parallel).

If installing 7-10 units in parallel, remove the jumper cap J30/J31 on the control inspection board (MHTBJHR1CU04 in all UPS to be connected in parallel).

Parallel quantity setting

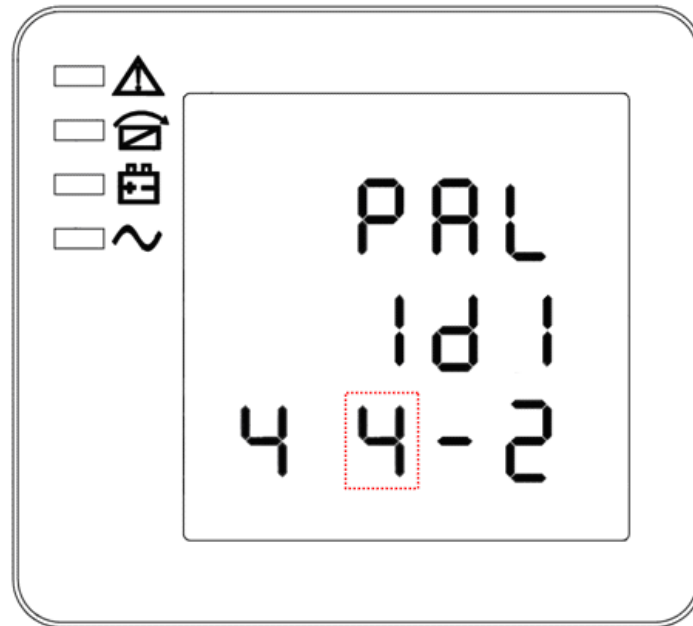

PARALLEL QUANTITY SETTING

(Note: the information in the red box will be flashing)

When in parallel ID setting press On ▼ or when in parallel redundancy quantity setting press Off ▲ to go to the parallel quantity setting mode. The parallel quantity line flashes as in the above image. Use the Enter ↵ button to choose different parallel quantity. Parallel quantity range is 2 - 4. Press Off ▲ or On ▼ to exit the parallel quantity setting (save the parallel quantity setting), and then goes to parallel ID setting or parallel redundancy quantity setting.



CAUTION!

Parallel cable cannot be connected when setting the parallel parameters

Note:

If installing 5-6 units in parallel, remove the jumper cap J30 on the control inspection board (MHTBJHR1CU04 in all UPS to be connected in parallel).

If installing 7-10 units in parallel, remove the jumper cap J30/J31 on the control inspection board (MHTBJHR1CU04 in all UPS to be connected in parallel).

Parallel redundancy quantity setting

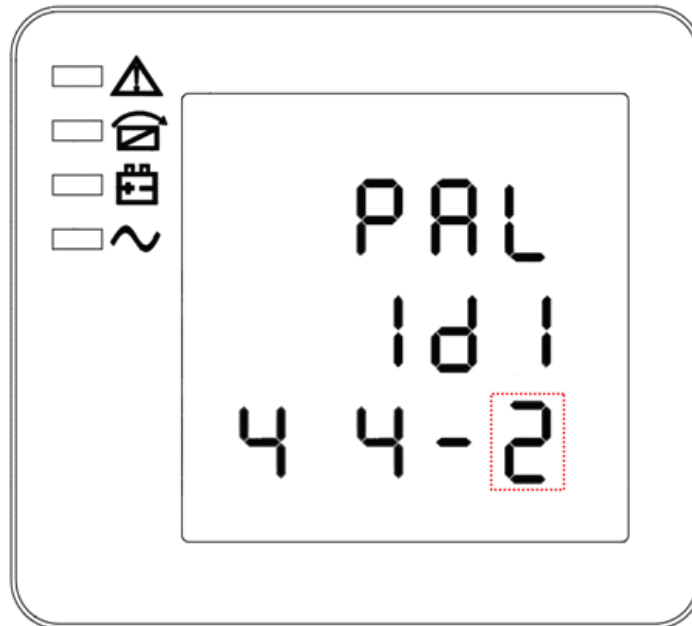

PARALLEL REDUNDANCY QUANTITY SETTING

(Note: the information in the red box will be flashing)

When in parallel quantity setting, press On ▼ to go to the parallel redundancy quantity setting mode. The parallel redundancy quantity line flashes as in the above image. Use the Enter ↵ button to choose different parallel redundancy quantity. Parallel redundancy quantity range is 0 - 3. Press Off ▲ or On ▼ to exit the parallel redundancy quantity setting (save the parallel redundancy quantity setting), and then goes to parallel redundancy setting or to exit the mode setting. The UPS LCD panel setting is now completed.



CAUTION!

Parallel cable cannot be connected when setting the parallel parameters

Note:

If installing 5-6 units in parallel, remove the jumper cap J30 on the control inspection board (MHTBJHR1CU04 in all UPS to be connected in parallel).

If installing 7-10 units in parallel, remove the jumper cap J30/J31 on the control inspection board (MHTBJHR1CU04 in all UPS to be connected in parallel).

Display Messages

This section lists the event and alarm messages that the UPS might display. The messages are listed in alphabetical order.

Operational Status and Mode(s)

ITEM	CONTENT DISPLAYED
1	Initialized
2	Standby Mode
3	No Output
4	Bypass Mode
5	Utility Mode
6	Battery Mode
7	Battery Self-diagnostics
8	Inverter is starting up
9	ECO Mode (Note: ECO mode is not available in parallel system configurations.)
10	EPO Mode
11	Maintenance Bypass Mode
12	Fault Mode

Alarm Information

EVENT LOG	UPS ALARM WARNING	BUZZER	LED
1	Rectifier Fault	Continuously	Fault LED on
2	Inverter fault (incl Inverter bridge shorted)	Continuously	Fault LED on
3	Inverter Thyristor short	Continuously	Fault LED on
4	Inverter Thyristor broken	Continuously	Fault LED on
5	Bypass Thyristor short	Continuously	Fault LED on
6	Bypass Thyristor broken	Continuously	Fault LED on
7	Fuse broken	Continuously	Fault LED on
8	Parallel Relay fault	Continuously	Fault LED on
9	Fan fault	Continuously	Fault LED on
10	Fan Power fault	Continuously	Fault LED on
11	Auxiliary Power fault	Continuously	Fault LED on
12	Initialization fault	Continuously	Fault LED on
13	P-Battery Charger fault	Continuously	Fault LED on
14	N-Battery Charger fault	Continuously	Fault LED on
15	DC Bus Over Voltage	Continuously	Fault LED on
16	DC Bus Below Voltage	Continuously	Fault LED on
17	DC Bus Unbalance	Continuously	Fault LED on

18	Soft Start failed	Continuously	Fault LED on
19	Rectifier Over Temperature	Twice per second	Fault LED on
20	Inverter Over Temperature	Twice per second	Fault LED on
21	Input Neutral Line missing	Twice per second	Fault LED on
22	Battery Reverse	Twice per second	Fault LED on
23	Cable Connection error	Twice per second	Fault LED on
24	CAN Communication fault	Twice per second	Fault LED on
25	Parallel Load Sharing fault	Twice per second	Fault LED on
26	Battery Over Voltage	Once per second	Fault LED blinking
27	Mains Site Wiring fault	Once per second	Fault LED blinking
28	Bypass Site Wiring fault	Once per second	Fault LED blinking
29	Output Short-Circuit	Once per second	Fault LED blinking
30	Rectifier Over Current	Once per second	Fault LED blinking
31	Bypass Over Current	Once per second	BPS LED blinking
32	Overload	Once per second	INV or BPS LED blinking
33	No Battery	Once per second	Battery LED blinking
34	Battery Under Voltage	Once per second	Battery LED blinking
35	Battery Low Pre-warning	Once per second	Battery LED blinking
36	Internal Communication Error	Once per 2 seconds	Fault LED blinking
EVENT LOG	UPS ALARM WARNING	BUZZER	LED
37	DC component over limit	Once per 2 seconds	INV LED blinking
38	Parallel Overload	Once per 2 seconds	INV LED blinking
39	Mains Volt. Abnormal	Once per 2 seconds	Battery LED on
40	Mains Freq. Abnormal	Once per 2 seconds	Battery LED on
41	Bypass Not Available		BPS LED blinking
42	Bypass unable to trace		BPS LED blinking
43	Inverter on invalid		

Options



CAUTION!

For network management configuration and use, refer to the separate user manual - Network Management Card with Environmental Monitor, which is shipped with the SNMP card.

SNMP Card: external SNMP optional

- Connect the external SNMP adapter to the SNMP port indicated
- Tighten the screws

The slot called SNMP supports the MEGAtec protocol. We advise NetAgent II-3 port is a tool to remotely monitor and manage any UPS system.



EXTERNAL SNMP CARD

Troubleshooting

No.	PROBLEM	POSSIBLE REASON	SOLUTION
1	Utility connected but the UPS cannot power ON	Input power supply is not connected.	Measure if the UPS input voltage / frequency are within the required range per specification. Check if all modules input switches are turned on.
		Input voltage low	
		The input switch of the module is not switched on	
2	Utility normal but Utility LED does not light, and the UPS operates at battery mode	The input breaker of the modules are not switched on; input cables are not properly connected	Switch on the input breaker. Make sure the input cable is properly connected.
3	The UPS does not indicate any failure, but the output does not have voltage	Output cable is not properly connected	Make sure the output cable is properly connected
4	Battery LED is flashing but no charge voltage and current	Battery breaker does not switch on, or batteries are damaged, or battery is reverse connected.	Switch on the battery breaker. If batteries are damaged, replace the entire set of batteries. Connect the battery cables correctly.
		Battery number and capacity are not set correctly	Go to the LCD display setting of the battery number and capacity, and set with correct data.
5	Audible beep every 0.5 seconds and LCD displays "Output Overload" code 39	Overload	Remove some of the load
6	The UPS only works on bypass	The UPS is set to ECO Mode or the transfer times to Bypass Mode are limited	Set the UPS working mode to Single Module type (non-parallel) or to reset the times of transfer to bypass or restart the UPS
7	Cannot Cold Start	Battery breaker is not properly closed or battery capacity is low	Chose the battery breaker; Recharge the batteries
15	Buzzer sounds continuously, Fault LED is illuminated and the related code of "Rectifier / Inverter Out of Order" or "Output Out of Order" shows in the LCD display	UPS has failed	Contact dealer or distributor for service and repair

BATTERIES

The life of batteries used in these UPS products is estimated at 3-6 years depending on level of usage. Once the battery is no longer useful and must be replaced, please contact service personnel for assistance.

REPLACING THE BATTERY

(QUALIFIED SERVICE PERSONNEL ONLY)

CAUTION! Read and follow the IMPORTANT SAFETY INSTRUCTIONS before servicing the battery. Service the battery under the supervision of Qualified Service Personnel knowledgeable of batteries and their precautions.

CAUTION! Use only the specified type of battery. See your dealer for replacement batteries.

CAUTION! The battery may present risk of electrical shock. Do not dispose of batteries in a fire as it may explode. Follow all local ordinances regarding proper disposal of batteries.

CAUTION! Do not open or mutilate the batteries. Released electrolyte is harmful to skin and eyes and may be toxic.

CAUTION! The battery can present a high risk of short circuit current and electrical shock. The short circuit current capability of the battery is sufficient to burn wire or tools very rapidly, producing molten metal. Observe these precautions when replacing the battery:

1. Remove all watches, rings or other metal objects.
2. Only use tools with insulated handles.
3. Do not lay tools or metal parts on top of battery or any terminals.
4. Wear protective eye wear (goggles), rubber gloves, and boots.
5. Disconnect the charging source before connecting or disconnecting the battery terminals.
6. Determine if the battery is inadvertently grounded. If inadvertently grounded, remove the source of the ground. Contact with a grounded battery can result in electrical shock! The likelihood of such shock will be reduced if such grounds are removed during installation and maintenance (applicable to a UPS and a remote battery supply not having a grounded circuit).

SPECIFICATIONS

Model		R90-20KVA
Capacity		20kVA / 18Kw
Input	Phase	3 Phase / 4 Wires + Ground
	Rated Voltage	380/220VAC, 400/230VAC, 415/240VAC
	Voltage Range	208 - 478 VAC
	Frequency Range	40 - 70 Hz
	Power Factor	≥ 0.99
	Bypass Voltage Range	Max: +15% (optional +5%, +10%, +25%); Min: -45% (optional -20%, -30%); Frequency range: ± 10%
	Current Harmonic	≤ 3% (100% non-linear load)
Output	Phase	3 Phase / 4 Wires + Ground
	Rated Voltage	380/220VAC, 400/230VAC, 415/240VAC
	Power Factor	0.9
	Voltage Precision	± 2%
	Frequency	Utility Mode: ± 1%, ± 2%, ± 4%, ± 5%, ± 10% of the rated frequency (optional)
		Battery Mode: 50 / 60 Hz ± 0.2
	Crest Factor	3:1
	Transfer Time	Utility to Battery: 0ms; Utility to Bypass: 0ms
	Overload Capacity	≤ 110% = 60 min; ≤ 125% = 10 min; ≤ 150% = 1 min ≥ 150% = immediate shutdown
	Total Harmonic Distortion	≤ 2% with linear load; ≤ 5% with non-linear load
Efficiency		ECO Mode ≥ 98%; Normal Mode ≥ 95.5%
Battery	Voltage	± 192 VDC (programmable to ± 204/216/228/240 VAC)
	Charge Current	1A (programmable to 6A)
	Backup Time	over 290 minutes with (8) R90-EBP32 (optional)
Physical	UPS dimensions (W x D x H)	17.4 x 22.8 x 5.2 in (443 x 580 x 131 mm)
	UPS Weight	68.4 lbs (31 kg)
	EBP32 dimensions (W x D x H)	17.25 x 27.5 x 5.25 in (438 x 698 x 133 mm)
	EBP32 Weight	205 lbs (93 kg)
	Options	Input / Output cord kits, rack mount hardware, Maintenance bypass, Output distribution, SNMP
Environment	Operating Temperature	32 - 104°F (0-40°C)
	Humidity	0 – 95% non-condensing
	Altitude	11,500 ft (3500 m) above sea level
Approvals		CE, EN/IEC 62040-2, EN/IEC 62040-1-1

Model		R90-20KVA
Indicators & Alarms	LCD Visual Display	Individual input / output voltage & frequency, battery voltage & current; Individual & summary for kW / kVA
Communications		Local monitoring software, RS232, RS485, Parallel Port, SNMP card (optional)

BATTERY RUN TIMES USING EBP32

BATTERY RUNTIMES* for R90-20kVA

QTY of R90-EBP32	5kVA/4.5kW	10kVA/9kW	15kVA/13.5kW	20kVA/18kW
(1) R90-EBP32	18	6	2.5	<1
(2) R90-EBP32	47	18	11	6
(3) R90-EBP32	78	33	18	12
(4) R90-EBP32	110	47	30	18
(5) R90-EBP32	165	63	39	27
(6) R90-EBP32	205	80	50	33
(7) R90-EBP32	250	95	60	40
(8) R90-EBP32	290	110	70	46

**Battery runtimes are shown in minutes and will vary based on battery age and site conditions.*

Two or more EBP32 battery packs are recommended for loads over 15kVA/13.5kW.

SHIPPING LIST

R90-20K UPS

1. Software CD
2. horizontal brackets (front)
3. shelf with mounting hardware
4. manual

R90-EBP32 (OPTIONAL)

1. horizontal brackets (front)
2. shelf with mounting hardware

OBTAINING SERVICE

If the UPS requires Service:

1. Use the TROUBLESHOOTING section in this manual to eliminate obvious causes.
2. Verify there are no circuit breakers tripped.
3. Call your dealer for assistance. If you cannot reach your dealer, or if they cannot resolve the problem, call Xtreme Power Conversion Corp Technical Support at 800.582.4524 or 720.292.1217. Technical support inquiries can also be made at support@xpcc.com. Please have the following information available BEFORE calling the Technical Support Department:
 - a. Your name and address.
 - b. The serial number of the unit.
 - c. Where and when the unit was purchased.
 - d. All of the model information about your UPS.
 - e. Any information on the failure, including LED's that may or may not be illuminated.
 - f. A description of the protected equipment, including model numbers if possible.

A technician will ask you for the above information and, if possible, help solve your problem over the phone. In the event that the unit requires factory service, the technician will issue you a Return Material Authorization number (RMA).

If you are returning the UPS to Xtreme Power for service, please follow these procedures:

1. Pack the UPS in its original packaging. If the original packaging is no longer available, as the Technical Support Technician about obtaining a replacement set of packaging material. It is important to pack the UPS properly in order to avoid damage in transit. Never use Styrofoam beads for a packing material.
2. Include a letter with your name, address, daytime phone number, RMA number, a copy of your original sales receipt, and a brief description of the problem.
3. Mark the RMA number on the outside of all packages. Xtreme Power cannot accept any package without the RMA number marked on the outside of the boxes.
4. Return the UPS by insured, prepaid carrier to the address provided by the Technician.

Refer to the Warranty statements in this manual for additional details on what is covered.

XTREME POWER CONVERSION CORPORATION LIMITED WARRANTY

Xtreme Power Conversion (XPC) Corporation warrants Xtreme Power Conversion equipment, when properly applied and operated within specified conditions, against faulty materials or workmanship (excluding batteries) for a period of **two years for R90-Series products** from the date of purchase. XPC Corporation warrants **internal batteries for a period of two years** from the date of purchase. For equipment sites within the United States and Canada, this warranty covers repair or replacement, at the sole discretion of XPC Corporation. The customer is responsible for the costs of shipping the defective product to XPC Corporation. XPC Corporation will pay for ground shipment of the repaired or replacement product. This warranty applies only to the original purchaser.

If equipment provided by XPC Corporation is found to be **Dead-on-Arrival (DOA)**, XPC Corporation will be responsible for the costs of shipping product to and returning equipment from the customer in a timely manner as agreed to with the customer, once the customer has requested and received a **Return Material Authorization (RMA)** number. DOA equipment is defined as equipment that does not properly function according to user documentation when initially received and connected in conjunction with proper procedures as shown in the user documentation or via support provided by XPC Corporation personnel or authorized agents.

This warranty shall be void if (a) the equipment is repaired or modified by anyone other than XPC Corporation or a XPC Corporation approved third party; (b) the equipment is damaged by the customer, is improperly used or stored, is subjected to an adverse operating environment, or is operated outside the limits of its electrical specifications; or (c) the equipment has been used or stored in a manner contrary to the equipment's operating manual, intended use or other written instructions. Any technical advice furnished by XPC Corporation or a XPC Corporation authorized representative before or after delivery with regard to the use or application of Xtreme Power Conversion equipment is furnished on the basis that it represents XPC Corporations best judgment under the situation and circumstances, but it is used at the recipient's sole risk.

EXCEPT AS STATED ABOVE, XPC Corporation DISCLAIMS ALL WARRANTIES, EXPRESSED OR IMPLIED, INCLUDING WARRANTIES OF MERCHANTABILITY AND FITNESS FOR A PARTICULAR PURPOSE.

EXCEPT AS STATED ABOVE, IN NO EVENT WILL XPC Corporation BE LIABLE FOR DIRECT, INDIRECT, SPECIAL, INCIDENTAL, OR CONSEQUENTIAL DAMAGES ARISING OUT OF THE USE OF Xtreme Power Conversion EQUIPMENT, including but not limited to, any costs, lost profits or revenue, loss of equipment, loss of use of equipment, loss of software, loss of data, cost of substitutes, or claims by third parties..Purchaser's sole and exclusive remedy for breach of any warranty, expressed or implied, concerning Xtreme Power Conversion equipment, and the only obligation of XPC Corporation under this warranty, shall be the repair or replacement of defective equipment, components, or parts; or, at XPC Corporations sole discretion, refund of the purchase price or substitution of an equivalent replacement product.