

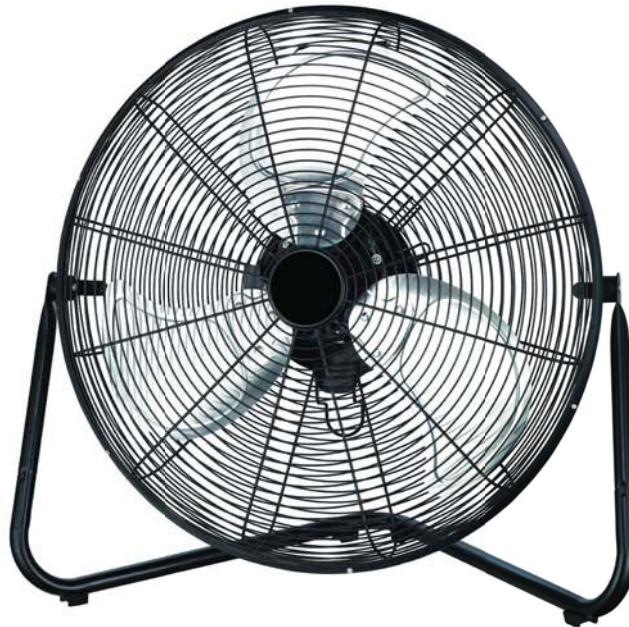

ATD-30318 / ATD-30320

18"/ 20" FLOOR FAN

INSTRUCTIONS



Item No.	Blade Diameter	Voltage / Hz	Current (A)
ATD-30318	18"/ 450mm	120V / 60Hz	1.05
ATD-30320	20"/ 500mm	120V / 60Hz	1.35



READ AND SAVE THESE INSTRUCTIONS

Failure to properly follow these instructions may lead to injury or bodily harm.

California Prop 65 WARNING:

This product contains chemicals including lead, known to the State of California to cause cancer, birth defects, or other reproductive harm. **Wash hands after handling.**

General Safety Warnings:

 **WARNING:** The instructions and warnings contained in this manual should be read and understood before using or operating this fan. Do not allow anyone to use or operate this fan until they have read this manual and have developed a thorough understanding of how this fan works. Failure to observe any of the following instructions could result in severe personal injury to fan user and bystanders, or cause damage to the fan and property. Keep this manual for future reference.

 **Note:** The warnings and cautions discussed in this instruction manual cannot cover all possible conditions and situations that may occur. It must be understood by the operator that common sense and caution are factors which cannot be built into this product, but must be supplied by the operator.

Electrical Safety Warnings:

 **WARNING:** Read all safety warnings and instructions. Failure to follow all warnings and instructions may result in electric shock, fire and/or serious injury or death.

 **WARNING:** Before connecting a fan to a power supply, always check to ensure the power supply corresponds to the voltage on the nameplate of the fan. A power supply with a voltage greater than that specified for the fan can result in serious injury to the user, as well as damage to the fan. Using a power supply with a voltage less than the nameplate rating is harmful to the motor. If in doubt, do not plug in the fan.

 **WARNING:** Grounded fans must be plugged into an outlet properly installed and grounded in accordance with all codes and ordinances. This fan is equipped with a 3-prong plug and a 3-wire grounding system. Never remove the grounding prong or modify the plug in any way. Do not use any adapter plugs. Check with a qualified electrician if you are in doubt as to whether the outlet is properly grounded.

 **NOTE:** Double insulated fans are equipped with a polarized plug (one blade is wider than the other). This plug will fit in a polarized outlet only one way. If the plug does not fit fully in the outlet, reverse the plug. If it still doesn't fit, contact a qualified electrician to install a polarized outlet. Do not change the plug in any way.

 **WARNING:** To reduce the risk of electric shock, DO NOT use in damp conditions, on wet surfaces, or expose to rain. Do not plug in this fan or operate it with wet hands or while standing in water.

 **WARNING:** Never use the cord for carrying, pulling or unplugging the fan. Grasp plug and pull to disconnect from outlet. Keep cord away from heat, oil, sharp edges or moving parts. Replace damaged cords immediately.

 **WARNING:** Ensure the switch is in the off position before plugging the fan into the power outlet. In the event of a power failure while the fan is being used, turn the switch off to prevent surprise starting when the power is restored.

 **WARNING:** Always remove the power cord from the electric outlet when making adjustments, changing parts, cleaning or working on the fan.

 **WARNING:** Care should be taken to arrange the cord so it will not be stepped on, tripped over, or otherwise subjected to damage or stress.

 **WARNING:** Never attempt to plug in or operate equipment with defective or damaged wires, power cord or power cord plug. Have any defective or damaged parts replaced immediately by qualified personnel.

 **WARNING:** Avoid body contact with electrically grounded surfaces. There is an increased risk of electric shock if your body is grounded.

 **WARNING:** If the work area is not equipped with a permanently installed Ground Fault Circuit Interrupter outlet (GFCI), use a plug-in GFCI between the fan and the power receptacle.

 **WARNING:** This fan is for **INDOOR** use **ONLY**.

 **WARNING:** Do **NOT** use extension cords with this fan.

 **WARNING:** Never operate this fan without the protective front and rear guards in place. Do not stick anything through the guards that will come in contact with the moving blades (fingers, tools, etc.). Personal injury will result.

 **WARNING:** Never use this fan with any mister or spray attachment of any kind.

Care and Maintenance:

- Unplug the appliance before cleaning.
- Do **NOT** use water directly on the fan for cleaning metal surfaces.
- Slightly moisten a cloth and then wipe off the surfaces of the fan. In order to remove the dust from the grill, use a vacuum cleaner or remove the front grill by removing the securing screw on the edge of the grill with a screwdriver.
- After cleaning, remount the grill and fasten the securing screw on the edge of the grill.

Assembly Instructions:

1. Press the button on the base

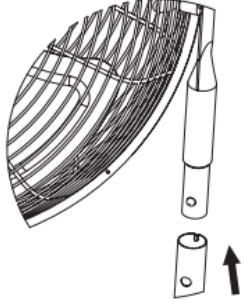

2. Insert the fan into the bracket until the button pops-up from the hole

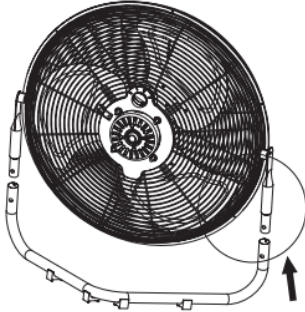

Operating Instructions:

1. Place the fan on a safe, flat surface where it cannot fall or be pulled by the cord.
2. Select desired direction of air flow by tilting the fan grill upward or downward.
3. Plug unit into electrical outlet.
4. Select preferred speed (1-Low, 2-Med., 3-High) by rotating the switch on the back of the unit.
5. Always turn off (0-Off) and unplug fan after using.

Servicing Instructions:

1. Unplug the fan by gripping the plug directly.
2. Open fuse cover.
3. Select a suitable tool, small flat screwdriver or similar tool, and insert the tip of the tool into the gap of the plug face.
4. Press the tool down, then pry the protection door of the fuse out until the fuse is fully accessible.
5. Carefully remove the fuse.
6. To avoid risk of fire, make sure replacement fuse is a 5 AMP 125 VOLT fuse.
7. Place the new fuse in the slot and carefully press down by pushing gently on the copper caps on either side. Be careful not to push too hard to avoid damage to the fuse.
8. Close fuse cover. Push the protection door back into place. If the door will not go back into original place, ensure that the fuse is properly situated. Be careful not to force the door as this could damage the fuse or the door.

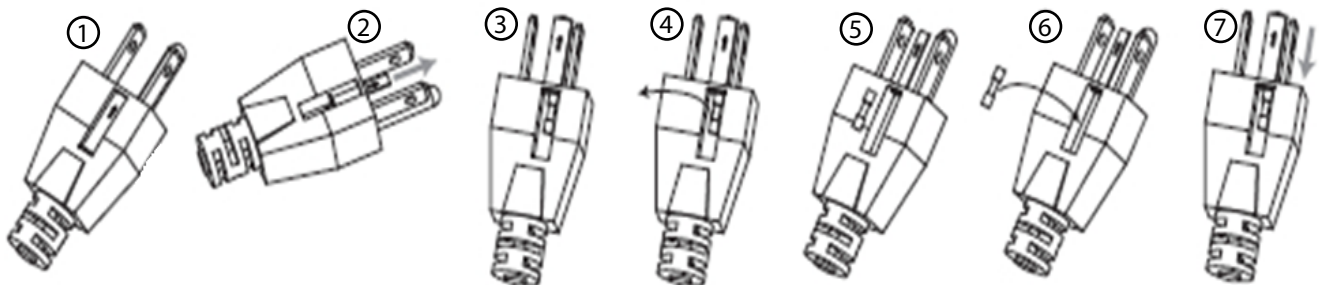



ATD-30318

ATD-30320

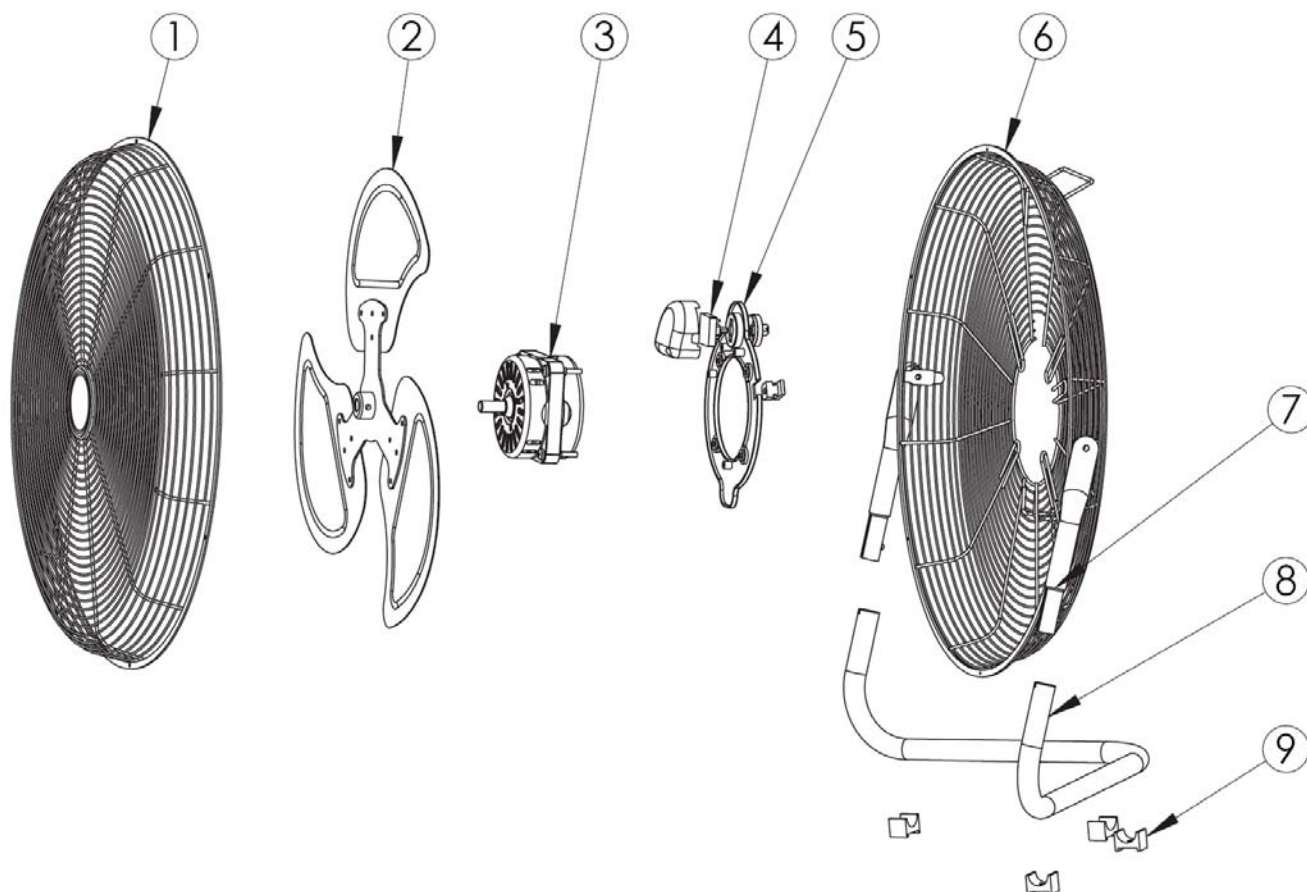

ATD-30318

ATD-30320

ITEM#	ORDERING PART#	PART DESCRIPTION
1	PRT30318-01	FRONT GUARD
2	PRT30318-02	BLADE
3	PRT30318-03	MOTOR
4	PRT30318-04	CAPACITOR
5	PRT30318-05	SWITCH
6	PRT30318-06	REAR GUARD
7	PRT30318-07	UPPER BRACKET
8	PRT30318-08	BRACKET
9	PRT30318-09	PLASTIC HOLDER

ITEM#	ORDERING PART#	PART DESCRIPTION
1	PRT30320-01	FRONT GUARD
2	PRT30320-02	BLADE
3	PRT30320-03	MOTOR
4	PRT30320-04	CAPACITOR
5	PRT30320-05	SWITCH
6	PRT30320-06	REAR GUARD
7	PRT30320-07	UPPER BRACKET
8	PRT30320-08	BRACKET
9	PRT30320-09	PLASTIC HOLDER

Please contact jay@supertestusa.com for parts and service issues