

Antec
Believe it.



ISK 100

ISK Series

USER'S MANUAL

TABLE OF CONTENTS

INTRODUCTION

1.1	Case Specifications.....	3
1.2	Diagram.....	3
1.3	Power Supply Specifications	4

HARDWARE INSTALLATION GUIDE

2.1	Removing the Left Panel	5
2.2	Motherboard Installation.....	5
2.3	Internal 2.5" Device Installation	6

CONNECTING THE FRONT I/O PORTS

3.1	USB 2.0 Ports.....	7
3.2	AC'97 / HD Audio Ports	7
3.3	Switch and LED Connectors	8
3.4	Rewiring Motherboard Header Connections.....	8
3.5	Final Steps	8

COOLING SYSTEM

4.1	2-speed Exhaust Fan	9
-----	---------------------------	---

ISK 100 USER'S MANUAL

At Antec, we continually refine and improve our products to ensure the highest quality. It's possible that your new case will differ slightly from the descriptions in this manual. This isn't a problem; it's simply an improvement. As of the date of publication, all features, descriptions, and illustrations in this manual are correct.

Disclaimer

This manual is intended only as a guide for Antec's computer enclosures. For more comprehensive instructions on installing the motherboard and peripherals, please refer to the user's manuals that come with those components.

Although care has been taken to prevent sharp edges in your Antec case, we strongly recommend taking the appropriate time and care when working with it. Avoid hurried or careless motions. Please use reasonable precaution.

This manual is not designed to cover CPU, RAM, or expansion card installation. Please consult the motherboard manual for specific mounting instructions and troubleshooting. Before proceeding, check the manual for your CPU cooler to find out if there are steps you must take before installing the motherboard. While installing hardware, keep your case on a flat, stable surface.

1.1 CASE SPECIFICATIONS

Case Type	Mini-ITX Desktop
Color	Black
Dimensions	220 mm (H) X 70 mm (W) X 210 mm (D) 8.7" (H) x 3.8" (W) x 8.3" (D)
Net Weight	3 lbs / 1.36 kg
Cooling	1 x 100 mm 2-speed side fan
Drive Bays	2 x 2.5" internal drive bays
Motherboard Size	Mini-ITX
Front I/O Panel	4 x USB 2.0 AC'97 / HD Audio In and Out
Power Supply	90-watt internal adapter

1.2 DIAGRAM

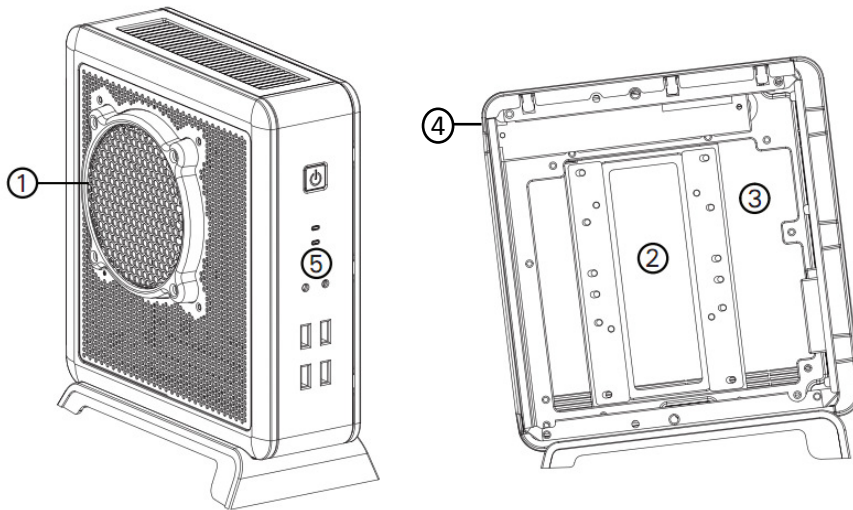

1. 1 x 100 mm 2-speed side fan
2. 2 x 2.5" internal drive bays
3. Motherboard mount – Mini-ITX
4. 90-watt power adapter port
5. Front I/O panel

Note: The ISK 100 includes a tool bag with Product Overview located inside the case.

1.3 POWER SUPPLY SPECIFICATIONS

The ISK 100 is powered by a 90-watt power adapter.

Input characteristics:

Rated Voltage	Input Voltage Range	Frequency Range
100VAC – 240VAC	90 VAC – 264 VAC	47 Hz – 63 Hz

Output characteristics:

Rated Power	Rated Voltage	Voltage Range	Output Current
90W	19V	18.4V ~ 20.0V	0A ~ 4.7A

The adapter is rated at least 85% efficient at 100 VAC and 240 VAC input voltage and maximum load.

A variety of industrial-grade safety circuitry will help protect your computer: Over Voltage Protection (OVP), Short Circuit Protection (SCP), Over Current Protection (OCP) and Over Temperature Protection (OTP). Sometimes the PSU will “latch” into a protected shutdown state. This means that you will need to power off the power supply and clear the fault before it will function again.

There are no user-replaceable fuses in the adapter.

HARDWARE INSTALLATION GUIDE

Note: Do not install the stand prior to installing hardware. You will need to remove the stand in order to access the inside of the case.

2.1 REMOVING THE LEFT PANEL

Lay the case on its right side, with the I/O panel facing you. You will be removing the left panel (the one with the fan)

1. Remove the two screws from the rear of the panel.
2. Remove the panel, making sure to lift the back portion first. If this is the first time you are opening the case, remove the drive cable bundle and tool bag from the inside of the case and set them aside.

Note: Do not use your fingernails to pry or lift the panels.



Remove these case screws

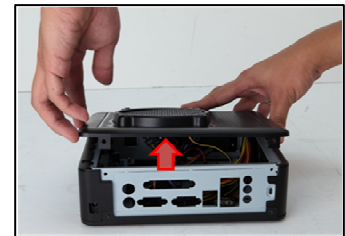

Lift the back up first

2.2 MOTHERBOARD INSTALLATION

1. Lay the case down, with the open side facing up.
2. Make sure you have the correct I/O panel for your motherboard. If the panel provided with the case isn't suitable, please contact your motherboard manufacturer for the correct I/O panel. Install the I/O panel at the rear of the case.
3. Align your motherboard with the motherboard standoff holes located at the rear of the case.
4. Screw in your motherboard to the standoffs with the provided Phillips-head screws.
5. Attach the 24-pin connector of the included cable bundle to the motherboard and connect the 18-pin connector to the already installed PCB in the case.
6. Your motherboard is now installed. Refer to section 3.1 for instructions on how to connect the I/O panel cables.



Motherboard screw locations

2.3 INTERNAL 2.5" DEVICE INSTALLATION

Note: It is important that you install the insulating sheets in step 3 to ensure that the hard drive(s) and bracket do not come into contact.

2.5" hard drives can be mounted to a bracket underneath the motherboard. To access this bracket, you will need to remove the right side panel. If you have just installed the motherboard, it can be helpful to replace the left side panel before continuing.

1. Lay the case down on its left side, and remove the right panel as described in section 2.1.
2. Remove the four screws securing the bracket to the case (see picture).



3. Attach the red insulating strips by removing the adhesive covering and attaching them as shown in the picture.

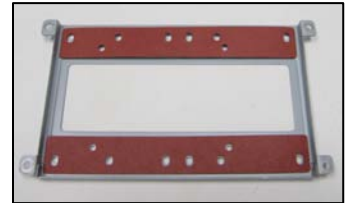

4. Align your drive(s) such that all four screw holes in the drive will be utilized.
5. Secure your hard drive(s) to the bracket using the supplied black screws. Fasten screws to the bottom of the hard drive. The top of the hard drive will face the motherboard and the back of the hard drive will face the front of the case (see picture).
6. Place the insulating sheet on the exposed part of the motherboard in the case.
7. Reattach the HDD tray to the case, and replace the four screws.
8. Connect the data and power connectors from the motherboard and power supply to the device by pulling the connections through the opening left between the motherboard and the case (see picture).

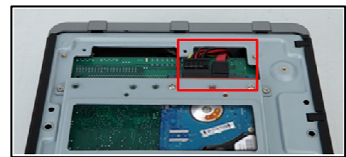

**Route HDD cables through
this gap**

CONNECTING THE FRONT I/O PORTS

3.1 USB 2.0

Connect the front I/O panel USB cables to the USB header pins on your motherboard. Check the motherboard manual to ensure that it matches the table below:

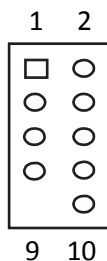

Pin	Signal Names	Pin	Signal Names
1	USB Power 1	2	USB Power 2
3	Negative Signal 1	4	Negative Signal 2
5	Positive Signal 1	6	Positive Signal 2
7	Ground 1	8	Ground 2
9	Key (No Connection)	10	Empty Pin

3.2 AC'97 / HD AUDIO PORTS

There is an Intel® standard 10-pin AC'97 connector and an Intel® 10-pin HDA (High Definition Audio) connector linked to the front panel of the case.

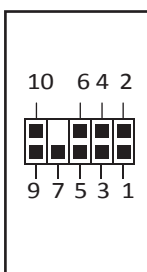

Pin	Signal Names (HDA)	Pin	Signal Names (AC'97)
1	MIC2 L	1	MIC In
2	AGND	2	GND
3	MIC2 R	3	MIC Power
4	AVCC	4	NC
5	FRO-R	5	Line Out (R)
6	MIC2_JD	6	Line Out (R)
7	F_IO_SEN	7	NC
8	Key (no pin)	8	Key (no pin)
9	FRO-L	9	Line Out (L)
10	LINE2_JD	10	Line Out (L)

You can connect either the AC'97 or the HDA connector, depending on your motherboard. Locate the internal audio connectors from your motherboard or sound card and connect the corresponding audio cable. Consult your motherboard or sound card manual for the pin-out positions. Even if your system supports both standards, only use one connector.

3.3 POWER SWITCH / RESET SWITCH / HARD DISK DRIVE LED CONNECTORS

Connected to your front panel are LED and switch leads for power, reset, and HDD LED activity. Attach these to the corresponding connectors on your motherboard. Consult your motherboard user's manual for specific pin header locations. For LEDs, colored wires are positive (+). White or black wires are negative (-). If the LED does not light up when the system is powered on, try reversing the connection. For more information on connecting LEDs to your motherboard, see your motherboard user's manual.

Note: Polarity (positive and negative) does not matter for switches.

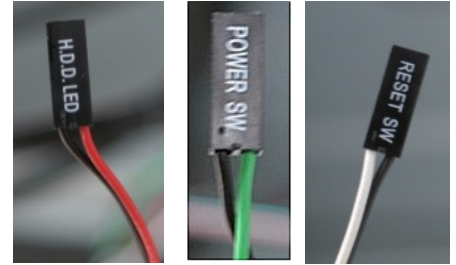

3.4 REWIRING MOTHERBOARD HEADER CONNECTIONS

There may come a time when you need to reconfigure the pin-out of a motherboard header connector. Examples could be for your USB header, audio input header, or some other front panel connector such as the Power Button connector.

Before performing any work, please refer to your motherboard user's manual or your motherboard manufacturer's website to be sure of the pin-out needed for your connector. We strongly recommend making a notated drawing before beginning work so that you can recover if your work gets disturbed.

1. Determine which wires you need to remove in order to rewire your plug to match the USB pin-outs on your motherboard (refer to your motherboard user's manual). Working on one connector at a time, use a very small flathead screwdriver or similar tool to lift up on the black tab located beside the gold posts (squares). This will allow you to easily slide out the pins from the USB plug.
2. Working carefully so as not to damage the wires, connectors, or pins, slowly remove the pin from the connector. Repeat these steps for each wire you need to change.
3. Working carefully so as not to damage the wires, connectors or pins, slowly reinsert the pin into the correct slot of the connector then snap closed the black tab that was lifted in step 1. Repeat these steps for each wire you need to change.



3.5 FINAL STEPS

1. Replace the right side panel, securing it with the two screws.
2. When you have replaced both side panels, attach the stand to the case by inserting the stand into mounting holes on the bottom of the case with the larger portion of the stand facing forward and then sliding the stand forward until it clicks into place.
3. Attach the power adapter to the port on the rear of the case. Your PC is now assembled.

COOLING SYSTEM

4.1 2-SPEED EXHAUST FAN

There is a 100 mm x 12 mm 2-speed fan preinstalled on the right-hand side of the case. It has an internal switch that allows you to choose between quiet performance or maximum cooling. The default speed setting is Low. The fan is mounted so that air blows out of the case.

Size: 100 mm x 12 mm 2-speed fan
Rated Voltage: 12V
Operating Voltage: 10.8V - 13.2V

Speed (RPM)	Input Current	Airflow	Static Pressure	Acoustic Noise	Input Power
Low 1600	0.25A	0.2 m ³ / min (7.8 CFM)	0.6 mm-H ₂ O (0.02 inch-H ₂ O)	20 dBA	3W
High 2000	0.3A	0.3 m ³ / min (20 CFM)	0.9mm-H ₂ O (0.04 inch-H ₂ O)	24.8 dBA	3.6W

Antec, Inc.

47900 Fremont Blvd.
Fremont, CA 94538
USA
tel: 510-770-1200
fax: 510-770-1288

Antec Europe B.V.

Stuttgartstraat 12
3047 AS Rotterdam
Netherlands
tel: +31 (0) 10 462-2060
fax: +31 (0) 10 437-1752

Customer Support: US & Canada

1-800-22ANTEC
customersupport@antec.com

Europe

+31 (0) 10 462-2060
europe.techsupport@antec.com

www.antec.com

© Copyright 2010 Antec, Inc. All rights reserved.
All trademarks are the property of their respective owners. Reproduction in whole or in part
without written permission is prohibited.