

# User's Manual

Wireless Gun Type 2D Image Reader





**Revision History**

Changes to the original manual are listed below:

<b>Version</b>	<b>Date</b>	<b>Description of Version</b>
1.0	2012/11/01	Initial release
1.1	2015/10/6	Corrected default length for Code39, I25

# Important Notice

No warranty of any kind is made in regard to this material, including, but not limited to, implied warranties of merchantability or fitness for any particular purpose. We are not liable for any errors contained herein nor for incidental or consequential damages in connection with furnishing, performance or use of this material. We shall be under no liability in respect of any defect arising from fair wear and tear, willful damage, negligence, abnormal working conditions, failure to follow the instructions and warnings, or misuse or alteration or repair of the products without written approval. No part of this document may be reproduced, transmitted, stored in a retrieval system, transcribed, or translated into any human or computer or other language in any form or by any means electronic, mechanical, magnetic, optical, chemical, biological, manual or otherwise, except for brief passages which may be quoted for purposes of scholastic or literary review, without express written consent and authorization. We reserve the right to make changes in product design without reservation and without notification. The material in this guide is for information only and is subject to change without notice. All trademarks mentioned herein, registered or otherwise, are the properties of their various, ill, assorted owners.

## General Handling Precautions

- Do not dispose the scanner in fire.
- Do not put the scanner directly in the sun or by any heat source.
- Do not use or store the scanner in a very humid place.
- Do not drop the scanner or allow it to collide violently with other objects.
- Do not take the scanner apart without authorization

## Guidance for Printing

This manual is in A5 size. Please double check your printer setting before printing it out. When the barcodes are to be printed out for programming, the use of a high-resolution laser printer is strongly suggested for the best scan result.

## Radio Notice

This equipment generates uses and can radiate radio frequency energy. If not installed and used in accordance with the instructions in this manual, it may cause interference to radio communications. The equipment has been tested and found to comply with the limits for a Class A computing device pursuant to EN55022 and 47 CFR, Part 2 and Part 15 of the FCC rules. These specifications are designed to provide reasonable protection against interference when operated in a commercial environment.

### Radio and Television Interference

Operation of this equipment in a residential area can cause interference to radio or television reception. This can be determined by turning the equipment off and on. The user is encouraged to try to correct the interference by one or more of the following measures:

- Reorient the receiving antenna.
- Relocate the device with respect to the receiver.
- Move the device away from the receiver.
- Plug the device into a different outlet so that the device and the receiver are on different branch circuits.

If necessary the user may consult the manufacturer, and authorized dealer, or experienced radio/television technician for additional suggestions. The user may find the following booklet prepared by the Federal Communications Commission helpful: "How to Identify and Resolve Radio-TV Interference Problems." This booklet is available from the U.S. Government Printing Office, Washington, DC 20402 U.S.A., Stock No. 004000003454.

## For CE-Countries

This scanner is in conformity with CE standards. Please note that an approved, CE-marked power supply unit should be used in order to maintain CE conformance.

## Power Supply

- Use only the type of battery and the charging equipments that came with your scanner.
- Using any other type of battery and charging equipment may damage the scanner and invalidate the warranty.
- Do not short the battery terminals. The battery could overheat.
- Do not attempt to split or peel the outer casing.
- Remove the battery if the scanner is not going to be used for a long time. If the battery is left unused for more than 3 months, you need to charge the battery before use.

## Wireless Communication

- Wireless technology operates 100M / 75M with communication cradle. Maximum communication range may vary depending on obstacles (person, metal, wall, etc.) or electromagnetic environment.
- The following conditions may affect the sensitivity of wireless communication.
  - There is an obstacle such as a person, metal, or wall between this unit and wireless device.
  - A device using 2.4 GHz frequency, such as a wireless LAN device, cordless telephone, or microwave oven, is in use near this unit.
- Because wireless devices and wireless LAN (IEEE802.11b/g) use the same frequency, microwave interference may occur and resulting in communication speed deterioration, noise, or invalid connection if this unit is used near a wireless LAN device. In such a case, perform the following.
  - Use this unit at least 10 m (about 30 ft) away from the wireless LAN device.
  - If this unit is used within 10 m (about 30 ft) of a wireless LAN device, turn off the wireless LAN device.
  - Install this unit and wireless device as near to each other as possible.
- Microwaves emitting from a wireless device may affect the operation of electronic medical devices. Turn off this unit and other wireless devices in the following locations, as it may cause an accident.
  - Where inflammable gas is present, in a hospital, train, airplane, or a petrol station
  - Near automatic doors or a fire alarm
- This unit supports security capabilities that comply with the wireless standard to provide a secure connection when the wireless technology is used, but security may not be enough depending on the setting. Be careful when communicating using wireless technology.
- We do not take any responsibility for the leakage of information during wireless communication.
- Connection with all wireless devices cannot be guaranteed.
  - A device featuring wireless function is required to conform to the wireless standard specified by wireless SIG, and be authenticated.
  - Even if the connected device conforms to the above mentioned wireless standard, some devices may not be connected or work correctly, depending on the features or specifications of the device.
- Depending on the device to be connected, it may require some time to start communication.

## Tips to help improve your wireless network

1. Position the access point (host/cradle) in a relatively empty space at central location.  
When possible, place the access point in a central location on the high ground (1m or above). If your access point is against an outside wall, the signal will be weak on the other side of the room.

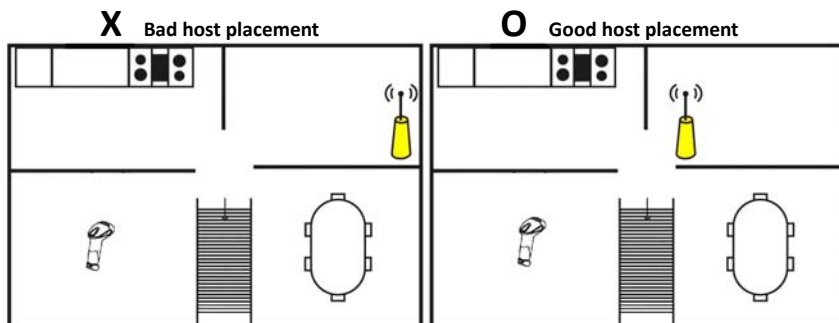

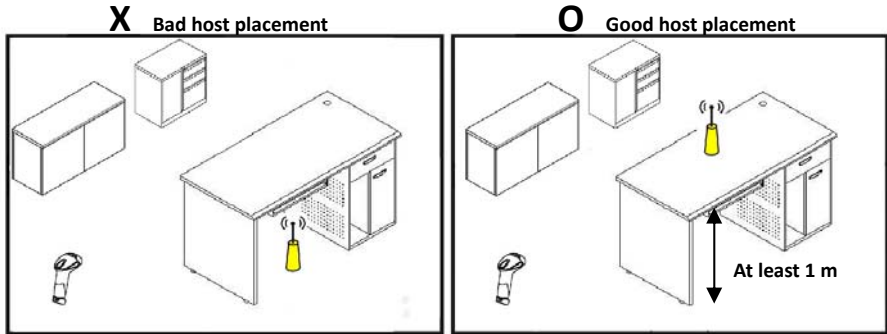

2. Move the access point (host/cradle) off the floor and away from walls and metal objects (such as metal file cabinets). Metal objects, walls, and floors will interfere with your wireless signals. The closer your access point is to these obstructions, the more severe the interference, and the weaker your connection will be.

3. Reduce wireless interference.

The most common wireless technology, 802.11g (wireless-G), operates at a frequency of 2.4 gigahertz (GHz). Many cordless phones, microwave ovens, hospital equipments, refrigerator, LED, and other wireless electronics also use this frequency. If you use these wireless devices in your office, your device might not be able to "hear" the signals over the noise coming from them.

If your network uses wireless-G, you can quiet the noise by avoiding wireless electronics that use the 2.4 GHz frequency. Instead, look for cordless phones and other devices that use the 5.8 GHz or 900 megahertz (MHz) frequencies. Because 802.11n (wireless-N) operates at both 2.4 GHz and the less frequently used 5.0 GHz frequency, you may experience less interference on your network if you use this technology.

#### Avoid possible wireless interference

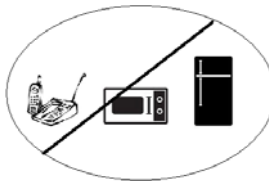

4. Update the firmware or driver of your wireless dongle.

If you are using a wireless dongle or other similar devices to make the connection, getting the latest firmware or driver updates may improve the performance. Visit your manufacturer's website for the updates.

## Table of Contents

Important Notice.....	ii
General Handling Precautions.....	ii
Guidance for Printing .....	ii
For CE-Countries.....	iii
Power Supply .....	iii
Wireless Communication .....	iv
Introduction .....	1
Product Overview .....	2
Scanner .....	2
Cradle .....	2
Scanner and Accessories .....	3
Battery Installation.....	4
Installing Cable Clip .....	5
Connecting the Cradle.....	6
Connecting the Cradle.....	7
Charging the Battery .....	8
Power on the Scanner .....	9
How to Scan .....	10
Radio Communication Host Type.....	11
Cradle Host Mode .....	11
SPP Mater/SPP Slave Mode.....	11
HID Mode .....	11
Paging the Scanner.....	12
Scanner USB online to Host .....	12
USB Online Mode .....	12
Visible Indicators .....	13
Scanner .....	13
Cradle .....	14
Sound Indicators .....	14
ACK/NAK Protocol or Frame Packing.....	15
Scanner to Remote Application.....	16
Pin-out Configuration.....	18
Cable Pin-out.....	19
Programming Guide .....	20
Connecting to a Host.....	24
Cradle Host Mode .....	25
Wireless Mode .....	26
Data Transnit Method .....	31
System Function Settings .....	34
Data Editing .....	90
Appendix 1: USB Virtual COM Driver Installation .....	98
Appendix 2: Barcode Length Setting .....	99



# Introduction

This scanner is a gun type rugged wireless 2D image reader with a state of the art image sensor. Featuring a superb scanning ability and able to withstand 1.5 meter drop, it is ideal for manufacturing and logistic sectors.

The cradle, a dongle, or devices with wireless technology can be the host of this scanner. All scanned data are instantly transferred to the connected host in a 100-meter connection range in open space or 75-meter range in indoor environments (the actual communication range may vary due to different indoor placement). This feature eliminates hazardous cables and creates a safer work environment.

Either scanning in the handheld or hands-free mode, this scanner always offers a high-accuracy and reliable scanning ability. This scanner would be your trusted tool scanning partner.

Key Features:

- Powerful image sensor yields advanced performance
- Ergonomic, rugged design
- Support multiple code formats

# Product Overview

---

## Scanner



## Cradle

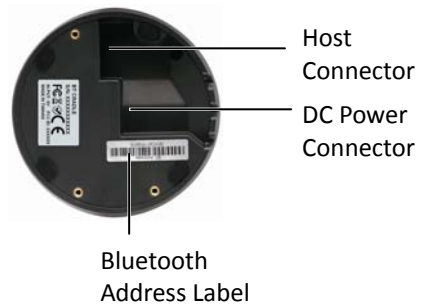
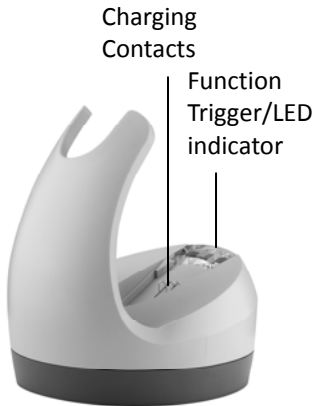

# Scanner and Accessories

---

The scanner package contains:

Wireless scanner with battery /  
Scanner cradle (optional)



Li-ion battery pack



Communication cable for cradle  
(optional)



Mini USB B to mini USB A cable



5V USB Power adapter



CD-ROM or handbook  
(Containing manual and programming guide)



Cable clip



If any contents are damaged or missing, please contact your dealer immediately.

# Battery Installation

---

## Installing Batteries

The rechargeable batteries are packed individually for shipping safety. Please follow the steps below to install the batteries.



*Always use the rechargeable batteries provided by the manufacturer to avoid any non-compatible danger or void the warranty.*

1. Unscrew the cap from the battery compartment at the bottom of the scanner and insert the battery.



2. Make sure the red tag on the battery is tugged in and not blocking the cable connector and close the cap.



3. Tighten the screw on the cap to secure the battery.

# Installing Cable Clip

Cable clip is used to hold the mini USB cable in USB Online Mode. With the cable clip, you can easily transform your wireless scanner into a wired one.

## Attaching Cable Clip

1. Insert the cable clip to the strap hole as shown.



2. Gently turn the cable clip counter-clockwise and push the cable clip all the way through the strap hole.



3. Attach the bottom part of the cable clip to the scanner handle.



4. Insert the USB cable as illustrated below.



## Removing Cable Clip

1. Detach the cable from the clip and detach the bottom part of the cable clip from the scanner handle.



2. Unhook the left part of the cable clip from the strap hole then turn it clockwise. While in turning motion, push the cable clip all the way through.



3. Remove the cable clip from the strap hole.



## Connecting the Cradle

The cradle host features wireless technology and is designed to support radio communication to the scanner. It can be used for both battery charging and radio communication.

1. Take the desirable interface cable and insert the RJ-45 connector on the bottom of the cradle. You will hear a clear and short “click” sound; then connect the other end to the host.
2. Connect the included USB cable to mini USB port at the bottom of the cradle and connect other end to USB power adaptor.
3. Connect the USB power adaptor into AC outlet. The LED indicator on the cradle should flash blue until it made connection with the scanner.

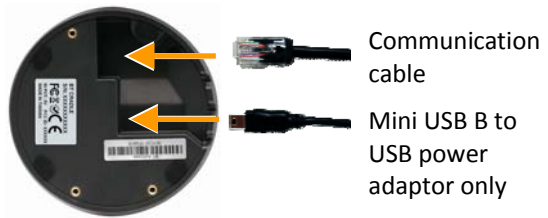

- When using Keyboard wedge and USB interface for cradle communication, it is not necessary to have an external power adapter if host has sufficient power. But these interfaces need external power adapter when charging batteries.
- The mini USB port on the bottom of the cradle should only be connected using the USB power adaptor. Please do not connect the USB cable to a PC host for charging when using the cradle.

# Charging the Battery

---

The scanner offers two different ways to charge the battery: USB Cable or Cradle.

## To charge the battery using the cradle:

1. Connect the cradle. Please see [Connecting the Cradle](#) section for more details.
2. Place the scanner on the cradle. You will hear a short beep sound from the scanner indicating scanner is in contact with the cradle.
3. The battery begins charging when the scanner LED indicator starts flashing green. LED turns steady green when charging is complete.



Approx. charging time: 4.5 hours

## To charge the battery using the USB cable:

There are two method to charge scanner via USB cable.

- Host USB Power
  - Power adaptor
1. Connect the mini USB connector directly to the scanner.
  2. Connect the other end of the USB connector to the host to begin charging. You can also connect the USB cable to an outlet using the power adaptor to charge the battery.
  3. The battery begins charging when the scanner LED indicator starts flashing green. LED turns steady green when charging is complete.





Approx. charging time: 5~6 hours



- The scanner will power on automatically when charging.
- Batteries shipped may not be full charged and should be fully charged for maximum charge capacity.
- *Recommended* charging environment is temperature in 0°C~35°C (32°F~95°F).

## Power on the Scanner

---

1. Ensure the battery is fully charged. Please refer to the previous section to charge the battery.
2. Press and hold the trigger for 1 second until a long beep sound is heard to turn on the scanner.

# How to Scan

---

There are two ways to scan with this device.

- Handheld scanning
- Presentation scanning

## Handheld scanning

1. Power on the scanner.
2. Press the trigger and aim at the barcode as illustrated.
3. When decoding is successful, the scanner beeps and the LED indicates blue.

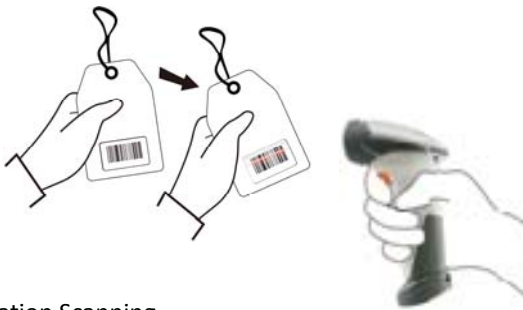

## Presentation Scanning

1. Put the scanner into the cradle for presentation scanning.
2. Move the barcode label approach the scanner scanning zone.
3. When decoding is successful, the scanner beeps and the LED indicates blue.



# Radio Communication Host Type

This scanner support three radio communication types:

- Cradle Host mode
- SPP master/slave mode
- HID mode

## Cradle Host Mode

The scanner communicates with the host through the cradle and the cradle communicates directly to the host via host interface cable connection.

**Typically, scanner and cradle in the same delivery box are paired in factory. As soon as both are powered on, they should find and connect to each other immediately.**

However, under special circumstance that the scanner and the cradle are not paired with the cradle, please See [Cradle Host Pairing](#) for detail operation information.



## SPP Mater/SPP Slave Mode

The scanner communicates with the host through wireless connection. Please see [Wireless Mode](#) for detail operation information.



## HID Mode

The scanner communicates with the smart phone through wireless HID connection. Please see [BT HID mode](#) for detail operation information



## Paging the Scanner

---

1. Ensure the cradle is properly connected to the host and LED indicator is showing steady blue.
2. Press the function trigger on the cradle. You should hear the scanner make 3 beep sounds and blue LED flash 3 times if it is in range.

## Scanner USB online to Host

---

The scanner provides other ways for you to connect to the host. When the radio communication is not available, the scanner can be connected to transmit data via USB Online mode. Please see [USB Online Mode](#) for detail operation information.

### USB Online Mode

The scanner connects directly to a USB host to recharge and transmit data.



# Visible Indicators

## Scanner

There are 2 groups of LED indicators on top of the scanner. These indicate the operational status of the scanner.

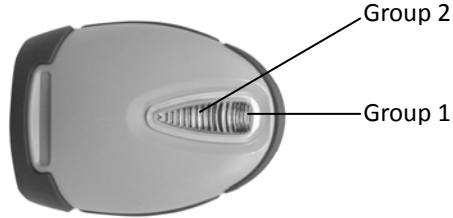

LED Status		Indication
Group_2	Group_1	
	Blue Flashing	Waiting for radio connection (flash time 0.5s : 0.5s).
	Blue fast Flashing	Radio connecting.
	Blue Slow Flashing	Device connected (flash time 0.03s : 3s).
1 Blue Flashing		A barcode was decoded successfully
Blue Fast Flashing		Data transmission
	Green Flashing	Charging mode
	Steady Green	Battery fully charged
Steady Red		Programming mode
Red flashing slow (with continuous beep sound)		Low battery warning
Red flash twice (with 2 beep sound)		Very low battery warning

## Cradle

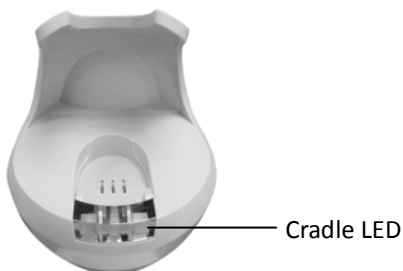

LED Status		Indication
		Red steady and blue continuous flashing Cradle is radio disconnected and power from DC adaptor is lost.
		Steady red and blue Cradle is radio connected. But lost DC power from the adaptor.
		Red and blue interchange USB Interface communication failed.
		Steady blue Cradle is radio connected.
		Blue flashing Cradle is radio disconnected.

## Sound Indicators

When the scanner is in operation, it provides audible feedback. The beeps indicate the status of the scanner.

Beep	Indication
A long beep	Power on scanner.
One beep	A barcode has been successfully decoded and data is either transfer to the host or saved in the memory.
1 high - low - high beeps	Scan cradle pair barcode.
Four short medium beeps	Data communication failed or out of range.
Intermission medium-low beeps	Low battery warning.
1 short medium – low beeps	Scanner is power down.
1 long high – medium beeps	Enter programming mode.
1 long medium - medium beeps	Exit Programming mode.

# ACK/NAK Protocol or Frame Packing

When scanner is in SPP Master/Slave mode, and add in the data protocol or packing could confirm the data reliability. Refer to below for different setting options:

a) No ACK/NAK protocol:

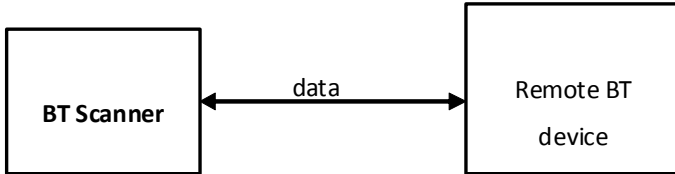

b) ACK/NAK only

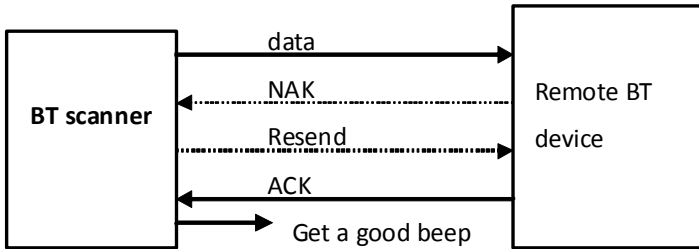

c) Frame packing:

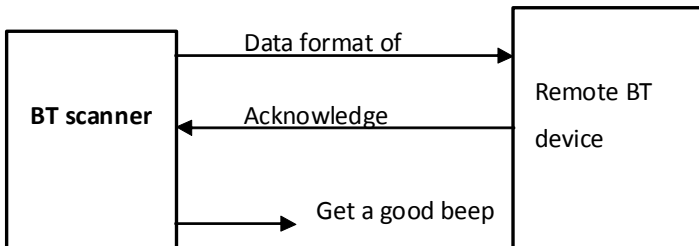

# Scanner to Remote Application

## Data Format of Packet

To send a data (barcode) to the remote application, the BT scanner has to encapsulate it:

EAH (Header)	Size of payload	FEH (Format Byte)	Data ID	Data	Barcode Type	AEH (End of Byte)	Reserved Byte
1 byte	1 byte	1 byte	1 byte	Varies	1 byte	1 byte	1 byte

Title	Definition
Header Character (EAH)	The character ID at the head of every data. It has to start with EAH.
Size of Payload	The encapsulated data length excluding header character.
Format Byte (FEH)	Differentiate data format; barcode data is always FEH.
Data ID	The number of each data. If receive the same ID more than once, only the first one is valid, delete the rest.
Barcode Type (1 byte)	Please refer to the <a href="#">Barcode Type Table</a> .
Data	Decoded barcode data.
End of Byte (AEH)	Record data ends.
Reserved Byte	Reserved for future use.

Example:

If Code39 barcode data is "ABCD", then sender sends out:  
EAH + 0AH + FEH + ID + "ABCD " + 11H+AEH + Reserved Byte

$$0AH = 1+1+1+4+1+1+1$$

## Acknowledge packet

55H (Header )	Data ID	55H (end of byte)
1 byte	1 byte	1 byte

Example:

If scanner sends out:

EAH , 0AH , FEH , 01H , "ABCD " , 011H, AEH , EEH

Remote acknowledges: 55H +01H + 55H



Barcode Type Table

Code	Value
Code39	0x11
Codabar	0x01
Code128	0x03
Interleaved 2/5	0x02
Code93	0x06
UPC-E	0x14
UPC-A	0x24
EAN-8	0x34
EAN-13	0x44
Chinese Post Code	0x05
MSI	0x07

# Pin-out Configuration

---

Scanner mini USB Pin-Out Configuration	
PIN 1.	+5V
PIN 2.	USB_D-
PIN 3.	USB_D+
PIN 4.	NC
PIN 5.	GND

Cradle Phone Jack Pin-Out Configuration			
RJ 1.	RTS_EIA	RJ 6.	RX_EIA
RJ 2.	KB Data / USB_D+	RJ 7.	KB Clock
RJ 3.	PC Clock / USB_D-	RJ 8.	+5V
RJ 4.	GND	RJ 9.	PC Data
RJ 5.	CTS_EIA	RJ10.	TX_EIA

Cradle Mini USB Pin-Out Configuration	
PIN 1.	DC+5V
PIN 2.	NC
PIN 3.	NC
PIN 4.	NC
PIN 5.	GND

# Cable Pin-out

## 1. Keyboard Wedge Cable (for PS/2)

	PIN-OUT CONFIGURATION			
	MINI DIN (M)		MINI DIN(F)	
	DIN	FUNCTION	DIN	FUNCTION
	1.	PC Data	1.	KB Data
	2.	N.C.	2.	N.C.
	3.	GND	3.	GND
	4.	+5V	4.	+5V
5.	PC Clock	5.	KB Clock	
6.	N.C.	6.	N.C.	

## 2. RS-232 Cable (DTE pin out)

	PIN-OUT CONFIGURATION	
	DB-9 (F)	FUNCTION
	2	TX
	3	RX
	7	CTS
	8	RTS
	5	GND
9	+5V	

## 3. RS-232 Cable (DCE pin out)

	PIN-OUT CONFIGURATION	
	DB-9 (F)	FUNCTION
	2	RX
	3	TX
	7	CTS
	8	RTS
	5	GND
9	+5V	

## 4. USB / Virtual COM USB / OPOS USB Interface with Detachable Cable Type A

	USB TYPE A CONNECTOR	FUNCTION
	1.	VCC
	2.	D-
	3.	D+
	4.	VSS

# Programming Guide

## Program Procedure Using Barcode Manual

1. Power up the scanner.
2. Scan the Start of Configuration barcode.
3. Scan the barcode for the desired feature. Multiple features can be enabled/disabled before scanning the End of Configuration barcode.
4. Scan the End of Configuration barcode and save the new configuration.
5. To give up a configuration change, power off the scanner before scanning the End of Configuration barcode or scan the Abort barcode.
6. For some parameter setting, such as barcode length and identifier code, it is required to scan the Set barcode to save the configuration.

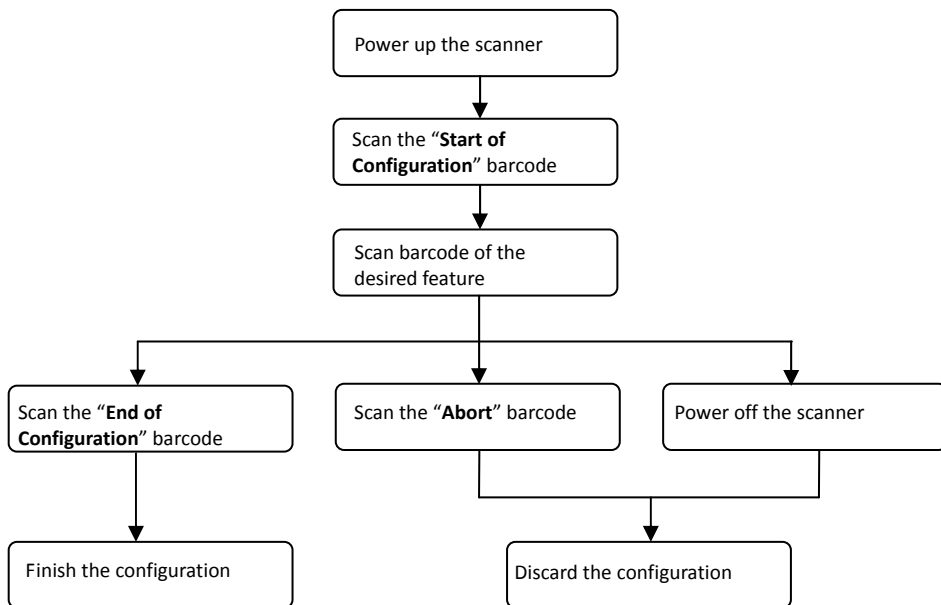

# Default Parameters

The factory default setting table gives the default settings of all the programmable parameters. The default settings will be restored whenever the "Reset" programming label is scanned and the scanner is in programming mode. Default values are highlighted in grey background in the settings.

## Factory Default Setting

Parameter	Default
<b>Radio communication</b>	
Wireless host	Cradle Host
Pairing mode	Unlocked
Data transmit	Normal
Radio protocol timeout	5 seconds
Power off timeout	20 minutes
Encryption	Enable
<b>Cradle Host</b>	
<b>RS-232 communication</b>	
Baud rate	9600
Parity	none
Data bits	8
Stop bit	1
RTS/CTS	off
Terminator	<CR><LF>
<b>Keyboard Wedge Communication</b>	
Terminator	PC/AT
Keyboard	US keyboard
Terminator	Enter(Alpha numeric)
<b>USB Communication</b>	
Terminator	Enter
Code mode	Scan code
Keyboard	US keyboard
<b>Wand Emulation</b>	
Wand emulation speed	Normal
Data output	Black=high
<b>Pair contact on cradle</b>	Enable
<b>Scanner</b>	
<b>Decoder Selection</b>	<b>Default</b>

EAN/UPC	Enable
CODE 39	Enable
Code 32	Disable
CODABAR	Enable
ITF 2 OF 5	Enable
MSI	Disable
Chinese post code	Disable
Code 93	Enable
Code 128	Enable
EAN-128	Disable
Telepen	Disable
Code 11	Disable
Standard 2 of 5	Disable
Industrial 2 of 5	Disable
GS1 DataBar	Disable
<b>Beeper Sound</b>	<b>Default</b>
Frequency	Medium
Duration	Medium
<b>Operating Parameter</b>	<b>Default</b>
Scan mode	Trigger mode
Stand mode	Enable
Header and trailer	None
Inter-message delay	None
Inter-character delay	None
<b>Code Identifiers</b>	<b>Default</b>
Identifier code as ZEBEX standard	Disable
Identifier code as AIM standard	Disable
Code 39 identifier code	M
ITF 2 of 5 identifier code	I
Chinese post code identifier code	H
UPC-A identifier code	A
UPC-E identifier code	E
EAN-13 identifier code	F
EAN-8 identifier code	FF
Codabar identifier code	N
Code 128 identifier code	K
Code 93 identifier code	L

MSI identifier code	P
Code 11 identifier code	O
Standard 2 of 5 identifier code	S
Industrial 2 of 5 identifier code	D
GS1 DataBar identifier code	RS
GS1 DataBar Limited identifier code	RL
GS1 DataBar Expanded identifier code	RX

### Default Data Transmit Format

Code	Message format
EAN-13	D1 D2 D3 D4 D5 D6 D7 D8 D9 D10 D11 D12 D13
EAN-8	D1 D2 D3 D4 D5 D6 D7 D8
UPCA	D1 D2 D3 D4 D5 D6 D7 D8 D9 D10 D11 D12
UPCE	D1 D2 D3 D4 D5 D6 D7 D8
CODE128	D1-Dx (default 3~62)
EAN128	C1 D1-Dx (default 3~62)
CODE39	D1-Dx (default 3~62)
CODABAR	D1-Dx (default 6~32)
INTERLEAVED 2/5	D1-Dx (default 14)
CHINESE POST CODE	D1-Dx (default 8~32)
CODE93	D1-Dx (default 4~55)
MSI	D1-Dx (default 6~32)

## Connecting to a Host

---

The scanner provides several data transmit methods to communicate with the host. User may select the method according to their preferences. Read this section to learn the setups for connecting to different hosts.



Start Of Configuration

---

### USB Online Mode

The scanner connects directly to a USB host to recharge and transmit data. You may enable or disable the functions using the following settings.

#### Disable USB communication



USB online scan disable

Disable USB communication

#### Enable USB communication



USB online scan enable

Wireless connection as the primary communication option to the host. USB connection is only used when wireless is disconnected

#### Set USB as the primary connection



USB online scan, Ignore radio communication

USB connection as the primary communication option to the host when it is available. Wireless mode is set as the secondary option



End Of Configuration

---





## Start Of Configuration

---

### Cradle Host Mode

The scanner communicates with the host through the cradle. Typically, scanner and cradle in the same delivery box are paired and corresponded to host interface in factory. To check if the scanner is paired to the cradle, check the scanner LED group1 for slow blue flash and check the top cradle LED for steady blue light. If LED group1 of scanner and top LED of cradle are both flashing blue, follow the steps below to radio connect the scanner and cradle.

#### Cradle Host Pairing

1. See [Connecting the Cradle](#) to connect the cradle and the computer. Please make sure the cradle LED is flashing blue indicating it's not linked to any scanner. If the LED shows steady blue, the cradle is already paired to another scanner so you must unpair the scanner before continuing.
2. Power on the scanner and enable cradle host mode if necessary.



Enable cradle mode with this set

Cradle Host mode enable

3. Use the scanner to scan the pairing barcode at the bottom of the cradle to begin pairing. 3 short beeps will be heard.
4. The LED indicator on the scanner will flash blue rapidly indicating search mode in process. The LED on the cradle becomes steady blue when the pairing is successful.
5. Scan the corresponding host interface the cradle is using to begin using the scanner.



Return to USB default

Return to cradle USB communication  
(Communication cradle link required)



Return to wand  
emulation default

Return to cradle wand emulation  
(Communication cradle link required)



Return to RS232 default

Return to RS232 cradle communication  
(Communication cradle link required)



IBM PC/AT/PS/2 Keyboard  
emulation

Cradle IBM PC/AT/PS/2 Keyboard emulation  
(Communication cradle link required)



## End Of Configuration

---



## Wireless Mode

The scanner connects to the host via wireless connection. You may select SPP Master or SPP Slave for PC connection or select HID mode and Smart phone mode for smart phone connection.

### SPP Slave Mode

In this mode, the scanner connects to the host /PC via wireless connection and performs like there's a serial connection. In SPP Slave mode, the scanner is discoverable from a remote device and it can request the scanner for connection. There are several ways to connect the wireless scanner to your PC. If you have your own applications please check their User's Manuals for pairing instructions.

To connect a wireless device to Window based system for the first time:

1. Turn on the host computer and activate its wireless connection.
2. Select "Add wireless device". Or open the dialog BT devices and click "Add".
3. Power on the scanner and program it with "SPP Slave mode" label.



Enable wireless SPP Slave mode

Scanner SPP Slave enable

4. On Devices tab, click Add. This will open the Add wireless Device Wizard.
  5. Select the "My device is set up and ready to be found" checkbox, and then click Next.
  6. The scanner should be on the list of discoverable devices. The default name of the scanner is "ZBBT". Select "ZBBT" and click "Next".
  7. Select "Let me choose my own passkey" and enter the pin code. The default pin code is "12345678".
  8. Click "Next" to connect the scanner to the host. A short beep should be heard upon connection.
- 





## Start Of Configuration

SPP Master Mode

In this mode, the scanner connects to the host /PC via wireless connection and performs like there's a serial connection. In master mode, the scanner initiates the connection to the remote device.

1. Power on of the remote device and have its address ready in hand and make it discoverable.
2. Program the scanner with the "SPP Master enable" barcode.



Scanner SPP Master enable

Enable SPP Master mode.

3. Scan "Set wireless address" to set the address.

Set wireless address  
(SPP Master only)Set wireless address for SPP Master  
connection.

4. Use the ASCII table in Programming Guide to input the 12 digit wireless address. For example: if the address is "011B1345600", scan "0", "0", "1", "1", "B", "1", "3", "4", "5", "6", "0", "0" from ASCII barcode labels.
5. Scan "Confirm Setting" to store the address.

Confirm Setting (for address and pin code  
setting required)

6. Setup and input the pin code if necessary. Please see [Setting Pin Code](#) section for more details.
7. Scan "Required Pair with slave (SPP Master)" to begin pairing.



Required Pair with slave (SPP Master)



In SPP Master mode, you can print out a Code39 label of the wireless address in "BxxxxxxxxxxT" format and scan it with the scanner instead of using the ASCII table.



## End Of Configuration



Start Of Configuration

BT HID mode

In BT HID mode, the scanner connects to the host /PC via wireless connection and performs like there's a keyboard connection. The scanner initiates the connection to the remote device.

1. Power on the scanner and program it with "BT HID Mode". To connect a smart mobile phone (for example, iPhone, Android), the Smart phone mode must also be enabled.



BT HID mode

Enable wireless HID keyboard emulation



Smart phone mode

For smart phone mode (BT HID MODE must also be enabled)

2. Enable wireless connection on your host and follow the instructions in your host to set it to discover other wireless devices in its surrounding.
3. The scanner should be on the list of discoverable devices. The default name of the scanner is "ZBBT". You will be prompt to enter pairing pin code. Select "ZBBT" and input the pin code that appears on your mobile device to connect scanner to the phone.
4. Scan the Enter barcode to confirm. A short beep should be heard upon connection.



Enter  
Full ASCII ---CR  
Function key-----"Enetr(num.)"



End Of Configuration



## Start Of Configuration

---

### Setting Pin Code

1. To change the pin code, use the "Set pin code" setting. Default is "12345678".
2. Use the ASCII table in Programming Guide to input the new code (must be at least 4 digits and not more than 8 numeric digits).
3. Scan "Save Setting" to store the pin code.



Set pin code

Set pin code (SPP Master only)



Confirm Setting (for address and pin code setting required)



Please check the User's Manual from your PC for wireless address and pin code.

### Deleting pin code

To delete pin code, use the "Delete pin code setting".



Delete pin code

Delete the stored pin code

### Reset Name

To change the scanner name back to the default name "ZBBT" use the "Default device name" setting.



Default device name

Change device name back to default "ZBBT"



## End Of Configuration

---



Start Of Configuration

---

Setting Name

1. To change the name displayed when the scanner is discovered, scan the “Friendly device name set” label. Default name is “ZBBT”.
2. Use the ASCII table in Programming Guide to input the name (Max.12 digits).
3. Scan “Confirm Setting” to store the new name.

  
 Friendly device name set

Change the display name when scanner is discovered

	Confirm Setting (for address and pin code setting required)
---	---

Wireless Discovery

Use the following settings to show or hide the device from wireless discovery.

  
 Discover enable

Make scanner visible to wireless device

  
 Discover disable

Make scanner invisible to wireless device



End Of Configuration

Start Of Configuration

---

## Data Transnit Method

The data transfer method includes three types: Normal (default), Out-of-Range Mode, and Batch Mode. Users may modify this setting according to their preferences.

### Normal

When the scanner is within the connection range, the scanned data will be transferred to the host computer immediately. If the scanner is out of its connecting range, the scanner does not send or store any data.



Data transmit normal

Batch mode is disabled

### Out of Range

Scanned data are stored when scanner is out of its wireless communication range. When scanner is back into its communication range or re-connected, the stored data are sent when scanning next barcode label.

Out of range buffer  
enable

Enable out of range mode



End Of Configuration



Start Of Configuration

---

Batch Mode

Whether within the connection range or not, in batch mode, the scanner stores all scanned data that will be transferred to the host computer after scanning "Send Batch Data" label.

Number of storable bar codes = 61,365 bytes of memory / (number of characters in the bar code +2)



Batch mode

Note: Scanner LED indicator will not flash while waiting for connection in this mode

Clearing Batch

Use the settings in this section to clear the stored data.



Clear batch data after send

Saved data are cleared after they are transferred to the host



Clear batch data by scanning "Delete batch data" label

Scan this label then scan "Save Setting" to delete the stored batch data



Delete batch data

Same as previous setting but with alert sound



Confirm Setting (for address and pin code setting required)



End Of Configuration





## Start Of Configuration

---

### Batch Transfer

Use the settings in this section to setup batch transfer.



Send Batch Data By  
Scanning Label

Scanning this label automatically exits you from the Programming Mode. Press and hold the trigger for over 1 second to send the data



Send Batch Data on line  
USB cable contact

Data is ready to be transferred upon USB connection. Press and hold the trigger for over 1 second to send the data



Send Batch data on cradle

Data is ready to be transferred upon placement on the cradle. Press and hold the trigger for over 1 second to send the data (Cradle radio connected is required)

### Batch Mode Sounds Settings

Use the settings in this section to setup the sound.



Out of range resend data  
with beeper sound

Add beeper sound when resending data in Out of range mode



Out of range resend data  
without beeper sound in  
Out of range mode.

No beeper sound when resending data



Send Batch Data without  
beep

No beep when sending data. Good-read LED will light up until the transfer is done



Send Batch Data with Beep

Beep sound when sending data. Good-read LED will light up until the transfer is done



## End Of Configuration

---

# System Function Settings

---

Default values are highlighted in grey background.



Start Of Configuration

---

**Barcode Value**

**Description**



Return scanner to factory defaults



Return cradle host to factory defaults



Return to USB default  
(Communication cradle link required)



Return to wand emulation default  
(Communication cradle link required)



Return to RS232 default  
(Communication cradle link required)



IBM PC/AT/PS/2 keyboard emulation  
(Communication cradle link required)



Return as USB-virtual COM port default



Return to stand-alone keyboard default



Return as OPOS port default



End Of Configuration

---



Start Of Configuration

---

### Barcode Value

### Description



Display firmware version



Abort  
(exit programming mode without any updates)

### Scan Mode



Trigger mode  
The scanner becomes inactive as soon as the data is transmitted. It must be triggered to become active again



Auto scan mode  
The scanner is still active after the data is transmitted but the successive transmission of the same barcode is not allowed when the trigger switch is pressed again



Alternate mode  
The scanner illumination alternates between on and off when the trigger switch is pressed



Presentation mode  
Also called auto trigger mode. The scanner is inactive but will automatically detect barcodes presented in the scan zone and become active



Idle mode enable



Idle mode disable  
Disable Idle mode

---



End Of Configuration



Start Of Configuration

---

Radio Communication Setting

**Cradle Host mode**



Cradle Host mode enable  
Enable cradle mode with this setup



Unlock pairing mode  
In this mode, the scanner can pair with another cradle when disconnected



Lock pairing mode.  
In this mode, the scanner can not pair with another cradle



Undo pairing  
Undo the pairing between the cradle and the scanner



Scanner On Cradle sound alert enable  
Enable beep sound alert when scanner is placed on cradle



Scanner On Cradle sound alert disable  
Disable beep sound alert when scanner is placed on cradle



On Cradle Auto-Scan mode enable  
Enable Auto-Scan when scanner is placed on cradle



On Cradle Auto-Scan mode disable  
Disable Auto-Scan when scanner is placed on cradle



End Of Configuration



Start Of Configuration

---

### USB Online mode



USB online scan disable



USB online scan enable



USB online scan, ignore radio communication

### BT HID mode



BT HID mode (Combo keyboard)



For Apple mode (Must execute BT HID mode first)

### SPP Master/Slave mode



Scanner SPP Master enable  
SPP Master (Connect wireless address  
"BxxxxxxxxxxT" in CODE39 format)



Scanner SPP Slave enable



Setting wireless address (SPP Master only)



Set PIN code (SPP Master only)



End Of Configuration

---



Start Of Configuration



Default Device name



Friendly device name set



Delete pin code



Confirm Setting (for address, device name, and pin code setting required)



Required Pair with slave (SPP Master)



Discover enable



Discover disable



Encryption enable



Encryption disable



Data communication without protocol



Data communication with ACK/NAK protocol



Data communication with Packing protocol



End Of Configuration



Start Of Configuration

---

### Data Transmit Mode

Data transmit normal



Out of range buffer enable



Batch mode



Send Batch Data By Scanning Label



Clear batch data after send



Clear batch data by scanning "Delete batch data" label



Delete batch data



Send Batch Data on line USB cable contact.



Send Batch data on cradle



Out of range resend data with beeper sound



Out of range resend data without beeper sound



Send Batch Data without Beep



Send Batch Data with Beep



End Of Configuration

---



Start Of Configuration

---

Radio protocol communication parameter



Radio protocol timeout= 3 sec



Radio protocol timeout= 5 sec



Radio protocol timeout =8 sec



Radio protocol timeout= 10 sec



Radio protocol timeout =13 sec



Radio protocol timeout =16 sec



Radio protocol timeout= 20 sec



End Of Configuration



Start Of Configuration

---

Power off timeout parameter



Power off timeout=5 min



Power off timeout=10 min



Power off timeout=20 min



Power off timeout=30 min



Power off timeout=1 hr



Power Off timeout : 2 hr



Power Off timeout : 4 hr



Power Off timeout : 6 hr



Power Off timeout : 8 hr



End Of Configuration



Start Of Configuration

---



Power Always On



Power off by scanning this label



Link beeper enable



Link beeper disable



Power-up beeper enable



Power-up beeper disable

**Same Code Delay**



50 msec



100 msec



200 msec



300 msec



End Of Configuration



Start Of Configuration

---



400 msec



500 msec



600 msec



700 msec



800 msec



1000 msec



Infinite



End Of Configuration



Start Of Configuration

---

Operation Function Setting

**Good Read Beeper Tone Selection**



Medium beeper tone



High beeper tone



Low beeper tone



Speaker disable



End Of Configuration



Start Of Configuration

---

### **Beeper Duration Selection**



Long



Medium



Short



Ultra Short



Ultra Long



End Of Configuration

---



Start Of Configuration

---

Vibration Parameter

(Optional function, available only for customers of special request )



Good read vibrator enable



Good read vibrator disable



Good read beeper and vibrator enable



Vibration duration=100msec



Vibration duration=200msec



Vibration duration=300msec



Vibration duration=400msec



Vibration duration=500msec



Vibration duration=1 second



Vibration duration=2 second



Vibration duration=3 second



Vibration duration=4 second



Vibration duration=5 second



End Of Configuration



Start Of Configuration

---



**Inter Character Delay**

0 ms



2 ms



5 ms



10 ms



20 ms



50 ms



**Inter Message Delay**

0 ms



100 ms



500 ms



1000 ms



End Of Configuration

---



Start Of Configuration

Interface Settings

**1. RS-232C Interface Setting**

**Baud Rate**



115200



19200



9600



4800



2400



1200

**Parity Bit**



Even parity



Odd parity



Mark parity



Space parity



None parity

**Stop Bit**



1 stop bit



2 stop bit

**Data Bit**



7 data bit



8 data bit



End Of Configuration





Start Of Configuration

---

### Handshaking Protocol



None handshaking



ACK/NAK



Xon/Xoff



RTS/CTS



Enable BEEPER ON<BEL> CHARACTER



Ignore Beep on<BEL> character



ACK/NAK response time 300ms



ACK/NAK response time 2 sec



ACK/NAK response time 500 ms



ACK/NAK response time 3 sec



ACK/NAK response time 1 sec



ACK/NAK response time 5 sec



ACK/NAK response time infinity



End Of Configuration

Start Of Configuration

---

**Message Terminator**

RS-232 message terminator—none



RS-232 message terminator—CR/LF



RS-232 message terminator—CR



RS-232 message terminator—LF



RS-232 message terminator—H tab



RS-232 message terminator—STX/ETX



RS-232 message terminator—EOT



## End Of Configuration



Start Of Configuration

---

## 2. Keyboard Wedge Setting

### Keyboard Wedge Setting



IBM PC/AT/PS/2 Keyboard emulation



International Keyboard mode ( ALT method)



Keyboard language support---USA



Keyboard language support---UK send scan code



Keyboard language support---GERMANY



Keyboard language support---FRENCH send scan code



Keyboard language support---SPANISH send scan code



Keyboard language support---ITALIAN send scan code



Keyboard language support---Switzerland send scan code



Keyboard language support---Belgium send scan code



Keyboard language support---Japanese



Capital lock on



Capital lock off



Function key emulation enable



Function key emulation disable



Send number as normal data



Send number as keypad data



End Of Configuration

---



Start Of Configuration

---



**Message Terminator**

Keyboard terminator---none



Keyboard terminator---Enter



Keyboard terminator---H-TAB



End Of Configuration



Start Of Configuration

### 3. USB Interface Setting

#### USB interface



International Keyboard mode ( ALT method)



Keyboard language support---USA



Keyboard language support---GERMANY



Keyboard language support---FRENCH send scan code



Keyboard language support---SPANISH send scan code



Keyboard language support---JAPANESE



Keyboard language support---ITALIAN

#### Message Terminator



Keyboard terminator---none



Keyboard terminator---Enter



Keyboard terminator---H-TAB



End Of Configuration



Start Of Configuration

---

#### 4. Wand Emulation Setting

Wand emulation is not supported as standard, if needed, please contact your distributor. (Code128, Code93 not supported)

##### Wand Emulation



All barcode will be decoded and transmitted in that symbology



Enable Wand output data format as CODE39



Wand emulation data output black=high

- Scan this bar code to set quiet zones and spaces low and bars =high



Wand emulation data output black=low

- Scan this bar code to set quiet zones and spaces high and bars=low



Idle = high

- Idle state refers to the TTL logic level of the Wand Emulation signal when not in use



Idle = low

- Idle state refers to the TTL logic level of the Wand Emulation signal when not in use



End Of Configuration



Start Of Configuration

---

### Wand Emulation (Cont'd)



Wand emulation speed-----Low

- This option allows the transmission of wand emulation at 1ms narrow element width



Wand emulation speed-----medium

- This option allows the transmission of wand emulation at 600us narrow element width



Wand emulation speed-----high

- This option allows the transmission of wand emulation at 300us narrow element width



Wand emulation speed-----higher

- This option allows the transmission of wand emulation at 100 us narrow element width



End Of Configuration



Start Of Configuration

---

## 5. Smart Phone Software Keypad Control Setting

Smart Phone Software Keypad Control



Multi-media keyboard mode

- This option enables Multi-media keyboard mode



Software keypad enable/disable

- This option enable or disable Software keypad

To enable/disable Software keyboard:

1. Scan the Start Of Configuration barcode.
2. Scan the Multi-media keyboard mode barcode.
3. Scan the End Of Configuration barcode.
4. Connect the scanner with a smart phone. Please see [BT HID mode](#) for instructions.
5. With Multi-media keyboard mode enabled and smart phone connection made, you may scan the Software keypad enable/disable barcode to enable or disable the Software keypad.



End Of Configuration





Start Of Configuration

## The Symbolologies

### 1. Codabar Parameter Setting

Barcode Value	Barcode Label	Description
RC02		Codabar enable
RD02		Codabar disable
CB05		Codabar start/stop character transmission — none
CB06		Codabar start/stop character transmission — A,B,C,D
CB07		Codabar start/stop character transmission — DC1~DC4
CB08		Codabar start/stop character transmission — a/t,b/n,c/* ,d/e
CB09		Codabar maximum length setting
CB10		Codabar minimum length setting

SET



Confirm to save this setting (required for reading full ASCII table and length setting)



End Of Configuration



Start Of Configuration

Barcode Value	Barcode Label	Description
CB13		No check character
CB14		Validate modulo 16, but don't transmit
CB15		Validate modulo 16 and transmit
CB18		Codabar CLSI Editing enable When enabled, this parameter strips the start and stop characters and inserts a space after the first, fifth, and tenth characters of a 14-character Codabar symbol. Enable this feature if the host system requires this data format
CB19		Codabar CLSI Editing disable
CB20		Codabar Notis Editing enable When enabled, this parameter strips the start and stop characters from a decoded Codabar symbol. Enable this feature if the host system requires this data format
CB21		Codabar Notis Editing disable
DC50		Codabar data redundant check=off
DC51		Codabar data redundant check=1
DC52		Codabar data redundant check=2
DC53		Codabar data redundant check=3



End Of Configuration



Start Of Configuration

## 2. Code 39 Parameter Setting

Barcode Value	Barcode Label	Description
RC01		Code 39 enable
RD01		Code 39 disable
RC13		Code 32 enable
RD13		Code 32 disable
DC00		Code 39 data redundant check=off
DC01		Code 39 data redundant check=1
DC02		Code 39 data redundant check=2
DC03		Code 39 data redundant check=3
RC30		Code39 Trioptic enable
RD30		Code39 Trioptic disable
3919		Code39 Buffering (Scan & Store) enable This feature allows the decoder to accumulate data from multiple Code 39 symbols
3920		Code39 Buffering (Scan & Store) disable



End Of Configuration



Start Of Configuration

Barcode Value	Barcode Label	Description
3901		Standard code 39
3902		Full ASCII code 39
3903		Code 39 start/stop character transmission
3904		Code 39 start/stop character without transmission
3905		Code 39 check digit calculate and transmit
3906		Code 39 check digit calculate but without transmit
3907		No check character
3908		Code 39 maximum length setting
3909		Code 39 minimum length setting
SET		Confirm to save this setting (required for reading full ASCII table and length setting)
3912		Code 32 (Italian pharmacy) transmit "A" character
3913		Code 32 (Italian pharmacy) without transmit "A" character



End Of Configuration



Start Of Configuration

### 3. Code 93 Parameter Setting

Barcode Value	Barcode Label	Description
RC08		Code 93 enable
RD08		Code 93 disable
DC30		Code 93 data redundant check=off
DC31		Code 93 data redundant check=1
DC32		Code 93 data redundant check=2
DC33		Code 93 data redundant check=3
9301		Code 93 maximum length setting
9302		Code 93 minimum length setting
SET		Confirm to save this setting (required for reading full ASCII table and length setting)
9303		Code 93 check digit calculate but without transmit
9304		Code 93 check digit not calculate and without transmit
9305		Code 93 check digit calculate and transmit



End Of Configuration



Start Of Configuration

4. Code 128 Parameter Setting

Barcode Value	Barcode Label	Description
RC06		Code 128 enable
RD06		Code 128 disable
RC10		EAN-128 enable
RD10		EAN-128 disable
DC40		Code 128 data redundant check=off
RC31		ISBT-128 enable
RD31		ISBT-128 disable
DC41		Code 128 data redundant check=1
DC42		Code 128 data redundant check=2
DC43		Code 128 data redundant check=3
1803		No check character
1804		Calculate but not transmit
1805		Calculate and transmit
1806		Code 128 maximum length setting
1807		Code 128 minimum length setting

SET		Confirm to save this setting (required for reading full ASCII table and length setting)
-----	--	---



End Of Configuration



## Start Of Configuration

## 5. Chinese Post Code Parameter Setting

Barcode Value	Barcode Label	Description
RC05		Chinese post code enable
RD05		Chinese post code disable
DC60		Chinese post code data redundant check=off
DC61		Chinese post code data redundant check=1
DC62		Chinese post code data redundant check=2
DC63		Chinese post code data redundant check=3
SZ01		Chinese post code maximum length setting
SZ02		Chinese post code minimum length setting

SET



Confirm to save this setting (required for reading full ASCII table and length setting)



## End Of Configuration



Start Of Configuration

6. MSI/Plessey Parameter Setting

Barcode Value	Barcode Label	Description
RC14		MSI enable
RD14		MSI disable
DC70		MSI data redundant check= off
DC71		MSI data redundant check=1
DC72		MSI data redundant check=2
DC73		MSI data redundant check=3
MS01		MSI/Plessey maximum length setting
MS02		MSI/Plessey minimum length setting
SET		Confirm to save this setting (required for reading full ASCII table and length setting)
MS03		MSI/Plessey double check digit calculate but not transmit
MS04		MSI/Plessey double check digit without calculate and transmit
MS05		MSI/Plessey double check digit calculate but only first digit transmit
MS06		MSI/Plessey double check digit calculate and both transmit
MS07		MSI/Plessey single check digit calculate but without transmit
MS08		MSI/Plessey single check digit calculate and transmit



End Of Configuration



Start Of Configuration

---

<b>Barcode Value</b>	<b>Barcode Label</b>	<b>Description</b>
MS11		MSI Check Digit Algorithm (Mod10/Mod10) Two algorithms are possible for the verification of the second MSI check digit. Select the barcode corresponding to the algorithm used to encode the check digit
MS12		MSI Check Digit Algorithm (Mod10/Mod11)



End Of Configuration



Start Of Configuration

7. Code 11 Interface Setting

Barcode Value	Barcode Label	Description
RC07		Code 11 enable
RD07		Code 11 disable
1101		Code 11 maximum length setting
1102		Code 11 minimum length setting

SET		Confirm to save this setting (required for reading full ASCII table and length setting)
-----	--	---

1103		Code 11 one check digit verification
1104		Code 11 two check digit verification
1105		Two Check for Code 11 check digit if code length is longer than 10 characters
1106		Disable verification
1107		Code 11 check digit transmitted
1108		Code 11 check digit not transmitted



End Of Configuration



Start Of Configuration

## 8. ITF 2 of 5 Parameter Setting

Barcode Value	Barcode Label	Description
RC04		ITF 2 of 5 enable
RD04		ITF 2 of 5 disable
RC09		IATA code enable
RD09		IATA disable
RC32		Convert ITF 2 of 5 to EAN-13 enable
RD32		Convert ITF 2 of 5 to EAN-13 disable
DC80		ITF 25 data redundant check=off
DC81		ITF25 data redundant check=1
DC82		ITF25 data redundant check=2
DC83		ITF25 data redundant check=3
IT03		ITF 2 of 5 no check character
IT04		ITF 2 of 5 check digit calculate and transmit
IT05		ITF 2 of 5 check digit calculate but without transmit



End Of Configuration



Start Of Configuration

<b>Barcode Value</b>	<b>Barcode Label</b>	<b>Description</b>
IT01		ITF 2 of 5 code maximum length setting
IT02		ITF 2 of 5 code minimum length setting
IT06		ITF 2 of 5 one fixed length setting
IT07		ITF 2 of 5 two fixed length setting

SET		Confirm to save this setting (required for reading full ASCII table and length setting)
-----	--	---

IT08		ITF 2 of 5 length variable
------	--	----------------------------



End Of Configuration



## Start Of Configuration

## 9. Standard 2 of 5 Parameter Setting

Barcode Value	Barcode Label	Description
RC22		Standard 2 of 5 code enable
RD22		Standard 2 of 5 code disable
D051		Standard 2 of 5 code maximum length setting
D052		Standard 2 of 5 code minimum length setting

SET



Confirm to save this setting (required for reading full ASCII table and length setting)

D053		Standard 2 of 5 code no check character
D054		Standard 2 of 5 code check digit calculate and transmit
D055		Standard 2 of 5 code check digit calculate but without transmit



## End Of Configuration



Start Of Configuration

10. Industrial 2 of 5 Parameter Setting

Barcode Value	Barcode Label	Description
RC21		Industrial 2 of 5 code enable
RD21		Industrial 2 of 5 code disable
D251		Industrial 2 of 5 code maximum length setting
D252		Industrial 2 of 5 code minimum length setting

SET		Confirm to save this setting (required for reading full ASCII table and length setting)
-----	--	---

D253		Industrial 2 of 5 code no check character
D254		Industrial 2 of 5 code check digit calculate and transmit
D255		Industrial 2 of 5 code check digit calculate but without transmission



End Of Configuration



Start Of Configuration

## 11. UPC/EAN/JAN Parameter Setting

Barcode Value	Barcode Label	Description
RC11		EAN convert to ISSN/ISBN enable
RD11		EAN convert to ISSN/ISBN disable
RC03		UPC/EAN/JAN enable
RD03		UPC/EAN/JAN disable
UE01		UPC/EAN/JAN all enable
UE02		EAN-8 or EAN-13 enable
UE03		UPC-A and EAN-13 enable
UE04		UPC-A and UPC-E enable
UE05		UPC-A enable
UE06		UPC-E enable
UE07		EAN-13 enable
UE08		EAN-8 enable
UE09		UPC/EAN Addendum disable



End Of Configuration



Start Of Configuration

Barcode Value	Barcode Label	Description
UE10		Add on 5 only
UE11		Add on 2 only
UE12		Add on 2 or 5
UE13		Force UPC-E to UPC-A format enable
UE14		Force UPC-E to UPC-A format disable
UE15		Force UPC-A to EAN-13 format enable
UE16		Force UPC-A to EAN-13 format disable
UE44		Force EAN-8 to EAN-13 format enable
UE45		Force EAN-8 to EAN-13 format disable
UE17		Transmit UPC-A check digit enable
UE18		Transmit UPC-A check digit disable
UE19		Transmit UPC-E leading character enable
UE20		Transmit UPC-E leading character disable
UE21		Transmit UPC-E check digit enable
UE22		Transmit UPC-E check digit disable



End Of Configuration





Start Of Configuration

Barcode Value	Barcode Label	Description
UE23		Transmit EAN-8 check digit enable
UE24		Transmit EAN-8 check digit disable
UE25		Transmit EAN-13 check digit enable
UE26		Transmit EAN-13 check digit disable
UE27		Transmit UPC-A leading character enable
UE28		Transmit UPC-A leading character disable
UE30		Add-on format with separator
UE31		Add-on format without separator
UE60		EAN-13 country code first "0" can be transmitted
UE61		EAN-13 country code first:"0" can't be transmitted
UE66		EAN-13 with first 0 ID code same as "UPC-A"
UE67		EAN-13 with first 0 ID code same as "EAN-13"
DC10		UPC-A data redundant check=off
DC11		UPC-A data redundant check=1



End Of Configuration



Start Of Configuration

Barcode Value	Barcode Label	Description
DC12		UPC-A data redundant check=2
DC13		UPC-A data redundant check=3
DC14		UPC-E data redundant check=off
DC15		UPC-E data redundant check=1
DC16		UPC-E data redundant check=2
DC17		UPC-E data redundant check=3
DC20		EAN-13 data redundant check=off
DC21		EAN-13 data redundant check=1
DC22		EAN-13 data redundant check=2
DC23		EAN-13 data redundant check=3
DC24		EAN-8 data redundant check=off
DC25		EAN-8 data redundant check=1
DC26		EAN-8 data redundant check=2
DC27		EAN-8 data redundant check=3
UE32		EAN/UPC +add-on (none mandatory)
UE33		EAN/UPC +add-on (mandatory)



End Of Configuration

Start Of Configuration

---

<b>Barcode Value</b>	<b>Barcode Label</b>	<b>Description</b>
UE35		EAN/UPC +add-on mandatory for 978/977 bookland (Supplement requirement, not sent for other)
UE38		EAN/UPC +addon mandatory for 978/977 bookland (Supplement requirement, optional for other)
UE42		EAN/UPC +addon mandatory for 491 Japanese bookland (Supplement requirement, not sent for other)
UE43		EAN/UPC +addon mandatory 491 Japanese bookland (Supplement requirement, optional for other)



End Of Configuration



Start Of Configuration

<b>Barcode Value</b>	<b>Barcode Label</b>	<b>Description</b>
RC33		UPCE1 enable
RD33		UPCE1 disable
UE68		UPCE1 Check Digit Transmit enable
UE69		UPCE1 Check Digit Transmit disable
UE70		UPCE1 Preamble off
UE71		UPCE1 Preamble System Character
UE72		System Character & Country Code
UE73		Convert UPCE1 to UPCA enable
UE74		Convert UPCE1 to UPCA disable
UE75		Bookland ISBN Format enable
UE76		Bookland ISBN Format disable
UE77		UCC Coupon extended Code enable
UE78		UCC Coupon extended Code disable



End Of Configuration

Start Of Configuration

---

## 12. Telepen Parameter Setting

Barcode Value	Barcode Label	Description
RC25		Telepen enable
RD25		Telepen disable
TE03		Telepen numeric mode enable
TE04		AIM Telepen enable



End Of Configuration



Start Of Configuration

13. Matrix 2 of 5 Parameter Setting

Barcode Value	Barcode Label	Description
RC12		Matrix 2 of 5 enable
RD12		Matrix 2 of 5 disable
D151		Matrix 2 of 5 maximum length setting
D152		Matrix 2 of 5 minimum length setting

SET		Confirm to save this setting (required for reading full ASCII table and length setting)
-----	--	---

D153		Matrix 2 of 5 no check character
D154		Matrix 2 of 5 check digit calculate and transmit
D155		Matrix 2 of 5 check digit calculate but without transmission



End Of Configuration



Start Of Configuration

14. GS1 DataBar Parameter Setting

There are 7 kinds of barcodes in the GS1 DataBar family and they are categorized into three groups. Barcode types in the same group use the same barcodes for setting.

Group	Representative	Contents
Group 1	GS1 DataBar Omnidirectional <b>(Formally RSS-14)</b>	GS1 DataBar Omnidirectional GS1 DataBar Truncated GS1 DataBar Stacked GS1 DataBar Stacked Omnidirectional
Group 2	GS1 DataBar Limited <b>(Formally RSS Limited)</b>	GS1 DataBar Limited
Group 3	GS1 DataBar Expanded <b>(Formally RSS Expanded)</b>	GS1 DataBar Expanded GS1 DataBar Expanded Stacked

**GS1 DataBar Omnidirectional (Formally RSS-14)**

Barcode Value	Barcode Label	Description
RC15		GS1 DataBar Omnidirectional enable
RD15		GS1 DataBar Omnidirectional disable
SS00		Transmit GS1 DataBar Omnidirectional check digit
SS01		Do not transmit GS1 DataBar Omnidirectional check digit
SS02		Transmit GS1 DataBar Omnidirectional application ID (01)
SS03		Do not transmit GS1 DataBar Omnidirectional application ID (01)
SS05		GS1 DataBar Omnidirectional /EAN-128 emulation enable
SS04		GS1 DataBar Omnidirectional /EAN-128 emulation disable



End Of Configuration



Start Of Configuration

**GS1 DataBar Limited (Formally RSS Limited)**

Barcode Value	Barcode Label	Description
RC16		GS1 DataBar Limited enable
RD16		GS1 DataBar Limited disable
SS10		Transmit GS1 DataBar Limited check digit
SS11		Don't transmit GS1 DataBar Limited check digit
SS12		Transmit GS1 DataBar limited application ID (01)
SS13		Do not transmit GS1 DataBar limited application ID



End Of Configuration





Start Of Configuration

### GS1 DataBar Expanded (Formerly RSS Expanded)

Barcode Value	Barcode Label	Description
RC17		GS1 DataBar Expanded enable
RD17		GS1 DataBar Expanded disable
SS07		GS1 DataBar Expanded/EAN-128 emulation enable
SS06		GS1 DataBar Expanded/EAN-128 emulation disable
SS08		GS1 DataBar Expanded check digital enable
SS09		GS1 DataBar Expanded check digital disable
SS16		Transmit GS1 DataBar Expanded application ID (01)
SS17		Do not transmit GS1 DataBar Expanded application ID



End Of Configuration



Start Of Configuration

**15. Postal Codes Setting**

<b>Barcode Value</b>	<b>Barcode Label</b>	<b>Description</b>
RC35		US Postnet enable
RD35		US Postnet disable
RC36		US Planet enable
RD36		US Planet disable
RC37		Transmit US Postal Check Digit enable
RD37		Transmit US Postal Check Digit disable
RC38		UK Postal enable
RD38		UK Postal disable
RC39		Transmit UK Postal Check Digit enable
RD39		Transmit UK Postal Check Digit disable



End Of Configuration



Start Of Configuration

---

<b>Barcode Value</b>	<b>Barcode Label</b>	<b>Description</b>
RC40		Japan Postal enable
RD40		Japan Postal disable
RC41		Australian Postal enable
RD41		Australian Postal disable
RC42		Dutch Postal enable
RD42		Dutch Postal disable
RC43		4State Postal enable
RD43		4State Postal disable
RC44		Post US4 enable
RD44		Post US4 disable



End Of Configuration

---



Start Of Configuration

**16. Composite Setting**

<b>Barcode Value</b>	<b>Barcode Label</b>	<b>Description</b>
RC45		Composite cc-c enable
RD45		Composite cc-c disable
RC46		Composite cc-A/B enable
RD46		Composite cc-A/B disable
RC47		Composite TLC-39 enable
RD47		Composite TLC-39 disable
UC00		UPC Composite Mode never linked
UC01		UPC Composite Mode always linked
UC02		UPC Composite Mode auto
UC03		Composite Beep Mode single beep after
UC04		Composite Beep Mode beep as each
UC05		Composite Beep Mode double beep after
UC06		UCC/EAN Code128 Emulation Mode for UCC/EAN Composite codes enable
UC07		UCC/EAN Code128 Emulation Mode for UCC/EAN Composite codes disable



End Of Configuration



Start Of Configuration

---

## 17. 2D Setting

Barcode Value	Barcode Label	Description
RC48		PDF417 enable
RD48		PDF417 disable
RC49		MicroPDF417 enable
RD49		MicroPDF417 disable
RC50		Code128 Emulation enable
RD50		Code128 Emulation disable
RC51		Data Matrix enable
RD51		Data Matrix disable



End Of Configuration



Start Of Configuration

---

<b>Barcode Value</b>	<b>Barcode Label</b>	<b>Description</b>
RC52		Maxicode enable
RD52		Maxicode disable
RC53		QR Code enable
RD53		QR Code disable
RC54		MicroQR enable
RD54		MicroQR disable
RC55		Aztec enable
RD55		Aztec disable



End Of Configuration



Start Of Configuration

## 18. Symbology-Specific Security Levels

Barcode Value	Barcode Label	Description
SL00		<p>Security Level 0</p> <p>The decoder offers four levels of decode security for delta bar codes, which include the Code 128 family, UPC/EAN, and Code 93. Select increasing levels of security for decreasing levels of bar code quality</p>
SL01		Security Level 1
SL02		Security Level 2
SL03		Security Level 3
GS00		<p>Intercharacter Gap Size normal</p> <p>The Code 39 and Codabar symbologies have an intercharacter gap that is typically quite small. Due to various barcode-printing technologies, this gap can grow larger than the maximum size allowed, preventing the decoder from decoding the symbol. If this problem occurs, scan the Large Intercharacter Gaps parameter to tolerate these out-of-specification bar codes</p>
GS01		Intercharacter Gap Size large







End Of Configuration



## Start Of Configuration

## 19. MicroPDF Features

Barcode Value	Barcode Label	Description
MP03		<b>Transmit MicroPDF Control Header enable</b> When enabled, this activates transmission of the control header, which contains the segment index and the file ID, in Macro PDF symbols. For example, the field may be: \92800000\725\120\343. The five digits after the \928 are the segment index (or block index), and \725\120\343 is the file ID
MP04		<b>Transmit MicroPDF Control Header disable</b>
MP05		<b>Escape Characters GLI Protocol</b> This enables the backslash (\) character as an Escape character for systems that can process transmissions containing special data sequences. Scan a bar code below to either format special data according to the GLI (Global Label Identifier) protocol, or to disable this parameter. This parameter only affects the data portion of a Macro PDF symbol transmission; the Macro PDF Control Header (if enabled) is always sent with GLI formatting
MP06		<b>Escape Characters None</b>



## End Of Configuration





Start Of Configuration

20. Imager Preferences

Barcode Value	Barcode Label	Description
IP00		<b>Decoding Autoexposure enable</b> Select enable Decoding Autoexposure to allow the SE4500 to control gain settings and exposure (integration) time to best capture an image for decode mode
IP01		<b>Decoding Autoexposure disable</b>
IP02		<b>Decoding Illumination enable</b> Selecting enable Decoding Illumination causes the decoder to turn on illumination every image capture to aid decoding. Select disable Decoding Illumination to prevent the decoder from using decoding illumination
IP03		<b>Decoding Illumination disable</b>
IP04		<b>Decode Aiming Pattern enable</b> This parameter only applies in Decode Mode. Select Enable Decode Aiming Pattern to project the aiming pattern during bar code capture, or Disable Decode Aiming Pattern to turn the aiming pattern off
IP05		<b>Decode Aiming Pattern disable</b>
IP06		<b>Aim Brightness</b> This feature sets the brightness of the aim pattern. The default is 0, which indicates that the aim pattern is always on in between camera exposures. For values above 0, each increment of the brightness value increments the aim duration 0.5 ms
IP07		<b>Illumination Brightness</b> This feature sets the brightness of the illumination by altering LED power. The default is 10, which is maximum LED brightness. For values from 1 to 10, LED brightness varies from lowest to highest level of brightness

SET		Confirm to save this setting (required for reading full ASCII table and length setting)
-----	--	---



End Of Configuration



Start Of Configuration

## Data Editing

### 1. Identifier Code

Barcode Value	Barcode Label	Description
IS00		Disable identifier code
IS01		Enable identifier code table as factory standard
IS03		Enable identifier code table as AIM standard.
CI01		Code 39 identifier code setting
CI02		ITF 2 of 5 identifier code setting
CI03		Chinese Post Code identifier code setting
CI04		UPC-E identifier code setting
CI05		UPC-A identifier code setting
CI06		EAN-13 identifier code setting
CI07		EAN-8 identifier code setting

SET		Confirm to save this setting (required for reading full ASCII table and length setting)
-----	--	---



End Of Configuration



Start Of Configuration

Barcode Value	Barcode Label	Description
CI08		Codabar identifier code setting
CI09		Code 128 identifier code setting
CI10		Code 93 identifier code setting
CI11		MSI identifier code setting
CI12		GS1 DataBar Omnidirectional identifier code setting
CI13		GS1 DataBar Limited identifier code setting
CI14		GS1 DataBar expanded identifier code setting
CI15		Industrial 2 of 5 identifier code setting
CI16		Code 11 Identifier code setting
CI17		Standard 2 of 5 identifier code setting
CI18		Matrix 2 of 5 identifier code setting

SET		Confirm to save this setting (required for reading full ASCII table and length setting)
-----	--	---



End Of Configuration



Start Of Configuration

2. Header and Trailer

Barcode Value	Barcode Label	Description
CP11		Add code length as header enable (2 digits)
CP12		Add code length as header disable (2 digits)
HT01		Header (Preamble)
HT02		Trailer (Postamble)
HT03		Truncate header character
HT04		Truncate trailer character

SET		Confirm to save this setting (required for reading full ASCII table and length setting)
-----	--	---



End Of Configuration



Start Of Configuration

**Full ASCII Code 39 Table**

Code 39	ASCII	Hexa - code	Code 39	ASCII	Hexa- code
	Full ASCII ---NUL	00		Full ASCII ---SI Function key----"Shift"	0F
	Full ASCII ---SOH Function key----"Ins"	01		Full ASCII ---DLE Function key---- "5(num)"	10
	Full ASCII ---STX Function key----"Del"	02		Full ASCII ---DC1 Function key----"F1"	11
	Full ASCII ---ETX Function key----"Home"	03		Full ASCII ---DC2 Function key----"F2"	12
	Full ASCII ---EOT Function key----"End"	04		Full ASCII ---DC3 Function key----"F3"	13
	Full ASCII ---ENQ Function key----"Up arrow"	05		Full ASCII ---DC4 Function key----"F4"	14
	Full ASCII ---ACK Function key----"Down arrow"	06		Full ASCII ---NAK Function key----"F5"	15
	Full ASCII ---BEL Function key----"Left arrow"	07		Full ASCII ---SYN Function key----"F6"	16
	Full ASCII ---BS Function key---- "Backspace"	08		Full ASCII ---ETB Function key----"F7"	17
	Full ASCII ---HT Function key----"TAB"	09		Full ASCII ---CAN Function key----"F8"	18
	Full ASCII ---LF Function key----"Enter (alpha numeric)"	0A		Full ASCII ---EN Function key----"F9"	19
	Full ASCII ---VT Function key----"right arrow"	0B		Full ASCII ---SUB Function key----"F10"	1A
	Full ASCII ---FF Function key----"PgUp"	0C		Full ASCII ---ESC Function key----"F11"	1B
	Full ASCII ---CR Function key---- "Enetr(num.)"	0D		Full ASCII ---FS Function key----"F12"	1C
	Full ASCII ---SO Function key----"PgDn"	0E		Full ASCII ---GS Function key----"ESC"	1D



End Of Configuration



Start Of Configuration

**Full ASCII Code 39 Table (continued)**

Code 39	ASCII	Hexa-code	Code 39	ASCII	Hexa-code
	Full ASCII ---RS Function key-----"CTL(L)"	1E		Full ASCII ---	2D
	Full ASCII ---US Function key-----"ALT(L)"	1F		Full ASCII ---.	2E
	Full ASCII ---SP	20		Full ASCII ---/	2F
	Full ASCII ---!	21		Full ASCII ---0	30
	Full ASCII ---"	22		Full ASCII ---1	31
	Full ASCII ---#	23		Full ASCII ---2	32
	Full ASCII ---\$	24		Full ASCII ---3	33
	Full ASCII ---%	25		Full ASCII ---4	34
	Full ASCII ---&	26		Full ASCII ---5	35
	Full ASCII ---'	27		Full ASCII ---6	36
	Full ASCII --- (	28		Full ASCII ---7	37
	Full ASCII ---)	29		Full ASCII ---8	38
	Full ASCII ---*	2A		Full ASCII ---9	39
	Full ASCII ---+	2B		Full ASCII ---:	3A
	Full ASCII ---,	2C		Full ASCII ---;	3B



End Of Configuration



Start Of Configuration

**Full ASCII Code 39 Table (continued)**

Code 39	ASCII	Hexa-code	Code 39	ASCII	Hexa-code
	Full ASCII ---<	3C		Full ASCII ---K	4B
	Full ASCII ---=	3D		Full ASCII ---L	4C
	Full ASCII --->	3E		Full ASCII ---M	4D
	Full ASCII ---?	3F		Full ASCII ---N	4E
	Full ASCII ---@	40		Full ASCII ---O	4F
	Full ASCII ---A	41		Full ASCII ---P	50
	Full ASCII ---B	42		Full ASCII ---Q	51
	Full ASCII ---C	43		Full ASCII ---R	52
	Full ASCII ---D	44		Full ASCII ---S	53
	Full ASCII ---E	45		Full ASCII ---T	54
	Full ASCII ---F	46		Full ASCII ---U	55
	Full ASCII ---G	47		Full ASCII ---V	56
	Full ASCII ---H	48		Full ASCII ---W	57
	Full ASCII ---I	49		Full ASCII ---X	58
	Full ASCII ---J	4A		Full ASCII ---Y	59



End Of Configuration



Start Of Configuration

**Full ASCII Code 39 Table (continued)**

Code 39	ASCII	Hexa-code	Code 39	ASCII	Hexa-code
	Full ASCII ---Z	5A		Full ASCII ---i	69
	Full ASCII ---[	5B		Full ASCII ---j	6A
	Full ASCII ---\	5C		Full ASCII ---k	6B
	Full ASCII ---]	5D		Full ASCII ---l	6C
	Full ASCII ---^	5E		Full ASCII ---m	6D
	Full ASCII ---_	5F		Full ASCII ---n	6E
	Full ASCII ---`	60		Full ASCII ---o	6F
	Full ASCII ---a	61		Full ASCII ---p	70
	Full ASCII ---b	62		Full ASCII ---q	71
	Full ASCII ---c	63		Full ASCII ---r	72
	Full ASCII ---d	64		Full ASCII ---s	73
	Full ASCII ---e	65		Full ASCII ---t	74
	Full ASCII ---f	66		Full ASCII ---u	75
	Full ASCII ---g	67		Full ASCII ---v	76
	Full ASCII ---h	68		Full ASCII ---w	77



End Of Configuration





Start Of Configuration

**Full ASCII Code 39 Table (continued)**

<b>Code 39</b>	<b>ASCII</b>	<b>Hexa- code</b>	<b>Code 39</b>	<b>ASCII</b>	<b>Hexa- code</b>
	Full ASCII ---x	78		Full ASCII ---	7C
	Full ASCII ---y	79		Full ASCII ---}	7D
	Full ASCII ---z	7A		Full ASCII ---~	7E
	Full ASCII ---{	7B		Full ASCII ---DEL	7F



End Of Configuration

## Appendix 1: USB Virtual COM Driver Installation

Contact your distributor to get the driver and follow the steps below to enable USB virtual COM port.

1. Connect the handheld scanner and the host (e.g. a PC) with a USB interface cable.
2. Enable USB virtual COM port with programming barcode from System Function Settings.
3. After the programming, the host would request driver installation. Browse your files to locate the driver and start installation.
4. The USB virtual COM port is ready for use after driver installation.

## Appendix 2: Barcode Length Setting

### Introduction

The length of a barcode is the number of characters it contains, including check digits. As listed in the Default Parameters section, each barcode type has different default length. You may change the setting by the following procedure.

To set up barcode length, the parameters to be determined are barcode type and the desired barcode length. Barcode length is consisted of 2 digits. For numbers smaller than 10, you need to add a "0" in the front.

### Example

If the barcode length is 4 to 12 digits, the steps would be as below:

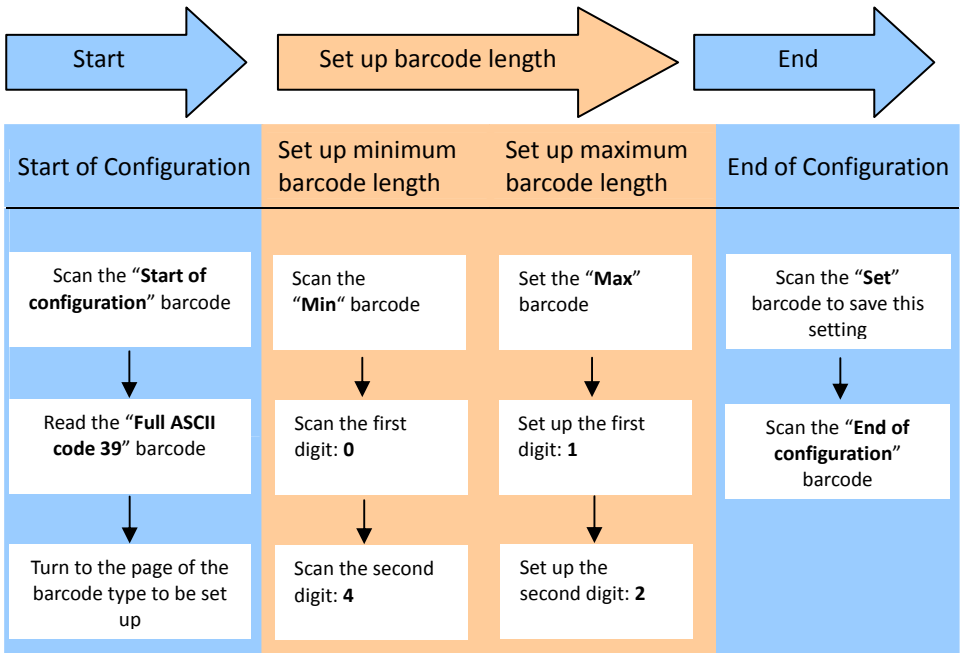

Use the ASCII table (Appendix 4) to set up barcode length. Be sure to enable the full ASCII code 39 option before you start and read the "Set" label to set your choice into memory.