



PIXSYS
elettronica

ATR 401



- **Regolatore**
- **Controller**

Manuale Installatore
User manual

Summary		Page
1	Introduction	4
2	Model Identification	4
3	Technical data	5
3.1	General data	5
3.2	Hardware data	5
3.3	Software data	6
4	Dimensions and Installation	6
4.1	Electronics Removal	7
5	Electrical wirings	7
5.1	Wiring diagram	8
6	Display and Key Functions	15
6.1	Numeric Indicators (Display)	15
6.2	Meaning of Status Lights (Led)	15
6.3	Keys	16
7	Dual input mode	17
7.1	Selection of process value related to the command output and to the alarms	17
7.2	Remote setpoint	18
8	Controller Functions	19
8.1	Modifying Main Setpoint and Alarm Setpoint Values	19
8.2	Auto-Tuning	19
8.3	Manual Tuning	19
8.4	Automatic Tuning	19
8.5	Automatic / Manual Regulation for % Output Control	20
8.6	Soft-Start	20
8.7	Memory Card (optional)	21
8.8	Loading default values	22
8.9	LATCH ON Functions (only AI1)	22
8.10	Heating-Cooling P.I.D.	24
9	Serial Communication	26
10	Configuration	30
10.1	Modify Configuration Parameter	30
11	Table of Configuration Parameters	31
12	Alarm Intervention Modes	49
13	Table of Anomaly Signals	53
14	Configuration EASY-UP	54
15	Summary of Configuration parameters	55



Pay attention at the section marked with this symbol

Presta attenzione alla sezione contrassegnata da questo simbolo

Sommario

	Pag
1 Introduzione	59
2 Identificazione di modello	59
3 Dati tecnici	60
3.1 Caratteristiche generali	60
3.2 Caratteristiche Hardware	60
3.3 Caratteristiche Software	61
4 Dimensioni e installazioni	61
4.1 Estrazione dell'elettronica	62
5 Collegamenti elettrici	62
5.1 Schema di collegamento	63
6 Funzione dei visualizzatori e tasti	70
6.1 Indicatori numerici (Display)	70
6.2 Significato delle spie di stato (Led)	70
6.3 Tasti	71
7 Modalità doppio ingresso	72
7.1 Selezione grandezza correlata al comando e agli allarmi	72
7.2 Setpoint remoto	73
8 Funzioni del regolatore	74
8.1 Modifica valore setpoint principale e setpoint di allarme	74
8.2 Auto-Tuning	74
8.3 Lancio del Tuning Manuale	74
8.4 Tuning Automatico	74
8.5 Regolazione automatico / manuale del controllo % uscita	75
8.6 Soft-Star	75
8.7 Memory Card (opzionale)	76
8.8 Caricamento valori di default	77
8.9 Funzione LATCH ON (solo AI1)	77
8.10 Funzionamento da doppia azione (caldo-freddo)	79
9 Comunicazione Seriale	81
10 Configurazione	85
10.1 Modifica parametro di configurazione	85
11 Tabella parametri di configurazione	86
12 Modi di intervento allarme	104
13 Tabella segnalazioni anomalie	108
14 Configurazione EASY-UP	109
15 Promemoria configurazione	110

Sommaire

1 Identification du modèle	114
2 Données techniques	114
2.1 Caractéristiques générales	114
2.2 Caractéristiques Hardware	115
2.3 Caractéristiques Software	116
3 Dimensions et Installation	116
3.1 Déplacement de l'électronique	117
4 Raccordements électriques	118
4.1 Schéma des connexions	118

1 Introduction

Thanks for choosing a Pixsys controller.

With ATR401 model, Pixsys integrates in a single device all options for sensors reading and actuators control, beside an useful supply with extended range 24...230 Vac/Vdc. Thanks to dual universal analogue input outputs configurable as relay or SSR, the user or the retailer can reduce stock needs.

The series includes also a model with serial communication RS485 Modbus Rtu and linear output 0-10 V, 0/4-20 mA. The possibility to repeat parameterization is simplified by the Memory Cards with internal battery that do not require power supply for the controller.

2 Model Identification

ATR401 series includes four versions.

Looking at the following table it is possible to find the required model.

Power supply 24...230 Vac/Vdc +/-15% 50/60 Hz – 5,5 VA

ATR401-22ABC	2 Analogue inputs + 2 Relays 8 A + 1 SSR
ATR401-23ABC	2 Analogue inputs + 3 Relays 8 A + 1 SSR
ATR401-24ABC	2 Analogue inputs + 4 Relays 8 A + 1 SSR
ATR401-22ABC-T	2 Analogue inputs + 2 Relays 8 A + 1 SSR 1 Output V / mA + RS485

3 Technical data

3.1 General data

<i>Indicators</i>	4 display 0,40 inches 4 display 0,30 inches
<i>Operating temperature</i>	Temperature 0-45 °C Humidity 35..95 uR%
<i>Sealing</i>	IP54 front panel, box IP30 and terminal block IP20
<i>Material</i>	Box: Noryl UL94V1 self-exstinguish Front panel: PC ABS UL94V0 self-exstinguish
<i>Weight</i>	Approx 350 g

3.2 Hardware data

<i>Analogue input</i>	AI1 – AI2: Configurable via software. Input: Thermocouple type K, S, R, J. Automatic compensation of cold junction from 0 ... 50°C. Thermoresistances: PT100, PT500, PT1000, Ni100, PTC1K, NTC10K (β 3435K) Linear input: 0-10 V, 0-20 o 4-20 mA, 0-40 mV. Input Potentiometer: 6 K \square , 150 K \square . • ONLY AI2 input T.A.: 50 mA.	Tolerance (25 °C) +/-0.2% \pm 1 digit for thermocouple, thermoresistance and V / mA. Cold junction accuracy 0.1 °C/°C.
<i>Relay outputs</i>	Configurable as control and alarm output.	Contacts: 8 A - 250 V~ for resistive charges.
<i>SSR output</i>	Configurable as control and alarm output.	24 V; 25 mA.
<i>Analogue output</i>	Configurable as control output, alarm, retransmission of process or setpoint.	Configurable: 0-10 V (9500 points); 0-20 mA (7500 points); 4-20 mA (6000 points).
<i>Power supply</i>	Extended range 24...230 Vac/ Vdc \pm 15% 50/60 Hz.	Consumption: 5.5 VA.

3.3 Software data

<i>Regulation algorithms</i>	ON - OFF with hysteresis. P, P.I., P.I.D., P.D. proportional time.
<i>Proportional band</i>	0...9999 °C o °F
<i>Integral time</i>	0,0...999,9 sec. (0 excludes integral function)
<i>Derivative time</i>	0,0...999,9 sec. (0 excludes derivative function)
<i>Controller functions</i>	Manual or automatic tuning, selectable alarms, protection of control and alarm setpoints.

4 Dimensions and Installation

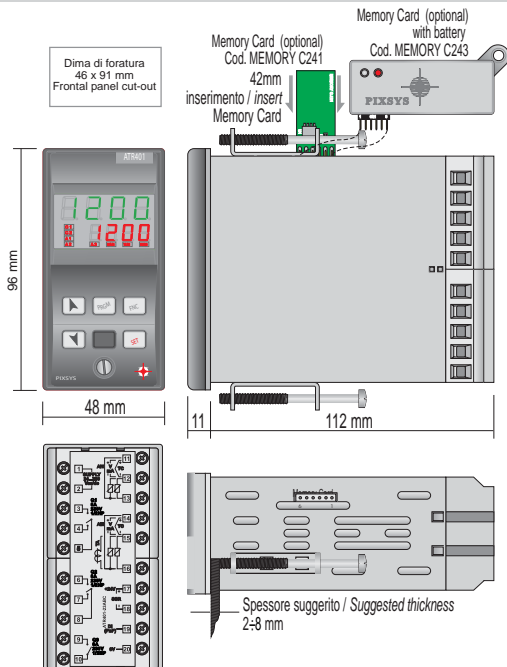

4.1 Electronics Removal

To configure internal Jumper, remove the electronics by twist off the screw on instrument frontal side.

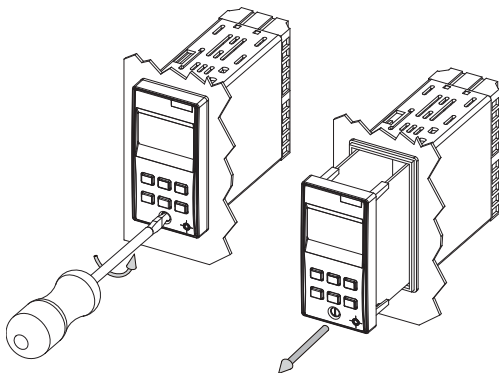

WARNING

Disconnect the device from the mains before starting to configure or service it.

5 Electrical wirings



WARNING

Although this controller has been designed to resist noises in an industrial environments, please notice the following safety guidelines:

- Separate control lines from the power wires.
- Avoid the proximity of remote control switches, electromagnetic meters, powerful engines.
- Avoid the proximity of power groups, especially those with phase control.

5.1 Wiring diagram

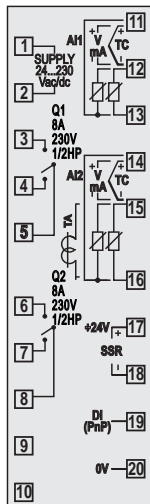

ATR401-22ABC

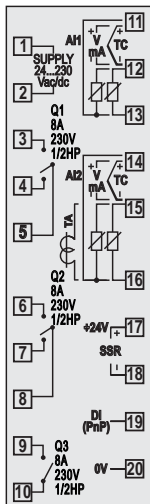

ATR401-23ABC

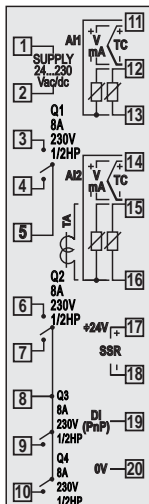

ATR401-24ABC

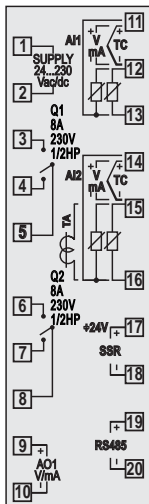

ATR401-22ABC-T

Power



Switching power supply with extended range 2 selections:

- 24 Vac/dc $\pm 15\%$ with Jumper insertion JP4;
 - 115...230 Vac/dc $\pm 15\%$ without Jumper JP4;
- 50/60 Hz – 5,5 VA (with galvanic isolation).

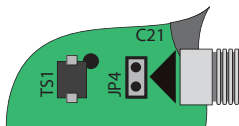

Analogue Input AI1

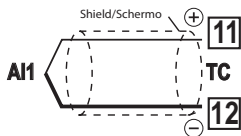

For thermocouples K, S, R, J.

- Comply with polarity.
- For possible extensions, use a compensated wire and terminals suitable for the thermocouples used (compensated).
- When shielded cable is used, it should be grounded at one side only.

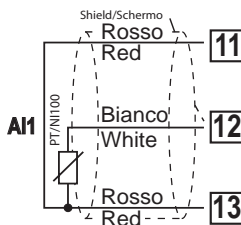

For thermoresistances PT100, NI100.

- For a three-wires connection use cables with the same diameter.
- For a two-wires connection short-circuit terminals 16 and 18.
- When shielded cable is used, it should be grounded at one side only.

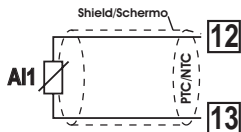

For thermoresistances NTC, PTC, PT500, PT1000 and linear potentiometers.

- When shielded cable is used, it should be grounded at one side only.

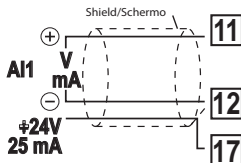

For linear signals Volt / mA.

- Comply with polarity.
- When shielded cable is used, it should be grounded at one side only.

Analogue Input AI2

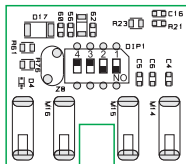

To enable the second analogue input, set the dip switches as indicated in the figure.

In this configuration input T.A. **is not** available.

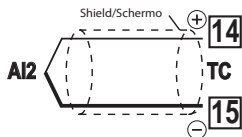

For thermocouples K, S, R, J.

- Comply with polarity.
- When extending thermocouples be sure to use the correct extension/compensating cable.
- When shielded cable is used, it should be grounded at one side only.

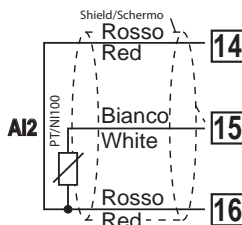

For thermoresistances PT100, NI100.

- For a three-wires connection use cables with the same diameter.
- For a two-wires connection short-circuit terminals 16 and 18.
- When shielded cable is used, it should be grounded at one side only.

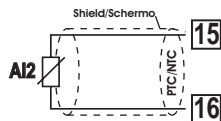

For thermoresistances NTC, PTC, PT500, PT1000 and linear potentiometers.

- When shielded cable is used, it should be grounded at one side only.

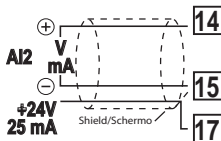

For linear signals in Volt / mA.

- Comply with polarity.
- When shielded cable is used, it should be grounded at one side only.

Examples of connection for linear input AI1



For linear signals 0...10 V.

Comply with polarity.

PRESSURE TRANSMITTER/ SENSORE DI PRESSIONE

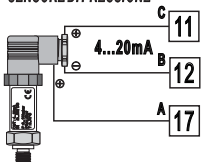

For linear signals 0/4...20 mA with **three-wires sensors**.

Comply with polarity:

C= Sensor output

B= Sensor ground

A= Sensor supply (24 Vdc / 25 mA)

PRESSURE TRANSMITTER/ SENSORE DI PRESSIONE

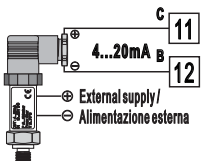

For linear signals 0/4...20 mA with **external power supply for sensor**.

Comply with polarity:

C= Sensor output

B= Sensor ground

PRESSURE TRANSMITTER/ SENSORE DI PRESSIONE

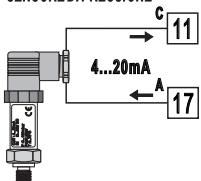

For linear signals 0/4...20 mA with **two-wires sensors**.

Comply with polarity:

C= Sensor output

A= Sensor supply (24 Vdc / 25 mA)

T.A. Input

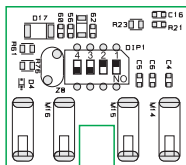

To enable T.A. input, set the dip switches as indicated in the figure.

In this configuration it is possible to set on parameter 11 .

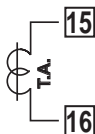

- Input for 50 mA amperometric transformer.
- Sampling time 100 ms.
- Configurable by parameters.

Digital input (not available on ATR401-22ABC-T)

+24V —



DI (PnP) —

0V —

Digital input (parameter).

- Close pin “DI” (19) on pin “+24 V” (17) to enable digital input.

Serial input (only on ATR401-22ABC-T)

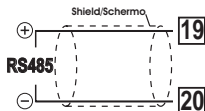

Communication RS485 Modbus RTU with galvanic isolation.

Relay outputs Q1, Q2

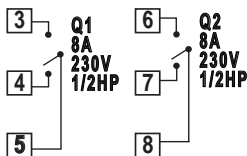

Contacts capacity:

- 8 A, 250 Vac, resistive charge 10^5 operations.
- 30/3 A, 250 Vac, $\cos\phi = 0.3$, 10^5 operations.

N.B.: See graphic.

Relay output Q3 (ATR401-23ABC)

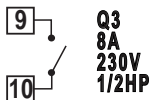

Contacts capacity:

- 8 A, 250 Vac, resistive charge 10^5 operations.
- 30/3 A, 250 Vac, $\cos\phi = 0.3$, 10^5 operations.

N.B.: See graphic.

Relay outputs Q3, Q4 (ATR401-24ABC)

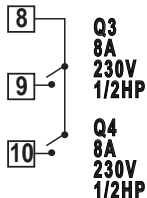

Contacts capacity:

- 8 A, 250 Vac, resistive charge 10^5 operations.
- 30/3 A, 250 Vac, $\cos\phi = 0.3$, 10^5 operations.

N.B.: See graphic.

N.B.:

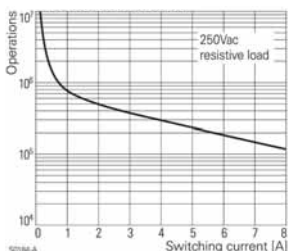

Electrical endurance

Q1 / Q2 / Q3 / Q4:

- 8 A, 250 Vac, resistive charge 10^5 operations.
- 30/3 A, 250 Vac, $\cos\phi = 0.3$, 10^5 operations.

SSR output

+24V 

SSR



SSR Command output capacity 24 V / 25 mA.

Output mA or Volt (ATR401-22ABC-T)

9 
AO1
V/mA
10 

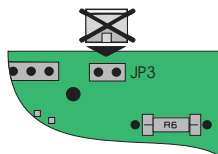

Linear output in **mA** configurable using parameters as command (parameter `COUE`) or retransmission of process-setpoint (parameter `RETr`).



To use analogue output in mA do not place JP3.

9 
AO1
V/mA
10 

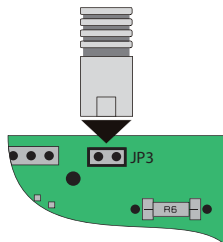

Linear output in **Volt** configurable using parameters as command (parameter `COUE`) or retransmission of process-setpoint (parameter `RETr`).



To use analogue output in Volt enter JP3 as indicated in the figure.

6 Display and Key Functions

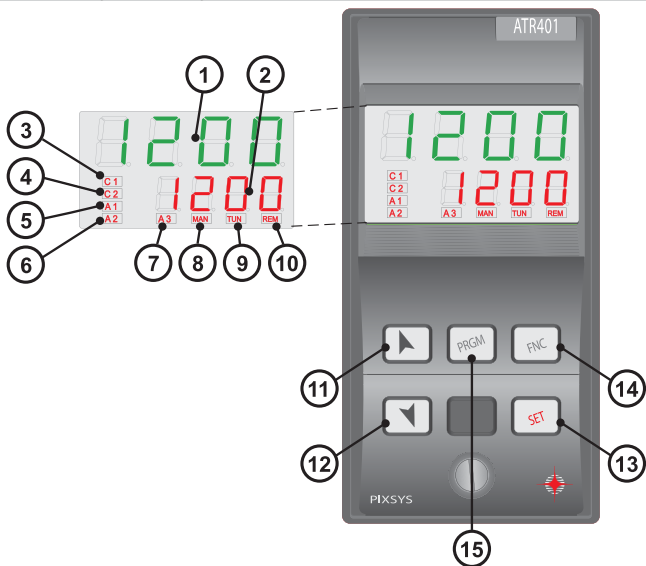

6.1 Numeric Indicators (Display)







- | | | |
|---|--|--|
| 1 | | Normally visualizes process.
In configuration mode visualizes parameter that is being entered. |
| 2 | | Normally visualizes setpoints.
In configuration mode visualizes value of parameter that is being entered. |

6.2 Meaning of Status Lights (Led)

- | | | |
|---|--|--|
| 3 | | On when command output is active. For open / close logic: on during valve opening. |
| 4 | | For open / close logic: on during valve closing. |
| 5 | | On when alarm 1 is active. |

6	A2	On when alarm 2 is active.
7	A3	On when alarm 3 is active.
8	MAN	On when "Manual" function is active.
9	TUN	On when controller is executing an auto-tuning cycle.
10	REM	On when controller communicates in serial way.

6.3 Keys

11		<ul style="list-style-type: none"> Increases main setpoint. In configuration mode allows to scroll and modify parameters. Press after  key increases alarm setpoint.
12		<ul style="list-style-type: none"> Decreases main setpoint. In configuration mode allows to scroll and modify parameters. Press after  key decreases alarm setpoints.
13		<ul style="list-style-type: none"> Allows to visualize command and alarm setpoints. In configuration mode allows to access the parameter to change and confirm its modification.
14		<ul style="list-style-type: none"> Allows to enter Tuning launch, selection automatic / manual. In configuration mode operates as exit key (ESCAPE).
15		<ul style="list-style-type: none"> If pressed allows to enter configuration password. In configuration mode assigns at selected parameter a mnemonic code or a number.

7 Dual input mode

Each ATR401 model has the possibility to use two analogue inputs: it is possible to do easy mathematic operations between measured process values, correlating obtained result to the command or alarm outputs, or use a process as remote setpoint.

7.1 Selection of process value related to the command output and to the alarms

When second input is enabled (par.11 **SEn2** other than **d.i.s.**) it is possible to choose the process value to be related to command output, to alarms and to retransmission.

Following options are available:

- **PrO1**: Value read by input AI1;
- **PrO2**: Value read by input AI2;
- **MEAN**: Mean between inputs AI1 and AI2;
- **dIFF**: Difference between inputs: AI1-AI2;
- **AbSd**: Difference between inputs as absolute value: AI1-AI2;
- **SuM**: Addition between inputs: AI1+AI2.
- Process related to command output must be set on parameter 19 **cPrO**.
- Process related to alarms must be set on par. 38 **A1Pr** for alarm 1, on par. 47 **A2Pr** for alarm 2, on par. 56 **A3Pr** for alarm 3 and on par. 65 **A4Pr** for alarm 4.
- Value to retransmit must be set on par. 88 **rEtr**.

It is possible to choose the visualization for display 2 on parameter 86 **u d2**.



WARNING

Mean, difference and addition are available only if both inputs are configured for temperature sensors or for linear signals V / mA.

7.2 Remote setpoint

It is possible to enable remote setpoint function setting `En` on par. 20 `FENS`.

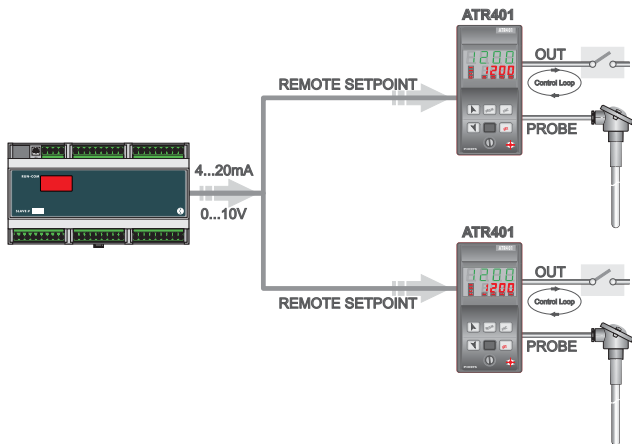

In this configuration command setpoint corresponds to the second process value read:

- if parameter 19 `cPrc` is set as `Prc1`, AI1 becomes the main process (command) and AI2 becomes the setpoint value.
- If parameter 19 `cPrc` is set as `Prc2`, AI2 becomes the main process (command) and AI1 becomes the setpoint value.

Remote setpoint function works only with one of these two settings of parameter. 19 `cPrc`.







WARNING

Decimal point setting parameter for remote setpoint input is locked and it is automatically changed when command input decimal point variates.

8.1 Modification of main and alarm setpoint value

Setpoint value can be modified from keyboard as follows:





	Press	Display	Do
1	 or 	Value on display 2 changes.	Increases or decreases the main setpoint.
2		Visualize alarm setpoint on display 1.	
3	 or 	Value on display 2 changes.	Increases or decreases the alarm setpoint value.

8.2 Auto-Tuning

Tuning procedure to calculate regulation parameters can be manual or automatic and according to selection on parameter 28 .

8.3 Manual Tuning

Manual procedure allows user more flexibility on deciding when to update regulation parameters of P.I.D. algorithm.

Press key  until display 1 visualizes writing  and display 2 visualizes . Pressing , display 2 visualizes .

Led  switches on and procedure starts.

8.4 Automatic Tuning

Automatic tuning starts when the controller is switched-on or when setpoint value has been modified over 35%.

To avoid overshooting, the threshold where controller calculates new P.I.D. parameters is determined by setpoint value minus "Set Deviation Tune" value (see parameter 29 .

To interrupt Tuning keeping the P.I.D. values unchanged, press key **[FNC]** until display 1 visualizes writing **EunE** and display 2 visualizes **on**. Pressing **[↓]**, display 2 visualizes **OFF**, led **TUN** switch off and procedure ends.

Setting **[once]** on parameter 28 **EunE** autotuning procedure starts only once when instrument is switched on: after calculating P.I.D. parameters parameter 28 **EunE** returns to **d 15**.

8.5 Automatic / Manual Regulation for % Output Control

This function allows to switch from automatic functioning to manual control of output percentage.

With parameter 83 **[MAN]**, it is possible to select two modes.

- 1 First selection (En)**. Pressing key **[FNC]** display 1 visualizes writing **P.---** on display 1, while display 2 visualizes **Auto**. Press key **[▶]** to select manual mode **[MAN]**. Whit **[▶]** and **[↓]** change output percentage. To return to automatic mode with the same procedure select **Auto** on display 2: led **MAN** switches on and operation returns to automatic mode.
- 2 Second selection (EnSE)**. Enable the same functioning, but with two important variants:
 - In case of power failure or after a switch-off, at restart both the manual functioning and the previously fixed output percentage value will be maintained.
 - If during automatic functioning there is a sensor failure, controller will automatically switch to manual mode while maintaining command output percentage unchanged as generated by P.I.D. immediately before failure.

8.6 Soft-Start

At switch-on the controller follows a rising gradient expressed in units (ex. Degree / Hour) to reach the setpoint.

The chosen rising gradient in Unit / Hour must be set on parameter 85 **[rgr]**; at **next switch-on** the controller will execute Soft-Start function. Automatic and manual Tuning function cannot be enabled if Soft-Start function is active.

Parameters and setpoint values can be easily copied from one controller to others using the MEMORY CARD.

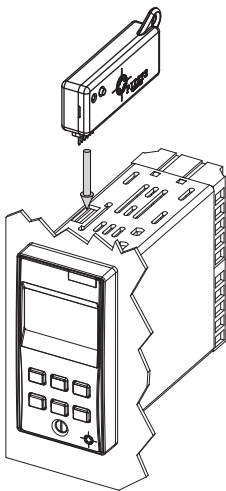

Two modes are available:



- **With the controller connected to the power supply:**

Insert Memory card when the **controller is off**.

At switch-on display 1 visualizes **MEMO** and display 2 visualizes **----** (only if correct values are stored on Memory).

Pressing  display 2 visualizes **LOAD**. Confirm with .

Controller loads news values and restarts.

- **With the controller not connected to power supply:**

The memory card is equipped with an internal battery with an autonomy of about 1000 uses (button battery, replaceable). Insert the memory card and press the programming button.

When writing the parameters, led turns red and on completing the procedure it turns to green. It is possible to repeat the procedure without any particular attention.



WARNING

Updating Memory Card

To *update* the memory card values, follow the procedure described in the first method, setting display 2 to **----** so as not to load the parameters on controller¹.







Enter configuration and **change at least one parameter.**

Exit configuration. Changes are saved automatically.







¹ If on activation the controller does not display **MEMO** it means no data have been saved on the memory card, but it is possible to update values.





8.8 Loading default values



This procedure allows to restore factory settings of the instrument.

Press	Display	Do
1  for 3 second	Display 1 visualizes  with 1 st digit blinking, while display 2 shows PASS .	
2  or 	Change blinking digit and move to the next one with  .	Enter password:  .
3  to confirm	Device loads default settings.	Switch the instrument off and on.

8.9 LATCH ON Functions (only A11)

For use with input  (potentiometer 6 K Ω) and  (potentiometer 150 K Ω) and with linear input (0...10 V, 0...40 mV, 0/4...20 mA), you can associate start value of the scale (parameter 6 ) to the minimum position of the sensor and value of the scale end (parameter 7 ) to the maximum position of the sensor (parameter 8  configured as ).





It is also possible to fix the point in which the controller will display 0 (however keeping the scale range between  and ) using the “virtual zero” option by setting  or  in parameter 8 .

If you set  the virtual zero will reset after each activation of the tool; if you set  the virtual zero remains fixed once tuned.

To use the LATCH ON function configure as you wish the parameter ².

²The tuning procedure starts by exiting the configuration after changing the parameter.

For the calibration procedure refer to the following table:

Press	Display	Do
<p>1</p> 	<p>Exit parameters configuration. Display 2 visualizes writing LAEC.</p>	<p>Place the sensor on minimum operating value (corresponding to LL.L).</p>
<p>2</p> 	<p>Store value on minimum. Display shows LoU.</p>	<p>Place sensor on maximum operating value (corresponding to UL.L).</p>
<p>3</p> 	<p>Store value on max. Display shows HIGH.</p>	<p>To exit standard proceeding press FNC. For “virtual zero” setting, place the sensor to zero point.</p>
<p>4</p> 	<p>Set the virtual zero. Display shows URt.</p> <p>N.B.: if URt is selected, the procedure must be executed at each start.</p>	<p>To exit procedure press FNC.</p>



8.10 Heating-Cooling P.I.D.

ATR401 is suitable also for applications requiring a combined heating-cooling P.I.D. action.

Command output must be configured as Heating P.I.D.

($ACTE = HEAT$ and Pb greater than 0 and one of alarms

(AL_1 , AL_2 , AL_3 or AL_4) has to be configured as $COOL$).

Command output must be connected to actuator responsible for heating action, while alarm will control the cooling action.

Parameters to configure for Heating P.I.D. are:

$ACTE = HEAT$ Command output action type (Heating);

Pb : Proportional band Heating;

Et : Integral time Heating and cooling;

Ed : Derivative time Heating and cooling;

Ec : Cycle time Heating.

Configuration parameters for Cooling P.I.D. are (example: action associated to alarm 1):

$AL_1 = COOL$ Alarm 1 selection (Cooling);

PbN : Proportional band multiplier;

$audb$: Overlapping / Dead band;

$cotc$: Cycle time Cooling.

Parameter PbN (that ranges from 1.00 to 5.00) sets the proportional band for cooling action, according to the formula here below:

Proportional band cooling action = $Pb \times PbN$.

In this way it is possible to have a proportional band for cooling action that will be equal to heating proportional band if $PbN = 1.00$, or 5 times greater if $PbN = 5.00$.

Integral time and derivative time are the same for both actions

Parameter $audb$ sets the percentage overlapping between the two actions. For installations where heating and cooling output cannot be activated at the same time, a dead band will be configured ($audb \leq 0$), vice versa an overlapping will be configured ($audb > 0$).

Figure here below shows an example of double action P.I.D. (heating-cooling) with $E_i = 0$ and $E_d = 0$.

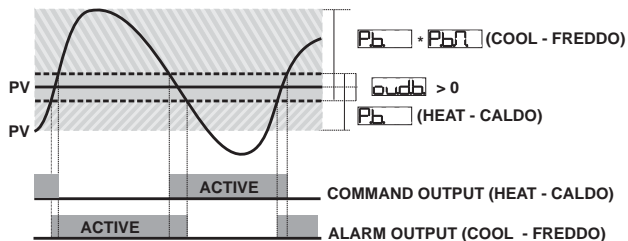
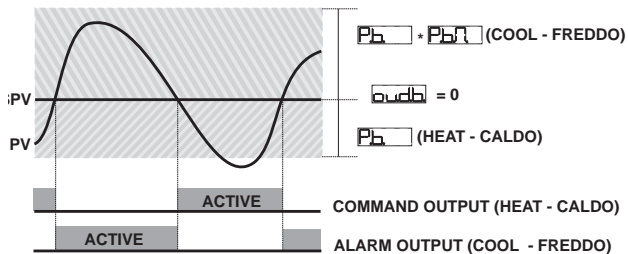
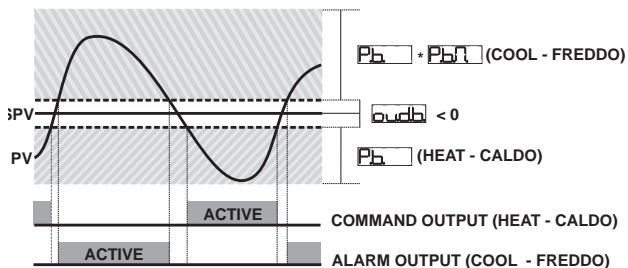

Parameter **COBCT** has the same meaning of cycle time for heating action **EC**.

Parameter **COOF** (Cooling Fluid) pre-selects the proportional band multiplier **PbN** and the cooling P.I.D. cycle time **COBCT** according to cooling fluid type:

COOF	Cooling fluid type	PbN	COBCT
Air	Air	1.00	10
Oil	Oil	1.25	4
H ₂ O	Water	2.50	2

Once parameter **COOF**, has been selected, the parameters **PbN**, **COBDB** and **COBCT** can be however modified.

9 Serial Communication

ATR401-22ABC-T is provided with RS485 and can receive / broadcast data via MODBUS-RTU protocol. Device can be configured only as Slave.

This function allows to control multiple controllers connected to a supervisory system. Each instrument will answer to a Master query only if contains same address as on parameter 93 **SLAD**.

Allowed addresses are from 1 to 254 and there should not be controllers with the same address on the same line.

Address 255 can be used by the Master to communicate with all connected equipments (broadcast mode), while with 0 all devices receive command, but no answer is expected.

ATR401 can introduce an answer delay (in milliseconds) to Master request. This delay has to be set on parameter 94 **SEDE**.

At each parameters modification, instrument stores values in EEPROM memory (100000 writing cycles), while setpoints are stored with a delay of 10 seconds after last modification.

N.B.: Modifications made to Words different from those described in the following table can lead to instrument malfunction.

Modbus RTU protocol features

<i>Boud-rate</i>	Selectable on parameter 92 bdr :
	48 F 4800 bit/sec.
	96 F 9600 bit/sec.
	192 F 19200 bit/sec.
	288 F 28800 bit/sec.
	384 F 38400 bit/sec.
	576 F 57600 bit/sec.
	1152 115200 bit/sec.
<i>Format</i>	8, N, 1 (8 bit, no parity, 1 stop)
<i>Supported functions</i>	WORD READING (max 20 word) (0x03, 0x04) SINGLE WORD WRITING (0x06) MULTIPLE WORDS WRITING (max 20 word) (0x10)

Looking at the table here below it is possible to find all available addresses and functions:

RO	Read Only
R/W	Read / Write
WO	Write Only

Modbus Address	Description	Read Write	Reset value
0	Device type	RO	EEPROM
1	Software version	RO	EEPROM
5	Slave address	R/W	EEPROM
6	Boot version	RO	EEPROM
50	Automatic addressing	WO	-
51	Installation code comparison	WO	-
500	Loading Default values: 9999 Restore all values 9998 Restore all values except for baud-rate and slave address 9997 Restore all values except for baud-rate 9996 Restore all values except for slave address	R/W	0
900	Process AI1 (degrees with tenths of degree for temperature sensors; digits for linear sensors)	RO	?
901	Process AI2 (degrees with tenths of degree for temperature sensors; digits for linear sensors)	RO	?
902	Average AI1-AI2 (degrees with tenths of degree for temperature sensors; digits for linear sensors)	RO	?

903	Difference AI1-AI2 (degrees with tenths of degree for temperature sensors; digits for linear sensors)	RO	?
905	Modul difference AI1-AI2 (degrees with tenths of degree for temperature sensors; digits for linear sensors)	RO	?
905	Addition AI1-AI2 (degrees with tenths of degree for temperature sensors; digits for linear sensors)	RO	?
1000	Command process (degrees with tenths of degree for temperature sensors; digits for linear sensors)	RO	?
1001	Setpoint 1	R/W	EEPROM
1002	Setpoint 2	R/W	EEPROM
1003	Setpoint 3	R/W	EEPROM
1004	Setpoint 4	R/W	EEPROM
1005	Alarm 1	R/W	EEPROM
1006	Alarm 2	R/W	EEPROM
1007	Alarm 3	R/W	EEPROM
1008	Alarm 4	R/W	EEPROM
1009	Real setpoint (it is based on gradient)	RO	EEPROM
1010	Relay status (0 = Off, 1 = On) Bit 0 = Relay Q4 Bit 3 = Relay Q2 Bit 1 = Relay Q3 Bit 4 = Relay Q1 N.O. Bit 2 = Relay Q1 N.O. Bit 5 = SSR	RO	0
1011	Percentage heating output (0-10000)	RO	0
1012	Percentage cooling output (0-10000)	RO	0
1013	Alarms status (0 = None, 1 = Active) Bit 0 = Alarm 1 Bit 2 = Alarm 3 Bit 1 = Alarm 2 Bit 3 = Alarm 4	RO	0
1014	Manual reset: write 0 to reset all alarms. In reading (0 = Not resettable, 1 = Resettable) Bit 0 = Alarm 1 Bit 2 = Alarm 3 Bit 1 = Alarm 2 Bit 3 = Alarm 4	WO	0
1015	Error flags Bit 0 = Eeprom writing error Bit 1 = Eeprom reading error Bit 2 = Cold junction error Bit 3 = Error AI1 (sensor 1) Bit 4 = Error AI2 (sensor 2) Bit 5 = Generic error Bit 6 = Hardware error Bit 7 = Missing calibration error Bit 8 = Incongruous control parameters Bit 9 = Incongruous alarm parameters Bit 10 = Incongruous retransmission parameters Bit 11 = Incongruous visualization parameters Bit 12 = L.B.A. – Low current Bit 13 = L.B.A. – Short circuit	RO	0

1016	Cold junction temperature (with decimal point)	RO	?
1017	Start / Stop 0 = Controller in STOP 1 = Controller in START	R/W	0
1018	Lock conversion ON / OFF 0 = Lock conversion off 1 = Lock conversion on	R/W	0
1019	Tuning ON / OFF 0 = Tuning off 1 = Tuning on	R/W	0
1020	Automatic / Manual selection 0 = Automatic 1 = Manual	R/W	0
1021	OFF LINE ³ time (milliseconds)	R/W	?
1022	Digital input status 0 = Input OFF 1 = Input ON	RO	?
1023	Instantaneous current value (tenth of ampere)	RO	0
1024	Current ON value (tenth of ampere)	RO	0
1025	Current OFF value (tenth of ampere)	RO	0
1100	Process with decimal point selection	RO	?
1101	Setpoint 1 with decimal point selection	R/W	EEPROM
1102	Setpoint 2 with decimal point selection	R/W	EEPROM
1103	Setpoint 3 with decimal point selection	R/W	EEPROM
1104	Setpoint 4 with decimal point selection	R/W	EEPROM
1105	Alarm 1 with decimal point selection	R/W	EEPROM
1106	Alarm 2 with decimal point selection	R/W	EEPROM
1107	Alarm 3 with decimal point selection	R/W	EEPROM
1108	Alarm 4 with decimal point selection	R/W	EEPROM
1109	Real setpoint (gradient) with decimal point selection	RO	EEPROM
1110	Percentage heating output (0-1000)	R/W	0
1111	Percentage heating output (0-100)	R/W	0
1112	Percentage cooling output (0-1000)	RO	0
1113	Percentage cooling output (0-100)	RO	0
2001	Parameter 1	R/W	EEPROM
....	R/W	EEPROM
2100	Parameter 100	R/W	EEPROM
4001	Parameter 1 ⁴	R/W	EEPROM
....	R/W	EEPROM
4100	Parameter 100	R/W	EEPROM

















³ If it is 0, control is disabled. If it is different from 0, it is "maximum time that can elapse between two pollings before the controller goes off-line".
If it goes Off-line, the controller goes.

⁴ Parameters changed using serial address from 4001 to 4100 are saved in eeprom only after 10" after the last writing of parameters.

10 Configuration

10.1 Modify configuration parameters

For configuration parameters see next paragraph.

Press	Display	Do
1  for 3 second	Display 1 shows  with the 1 st digit flashing, while display 2 shows  .	
2  or 	Modify flashing digit and move to next digit with  .	Enter password:  .
3  to confirm	Display 1 shows first parameter and second display shows its value.	
4  or 	Scroll parameters.	
5 	Allows to pass from mnemonic parameter code to the numeric one and viceversa.	
6 	Allows parameter modification (display 2 flashes).	
7  or 	Increases or decreases visualized value.	Introduce new data.
8 	Confirms data entering (display 2 stops flashing).	To change another parameter return to point 4.
9 	End of parameters modification Controller exits the programming mode.	

11 Table of Configuration Parameters

The following table includes all parameters. Some of them will not be visible on the models which are not provided with relevant Hardware data.

1 **c.out** **Command Output:** Command output type selection



c.o.l

Default (necessary for using process and setpoint retransmission function with Volt / mA output)

c.wAL

c.S5r

c.420

c.020

c.0.10

ATR401-22ABC

	COMMAND	ALARM 1	ALARM 2
c.o.l	Q1	Q2	SSR
c.wAL	Q1 3-4 (open) / 4-5 (close)	Q2	SSR
c.S5r	SSR	Q1	Q2

ATR401-23ABC

	COMMAND	ALARM 1	ALARM 2	ALARM 3
c.o.l	Q1	Q2	Q3	SSR
c.wAL	Q1 3-4 (open) / 4-5 (close)	Q2	Q3	SSR
c.S5r	SSR	Q1	Q2	Q3

ATR401-24ABC

	COMMAND	ALARM 1	ALARM 2	ALARM 3	ALARM 4
c.o.l	Q1	Q2	Q3	Q4	SSR
c.wAL	Q1 3-4 (open) / 4-5 (close)	Q2	Q3	Q4	SSR
c.S5r	SSR	Q1	Q2	Q3	Q4

ATR401-22ABC-T

	COMMAND	ALARM 1	ALARM 2	ALARM 3
c.o.l	Q1	Q2	SSR	AO1(V)
c.wAL	Q1 3-4 (open) / 4-5 (close)	Q2	SSR	AO1(V)
c.S5r	SSR	Q1	Q2	AO1(V)
c.420	4...20 mA	Q1	Q2	SSR
c.020	0...20 mA	Q1	Q2	SSR
c.0.10	0...10 V	Q1	Q2	SSR

2 **SEn** | **Sensor:** Analog input configuration / sensor selection (AI1)



d.S	Disabled
Ec.T	Tc-K (Default) -260...1360 °C
Ec.S	Tc-S -40...1760 °C
Ec.R	Tc-R -40...1760 °C
Ec.J	Tc-J -200...1200 °C
PE	PT100 -200...600 °C
PEI	PT100 -200...140 °C
NI	NI100 -60...180 °C
nTc	NTC10K -40...125 °C
PEc	PTC1K -50...150 °C
PE5	PT500 -100...600 °C
PE1K	PT1000 -100...600 °C
0-10	0...10 Volt
0-20	0...20 mA
4-20	4...20 mA
0.40	0...40 mVolt
Pot.1	Potentiometer max 6 Kohm
Pot.2	Potentiometer max 150 Kohm

3 **dp.** | **Decimal Point:** Select type of visualized decimal point for Analogic Input 1

0	Default
00	1 Decimal
000	2 Decimal
0000	3 Decimal

4 **LL.L** | **Lower Linear Input 1:** AI1 lower range limit only for linear signals. Example: with input 4...20 mA this parameter takes value associated to 4 mA **-999...+9999 digit***, **Default: 0.**



* The display of the decimal point depends on the setting of parameter **SEn** and the parameter **dp.**

5  **Upper Linear Input 1:** AI1 upper range limit only for linear signals. Example: with input 4...20 mA this parameter takes value associated to 20 mA -999...+9999 digit*, **Default: 1000.**



6  **Offset Calibration 1:** Offset AI1 calibration. Number added to visualized process value (normally correcting ambient temperature value) -999...+1000 digit* for linear sensors and potentiometers. -99.9...+100.0 tenths for temperature sensors, **Default: 0.0.**

7  **Gain Calibration 1:** AI1 gain calibration. % Value multiplied with displayed value to calibrate process value -99.9%...+100.0%, **Default: 0.0.**

8  **Latch-On 1:** Automatic setting of limits for linear input

 Disabled (**Default**)

 Standard

 Virtual Zero Stored (see paragraph 8.9)

 Virtual Zero Initialized (see paragraph 8.9)

9  **Lower Limit Setpoint 1:** AI1 lower limit setpoint

-999...+9999 digit* (degrees if temperature), **Default: 0.**



10  **Upper Limit Setpoint 1:** AI1 upper limit setpoint

-999...+9999 digit* (degrees if temperature), **Default: 1750.**



11  **Sensor 2:** Analogue input 2 configuration / sensor selection AI2

 Disabled (**Default**)

 Tc-K -260...1360 °C

 Tc-S -40...1760 °C

 Tc-R -40...1760 °C

 Tc-J -200...1200 °C



 PT100 -200...600 °C

 PT100 -200...140 °C

 NI100 -60...180 °C

 NTC10K -40...125 °C

 PTC1K -50...150 °C

* The display of the decimal point depends on the setting of parameter  and the parameter .

<input type="text" value="PT5"/>	PT500	-100...600 °C
<input type="text" value="PT1"/>	PT1000	-100...600 °C
<input type="text" value="0-10"/>	0...10 Volt	
<input type="text" value="0-20"/>	0...20 mA	
<input type="text" value="4-20"/>	4...20 mA	
<input type="text" value="040"/>	0...40 mVolt	
<input type="text" value="Pot1"/>	Potenc. max 6 Kohm (full scale)	
<input type="text" value="Pot2"/>	Potenc. max 150 Kohm (full scale)	
<input type="text" value="tA"/>	Current measured by amperometric transformer	

12 **Decimal Point 2:** Select decimal type visualized for analogue input 2

<input type="text" value="0"/>	Default
<input type="text" value="00"/>	1 Decimal
<input type="text" value="000"/>	2 Decimal
<input type="text" value="0000"/>	3 Decimal

13 **Lower Linear Input 2:** AI2 lower range limit only for linear signals. Example: with input 4...20 mA this parameter takes value associated to 4 mA
-999...+9999 digit*, **Default: 0.**

14 **Upper Linear Input 2:** AI2 upper range limit only for linear signals. Example: with input 4...20 mA this parameter takes value associated to 20 mA
-999...+9999 digit*, **Default: 1000.**

15 **Offset Calibration 2:** AI2 offset calibration. Number added to visualized process value (normally correcting ambient temperature value)
-999...+1000 digit* for linear sensors and potentiometers.
-99.9...+100.0 tenths for temperature sensors, **Default: 0.0.**

16 **Gain Calibration 2:** AI2 Gain calibration. % Value multiplied with displayed value to calibrate process value
-99.9%...+100.0%, **Default: 0.0.**

17 **Lower Limit Setpoint 2:** AI2 lower limit setpoint
-999...+9999 digit* (degrees if temperature), **Default: 0.**

* The display of the decimal point depends on the setting of parameter and the parameter

18 **UL52** **Upper Limit Setpoint 2:** AI2 upper limit setpoint 

-999...+9999 digit* (degrees if temperature), **Default: 1750.**

19 **cPro** **Command Process:** Selects process value related to command output and visualized on display 1.
This determinates which is the primary process

Pro1 Process 1 (**Default**)

Pro2 Process 2

MEAN Processes mean

DIFF Processes difference

ABSd Processes difference as absolute value

SuN AI1+AI2 Input addition

20 **rENS** **Remote Setpoint:** Enables remote setpoint.
Command setpoint is the secondary process.
It works if **Pro1** or **Pro2** is selected on parameter **cPro**

dIS Disabled (**Default**)

En Enabled

21 **ActE** **Command Action Type:** Regulation type for command output

HEAT Heating (N.O.) (**Default**)

COOL Cooling (N.C.)

HOOS Lock command above SPV.

Example: command output disabled when reaching setpoint,
also with P.I.D. value different from 0

22 **cHY** **Command Hysteresis:** Hysteresis in ON / OFF or dead band in P.I.D.

0.0-999.9 digit* (tenth of degree if temperature), **Default: 0.**

23 **cRE** **Command Rearmament:** Type of reset for contact of command output (always automatic in P.I.D. functioning)

RE Automatic Reset (**Default**)

rE Manual Reset by keyboard

rES Manual reset stored
(keeps relay status also after an eventual power failure)

* The display of the decimal point depends on the setting of parameter **SEn** and the parameter **dp.**

- 24 **c. SE** **Command State Error:** Contact state for command output in case of error
- ca** Open contact (**Default**)
- cc** Closed contact
- 25 **c. Ld** **Command Led:** Defines led C1 state corresponding to relevant contact
- ca** ON with open contact
- cc** ON with closed contact (**Default**)
- 26 **c. dE** **Command Delay:** Command delay (only in ON / OFF functioning). (In case of servo valve it works also in P.I.D. and represents delay between opening and closure of two contacts) **-600...+600** seconds (tenth of second in case of servo valve).
Negative: delay when turning off.
Positive: delay when turning on.
Default: 0.
- 27 **c. SP.** **Command Setpoint Protection:** Allows or not to change command setpoint value by keyboard
- FrEE** Modification allowed (**Default**)
- Loct** Protected
- 28 **tunE** **Tune:** Autotuning type selection
- d,5** Disabled (**Default**)
- Auto** Automatic (P.I.D. parameters calculation at each activation and / or each change)
- MAN** Manual (launch by keyboards or by digital input)
- oncE** Once (P.I.D. parameters calculation only at first start)
- 29 **sdEtu** **Setpoint Deviation Tune:** Selects deviation from command setpoint as threshold used by autotuning to calculate P.I.D. parameters
0...5000 digit* (tenth of degree if temperature), **Default: 10.0.**
- 30 **Ph** **Proportional Band:** Process inertia in units (example: °C if temperature)
0 ON / OFF if also **E₁** is equal to 0 (**Default**).
1...9999 digit* (tenth of degree if temperature).

* The display of the decimal point depends on the setting of parameter **SEn** and the parameter **dp.**

- 31 **Integral Time:** Process inertia in seconds
0.0...999.9 seconds. 0 integral disabled, **Default: 0.0.**
- 32 **Derivative Time:** Normally ¼ of integral time
0.0...999.9 seconds. 0 derivative disabled, **Default: 0.0.**
- 33 **Cycle Time:** Cycle time (for P.I.D. on remote control switch 10 / 15 sec., for P.I.D. on SSR 1 sec.) or servo time (value declared by servo-motor manufacturer)
0.1...300.0 seconds, **Default: 10.0.**
- 34 **Lower Limit Output Percentage:** Select minimum value for command output percentage
0...100%, **Default: 0%.**
Example: with selected as 0...10 V and set at 10%, command output can change from a min. of 1 V to a max. of 10 V.
- 35 **Upper Limit Output Percentage:** Selects maximum value for command output percentage
0...100%, **Default: 100%.**
- 36 **Degree:** Select degree type
 Centigrade (**Default**)
 Fahrenheit
- 37 **Alarm 1:** Alarm 1 selection.
Alarm intervention is correlated to AL1
- Disabled (**Default**)
- Absolute alarm, referring to process
- Band alarm
- Upper deviation alarm
- Lower deviation alarm
- Absolute alarm, referring to command setpoint
- Status alarm (active in Run / Start)
- Cooling action
- Status alarm "load control" (Loop Break Alarm)
Example: status of contactors / SSR or heating elements



* The display of the decimal point depends on the setting of parameter and the parameter

38 **A1Pr** **Alarm 1 Hysteresis:** Select value correlated to alarm 1

- Pr01** Process 1 (**Default**)
- Pr02** Process 2
- MEAn** Processes mean
- dIFF** Processes difference
- AbSd** Processes difference as absolute value
- Sum** AI1+AI2 Input addition

39 **A1So** **Alarm 1 State Output:** Alarm 1 output contact and intervention type

- no S** (N.O. start) Normally open, active at start
- nc S** (N.C. start) Normally closed, active at start
- no E** (N.O. threshold) Normally open, active on reaching alarm⁵
- nc E** (N.C. threshold) Normally closed, active on reaching alarm⁵

40 **A1Hy** **Alarm 1 Hysteresis**
-999...+999 digit* (tenths of degree if temperature), **Default: 0.0.**

41 **A1rE** **Alarm 1 Rearmament:** Type of reset for contact of alarm 1

- rE** Automatic Reset (**Default**)
- nE** Manual Reset by keyboard
- nES** Manual reset stored (keeps relay status also after an eventual power failure)

42 **A1SE** **Alarm 1 State Error:** Contact status for alarm 1 output in case of error

- co** Open contact (**Default**)
- cc** Closed contact

43 **A1Ld** **Alarm 1 Led:** Defines led A1 status corresponding to relevant contact

- co** ON with open contact
- cc** ON with closed contact (**Default**)

⁵ On activation, the output is inhibited if the controller is in alarm mode. Activates only if alarm condition reappears, after that it was restored.

* The display of the decimal point depends on the setting of parameter **SEn** and the parameter **dP.**

- 44 **ALDE** **Alarm 1 Delay**
-600...+600 seconds.
 Negative: delay at exit from alarm.
 Positive: delay at starting of alarm.
Default: 0.
- 45 **ALSP** **Alarm 1 Setpoint Protection:** Alarm 1 set protection.
 Does not allow the user to change setpoint
- Free** Modification allowed (**Default**)
Loct Protected
Hide Protected and not visualized
- 46 **AL2** **Alarm 2:** Alarm 2 selection.
 Alarm intervention is associated to AL2
- dis** Disabled (**Default**)
AL Absolute alarm, referring to process
band Band alarm
hdAL Upper deviation alarm
ldAL Lower deviation alarm
acAL Absolute alarm, referring to command setpoint
stAL Status alarm (active in Run / Start)
cool Cooling action
lbr Status alarm "load control" (Loop Break Alarm)
 Example: status of contactors / SSR or heating elements
- 47 **AL2Pr** **Alarm 2 Process:** Selects value related to alarm 2
- Pr1** Process 1 (**Default**)
Pr2 Process 2
MEAN Processes mean
dIFF Processes difference
AbSd Processes difference as absolute value
Sum AI1+AI2 Input addition
- 48 **AL2SO** **Alarm 2 State Output:** Alarm 2 output contact and intervention type
- no S** (N.O. start) Normally open, active at start
nc S (N.C. start) Normally closed, active at start

* The display of the decimal point depends on the setting of parameter **SEn** and the parameter **dp**.

- no t** (N.O. threshold) Normally open, active on reaching alarm⁶
- nc t** (N.C. threshold) Normally closed, active on reaching alarm⁶

49 **A2H4** **Alarm 2 Hysteresis**
 -999...+999 digit* (tenth of degree if temperature), **Default: 0.0**.

50 **A2rE** **Alarm 2 Rearmament:** Type of reset for alarm 2 contact

rE Automatic Reset (**Default**)

nE Manual Reset by keyboard

rES Manual reset stored
 (keeps relay status also after an eventual power failure)

51 **A2SE** **Alarm 2 State Error:** Contact status for alarm 2 output in case of error

co Open contact (**Default**)

cc Closed contact

52 **A2Ld** **Alarm 2 Led:** Defines led A2 status corresponding to relevant contact

co ON with open contact

cc ON with closed contact (**Default**)

53 **A2dE** **Alarm 2 Delay**
 -600...+600 seconds.

Negative: delay at exit from alarm.

Positive: delay at starting of alarm.

Default: 0.

54 **A2SP** **Alarm 2 Setpoint Protection:** Alarm 2 set protection.
 Does not allow the user to change set value

FrEE Modification allowed (**Default**)

Loct Protected

HiDE Protected and not visualized

⁶ On activation, the output is inhibited if the controller is in alarm mode. Activates only if alarm condition reappears, after that it was restored.

* The display of the decimal point depends on the setting of parameter **SEn** and the parameter **dP**.

- 55 **AL 3** **Alarm 3:** Alarm 3 selection.
Alarm intervention is associated to AL3
- d 5** Disabled (**Default**)
- A AL** Absolute alarm, referring to process
- b AL** Band alarm
- HdAL** Upper deviation alarm
- LdAL** Lower deviation alarm
- AcAL** Absolute alarm, referring to command setpoint
- StAL** Status alarm (active in Run / Start)
- cool** Cooling action
- LbA** Status alarm "load control" (Loop Break Alarm)
Example: status of contactors / SSR or heating elements

- 56 **A3Pr** **Alarm 3 Process:** Selects value correlated to alarm 3

- Pr01** Process 1 (**Default**)
- Pr02** Process 2
- MEAn** Processes mean
- d iFF** Processes difference
- AbSd** Processes difference as absolute value
- Sum** AI1+AI2 Input addition

- 57 **A3So** **Alarm 3 State Output:** Alarm 3 output contact and intervention type

- no S** (N.O. start) Normally open, active at start
- nc S** (N.C. start) Normally closed, active at start
- no t** (N.O. threshold) Normally open, active on reaching alarm⁷
- nc t** (N.C. threshold) Normally closed, active on reaching alarm⁷

- 58 **A3H4** **Alarm 3 Hysteresis**
-999...+999 digit* (tenths of degree if temperature), **Default: 0.0.**

⁷ On activation, the output is inhibited if the controller is in alarm mode. Activates only if alarm condition reappears, after that it was restored.

* The display of the decimal point depends on the setting of parameter **SEn** and the parameter **dP.**

59 **A3rE** **Alarm 3 Rearmament:** Type of reset for alarm 3 contact

rE Automatic Reset (**Default**)

rE Manual Reset by keyboard

rES Manual reset stored
(keeps relay status also after an eventual power failure)

60 **A3SE** **Alarm 3 State Error:** Contact status for alarm 3 output in case of error

co Open contact (**Default**)

cc Closed contact

61 **A3Ld** **Alarm 3 Led:** Defines led A3 status corresponding to relevant contact

co ON with open contact

cc ON with closed contact (**Default**)

62 **A3dE** **Alarm 3 Delay**

-600...+600 seconds.

Negative: delay at exit from alarm.

Positive: delay at starting of alarm.

Default: 0.

63 **A3SP** **Alarm 3 Setpoint Protection:** Alarm 3 set protection.
Does not allow the user to change set value

FrEE Modification allowed (**Default**)

Loct Protected

H idE Protected and not visualized

64 **AL 4** **Alarm 4:** Alarm 4 selection.
Alarm intervention is associated to AL4

d is Disabled (**Default**)

A AL Absolute alarm, referring to process

b AL Band alarm

HdAL Upper deviation alarm

LdAL Lower deviation alarm

AcAL Absolute alarm, referring to command setpoint

StAL Status alarm (active in Run / Start)

cool Cooling action

LbA Status alarm "load control" (Loop Break Alarm)
Example: status of contactors / SSR or heating elements

- 65 **A4Pr** **Alarm 4 Process:** Selects value correlated to alarm 4
- Pr01** Process 1 (**Default**)
 - Pr02** Process 2
 - MEAn** Processes mean
 - dIFF** Processes difference
 - AbSd** Processes difference as absolute value
 - Sum** AI1+AI2 Input addition
- 66 **A4So** **Alarm 4 State Output:** Alarm 4 output contact and intervention type
- no S** (N.O. start) Normally open, active at start
 - nc S** (N.C. start) Normally closed, active at start
 - no E** (N.O. threshold) Normally open, active on reaching alarm⁸
 - nc E** (N.C. threshold) Normally closed, active on reaching alarm⁸
- 67 **A4H4** **Alarm 4 Hysteresis**
-999...+999 digit* (tenths of degree if temperature), **Default: 0.0**.
- 68 **A4rE** **Alarm 4 Rearmament:** Type of reset for alarm 4 contact
- rE** Automatic Reset (**Default**)
 - nE** Manual Reset by keyboard
 - nES** Manual reset stored
(keeps relay status also after an eventual power failure)
- 69 **A4SE** **Alarm 4 State Error:** Contact status for alarm 4 output in case of error
- co** Open contact (**Default**)
 - cc** Closed contact
- 70 **A4Ld** **Alarm 4 Led:** Defines led A4 status corresponding to relevant contact
- co** ON with open contact
 - cc** ON with closed contact (**Default**)

⁸ On activation, the output is inhibited if the controller is in alarm mode. Activates only if alarm condition reappears, after that it was restored.

* The display of the decimal point depends on the setting of parameter **SEn** and the parameter **dP.**

- 71 **R4dE** **Alarm 4 Delay**
-600...+600 seconds.
 Negative: delay at exit from alarm.
 Positive: delay at starting of alarm.
Default: 0.
- 72 **R4SP** **Alarm 4 Setpoint Protection:** Alarm 4 set protection.
 Does not allow the user to change set value
- FrEE** Modification allowed (**Default**)
- Loct** Protected
- Hide** Protected and not visualized
- 73 **EA** **Amperometric Transformer:** Activation and range for amperometric transformer
0 Disabled (**Default**)
1...200 Ampere
- 74 **LbAd** **Loop Break Alarm Threshold:** Loop Break Alarm intervention threshold
0.0 Disabled alarm
0.1...200.0 Ampere
Default: 50.0
- 75 **LbAd** **Loop Break Alarm Delay:** Loop Break Alarm intervention delay
00.00...60.00 mm.ss
Default: 01.00
- 76 **cooF** **Cooling Fluid:** Type of refrigerant fluid for heating / cooling P.I.D.
- Air** Air (**Default**)
- oil** Oil
- H2o** Water
- 77 **PbN** **Proportional Band Multiplier:** Proportional band for cooling action is given by parameter 30 multiplied for this parameter
1.00...5.00
Default: 1.00

78 **oadb** **Overlap / Dead Band:** Dead band combination for heating / cooling P.I.D.
-20.0...50.0%.
Negative: Dead band.
Positive: overlap.
Default: 0.0.

79 **coctc** **Cooling Cycle Time:** Cycle Time for Cooling output
1...300 seconds
Default: 10

80 **cFLE** **Conversion Filter:** ADC Filter: Number of sensor readings to calculate mean that defines process value.
N.B.: When readings increase, control loop speed slows down

d 5	Disabled
2 5	2 Samples Mean
3 5	3 Samples Mean
4 5	4 Samples Mean
5 5	5 Samples Mean
6 5	6 Samples Mean
7 5	7 Samples Mean
8 5	8 Samples Mean
9 5	9 Samples Mean
10 5	10 Samples Mean
11 5	11 Samples Mean
12 5	12 Samples Mean
13 5	13 Samples Mean
14 5	14 Samples Mean
15 5	15 Samples Mean

81 **cFrc** **Conversion Frequency:** Sampling frequency of digital / analogue converter.
N.B.: Increasing the conversion speed will slow down reading stability (example: for fast transients, as the pressure, it is advisable to increase sampling frequency)

242H	242 Hz (Maximum speed conversion)
123H	123 Hz
62 H	62 Hz
50 H	50 Hz
39 H	39 Hz

<input type="checkbox"/> 33.2H	33.2 Hz
<input type="checkbox"/> 19.6H	19.6 Hz
<input type="checkbox"/> 16.7H	16.7 Hz (Default) Ideal for filtering noises 50 / 60 Hz
<input type="checkbox"/> 12.5H	12.5 Hz
<input type="checkbox"/> 10 H	10 Hz
<input type="checkbox"/> 8.33H	8.33 Hz
<input type="checkbox"/> 6.25H	6.25 Hz
<input type="checkbox"/> 4.17H	4.17 Hz (Minimum speed conversion)

82 **Visualization Filter:** Slow down the update of process value visualized on display, to simplify reading

<input type="checkbox"/> d.s	Disabled with pitchfork (maximum speed of display update)
<input type="checkbox"/> F.or.	First order filter with pitchfork
<input type="checkbox"/> 2.SN	2 Samples Mean
<input type="checkbox"/> 3.SN	3 Samples Mean
<input type="checkbox"/> 4.SN	4 Samples Mean
<input type="checkbox"/> 5.SN	5 Samples Mean
<input type="checkbox"/> 6.SN	6 Samples Mean
<input type="checkbox"/> 7.SN	7 Samples Mean
<input type="checkbox"/> 8.SN	8 Samples Mean
<input type="checkbox"/> 9.SN	9 Samples Mean
<input type="checkbox"/> 10.SN	10 Samples Mean (Maximum slow down of display update)
<input type="checkbox"/> null	Disabled without pitchfork
<input type="checkbox"/> F.o.2	First order filter

83 **Automatic / Manual:** Enables automatic / manual selection

<input type="checkbox"/> d.s	Disabled (Default)
<input type="checkbox"/> En	Enabled
<input type="checkbox"/> EnSt.	Enabled with memory

84 **Digital Input**

<input type="checkbox"/> d.s	Disabled (Default: 0)
<input type="checkbox"/> 2.S	2 Setpoints Switch
<input type="checkbox"/> 2.S.I	2 Setpoints Switch Impulsive
<input type="checkbox"/> 3.S	3 Setpoints Switch Impulsive
<input type="checkbox"/> 4.S	4 Setpoints Switch Impulsive

StSt	Start / Stop
rno	Run N.O. (enables regulation with N.O. contact)
rnC	Run N.C. (enables regulation with N.C. contact)
Lno	Lock conversion N.O. (stop conversion and display value with N.O.)
LnC	Lock conversion N.C. (stop conversion and display value with N.C.)
tunE	Manual Tune (by digital input)
ANAI	Automatic / Manual Impulse (if enabled on parameter 83)
ANAc	Automatic / Manual Contact (if enabled on parameter 83)
Actt	Action Type. Heating regulation with open D.I. Cooling regulation with closed D.I.

85 **rGr** **Rising Gradient:** Rising gradient for Soft-Start
0 Disabled.
1...9999 digit/hour* (degrees/hour with decimal visualization if temperature), **Default: 0.**

86 **uId2** **Visualization Display 2:** Set visualization on display 2

outP	Output Percentage
ANP	Ampere
cSPu	Command Setpoint (Default)
Pro1	Process 1
Pro2	Process 2
NEAn	Processes mean
dIFF	Processes difference
AbSd	Processes difference as absolute value
SuN	AI1+AI2 Input addition

87 **uIt4** **Visualization Type:** Set visualization type on display

Std	Display 1 process + Display 2 as uId2 (Default)
d2H	Display 1 process + Display 2 as uId2 hidden after 3 sec.
SUAP	Display 1 as uId2 + Display 2 process
Sd2H	Display 1 as uId2 + Display 2 process hidden after 3 sec.

88 **rEtr** **Retransmission:** Retransmission for output 0...10 V or 0/4...20 mA. Parameters 90 and 91 defines upper/lower limit of scale

dIs	Disabled (Default)
cSPu	Command Setpoint

* The display of the decimal point depends on the setting of parameter **SEn** and the parameter **dP**.

- 88 **rEtr.** **Retransmission:** Retransmission for output 0...10 V or 0/4...20 mA. Parameters 90 and 91 defines upper/lower limit of scale
- Pr_{o1}** Process 1
- Pr_{o2}** Process 2
- MEAn** Processes Mean
- dIFF** Processes Difference
- ABSd** Processes Difference as absolute value
- SuN** AI1+AI2 Input addition
- 89 **rEty** **Retransmission Type:** Select retransmission type
- 0-10** 0...10 Volt **(Default)**
- 0-20** 0...20 mA
- 4-20** 4...20 mA
- 90 **LoLr.** **Lower Limit Retransmission:** Lower limit analogue output range -999...9999 digit* (degrees if temperature), **Default: 0.**
- 91 **uPLr.** **Upper Limit Retransmission:** Upper limit analogue output range -999...9999 digit* (degrees if temperature), **Default: 1000.**
- 92 **bdRt.** **Baud Rate:** Selects baudrate for serial communication
- 48 F** 4800 bit/s
- 96 F** 9600 bit/s
- 192 F** 19200 bit/s **(Default)**
- 288 F** 28800 bit/s
- 384 F** 39400 bit/s
- 576 F** 57600 bit/s
- 1152** 115200 bit/s
- 93 **SLAd** **Slave Address:** Selects slave address for serial communication
1 – 254
Default: 254
- 94 **SEdE.** **Serial Delay:** Selects serial delay
0 – 100 milliseconds
Default: 20

* The display of the decimal point depends on the setting of parameter **SEn** and the parameter **dp.**

Absolute Alarm or Threshold Alarm (**AL** selection)

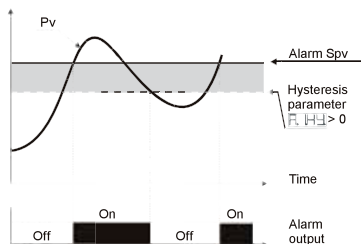

Absolute alarm with controller in heating functioning (par. 21 **ACTE** selected **HEAT**) and hysteresis value greater than "0" (par. 40 **A.HY** > 0).

N.B.

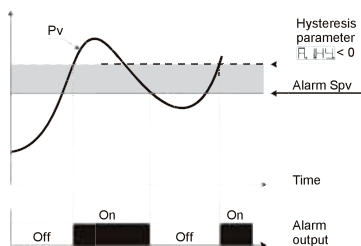

Absolute alarm with controller in heating functioning (par. 21 **ACTE** selected **HEAT**) and hysteresis value less than "0" (par. 40 **A.HY** < 0).

N.B.

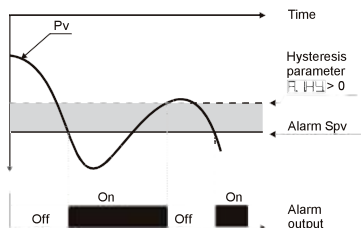

Absolute alarm with controller in cooling functioning (par. 21 **ACTE** selected **COOL**) and hysteresis value than "0" (par. 40 **A.HY** > 0).

N.B.

N.B.: The example is related to alarm 1; function can be enabled also for alarms 2, 3 and 4 on models that include them.

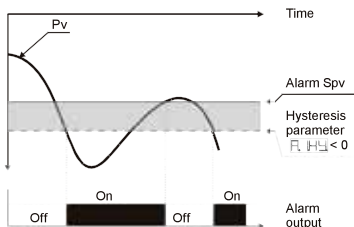

Absolute alarm with controller in cooling functioning (par. 21 **ACTE** selected **COOL**) hysteresis value minor than "0" (par. 40 **R.I.H.Y** < 0).

N.B.

Absolute Alarm or Threshold Alarm Referring to Setpoint Command (selection **ACAL**)

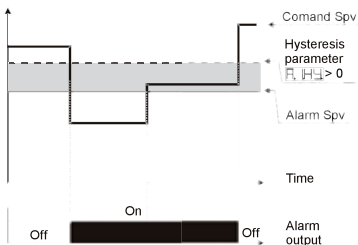

Absolute alarm refers to the command set, with the controller in heating functioning (par. 21 **ACTE** selected **HEAT**) hysteresis value greater than "0" (par. 40 **R.I.H.Y** > 0).

Command set can be changed by pressing the arrow keys on front panel.

N.B.

N.B.: The example is related to alarm 1; function can be enabled also for alarms 2, 3 and 4 on models that include them.

Band Alarm (selection **AL**)

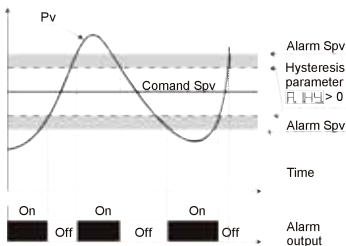

Band alarm with hysteresis value greater than "0".
(par. 40 **R_{HY}** > 0).

N.B.

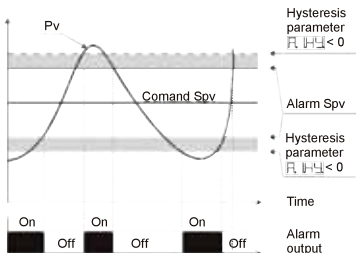

Band alarm with hysteresis value minor than "0".
(par. 40 **R_{HY}** < 0).

N.B.

N.B.: The example is related to alarm 1; function can be enabled also for alarms 2, 3 and 4 on models that include them.

Upper Deviation Alarm (selection **HDAL**)

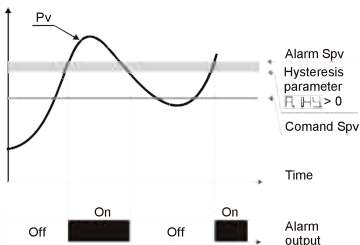

Upper deviation alarm value of alarm setpoint greater than "0" and hysteresis value greater than "0".
(par. 40 **R_{HY}** > 0).

N.B.²

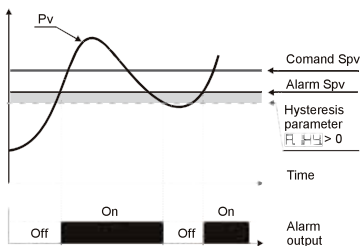

Lower Deviation Alarm (selection \boxed{HdAL})

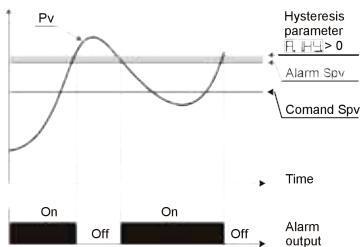
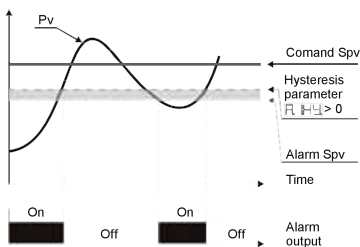

N.B.²: a) The example is related to alarm 1; function can be enabled also for alarms 2, 3 and 4 on models that include them.

b) With hysteresis minor than "0" ($\boxed{R.I.H.Y} < 0$) dotted line moves below alarm setpoint.

13 Table of Anomaly Signals

If installation malfunctions, controller will switch off regulation output and will report the anomaly.

For example, controller will report failure of a connected thermocouple visualizing $E-05$ (flashing) flashing on display.

For other signals see table below.

#	Cause	What to do
E-01 $SYSE$	EEPROM programming error.	Call Assistance.
E-02 $SYSE$	Cold junction temperature sensor failure or environment temperature out of range.	Call Assistance.
E-04 $SYSE$	Incorrect configuration data. Possible loss of instrument calibration.	Verify that configuration parameters are correct.
E-05 Pr_{o1}	Sensor connected to AI1 broken or temperature out of range.	Control connection with probes and their integrity.
E-06 Pr_{o2}	Sensor connected to AI2 broken or temperature out of range.	Control connection with probes and their integrity.
E-08 $SYSE$	Missing calibration.	Call Assistance.
E-10 $cPAR$	Incorrect control parameters.	Verify control parameters.
E-11 $APAR$	Incorrect alarms parameters.	Verify alarm parameters.
E-12 $rPAR$	Incorrect retransmission parameters.	Verify retransmission parameters.
E-13 $uPAR$	Incorrect visualization parameters.	Verify visualization parameters.
E-14 $SPAR$	Incorrect remote setpoint parameters.	Verify remote setpoint parameters.

14 Configuration EASY-UP



To Simplify the setting of parameters and the integration of the different components involved in the control system, Pixsys introduces the EASY-UP coding which allows to set sensors and/or command outputs in one single step.

By means of the code listed in the data sheet enclosed to the sensor or actuator (SSR, motorized valve, etc.) the EASY-UP coding will set the relevant main parameters on the controllers (ex. selection of PT100 on parameter "Sensor" and the corresponding measuring range on parameters "Lower and Upper limits of the setpoint").

Different codes may be entered on the controllers in sequence to configure inputs, control output or retransmission of signal.



15 Summary of Configuration parameters

Date:	Model ATR401:
Installer:	System:
Notes:	

cout	Select type of command output
SEn1	Analogue input 1 configuration
DP. 1	Select type of decimal visualized by sensor 1
LL. 1	AI1 range lower limit only for linear
UL. 1	AI1 range upper limit only for linear
ocA1	AI1 Offset calibration
GcA1	AI1 Gain calibration
Ltc. 1	Limits automatic setting for linear inputs
ULS1	AI1 setpoint lower limit
uLS1	AI1 setpoint upper limit
SEn2	Analogue input 2 configuration
DP. 2	Select type of decimal visualized by sensor 2
LL. 2	AI2 range lower limit only for linear
UL. 2	AI2 range upper limit only for linear
ocA2	AI2 offset calibration
GcA2	AI2 gain calibration
ULS2	AI2 setpoint lower limit
uLS2	AI2 setpoint upper limit
CPrcd	Select process value related to command output
rENS	Enable remote setpoint
Actct	Regulation type for command output
c. HY	Hysteresis in ON / OFF or dead band in P.I.D.
c. rE	Command contact reset type
c. SE	Contact status for command output in case of error
c. Ld	C1 led status in correspondence of relevant contact
c. dE	Command delay
c. SP.	Command setpoint protection
tunE	Autotuning type selection
Sdtw	Deviation from command setpoint for autotuning
Pb	Proportional band

E_i	Integral time
E_d	Derivative time
E_c	Cycle time
U_{LoP}	Minimum value for command output percentage
u_{LoP}	Maximum value for command output percentage
dEG_r	Degrees type
AL 1	Alarm 1 selection
A1P_r	Select process value related to alarm 1
A1S_o	Alarm 1 output contact and intervention type
A1H_y	Alarm 1 hysteresis
A1rE	Alarm 1 contact reset type
A1SE	Alarm 1 output contact status in case of error
A1L_d	Led A1 status in correspondance of relevant contact
A1dE	Alarm 1 delay
A1SP	Alarm 1 set protection
AL 2	Alarm 2 selection
A2P_r	Select process value related to alarm 2
A2S_o	Alarm 2 output contact and intervention type
A2H_y	Alarm 2 hysteresis
A2rE	Alarm 2 contact reset type
A2SE	Alarm 2 output contact status in case of error
A2L_d	Led A2 status in correspondance of relevant contact
A2dE	Alarm 2 delay
A2SP	Alarm 2 set protection
AL 3	Alarm 3 selection
A3P_r	Select value related to alarm 3
A3S_o	Alarm 3 output contact and intervention type
A3H_y	Alarm 3 hysteresis
A3rE	Alarm 3 contact reset type
A3SE	Alarm 3 output contact status in case of error
A3L_d	Led A3 status in correspondance of relevant contact
A3dE	Alarm 3 delay
A3SP	Alarm 3 set protection
AL 4	Alarm 4 selection
A4P_r	Select value related to alarm 4

A4So	Alarm 4 output contact and intervention type
A4HY	Alarm 4 hysteresis
A4RE	Alarm 4 contact reset type
A4SE	Alarm 4 output contact status in case of error
A4Ld	Led A4 status in correspondance of relevant contact
A4dE	Alarm 4 delay
A4SP	Alarm 4 set protection
EA	Activation and scale range of amperometric transformer
LbAE	Loop Break Alarm intervention threshold
LbAd	Delay for Loop Break Alarm intervention
cooF	Cooling fluid type
PbN	Proportional band multiplier
oudb	Overlap / Dead band
coctc	Cooling output cycle time
eFLt	Adc filter
eFrc	Sampling frequency
uFLt	Filter in visualization
AuNA	Enable automatic / manual selection
dGE	Digital input functioning
rGr	Rising gradient
u d2	Set visualization on display 2
u t4	Set visualization type on displays
rEtr	Retransmission for output 0-10 V o 4...20 mA
rEt4	Select retransmission type
LoLr	Lower limit analogue output range
uPLr	Upper limit analogue output range
bdrE	Select baud rate for serial communication
SLAd	Select slave address
SEdE	Select serial delay

