



SECURITY ENERGIZER

Installation and User Manual



Edition 2.1, 2013



JVA ELECTRIC FENCE SYSTEMS



Thank you for choosing our product. The JVA brand is a range of electric fencing products carefully selected from leading manufacturers around the world to meet the needs of perimeter security.

THE JVA Z RANGE ENERGIZER CONCEPT

The JVA Range of Energizers has been collaboratively designed and manufactured by an international team with over 30 years of electric fence experience earned in some of the most testing security environments in the world. It aims to provide the very best low-cost, high-voltage security energizers in the world. They are compact, integrated and fully programmable electric fence energizers with built-in alarm units and LCD *out* and *return* voltage display. They also have the option of being controlled from a remote LCD keypad.

State-of-the-art energizer design IP4 x and ABS plastic

Unique LCD display depicting fence out and return voltage



Unique LCD keypad option depicting fence and alarm condition

Wall-mountable, robust energizer housing with easily detachable PCB chassis for ease of installation and repair

2-yr
WARRANTY

TWO-YEAR WARRANTY

All JVA products carry a 2-year warranty against defective components and workmanship. The warranty excludes damage caused by acts of Nature such as lightning or flooding, power supply surges, rough handling, malicious action or incorrect wiring.

Please retain your invoice as proof of purchase and fill in the warranty form on page 43.

JVA Z Energizer Range Concept



CONTENTS

- 1. INTRODUCTION 3
 - The JVA Z14 Story 3
- 2. FEATURES AND BENEFITS 4
- 3. SPECIFICATIONS 5
- 4. DESCRIPTION 6
 - 4.1 JVA Z14 Exterior 6
 - 4.2 LCD Voltage Display 7
 - 4.3 Status Lights 7
 - 4.4 Inputs and Outputs 7
 - 4.5 Status Codes 7
 - 4.6 Keypad (Optional) 8
 - 4.7 Keypad LCD screen 8
 - 4.8 Internal Beeper/Keypad Beeper 8
 - 4.9 Bi-Polar Option 9
 - 4.10 Cabling 9
 - 4.11 Lightning Protection 9
 - 4.12 Earth Loop Monitoring 9
 - 4.13 Noise and Interference 10
 - 4.14 Programmable Options 10
 - 4.15 Low Power mode 10
 - 4.16 Key Switch 10
 - 4.17 Gate Input 10
 - 4.18 Group Simultaneous Pulse Feature 10
 - Perimeter Patrol Lite (2x) Software 11
 - Perimeter Patrol 3.x Software 11
- 5. INSTALLATION 12
 - 5.1 Installation Steps 12
 - 5.2 JVA Z14 – Interior Configuration 13
 - 5.3 Examples of Fence Wiring Diagrams 14
 - 5.4 Installation Steps – Group Mode 16
- 6. OPERATION 18
 - 6.1 Control 18
 - 6.2 Arming the Fence Using the Keypad 18
 - 6.3 Turning to Low Power Mode 18
 - 6.4 When an Alarm Occurs 19
 - 6.5 To Silence the Alarm 19
 - 6.6 Changing the PIN Number 19
 - 6.7 Standby Battery 20
 - 6.8 Status Light 20
 - 6.9 Keypad Control in Brief 20
 - 6.10 Solar Power 20
- 7. TECHNICAL INFORMATION 21
 - 7.1 Power Options 22
 - 7.2 Status Codes 22
 - 7.3 Jumpers 22



- 8. INSTALLATION PROGRAMMING OPTIONS 23
 - 8.1 Programming Mode 23
 - 8.2 To Exit Programming Mode 23
 - 8.3 Changing the Installer PIN 23
 - 8.4 Changing an Option 23
 - 8.5 Programming Options in Brief 24
 - 8.6 Programming Options in Detail 25
 - 8.6.1 Power Level (01x#) 25
 - 8.6.2 Low Power Level (02x#) 25
 - 8.6.3 Fence Alarm Voltage (03x#) 25
 - 8.6.4 Low Power Alarm Level (05x#) 26
 - 8.6.5 Missed Pulse Count (06x#) 26
 - 8.6.6 Battery Alarm Voltage (07x#) 26
 - 8.6.7 Siren On Time (08x#) 27
 - 8.6.8 Siren Off Time (09x#) 27
 - 8.6.9 Siren Cycles (10x#) 27
 - 8.6.10 Input Inversion (11x#) 28
 - 8.6.11 Gate Input Function (12x#) 28
 - 8.6.12 Gate Entry/Exit Delay (13x#) 28
 - 8.6.13 Chime/Self-Resetting Mode (14x#) 28
 - 8.6.14 Fence Mode (15x#) 29
 - 8.6.15 Binary Options (16x#) 29
 - 8.6.16 Anti-bridging threshold (17x#) 29
 - 8.6.17 Binary Options 2 (18x#) 30
 - 8.6.18 Auto Re-arm Time (20x#) 31
 - 8.6.19 Relay Functions 31
 - 8.6.20 Relay Options explained 32
 - 8.6.21 Group Mode (26x#) 32
- 9. JVA Z14 ALPHA PLUS LCD KEYPAD FEATURES 33
 - 9.1 Using the Alpha Plus LCD Keypad 33
 - 9.2 Changing the Keypad Messages 34
 - 9.3 To Exit Keypad Programming 35
 - 9.4 Other Keypad Functions 35
 - 9.5 Multiple Keypads 35
- 10. SECTOR SETUP TESTS AND ADJUSTMENT 36
 - 10.1 Basic Fence Tests 36
 - 10.2 Fault Condition Tests 37
- 11. SOME STANDARD REQUIREMENTS FOR ELECTRIC SECURITY FENCES 38
 - 11.1 Definitions 38
 - 11.2 Installation, Operation and Maintenance 38
 - 11.3 Warning signs 39
 - 11.4 Gates 39
 - 11.5 Earthing 39
 - 11.6 Protection 40
- 12. WARRANTY 43

1. INTRODUCTION

Welcome to the world of JVA monitored electric security fences. The proliferation of non-lethal, monitored, electric security fences in our towns and cities is indicative of the confidence the public has in this form of perimeter security. The reason for this popularity is simple – monitored electric security fences are effective, economical, simple to install, and they offer more D's of security than any other perimeter system:

DEMARICATION – The JVA fence around your property shows you mean business.

DEFLECTION – Would-be intruders will be deflected to softer targets.

DETERRENCE – The safe, powerful JVA shock is a strong deterrent to intruders.

DELAY – The physical barrier will delay an intruder, something they do not like.

DETECTION – The JVA's voltage monitor warns you of any tampering with the fence.

DENY – A well-erected electric security fence will deny entry.

DEPENDABLE – 60 seconds a minute, 60 minutes an hour, 24 hours a day, 365 days a year, your JVA electric security fence is monitored by an alert, sober, electronic watchman.

Every second, the JVA Z14 energizer discharges a very short-duration, safe, high-voltage pulse down the fence live wire. The JVA Z14 then monitors the voltage at the end of this live wire, thereby checking that the voltage is being maintained along the entire fence line. In the event of a voltage drop caused by either shorting, cutting or poor maintenance, the monitor will trigger an alarm, thus alerting you.

Manufactured to meet the most stringent international safety standards, the JVA Z14 is in a class of its own when it comes to features and benefits at an affordable price.

An electric fence system which meets current safety regulations



2. FEATURES AND BENEFITS

★ Keypad option– can be used with up to 3 keypads	▶ <i>gives user flexible options</i>
★ Keypad programmable	▶ <i>can customise the energizer to unique fence conditions</i>
★ Wall-mountable, robust enclosure with easily detachable PCB chassis	▶ <i>for ease of installation and repair</i>
★ LCD voltage display and status lights	▶ <i>see fence voltage condition at a glance</i>
★ Internal 7Ah 12V rechargeable battery	▶ <i>ensures continued operation of your security system for up to 10 hours (Don't let power cuts compromise your security!)</i>
★ Adaptive Voltage Control	▶ <i>energizer automatically adjusts output voltage according to condition of fence</i>
★ Key switch operated with unique keys	▶ <i>limits tampering</i>
★ Choice of Low Power mode	▶ <i>ensures detection together with public safety during the day</i>
★ Switched +12V relay outputs for Siren and Strobe up to 30 Watts for 3 minutes. All relays may be assigned to any alarm function	▶ <i>audible and visual indication alerting user to breach of security</i> ▶ <i>versatility</i>
★ Earth monitor input	▶ <i>ensures that all the wires on the fence are monitored continually</i>
★ Enclosed fence terminals	▶ <i>tamper resistant and prevent accidental contact with high voltage</i>

- ★ Certified to meet IEC60335.2.76 and EMC standards (reports available on request)
- ★ Powerful 4 joules peak output energy
- ★ Gate input with entry/exit delay from gate input trigger
- ★ 2-Year Warranty
- ★ Powered from 16Vac directly into the unit
- ★ Status lights
- ★ State-of-the-art, robust case design IP4 x ABS
- ★ Good lightning protection from both mains and fence sides
- ★ AC fail, Low Battery and Bad Battery detection
- ★ Adjustable energizer power output level
- ★ Plug-in low voltage screw terminal connectors
- ★ Outputs may be wired for all live Bi-Polar fences
- ★ Microprocessor controlled
- ★ Internal beeper

3. SPECIFICATIONS

Specification Name	Specification
Energizer Output Voltage	9kV peak no load
Peak Output Energy	4.0 Joules at 500 Ohms, limited to 2.5J in group mode
Pulse Rate	Locked at 0.9 Hz
12v Dc Power Consumption	Energizer On – 550mA Average, 700mA peak Energizer Off – 28mA (40mA with keypad) Not including keypad or auxiliary power
Ac Power Input	16Vac 1A
Battery Charger Output	Float voltage 14V, 700mA , short circuit and reverse polarity protection
Siren and Strobe Outputs	Self-resetting fuse protection, switched 12V, rated at 30W (combined)
Enclosure	IP4x ABS plastic
Size	300mm high, 190mm wide, 115mm deep
Weight – packed, no battery	1.9kg
Weight – packed, with battery	4.25kg

- There are no user-serviceable parts in this unit.
- The installer is reminded that high voltages are retained for a while after switching off, and to wait for at least 10 minutes before opening the case.
- Before working on the high voltage wiring of an electric fence, it is recommended that the energizer be turned off and an intentional short circuit be placed from the fence live wires to earth. This is a sensible precaution against the energizer being turned on by others or malfunctioning while work on the fence is in progress.
- This appliance is not intended for use by persons with reduced physical, sensory or mental capabilities, or lack of experience and knowledge, unless they have been given supervision or instruction concerning use of the appliance by a person responsible for their safety.
- Children should be supervised to ensure that they do not play with the appliance.



4. DESCRIPTION

4.1 JVA Z14 Exterior



4.2 LCD Voltage Display

The display on the JVA Z14 shows the voltage at the fence and return terminals. The left is the return and the right is the feed voltage. Arrows at the top of the display indicate that the unit is in conventional mode.

For Bi-Polar fences, the left side is the positive return wire voltage and the right is the negative wire return voltage.

The LCD also shows the programming option and current setting when in programming mode. This allows the programming options settings to be checked easily.

4.3 Status Lights

Power	On whenever the unit has power
Armed	On when the unit is armed (pulsing), will flash when in Low Voltage mode
Fence	On when there is a fence alarm
Gate	On when there is a gate alarm
Status	The number of times the Status Light flashes indicates the status of the energizer. See the table in section 7.2 – Status Codes.

4.4 Inputs and Outputs

See Technical Information page 21.

4.5 Status Codes

See Technical Information page 22.

4.6 Keypad (Optional)



Up to 3 keypads can be used to remotely monitor and control the Z14. A keypad is required to set the programmable options for installer programming options. See pages 33–35.

4.7 Keypad LCD Screen

The JVA Z14 can function with the supplied side-mounted key switch. However, the user has the option of purchasing the LCD keypad.

This state-of-the-art keypad has a liquid crystal display screen, which is easier to understand than coded LEDs as it provides detailed information regarding energizer status in easy-to-read text.

For information on how to control the Z14 via the keypad, see section 6, page 18.

4.8 Internal Beeper/Keypad Beeper

Depending on the *chime* setting, the internal beeper and keypad beeper will sound when there is a fence alarm, a gate alarm, a door chime or a general alarm. Should the battery voltage run low, the keypad will always beep 4 times before the energizer automatically enters Low Voltage mode to preserve the battery. Should the mains fail, it will not beep until it enters Low Voltage mode.

4.9 Bi-Polar Option

The Bi-Polar fence is made up of alternating positive (+ve) and negative (-ve) wires instead of live and earth. Bi-Polar has the benefit, for security purposes, that all wires on the fence are live with respect to earth, so every wire gives a shock, and anything touching both wires receives a larger shock. The trade-off is that the voltage on each set of wires to earth is approximately half that of a conventional fence's live wires. The voltage between the wires is the same as that of a conventional fence. To set a Z14 to Bi-Polar mode, the unit must be modified by a JVA Technical Centre.

The fence feed and return connections are wired differently for Bi-Polar mode compared to Conventional mode.

For diagrams showing how to connect the Z14 to a fence, see section 5.3, page 14.

NOTE: In Bi-Polar particular mode, the display shows return voltages only for each circuit. e.g. Return voltages showing 4.3 and 3.9 mean a total voltage of 8.2 kV.

4.10 Cabling

High voltage cabling (fence lead out and returns) should be run using suitably rated cable. Double insulated electric fence "underground" cable is suitable. High voltage cables must **never** be run within the same conduit as low voltage cables. A minimum distance of 100mm should be kept between high voltage and low voltages cables.

4.11 Lightning Protection

Although the Z14 contains internal lightning protection elements, external lightning protection elements such as additional external lightning protection kits are recommended to further reduce lightning damage and thus reduce repair costs. They are available from your local dealer.

4.12 Earth Loop Monitoring

The Z14 has two fence earth terminals. If the earth monitoring facility is not required, the *Earth Out* and *Earth Return* terminals must be joined with a wire bridge. The earth terminals must be connected to the earth spikes as close to the energizer as possible. In most installations these may be joined and only one wire used to connect to the earth. Directions on how to wire for earth loop monitoring are in section 5.3, page 14.

NOTE: In this particular mode, i.e. earth monitoring mode, the fence earth loop must be connected to the ground earth spikes at only one location (close to the energizer).

4.13 Noise and Interference

The Z14 contains a microprocessor. Extreme electrical noise can upset microprocessors. The most likely cause of such noise is the high voltage output from the unit itself. In the event of erratic behaviour, check that the high voltage wiring is firmly connected to the terminals and that no sparking is seen. The Z14 is designed to self-recover from interference. Powering off (both AC and battery) should not be necessary.

4.14 Programmable Options

The Z14 has many programmable options. These are also known as *setup parameters*. To alter these options, a keypad must be used. The options are explained in *Programming Options In Brief* on page 24. Each parameter has a factory set default.

4.15 Low Power mode

Z14 energizers can be switched into Low Power mode. Low Power mode may be used in situations where the fence is not required to be a deterrent but is still required to actively detect intrusion. In Low Power mode the fence live wires operate at a much lower voltage, typically 500V peak. See *Programming Options in Brief* on page 24 for details on using the keypad to set Low Voltage mode.

4.16 Key Switch

The unit may be armed using the key switch on the right-hand side. Alternatively, if a keypad is fitted, it may be armed from the keypad. An external switch device, for example a remote receiver or access control keypad, can also be used to arm and disarm the unit.

4.17 Gate Input

The gate input may be wired to a gate switch to trigger an alarm when a gate is opened. Alternatively, it may be programmed as a control input for Low Power mode. This is determined by the programmable option settings but defaults to Gate Switch mode.

If the unit is disarmed, the gate input may be set to Chime mode. If the unit is in Low Power mode, the gate input may be programmed as Chime mode or Alarm mode. See *Programming Options in Brief* on page 24.

4.18 Group Simultaneous Pulse Feature

In some installations it may be preferable to provide the ability to link multiple units into a group. When linked, the individual Z14s, Z18s and Z28s become a group. As many as fifteen energizers can be grouped. Individual units in a group have

simultaneous high voltage output pulses and act as if they are one energizer with multiple outputs. This is designed so that no possible combination of individual outputs can be dangerous. See *Installation Steps – Group mode*

Perimeter Patrol Lite (2x) Software

The Pakton Perimeter Patrol Lite software package enables one or more energizers to be monitored and controlled from a PC. Perimeter Patrol Lite is free for owners of Z-series energizers.

This package is sufficient for a standalone system where the owner is interested in a visual representation of an electrified enclosure (mimic screen) and the ease of operation that a Windows compatible GUI application can provide.

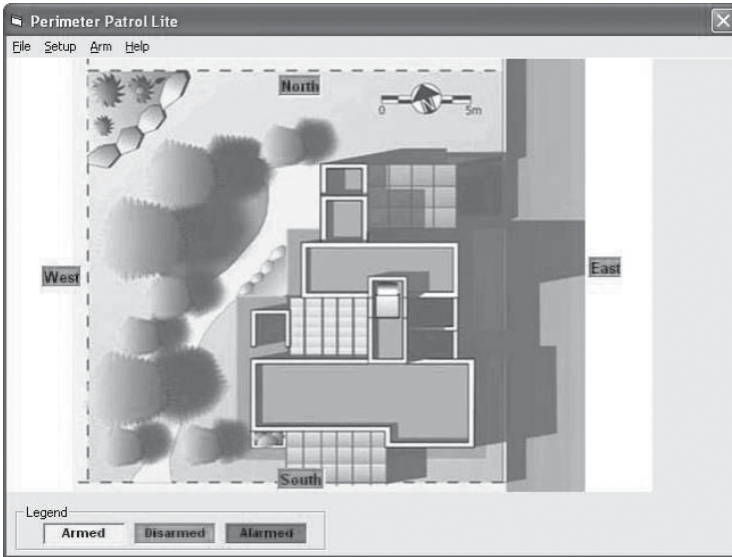

Perimeter Patrol 3.x Software

Perimeter Patrol 3.x is sold as commercial software to accompany one or more Z-series energizers. It offers a number of features not available in the Lite version, providing functionality that may be required at more critical installations. To obtain a copy of Perimeter Patrol 3.x, please contact your Z-series distributor.

5. INSTALLATION

JVA recommends installation by qualified technicians.

5.1 Installation Steps

1.	Read the entire manual first!
2.	Design and build the fence. (Beyond the scope of this manual.) Ask your distributor for help if required.
3.	Decide where the JVA Z14 is to be mounted. If on an external wall it should be housed within a waterproof equipment box and definitely not in direct sunlight.
4.	Remove the JVA Z14 PCB chassis from the housing by removing the 2 screws.
5.	Mount the housing by using 4 screws through the rear of the box.
6.	Replace the PCB chassis.
7.	If using a keypad, remove the rear housing of the keypad and fix it to the wall.
8.	Wire the low voltage cables to the PCB terminals*. (See page 13)
9.	Wire the high voltage cable to the PCB terminals*. (See page 13) If earth monitoring is not going to be used on the fence, connect a bridge wire from <i>earth out</i> to <i>earth return</i> .
10.	Ensure that the key switch is off.
11.	Fit the battery leads to the battery. The <i>Status Light</i> should blink twice repetitively to show mains fail, unless J3 is fitted.
12.	Mount the 220 – 16V transformer and connect the 16V side to the Z14 16V input terminals. (AC is not polarity sensitive.) Do not connect a <i>live</i> or <i>neutral</i> to the earth terminal.
13.	Replace the front cover.
14.	Turn AC power on.
15.	Arm and disarm the energizer via the keyswitch or keypad, if fitted. The <i>Status Light</i> should stop blinking.
16.	Arm the unit. The LCD display will now show the fence voltage.
17.	Check to ensure that a short anywhere on the fence triggers the alarm.
18.	Ensure that the user understands how to change the user code (PIN) and is in possession of this Installer/User Manual and the installer's contact details.

***NB** Keep high voltage and low voltage cables at least 100mm apart.
Do not run high and low voltage cables in the same conduit.

5.2 JVA Z14 – Interior Configuration

Main board

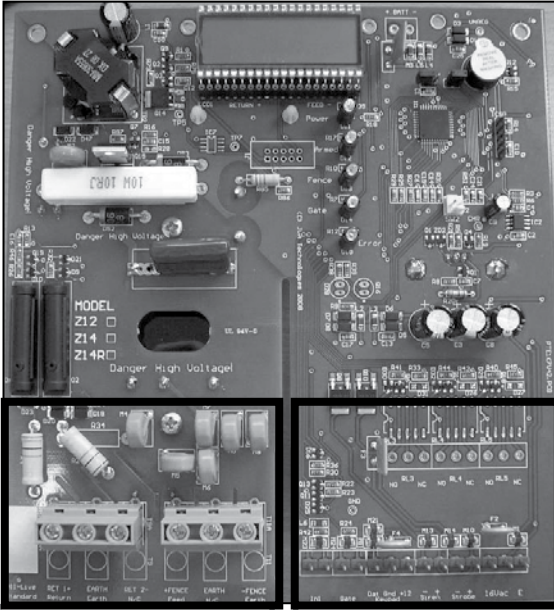

HV terminals

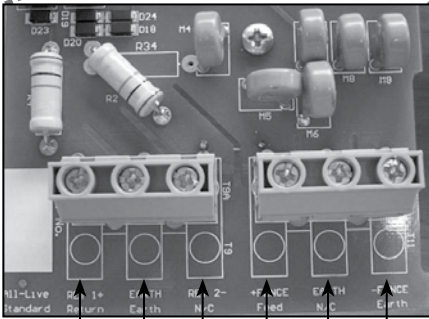

Live return
Earth return
no connection
Live out
no connection
Earth

LV terminals

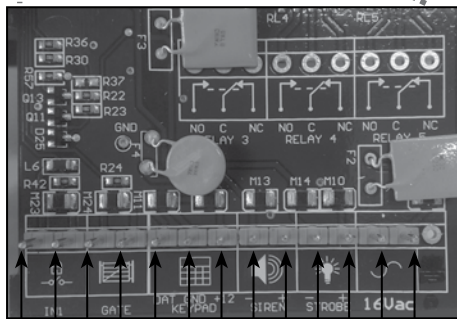

IN1
Gate
Keypad
Siren
Strobe
16V AC Input

5.3 Examples of Fence Wiring Diagrams

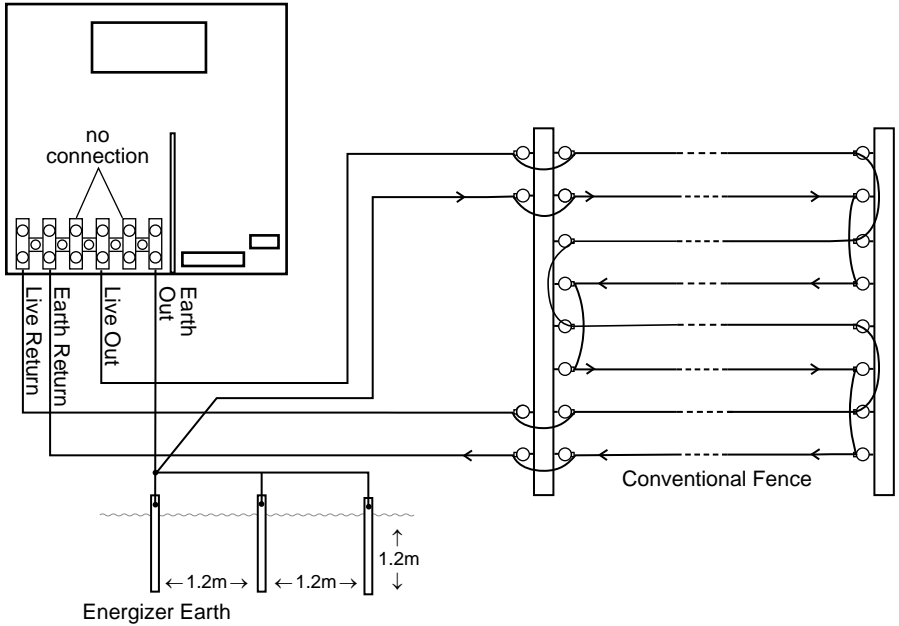

*JVA Z14 Energizer configured for conventional fence operation
(including earth monitoring)*

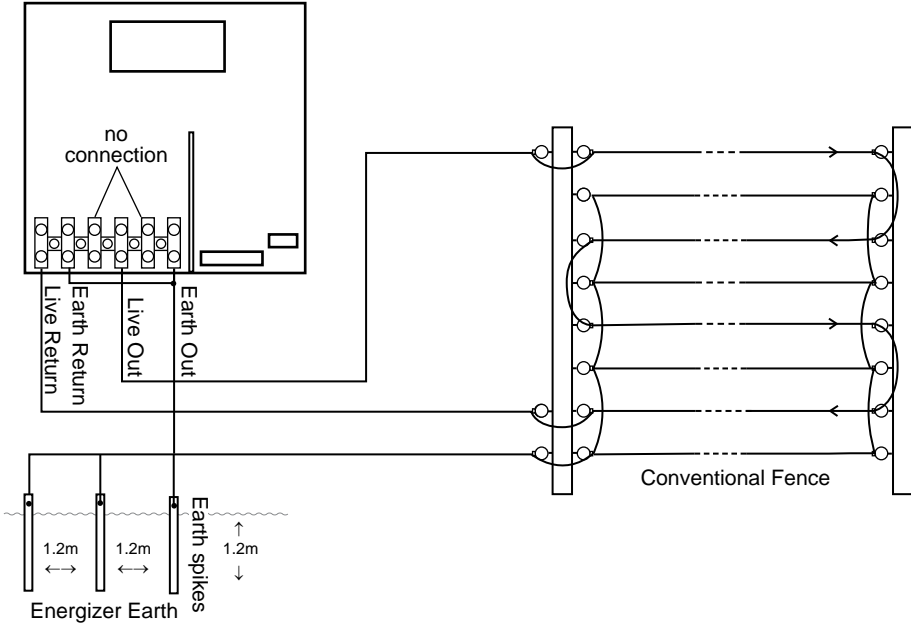

JVA Z14 Energizer configured for conventional fence operation (without earth monitoring)

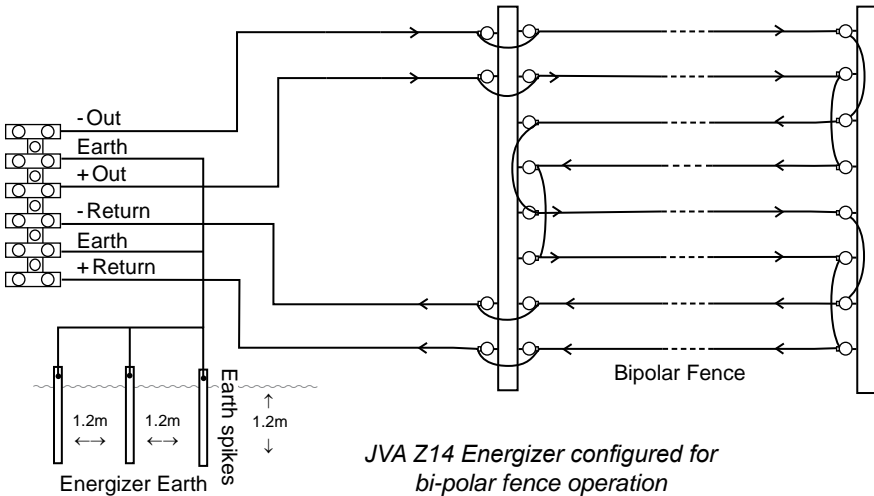

JVA Z14 Energizer configured for bi-polar fence operation

5.4 Installation Steps – Group Mode

1.	Disarm all energizers in the group. If energizers are not disarmed Step 10 may not work correctly.
2.	Program the keypad address using one of the energizers.
3.	Program each energizer with its required address (Master address = 1, Slave 1 address = 2...). Refer to note 4 below.
4.	Connect any control/monitoring unit 12V, GND and Data to the Group Master
5.	Connect all the slaves Data and GND to the Group Master.
6.	Connect the battery and AC power of the Group Master but do not arm.
7.	Connect the battery and AC power of each slave Note: Do not arm them until all the Energizers in the group are connected
8.	Wait 5 minutes for all the Energizers to synchronise with the Master
9.	If there are more than one keypad or control unit, make sure they have a different ID then reset the group using keypad code: [user pin] [*] [6] [8] [#] or Perimeter Patrol “Reset All” this will allow both keypads to be recognised by all energizers in the group.
10.	Enter the key sequence [*][6][8][#] to automatically re-scan the group and check what energizers are connected.
11.	Arm the group using keypad [1] [2] [3] [4] [*] [1] [0] [#] or Perimeter Patrol, make sure all Energizers are activated.

NOTE:

- Members of a group can be individually switched on and off; even the master can be turned off via input or key switch.
- A slave will generate a General alarm if the keypad bus is broken between it and the group master.
- After programming the Keypad may be disconnected, it is not required for group operation.
- As of energizer firmware 7v83 and keypad firmware 1v09, Z28's should have an 'empty' ID between each Energizer. This means if the Z28 master ID=1, then the ID of the first slave should be 3, not 2.
- When connected to Perimeter Patrol, the arm/disarm function of a keypad is disabled. Control of these functions is through the Perimeter Patrol interface.
- A Keypad that is connected to a Slave Energizer (that is disconnected from the Group) must have a KEYPAD ADDRESS set to 1 or 8. Otherwise the Energizer will not respond to commands.

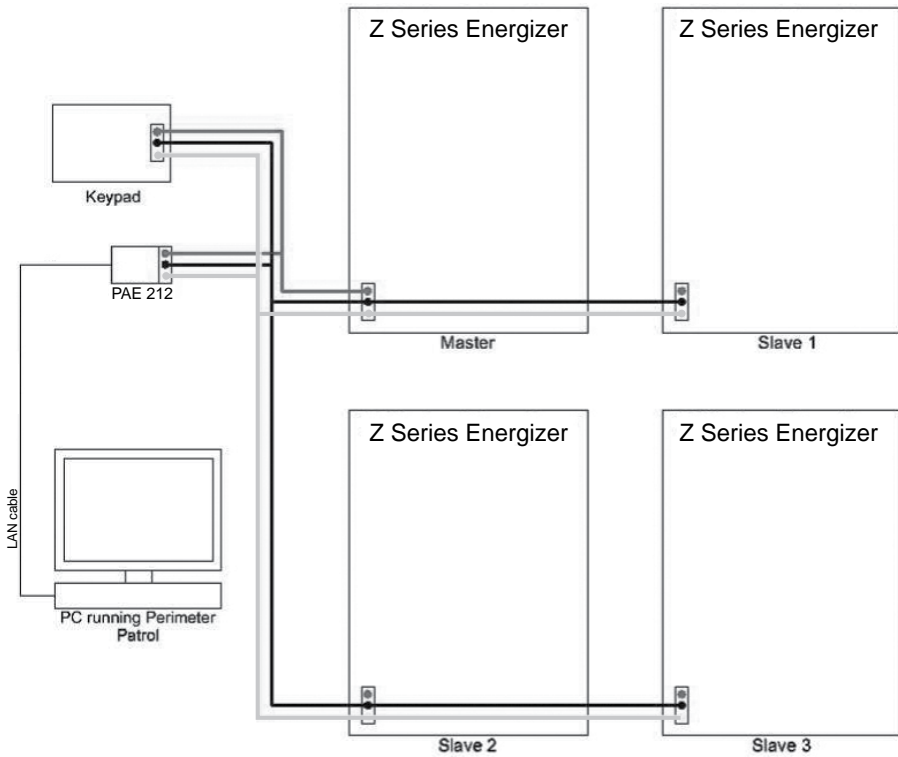

Group Mode Linking

Group Installation notes

1. If an Energizer hasn't been programmed as a Master or a Slave, it is set as "Stand alone" by default.
2. All energizers need an appropriate high voltage circuit earth connection.
3. Allow for the heat load of multiple Energizers mounted inside a cabinet, approximately 10W each.
4. Use shielded or twisted pair cable for the group keypad wiring.

6. OPERATION

6.1 Control

Your JVA Z14 security energizer has been designed for ease of operation.

Key Switch: In its simplest form, the energizer is controlled by the key switch on the side of the unit.

Keypad: The optional keypad allows the user to have completely secure control of the energizer on a neat, small keypad at a location up to 100 metres from the energizer, such as a bedroom, without having to have the large energizer box and ticking noise in the room. The energizer can be installed in a garage or location close to the fence, while the keypad can be positioned in an easily accessible place. The specific system's information, e.g. mains power, energizer on/off, fence alarm, auxiliary alarm, etc., are displayed on the keypad.

If a keypad is connected, the key switch and control input terminal may not be operational as they may have been disconnected by the installer.

If both the key switch and keypad are connected to the energizer, then the last change will determine the result. For example, if the unit is armed via the keypad and then disarmed using the local key switch, it will disarm.

If in doubt consult your installer.

6.2 Arming the Fence Using the Keypad

- Enter your PIN number (four digits long) and push the # key. (Default is 1 2 3 4)
- Make sure the red ARM light comes on.
- The keypad will beep twice to confirm that the system is armed.
- The fence will power up and if all is well (no faults) the system will be ready to deter and detect.
- If there is a fault on the fence and it cannot achieve full voltage, the LCD screen will indicate that there is a fault.
- To disarm the system, enter your PIN and press #. This will also clear any fault lights and zone lights which may have been on.

6.3 Turning to Low Power mode

To switch to Low Power mode, enter your PIN and press *41#. In Low Power mode the fence will still be powered and any breach will be detected, but the voltage will be much lower than normal operation. The ARM light will flash in Low Power mode.

Enter your PIN and press *42# to switch back to Full Power mode.

Alternatively, the unit can be switched to Low Power mode using the gate switch input, if it has been programmed accordingly. See *Programming Options*, page 23.

6.4 When an Alarm Occurs

If the system is armed and the fence is tampered with, the *Fence Light* will flash and then remain on. A siren or strobe connected to the unit will turn on. If the energizer is connected to an alarm system for monitoring, an alarm signal will be sent to the alarm company monitoring the alarm system.

An alarm will also sound if the gate input is opened and the entry/exit delay time has elapsed.

After the siren has cycled on and off according to the times and numbers set in options, the siren will stop sounding. The on and off timing is able to be set in the options. The Strobe will remain on. After a further delay (Auto Rearm Time) the siren will again respond to the next alarm condition with a new set of on / off cycles.

If the alarm condition (low fence voltage or gate input) is removed, the siren will stop after the end of the current "on" time (Siren On Time).

If the siren is muted by (entering PIN#) then the siren will enter the next "off" cycle (Siren Off Time). If the alarm condition is still present (voltage is low) the siren will sound again after the preset "off" time. If the alarm condition is not present the Energizer is instantly rearmed, irrespective of the auto-rearm setting. The last feature was added in firmware version 7.77.

6.5 To Silence the Alarm

- Enter your PIN and press #. This will silence the alarm but not disarm the system; the *Armed Light* will still be on. The system will be ready for the next alarm. Note that the following functions have an effect on alarm timing: Siren On time, Siren Off time, Siren Cycles, Auto Re-arm time).
- The siren and strobe are ready to respond again if triggered.
- To disarm the system, enter your PIN and press # again. This will also clear the fence alarm light.
- Alternatively, disarming using the key switch will reset the alarm.
- If you silence an alarm and the problem is still present when the unit is rearmed, the siren will sound again after the programmed *off time* has elapsed.
- To clear the alarm memory, press * 1 #

6.6 Changing the PIN Number

- Enter the old USER PIN and press *0#. This enters User Programming mode.
- Enter the new USER PIN (must be 4 digits) and then #. (Repeat to confirm PIN.)
- Press *# to exit User Programming mode.
- Make sure the new USER PIN works by using it to arm the energizer.
- **The default USER PIN is 1 2 3 4.**



6.7 Standby Battery

Should there be a loss of mains power, the *Power Light* on the keypad will go off. The unit will switch to a reduced output to conserve battery power. If the loss of power is prolonged, the battery may discharge power and become ineffective. The *Power Light* will start to flash indicating a battery low power problem. If the battery is depleted, the unit will not pulse.

If the standby battery requires replacement, the *Power Light* will flash and the *Status Light* will be flashing three times.

6.8 Status Light

The energizer status light indicates that the energizer requires attention. See section 7.2, page 22.

6.9 Keypad Control in Brief

In the following table, XXXX is the 4-digit USER PIN. The default USER PIN is 1 2 3 4.

ACTION	PRESS KEYS
Turn on / ARM	XXXX#
Turn off / DISARM	XXXX#
Silence an alarm	XXXX#
Switch to Low Power mode (all zones)	XXXX*41#
Switch to High Power mode (all zones)	XXXX*42#
Arm All Zones (Multizone systems)	XXXX#
Arm Zone 1 or Master	XXXX*11#
Arm Zone 2 (2 Zone models only) or Slave 1 etc.	XXXX*12#
Disarm All Zones	XXXX*20#
Disarm Zone 1 or Master	XXXX*21#
Disarm Zone 2	XXXX*22#

6.10 Solar Powering the Unit

If there is no mains power on the site, the Z14 can be powered as follows: A 105 Amp/hour battery charged by a 75 watt solar panel. This is a guideline. A bigger panel may be required in some cases. If operating from an externally charged battery, fit Jumper J3, to inhibit mains fail alarm.

7. TECHNICAL INFORMATION

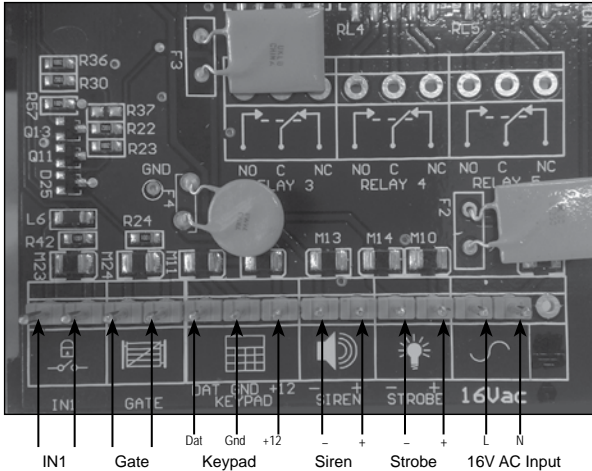

Label	Type	Description
IN1	2 Way	Energizer control input (dry contact) is in parallel with the key switch input, SW2. Can be used for a remote switch or a radio receiver. The receiver may be powered from the keypad +12V terminal.
Gate	2 Way	Normally open. When the unit is armed and the gate is opened, it will trigger the gate alarm. Alternatively, the gate input can be programmed to make the energizer alternate between Low Voltage and High Voltage mode.
Keypad	3 Way	Supplies power and data line for an external keypad. The +12 source on these terminals is protected with 1A self-resetting fuse.
Siren	2 Way	Switched 12V output. Low side switched. 30W max (including Strobe). A buffer relay should be used when connecting these outputs to an alarm panel.
Strobe	2 Way	Switched 12V output. Low side switched. 30W max (including Siren). A buffer relay should be used when connecting these outputs to an alarm panel.
AC IN	3 Way	16Vac power input. Fused via F3, 2A self-resetting fuse.
Batt	2 Way	Connect red lead to battery positive (+) terminal. 12V dc or battery connection via F1 (3 Amp self-resetting fuse).

Low Voltage Terminals

7.1 Power Options

The Z14 has 2 sources of power, 16VAC and 12VDC (Battery).

NOTE: Use only rechargeable batteries. Always ensure adequate ventilation is available for the housing if it contains a battery. Lead acid batteries may emit explosive gases while charging!

7.2 Status Codes

Status Light Number of Flashes	Interpretation	Corrective Action
2	Mains supply fail	Restore mains power (16 Vac)
3	Low battery, bad battery	Charge or replace battery
4	PCB service fault	Default the unit (See 7.3, J4)

Status codes

If an error occurs, an Output assigned to General Alarm will go into alarm state. Minor errors will self-clear if the error condition is removed.

Mains fail will not disarm the energizer, nor will low battery. However, without mains power, the battery will eventually be depleted and the energizer will attempt to maintain operation by entering low power mode after 4 warning beeps. If the battery charge continues to fall, the energizer will eventually stop. Once mains power has been restored and the battery has recovered, the energizer will re-arm itself automatically after 4 warning beeps.

A PCB fault will disarm the Energizer. If an error disarms the Energizer, the General Alarm and Fence Alarm will be activated.

7.3 Jumpers

The Z14 has two special purpose jumpers (links). These are listed in the table below.

Jumper	Function	Purpose
J3	DC only jumper	Remove J3 to inhibit mains fail errors if the intention is to operate the Z14 on DC only (as in Solar Power systems)
J4	Factory default jumper Off to return programmable options to factory defaults upon power up	If the energizer needs to be defaulted to factory settings, remove all power – mains and battery – and remove the J4 jumper. Reapply the battery power first, and then the mains power. Reapply the J4 jumper and the unit will be reset to default settings. If <i>Status LED</i> flashes four times after defaulting the unit, return it to the nearest JVA service centre.

Jumpers

8. INSTALLATION PROGRAMMING OPTIONS

The Z14 has a non-volatile memory in which are held programming options (setup parameters). These are factory pre-set but can be field programmed using a keypad.

8.1 Programming Mode

To enter Programming mode, enter the 6-digit INSTALLER PIN followed by *0# keys. The keypad will beep twice to indicate that the command was accepted. If the INSTALLER PIN was incorrect, the keypad will beep 3 times. The LCD will now show the first programming option and its current setting.

Pressing the # key will cycle through all the options on the LCD.

NOTE: Not all numbers are used. The default INSTALLER PIN is 0 1 2 3 4 5.

8.2 To Exit Programming Mode

After programming, press *# to exit. If left unattended, the unit will time out and auto exit Programming mode after approximately 5 minutes.

8.3 Changing the Installer PIN

The INSTALLER PIN may only be changed while in Programming mode.

To enter a new INSTALLER PIN, press 00 followed by the new 6-digit PIN, then the # key.

If you cannot remember your INSTALLER or USER PIN, return the unit's memory to default. To do this, remove power (AC off and disconnect the battery), open the energizer, remove jumper J4 and reconnect the battery for about 10 seconds. Re-fit J4. This will return all options to the factory set defaults.

8.4 Changing an Option

Most of the options have possible values in the range of 0 to 9.

To change any options, the unit must be in Programming mode. Check the option number (see table below) and then the table of values for that option. Then press the option number followed by the required value. When the programming is completed, exit from Programming mode. (See above.)

For example, to change the power level to maximum, press 019#, and the keypad will beep twice to indicate that the command was successful. The LCD will immediately show the updated value.

8.5 Programming Options in Brief

See page 23 for more detail.

Option	Function	Description
01	Power Level	Sets the output power levels
02	Low Power level	Sets the output power levels used in Low Power mode
03	Fence Alarm Voltage	Sets the voltage threshold below which the fence alarm will occur
05	Low Power Alarm Level	Sets the voltage threshold below which the fence alarm will occur in Low Power mode
06	Missed Pulse Count	Sets the number of pulses which may be missed before the alarm is activated
07	Battery Alarm Voltage	Sets the battery voltage threshold below which the general alarm will activate
08	Siren On Time	Sets the time that the siren (and keypad beeper) will stay on after an alarm
09	Siren Off Time	The amount of time the siren will be off for after the On time has expired
10	Siren Cycles	The number of times the siren will sound for the On time function above. After this many cycles the siren will automatically mute
11	Input Inversion	Input normally open or normally closed
12	Gate Input Function	Gate Switch mode or Low Power Switch mode
13	Gate Exit Delay	Time from gate switch opening to alarm
14	Chime Mode	Allows the keypad and internal beeper function to be altered
15	Fence Mode	Bi-Polar or Conventional mode. Requires hardware change, which can be done by nearest JVA service centre
16	Binary Options	Miscellaneous options
17	Anti-bridging	If the voltage rises OR falls quickly by more than this setting as a percentage of the average fence voltage the alarm will occur
18	Binary Options 2	Miscellaneous options
19	Not used	
20	Auto Re-arm Time	Sets the time which must elapse after an alarm has timed out (completed the Siren Cycles) before the Energizer will automatically re-arm ready for the next alarm event.
21	Relay 1	Used to assign an alarm function to relay 1
22	Relay 2	Used to assign an alarm function to relay 2
23	Relay 3	Used to assign an alarm function to relay 3
24	Relay 4	Used to assign an alarm function to relay 4
25	Relay 5	Used to assign an alarm function to relay 5
26	Group Mode	Allows the energizer to be set as a Master or slave in a synchronized group. Not available in all markets.

8.6 Programming Options in detail

8.6.1 Power Level (01x#)

The power level option allows the shocking power of the fence to be adjusted. For example: To change the power level to maximum, enter the following:

0 1 9 # or 0 1 0 9 #.

The keypad will beep twice to indicate that the new setting has been accepted.

The normal fence voltage depends on the amount of fence wire, the losses and the power level.

This setting affects the average power drain and therefore backup battery time.

Kilovolt settings refer to a 1000 Ohm load, actual fence voltages will depend on the type and length of fence.

Note: The bold panel in each table indicates the default value.

Value (x)	Voltage Conventional Mode	Voltage Bi-Polar Mode
0	±5.0kV	2.5kV
1	±5.5kV	2.8kV
2	±6.0kV	3.0kV
3	±6.5kV	3.3kV
4	±7.0kV	3.5kV
5	±7.5kV	3.8kV
6	±8.0kV	4.0kV
7	±8.5kV	4.3kV
8	±9.0kV	4.5kV
9	±9.5kV	4.5kV

Power Level (01x#)

8.6.2 Low Power Level (02x#)

Same as above, but for Low Power mode.

Value (x)	% of High Power
0	0.5%
1	1.0%
2	1.5%
3	2.0%
4	2.5%
5	3.0%
6	3.5%
7	4.0%
8	4.5%
9	5.0%

Low Power Level (02x#)

8.6.3 Fence Alarm Voltage (03x#)

This option sets the voltage threshold below which the fence alarm will occur. The default Fence Alarm Voltage is 4 kV. In Bi-Polar mode this threshold is for both positive and negative fence wires.

Value (x)	Voltage Conventional Mode	Voltage Bi-Polar Mode
0	1.5kV	1.5kV
1	2.0kV	1.8kV
2	2.5kV	2.1kV
3	3.0kV	2.4kV
4	3.5kV	2.7kV
5	4.0kV	3.0kV
6	4.5kV	3.3kV
7	5.0kV	3.6kV
8	5.5kV	3.9kV
9	6.0kV	4.2kV

Fence Alarm Voltage (03x#)



8.6.4 Low Power Alarm Level (05x#)

This option sets the voltage threshold below which the fence alarm will occur. The default Fence Alarm Voltage is 500 Volts.

Value (x)	Voltage
0	300 Volts
1	500 Volts
2	700 Volts
3	900 Volts
4	1100 Volts

Low Power Alarm Level (05x#)

Value (x)	Missed Pulses
0	1
1	1
2	2
3	3
4	4
5	5
6	6
7	7
8	8
9	9

Missed Pulse Count (06x#)

8.6.5 Missed Pulse Count (06x#)

This option enables the pulse count to be varied from the default (3). This is the number of bad or missing pulses that are counted before the alarm occurs.

NOTE: The lower this option is set, the more likely you are to get false alarms.

8.6.6 Battery Alarm Voltage (07x#)

This option sets the battery voltage threshold below which the alarm will activate. The default Battery Alarm Voltage is 11.0 Volts and the unit will drop to low power at 10.0 Volts (after beeping 4 times).

If the unit enters Low Power mode due to a flat battery, the unit will automatically return to high voltage, without warning, when the mains voltage comes back on and the battery voltage rises.

Keypad Number	Alarm	Reduce Power
0	9.0 V	8.0 V
1	9.5 V	8.5 V
2	10.0 V	9.0 V
3	10.5 V	9.5 V
4	11.0 V	10.0 V
5	11.5 V	10.5 V
6	12.0 V	11.0 V
7	12.5 V	11.5 V
8	13.0 V	12.0 V
9	13.5 V	12.5 V

Battery Alarm Voltage (07x#)

8.6.7 Siren On Time (08x#)

This option sets the duration of time that the siren will remain on after a fence alarm occurs. After this time the siren will turn off for the *Off* time indicated in Table 8.6.8. The siren will sound again if the alarm is still present after this *Off* time has passed. The default is 3 minutes.

This may be the subject of local regulations to stop an alarm causing undue disturbance to neighbours, etc.

NOTE: The siren *On* time will be cut short if the battery falls below the low battery level.

Firmware version 7.95 changes options:

Value	Time
0	10 Seconds
1	1 Minute
2	2 Minute
3	5 Minutes
4	10 Minutes
5	20 Minutes
6	30 Minutes
7	40 Minutes
8	50 Minutes
9	60 Minutes

Siren Off time (09x#)

8.6.9 Siren Cycles (10x#)

This option sets the maximum number of times the siren will sound for the *On* time if the alarm continues. This may be limited by local regulations to stop an alarm causing undue disturbance to neighbours, etc.

NOTE: This is the maximum number of cycles for 1 continuous alarm, intermittent alarm events could cause more than this number of siren soundings.

Value	Time
0	10 Seconds
1	30 Seconds
2	1 Minute
3	2 Minutes
4	3 Minutes
5	4 Minutes
6	5 Minutes
7	6 Minutes
8	7 Minutes
9	8 Minutes

Siren On time (08x#)

Value	Time
7	20 Minutes
8	45 Minutes
9	130 Minutes

7.95 firmware

8.6.8 Siren Off time (09x#)

This option sets the amount of time the siren will be off for after the *on* time above has expired. If an alarm is still present after this *Off* time, the siren will sound again.

Value	Cycles
0	0
1	1
2	2
3	3
4	4
5	5
6	6
7	7
8	8
9	9

Siren Cycles (10x#)

8.6.10 Input Inversion (11x#)

The control inputs can be inverted, unless an input is used for a Gate switch, in which case it is always NC.

Value	Function
0	Normally open
1	Normally closed

Input Inversion (11x#)

8.6.11 Gate Input Function/Low Power mode (12x#)

This option is used to set the mode for the gate input. If set to 0, the gate alarm will trigger if the gate is opened. If set to 1, the unit will go into low power if the gate input is closed.

Value	Function
0	Gate
1	Low Power

Gate Input Function (12x#)

Value	Time
0	0 Seconds (Immediate)
1	30 Seconds
2	1 Minute
3	2 Minutes
4	3 Minutes
5	4 Minutes
6	5 Minutes
7	6 Minutes
8	7 Minutes
9	8 Minutes

Gate Entry/Exit Delay (13x#)

8.6.12 Gate Entry/Exit Delay (13x#)

The gate switch must remain open for longer than the Gate Entry/Exit Delay before the Gate Alarm is triggered. If the switch closes within this time, the Gate timer is reset to the Gate Entry/Exit Delay value.

8.6.13 Chime Mode (14x#)

This option allows the Energizer's internal, and keypad, beeper to be used as a door chime for the gate switch. When set to None, the keypad beeper is used to indicate correct keypad operation only. When set to Door Chime, the beepers will sound when the gate switch opens, even if the energizer is disarmed. Note "Gate" must be selected in Input 2 Function (Option 12).

If set to Siren, the beepers mimic the siren function.

Gate Beeps plus Siren will give 2 beeps on Gate open and 4 on close, plus continuous for an alarm. Beeps are on Keypad only, not internal beeper.

NOTE:

Gate must be selected in option 12.

Value	Function
0	None
1	Door Chime
2	Siren
3	Fence Alarm
4	Gate beeps plus Siren

Chime Mode (14x#)

8.6.14 Fence Mode (15x#)

This option sets *Bi-Polar* or *Conventional* modes.

NOTE: Changing modes requires hard-ware reconfiguration by a JVA technician. This service is available from any JVA Electric Fence and Security Centre (0861 782 349).

Value	Function
0	Bi-Polar
1	Conventional

Fence Mode(15x#)

Value	Time
0	None
+1	Cross couple alarm
+2	Max Power
+4	2.5 Joules Limit
+8	IR Tamper enabled
+16	Stop slave on coms fail
+32	Do not send Alarm memory

Binary Options (16x#)

8.6.15 Binary Options (16x#)

Each option in this table can be turned on by adding the corresponding value.

For option + 1 set 16 to 01, for + 1 and +2 set 16 to 03.

+1: Enable cross coupled alarm, not used on Z series Energizers.

+2: Maximum power at all times. Note turning this option on may remove IEC standards compliance. Added in code version 7.80.

+4: Limits outputs to 2.5 Joules per Zone on a Z28. Added in code version 7.84. Also limits a Z14 to 2.5J per zone in group mode. Added 7.86.

+8: Enables the IR tamper detection under the lid. J3 changes function to inhibit tamper.

+16: Stop slaves on E-16 if the communications from the group master is lost.

+32: Stops the energizer sending Alarm Memory to a PC, relay PCB or keypad. Set this to restore *Unlatched* mode on a PAE201 relay PCB.

NOTE: +8 and +16 added in code version 7.86. +4 to +16 all default to *On* (strict IEC compliance) for a Z14R (i.e. if option 15 = 2 or 3). +32 added in code version 7.87.

8.6.16 Anti-bridging threshold (17x#)

Anti-bridging has been designed to detect a section of fence being bypassed, and removed from circuit, by an intruder bridging the feed to returns together and then cutting the live wires. Setting this option to a value greater than 0 (default is 0 = off) will enable Anti-bridging, however this feature will not operate in low power mode! While Armed, a Fence Alarm will trigger if the Fence Voltage rises OR falls quickly by more than the threshold. A slow change to the voltage will not trigger a Fence Alarm until the Voltage is less than the Fence Alarm Voltage (03x#)

The Anti-bridging Threshold is a percentage value of the current Fence Voltage. For example, setting option 17 to 10 (1710#) will set a 10% Anti-bridging Threshold. At this level a fence (return) voltage normally reading 7.5kV will trigger a Fence Alarm if the voltage quickly rises to over 8.3kV or falls to less than 6.7kV.

NOTES:

1. Power Level (Option 1) must be set higher than the normal fence running voltage, otherwise if the load is released (fence bridged) voltage control will limit the voltage rise and the anti-bridging alarm would not activate. For the above example, Option 1 must be set to 7 or greater to allow the un-loaded fence to rise to 8.3kV or higher, thus triggering the Alarm.
2. A minimum of 5% was added in code version 7.92

8.6.17 Binary Options 2 (18x#)

Each option in this table can be turned on by adding the corresponding value.

For option+ 1 set 18 to 01, for + 1 and +2 set to 03.

+1: Enable Siren Acknowledge. The siren will chirp once for armed and twice for disarmed.

+2: Enables a home alarm style entry/exit delay for the gate input. See also option 13.

Value	Function
0	None
+1	Siren codes
+2	Gate delay type
+4	4800 baud
+8	9600 baud
+16	
+32	

Binary Options 2 (18x#)

+4:Sets the keypad bus baud rate to 4800 (default is 2400), all units in a group, PC and Keypad must be set to the same baud rate. The change will not take effect until after a reset.

+8:Sets the keypad bus baud rate to 9600 (default is 2400)

Note: Z11 defaults to +1.

Note: +2, +4 and +8 were added in code version 7v92.

8.6.18 Auto Re-arm Time (20x#)

This option sets the time which must elapse before another alarm will sound after the first alarm has timed out (gone completely through its cycles without being turned off).

If an event occurs (such as a low fence voltage) which triggers the siren, any other events which would otherwise trigger the siren (such as a gate alarm) will be ignored while the siren is sounding and until after the *Auto Re-arm* time has passed.

A setting of 9 will disable *Auto Re-arm*.

Value	Time
0	0 Seconds (Immediate)
1	30 Seconds
2	1 Minute
3	2 Minutes
4	3 Minutes
5	4 Minutes
6	5 Minutes
7	6 Minutes
8	7 Minutes
9	Disabled – do not auto-rearm

Auto Re-arm Time Values (20x#)

8.6.19 Relay Functions

All relays can be set to any of the available functions (user assignable).

Relay 1 is (**21x#**)

Relay 2 is (**22x#**), etc.

Even though the three additional relays are not fitted to the Z14, Relays 3, 4 and 5 can still be programmed. The modes are explained in the table opposite.

The defaults for the Z14 are:

- Relay 1 – Siren
- Relay 2 – Strobe
- Relay 3 – Fence (Note: *Relay 3 is not physically fitted to PCB*)
- Relay 4 – Armed 1 (Note: *Relay 4 is not physically fitted to PCB*)
- Relay 5 – General (Note: *Relay 5 is not physically fitted to PCB*)

NOTE: Optional extra relays can be retro-fitted. Contact your nearest JVA service centre for details.

Value	Time
0	Fence 1
1	Fence 1 or off
2	Armed 1
3	Fence 2
4	Fence 2 or off
5	Armed 2
6	Fence Bi-Polar
7	General
8	Siren
9	Strobe
10	AC Fail
11	Low/Bad Battery
12	Tamper
13	Strobe 2
14	Gate 1 or 2
15	Siren caused by Gate 1 or 2
16	Armed in Low Power Mode
17	Group Armed Note 3
18	Group General

Relay Functions Values

8.6.20 Relay Options explained

Function	Logic for alarm state (opposite of normal state)
Fence x	Fence x Alarm: Zone x is Armed (Pulsing) AND the Fence Return Voltage has fallen below the Fence Alarm Voltage for more pulses than the Missed Pulse Count. Not latched.
Fence x alarm or off	Zone x is Off OR the Fence Return Voltage has fallen below the Fence Alarm Voltage for more pulses than the Missed Pulse Count. Not Latched.
Fence Bipolar	Energizer is Armed (Pulsing) AND the Fence Return Voltages on either Bi-polar return line has fallen below the Fence Alarm Voltage for more pulses than the Missed Pulse Count. Not latched.
Armed x	Zone x is Armed (Pulsing)
General	AC Fail OR Tamper OR Low Battery OR Gate Alarm OR Internal Error. Latched for internal errors only.
Siren	Fence Alarm 1 OR Fence Alarm 2 OR Gate Or Tamper, will time out after the Siren Time Out time. This function is latched.
Strobe	As per Siren but does not time out, will remain On until both Zones are switched off. This function is latched.
AC Fail	Alarm on AC Fail
Battery	Alarm on low or bad battery
Tamper	Alarm when the lid is up and J3 is not fitted
Group wide x	Group relay functions are the collected status of the whole group of Z energizers. Group Armed for example is set only if all energizers in the group are armed.

8.6.21 Group Mode (26x#)

A group must have only one master. The other units in the group are slaves. Group Voltage display units require each slave to have a different number. Since the keypad bus is common among the group one keypad can be used to program all units for all options except this one.

The procedure is:

Connect the keypad to each unit in turn, before linking all units into a group. Set this option: one unit as master the other as slaves.

NOTE: In some markets group mode may not be available.

For details on group wiring and operation see below.

1. Make sure the key switch is turned off and *Input 1* is not connected to the *Com* terminal.
2. Connect the battery.
3. Connect the keypad.
4. On the keypad, enter [Installer's code] [*] [0] [#], then [26].
5. Enter the required value (e.g. [1] for master) then [#].
6. Enter [*] [#] to exit programming.
7. Connect the group using the keypad bus as per Figure 7.

Value (x)	Mode
0	No Group
1	Master
2	Slave 1
3	Slave 2
4	Slave 3
5	Slave 4
6	Slave 5
7	Slave 6
etc	etc
15	Slave 14

Group Mode (26x#)

NOTE: At this time groups are limited to a master and 14 slaves (15 zones in total). If more zones are required, the LAN interface boards can be used. (PAE 212)

9. JVA Z14 ALPHA PLUS LCD KEYPAD FEATURES



9.1 Using the Alpha Plus LCD Keypad

The LCD keypad has two LEDs, Power and Arm, which act as follows:

- Power: On with Mains power, flashes on low battery.
- Arm On: When the energizer is armed (pulsing), flashes when in Low Power Mode.

All other indication is given via messages on the screen.

NOTE: There is no panic function.

NOTE: By pressing the # key or the House key () the display will toggle between any alarm conditions, trouble conditions and voltage conditions.

9.2 Changing the Keypad Messages

You can change the messages and each of the 8 zone labels.

- The *Dealer Message* displays when the system is on standby.
- *Zone Labels* displays after the [#] key is pressed during alarm memory or faults.
- The programmable *Service Message* is displayed during AC failure, fuse failure, communication failure, or low battery.

[1]	[2] Character up	[3] not used	Emergency not used
[4] ← Cursor left	[5] Next Message	[6] → Cursor right	Fire not used
[7]	[8] Character down	[9]	Panic not used
[*]	[0] Last Message	[#] Enter/Exit	Bypass not used

Keys used for changing messages

- To activate the keypad programming mode, enter the [Installer's Code] [*] [0] [1] [#]. Information may be entered into the keypad in the form of letters (upper and lower case), numbers (0–9), and 22 special symbols. All characters are displayed in the order: upper and lower case letters, numbers, and special symbols. The [Space] character precedes the letter A.
- To enter a Label, use the [2] key to scroll through the characters until you reach the desired character. If you scroll past the desired character, the [8] key may be used to scroll backwards. **NOTE:** *The space character is before the A character (When A is displayed, press [8] to get a space).*
- When the desired character is displayed, press the [6] key to move the cursor to the next character position. The [4] key moves the cursor to the left.
- When all characters have been entered, press the [#] key to enter the message and move to the next message position.
- Use the [0] key to move backward through the messages.
NOTE: *If you move to the next message using [5] instead of the [#] key you will lose any changes you made!*

The message order is:

- *Service Message* (Displayed under “System Trouble”)
- *Dealer Message* (Displayed under the standby message: “Ready to Arm”)
- *Soft Zone Identifiers* (A, B, And C) (not used)
- *Hardwired Loop Identifiers* (Zone 1 = Gate, Zone 3 = Fence)
- *Keypad Address* (used in Group Mode). If two keypads are used to control one energizer, one of the keypad addresses MUST have an ID of 2. The other keypad can have an ID of from 1 to 8 but excluding 2.

9.3 To Exit Keypad Programming

When you have finished programming, press [*] [#].

NOTE: *The keypad will also exit the programming mode if you do not press any key within a five minute period.*

9.4 Other Keypad Functions

- To turn the backlight on or off. [*][8][#]
- To turn the audible feedback on or off. [*][5][1][#]
- To change the Keypad Messages to English [*][3][1][#]
- To change the Keypad Messages to Spanish [*][3][2][#] (not well supported yet)

9.5 Multiple Keypads

All Z series energizers have support for up to two keypads provided the Energizers firmware version is 7v66 and above. If more than one keypad is desired one of the keypads must have an ID of 2, the other keypad can have an ID number from 1 to 8 but excluding ID 2. If only one keypad is desired any ID number from 1 to 8 can be used.

10. SECTOR SETUP TESTS AND ADJUSTMENT

With a single sector system there are two considerations for the electric fence monitor voltage level:

1. The monitor should trigger the alarm if one of the live wires is shorted to ground.
2. The monitor should trigger the alarm if one of the live wires is cut.

Use common sense and turn the energizer off when making changes to the fence, then turn the energizer back on to check the effects.

10.1 Basic Fence Tests

1. Energise the newly-completed fence.
2. Use an Electric Fence Power Probe to find any construction faults.
3. Check that there is voltage on all live wires (continuity) and that there are no shorts from live to earth, or between live circuits (Bi-Polar).
4. Check the electric fence earth. (See electric fence manuals.) One method is to make an intentional short from live wire to earthed metal (not +ve to -ve if using Bi-Polar). The voltage at the earthed point should be less than a few hundred volts; the voltage on the earth stake with respect to any nearby earthed metal should be less than a few hundred volts.
5. Record the start and end of fence live wire voltages.

NOTE: Bi-Polar systems should have approximately equal voltages with respect to earth.

6. Record the live wire currents going out from the energizer to the fence.

At this point you must have a reasonable voltage on all parts of the fence. To be an effective barrier, the Power Probe (or voltmeter) readings between wires (live to earth or +ve to -ve for Bi-Polar) must be greater than 5.0kV. If they are not, then you may require a larger energizer.

10.2 Fault Condition Tests

1. To simulate a break, disconnect a joint in the live wires at some convenient point on the fence, making sure that the wires do not short to ground or between +ve and -ve wires.
2. Check that the energizer fence alarm activates. If not, check the voltage (using an electric fence voltmeter) at the inputs to the monitor. Set the fence alarm voltage level higher than this voltage. If there is still considerable voltage, you may have induced voltage in the live return wires. If so, reduce the induced voltage by placing a 3000 Ohm resistor between the live return and earth return terminals (or from +ve to -ve in a Bi-Polar system) at the monitor.
3. Reconnect the live wires.
4. Place a short on the fence live wires.
5. Check that the monitor goes into alarm.
6. Remove the short.

11. SOME STANDARD REQUIREMENTS FOR ELECTRIC SECURITY FENCES

The JVA range of energizers has been extensively tested and certified in accordance with international standards. JVA does not take responsibility for the erection standards of the fence. It is the responsibility of the erector to consult and comply with the Standards and Codes of Practice for the installation and erection of electric security fences. For the user's convenience, we include some Standard Requirements here but the installer also needs to consult standards such as SABS 1063, 0142, SABS IEC 60335-2-76.

11.1 Definitions

Physical Barrier

A barrier of not less than 1.5m in height and intended to prevent inadvertent contact of persons with the conductors of the electric fence.

NOTE: Physical barriers are typically constructed from vertical sheeting, rigid vertical bars, rigid mesh or rods of chain wire mesh.

Public Access Area

Any area where persons are protected from inadvertent contact with pulsed conductors by a physical barrier (see above).

Pulsed Conductors

Conductors that are subjected to high voltage pulses by the energizer.

Secure Area

An area where a person is not separated by a physical barrier (see above) from pulsed conductors (see above) below 1.5m.

11.2 Installation, Operation and Maintenance

11.2.1 Electric security fences and their ancillary equipment shall be installed, operated and maintained in a way that minimises danger to persons, and reduces the risk of persons receiving an electric shock unless they attempt to penetrate the physical barrier, or are unauthorised to be in the secure area.

11.2.2 A space of 2.5m shall be maintained between uninsulated electric fence conductors or uninsulated connecting leads that are supplied from different energizers. This space can be less where the conductors or the connecting leads are covered by insulating sleeving, or consist of insulated cables that are rated to at least 10kV.

- 11.2.3 The requirement in 10.2.2 does not apply in cases where the separately energised conductors are separated by a physical barrier that has no openings greater than 50mm.
- 11.2.4 A vertical separation of not less than 2m shall be maintained between pulsed conductors fed from different energizers.
- 11.2.5 Mains supply wiring shall not be installed in the same conduit as signalling leads associated with the electric security fence installation, but shall be installed in accordance with the requirements given in SABS 0142.
* NB. (Fence HT leads must under no circumstances be routed in the same conduit as any other wiring.)

11.3 Warning Signs

NOTE: Regulation warning signs are available from all JVA Electric Fence centres and all JVA certified dealers.

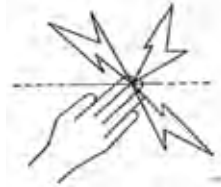

- 11.3.1 Electric security fences shall be identified by prominently placed warning signs that shall be legible from the secure area and from the public area.
- 11.3.2 Each side of the electric security fence will have at least one warning sign.
- 11.3.3 A warning sign shall be placed:
 - a. at each gate
 - b. at each access point
 - c. at intervals not exceeding 10m
 - d. adjacent to each sign with regard to chemical hazards, for emergency services information.

11.4 Gates

Gates in electric security fences shall be capable of being opened without the person who is operating the gate receiving a shock.

11.5 Earthing

- 11.5.1 Where an electric security fence passes below bare power line conductors, the highest metallic element shall be effectively earthed for a distance of not less than 5m on either side of the crossing point.
- 11.5.2 The distance between any electric fence earth electrode and other earth systems shall be not less than 10m, except when the earth system is associated with a graded earth mat. The earth electrode shall comply with SASS 10611. Amendment 1, Deco 2000 1.
- 11.5.3 All exposed conductive parts of the physical barrier shall be effectively earthed.

11.6 Protection

11.6.1 All ancillary equipment connected to the fence circuit shall be designed to provide a degree of isolation between a fence circuit and the supply mains equivalent to that specified for the energizer.

11.6.2 Protection from weather shall be provided for the ancillary equipment unless the equipment is certified by the manufacturer as being suitable for use outdoors, and is of a type with a minimum degree of protection IPX4 (protected against splashing water).

Power line voltage	Minimum clearance
<1 000	3m
>1 000 and <33 000	4m
>33 000	5m

Fence to powerline minimum clearance

Figure 1

Typical constructions where the electric security fence is exposed to the public.

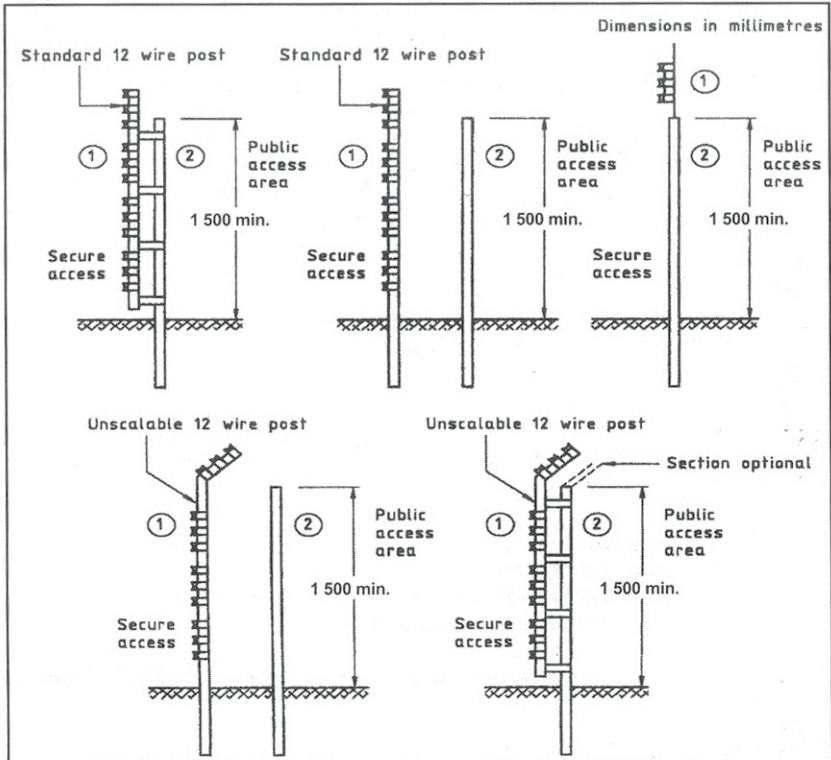

Figure 2

Typical fence constructions where the electric security fence is installed in windows and skylights.

- Key: ① Electric security fence
 ② Physical barrier

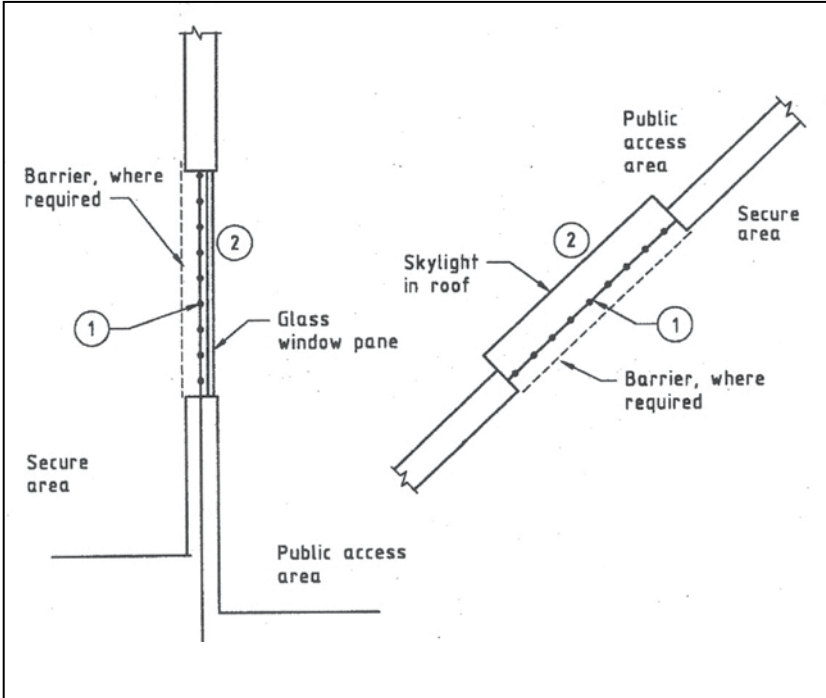
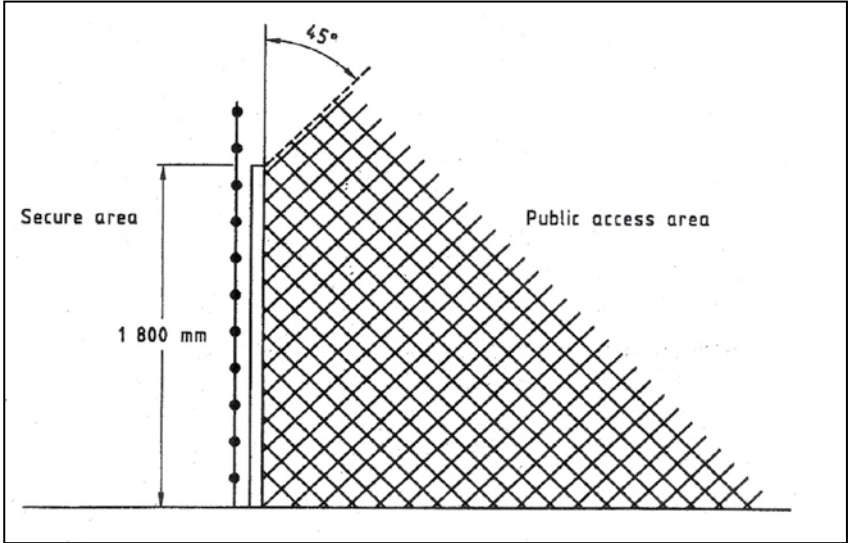

Figure 3
Prohibited zone for pulsed conductors.

- Key: ●●● Electric security fence
 □ Physical barrier
 ▒ Prohibited zone



CUSTOMISED CODES

Customer Pin No.

Installer Pin No:

INSTALLER DETAILS

Name

Phone No.

Date Of Installation



12. WARRANTY

All JVA products carry a **2-year warranty** against defective components and workmanship. The warranty excludes damage caused by acts of Nature such as lightning or flooding, power supply surges, rough handling, malicious actions or incorrect wiring.

Whilst every effort has been made to check that the information contained is accurate, JVA Technologies Pty Ltd will not be liable to loss or damage resulting from construction, operation or failure of any installation or system. Installation of security electric fences should be made by trained professionals with regard to the relevant local standards and workplace health and safety requirements.

Product model purchased: Serial No:

Customer Name:

Address:
.....
.....

Postal Code:

Tel. No: Cell: Landline:

email:

Date purchased:

Invoice No:

Dealer Name:

Dealer's Stamp



Mail to:

Your local JVA Dealer

SA JVA Service Department P.O. Box 13898, Cascades 3202

Warranty

Report Number: PL2008039/ASNZS

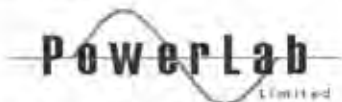
Test Report

DATE ISSUED: 24 February 2009

ITEM(S) TESTED: JVA Technologies
Type D electric fence energizer
model Z14

CLIENT'S NAME: Pakton Technologies
1 Holium Street
PO Box 408
Narangba QLD 4504
AUSTRALIA

Attention: Paul Thompson

CLIENT'S REFERENCE: Purchase Order: 00009533

TEST SPECIFICATION: AS/NZS 60335.2.76:2003 (with amendment AMD 1/2006-10-20)
Household and similar electrical appliances - Safety - Part 2.76: Particular requirements for electric fence energizers
(In conjunction with AS/NZS 60335.1:2003 with amendments AMD1/2004-05-31, AMD2/2007-05-25) and AMD3/2007-11-30)

DATE OF TEST COMPLETION: 24 February 2009

SUMMARY OF RESULTS: The sample energizer complied with the requirements of the test specification.



All tests reported herein have been performed in accordance with the Laboratory's terms of registration. Laboratory Registration Number: 12

IANZ Signatory: G I Dix

Checked By: K. Manson

PowerLab Limited, PO Box 31034 Christchurch 8444 New Zealand, 5 Shelfield Crescent Christchurch New Zealand, info@powerlab.co.nz. This Report must not be quoted except in full.



Z14 STANDARD AND BI-POLAR ENERGIZERS



Z18 STANDARD AND BI-POLAR ENERGIZERS



Z28 STANDARD 2-ZONE ENERGIZER

Z-RANGE

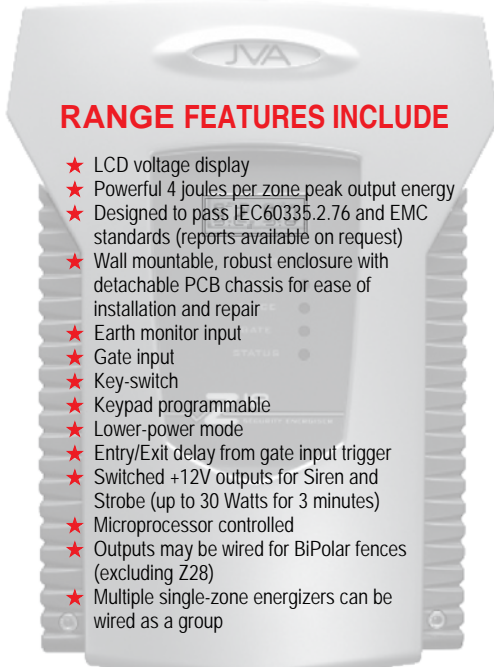

RANGE FEATURES INCLUDE

- ★ LCD voltage display
- ★ Powerful 4 joules per zone peak output energy
- ★ Designed to pass IEC60335.2.76 and EMC standards (reports available on request)
- ★ Wall mountable, robust enclosure with detachable PCB chassis for ease of installation and repair
- ★ Earth monitor input
- ★ Gate input
- ★ Key-switch
- ★ Keypad programmable
- ★ Lower-power mode
- ★ Entry/Exit delay from gate input trigger
- ★ Switched +12V outputs for Siren and Strobe (up to 30 Watts for 3 minutes)
- ★ Microprocessor controlled
- ★ Outputs may be wired for BiPolar fences (excluding Z28)
- ★ Multiple single-zone energizers can be wired as a group

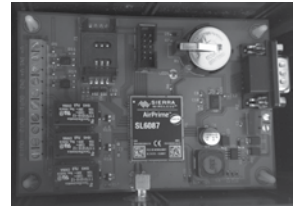

GSM MONITORS AND CONTROLS JVA ENERGIZERS USING A CELL PHONE



WEB SERVER MONITORS AND CONTROLS JVA ENERGIZERS VIA THE INTERNET

PERIMETER PATROL COMPLETE CONTROL SYSTEM MONITORING EVENT LOGGING



Customer Support

For assistance: If you have any questions or need further assistance, please call your nearest JVA dealer. SA Tel. No.: 0861 782 349.

For service or repairs: If a service or repair is required, please package and label your energizer carefully and return it to your local JVA Service Centre.

For warranty repairs: Include proof of purchase, e.g. invoice.

Note: Repair centre details are displayed on the back cover of this manual.



JVA products are designed by JVA Technologies, Queensland, Australia and distributed to:



JVA SA SERVICE CENTRES

East Rand (Jet Park)

Aerostar Business Park
219 Jet Park Road, Jet Park
Tel: 011 397 3507

North Rand (Kya Sand)

174 Bernie Street
Randburg
Tel: 011 708 6442

West Rand (Roodepoort)

602 Ontdekkers Road
Delaréy, Roodepoort
Tel: 011 472 8823

Pretoria

1185 Steve Biko Road
(977 Voortrekker Road)
Wonderboom South
Tel: 012 335 4290

Kimberley

29 Schmidtsdrift Road
Tel: 053 861 5631

Cape Town

Unit 15, Viking Business Park
Viking Way, Epping Industria
Tel: 021 534 5056

Polokwane

19A Suez Street
Nirvana
Tel: 015 292 6273

Nelspruit

D1 Waterfall Park
15 Rapid Street
Riverside Industrial Park
Tel: 013 752 7152

Bloemfontein

36 Kolbe Lane
Tel: 051 448 6695

Pinetown

Unit 1, 7 Suffert Street
Tel: 031 702 6351

Rustenburg

1 Howick Avenue, Shop 7, Waterfall Mall
Tel: 014 537 2884

Durban North

Shop 11, Arcadia Centre
87 Umhlanga Rocks Drive
Tel: 031 563 0274/
031 563 6478

Pietermaritzburg

51 Winston Road
Tel: 033 342 6727

Port Elizabeth

45 Mangold Street
Newton Park
Tel: 041 365 7178

East London

Shop 3, Paphos Park
Devereaux Avenue
Tel: 043 726 6652/60

George

Shop 3, 57 York Road
George
Tel: 044 874 0669