

IQBoard IR Pro & IR-D Pro

User Manual



Copyright(C) 2003-2012 Fuzhou Returnstar Technology Co., Ltd.

Websites: www.recoverystar.com; www.iqboard.net

Tel: 0086-591-87274373

Fax: 0086-591-87274383

E-mail: master@iqboard.net

Statement

This manual is for IQBoard IR Pro & IR-D Pro.

Both Whiteboard and Interactive Whiteboard in this manual refer to IQBoard IR Pro or IQBoard IR-D Pro. Colorless Writing Pen (Finger) is used for IQBoard IR Pro or IQBoard IR-D Pro.

Use this product strictly according to detailed operation instruction in this manual so as to ensure proper use. Please read this manual carefully before you install this product.

Opening the package means you have agreed to purchase this product, Returnstar will not accept returns of opened packages.

The product specification may be subject to change without prior notice. The sample pictures in this User Manual may differ from the real product.

Returnstar reserves all rights to charge the fee at anytime for product replacement, revision and update. The information in this manual is subject to regular change without prior notice. Returnstar will make no warranties with respect to this product and disclaims any warranties, whether express or implied, of merchantability and fitness for a particular purpose.

Trademark Notice

Returnstar and IQBoard are registered trademarks of Fuzhou Returnstar Technology Co., Ltd.. Windows is a registered trademark of Microsoft Corporation.

Recycling

Always return your used electronic products, batteries, and packaging materials to separate collection. This way you help prevent uncontrolled waste disposal and promote the recycling of materials.

Temperature and Humidity Requirements

Storage

Temperature: -40°C ~ 60 °C Humidity: 0% ~ 95%

Operation

Temperature: 0°C ~ 40 °C Humidity: 15% ~ 85%

CONTENT

CHAPTER 2 SPECIFICATIONS	5
2.1 PERFORMANCE	5
2.2 FLEXIBLE FIXING AND RELOCATING METHODS	5
2.3 DURABLE SURFACE, SOLID BODY	5
2.4 PC CONNECTION	5
2.5 IQBOARD IR PRO & IR-D PRO MODELS	6
2.6 SYSTEM REQUIREMENTS	6
CHAPTER 3 HOW TO INSTALL IQBOARD	7
3.1 MOUNT WHITEBOARD	7
3.1.1 For Product with an “M” in Its Hardware SN	7
3.1.2 For Product with a “Y” in Its Hardware SN	9
3.1.2.1 Wall Mounting	9
3.1.2.2 Stand Mounting	11
CHAPTER 4 HOW TO CONNECT TO COMPUTER AND PROJECTOR	17
CHAPTER 5 HOW TO INSTALL AND UNINSTALL DRIVER	18
5.1 HOW TO INSTALL DRIVER	18
5.2 HOW TO UNINSTALL DRIVER	18
CHAPTER 6 HOW TO SETUP IQBOARD	19
6.1 ORIENTATION	19
6.2 HOTKEY SETTINGS	20
CHAPTER 7 HOW TO USE IQBOARD	22
7.1 BASIC OPERATIONS	22
7.2 HOW TO USE HOTKEYS ON WHITEBOARD	23
7.3 HOW TO USE GESTURE RECOGNITION	24
7.3.1 Enable Gesture Recognition	24
7.3.2 Customize Gesture Recognition Sensitivity	25
7.3.3 Basic Operations	25
7.4 HOW TO USE SMART PEN TRAY	26
CHAPTER 8 FAQ	27
CHAPTER 9 CAUTIONS AND MAINTENANCE	29
9.1 WHITEBOARD	29
9.2 USB CABLE	30
9.3 PROJECTION	30
9.4 TRANSPORT	30
9.5 PART REPLACEMENT	30

Chapter 1 Product Introduction

IQBoard IR Pro & IQBoard IR-D Pro are the latest interactive presentation boards. Connect the whiteboard with your computer and projector, then simply touch the projection area with your pen or your finger, you can transform the pen or your finger to Mouse and directly operate the computer on the projection area. If you select IQBoard IR-D Pro, two users can operate on the board simultaneously by entering Dual-mode in IQBoard Software.

With IQBoard IR Pro / IR-D Pro and IQBoard Software, marvelous interactive communicating effects can be achieved in live demonstration, teaching, product exhibition, business conference, video communication, news broadcast, securities evaluation, military command, entertainment, medical consultation, engineering design, competition tactics analysis, weather analysis, etc.

IQBoard IR Pro / IR-D Pro is provided with powerful IQBoard Software, which makes your operation on interactive whiteboard more convenient. Through IQBoard Software, various interactive teaching and demonstrating functions can be achieved, such as write, erase, label (in character, line, dimension and angle), drag, zoom, reveal screen, spotlight, screen capture and save, screen record and playback, handwriting recognition, on-screen keyboard, text input, text to speech, hyperlink to video, sound and webpage, and remote conference by NetMeeting. IQBoard Software also has colorful object animation effects, page switching effects and interactive questions. Therefore, with IQBoard Software, users can make more interactive courseware by designing unique object animation, adding sound or hyper linking.

IQBoard Software also includes 500M IQBoard Resource Library covering more than 30 subjects, such as math, physics, chemistry, biology, gymnasium, etc. User can customize the installation by selecting subjects. The software also provide common line, shape, character, symbol, decoration graph, background template, Flash courseware, and other resources. Moreover, the software supports importing various picture files and DOC(X), PPT(X), XLS(X), PDF files. The page and file created by IQBoard Software can be saved as and freely converted to various picture files as well as DOC(X), PPT(X), XLS(X), PDF, html files, etc.

We provide continuous upgrading service for IQBoard Software. For more information and detailed operation about IQBoard Software, please refer to IQBoard Software User Manual in the installation CD.

Chapter 2 Specifications

2.1 Performance

Resolution: 9600×9600, 600dpi;
Signal tracking rate: 8m/s;
Signal processing rate: 480 dots/s;
Orientation: 4, 9 or 20 points

2.2 Flexible Fixing and Relocating Methods

Fixing methods include wall hanging, cabinets, and mobile stand. Provide optional height adjustable mobile stand for 50-120 inch whiteboards, the height can be adjusted from 1.88M to 2.12M.

2.3 Durable Surface, Solid Body

The surface adopts dedicated writing film made of DuPont anti-abrasive coating. It features with anti-scratch, high luminance, high definition, easy cleaning (can be cleaned by whiteboard detergent or wet cloth), and can completely eliminate bright spots. The backboard, which is resistant to distortion, expansion and shrinkage, adopts PS board with high density. Model supporting normal pen writing is also provided.

2.4 PC Connection

Connection Way 1:

Standard: 10m USB cable for connecting IQBoard with PC, external power is not required.

Optional: USB signal amplifier to extend the USB cable to 20m and 2.4G radio frequency wireless module with 25m effective transmission distance.

Connection Way 2:

Standard: 5m USB cable for connecting IQBoard with PC, external power is not required.

Optional: 5m USB cable to extend the standard 5m USB cable to 10m and 2.4G radio frequency wireless module with 25m effective transmission distance.



Note: Each board can only support one of these connection way when product. Please do not miss use these two connection ways.

2.5 IQBoard IR Pro & IR-D Pro Models

RP060, RP080, RP085, RP0100 and RP105 refer to IQBoard IR Pro in relevant sizes. RPD060, RPD080, RPD085, RPD0100 and RPD105 refer to IQBoard IR-D Pro in relevant sizes. N means hotkeys and pen tray are not included. W means board surface supporting normal pen writing. For example, RP080PCNWX means 80 inches IQBoard IR Pro without hotkeys and pen tray, and supporting normal pen writing.

2.6 System Requirements

Windows XP/2003/Vista/7

Pentium166 CPU (Pentium II or higher recommended)

64MB RAM (128MB recommended)

1G free hard disk space (for full installation)

1 free USB port

1 projector (short throw or ultra-short throw projector recommended)





Chapter 3 How to Install IQBoard

3.1 Mount Whiteboard

3.1.1 For Product with an “M” in Its Hardware SN

In case your product has an “M” in its hardware SN, you can select wall mounting by 2 anchor bolts fixing on the wall.

Parts list

Picture	Name	Quantity
	Screw	4
	Wall Anchor	2
	Safety Bracket	2
	Anchor Bolt	2
	Wall Mounting Bracket (already mounted on the backboard)	2

Installation steps

Step 1. Determine the installation height of the Anchor Bolt (190cm above floor), then measure the horizontal distance L (70cm recommended) of the two holes on the wall mounting bracket according to the location of the whiteboard. Drill a hole at both ends, then screw the 2 Anchor Bolts into the holes and leave 4mm clearance between bolt head and nut (as shown in the figure below).

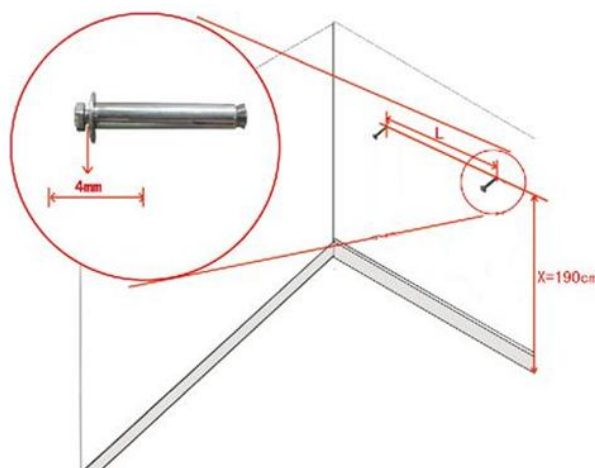

Step 2. According to the distance of the two Anchor Bolts, fix the Wall Mounting Bracket on each screw on the top frame of backboard. Please make sure to fix the Wall Mounting Brackets symmetrically on the backboard to keep the balance (as shown in the figure).

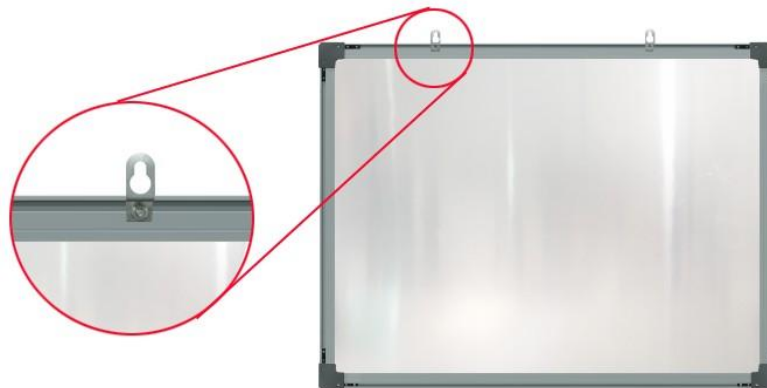

Step 3. Align the Wall Mounting Brackets on the backboard with the Anchor Bolts, and hang the whiteboard on the wall.

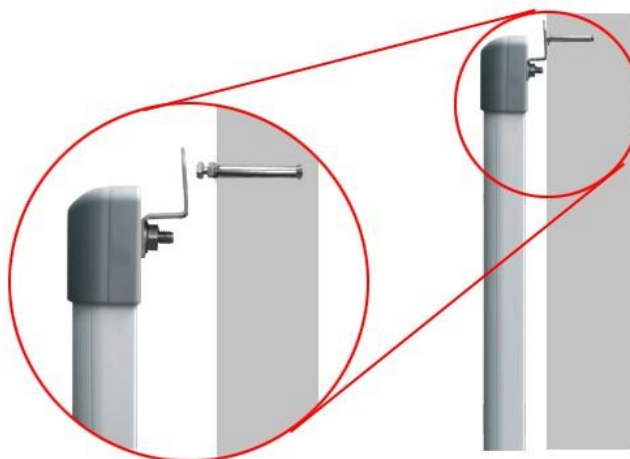

Step 4. Fasten the 2 Safety Brackets on each side of whiteboard lower frame using 2 Screws. According to the location of the Safety Brackets, drill 2 mounting holes on the wall. Finally, use Wall Anchors and Screws to fix the Safety Brackets on the wall.

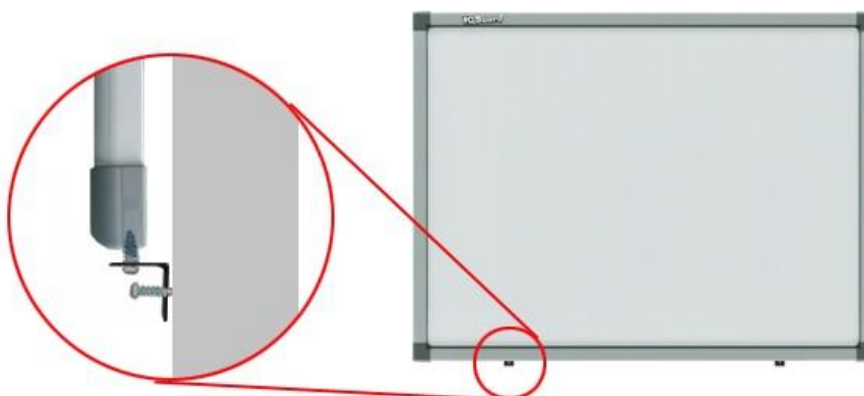

3.1.2 For Product with a “Y” in Its Hardware SN

In case your product having a “Y” on its hardware SN, you can select either wall mounting by 4 anchor bolts fixing on the wall or stand mounting.

3.1.2.1 Wall Mounting

Part list

Picture	Name	Quantity
	Screw	4
	Wall Anchor	2
	Safety Bracket	2
	Anchor Bolt	4
	Height Adjustable Bracket	4

Installation steps

Step 1. Fix 4 Height Adjustable Brackets on screws on the backboard according to Height H. Please make sure to fix the Height Adjustable Brackets symmetrically on the backboard to keep the balance (as shown in the figure).

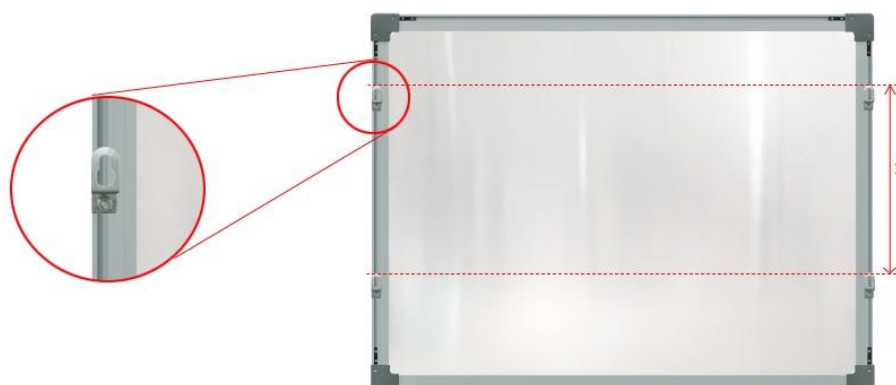

Note: 75cm Height H is recommended for 80" whiteboard.

Step 2. Drill 4 holes at the location where you want to place the 4 Anchor Bolts (the above 2 Anchor Bolt are usually placed 190cm from the floor), insert the 4 Anchor Bolts in these holes, and leave 4mm clearance between bolt head and nut for hanging whiteboard.

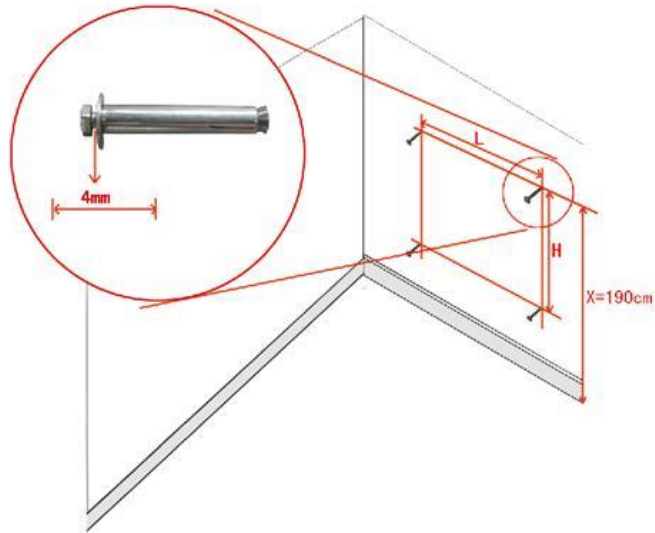

Step 3. Align the Anchor Bolts with the clip holes of Height Adjustable Bracket on backboard, and then hang the whiteboard on the wall.

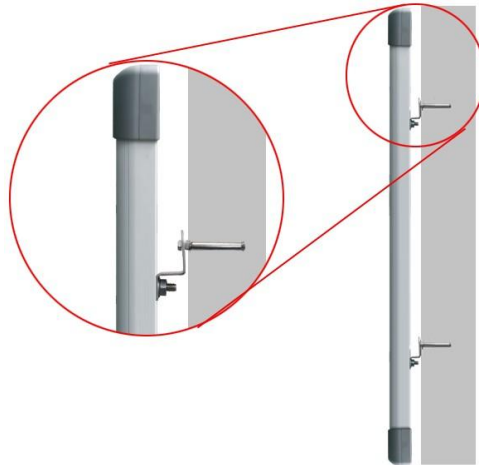

Note: You can adjust the height of whiteboard by hanging the whiteboard on different height of clip holes on Height Adjustable Bracket (The distance between lower frame of whiteboard and floor is 75-80cm recommended).



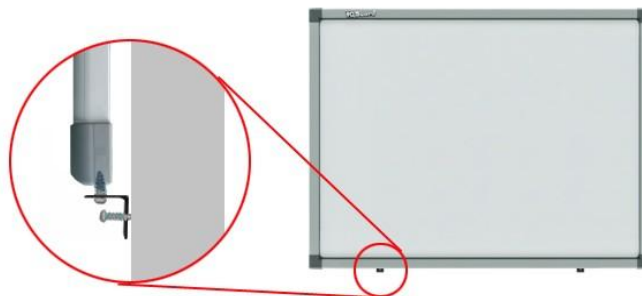

Step 4. Fasten the 2 Safety Brackets on each side of whiteboard lower frame using 2 Screws. According to the location of the Safety Brackets, drill 2 mounting holes on the wall. Finally use Wall Anchors and Screws to fix the Safety Brackets on the wall.



3.1.2.2 Stand Mounting

Parts list

Picture	Name	Quantity
	Leg Bar	2
	Column	2
	Supporting Bar	2
	Caster	4
	Moveable Crossbeam (each includes 2 Beams and a U-shaped Groove; for 100", 112" and 120" whiteboards, Beams and U-shaped Grooves are especially lengthened)	2
	Hexagon Bolt A	2
	Hexagon Bolt B (M8x50, with 08/22 washer)	4
	Hexagon Bolt C (M8x50)	8

	<p>Hexagon Bolt Set A (M8x50) (each set includes: 1 hexagon bolt, 1 wind nut, 1 M8 nut, 1 small washer and 1 big washer)</p>	<p>6</p>
	<p>Hexagon Bolt Set B (M8x35) (each set includes: 1 hexagon bolt, 1 wind nut, 1 small washer and 1 big washer)</p>	<p>4</p>
	<p>Anchor Bolt (M8x60)</p>	<p>4</p>
	<p>Open-end Wrench</p>	<p>1</p>

Installation steps

Step 1. Install Column on each Leg Bar with Hexagon Bolt B.



Step 2. Install one end of each Supporting Bar on each Leg Bar, using Hexagon Bolt A.

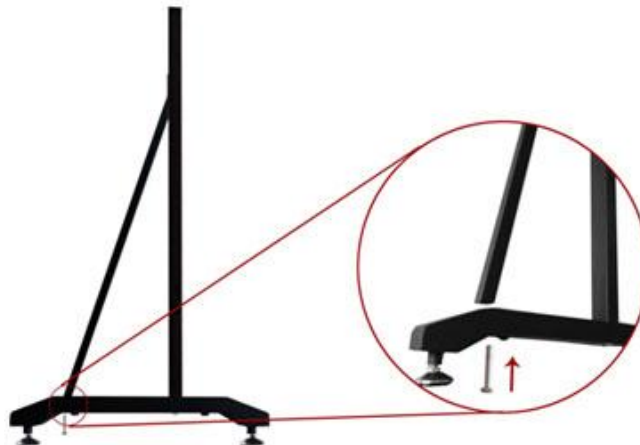

Step 3. Install the other end of each Supporting Bar on each Leg Bar, using Hexagon Bolt Set A. In this stage, please partially screw the bolt, leaving 4mm clearance between bolt head and Column for hanging whiteboard.

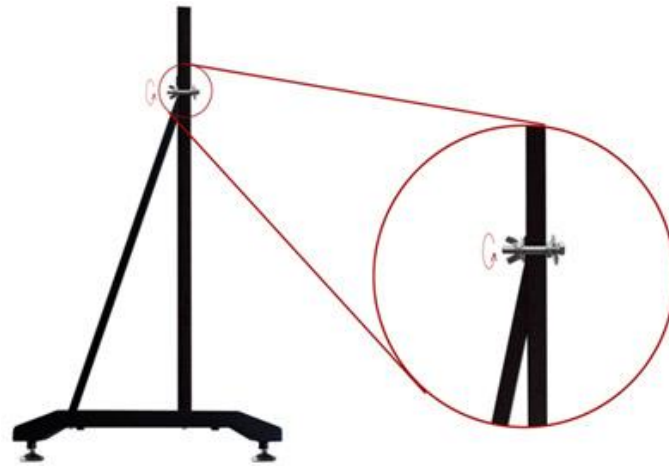

Step 4. Install 2 Casters on each Leg Bar.

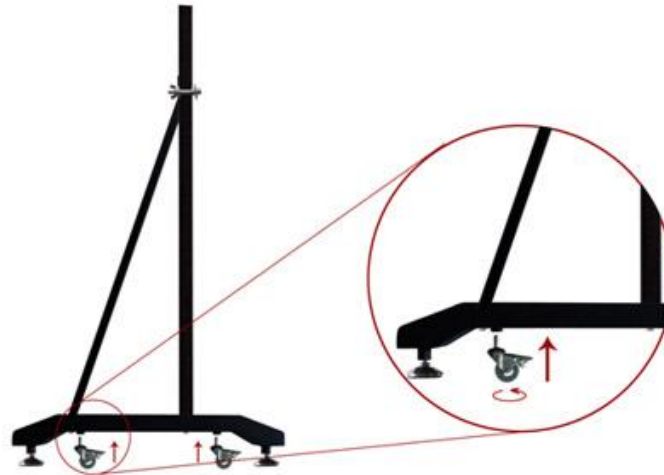

Step 5. Install 2 Beams on each Column, using Hexagon Bolt C

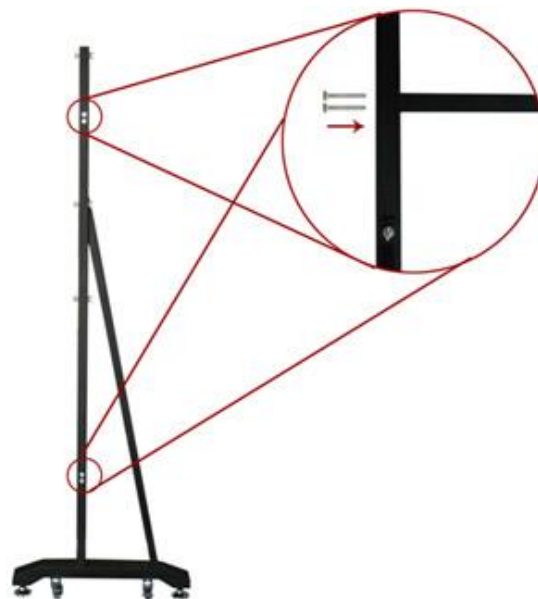

Step 6. Lay down and connect the two leg assemblies with U-Shaped Grooves.



Step 7. Secure U-Shaped Grooves with Hexagon Bolt Set B. In this stage, do not completely tighten the bolt in order to adjust the stand width later.

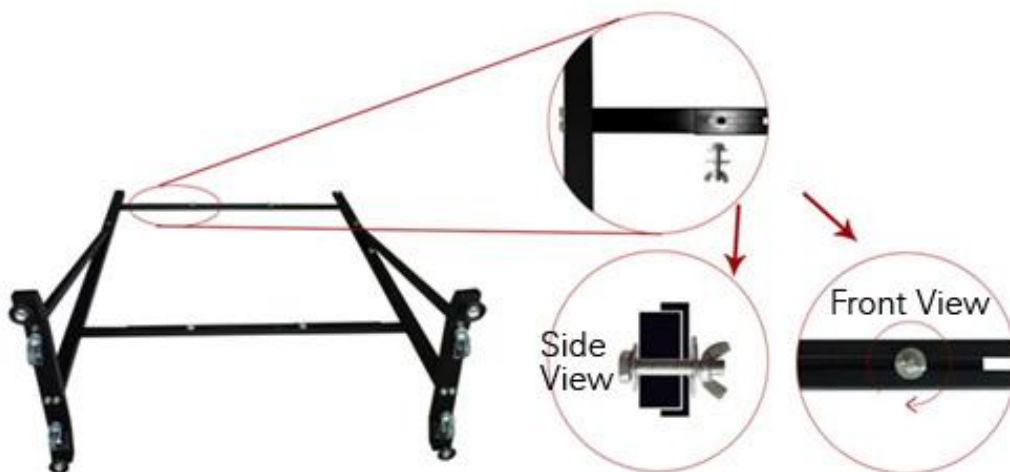

Step 8. Install 2 Hexagon Bolt Sets A on each Column, leaving 4mm clearance between bolt head and nut for hanging whiteboard.

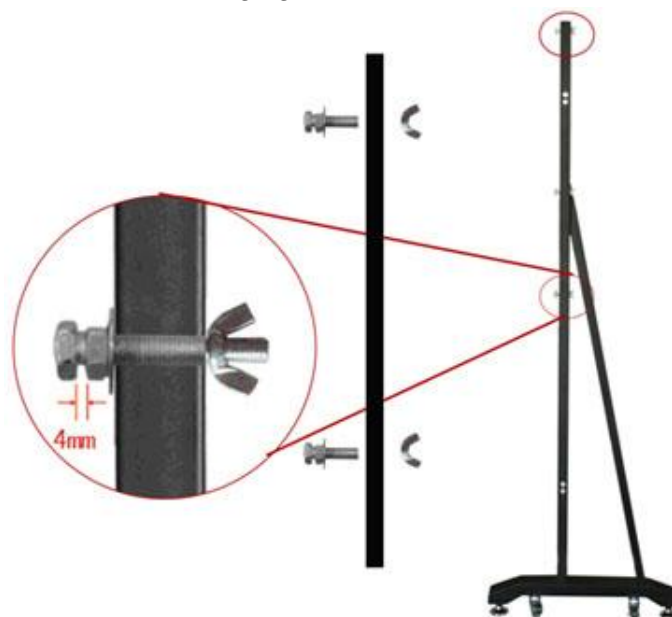

Step 9. Fix 4 Brackets on screws on backboard according to the vertical height of

Hexagon Bolt Sets A. Please make sure to fix the Brackets symmetrically on the backboard to keep the balance (as shown in the figure).

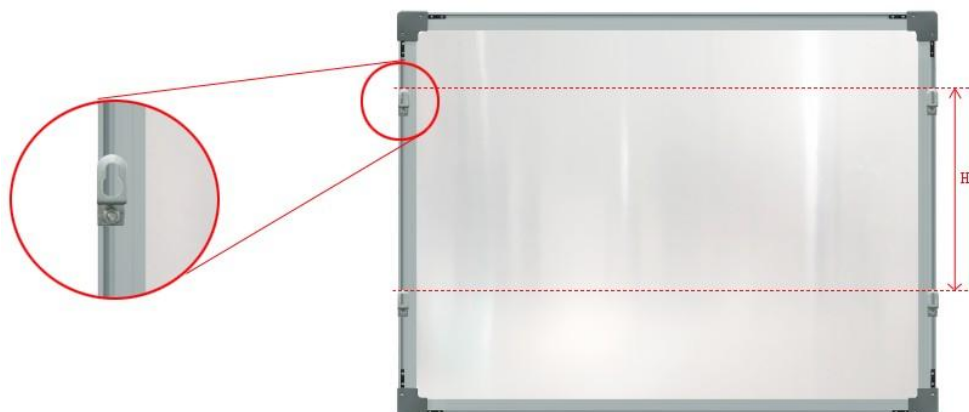

Note: You can adjust the height of whiteboard by screwing the Brackets on different height of backboard (The distance between lower frame of whiteboard and floor is 75-80cm recommended).

Step 10. Align the Hexagon Bolt on the Column with the clip holes of Height Adjustable Bracket on left and right frames of backboard, and hang the one side of whiteboard on the stand. Then adjust the stand width to fit the whiteboard, and hang other side of the whiteboard on the stand. Finally, tighten the bolts on the U-Shaped Groove and Columns.





Fully assembled whiteboard is as follows:



Chapter 4 How to Connect to Computer and Projector

After fixing the whiteboard, find a connecting port at the bottom of left corner protector. Plug the USB Standard-B into the connecting port, and plug the USB Standard-A into the available USB port of computer, as follows. External power source is not required. And please connect the projector into the VGA port of your PC video card.

	
USB Standard-A Plug for connecting the computer	USB Standard-B Plug for connecting whiteboard

Start the projector after connection, and adjust it to make its projection within the active area and centered. Then use the trapezoid rectification function of the projector to make the projection quadrature.

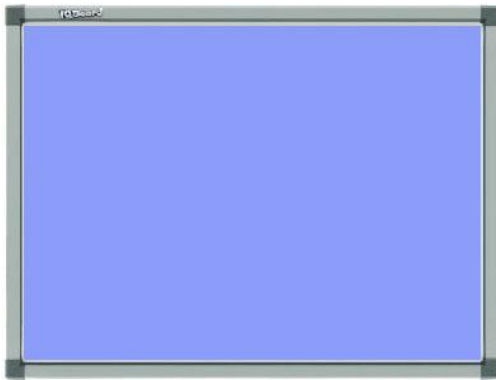

Maximum projection area for whiteboards without hotkey

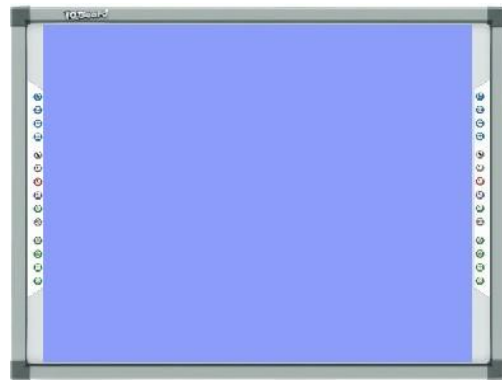

Maximum projection area for whiteboards with soft hotkeys

The blue areas are the maximum projection areas. For whiteboards without hotkey, there should be 1cm margin between projection area and whiteboard inner frame. For whiteboards with soft hotkeys, the projection area should not exceed the hotkeys.



Note:

- 1. In case you use 16:9 whiteboard, please choose the projector supporting the 16:9 projection mode.*
- 2. The projection image must be within the active area of the whiteboard, otherwise the whiteboard cannot work normally.*

Chapter 5 How to Install and Uninstall Driver

5.1 How to Install Driver

Run the relevant driver in the installation CD, and install the driver according to the prompt. The computer will automatically find a new hardware and install the driver.



Note:

1. *IQBoard IR PRO Driver is different from IQBoard IR-D PRO Driver.*
2. *After the driver installation is finished and the whiteboard is normally connected, the system will prompt you that "Initializing the hardware, please do not touch the writing area..... ". Please do not operate until the initializing process is done.*

5.2 How to Uninstall Driver

Select "Start > Programs > IQBoard IR Pro Drivers (or IQBoard IR-D Pro Drivers) > Uninstall" to uninstall. You also can open Control Panel, select "Add/Remove Programs", and in the list of currently installed Programs, select "IQBoard IR Pro Drivers" or "IQBoard IR-D Pro Drivers", then press the "Change/Remove" button to remove the drivers.

Chapter 6 How to Setup IQBoard

6.1 Orientation

At the first time you use IQBoard, you need to orient it, so the moving track of the pen (finger) can match the cursor. You can select 4 points, 9 points or 20 points orientation. Normally 9 points orientation is adopted. After the whiteboard is oriented, you don't need to re-orient under the same environment.

To orient the whiteboard

Please do as following steps when you orient the whiteboard:

Step 1. Select "Start > Programs > IQBoard IR Pro Drivers (or IQBoard IR-D Pro

Drivers) > Orient" or press  on the hotkey bar if your whiteboard is with hotkeys.

Then the Orientation Points Selection window appears as follow.

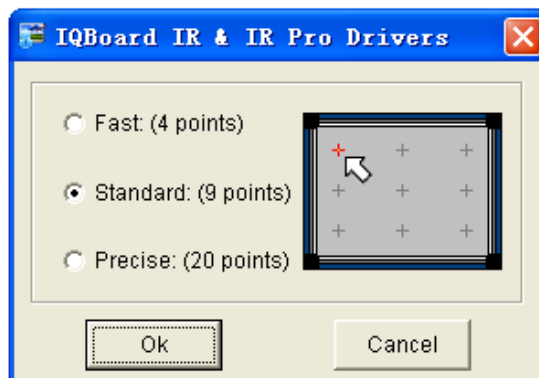

Step 2. Select one of the Orientation Points and click "OK", the Orientation interface appears as follow.

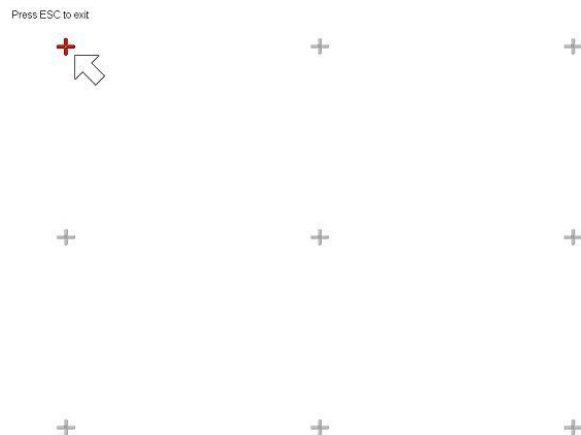

Step 3. Follow the on-screen instructions, press the center of each cross accurately with the pen or finger tip.

Your whiteboard is now oriented.



Note:

1. If you did not locate the accurate central point or clicked the wrong point, or the next fixed point appeared without press, please press “ESC” on the keyboard to exit this orientation and re-orient. Otherwise you can’t operate the whiteboard accurately.
2. Please make your pen (finger) upright when orienting.
3. In case the relative position of the whiteboard and projector is changed, or the driver or the monitor resolution is altered, please re-orient.

6.2 Hotkey Settings

If you select interactive whiteboard with soft hotkeys, at the first time you use the whiteboard, you need to set these hotkeys.

Step 1. Select “Start > Programs > IQBoard IR Pro Drivers (or IQBoard IR-D Pro Drivers) > Hotkey Settings” to enter Hotkey Settings window as follow

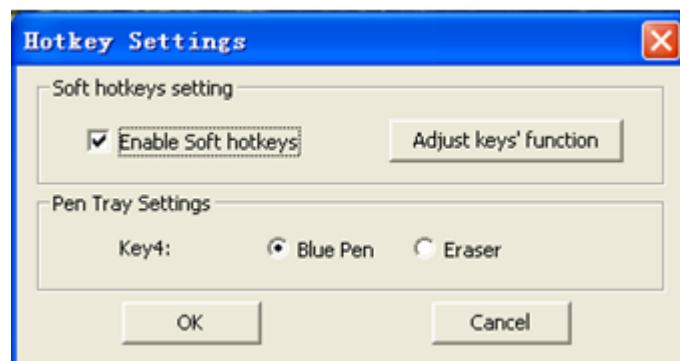

Step 2. Enable Soft Hotkeys and click “Adjust keys’ function”, then you will enter the following window:

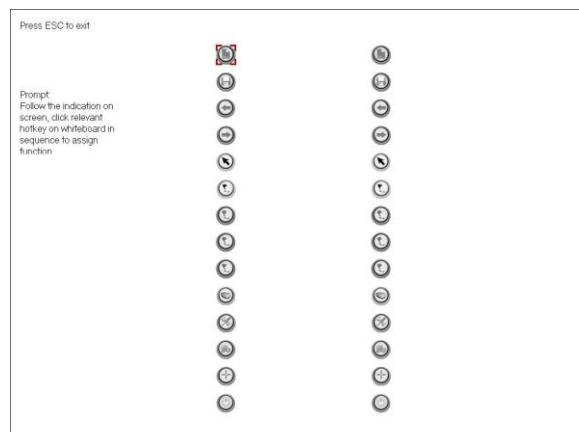

Step 3. Follow the indication on screen, click relevant hotkey in sequence. After the setting is completed, you can use these hotkeys.

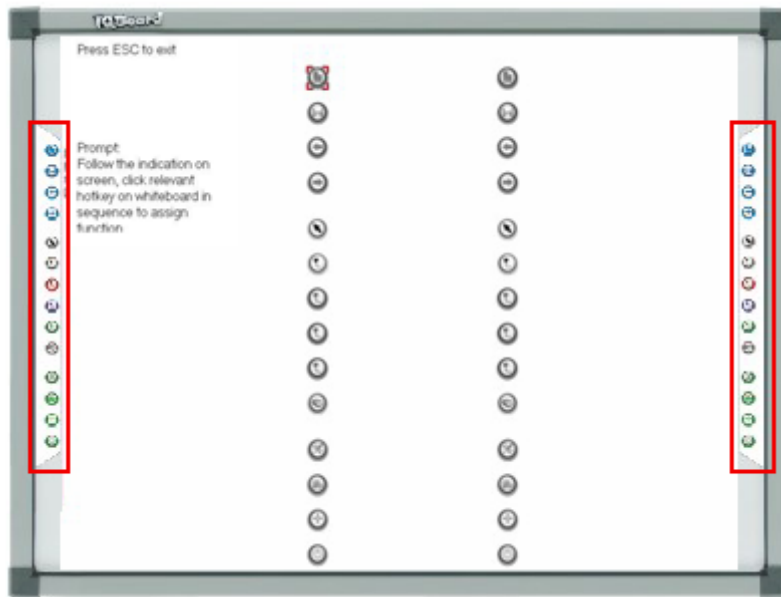

Note:

1. When setting the soft hotkeys, if some error occurs, you can press “ESC” key on the keyboard to exit the setting process, and then reset the hotkeys.

Chapter 7 How to Use IQBoard

7.1 Basic Operations

For IQBoard IR Pro & IR-D Pro, you can use the enclosed pen or your finger to write or perform Mouse function. Following are the tips for some basic operations:

Single-click

If you use pen or finger, press the surface with the pen or finger tip at proper strength.

Double-click

If you use pen or finger, press the surface twice with the pen or finger tip at proper strength. Please make sure you press at the same point.

Right-click

If you use pen or finger, press the surface with the pen or finger tip, and hold for 2 seconds to popup the right-click menu.

Drag

If you use pen or finger, press an object with the pen or finger tip and hold, then move the pen or finger tip to drag the object to the desired position.

Write

If you use pen or finger, start IQBoard Software, select a drawing tool, then you can write or draw by pressing the surface with the pen or finger tip.

Activate IQBoard Software

If IQBoard Software hasn't been activated, you can press interactive whiteboard with your palm to activate IQBoard Software.



Note:

- 1. When you want to erase content, we recommend you pressing interactive whiteboard with your palm. When you want to perform mouse function, we recommend you pressing interactive whiteboard with two fingers closed.*
- 2. Freehand Drawing Tool and Eraser are Pencil and Normal Eraser by default. If you have selected other Freehand Drawing Tool or Eraser before, IQBoard Software will use your previous selections.*
- 3. You can adjust the setting to customize gesture recognition.*
- 4. Gesture recognition can not be used under dual-user model.*

7.2 How to Use Hotkeys on Whiteboard

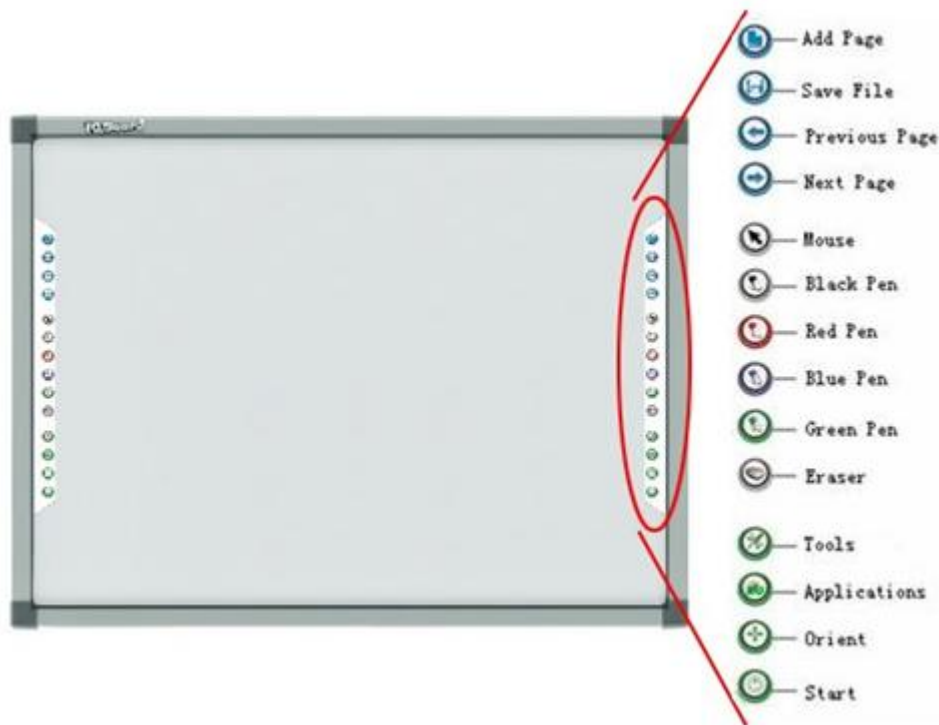



Following is the introduction of above soft hotkeys.





Add Page : In Windows Mode, press this key to clear all annotations on screen. In Board Mode, Press this key to add a new page in current .cdf file.

Save File : In Windows Mode, press this key to save all annotations on screen to a page in current file. In Board Mode, press this key to save the current .cdf file.

Previous Page : Press this key to go to the previous page.

Next Page : Press this key to go to the next page.

Mouse : Press this key, you can use pen (finger) to achieve click, double-click, and drag function. When using IQBoard Software, press this key to switch between Windows Mode and Board Mode.

Pen    : There are four “Pen” keys in different colors on the hotkey bar. Press one of these keys, you can write on the board in corresponding color. Press “Pen” twice to modify its properties.

Eraser : Press this key, you can erase the writing content on the board. In Windows Mode, press this key twice to popup the “Shut Down Windows” window.

Tools : Press this key to popup a quick access bar including shortcut icons for frequently used tools in IQBoard Software. You can add up to 8 shortcut icons in this bar.

Applications : Press this key to popup a quick access bar including shortcut icons for frequently used applications. You can add up to 8 shortcut icons in this bar.

Start : Press this key to start the IQBoard Software.

Orient : Press this key to popup the 9 points orientation interface.



Note:

1. Except the “Start” and “Orient” keys, all hotkeys are functional only after IQBoard Software is started.
2. The functions of “Frequently Used Tools”, “Frequently Used Applications”, “Orient” can be opened or closed by press the relevant hotkeys on the hotkey bar.
3. For IQBoard IR-D, when at Split-screen status in Dual-user Mode, the left hotkeys are for Teacher Pen, and the right for Student Pen. Teacher Pen can use the hotkeys including Mouse, 4 Freehand Drawing Tools, Eraser, Frequently Used Tools, Frequently Used Applications and Orient. Student Pen can use the hotkeys including Mouse, 4 Freehand Drawing Tools, Eraser, Frequently Used Tools and Frequently Used Applications. If it’s not Split-screen status in Dual-user Mode, no difference between left and right hotkeys.

7.3 How to Use Gesture Recognition

7.3.1 Enable Gesture Recognition

The default setting of gesture recognition is off. If you want to enable it, please select “Start >Programs > IQBoard IR Pro Drivers (or IQBoard IR-D Pro Drivers) > Gesture Recognition Settings”, and then select the “Enable the Gesture Recognition” check box.

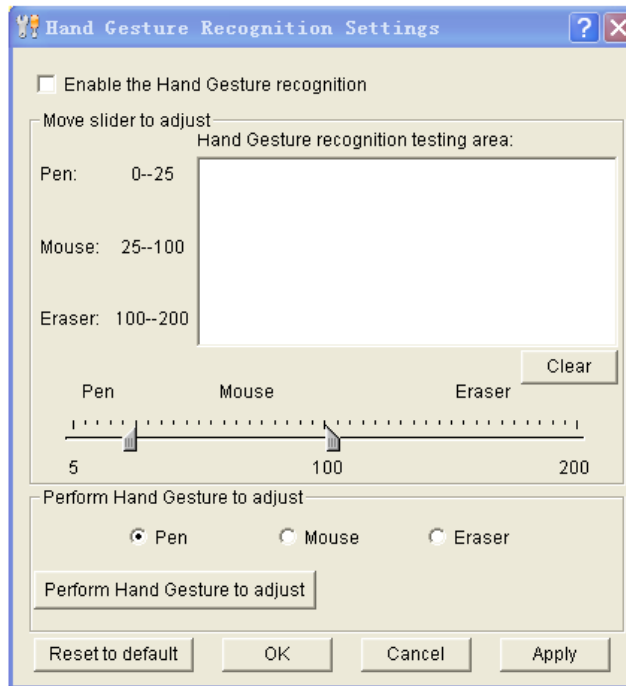

7.3.2 Customize Gesture Recognition Sensitivity

Move slider to adjust

Move the sliders to change the value of each range for functions. The wider the value range, the easier you can perform the related function.

Perform to adjust

An intelligent way to adjust the gesture recognition is performing your hand gesture to customize the function of Pen, Mouse and Eraser.

Select “Pen”, click “Perform Hand Gesture to Adjust”, then press the testing area for one second with pen tip;

Select “Mouse”, click “Perform Hand Gesture to Adjust”, then press the testing area for one second with two fingers;

Select “Eraser”, click “Perform Hand Gesture to Adjust”, then press the testing area for one second with hand palm.

Gesture testing area

Once the gesture recognition is set already, you can still test it. Pressing with hand palm, the cursor will turn to the icon of each function, or the function’s name will show on the testing area.

Reset to default

To reset Gesture Recognition sensitivity to default settings, click “ Reset to Default”.

7.3.3 Basic Operations

Single/Double click

Simply click the active area with the pen or finger tip quickly and make sure click at

the same point.

Right click

When the left-click is on, press the whiteboard area for 2 seconds with your pen or finger to activate the right-click;

Activate IQBoard Software

Tap with five fingers or your palm to activate IQBoard Software.

When in Board, Playing, Windows and Reviewing Modes

Tap with one finger to achieve Freehand Drawing Tools.



Mouse function



Tap with two fingers to imitate functions of Mouse.

Eraser



Tap with your palm to enable function of Eraser.

7.4 How to Use Smart Pen tray

If you choose to buy the interactive whiteboard with smart pen tray, please operate as follow when you enter board or annotating mode,

- 1) When you pick up any pen in the pen tray, the software will automatically apply the color of the pen.
- 2) When you pick up two or more pens at the same time, the software will apply the color of the left pen by default.
- 3) You can set Key4 to Blue Pen or Eraser by enter the following Hotkey Settings Window by clicking “*Start > Programs > IQBoard IR Pro Drivers (or IQBoard IR-D Pro Drivers) > Hotkey Settings*” to enter the setting window as follow

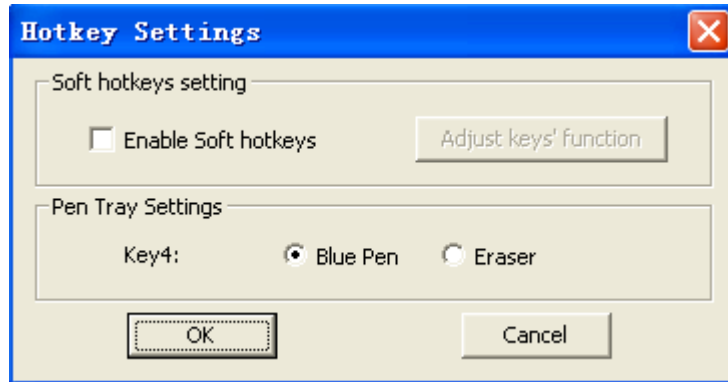

Chapter 8 FAQ

1. What kind of orientation precision should I select?

It depends on your requirement of orientation time and accuracy. You have the following choices:

Quick orientation (4 points): for fast orientation

Standard orientation (9 points): for most of situations

Precise orientation (20 points): for high-definition system

2. When operating and writing on the whiteboard, the position of pen or finger doesn't match the position of cursor.

1) The relevant location of projector and white has been changed. Please re-orient the whiteboard.

2) The projection area has trapezoid distortion, please adjust the projection area, and re-orient the whiteboard.

3) When orienting the whiteboard, the pen or finger is not perpendicular to the surface, please re-orient with correct posture.

4) When orienting the whiteboard, the pen or finger tip missed the green center of the red orienting cross, please re-orient the whiteboard.

5) The filters around whiteboard have been shaded by other objects, such as dust or chalk dust and so on. Please keep filters clean.

3. When I operate and write on the whiteboard, the system response is slow, or the stroke is intermittent.

The computer is not under normal running or the memory is occupied too much. Please close some applications or restart the computer.

The operating or writing force is uneven. Sometimes the force is too light to be sensed.

Initializing hardware failed. Please reconnect the cable with the board to initialize the hardware again.

4. When I operate and write on the IQBoard IR Pro & IR-D Pro, the system doesn't respond.

Please reconnect the cable with the board to initialize the hardware again.

5. What if part of area in IQBoard IR Pro & IR-D Pro can not work or write?

1) Hardware initialization failed. Please reconnect USB cable and try again when hardware initialization is finished.

2) Make sure that you do not touch the board when the hardware initialization is processing. If you touch the board, it will cause this problem. Please reconnect the USB cable or restart computer then try to operate or write on the board after hardware initialization is finished.

6. The pen tip worn out.

Common abrasion will not affect normal operation. When the pen point is severely abraded, you can purchase it from local dealer.

7. When I use Gesture Recognition function, the whiteboard often misinterprets my intent.

When pressing the surface with pen, finger or palm, please use certain strength. If the problem persists, please readjust the Gesture Recognition's sensitivity to suit your style.

You can enable "*Perform Hand Gesture to Adjust*" to readjust the functions.

For other questions, please consult our service center or local dealer.

Chapter 9 Cautions and Maintenance

9.1 Whiteboard

For the interactive whiteboard that do not support normal marker (no “W” included in the product model), please try not to use normal marker to write on the surface. Before cleaning, please shut down the computer and switch the projector into standby mode to make the dirt more obvious. In case of normal dirt, spray some water or detergent on the surface, then use the paper to wipe the dirt out. If you leave some ink trail by mistakenly using the fountain pen, please buy some special whiteboard detergent and spray it on the soft cloth to clean the surface. For cleaning the mark left by the permanent marker, first paint some ink of dry erase marker on the mark (the ink of dry erase marker can dissolve the ink of permanent marker), then use soft cloth to clean. If the mark still exists, spray some whiteboard detergent, and clean it out.



Note: Please do not use other organic solvent for cleaning. Otherwise it may permanently damage the surface.

For the interactive whiteboard that supports normal marker, you can use normal whiteboard eraser and wet cloth to clean.



Note: Clean the frequently used whiteboard once a week to keep the best definition.

Please do not use sharp or pointed objects to scratch the surface and frame, otherwise the scratched part may be damaged, and won't work normally. During the usage, do not knock or press the surface fiercely with your pen, wand or finger to avoid the damage of whiteboard surface, pen and wand. You can use sand wax to eliminate the scratch on the surface, and use dry cloth to clean out.

Since the mobile stand (or the wall hanging parts) is designed only to support the weight of the whiteboard, please do not put the additional weight or pressure on the whiteboard. Please keep the whiteboard away from intense collision, shaking, pressing and do not install it by force, otherwise it may cause cracking, short circuit and surface distortion.

Please do not use and install interactive whiteboard in dusty, foggy, wet and inclement environment. Keep it away from sharp object, heat source, corrosive chemicals, fire, and water. Please do not put the whiteboard in the outlet of hot air, otherwise the material will deteriorate and its life-span will be shortened.

To avoid harm from improper operation, please do not use chair or other tool to help short students use the whiteboard. If students are not tall enough to use the whiteboard, please low down the whiteboard under the help of the professional technician.

9.2 USB Cable

Do not put the USB cables on the floor where people might stumble over them. If you have to do so, straighten them and use insulated adhesive tape or cable with contrast color to tie them up. Please don't bend the USB cable excessively. Exposing the USB cable outside for a long time may shorten its life-span and cause other unnecessary damages, so please keep it carefully. If you use the whiteboard in the meeting room or classroom, please fix the cable along the cable alley.

9.3 Projection

Face the whiteboard when operating and writing on the projected image, stand aside when you turn back to face the students. Please do not look at the projector directly to avoid its strong light damaging your eyesight. Instruct students how to use the whiteboard, tell them not to face the projector directly.

9.4 Transport

Please handle with care, and do not put any weight on the surface so as to avoid the surface distortion and damage. Lay the whiteboard upright during the transportation or storage. For long distant transportation, it is suggested to repack the whiteboard with the original packing. If the original packing is unavailable, insert some protective padding between the components to protect them from intense vibration or crash. Please avoid vibration, dampness, electricity, water and pressure in transportation.

9.5 Part Replacement

Please do not disassemble the whiteboard or modify its inner structure so as to prevent accident or trouble. For maintenance or part replacement, please resort to our authorized technician. Make sure that you use our designated part or the one with the same specification when replacing.