

USER MANUAL

ProLite

LCD Monitor

ENGLISH

ProLite X4071UHSU

Thank you very much for choosing the iiyama LCD monitor.

We recommend that you take a few minutes to read this comprehensive manual carefully before installing and switching on the monitor. Please keep this manual in a safe place for your future reference.



CE MARKING DECLARATION OF CONFORMITY

This LCD monitor complies with the requirements of the EC/EU Directive 2004/108/EC "EMC Directive", 2006/95/EC "Low Voltage Directive" and 2011/65/EU "RoHS Directive".

Warning

This is a class A product. In a domestic environment this product may cause radio interference in which case the user may be required to take adequate measures.

IYAMA CORPORATION: Wijkemeerstraat 8, 2131 HA Hoofddorp, The Netherlands

Model No. : PL4071UH



We recommend recycling of used product. Please contact your dealer or iiyama service center. Recycle information is obtained via the Internet, using the address: <http://www.iiyama.com>

You can access the Web page of different countries from there.

- We reserve the right to change specifications without notice.
- All trademarks used in this user manual are the property of their respective owners.
- As an ENERGY STAR® Partner, iiyama has determined that this product meets the ENERGY STAR® guidelines for energy efficiency.

TABLE OF CONTENTS

FOR YOUR SAFETY.....	1
SAFETY PRECAUTIONS.....	1
SPECIAL NOTES ON LCD MONITORS.....	3
CUSTOMER SERVICE.....	4
CLEANING.....	4
BEFORE YOU OPERATE THE MONITOR.....	5
FEATURES.....	5
CHECKING THE CONTENTS OF THE PACKAGE.....	5
UNPACKING.....	5
FITTING AND REMOVAL OF BASE.....	6
CONTROLS AND CONNECTORS : MONITOR.....	7
INSTALLATION.....	9
CONTROLS AND CONNECTORS : REMOTE CONTROL.....	10
PREPARING THE REMOTE CONTROL.....	11
BASIC OPERATION.....	12
CONNECTING YOUR MONITOR.....	15
COMPUTER SETTING.....	16
OPERATING THE MONITOR.....	17
ADJUSTMENT MENU CONTENTS.....	19
SCREEN ADJUSTMENTS.....	27
POWER MANAGEMENT FEATURE.....	30
TROUBLE SHOOTING.....	31
RECYCLING INFORMATION.....	32
APPENDIX.....	33
SPECIFICATIONS.....	33
DIMENSIONS.....	34
COMPLIANT TIMING.....	35

FOR YOUR SAFETY

SAFETY PRECAUTIONS

WARNING

STOP OPERATING THE MONITOR WHEN YOU SENSE TROUBLE

If you notice any abnormal phenomena such as smoke, strange sounds or fumes, unplug the monitor and contact your dealer or iiyama service center immediately. Further use may be dangerous and can cause fire or electric shock.

NEVER REMOVE THE CABINET

High voltage circuits are inside the monitor. Removing the cabinet may expose you to the danger of fire or electric shock.

DO NOT PUT ANY OBJECT INTO THE MONITOR

Do not put any solid objects or liquids such as water into the monitor. In case of an accident, unplug your monitor immediately and contact your dealer or iiyama service center. Using the monitor with any object inside may cause fire, electric shock or damage.

INSTALL THE MONITOR ON A FLAT, STABLE SURFACE

The monitor may cause an injury if it falls or is dropped.

DO NOT USE THE MONITOR NEAR WATER

Do not use where water may be splashed or spilt onto the monitor as it may cause fire or electric shock.

OPERATE UNDER THE SPECIFIED POWER SUPPLY

Be sure to operate the monitor only with the specified power supply. Use of an incorrect voltage will cause malfunction and may cause fire or electric shock.

PROTECT THE CABLES

Do not pull or bend the power cable and signal cable. Do not place the monitor or any other heavy objects on the cables. If damaged, the cables may cause fire or electric shock.

ADVERSE WEATHER CONDITIONS

It is advisable not to operate the monitor during a heavy thunder storm as the continual breaks in power may cause malfunction. It is also advised not to touch the plug in these circumstances as it may cause electric shock.

CAUTION

INSTALLATION LOCATION

Do not install the monitor where sudden temperature changes may occur, or in humid, dusty or smoky areas as it may cause fire, electric shock or damage. You should also avoid areas where the sun shines directly on the monitor.

DO NOT PLACE THE MONITOR IN A HAZARDOUS POSITION

The monitor may topple and cause injury if not suitably located. Please also ensure that you do not place any heavy objects on the monitor, and that all cables are routed such that children may not pull the cables and possibly cause injury.

MAINTAIN GOOD VENTILATION

Ventilation slots are provided to keep the monitor from overheating. Covering the slots may cause fire. To allow adequate air circulation, place the monitor at least 10 cm (or 4 inches) from any walls. Do not remove the tilt stand when operating the monitor. Ventilation slots on the back of the cabinet will be blocked and the monitor may overheat if the stand is removed. This may cause fire or damage. Operating the monitor on its back, side, upside down or on a carpet or any other soft material may also cause damage.

DISCONNECT THE CABLES WHEN YOU MOVE THE MONITOR

When you move the monitor, turn off the power switch, unplug the monitor and be sure the signal cable is disconnected. If you do not disconnect them, it may cause fire or electric shock.

UNPLUG THE MONITOR

If the monitor is not in use for a long period of time it is recommended that it is left unplugged to avoid accidents.

HOLD THE PLUG WHEN DISCONNECTING

To disconnect the power cable or signal cable, always pull it by the plug. Never pull on the cable itself as this may cause fire or electric shock.

DO NOT TOUCH THE PLUG WITH WET HANDS

Pulling or inserting the plug with wet hands may cause electric shock.

WHEN YOU INSTALL THE MONITOR ON YOUR COMPUTER

Be sure the computer is strong enough to hold the weight of the monitor, otherwise, you may damage your computer.

REMARK FOR 24/7 USAGE

This product is not specifically designed for 24/7 usage in all environments.

OTHERS

ERGONOMIC RECOMMENDATIONS

To eliminate eye fatigue, do not operate the monitor against a bright background or in a dark room. For optimal viewing comfort, the monitor should be just below eye level and 40-60 cm (16-24 inches) away from your eyes. When using the monitor over a prolonged time, a ten minute break every hour is recommended as looking at the screen continuously can cause eye strain.

SPECIAL NOTES ON LCD MONITORS

The following symptoms are normal with LCD monitors and do not indicate a problem.

NOTE

- When you first turn on the LCD monitor, the picture may not fit in the display area because of the type of computer that is used. In this case, adjust the picture position to the correct position.
- You may find slightly uneven brightness on the screen depending on the desktop pattern you use.
- Due to the nature of the LCD screen, an afterimage of the previous screen may remain after switching the image, when the same image is displayed for hours. In this case, the screen is recovered slowly by changing the image or turning off the Power Switch for hours.
- Max. non-stop operating time and conditions
 - (1) If a static image is displayed continuously, it is recommended to disrupt it with a motion picture.
 - (2) It is recommended to periodically change the background colour and background image.
 - (3) Do not exceed a 12 hour non-stop operating time limit.
 - (4) If the screen is active for a longer period of time, it is recommended to
 - I. Run the screensaver (motion picture or black pattern)
 - II. Power off the system for a while
 - (5) Make sure that the screen is suitably ventilated, or is used in conjunction with climate control system if installed into any bespoke cabinets.
 - (6) We strongly recommend an active cooling system with fans for long operating times, especially for high luminance LCD models.
- This LCD cannot be used outdoors.
- This LCD cannot be used with the screen facing upwards.

CUSTOMER SERVICE

NOTE

- If you have to return your unit for service and the original packaging has been discarded, please contact your dealer or iiyama service center for advice or replacement packaging.

CLEANING

WARNING

- If you drop any materials or liquids such as water into the monitor when cleaning, unplug the power cable immediately and contact your dealer or iiyama service center.

CAUTION

- For safety reasons, turn off the power switch and unplug the monitor before you clean it.

NOTE

- To protect the LCD panel, do not scratch or rub the screen with a hard object.
- Never use any of the following strong solvents. These will damage the cabinet and the LCD screen.

Thinner	Benzine	Abrasive cleaner
Spray-type cleaner	Wax	Acid or Alkaline solvent

- Touching the cabinet with any product made from rubber or plastic for a long time may cause degeneration or loss of paint on the cabinet.

CABINET

Stains can be removed with a cloth lightly moistened with a mild detergent solvent. Then wipe the cabinet with a soft dry cloth.

LCD SCREEN

Periodic cleaning with a soft dry cloth is recommended.

Don't use tissue paper etc. because these will damage the LCD screen.

BEFORE YOU OPERATE THE MONITOR

FEATURES

- ◆ Supports Resolutions up to 3840 × 2160
- ◆ High Contrast 5000:1 (Typical) / Brightness 350cd/m² (Typical) / Response Time : 3ms (Gray to Gray)
- ◆ Blue Light Reducer
- ◆ Digital Character Smoothing
- ◆ Automatic Set-up
- ◆ Stereo Speakers
2 × 6W Stereo Speakers
- ◆ Plug & Play VESA DDC2B Compliant
Windows® Vista/7/8/8.1/10 Compliant
- ◆ Power Management (ENERGY STAR® VESA DPMS Compliant)
- ◆ VESA Mounting Standard (200mm×400mm) Compliant
- ◆ Fanless design
- ◆ Headphone hook

CHECKING THE CONTENTS OF THE PACKAGE

The following accessories are included in your package. Check to see if they are enclosed with the monitor. If anything is missing or damaged, please contact your local iiyama dealer or regional iiyama office.

- | | | |
|-----------------------|---------------------|---------------------------------|
| ■ Power Cable (2pcs)* | ■ HDMI Cable | ■ mDP-DP Cable |
| ■ DisplayPort Cable | ■ RS232C Cable | ■ USB Cable |
| ■ Audio Cable | ■ Stand Base (2pcs) | ■ Screw for stand fixing (2pcs) |
| ■ Remote Control | ■ Safety Guide | ■ Quick Start Guide |

CAUTION * The rating of the Power Cable enclosed in 120V area is 10A/125V. If you are using a power supply higher than this rating, then a power cable with a rating of 10A/250V must be used. However, all guarantees and warranties are void for any problems or damage caused by a power cable not supplied by iiyama.

UNPACKING

CAUTION

Moving the monitor requires at least two people. If not, it may drop and could result in a serious injury.

FITTING AND REMOVAL OF BASE

- CAUTION**
- Put the monitor on a stable surface. The monitor may cause injury or damage if it falls or is dropped.
 - Do not give a strong impact to the monitor. It may cause damage.
 - Unplug the monitor before removal or installation to avoid electric shock or damage.

<Installation>

- ① Put a piece of soft cloth on the table beforehand to prevent the monitor from being scratched.
Lay the monitor flat on a table with front face down.
- ② Hold the monitor and push the Stand-Base.
- ③ Use 'thumb screw' provided to secure base to monitor column.

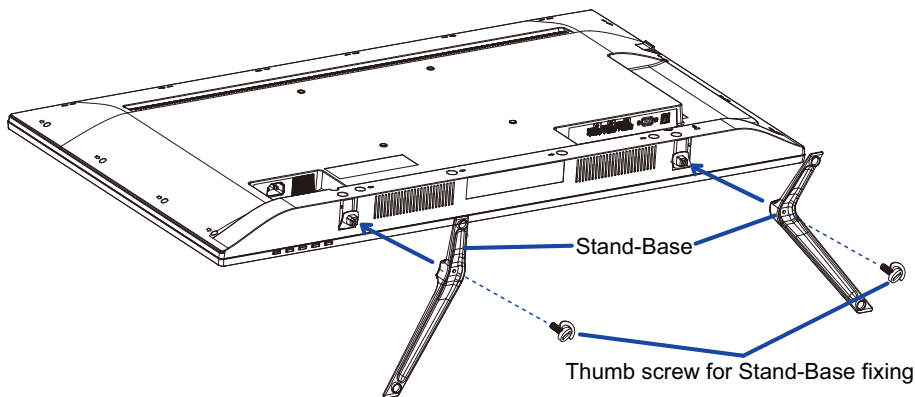

<Removal>

- ① Put a piece of soft cloth on the table beforehand to prevent the monitor from being scratched.
Lay the monitor flat on a table with front face down.
- ② Remove 'thumb screw' to remove base from monitor column.

CONTROLS AND CONNECTORS : MONITOR

<Front>

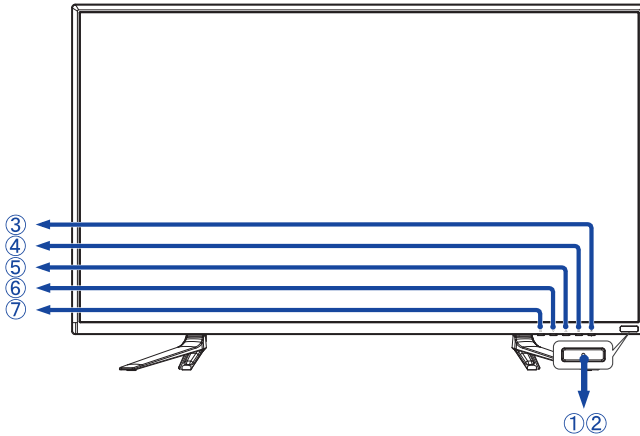

①	Power Indicator	Blue	Normal Operation
		Orange	Power Management
②	Remote Sensor		Remote Sensor
③	⏻		Power Button
④	②		Input / Select Button
⑤	▲		Up Button
⑥	▼		Down Button
⑦	①		Menu Button

<Back>

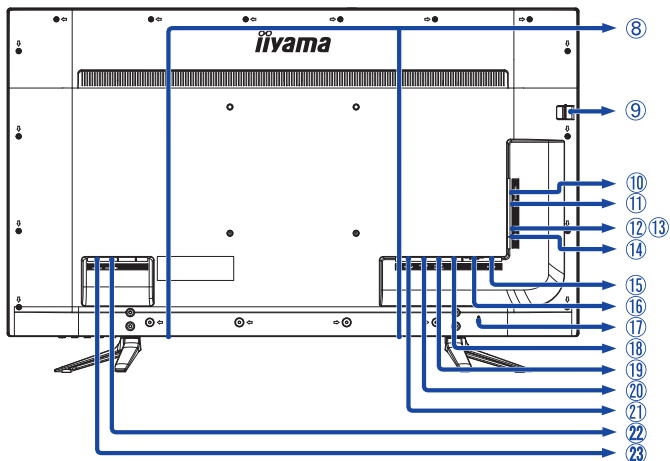

⑧	SPEAKERS		Speakers
⑨	HEADPHONE HOOK		Headphone hook
⑩	EARPHONE	Mini Jack	Headphone connector
⑪	AUDIO IN (PC Audio In)	Mini Jack	Audio Connector
⑫	USB	USB Downstream	USB Downstream Connector
⑬	USB	USB Downstream	USB Downstream Connector
⑭	RS232C	Mini Jack	RS232C Connector
⑮	PC USB	USB Upstream	USB Upstream Connector
⑯	VGA	D-SUB mini 15pin	VGA(D-sub) mini 15pin Connector
⑰	KEYHOLE FOR SECURITY LOCK		Keyhole for Security Lock
⑱	DP	DisplayPort	DisplayPort Connector
⑲	HDMI-1 (4K 60p)	HDMI	HDMI Connector
⑳	HDMI-2/MHL	HDMI/MHL	HDMI/MHL Connector
㉑	HDMI-3	HDMI	HDMI Connector
㉒	AC POWER IN	AC-INLET	AC Connector(~ : Alternating current) (AC POWER IN)
㉓	AC SWITCH (ON) / ○ (OFF)	MAIN POWER	Main Power Switch

INSTALLATION

CAUTION

- Follow the manual instructions for the type of mount you have selected. Refer all servicing to qualified service personnel.
- Moving the monitor requires at least two people.
- Before installing, please make sure the wall is strong enough to hold the necessary weight of the display and the mount.

[WALL MOUNTING]

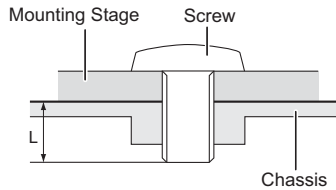

CAUTION

When using the wall mounting, consideration of thickness of the mounting stage needs to be taken. Tighten the M6 Screw with washer which “L” length is 10mm to fasten the monitor. Using a screw longer than this may cause electric shock or damage because it may contact with the electrical parts inside the monitor.

[ROTATING THE DISPLAY]

It is designed to be compatible in landscape mode.

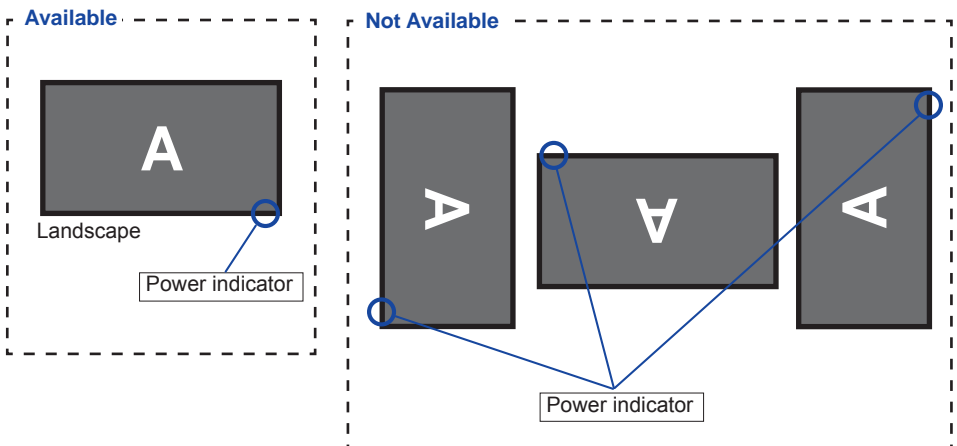

CONTROLS AND CONNECTORS : REMOTE CONTROL

ENGLISH

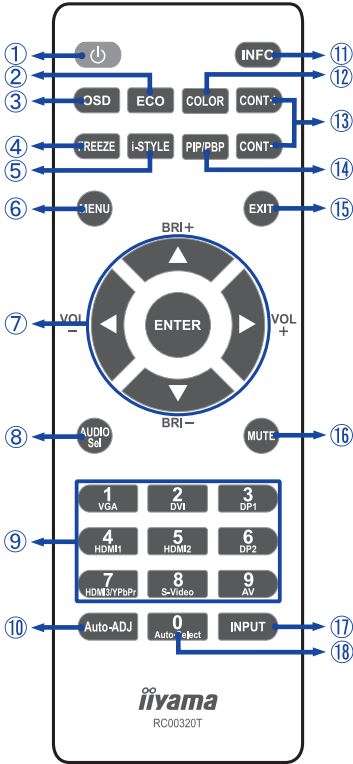

①		Turns the monitor ON and OFF.
②	ECO	Display the ECO mode menu.
③	OSD	Display the OSD menu.
④	FREEZE	Freeze the picture.
⑤	i-STYLE	Display the i-Style Color menu.
⑥	MENU	Opens the monitor's on-screen menu systems. When the menu system is already open, pressing this button will select the previous submenu.
⑦		Navigates through settings. ▲: Up Button ▼: Down Button ◀: - Button ▶: + Button ▲ (BRI+): Turn up the brightness. ▼ (BRI-): Turn down the brightness. ◀ (VOL-): Decreases the sound volume. ▶ (VOL+): Increases the sound volume.
	ENTER	Decision Button
⑧	AUDIO Sel	Display the AUDIO select menu.
⑨	Number (1-9) / Input source	Serve as input source buttons when the Menu is not displayed. The DP2, DVI, S-Video and AV are not available with this monitor.
⑩	Auto-ADJ	Adjust the Auto Adjustment.
⑪	INFO	Provides source and resolution information.
⑫	COLOR	Display the Color Setting menu.
⑬	CONT + / CONT -	CONT + : Turn up the Contrast. CONT - : Turn down the Contrast.
⑭	PIP/PBP	Display the PIP/PBP menu.
⑮	EXIT	Returns to a previous menu or closes the OSD Menu.
⑯	MUTE	Turns on or off the mute function when the Menu is not displayed.
⑰	INPUT	Display the Input Select menu.
⑱	Number (0) / Auto-Select	Search for an available input source and select automatically.

PREPARING THE REMOTE CONTROL

To use the remote control, insert the two dry batteries.

CAUTION

Do not use any other batteries other than those specified in this manual for the Remote Control. Do not insert old and new batteries together in the Remote Control. Make sure that the terminals match the "+" and "-" indications in the battery compartment. Burst batteries or the electrolyte from these batteries may cause stains, fire or injury.

- ① Slide back and remove the battery cover in the direction of the arrow.

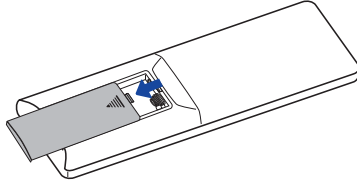

- ② Align and insert two AAA batteries according to their plus and minus ports (as indicated in the remote control).

Battery x 2 (Not included)

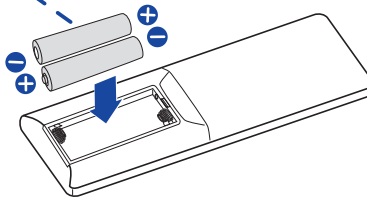

- ③ Replace the battery cover in the direction of the arrow and snap it back into place.

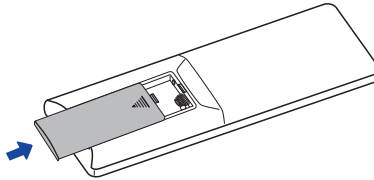

NOTE

- Replace with new batteries when the Remote Control does not work close to the monitor. Use AAA dry batteries.
- Operate the Remote Control by pointing it toward the Remote Sensor on the monitor.
- Other manufacturers remote control will not work with this monitor. Use the provided Remote Control ONLY.
- Used batteries needed to follow the local rules to be discarded. (Suggestion: to dispose of used batteries please follow correct policy as per your local regulations.)

BASIC OPERATION

■ Turning the monitor ON

The monitor is on and the Power Indicator turns Blue when you press the Power Button on the monitor or the Remote Control. The monitor is off and the Power Indicator turns Orange when you press the Power Button on the monitor or the Remote Control. Press again to turn the monitor on.

NOTE

Even when using the power management mode or turning OFF the Power Switch, the monitor will consume a small amount of electricity. Disconnect the Power Cable from the power supply whenever the monitor is not in use or during the night, to avoid unnecessary power consumption.

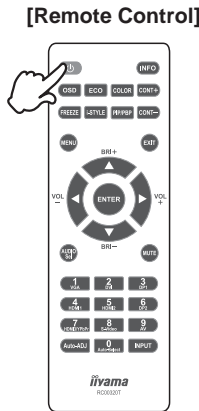
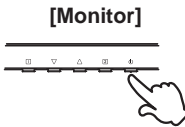

■ Display the adjustment menu page

The menu page appears on the screen when you press the ① Button on the monitor or the MENU Button on the Remote Control.

The menu page disappears when you press the ① Button on the Monitor or EXIT Button on the Remote Control.

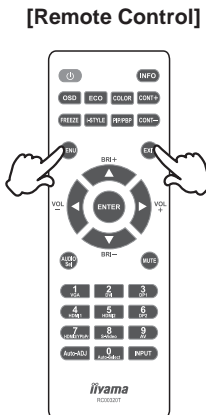
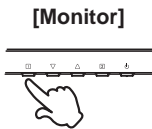

■ **Move the cursor vertically**

Select adjustment by pressing the ▲ / ▼ Button on the monitor or the Remote Control while the menu page is displayed on the screen.

[Monitor]

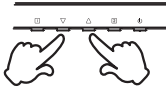

[Remote Control]

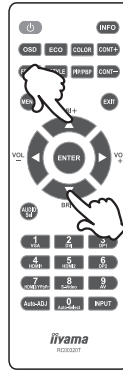

■ **Move the Adjustment bar**

Perform the adjustment by pressing the ◀ / ▶ Button on the Remote Control while the Adjustment bar of menu page is displayed on the screen.

[Remote Control]

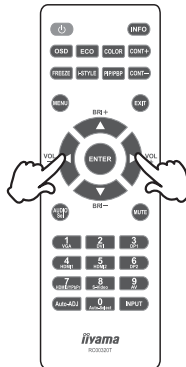

■ Adjust the volume of sound

Press the VOL ◀/▶ Button on the Remote Control to adjust the volume of sound when the menu page is not displayed on the screen.

[Remote Control]

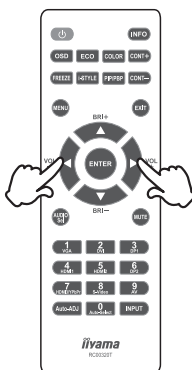

■ Switch the input signal

This is activated when you successively press the 2 Button on the monitor or INPUT Button on the Remote Control.

Even you can switch by pressing the Number Button (1-5,7) on the Remote Control.

[Monitor]

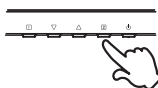

[Remote Control]

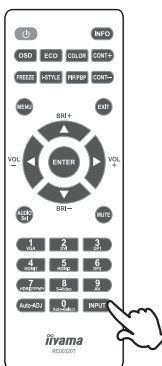

CONNECTING YOUR MONITOR

- ① Ensure that both the computer and the monitor are switched off.
- ② Connect the computer to the monitor with the signal cable.
- ③ Connect the monitor to the audio equipment with the Audio Cable for computer when using the audio features.
- ④ Connect the computer to the monitor with the USB Cable.
- ⑤ Connect the Power Cable to the monitor first and then to the power supply.
- ⑥ Turn on your monitor (Main Power Switch and Power Switch) and computer.

NOTE

- The signal cables used for connecting the computer and monitor may vary with the type of computer used. An incorrect connection may cause serious damage to both the monitor and the computer. The cable supplied with the monitor is for a standard connector. If a special cable is required please contact your local iiyama dealer or regional iiyama office.
- For connection to Macintosh computers, contact your local iiyama dealer or regional iiyama office for a suitable adaptor.
- Make sure you tighten the finger screws at each end of the Signal Cable.

[Example of Connection]

<Back>

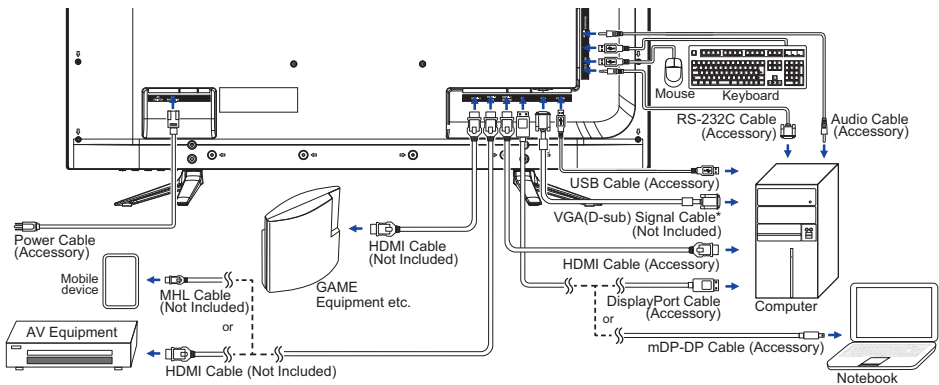

* VGA (D-Sub) cable is not supplied with the monitor; you need to use a special VGA (D-Sub) cable dedicated for this model. Please contact the iiyama Support Centre in your country if you wish to connect the monitor via the VGA input.

COMPUTER SETTING

- Signal Timing

Change to the desired signal timing listed on page 35: COMPLIANT TIMING.

- Procedure for turning ON the Power Switch

Turn ON the monitor first, and then the computer.

OPERATING THE MONITOR

The Auto Pow. Off function is enabled as default setting. Monitor will turn off automatically after 3 hours without any key operation.
If you prefer to use the monitor over 3 hours continuously, please disable The Auto Pow. Off function.

To create the best picture, your iiyama LCD monitor has been preset at the factory with the COMPLIANT TIMING shown on page 35. You are also able to adjust the picture by following the button operation shown below. For more detailed adjustments, see page 27 for SCREEN ADJUSTMENTS.

- 1 Press the **1** Button on the Monitor or the **MENU** Button on the Remote Control to start the On Screen Display (OSD) feature. There are additional Menu items which can be switched by using the **▲ / ▼** Buttons.

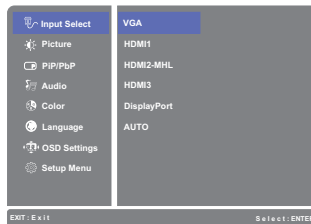

- 2 Select the Menu item which contains the adjustment icon relating to the adjustment you want to make. Press the **2** Button on the Monitor or the **ENTER** Button on the Remote Control. Then, use the **▲ / ▼** Buttons to highlight the desired adjustment icon.
- 3 Press the **2** Button on the Monitor or the **ENTER** Button on the Remote Control again. Use the **▲ / ▼** Buttons to make the appropriate adjustment or setting.
- 4 Press the **1** Button on the Monitor or the **EXIT** Button on the Remote Control to leave the menu, and the settings you just made would be automatically saved.

For example, to correct for vertical position, select Menu item of **Setup Menu** and then press the **2** Button on the Monitor or the **ENTER** Button on the Remote Control. Then, select **Geometry** by using the **▲ / ▼** Buttons and press the **2** Button on the Monitor or the **ENTER** Button on the Remote Control. Then, select **V. Position** by using the **▲ / ▼** Buttons.

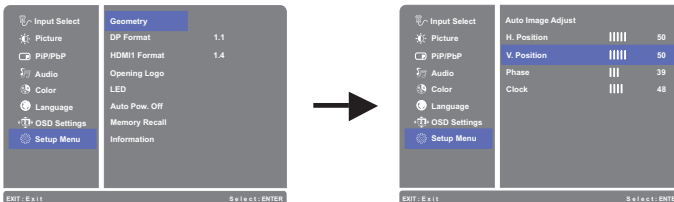

An adjustment page appears after you press the **2** Button on the Monitor or the **ENTER** Button on the Remote Control. Then, use the **▲ / ▼** Buttons to change the vertical position settings. The vertical position should be changing accordingly while you are doing this.



Press the **1** Button on the Monitor or the **EXIT** Button on the Remote Control lastly, it ends, all changes are saved in the memory.

NOTE

- When button operations are aborted during adjustment, On-Screen Display disappears when the time set for the OSD Time Out has passed. Also, the (1) Button on the Monitor or the EXIT Button on the Remote Control can be used to return previous menu and turn off the On-Screen Display.
- Any changes are automatically saved in the memory when the On Screen Display disappears. Turning off the power should be avoided while using the Menu.
- Adjustments for Image H./V.Position, Clock and Phase are saved for each signal timing. Except for these adjustments, all other adjustments have only one setting which applies to all signal timings.

■ Disabled function matrix

		After enabled function						
		Adv. Contrast	ECO Mode	i-Style Color	Blue Light Reducer	Brightness	Contrast	Overdrive
Function enabled	Adv. Contrast	—	×	○	×	×	○	○
	ECO Mode	×	—	○	×	×	○	○
	i-Style Color	×	×	—	×	×	×	×
	Blue Light Reducer	×	×	×	—	○	○	○

○ : adjustable

× : disabled

ADJUSTMENT MENU CONTENTS



Input Select

Direct

Adjustment Item	Problem / Option	Button to Press
Input Select	VGA	Select the VGA input.
	HDMI1	Select the HDMI1 input.
	HDMI2-MHL	Select the HDMI2-MHL input.
	HDMI3	Select the HDMI3 input.
	DisplayPort	Select the DisplayPort input.
	AUTO	Search for an available input source and select automatically.

















NOTE However it will automatically be selected when just one source is using. In Power Management Mode input switching is disabled. Input source is fixed, not selected automatically when VGA, HDMI1, HDMI2-MHL, HDMI3 and DisplayPort which are selected.

ENGLISH

Direct

You can skip the Menu items and display an adjustment scale directly by using the following button operations.

- Input Select: Press the **2** Button on the Monitor or INPUT on the Remote Control when the Menu is not displayed.

 Picture			
Adjustment Item	Problem / Option		Button to Press
Picture Format * ¹	Full Screen	Full screen display	
	Aspect Ratio * ²	Expansion display of Aspect	
	Dot By Dot	Display the picture dot by dot.	
Brightness * ^{3,4}	Too dark		
	Too bright		
Contrast * ⁴	Too dull		
	Too intense		
Sharpness	You can change the picture quality from 0 to 100 (soft to sharp). Press the  Button to change the picture quality in numerical order. Press the  Button to change the picture quality in reverse numerical order.		
			 
Overdrive * ^{1,4}	Off / -2 / -1 / 0 / +1 / +2 It will improve the gray level response time of the LCD panel. A higher level results in a faster response time.		
			 
Adv. Contrast * ^{1,4}	On	Increased Contrast Ratio	
	Off	Typical Contrast Ratio	
ECO Mode * ⁴	Off	Normal	
	1	Brightness of back-light is reduced.	
	2	Brightness of back-light is reduced more than 1.	
	3	Brightness of back-light is reduced more than 2.	
X-Res Technology	Off	Normal	
	Soft	Enhance the picture edge.	
	Middle	Enhance the picture edge more than the Soft option.	
	Hard	Enhance the picture edge more than the Middle option.	

*¹ Picture Format, Overdrive, Adv. Contrast are disabled when PiP/PbP Mode is activated.

*² Option unavailable with 16:9 resolution. When input video resolution is 4:3, 5:4 or 16:10, the image will be displayed in the center of the screen with 4:3 aspect ratio.

*³ Adjust the Brightness when you are using the monitor in a dark room and feel the screen is too bright.

*⁴ See page 18 for Disabled function matrix.



PiP/PbP

Adjustment Item	Problem / Option	Button to Press
PiP/PbP Mode *	Off	PiP/PbP Mode is turned off.
	PiP	Display the sub screen in the main screen.
	PbP	Divide display images in two
Sub Win Input	VGA	Select the VGA input.
	HDMI1	Select the HDMI1 input.
	HDMI2-MHL	Select the HDMI2-MHL input.
	HDMI3	Select the HDMI3 input.
PiP Size	DisplayPort	Select the DisplayPort input.
	Small	Reduce the size of the Sub screen.
	Middle	Normal size
PiP Position	Large	Increase the size of the Sub screen.
	Top-Right	Move the sub screen to the top right corner.
	Top-Left	Move the sub screen to the top left corner.
Swap	Bottom-Right	Move the sub screen to the bottom right corner.
	Bottom-Left	Move the sub screen to the bottom left corner.
Swap	Swaps the Main/Sub screens when PiP mode is active.	

* PiP = Picture In Picture

With this function, you can display two different pictures.

PbP = Picture By Picture

With this function, you can display max. four different pictures.

Audio Direct	
Adjustment Item	Problem / Option Button to Press
Volume	Too soft ▶ ▲ Too loud ▶ ▼
Mute Direct	On Turn off the sound temporarily. Off Return the sound volume to the previous level.
Audio Input *	Line-In Select the Line-In input.
	HDMI1 Select the HDMI1 input.
	HDMI2-MHL Select the HDMI2 input.
	HDMI3 Select the HDMI3 input.
	DisplayPort Select the DisplayPort input.

* Suitable for HDMI/DisplayPort input only.

Direct

You can skip the Menu items and display an adjustment scale directly by using the following button operations.

- Audio: Press the ▲ Button when the Menu is not displayed.
- Mute: Pressing and holding of the ▲ Button for about 2 seconds when the Menu is not displayed.
Mute and Unmute are switched as follows by pressing the ▲ Button successively.



Color *1

Adjustment Item	Problem / Option		Button to Press
Warm	Reddish white		
Normal	Greenish white		
Cool	Bluish white		
User Color	Red	Too weak	
	Green		
	Blue	Too strong	
i-Style Color Direct	Standard	For general windows environment and monitor default setting.	
	Scenery	For displaying outdoor scenery images	
	Cinema	For movie and video environment.	
	Game	For PC game environment.	
	Text	For text editing and viewing in a word processing environment.	
	Off	Return to a state set by color adjustment except i-Style Color.	
Blue Light Reducer *2 Direct	Off	Typical	
	1	Blue light is reduced.	
	2	Blue light is reduced more than Mode1.	
	3	Blue light is reduced more than Mode2.	

*1 Functions other than Blue Light Reducer is disabled when Blue Light Reducer is activated.

















*2 See page 18 for Disabled function matrix.

Direct

You can skip the Menu items and display an adjustment scale directly by using the following button operations.

- i-Style Color : Press the ▼ Button when the Menu is not displayed.
- Blue Light Reducer: Pressing and holding of the Button on the Monitor for about 2 seconds when the Menu is not displayed.

 Language				
Adjustment Item	Problem / Option			Button to Press
Language	English	English	Italiano	Italian
	Français	French	Русский	Russian
	Deutsch	German	日本語	Japanese
	Nederlands	Dutch	简体中文	Simplified Chinese
	Polski	Polish	繁體中文	Traditional Chinese
	Česky	Czech		

 OSD Settings		
Adjustment Item	Problem / Option	Button to Press
OSD H. Position	OSD is too left OSD is too right	   
OSD V. Position	OSD is too low OSD is too high	   
OSD Background	The background of OSD is mode transparent. Off / 1 / 2 / 3 / 4	   
OSD Time Out	You can set the OSD display duration time. 5 / 10 / 20 / 30 / 60 seconds	   



Setup Menu

Adjustment Item	Problem / Option		Button to Press
Geometry *1	Auto Image Adjust *2 Direct		Adjust H. / V. Position, Clock and Phase automatically.
	H. Position *3	Too left	
		Too right	
	V. Position *3	Too low	
		Too high	
Phase	To correct flickering text or lines		
Clock	Too narrow		
	Too wide		
DP Format *4	1.1	Standard	
	1.2	To be used when displaying 3840x2160 60Hz.	
HDMI1 Format *5	1.4	Standard	
	2.0	To be used when displaying 3840x2160 60Hz.	
Opening Logo	On	iiyama Logo displayed when the monitor is turned on.	
	Off	iiyama Logo does not display when the monitor is turned on.	
LED	On	The Power Indicator is turned On.	
	Off	The Power Indicator is turned Off.	
NOTE Turn Off the Power Indicator when you are bothered by the light.			
Auto Pow. Off	On	Enable the Auto Pow. Off function.	
	Off	Auto Pow. Off function is turned Off.	
NOTE The Auto Pow. Off function is enabled as default setting. Monitor will turn off automatically after 3 hours without any key operation. If you prefer to use the monitor over 3 hours continuously, please disable The Auto Pow. Off function.			
Memory Recall	Yes	Factory-preset data is restored.	
	No	Return to Menu.	
Information	Displays information regarding the current input signal coming from the graphic card in your computer. <Example>		NOTE See your graphic card user guide for more information about changing the resolution and refresh.

*¹ Only Analog Input.

*² For best results, use the Auto Image Adjust in conjunction with the adjustment pattern. See page 27 for SCREEN ADJUSTMENTS.

*³ See page 27 for SCREEN ADJUSTMENTS.

*⁴ To display 3840 x 2160 at 60Hz, the DisplayPort setting must be enabled as 1.2, and the source graphic card must be capable of supporting 3840 x 2160 resolution at 60Hz.

*⁵ Only HDMI1 can support 3840 x 2160 60Hz.

To display 3840 x 2160 at 60Hz, the HDMI1 setting must be enabled as 2.0, and the source graphic card must be capable of supporting 3840 x 2160 resolution at 60Hz.

Direct

You can skip the Menu items and display an adjustment scale directly by using the following button operations.

- Auto Image Adjust: Pressing and holding of the ▼ Button for about 2 seconds when the Menu is not displayed.
- FREEZE : Press the FREEZE Button on the Remote Control when the Menu is not displayed.
On: Freeze the picture.
Off: Return to Normal.

SCREEN ADJUSTMENTS

Adjust the image by following the procedure below to get the desired picture when selecting Analog input.

- The screen adjustments described in this manual are designed to set image position and minimize flicker or blur for the particular computer in use.
- The monitor is designed to provide the best performance at resolution of 3840 × 2160, but can not provide the best at resolutions of less than 3840 × 2160 because the picture is automatically stretched to fit the full screen. It is recommended to operate at resolution of 3840 × 2160 in normal use.
- Displayed text or lines will be blurred or irregular in thickness when the picture is stretched due to the screen enlargement process.
- It is preferable to adjust the image position and frequency with the monitor controls, rather than the computer software or utilities.
- Perform adjustments after a warm-up period of at least thirty minutes.
- Additional adjustments may be required after the Auto Adjust depending on the resolution or signal timing.
- The Auto Adjust may not work correctly when displaying the picture other than the screen adjustment pattern. In this case, manual adjustments are required.

There are two ways to adjust the screen. One way is automatic adjustment for Position, Clock and Phase. The other way is performing each adjustment manually.

Perform the Auto Adjust first when the monitor is connected to a new computer, or resolution is changed. If the screen has a flicker or blur, or the picture does not fit in the display area after performing the Auto Adjust, manual adjustments are required. Both adjustments should be made by using the screen adjustment pattern (Test.bmp) obtained via the Iiyama web site (<http://www.iiyama.com>).

Adjust the image by following the procedure below to get the desired picture.

This manual explains adjustment under Windows® OS.

- ① **Display the picture at the optimum resolution.**
- ② **Enter the Test.bmp (screen adjustment pattern) to wallpaper.**

NOTE

- Consult the appropriate documentation for doing this.
- Test.bmp is made at resolution of 1280 × 1024. Set the display position to center in the wallpaper setting dialogue box. If you use Microsoft® PLUS! 95/98 cancel the setting of "Stretch desktop wallpaper to fit the screen".

[Adjustment pattern]

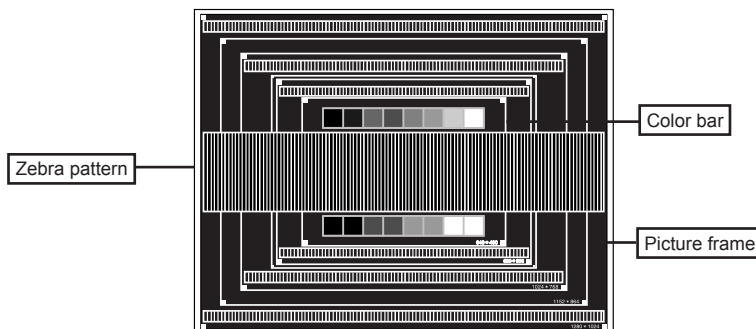

- ③ Adjust the Auto Adjustment.
- ④ Adjust the image manually by following procedure below when the screen has a flicker or blur, or the picture does not fit in the display area after performing the Auto Adjust.
- ⑤ Adjust the V-Position so that the top and bottom of the picture frame will fit to the display area.

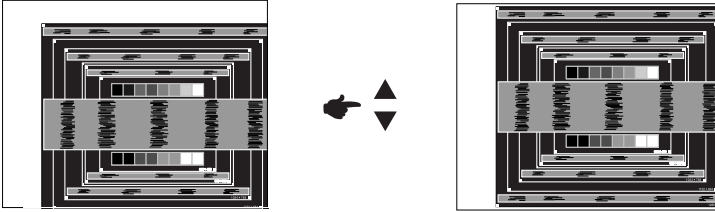

- ⑥ 1) Adjust the H-Position so that the left side of the picture frame will move to the left edge of the display area.

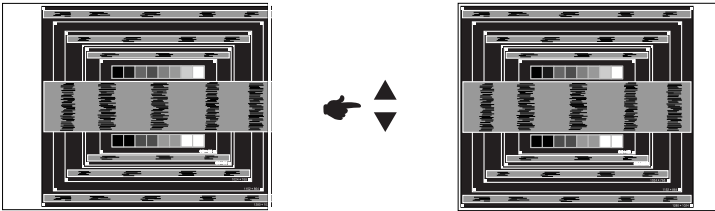

- 2) Stretch the right side of the picture frame to the right edge of the display area by adjusting the Clock.

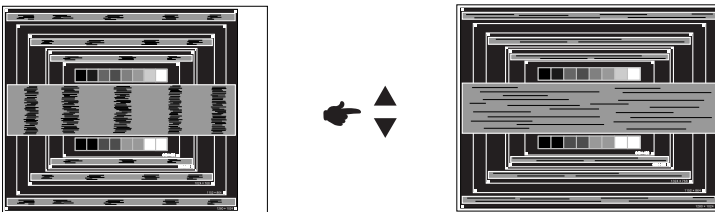
**NOTE**

- When the left side of the picture frame moves apart from the left edge of the display area during the Clock adjustment, adjust steps 1) and 2).
- Another way to make the Clock adjustment is to correct the vertical wavy lines in the zebra pattern.
- The picture may flicker during the Clock, H/V-Position adjustment.
- In case the picture frame is bigger or smaller than the data display area after the Clock adjustment, repeat steps from ③.

⑦ Adjust the Phase to correct horizontal wavy noise, flicker or blur in the zebra pattern.

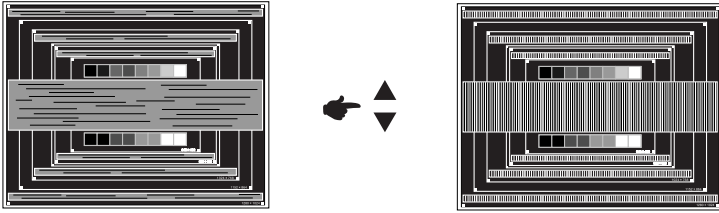

NOTE

- In case the strong flicker or blurs remain on a part of the screen, repeat steps ⑥ and ⑦ because the Clock may not be adjusted correctly. If the flicker or blurs still remain, set the refresh rate of computer to low (60Hz) and repeat steps from ③ again.
- Adjust the H-Position after the Phase adjustment if the horizontal position moves during the adjustment.

⑧ Adjust the Brightness and Color to get the desired picture after you complete the Clock and Phase adjustments.

Put back your favorite wallpaper.

POWER MANAGEMENT FEATURE

The power management feature of this product complies with power saving requirement of ENERGY STAR® and VESA DPMS. When activated, it automatically reduces unnecessary power consumption of the monitor when your computer is not in use.

To use the feature, the monitor needs to be connected to a VESA DPMS compliant computer. There is a power management step the monitor takes as described below. The power management function, including any timer settings is configured by the operating system. Check your operating system manual for information on how this can be configured.

■ Power Management Mode

When the H-sync signal / V-sync signal / H and V sync signals from the computer are off, the monitor enters into Power Management Mode which reduces the power consumption to less than 0.5W. The screen becomes dark, and the power indicator turns to orange. From Power Management Mode, the image reappears in several seconds when either the keyboard or the mouse are touched again.

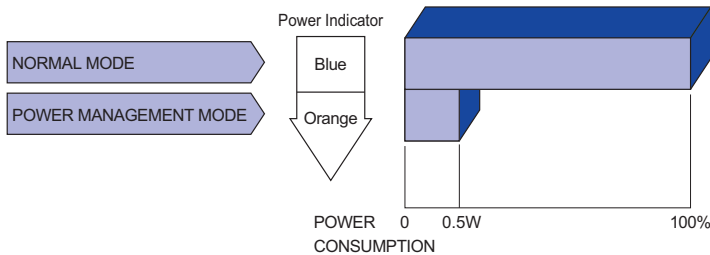

* USB peripherals and Audio equipment are not connected.

NOTE

- Even when using the power management mode, the monitor consumes electricity. Turn off the Power Switch whenever the monitor is not in use, during the night and weekends, to avoid unnecessary power consumption.
- It is possible that the video signal from the computer may be on while the H or V sync signal is missing. In this instance, the POWER MANAGEMENT feature may not work properly.

TROUBLE SHOOTING

If the monitor fails to operate correctly, please follow the steps below for a possible solution.

1. Perform the adjustments described in OPERATING THE MONITOR, depending on the problem you have. If the monitor does not get a picture, skip to 2.
2. Consult the following items if you cannot find an appropriate adjustment item in OPERATING THE MONITOR or if the problem persists.
3. If you are experiencing a problem which is not described below or you cannot correct the problem, discontinue using the monitor and contact your dealer or iiyama service center for further assistance.

Problem	Check
① The picture does not appear.	<input type="checkbox"/> The Power Cable is firmly seated in the socket. <input type="checkbox"/> The Power Switch is turned ON. <input type="checkbox"/> The AC socket is live. Please check with another piece of equipment. <input type="checkbox"/> If the blank screen saver is in active mode, touch the keyboard or the mouse. <input type="checkbox"/> Increase the Contrast and/or Brightness. <input type="checkbox"/> The computer is ON. <input type="checkbox"/> The Signal Cable is properly connected. <input type="checkbox"/> The signal timing of the computer is within the specification of the monitor. <input type="checkbox"/> If the monitor is in power management mode, touch the keyboard or the mouse.
② The screen is not synchronized.	<input type="checkbox"/> The Signal Cable is properly connected. <input type="checkbox"/> The signal timing of the computer is within the specification of the monitor. <input type="checkbox"/> The video output level of the computer is within the specification of the monitor.
③ The screen position is not in the center.	<input type="checkbox"/> The signal timing of the computer is within the specification of the monitor.
④ The screen is too bright or too dark.	<input type="checkbox"/> The video output level of the computer is within the specification of the monitor.
⑤ The screen is shaking.	<input type="checkbox"/> The power voltage is within the specification of the monitor. <input type="checkbox"/> The signal timing of the computer is within the specification of the monitor.
⑥ No sound.	<input type="checkbox"/> The audio equipment (computer etc.) is ON. <input type="checkbox"/> The Audio Cable is properly connected. <input type="checkbox"/> The Volume is turned up. <input type="checkbox"/> The Mute is OFF. <input type="checkbox"/> The audio output level of the audio equipment is within the specification of the monitor.
⑦ The sound is too loud or too quiet.	<input type="checkbox"/> The audio output level of the audio equipment is within the specification of the monitor.
⑧ A strange noise is heard.	<input type="checkbox"/> The Audio Cable is properly connected.

RECYCLING INFORMATION

For better environment protection please don't dispose your monitor.
Please visit our web site: www.iiyama.com/recycle for monitor recycling.

APPENDIX

Design and specifications are subject to change without prior notice.

SPECIFICATIONS

Size Category	40"	
LCD Panel	Panel technology	MVA
	Size	Diagonal: 39.5" (100.3cm)
	Pixel pitch	0.229mm H × 0.225mm V
	Brightness	350cd/m ² (Typical)
	Contrast ratio	5000 : 1 (Typical)
	Viewable angle	Right/Left/Up/Down: 89 degrees each (Typical)
	Response time	3ms (Gray to Gray)
Display Colors	Approx. 1.07G	
Sync Frequency	VGA: Horizontal: 30.0-80.0kHz, Vertical: 55-75Hz HDMI1: Horizontal: 30.0-135.0kHz, Vertical: 24-30,55-75Hz HDMI2/MHL: Horizontal: 30.0-90.0kHz, Vertical: 24-30,55-75Hz HDMI3: Horizontal: 30.0-90.0kHz, Vertical: 24-30,55-75Hz DisplayPort: Horizontal: 30.0-135.0kHz, Vertical: 24-30,55-75Hz	
Native Resolution	3840 × 2160, 8.3 MegaPixels	
Supported max. resolution	VGA: 2048 × 1152 60Hz HDMI1: 3840 × 2160 60Hz HDMI2/MHL: 3840 × 2160 30Hz, 2560 × 1440 60Hz, 1920 × 2160 60Hz(HDMI), 1920 × 1080 60Hz(MHL) HDMI3: 3840 × 2160 30Hz, 2560 × 1440 60Hz, 1920 × 2160 60Hz DisplayPort: 3840 × 2160 60Hz	
Input Connector	VGA(D-sub) mini 15 pin, HDMIx3, DisplayPort	
Serial Port	RS-232C	
Plug & Play	VESA DDC2B™	
Input Sync Signal	Separate sync: TTL, Positive or Negative	
Input Video Signal	Analog: 0.7Vp-p (Standard), 75Ω, Positive Digital: HDMI, HDMI (MHL compliance)* ¹ , DisplayPort	
USB Standard	USB3.0	
Number of USB Ports	1 Upstream : Series B	
Connector shape	2 Downstream : Series A	
Input Audio Connector	ø 3.5mm mini jack (Stereo)	
Input Audio Signal	1.0Vrms maximum	
Headphone Connector	ø 3.5mm mini jack (Stereo)	
Speakers	6W×2 (Stereo speakers)	
Maximum Screen Size	878.11mm W × 485.35mm H / 34.6" W × 19.1"	
Power Source	100-240VAC, 50/60Hz, 1.3A	
Power Consumption* ²	60W typical Energy Efficiency Class: B	
Dimensions / Net Weight	906.5 × 577.0 × 238.5mm / 35.7 × 22.7 × 9.4" (W×H×D) 12.2kg / 26.9lbs	

Environmental Considerations	Operating: Temperature	5 to 35°C / 41 to 95°F
	Humidity	10 to 80% (No condensation)
Approvals	Storage: Temperature	-20 to 60°C / -4 to 140°F
	Humidity	5 to 85% (No condensation)

- NOTE** *¹ Only HDMI2 input.
 *² USB, MHL and Audio equipment are not connected.

DIMENSIONS

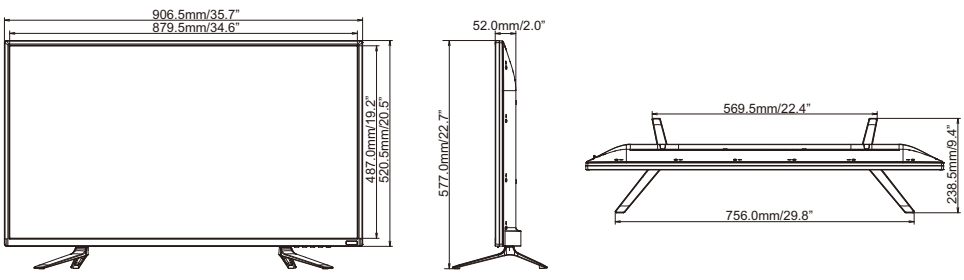

* Protruding portion(s) not included.

COMPLIANT TIMING

Video Mode		Horizontal Frequency	Vertical Frequency	Dot Clock
VESA	VGA 640 × 480	31.469kHz	59.940Hz	25.175MHz
		37.500kHz	75.000Hz	31.500MHz
		37.861kHz	72.809Hz	31.500MHz
	SVGA 800 × 600	35.156kHz	56.250Hz	36.000MHz
		37.879kHz	60.317Hz	40.000MHz
		46.875kHz	75.000Hz	49.500MHz
	XGA 1024 × 768	48.363kHz	60.004Hz	65.000MHz
		56.476kHz	70.069Hz	75.000MHz
		60.023kHz	75.029Hz	78.750MHz
	SXGA 1280 × 1024	63.981kHz	60.020Hz	108.000MHz
		79.976kHz	75.025Hz	135.000MHz
	WXGA+ 1440 × 900	55.935kHz	59.887Hz	106.500MHz
		70.635kHz	74.984Hz	136.750MHz
	WSXGA+ 1680 × 1050	65.290kHz	60.000Hz	146.250MHz
	Full HD 1920 × 1080	66.590kHz	59.930Hz	138.500MHz
QWXGA 2048 × 1152	71.584kHz	60.000Hz	197.000MHz	
WQHD 2560 × 1440	88.787kHz	59.951Hz	241.500MHz	
UHD 3840 × 2160	67.430kHz	29.970Hz	296.700MHz	
	133.313kHz	59.997Hz	533.250MHz	
	1920 × 2160	135.000kHz	60.000Hz	297.000MHz

NOTE *¹ HDMI1, HDMI2, HDMI3 and DisplayPort input only.

*² HDMI1 and DisplayPort input only.

*³ Recommended to use on PbP mode.