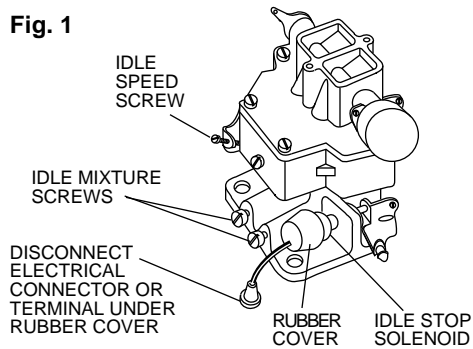
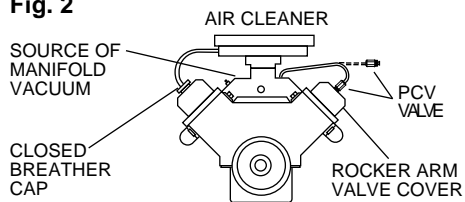

VACUUM GAUGE/ PRESSURE TESTER KIT INSTRUCTIONS

CRANKING VACUUM TESTS

Engine Condition Test

1. Start engine and allow it to warm to normal operating temperature. Stop engine. To prevent the engine from starting, disable the ignition system.
2. Remove the air filter. Back out the idle speed screw (see Figure 1) until the throttle valve is tightly closed. If the carburetor is also equipped with an idle air bleed screw, turn the screw clockwise until it bottoms lightly. In both cases, count the number of turns so the screws can be returned to their original positions after the tests.
3. If the vehicle is equipped with an idle stop solenoid (See Figure 1), disconnect the electrical wire at the base of the solenoid under the rubber boot or at the connector as shown.
4. If the engine is equipped with a PCV (Positive Crankcase Ventilation) system, remove the PCV valve at the engine rocker arm cover (see Fig-

Fig. 1**Fig. 2**

ure 2) and plug the valve on the bottom with tape or other suitable means.

5. Using the hose supplied, connect the Vacuum Gauge to a source of manifold vacuum. This may be a fitting on the carburetor below the throttle plate, or a fitting in the intake manifold. See Figures 2 and 9.

6. Crank the engine and note Vacuum Gauge reading.

(After testing, return adjustment screws to their original positions.)

Test Results

The general condition of an engine is indicated by one of three possible gauge readings:

- A.** (Figure 3) A reasonably steady vacuum reading of 4 inches or more on emission controlled engines, and 10 inches or more on non-emission controlled engines (pre-1968) indicates correct engine vacuum. Readings may vary considerably on different engines, but should not fall below these minimums. (See manufacturer's specifications).

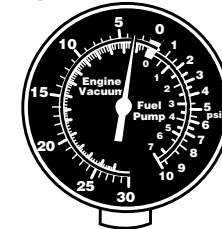
Fig. 3**Fig. 4**

- B.** (Figure 4) An excessively low, steady vacuum is caused by a condition which affects all cylinders equally.

Check for:

1. Leaking carburetor flange gasket.
2. Worn carburetor throttle shaft.
3. Leaking vacuum lines.
4. Improper valve timing.

5. Slow engine cranking due to:

- A. Battery
- B. Battery cable connections
- C. Defective starter motor
- D. Excessive mechanical drag in engine caused by:
 1. Tight fitting pistons in rebuilt engine.
 2. Thickened oil due to excessive oxidation.

- C.** (Figure 5) A reading which pulses unevenly indicates a leaky condition which affects one or more, but not all cylinders.

NOTE: A certain amount of even pulsing is normal, notably on 6 and 4 cylinder engines, and does not necessarily indicate a leaky condition.

Check for:

1. Burned or stuck valve.
2. Intake manifold leak at one cylinder.
3. Worn intake valve guide.
4. Broken piston or piston rings.

Fig. 5

RUNNING VACUUM TEST

Engine Condition Test

While performing a running vacuum test, it is possible to obtain a different gauge indication than that obtained under the cranking vacuum test.

1. Connect the vacuum gauge to a source of manifold vacuum. See Figures 2 and 9.
2. Run the engine at normal operating temperature and idle speed.

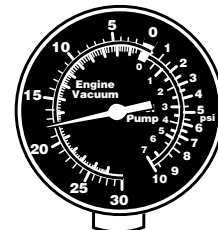
Fig. 6**Fig. 7**

Test Results

- A.** (Figure 6) A steady reading between 15 and 22 inches indicates a mechanically sound engine.

- B.** (Figure 7) A pointer which sweeps or wanders erratically through several inches indicates a malfunction affecting all cylinders unequally and inconsistently. To help isolate the troubled area, run the engine at about 2000 RPM. If the pointer steadies, check for:

1. Ignition and/or timing.
2. Carburetor mixture adjustment at idle.

If the sweep gets larger, check for weak or broken valve springs. If the sweep becomes shorter and more rapid, check for:

1. Carburetor or intake manifold leaks.
2. Sticky valves.

EXHAUST RESTRICTION TEST

With vacuum gauge connected to a source of manifold vacuum, increase engine speed to 2000 RPM, maintain this speed, and note the vacuum gauge reading. A gradually decreasing vacuum reading may indicate a restricted exhaust system.

(Partially blocked muffler or tailpipe.)

POSITIVE CRANKCASE VENTILATION (PCV) VALVE TEST

1. Unplug the PCV valve, plugged previously with a piece of tape (Step 4, Cranking Vacuum Tests) and crank engine.

A. If the PCV valve is operating properly, the vacuum will drop to about one-half the value noted in Step 6, Cranking Vacuum Tests.

B. A reading much lower than one-half indicates excessive flow which could upset the proper carburetor air/fuel ratio causing rough idling and burned valves.

C. No change in the vacuum indicates a clogged PCV valve.

2. Return the idle screw (and idle air bleed screw) to its original position. (See Step 2, Cranking Vacuum Tests).
3. Re-enable the ignition system.
4. Re-connect the wire to the idle stop solenoid.
5. Re-connect all hoses and vacuum lines.
6. Re-install the PCV valve in its proper location.

PCV SYSTEM TEST

1. Operate the engine at normal temperature and idle speed.
2. Remove the hose connected between the air cleaner and valve cover or oil filler/breather cap as shown in Figure 8. Plug the oil dipstick tube to prevent an air leak.

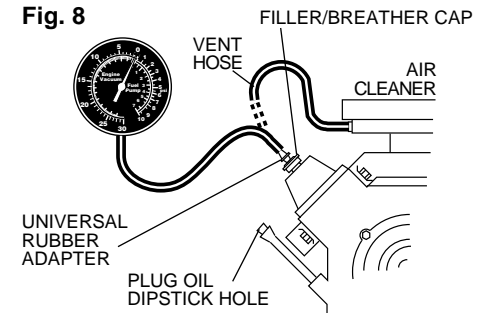
Fig. 8

3. Hold the vacuum gauge with rubber universal adaptor firmly over the valve cover hole or filler/breather cap opening.

A. A properly working PCV system will draw a vacuum of about 3 to 5 inches within 10 seconds.

B. If there is very little or no change in the gauge reading in the first 10 to 15 seconds of the test the PCV valve is clogged or frozen, or there is excessive air leakage in the vacuum hose between the intake manifold and PCV valve (or other leakage into the crankcase).

4. Repair or replace the defective parts as needed and reconnect hoses.

DISTRIBUTOR VACUUM ADVANCE MECHANISMS

The amount of spark ignition advance needed is determined by the intake manifold vacuum and engine speed.

The vacuum advance mechanism in the distributor is connected to the intake manifold or carburetor by a rubber hose. To measure the amount of vacuum at any RPM, disconnect the hose from the distributor and insert a "Tee" connector (Item 4, Figure 12) in line with this hose and another back to the distributor as shown in Figure 9. Also, connect the gauge to the "Tee" as shown.

Fig. 9

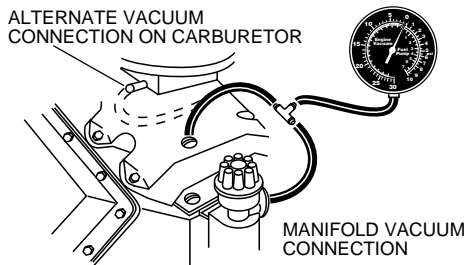

Test Results

On many systems, little or no vacuum is applied to the distributor at idle; as the throttle is opened wider (engine RPM increases), the vacuum gradually increases. The manifold vacuum drops when the engine is accelerated in proportion to the amount of throttle advance. The gauge should read between 18 and 21 for normal engines. Check vehicle manual for your car for proper value.

If the vacuum gauge does not change or changes very little with a change in RPM as described above, the vacuum hose may be open or cracked, or the diaphragm in the advance mechanism may be punctured.

NOTE: The vacuum reading can appear to be normal during the above tests while the advance mechanism is defective; that is, frozen due to rust, dirt or corrosion.

FUEL PUMP TESTING

CAUTION: Use extreme care in disconnecting fuel lines. Catch all gasoline in a container and discard. Leaking gasoline is a serious fire hazard.

Initial Inspection

Before testing, check tightness of all fittings and connections.

Check the rubber fuel lines at the fuel pump for deterioration, such as splitting, cracking and sponginess.

If leaks are evident in lines or fittings, repair or replace as necessary. If leakage is detected in the pump at the diaphragm flange, in the sheet metal cover, or in casting breather holes, replace the fuel pump. Check fuel level and remove any kinks in the fuel line. It is not necessary to remove the fuel pump for any of these inspections.

Procedure

1. Disconnect the fuel line between the fuel pump and the carburetor and attach the vacuum gauge hose to the fuel line, using adaptors as necessary. (See Figure 10).

NOTE: The fuel in the carburetor fuel bowl will be sufficient to run the engine for these tests.

2. Operate the engine at idle. Hold gauge at carburetor height and note the reading. Stop engine and re-connect fuel line.

Test Results

Compare the observed reading with the manufacturer's specifications. If specifications are not immediately available, fuel pump pressure can be considered satisfactory if it is between 4 and 6 PSI, with lower readings for smaller displacement engines. If pressure reading falls outside this range, consult the manufacturer's specifications before replacing the fuel pump.

Fig. 10

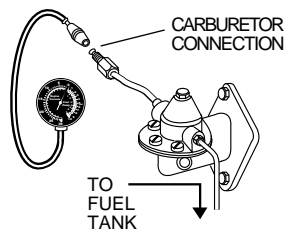
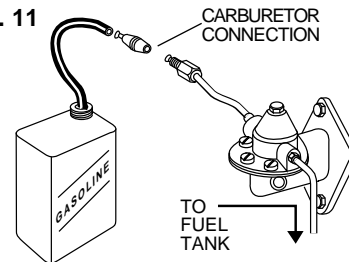

Fig. 11



VOLUME TEST

- Operate engine with fuel line connected to fill carburetor fuel bowl. Stop Engine.
- Disconnect the fuel line at the carburetor and connect a flexible hose to the fuel line using the adapter as shown in Figure 11. Insert the other end of the hose in a proper gasoline container.
- Have an assistant start the engine. While holding the gasoline can, carefully collect the discharge from the fuel pump for exactly 30 seconds. The assistant must count off the time precisely and turn off the engine after the 30 seconds to get an accurate measurement. Reconnect the fuel line to the carburetor.
- Remove the gasoline from the engine area. Pour the contents of the gasoline can into another container marked off in fluid ounces such as a kitchen measuring cup. Record the fuel quantity.
- After taking all measurements, return the fuel to the vehicle's gas tank.

Test Results

Consult the manufacturer's specifications for required fuel delivery rate. If specifications are not readily available, use the following table as a guide.

Engine Displacement (CID)	Ozs. Collected (30 seconds)
Up to 225	8
225 to 350	11
Over 350	16

If the above conditions are not met, replace or repair the defective components.

actron®
Actron Manufacturing Company

Fig. 12

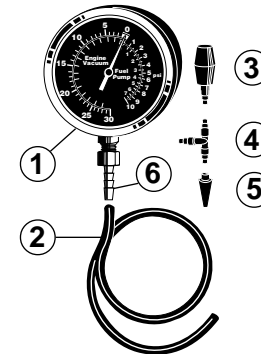

Vacuum & Pressure Tester Kit Repair Parts

Key No.	Part No.	Description
1	31-269	Vacuum and Pressure Gauge
2	400-384	Black Rubber Hose for air and fuel (24")
3	1000-1113	Universal Adapter – Fuel line, air and PVC
4	400-810	"Tee" Fitting
5	400-819	Tapered Hose Adapter
6	180-784	1/8 NPT X 0.187 Barb
	2-202002	Instruction Manual

One Year Warranty

If within one year from the date of purchase this equipment fails due to defect in materials or workmanship, return it to Actron and Actron will repair it free of charge.

This warranty gives you specific legal rights, and you may also have other rights which may vary from state to state.