

# User Manual

97 A!EA) +

lbhY^α `7 cfY! ]+!\* &\$@#\* &\$! 9 " ") Î  
`A]Wc`AcXi `Y`k ]h `bhY^α  
`EA) +`7\ ]dgYh

1st Ed -`\$, `GYdhYa VYf 201\$

**Version: January 2013**

## FCC Statement



THIS DEVICE COMPLIES WITH PART 15 FCC RULES. OPERATION IS SUBJECT TO THE FOLLOWING TWO CONDITIONS:

(1) THIS DEVICE MAY NOT CAUSE HARMFUL INTERFERENCE.

(2) THIS DEVICE MUST ACCEPT ANY INTERFERENCE RECEIVED INCLUDING INTERFERENCE THAT MAY CAUSE UNDESIRE OPERATION.

THIS EQUIPMENT HAS BEEN TESTED AND FOUND TO COMPLY WITH THE LIMITS FOR A CLASS "A" DIGITAL DEVICE, PURSUANT TO PART 15 OF THE FCC RULES.

THESE LIMITS ARE DESIGNED TO PROVIDE REASONABLE PROTECTION AGAINST HARMFUL INTERFERENCE WHEN THE EQUIPMENT IS OPERATED IN A COMMERCIAL ENVIRONMENT. THIS EQUIPMENT GENERATES, USES, AND CAN RADIATE RADIO FREQUENCY ENERGY AND, IF NOT INSTALLED AND USED IN ACCORDANCE WITH THE INSTRUCTION MANUAL, MAY CAUSE HARMFUL INTERFERENCE TO RADIO COMMUNICATIONS.

OPERATION OF THIS EQUIPMENT IN A RESIDENTIAL AREA IS LIKELY TO CAUSE HARMFUL INTERFERENCE IN WHICH CASE THE USER WILL BE REQUIRED TO CORRECT THE INTERFERENCE AT HIS OWN EXPENSE.

## Notice

This guide is designed for experienced users to setup the system within the shortest time. For detailed information, please always refer to the electronic user's manual.

## Copyright Notice

Copyright © 2010 Avalue Technology Inc., ALL RIGHTS RESERVED.

No part of this document may be reproduced, copied, translated, or transmitted in any form or by any means, electronic or mechanical, for any purpose, without the prior written permission of the original manufacturer.

## Trademark Acknowledgement

Brand and product names are trademarks or registered trademarks of their respective owners.

## Disclaimer

Avalue Technology Inc. reserves the right to make changes, without notice, to any product, including circuits and/or software described or contained in this manual in order to improve design and/or performance. Avalue Technology assumes no responsibility or liability for the use of the described product(s), conveys no license or title under any patent, copyright, or masks work rights to these products, and makes no representations or warranties that these products are free from patent, copyright, or mask work right infringement, unless

otherwise specified. Applications that are described in this manual are for illustration purposes only. Avalue Technology Inc. makes no representation or warranty that such application will be suitable for the specified use without further testing or modification.

## **Life Support Policy**

Avalue Technology's PRODUCTS ARE NOT FOR USE AS CRITICAL COMPONENTS IN LIFE SUPPORT DEVICES OR SYSTEMS WITHOUT THE PRIOR WRITTEN APPROVAL OF Avalue Technology Inc.

As used herein:

1. Life support devices or systems are devices or systems which, (a) are intended for surgical implant into body, or (b) support or sustain life and whose failure to perform, when properly used in accordance with instructions for use provided in the labeling, can be reasonably expected to result in significant injury to the user.
2. A critical component is any component of a life support device or system whose failure to perform can be reasonably expected to cause the failure of the life support device or system, or to affect its safety or effectiveness.

## **A Message to the Customer**

### ***Avalue Customer Services***

Each and every Avalue's product is built to the most exacting specifications to ensure reliable performance in the harsh and demanding conditions typical of industrial environments. Whether your new Avalue device is destined for the laboratory or the factory floor, you can be assured that your product will provide the reliability and ease of operation for which the name Avalue has come to be known.

Your satisfaction is our primary concern. Here is a guide to Avalue's customer services. To ensure you get the full benefit of our services, please follow the instructions below carefully.

### ***Technical Support***

We want you to get the maximum performance from your products. So if you run into technical difficulties, we are here to help. For the most frequently asked questions, you can easily find answers in your product documentation. These answers are normally a lot more detailed than the ones we can give over the phone. So please consult the user's manual first.

To receive the latest version of the user's manual; please visit our Web site at:

<http://www.avalue.com.tw/>

## ECM-QM57

If you still cannot find the answer, gather all the information or questions that apply to your problem, and with the product close at hand, call your dealer. Our dealers are well trained and ready to give you the support you need to get the most from your Avalue's products. In fact, most problems reported are minor and are able to be easily solved over the phone. In addition, free technical support is available from Avalue's engineers every business day. We are always ready to give advice on application requirements or specific information on the installation and operation of any of our products. Please do not hesitate to call or e-mail us.

### Headquarters and Branch

#### Avalue Technology Inc.

7F, 228, Lian-cheng Road, Chung Ho City, Taipei,  
Taiwan

Tel: +886-2-8226-2345

Fax: +886-2-8226-2777

Information: [sales@avalue.com.tw](mailto:sales@avalue.com.tw)

Service: [service@avalue.com.tw](mailto:service@avalue.com.tw)

#### BCM Advanced Research

#### BCM Advanced Research an Avalue Company

7 Marconi, Irvine, CA92618

Tel: +1-949-470-1888

Fax: +1-949-470-0971

Information: [BCMSales@bcmcom.com](mailto:BCMSales@bcmcom.com)

Web: [www.bcmcom.com](http://www.bcmcom.com)

#### Avalue China

#### Avalue Technology Inc.

Room 805, Building 9, No.99 Tianzhou Rd.,  
Caohejing Development Area,  
Xuhui District, Shanghai

Tel: +86-21-5169-3609

Fax: +86-21-5445-3266

Information: [sales.china@avalue.com.cn](mailto:sales.china@avalue.com.cn)

Service: [service@avalue.com.tw](mailto:service@avalue.com.tw)

#### Avalue USA

#### Avalue Technology Inc.

200 Tornillo Way, Suite 210, Tinton Falls,  
NJ 07712

Tel: +1-732-578-0200

Fax: +1-732-578-0250

Information: [sales@avalue-usa.com](mailto:sales@avalue-usa.com)

Service: [support@avalue-usa.com](mailto:support@avalue-usa.com)

#### Avalue Europe

#### Avalue Europe A/S

Moelledalen 22C, 3140  
Aalsgaarde, Denmark

Tel: +45-7025-0310

Fax: +45-4975-5026

Information: [sales.europe@avalue.com.tw](mailto:sales.europe@avalue.com.tw)

Service: [service.europe@avalue.com.tw](mailto:service.europe@avalue.com.tw)

#### Avalue Japan

#### Avalue Technology Inc.

2F keduka-Bldg, 2-27-3 Taito,  
Taito-Ku, Tokyo 110-0016 Japan

Tel: +81-3-5807-2321

Fax: +81-3-5807-2322

Information: [sales.japan@avalue.com.tw](mailto:sales.japan@avalue.com.tw)

Service: [service@avalue.com.tw](mailto:service@avalue.com.tw)

## ***Product Warranty***

Avalue warrants to you, the original purchaser, that each of its products will be free from defects in materials and workmanship for two years from the date of purchase.

This warranty does not apply to any products which have been repaired or altered by persons other than repair personnel authorized by Avalue, or which have been subject to misuse, abuse, accident or improper installation. Avalue assumes no liability under the terms of this warranty as a consequence of such events. Because of Avalue's high quality-control standards and rigorous testing, most of our customers never need to use our repair service. If any of Avalue's products is defective, it will be repaired or replaced at no charge during the warranty period. For out-of-warranty repairs, you will be billed according to the cost of replacement materials, service time, and freight. Please consult your dealer for more details. If you think you have a defective product, follow these steps:

1. Collect all the information about the problem encountered. (For example, CPU type and speed, Avalue's products model name, hardware & BIOS revision number, other hardware and software used, etc.) Note anything abnormal and list any on-screen messages you get when the problem occurs.
2. Call your dealer and describe the problem. Please have your manual, product, and any helpful information available.
3. If your product is diagnosed as defective, obtain an RMA (return material authorization) number from your dealer. This allows us to process your good return more quickly.
4. Carefully pack the defective product, a complete Repair and Replacement Order Card and a photocopy proof of purchase date (such as your sales receipt) in a shippable container. A product returned without proof of the purchase date is not eligible for warranty service.
5. Write the RMA number visibly on the outside of the package and ship it prepaid to your dealer.

# Contents

<b>1. Getting Started</b> .....	<b>9</b>
1.1 Safety Precautions .....	9
1.2 Packing List.....	9
1.3 Document Amendment History .....	10
1.4 Manual Objectives.....	11
1.5 System Specifications .....	12
1.6 Architecture Overview – Block Diagram.....	14
<b>2. Hardware Configuration</b> .....	<b>16</b>
2.1 Product Overview.....	17
2.2 Installation Procedure .....	18
2.2.1 Main Memory.....	19
2.3 Jumper and Connector List.....	21
2.4 Setting Jumpers & Connectors .....	23
2.4.1 Clear CMOS (JBAT1).....	23
2.4.2 Serial port 1 pin 9 signal select (JRI1) .....	23
2.4.3 AT/ ATX Input power select (PWR_MSEL1).....	24
2.4.4 5VSB connector in ATX (PWR_SB).....	24
2.4.4.1 Signal Description –AT/ATX mode & Input power type .....	25
2.4.5 Battery connector (BBAT1) .....	26
2.4.6 CFAST LED connector (BLED1/ BLED2) .....	26
2.4.7 CPU fan connector (CPU_FAN1/ SYS_FAN1).....	27
2.4.8 Serial port 1 in RS-422/485 mode (J422/485) .....	27
2.4.9 Audio connector (JAUDIO1).....	28
2.4.10 +12V power Connector (JBKL1).....	28
2.4.11 LCD backlight brightness adjustment (JVR1).....	29
2.4.12 Low pin count connector (JLPC1).....	29
2.4.13 LCD Inverter Connector (JBKL2).....	30
2.4.13.1 Signal Description – LCD Inverter Connector (JBKL2).....	30
2.4.14 LED backlight adjustment connector (JBKL3/ JBKL4) .....	31
2.4.15 Serial port 2 connector (JCOM2).....	31
2.4.16 General purpose I/O connector (JDIO).....	32
2.4.17 Miscellaneous setting connector (JFP).....	33
2.4.18 SPI connector (JSPI1) .....	33
2.4.19 LVDS connector (JLVDS1) .....	34
2.4.20 USB connector 8 & 9/ 10 & 11 (JUSB45/ JUSB67).....	35
2.4.21 Power connector (PWRCON1).....	35
2.5 Audio / USB Daughter Board User’s Guide.....	36
<b>6 ECM-QM57 User’s Manual</b>	

2.5.1	Jumper and Connector Layout.....	36
2.5.2	Jumper and Connector List .....	36
2.5.3	Setting Jumper and Connector .....	37
<b>3.</b>	<b>BIOS Setup.....</b>	<b>38</b>
3.1	Introduction .....	39
3.2	Starting Setup .....	39
3.3	Using Setup .....	40
3.4	Getting Help .....	41
3.5	In Case of Problems.....	41
3.6	BIOS setup.....	42
3.6.1	Main Menu.....	42
3.6.1.1	System Language .....	42
3.6.1.2	System Date .....	42
3.6.1.3	System Time .....	42
3.6.2	Advanced Menu .....	43
3.6.2.1	ACPI Settings.....	44
3.6.2.2	S5 RTC Wake Settings.....	45
3.6.2.3	CPU Configuration .....	46
3.6.2.4	SATA Configuration.....	48
3.6.2.5	Intel IGD SWSCI OpRegion configuration .....	49
3.6.2.6	Intel TDT (AT-p) Configuration.....	50
3.6.2.7	Intel TXT (LT) Configuration.....	51
3.6.2.8	USB Configuration .....	52
3.6.2.8.1	<i>Legacy USB support</i> .....	52
3.6.2.8.2	<i>ECHI hand-off</i> .....	52
3.6.2.8.3	<i>Device Reset timeout</i> .....	52
3.6.2.8.4	<i>Controller Timeout</i> .....	53
3.6.2.8.5	<i>Mass Storage Devices</i> .....	53
3.6.2.9	H/W Monitor.....	53
3.6.2.10	Super IO Configuration.....	54
3.6.2.10.1	<i>Serial Port 0 Configuration</i> .....	55
3.6.2.10.2	<i>Serial Port 1 Configuration</i> .....	56
3.6.2.11	Thermal Configuration.....	57
3.6.2.11.1	<i>Platform thermal Configuration</i> .....	57
3.6.2.11.2	<i>Intelligent Power Sharing</i> .....	59
3.6.2.12	AMT Configuration .....	60
3.6.3	Advanced Chipset Features .....	61
3.6.3.1	North Bridge .....	62
3.6.3.2	South Bridge .....	63
3.6.3.2.1	<i>PCI Express Ports Configuration</i> .....	64

## ECM-QM57

3.6.3.2.2	USB Configuration.....	65
3.6.3.3	ME Subsystem .....	66
3.6.4	Boot .....	67
3.6.5	Security .....	68
3.6.5.1	Administrator Password.....	68
3.6.5.2	User Password.....	68
3.6.6	Save & Exit.....	69
3.6.6.1	Save Changes and Exit.....	69
3.6.6.2	Discard Changes and Exit .....	69
3.6.6.3	Save Changes and Reset.....	69
3.6.6.4	Discard Changes and Reset .....	69
3.6.6.5	Save Changes .....	69
3.6.6.6	Discard Changes.....	70
3.6.6.7	Restore Defaults .....	70
3.6.6.8	Save as user defaults .....	70
3.6.6.9	Restore as user defaults.....	70
3.6.6.10	Boot override.....	70
3.6.6.11	Reset system with ME disable mode.....	70
<b>4.</b>	<b>Drivers Installation.....</b>	<b>71</b>
4.1	Install Chipset Driver (For Intel QM57).....	72
4.2	Install Display Driver (For Intel QM57) .....	73
4.3	Install Audio Driver (For Realtek ALC888) .....	74
4.4	Install Ethernet Driver (For Intel 82574L/ 82577LM) .....	75
<b>5.</b>	<b>Mechanical Drawing .....</b>	<b>77</b>



# 1. Getting Started

## 1.1 Safety Precautions

### Warning!



Always completely disconnect the power cord from your chassis whenever you work with the hardware. Do not make connections while the power is on. Sensitive electronic components can be damaged by sudden power surges. Only experienced electronics personnel should open the PC chassis.

### Caution!



Always ground yourself to remove any static charge before touching the CPU card. Modern electronic devices are very sensitive to static electric charges. As a safety precaution, use a grounding wrist strap at all times. Place all electronic components in a static-dissipative surface or static-shielded bag when they are not in the chassis.

## 1.2 Packing List

Before you begin installing your single board, please make sure that the following materials have been shipped:

- 1 x 3.5" ECM-QM57 Micro Module
- 1 x Quick Installation Guide for ECM-QM57
- 1 x AUX-032 daughter board
- 1 x DVD-ROM contains the followings:
  - User's Manual (this manual in PDF file)
  - Ethernet driver and utilities
  - VGA drivers and utilities
  - Audio drivers and utilities
- 1 x Cable set contains the followings:
  - 1 x Audio cable (12pin, 2.0mm pitch)
  - 2 x USB cable (10P/2.54mm-10P/2.0mm)
  - 1 x Serial ATA cable (7-pin, standard)
  - 1 x Serial ATA cable (15-pin, 2P/2.0mm)



---

If any of the above items is damaged or missing, contact your retailer.

---

### 1.3 Document Amendment History

Revision	Date	Comment
1 <sup>st</sup>	September 2010	Initial Release

## 1.4 Manual Objectives

This manual describes in detail the Avalue Technology ECM-QM57 Single Board.

We have tried to include as much information as possible but we have not duplicated information that is provided in the standard IBM Technical References, unless it proved to be necessary to aid in the understanding of this board.



We strongly recommend that you study this manual carefully before attempting to interface with ECM-QM57 series or change the standard configurations. Whilst all the necessary information is available in this manual we would recommend that unless you are confident, you contact your supplier for guidance.

Please be aware that it is possible to create configurations within the CMOS RAM that make booting impossible. If this should happen, clear the CMOS settings, (see the description of the Jumper Settings for details).

If you have any suggestions or find any errors concerning this manual and want to inform us of these, please contact our Customer Service department with the relevant details.

## 1.5 System Specifications

System 	
CPU	Onboard Intel® Core™ i7-620LE/ 620UE Processor
BIOS	AMI 64Mbit SPI BIOS
System Chipset	Intel® QM57
I/O Chip	Winbond W83627DHG-P
System Memory	One 204-pin DDR3 SODIMM Socket Supports Up to 4GB DDR3 800/ 1066 SDRAM
SSD	One CompactFlash Type I/II Socket
Watchdog Timer Reset	1~255sec./min. and 1sec. or 1min./step
H/W Status Monitor	Monitoring System Temperature, Voltage. Auto Trotting Control When CPU Overheats
Expansion	1 x PCIe Mini Card Slot (From The Daughter Board )
I/O 	
MIO	2 x Serial ATA Ports, 1 x RS-232, 1 x RS-232/ 422/ 485, LPC, 2 x SATA
USB	5 x USB 2.0
DIO	8-bit GPI, 8-bit GPO
Display 	
Chipset	Intel® QM57
Resolution	CRT Mode: 2048 x 1536 @ 75Hz LCD/ Simultaneous Mode: 1600 x 1200 @ 75 Hz
Multiple Display	CRT + LVDS, HDMI + LVDS, CRT + HDMI
LVDS	Dual-channel 18/ 24-bit LVDS
Audio 	
AC97 Codec	Realtek ALC888 Supports 5.1-CH Audio
Audio Interface	Mic-in, Line-in, Line-out

Ethernet 	
LAN	1 x Intel® 82577LM Gigabit Ethernet 1 x Intel® 82574L Gigabit Ethernet
Ethernet Interface	1000 Base-Tx Gigabit Ethernet Compatible
Mechanical & Environmental 	
Power Requirement	+12V
ACPI	Single Power ATX Support S0, S1, S3, S4, S5 ACPI 3.0 Compliant
Power Type	AT/ ATX
Operation Temperature	0 ~ 60°C (32 ~ 122°F)
Storage Temperature	-20 ~ 80°C (-68 ~ 176°F)
Operating Humidity	0%~90% Relative Humidity, Non-condensing
Size ( L x W )	5.7" x 4" (146mm x 101mm)
Weight	0.44lbs (0.2kg)

## 1.6 Architecture Overview – Block Diagram

The following block diagram shows the architecture and main components of ECM-QM57.

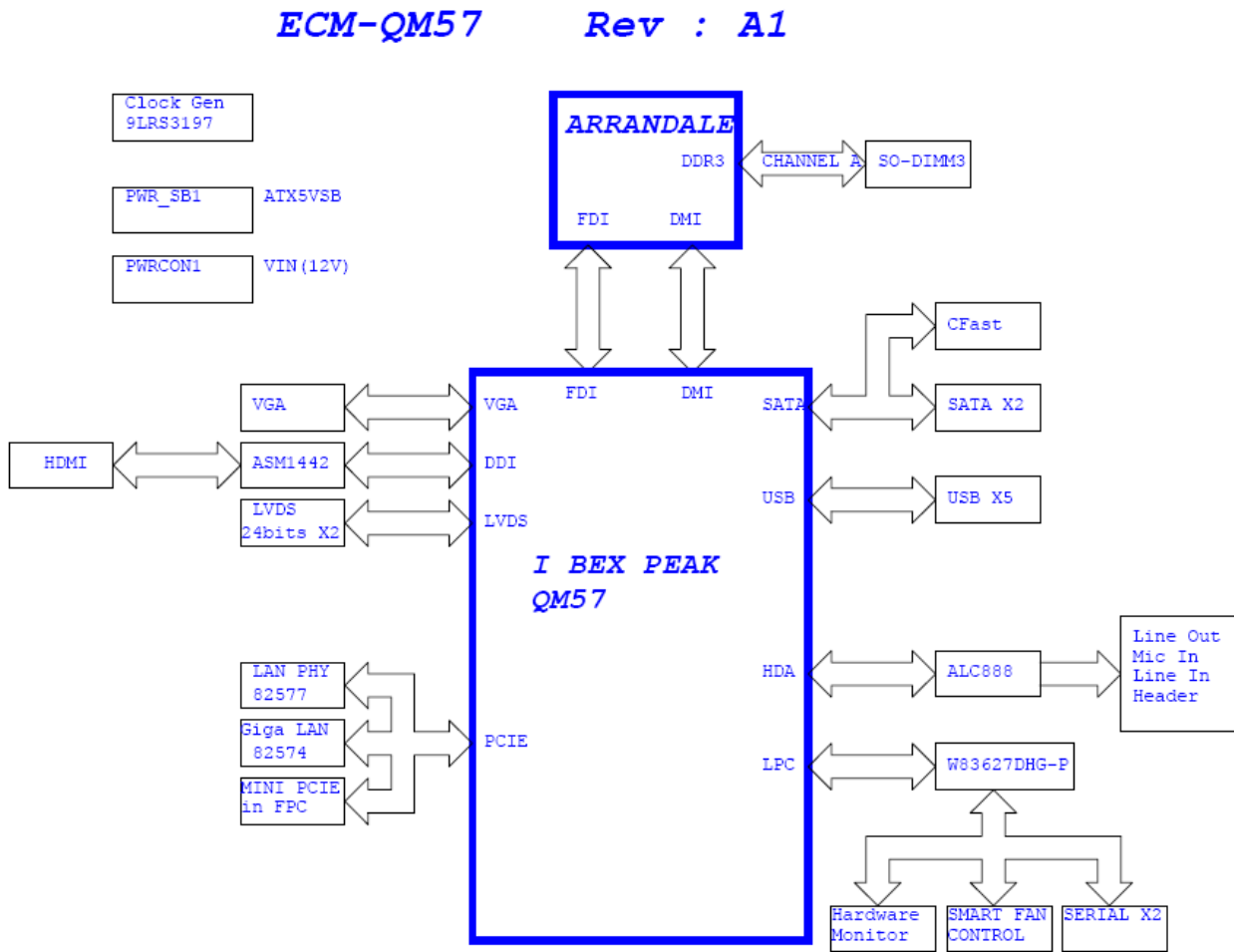



# 2. Hardware Configuration

---



## 2.1 Product Overview

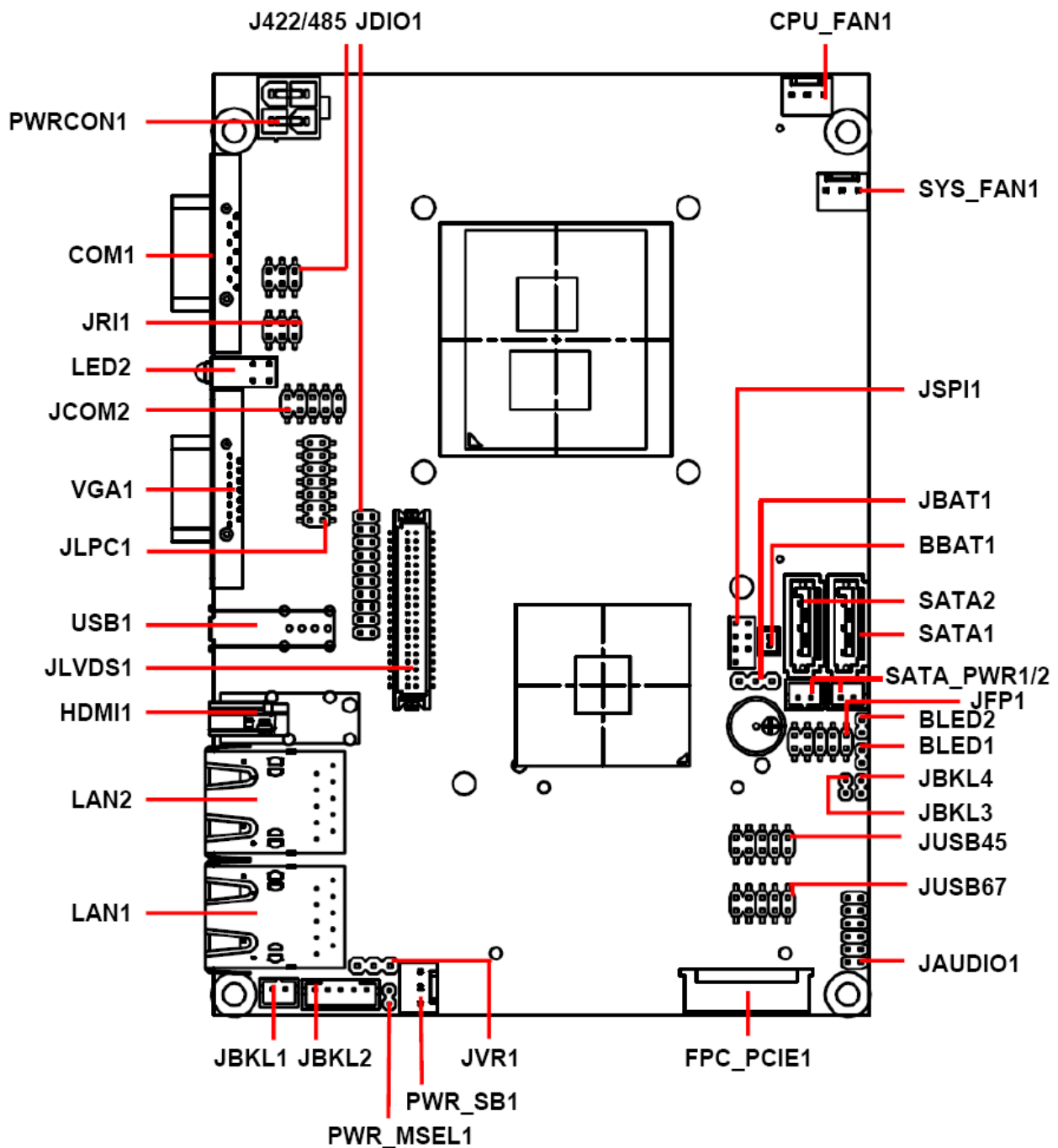

## 2.2 Installation Procedure

This chapter explains you the instructions of how to setup your system.

1. Turn off the power supply.
2. Insert the SODIMM module (be careful with the orientation).
3. Insert all external cables for hard disk, floppy, keyboard, mouse, USB etc. except for flat panel. A CRT monitor must be connected in order to change CMOS settings to support flat panel.
4. Connect power supply to the board via the ATXPWR.
5. Turn on the power.
6. Enter the BIOS setup by pressing the delete key during boot up. Use the “LOAD BIOS DEFAULTS” feature. The **Main** window must be entered and configured correctly to match the particular system configuration.
7. If TFT panel display is to be utilized, make sure the panel voltage is correctly set before connecting the display cable and turning on the power.



**Note:** Make sure the heat sink and the CPU top surface are in total contact to avoid CPU overheating problem that would cause the system to hang or unstable.

### 2.2.1 Main Memory

ECM-QM57 provides one 204-pin SODIMM non-ECC socket support up to DDR3 800/1066 SDRAM. The total maximum memory size is 4GB.

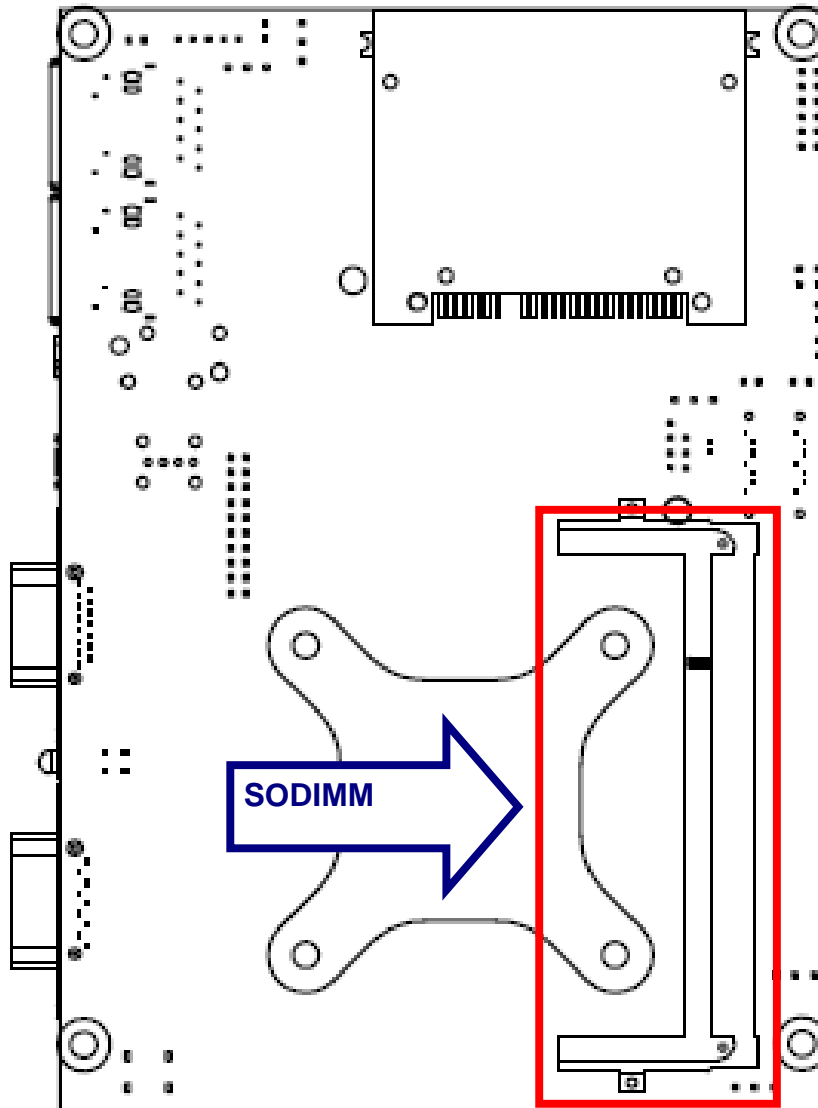

(Rear side)



Make sure to unplug the power supply before adding or removing SODIMMs or other system components. Failure to do so may cause severe damage to both the board and the components.

- Locate the SODIMM socket on the board.
- Hold two edges of the SODIMM module carefully. Keep away of touching its connectors.
- Align the notch key on the module with the rib on the slot.

## ECM-QM57

- Firmly press the modules into the socket automatically snaps into the mounting notch. Do not force the SODIMM module in with extra force as the SODIMM module only fit in one direction.

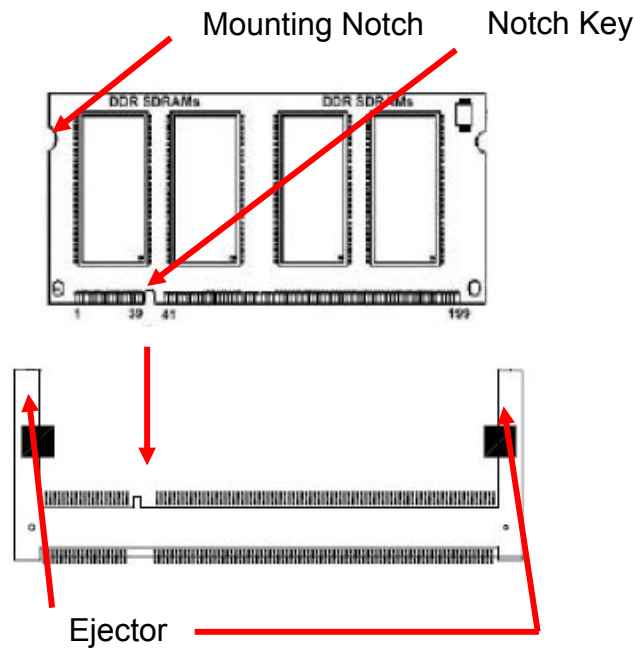

### 204-pin DDR3 SODIMM

- To remove the SODIMM modules, push the two ejector tabs on the slot outward simultaneously, and then pull out the SODIMM module.



#### Note:

- (1) Please do not change any DDR3 SDRAM parameter in BIOS setup to increase your system's performance without acquiring technical information in advance.
- (2) Static electricity can damage the electronic components of the computer or optional boards. Before starting these procedures, ensure that you are discharged of static electricity by touching a grounded metal object briefly.

## 2.3 Jumper and Connector List

You can configure your board to match the needs of your application by setting jumpers. A jumper is the simplest kind of electric switch.

It consists of two metal pins and a small metal clip (often protected by a plastic cover) that slides over the pins to connect them. To “close” a jumper you connect the pins with the clip. To “open” a jumper you remove the clip. Sometimes a jumper will have three pins, labeled 1, 2, and 3. In this case, you would connect either two pins.

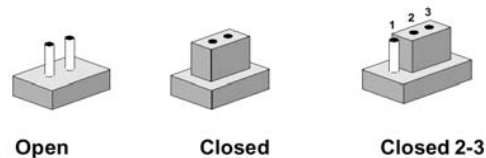

The jumper settings are schematically depicted in this manual as follows:



A pair of needle-nose pliers may be helpful when working with jumpers.

Connectors on the board are linked to external devices such as hard disk drives, a keyboard, or floppy drives. In addition, the board has a number of jumpers that allow you to configure your system to suit your application.

If you have any doubts about the best hardware configuration for your application, contact your local distributor or sales representative before you make any changes.

The following tables list the function of each of the board's jumpers and connectors.

### Jumpers

Label	Function	Note
<b>JBAT1</b>	Clear CMOS	3 x 1 header, pitch 2.54 mm
<b>JRI1</b>	Serial port 1 pin 9 signal select	3 x 2 header, pitch 2.0 mm
<b>PWR_MSEL1</b>	Input power select	2 x 1 header, pitch 2.54 mm

## Connectors

Label	Function	Note
BBAT1	Battery connector	2 x 1 wafer, pitch 1.25 mm
BLED1	CFAST LED connector 1	2 x 1 header, pitch 2.0 mm
BLED2	CFAST LED connector 2	2 x 1 header, pitch 2.0 mm
COM1	Serial port 1 connector	D-sub 9-pin, male
CPU_FAN1	CPU fan connector	3 x 1 wafer, pitch 2.54 mm
FPC_PCIE1	PCIE slot	
HDMI1	HDMI connector	
J422/485	Serial port 1 in RS-422/485 mode	3 x 2 header, pitch 2.0 mm
JAUDIO1	Audio connector	6 x 2 header, pitch 2.0 mm
JBKL1	+12V power connector	2 x 1 wafer, pitch 2.0 mm
JBKL2	LCD inverter connector	5 x 1 wafer, pitch 2.0 mm
JBKL3	LED backlight adjustment connector 1	2 x 1 header, pitch 2.0 mm
JBKL4	LED backlight adjustment connector 2	2 x 1 header, pitch 2.0 mm
JCOM2	Serial port 2 connector	5 x 2 header, pitch 2.0 mm
JDIO1	General purpose I/O connector	10 x 2 header, pitch 2.0 mm
JFP1	Miscellaneous setting connector	5 x 2 header, pitch 2.0 mm
JLPC1	Low pin count interface	7 x 2 header, pitch 2.0 mm
JLVDS1	LVDS connector	
JSPI1	SPI connector	4 x 2 header, pitch 2.0 mm
JUSB45	USB connector 8 & 9	5 x 2 header, pitch 2.0 mm
JUSB67	USB connector 10 & 11	5 x 2 header, pitch 2.0 mm
JVR1	LCD backlight brightness adjustment	3 x 1 header, pitch 2.54 mm
LAN1/ LAN2	RJ-45 Ethernet connector	
LED2	LED connector	
PWR_SB1	5VSB connector in ATX	3 x 1 wafer, pitch 2.54 mm
PWRCON1	Power connector	2 x 2 wafer, pitch 4.2 mm
SATA_PWR1	SATA power connector	2 x 1 wafer, pitch 2.0 mm
SATA_PWR2	SATA power connector	2 x 1 wafer, pitch 2.0 mm
SATA1	Serial ATA connector 1	
SATA2	Serial ATA connector 2	
SYS_FAN1	System fan connector	3 x 1 wafer, pitch 2.54 mm
USB1	USB connector 2	
VGA1	VGA connector	D-sub 15-pin, female

## 2.4 Setting Jumpers & Connectors

### 2.4.1 Clear CMOS (JBAT1)

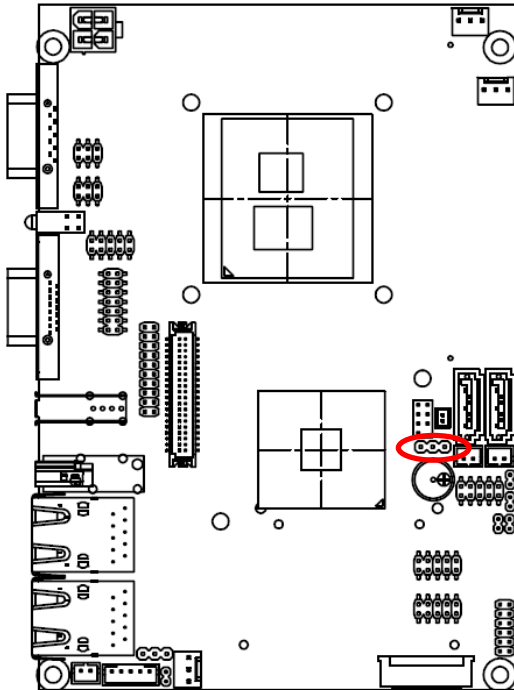

Protect\*

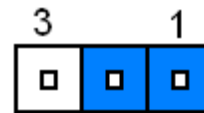

Clear CMOS

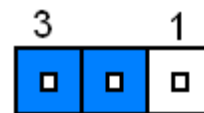

\* Default

### 2.4.2 Serial port 1 pin 9 signal select (JRI1)

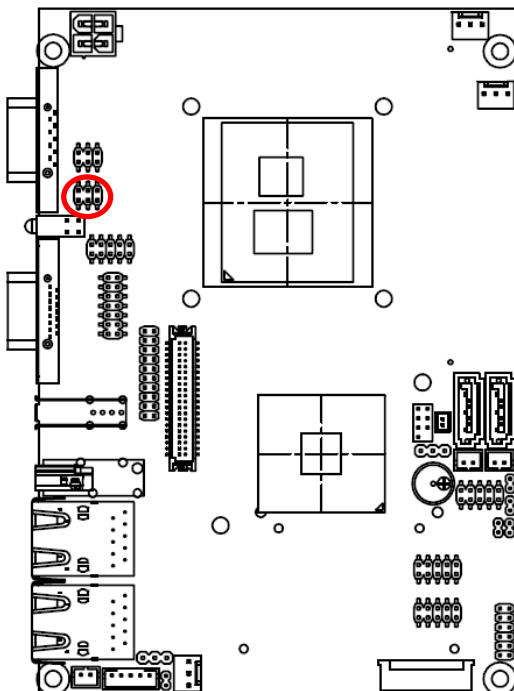

Ring\*

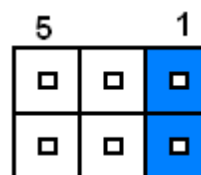

+5V

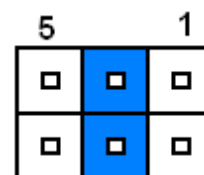

+12V

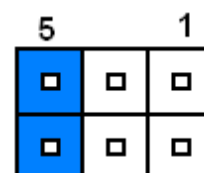

\* Default

### 2.4.3 AT/ ATX Input power select (PWR\_MSEL1)

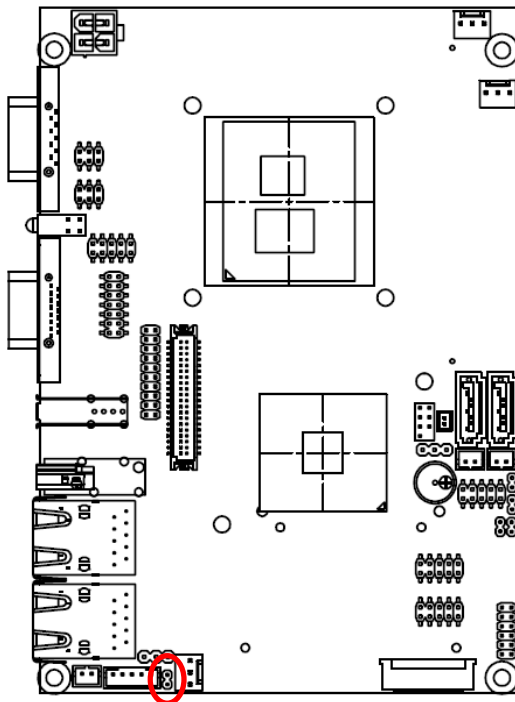

AT\*

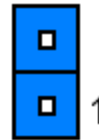

ATX

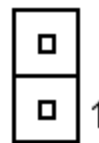

\* Default

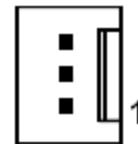
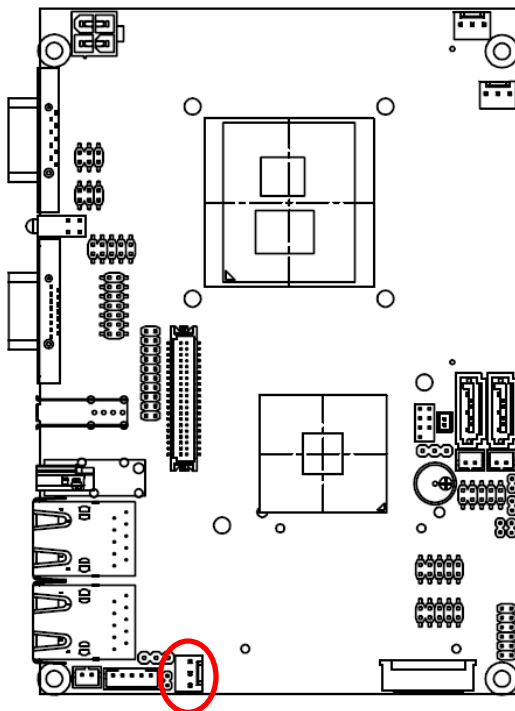

### 2.4.4 5VSB connector in ATX (PWR\_SB)



Signal	PIN
ATX5VSB	3
GND	2
PSON	1

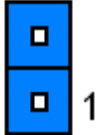
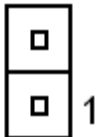

2.4.4.1 Signal Description –AT/ATX mode & Input power type

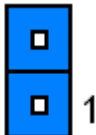
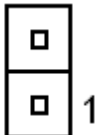
Input power type	Power-ON Mode	Description
<p>AT Type</p>	<p>AT Mode (PWR_MSEL1)</p> 	<p>Use AT type power input, and set the board in AT mode.</p>
	<p>ATX Mode (PWR_MSEL1)</p> 	<p>Use AT type power input, and set the board in ATX mode.</p>
<p>ATX Type (PWR_SB)</p> 	<p>AT Mode (PWR_MSEL1)</p> 	<p>Use ATX type power input, and set the board in AT mode.</p>
	<p>ATX Mode (PWR_MSEL1)</p> 	<p>Use ATX type power input, and set the board in ATX mode.</p>

### 2.4.5 Battery connector (BBAT1)

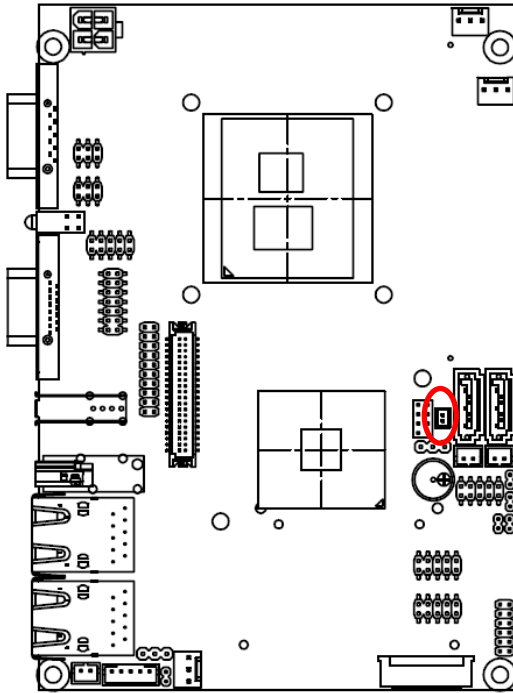

Signal	PIN
GND	2
VBAT	1

### 2.4.6 CFAST LED connector (BLED1/ BLED2)

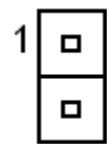
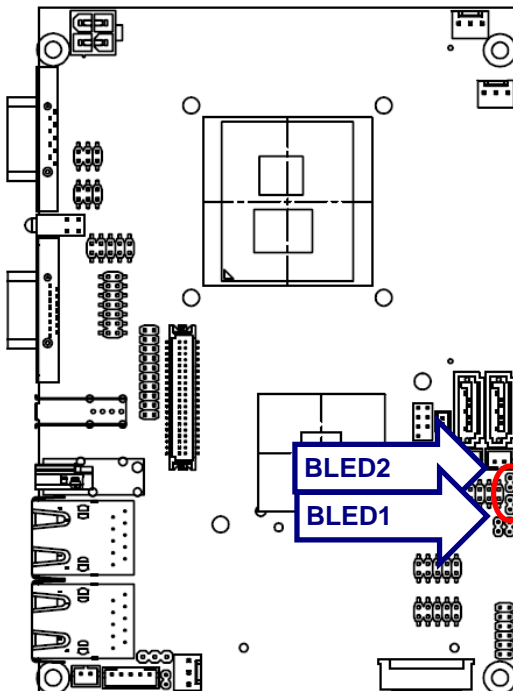

Signal	PIN
GND	2
BLED1/ BLED2	1

### 2.4.7 CPU fan connector (CPU\_FAN1/ SYS\_FAN1)

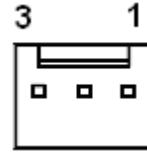
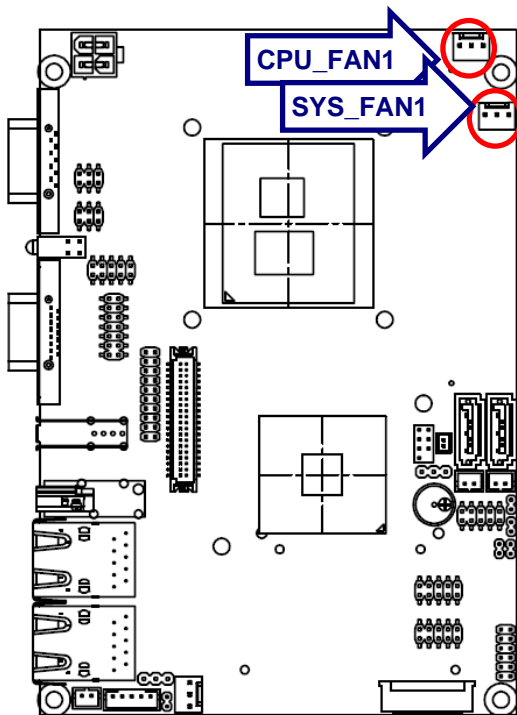

Signal	PIN
GND	1
CPU_FAN_PWR/ SYS_FAN_PWR	2
CPUFANIN/ SYSFANIN	3

### 2.4.8 Serial port 1 in RS-422/485 mode (J422/485)

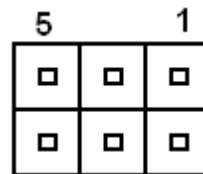
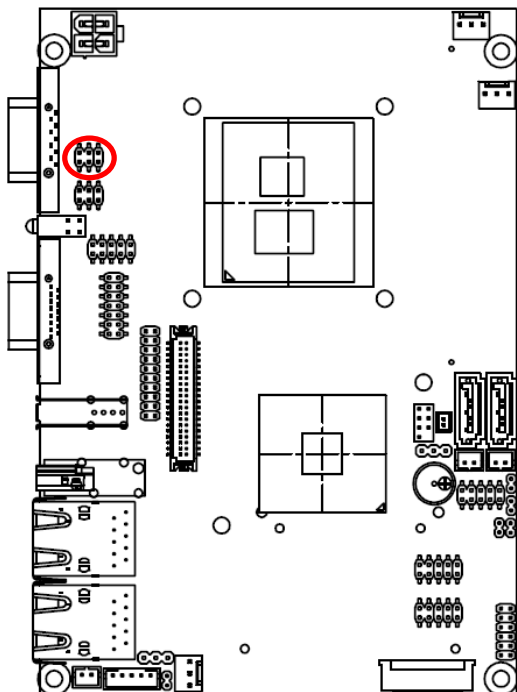

Signal	PIN	PIN	Signal
485RX-	2	1	485TX-
485RX+	4	3	485TX+
GND	6	5	+5V

2.4.9 Audio connector (JAUDIO1)

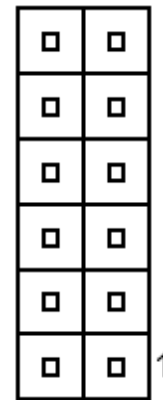
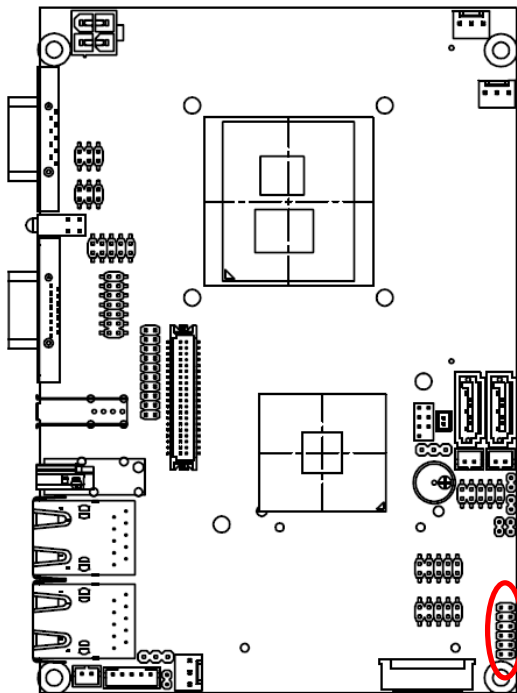

Signal	PIN	PIN	Signal
GND	12	11	MIC1_JD
LIN1_JD	10	9	FRONT_JD
MIC1_L	8	7	MIC1_R
LIN1_L	6	5	LIN1_R
GND	4	3	GND
FRONT_L	2	1	FRONT_R

2.4.10 +12V power Connector (JBKL1)

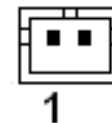
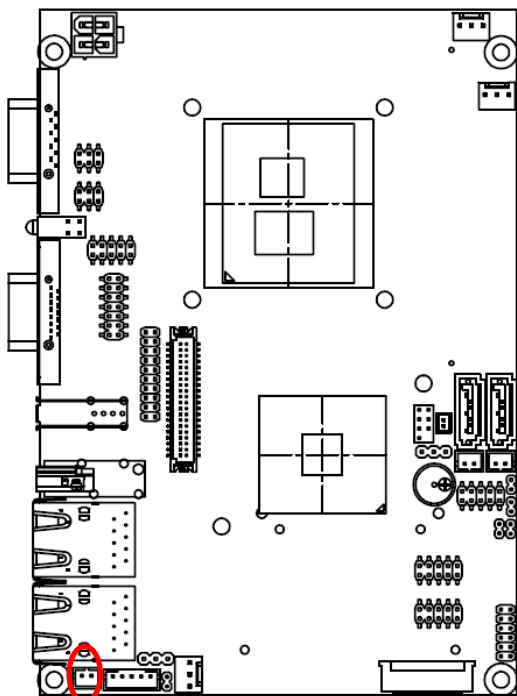

Signal	PIN
+12V	1
GND	2

### 2.4.11 LCD backlight brightness adjustment (JVR1)

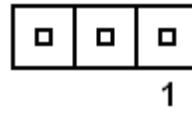
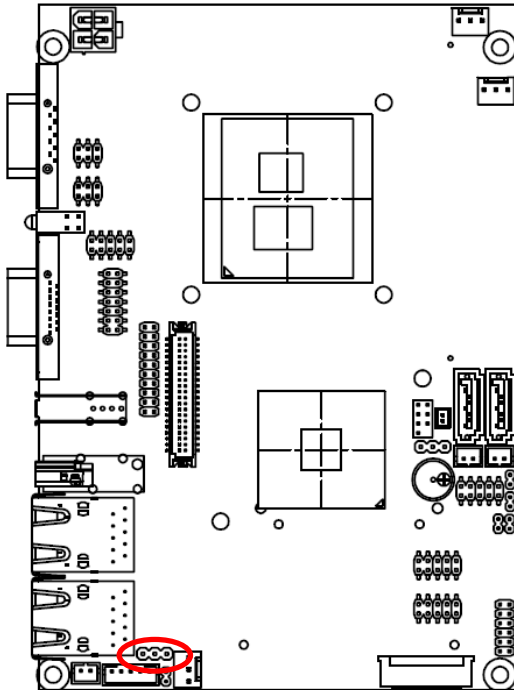

Signal	PIN
+5V	1
BRIGHT	2
GND	3

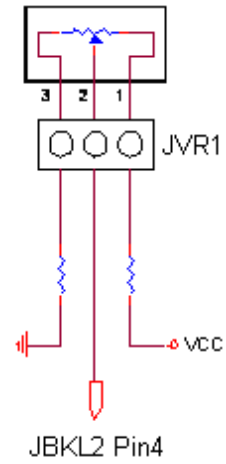

Variation Resistor  
(Recommended: 4.7KΩ,  
>1/16W)

### 2.4.12 Low pin count connector (JLPC1)

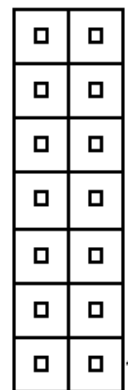
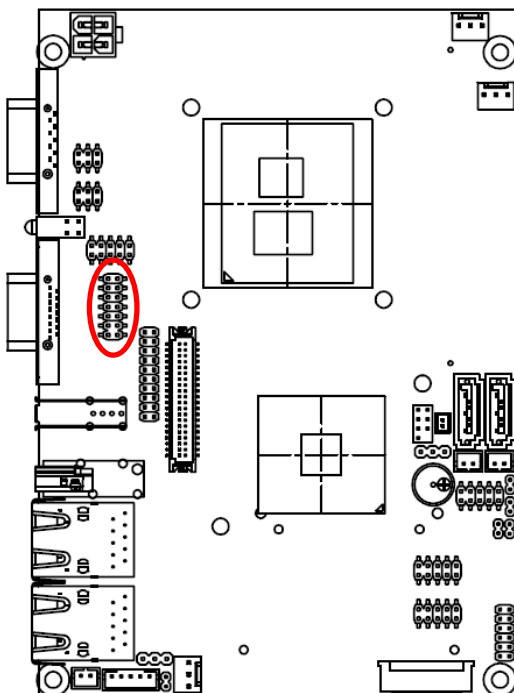

Signal	PIN	PIN	Signal
GND	14	13	+5VSB
GND	12	11	+5V
GND	10	9	INT_SERIRQ
CLK_LPC	8	7	LPC_AD3
LPC_FRAME#	6	5	LPC_AD2
PLT_RST#	4	3	LPC_AD1
+3.3V	2	1	LPC_AD0

2.4.13 LCD Inverter Connector (JBKL2)

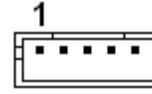
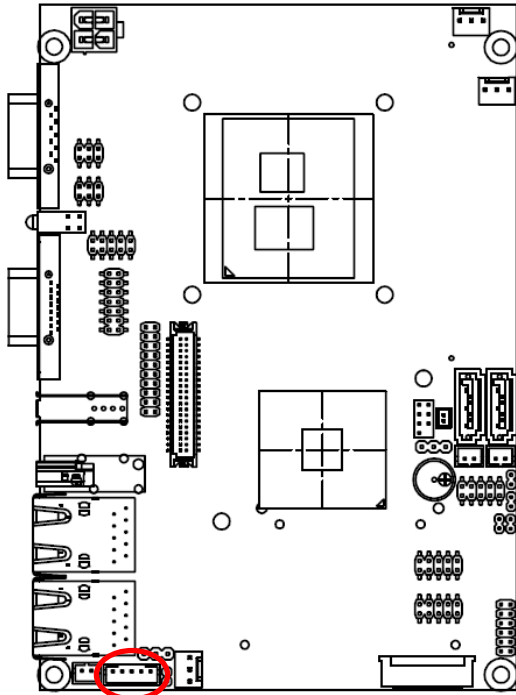

Signal	PIN
+12V	1
GND	2
BLEN	3
L_BKLT_CTRL_R	4
+5V	5



**Note:**

For inverters with adjustable Backlight function, it is possible to control the LCD brightness through the VR signal controlled by **JVR1**. Please see the **JVR1** section for detailed circuitry information.

2.4.13.1 Signal Description – LCD Inverter Connector (JBKL2)

Signal	Signal Description
L_BKLT_CTRL_R	V <sub>adj</sub> = 0.75V ~ 4.25V (Recommended: 4.7KΩ, >1/16W)
BLEN	LCD backlight ON/OFF control signal

### 2.4.14 LED backlight adjustment connector (JBKL3/ JBKL4)

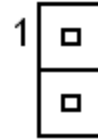
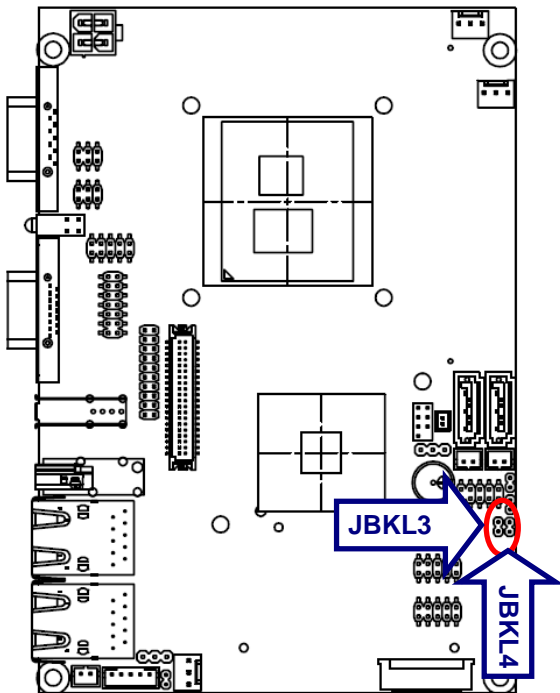

Signal	PIN
GPIO7/ DGPU_HPD_INTR#	1
GND	2

### 2.4.15 Serial port 2 connector (JCOM2)

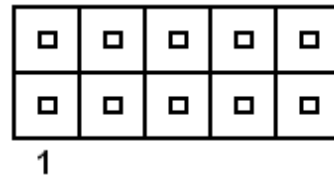
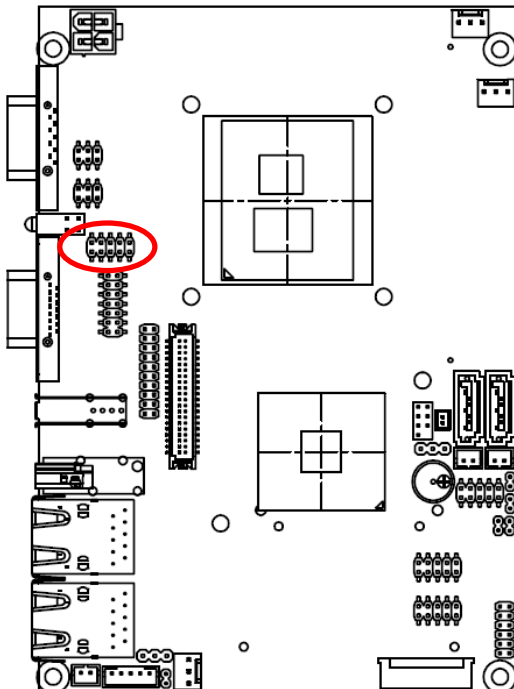

Signal	PIN	PIN	Signal
DCD2	1	2	RxDD2
TxDD2	3	4	DTR2
GND	5	6	DSR2
RTS2	7	8	CTS2
RI2	9	10	NC

2.4.16 General purpose I/O connector (JDIO)

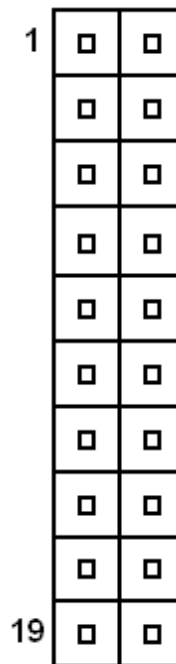
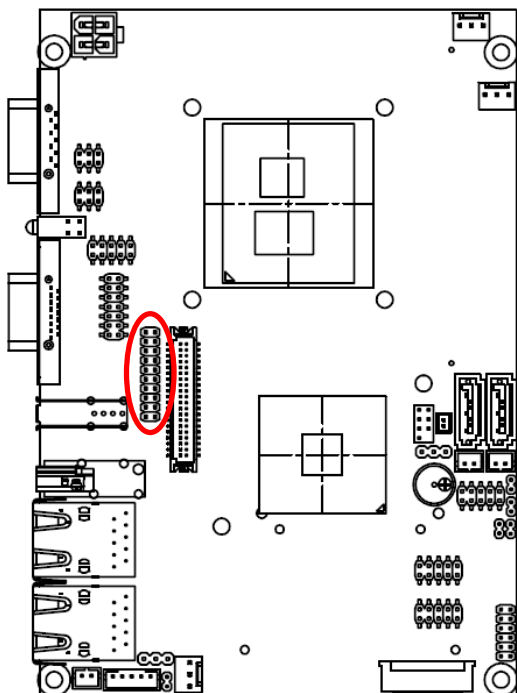

Signal	PIN	PIN	Signal
DIO_GP20	1	2	DIO_GP10
DIO_GP21	3	4	DIO_GP11
DIO_GP22	5	6	DIO_GP12
DIO_GP23	7	8	DIO_GP13
DIO_GP24	9	10	DIO_GP14
DIO_GP25	11	12	DIO_GP15
DIO_GP26	13	14	DIO_GP16
DIO_GP27	15	16	DIO_GP17
SMBCLK_MAIN	17	18	SMBDATA_MAIN
GND	19	20	+5V



### 2.4.17 Miscellaneous setting connector (JFP)

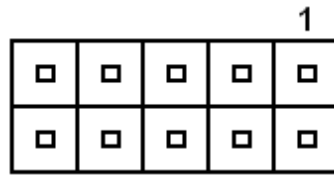
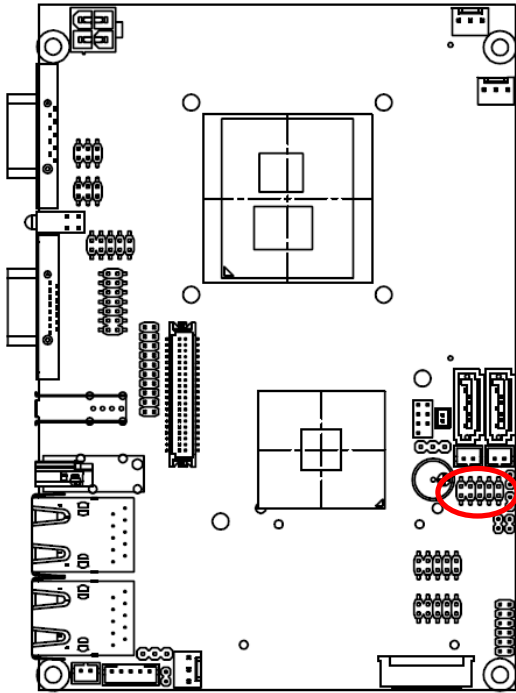

Signal	PIN
PEBT	1
	2
RST#	3
	4
PWR-LED	5
	6
HDD-LED	7
	8
COPEN#	9
	10

### 2.4.18 SPI connector (JSPI1)

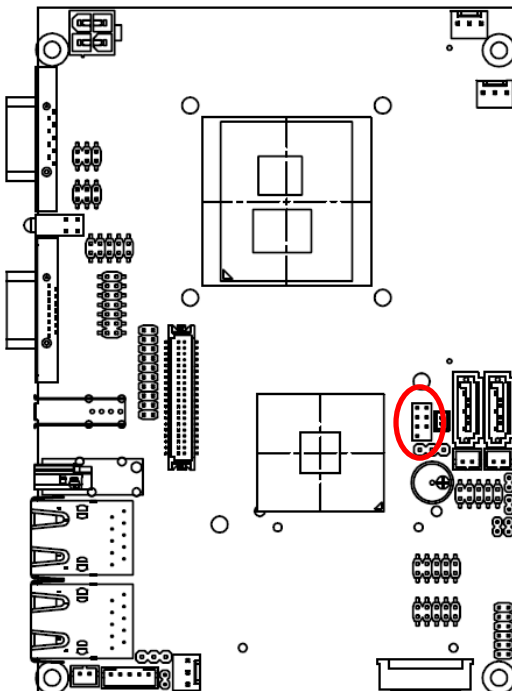

Signal	PIN	PIN	Signal
+3.3V	1	2	GND
SPI_CS#0	3	4	SPI_CLK
SPISO	5	6	SPI_SI
HOLD#_R	7		

2.4.19 LVDS connector (JLVDS1)

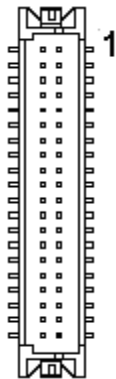
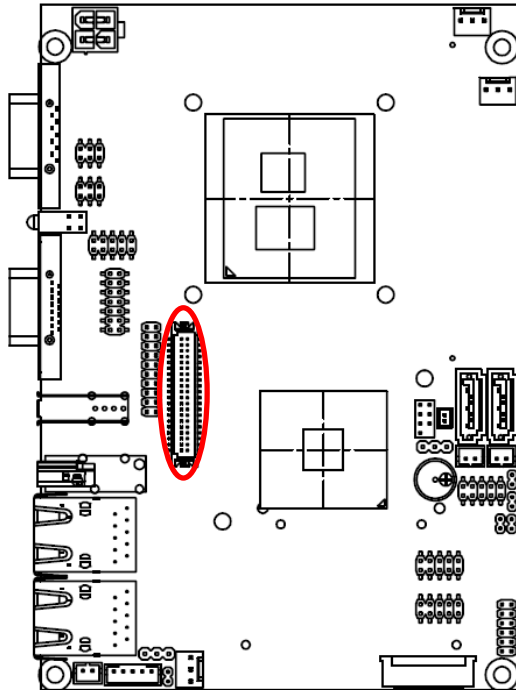

Signal	PIN	PIN	Signal
+5V	2	1	+3.3V
+5V	4	3	+3.3V
LVDS_DDC_DATA	6	5	LVDS_DDC_CLK
GND	8	7	GND
LVDSA_DATA0	10	9	LVDSA_DATA1
LVDSA_DATA0#	12	11	LVDSA_DATA1#
GND	14	13	GND
LVDSA_DATA2	16	15	LVDSA_DATA3
LVDSA_DATA2#	18	17	LVDSA_DATA3#
GND	20	19	GND
LVDSB_DATA0	22	21	LVDSB_DATA1
LVDSB_DATA0#	24	23	LVDSB_DATA1#
GND	26	25	GND
LVDSB_DATA2	28	27	LVDSB_DATA3
LVDSB_DATA2#	30	29	LVDSB_DATA3#
GND	32	31	GND
LVDSA_CLK	34	33	LVDSB_CLK
LVDSA_CLK#	36	35	LVDSB_CLK#
GND	38	37	GND
+12V	40	39	+12V

2.4.20 USB connector 8 & 9/ 10 & 11 (JUSB45/ JUSB67)

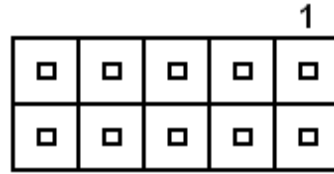
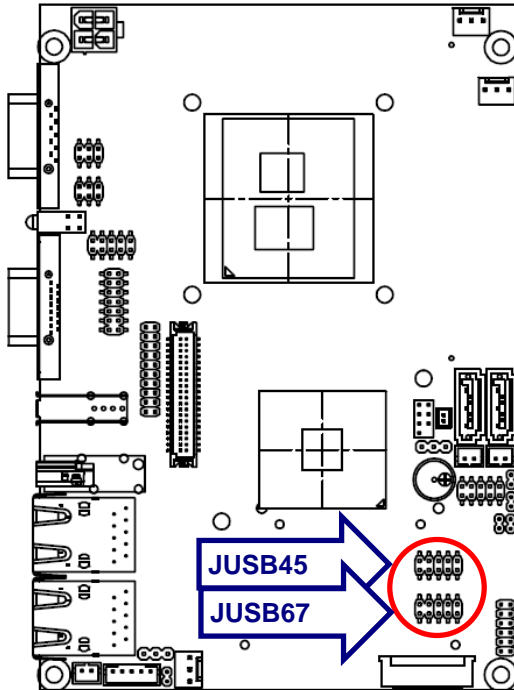

Signal	PIN	PIN	Signal
+5V	1	2	GND
N8/ N10	3	4	GND
P8/ P10	5	6	P9/ P11
GND	7	8	N9 N11
GND	9	10	+5V

2.4.21 Power connector (PWRCON1)

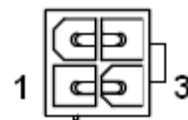
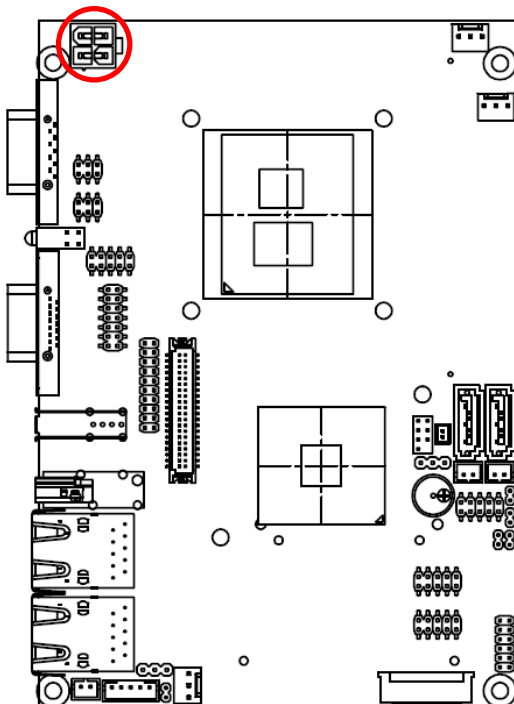

Signal	PIN	PIN	Signal
GND	2	4	VIN
GND	1	3	VIN

## 2.5 Audio / USB Daughter Board User's Guide

### 2.5.1 Jumper and Connector Layout

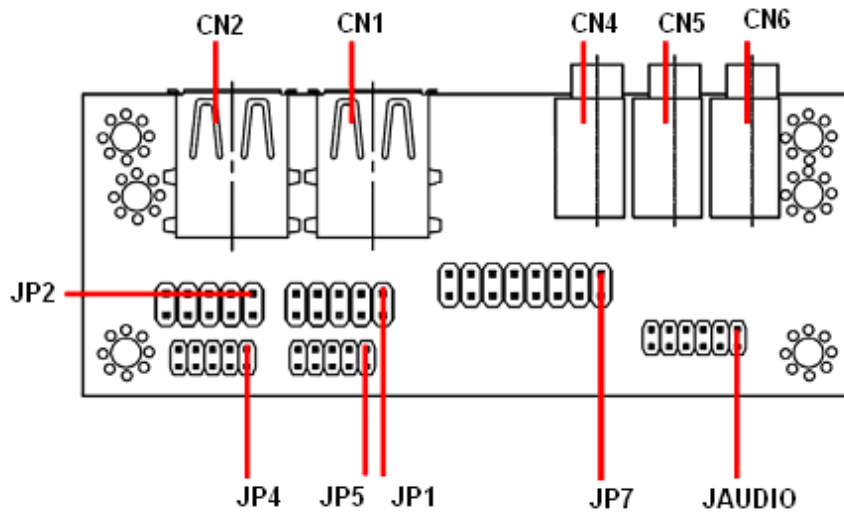

### 2.5.2 Jumper and Connector List

#### Connectors

Label	Function	Note
<b>CN1, CN2</b>	USB connector	
<b>CN4</b>	Line out connector	Phone Jack
<b>CN5</b>	Line in connector	Phone Jack
<b>CN6</b>	Mic in connector	Phone Jack
<b>JAUDIO</b>	Audio connector	6 x 2 header, pitch 2.0mm
<b>JP1</b>	2.54mm USB connector	5 x 2 header, pitch 2.54mm
<b>JP2</b>	2.54mm USB connector	5 x 2 header, pitch 2.54mm
<b>JP4</b>	2.0mm USB connector	5 x 2 header, pitch 2.0mm
<b>JP5</b>	2.0mm USB connector	5 x 2 header, pitch 2.0mm
<b>JP7</b>	TV / Audio connector	8 x 2 header, pitch 2.54mm

### 2.5.3 Setting Jumper and Connector

#### Audio Connector (JAUDIO)

Signal	PIN	PIN	Signal
OUTR	1	2	OUTL
GND	3	4	GND
INR1	5	6	INL1
MICIN1	7	8	AREF
FRONT-JD1	9	10	LINE1-JD1
MIC1-JD1	11	12	GND

#### 2.54mm USB Connector (JP1)

Signal	PIN	PIN	Signal
+5V	1	2	GND
D1-	3	4	GND
D1+	5	6	D2+
GND	7	8	D2-
GND	9	10	+5V



**Note:** Wrong USB cable configuration with your USB devices might cause your USB devices damaged.

#### 2.54mm USB Connector (JP2)

Signal	PIN	PIN	Signal
+5V	1	2	GND
D3-	3	4	GND
D3+	5	6	D4+
GND	7	8	D4-
GND	9	10	+5V

#### TV / Audio Connector (JP7)

Signal	PIN	PIN	Signal
Mic In	1	2	Mic Bais
GND	3	4	GND
Line out L	5	6	Line out R
SPK L	7	8	SPK R
Line in L	9	10	Line in R
GND	11	12	NC
TVGND	13	14	NC
TVGND	15	16	COMP

#### 2.0mm USB Connector (JP4)

Signal	PIN	PIN	Signal
+5V	1	2	GND
D3-	3	4	GND
D3+	5	6	D4+
GND	7	8	D4-
GND	9	10	+5V

#### 2.0mm USB Connector (JP5)

Signal	PIN	PIN	Signal
+5V	1	2	GND
D1-	3	4	GND
D1+	5	6	D2+
GND	7	8	D2-
GND	9	10	+5V

# 3. BIOS Setup

---

### 3.1 Introduction

The BIOS setup program allows users to modify the basic system configuration. In this following chapter will describe how to access the BIOS setup program and the configuration options that may be changed.

### 3.2 Starting Setup

The AMI BIOS™ is immediately activated when you first power on the computer. The BIOS reads the system information contained in the CMOS and begins the process of checking out the system and configuring it. When it finishes, the BIOS will seek an operating system on one of the disks and then launch and turn control over to the operating system.

While the BIOS is in control, the Setup program can be activated in one of two ways:

By pressing <Del> immediately after switching the system on, or

By pressing the <Del> key when the following message appears briefly at the bottom of the screen during the POST (Power On Self Test).

**Press DEL to enter SETUP**

If the message disappears before you respond and you still wish to enter Setup, restart the system to try again by turning it OFF then ON or pressing the "RESET" button on the system case. You may also restart by simultaneously pressing <Ctrl>, <Alt>, and <Delete> keys. If you do not press the keys at the correct time and the system does not boot, an error message will be displayed and you will again be asked to.

**Press F1 to Continue, DEL to enter SETUP**

### 3.3 Using Setup

In general, you use the arrow keys to highlight items, press <Enter> to select, use the PageUp and PageDown keys to change entries, press <F1> for help and press <Esc> to quit. The following table provides more detail about how to navigate in the Setup program using the keyboard.

Button	Description
↑	Move to previous item
↓	Move to next item
←	Move to the item in the left hand
→	Move to the item in the right hand
Esc key	Main Menu -- Quit and not save changes into CMOS Status Page Setup Menu and Option Page Setup Menu -- Exit current page and return to Main Menu
PgUp key	Increase the numeric value or make changes
PgDn key	Decrease the numeric value or make changes
+ key	Increase the numeric value or make changes
- key	Decrease the numeric value or make changes
F1 key	General help, only for Status Page Setup Menu and Option Page Setup Menu
(Shift) F2 key	Change color from total 16 colors. F2 to select color forward, (Shift) F2 to select color backward
F3 key	Calendar, only for Status Page Setup Menu
F4 key	Reserved
F5 key	Restore the previous CMOS value from CMOS, only for Option Page Setup Menu
F6 key	Load the default CMOS value from BIOS default table, only for Option Page Setup Menu
F7 key	Load the default
F8 key	Reserved
F9 key	Reserved
F10 key	Save all the CMOS changes, only for Main Menu

- **Navigating Through The Menu Bar**

Use the left and right arrow keys to choose the menu you want to be in.



**Note:** Some of the navigation keys differ from one screen to another.

- **To Display a Sub Menu**

Use the arrow keys to move the cursor to the sub menu you want. Then press <Enter>. A “➤” pointer marks all sub menus.



### 3.4 Getting Help

Press F1 to pop up a small help window that describes the appropriate keys to use and the possible selections for the highlighted item. To exit the Help Window press <Esc> or the F1 key again.

### 3.5 In Case of Problems

If, after making and saving system changes with Setup, you discover that your computer no longer is able to boot, the AMI BIOS supports an override to the CMOS settings which resets your system to its defaults.

The best advice is to only alter settings which you thoroughly understand. To this end, we strongly recommend that you avoid making any changes to the chipset defaults. These defaults have been carefully chosen by both Award and your systems manufacturer to provide the absolute maximum performance and reliability. Even a seemingly small change to the chipset setup has the potential for causing you to use the override.

## 3.6 BIOS setup

Once you enter the AMI BIOS CMOS Setup Utility, the Main Menu will appear on the screen. The Main Menu allows you to select from several setup functions and exit choices. Use the arrow keys to select among the items and press <Enter> to accept and enter the sub-menu.

### 3.6.1 Main Menu

This section allows you to record some basic hardware configurations on your computer and set the system clock.



#### 3.6.1.1 System Language

This option allows choosing the system default language.

#### 3.6.1.2 System Date

Use the system time option to set the system time. Manually enter hours, minutes and seconds.

#### 3.6.1.3 System Time

Use the system Date option to set the system date. Manually enter the day, month and year.



**Note:** The BIOS setup screens shown in this chapter are for reference purposes only, and may not exactly match what you see on your screen. Visit the Avalue website ([www.avalue.com.tw](http://www.avalue.com.tw)) to download the latest product and BIOS information.

### 3.6.2 Advanced Menu

This section allows you to configure your CPU and other system devices for basic operation through the following sub-menus.

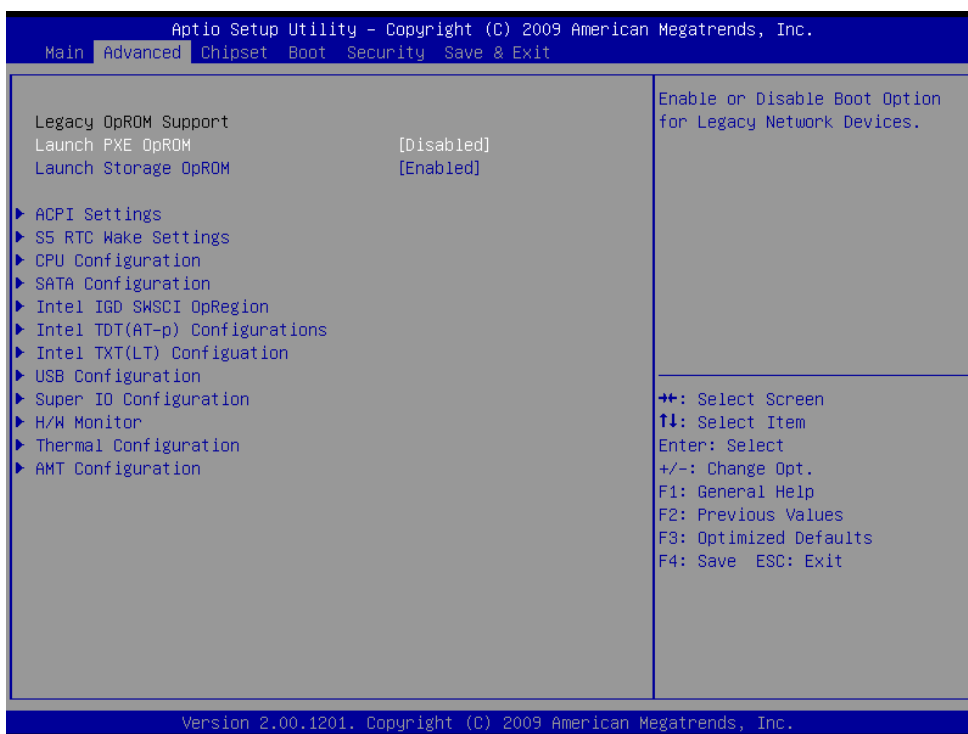

Item	Options	Description
Launch PXE OpROM	Disabled, Enabled	Enable or disable Boot Option for Legacy Network Devices
Launch Storage OpROM	Disabled, Enabled	Enable or disable Boot Option for Legacy Mass storage devices With Option ROM.

3.6.2.1 ACPI Settings

You can use this item to set up ACPI Configuration.

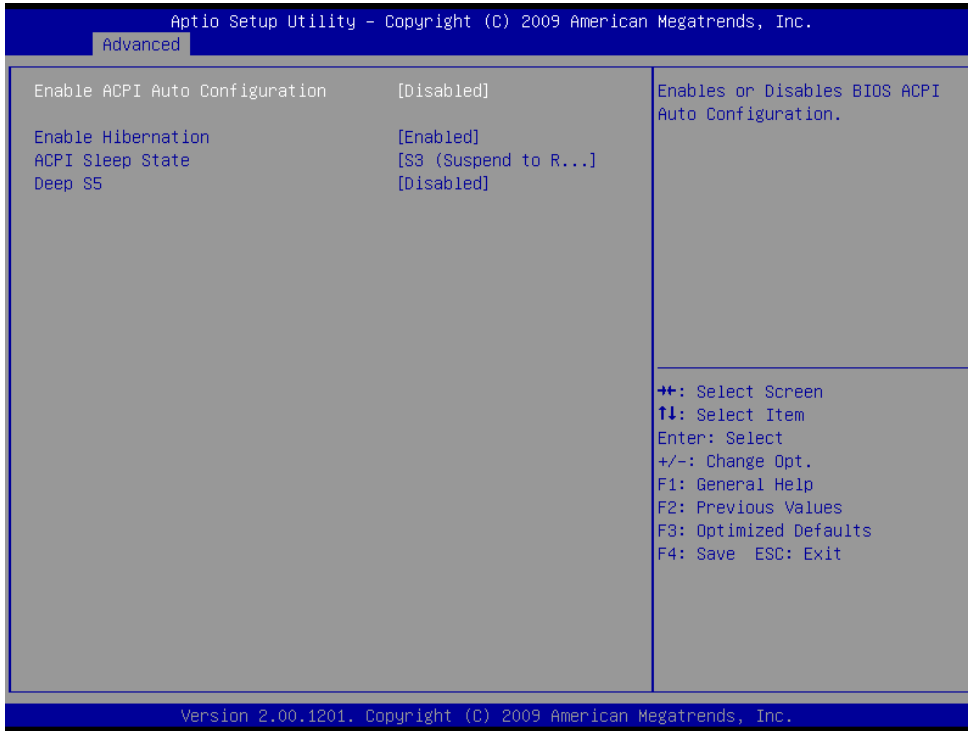

Item	Options	Description
<b>Enable ACPI Auto Configuration</b>	Disabled, Enabled	Enables or Disables BIOS ACPI Auto Configuration.
<b>Enable Hibernation</b>	Disabled, Enabled	Enables or Disables System ability to Hibernate (OS/S4 Sleep State). This option may be not effective with some OS.
<b>ACPI Sleep State</b>	Suspend Disable, S1 (CUP Stop Clock), S3 (Suspend to RAM)	Select the highest ACPI sleep state the system will enter, when the SUSPEND button is pressed.
<b>Deep S5</b>	Disabled, Enabled	Enables or Disables deep S5 function.

### 3.6.2.2 S5 RTC Wake Settings

Use the S5 RTC wake setting to set system wake in fixed time.



Item	Options	Description
Wake system with fixed time	Disabled, Enabled	Enables or Disables wake on alarm event. When enabled, system will wake on the specified hr:min::sec.

### 3.6.2.3 CPU Configuration

Use the CPU configuration menu to view detailed CPU specification and configure the CPU.

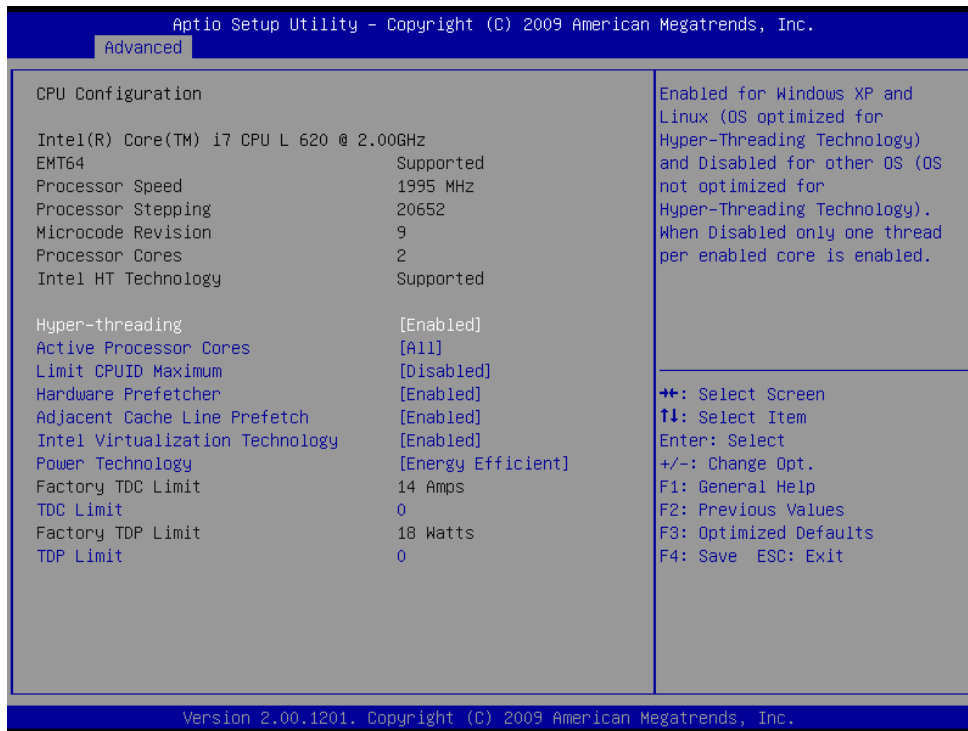

Item	Options	Description
<b>Hyper-threading</b>	Disabled, Enabled	Enabled for Windows XP and Linux (OS optimized for Hyper-Threading Technology) and Disabled for other OS (OS not optimized for Hyper-Threading Technology). When Disabled only one thread per enabled core is enabled.
<b>Active Processor Cores</b>	All, 1, 2	Number of cores to enable in each processor package.
<b>Limit CPUID Maximum</b>	Disabled, Enabled	Disabled for Windows XP.
<b>Hardware Prefetcher</b>	Disabled, Enabled	To turn on/ off the MLC streamer prefetcher.
<b>Adjacent Cache Line Prefetch</b>	Disabled, Enabled	To turn on/ off prefetching of adjacent cache lines.
<b>Intel Virtualization Technology</b>	Disabled, Enabled	When enables, a VMM can utilize the additional hardware capabilities provided by Vanderpool Technology.

<b>Power Technology</b>	Disabled, Energy Efficient, Custom	Enable the power management features.
<b>Factory TDC Limit</b>	Default, Extended user, User, Supervisor	Factory Turbo Mode Current Limit in Amps.
<b>TDC Limit</b>	0	Turbo-XE Mode Processor TDC Limit in 1/8 A granularity. 0 means using the factory-configured value.
<b>Factory TDP Limit</b>	Default, Extended user, User, Supervisor	Factory Turbo Mode Power Limit in Watts.
<b>TDP Limit</b>	0	Turbo-XE Mode Processor TDP Limit in 1/8 W granularity. 0 means using the factory-configured value.

### 3.6.2.4 SATA Configuration

It allows you to select the operation mode for SATA controller.

The choices:

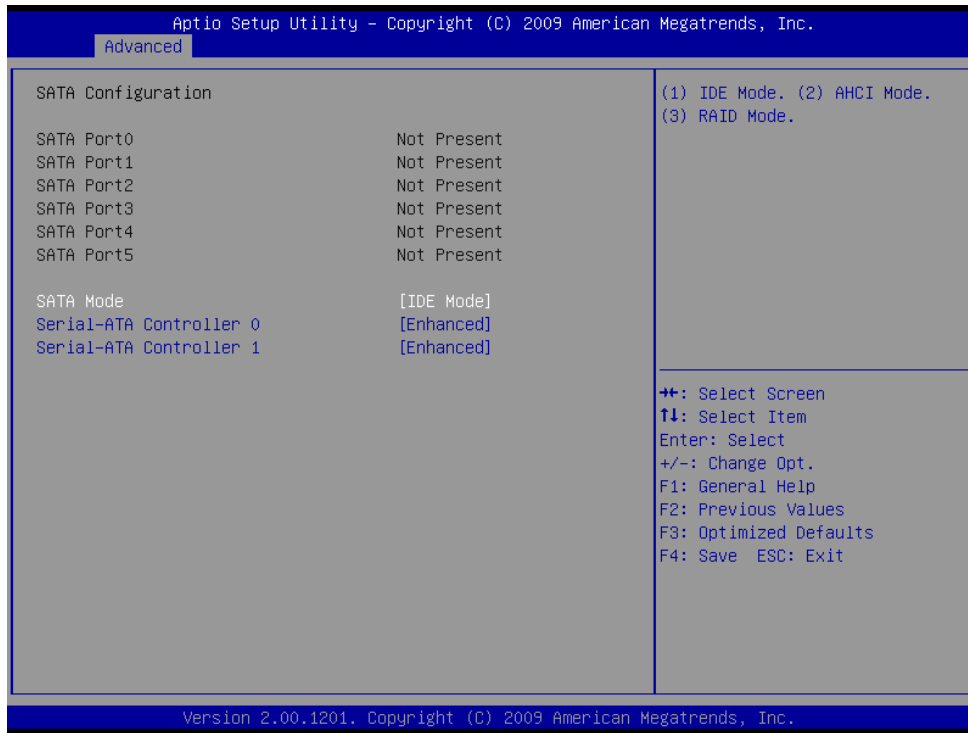

Item	Option	Description
<b>SATA mode</b>	Disabled, IDE mode, AHCI mode, RAID mode	It allows you to select the operation mode for SATA controller.
<b>Serial-ATA Controller 0</b>	Disabled, Enhanced, Compatible	Enabled/ Disabled Serial ATA Controller 0.
<b>Serial-ATA Controller 1</b>	Disabled, Enhanced	Enabled/ Disabled Serial ATA Controller 0.



### 3.6.2.5 Intel IGD SWSCI OpRegion configuration

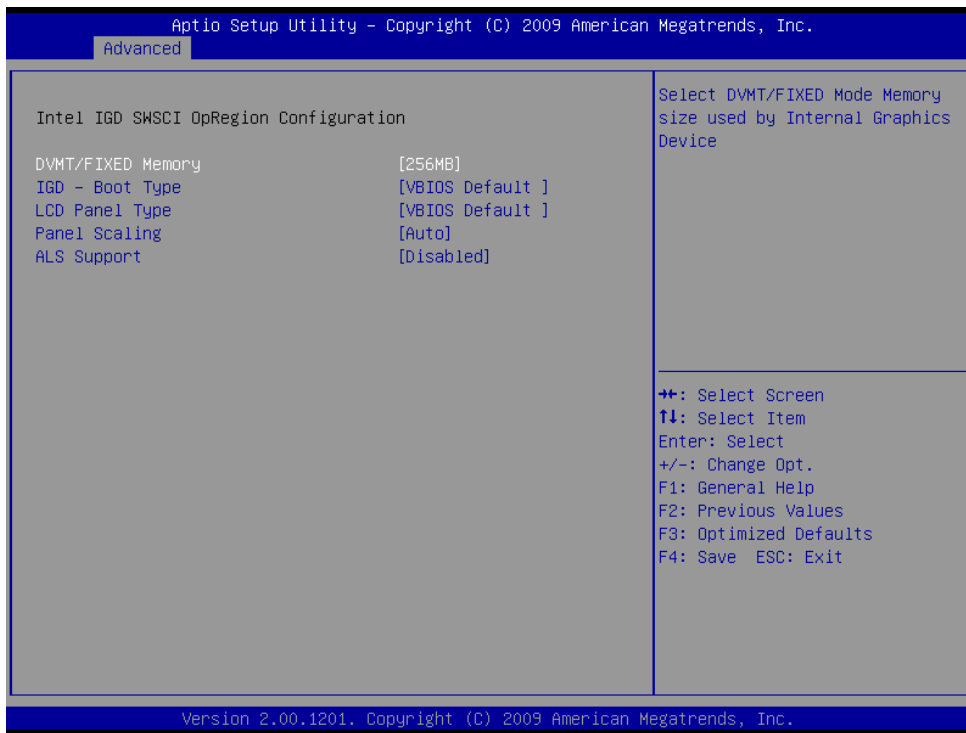

Item	Option	Description
<b>DVMT/ Fixed Memory</b>	256MB, 128MB, Maximum	This feature allows you to select the memory size of DVMT/BOTH operating mode.
<b>IGD – Boot Type</b>	VBIOS Default, CRT, LVDS, CRT+LVDS, HDMI, CRT+HDMI	This feature allows you to select the display device when you boot up the system.
<b>LCD Panel Type</b>	VBIOS Default, 640x480 18/1, 800x600 18/1, 1024x768 18/1, 1280x1024 24/2, 1024x600 18/2, 1400x900 24/2, 1600x1200 18/2, 1280x768 18/1, 1680x1050 24/2, 1920x1080 24/2,	This feature allows you to select Panel Resolution that will be displayed depending on the LCD Panel.

## ECM-QM57

	1024x768 24/1, 1366x768 24/1, 800x400 18/1, 1280x800 18/1, 1280x720 24/1, 2048x1536 24/2	
<b>Panel Scaling</b>	Auto, Force Scaling, Off, Maintain Aspect Ratio.	Select the LCD panel scaling option used by the Internal Graphics Device.
<b>ALS Support</b>	Enabled, Disabled	Valid only for ACPI. Legacy = ALS Support through the IGD INT10 function. ACPI = ALS support through an ACPI ALS Driver.

### 3.6.2.6 Intel TDT (AT-p) Configuration

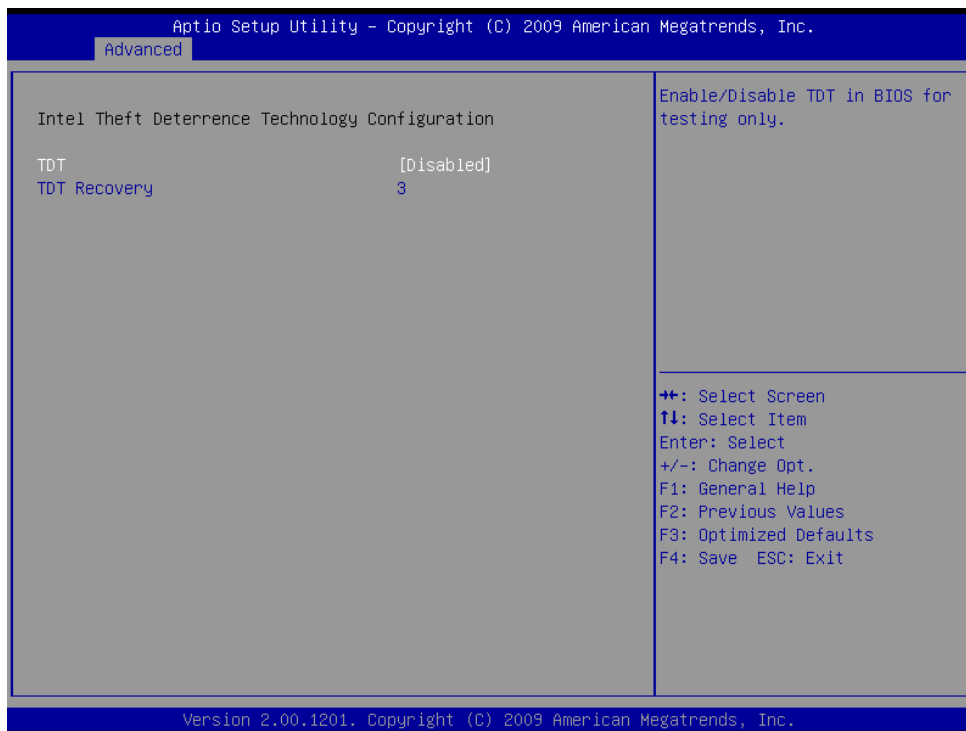

Item	Option	Description
<b>TDT</b>	Enabled, Disabled	Enable/ Disabled TDT in BIOS for testing only.
<b>TDT Recovery</b>	3	Set the number of times Recovery attempts will be allowed.

### 3.6.2.7 Intel TXT (LT) Configuration

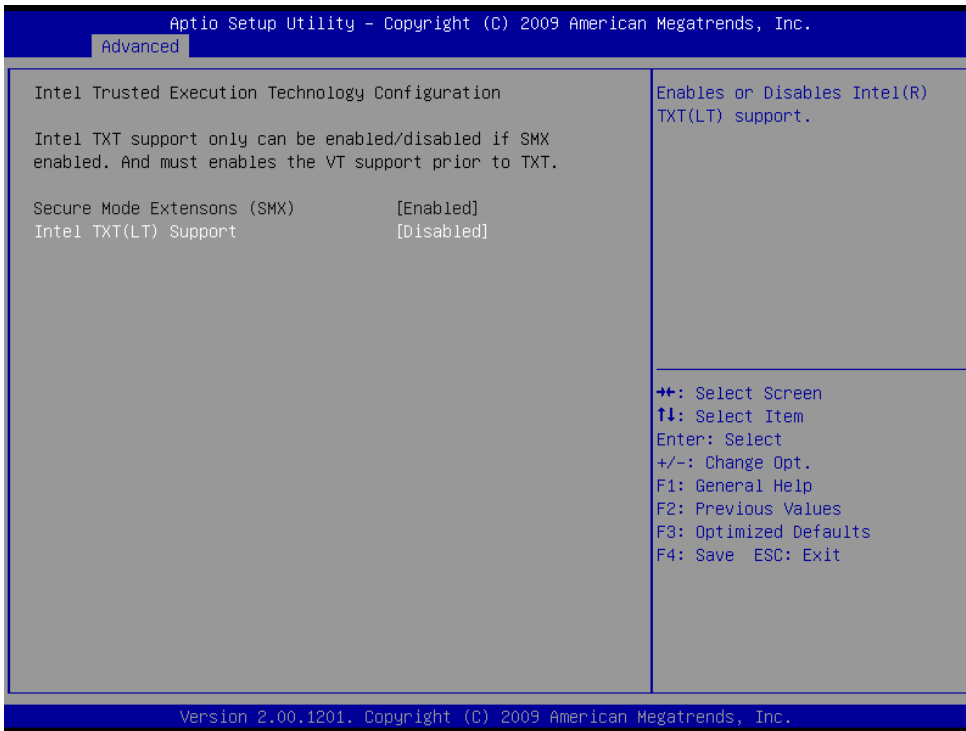

Item	Option	Description
<b>Secure Mode Extensions (SMX)</b>	Enabled, Disabled	Interface for system software to support trust decisions by end user
<b>Intel TXT (LT) Support</b>	Enabled, Disabled	Hardware extension intended to provide a higher level of trust and control.

### 3.6.2.8 USB Configuration

The USB configuration menu is used to read USB configuration information and configure the USB setting.



#### 3.6.2.8.1 Legacy USB support

Use the Legacy USB Support BIOS option to enable USB mouse and USB keyboard support. Normally if this option is not enabled, any attached USB mouse or USB keyboard does not become available until a USB compatible operating system is fully booted with all USB drivers loaded. When this option is enabled, any attached USB mouse or USB keyboard can control the system even when there is no USB driver loaded onto the system. The choices: Enabled, Disabled, Auto

#### 3.6.2.8.2 EHCI hand-off

This is a workaround for OSes without EHCI hand-off support. The EHCI ownership change should be claimed by EHCI driver.

The Choices: Enabled, Disabled

#### 3.6.2.8.3 Device Reset timeout

USB mass storage device start Unit command timeout.

The options are: 10, 20, 30, 40 sec.

### 3.6.2.8.4 Controller Timeout

The timeout values to control bulk interrupt transfer.

The options are: 1, 5, 10, 20 sec.

### 3.6.2.8.5 Mass Storage Devices

This item allows you to set up mass storage devices.

The choices: USB 2.0 Flash Disk 1100.

### 3.6.2.9 H/W Monitor

The H/W Monitor shows the operating temperature, fan speeds and system voltages.

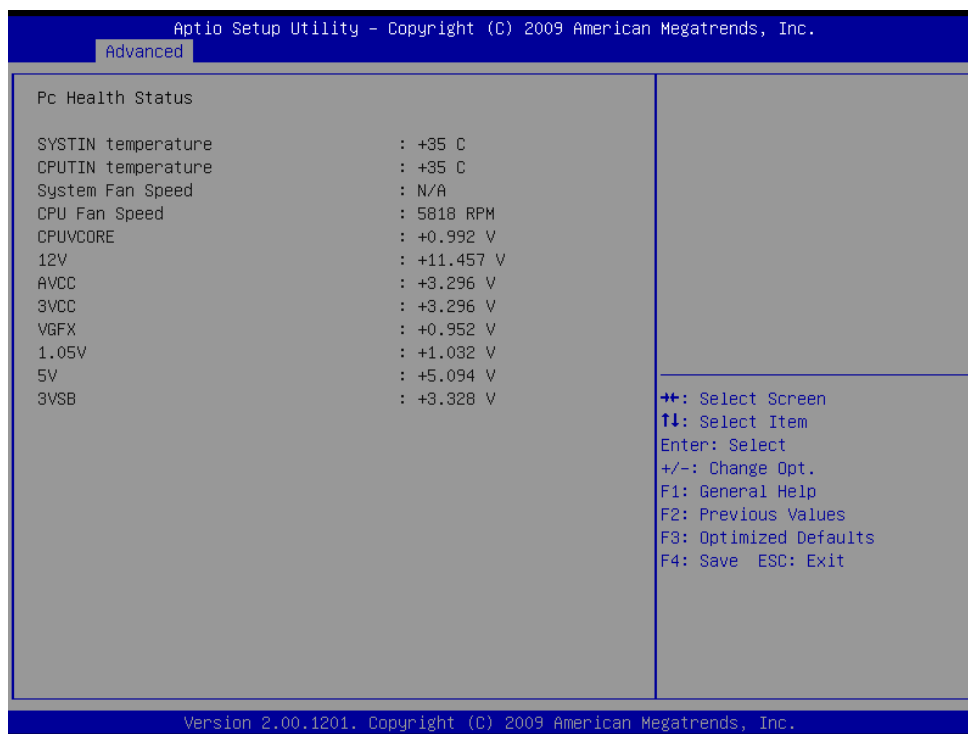

#### Temperature

- SYSTIN temperature
- CPUTIN temperature

#### Fan speed

- System Fan speed
- CPU Fan speed

#### Voltage

- CPUVCCORE
- 12V
- AVCC
- 3VCC
- VGFX
- 1.05V
- 5V
- 3VSB

### 3.6.2.10 Super IO Configuration

You can use this item to set up or change the Super IO configuration for FDD controllers, parallel ports and serial ports. Please refer to 3.6.2.10.1 and 3.6.2.10.2 for more information.

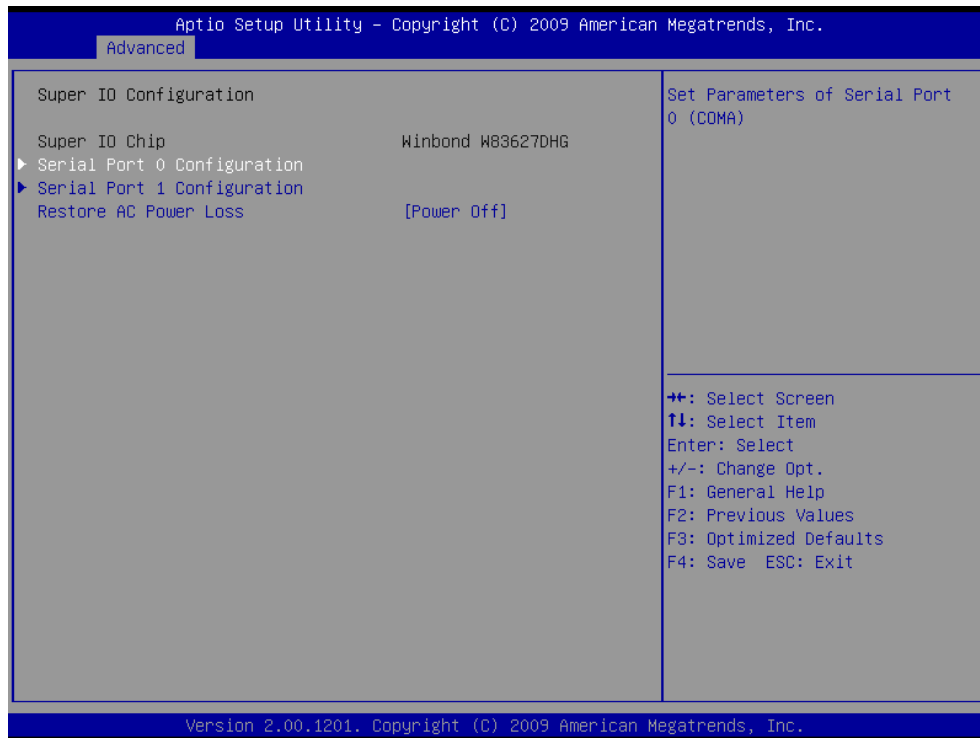

3.6.2.10.1 Serial Port 0 Configuration

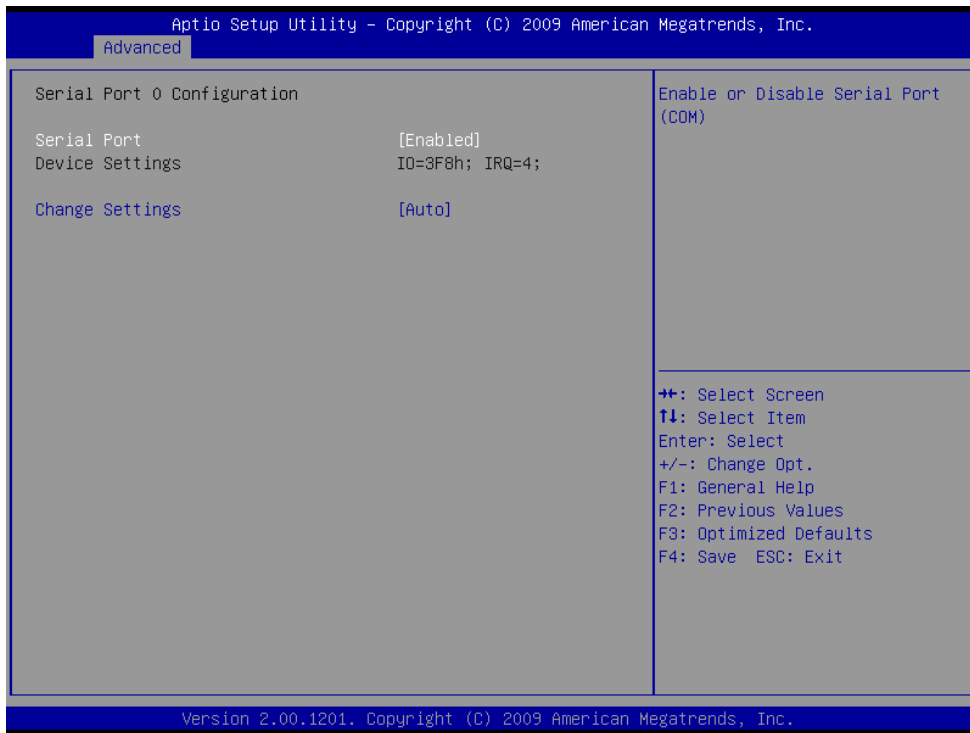

Item	Option	Description
Serial Port	Enabled, Disabled	Use the Serial port option to enable or disable the serial port.
Change Settings	IO=3F8h; IRQ=4, IO=3F8h; IRQ=3,4,5,6,7,10,11,12 IO=2F8h; IRQ=3,4,5,6,7,10,11,12 IO=3E8h; IRQ=3,4,5,6,7,10,11,12 IO=2E8h; IRQ=3,4,5,6,7,10,11,12	Use the change Settings option to change the serial port IO port address and interrupt address.

3.6.2.10.2 Serial Port 1 Configuration

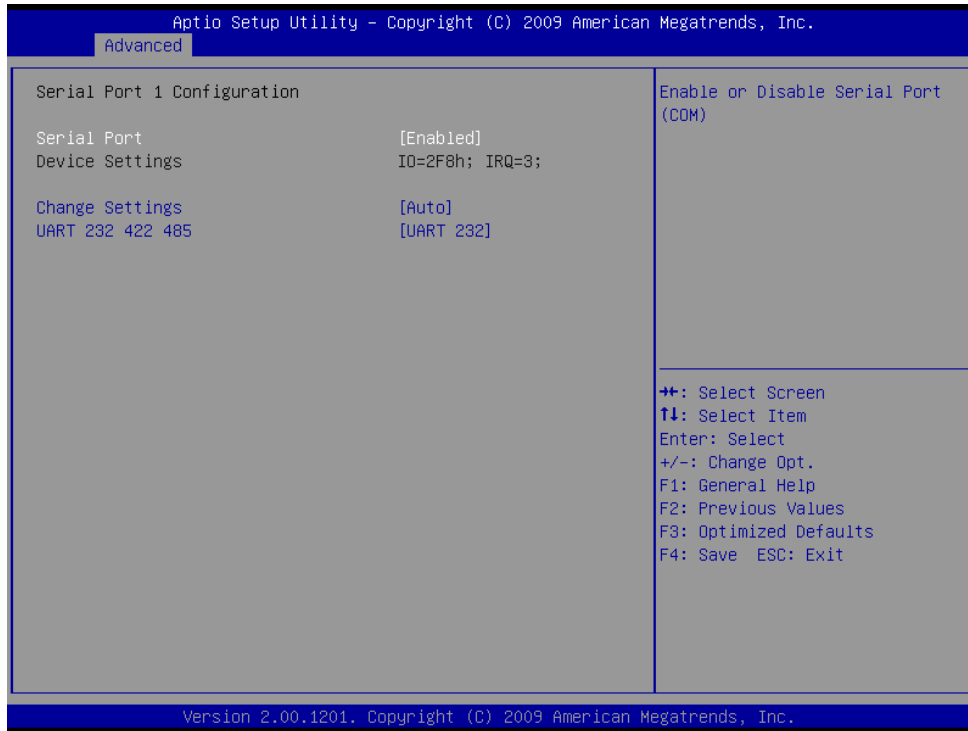

Item	Option	Description
<b>Serial Port</b>	Enabled, Disabled	Use the Serial port option to enable or disable the serial port.
<b>Change Settings</b>	IO=3F8h; IRQ=4, IO=3F8h; IRQ=3,4,5,6,7,10,11,12 IO=2F8h; IRQ=3,4,5,6,7,10,11,12 IO=3E8h; IRQ=3,4,5,6,7,10,11,12 IO=2E8h; IRQ=3,4,5,6,7,10,11,12	Use the change Settings option to change the serial port IO port address and interrupt address.
<b>UART 232 422 485</b>	UART 232, UART 422, UART485	Change the Serial Port as RS232/ 422/ 485.



### 3.6.2.11 Thermal Configuration

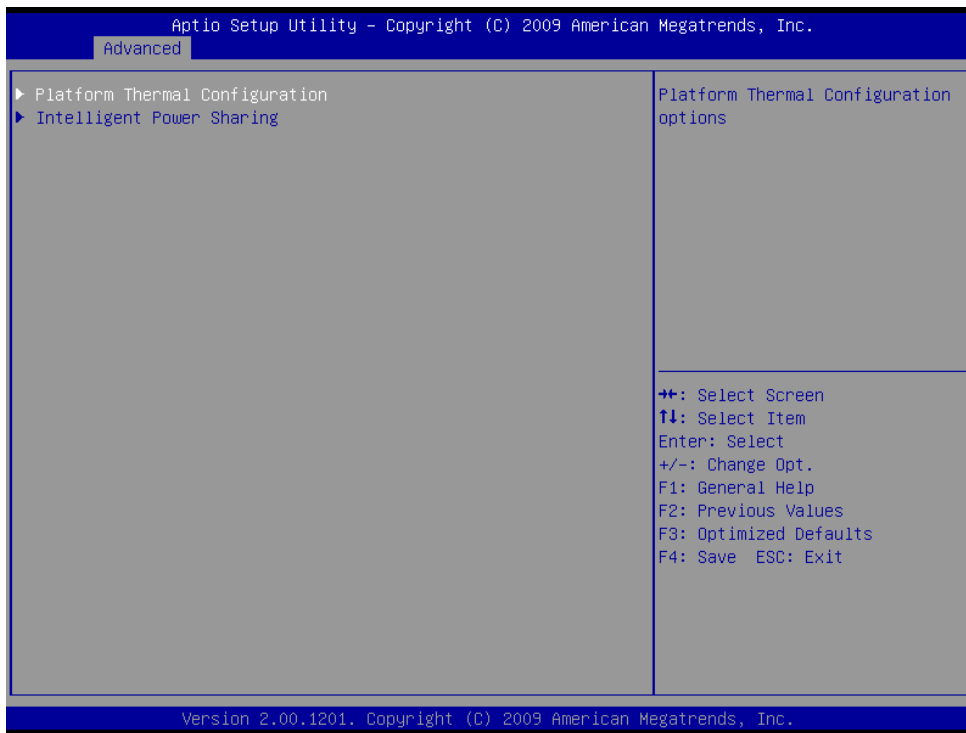

#### 3.6.2.11.1 Platform thermal Configuration

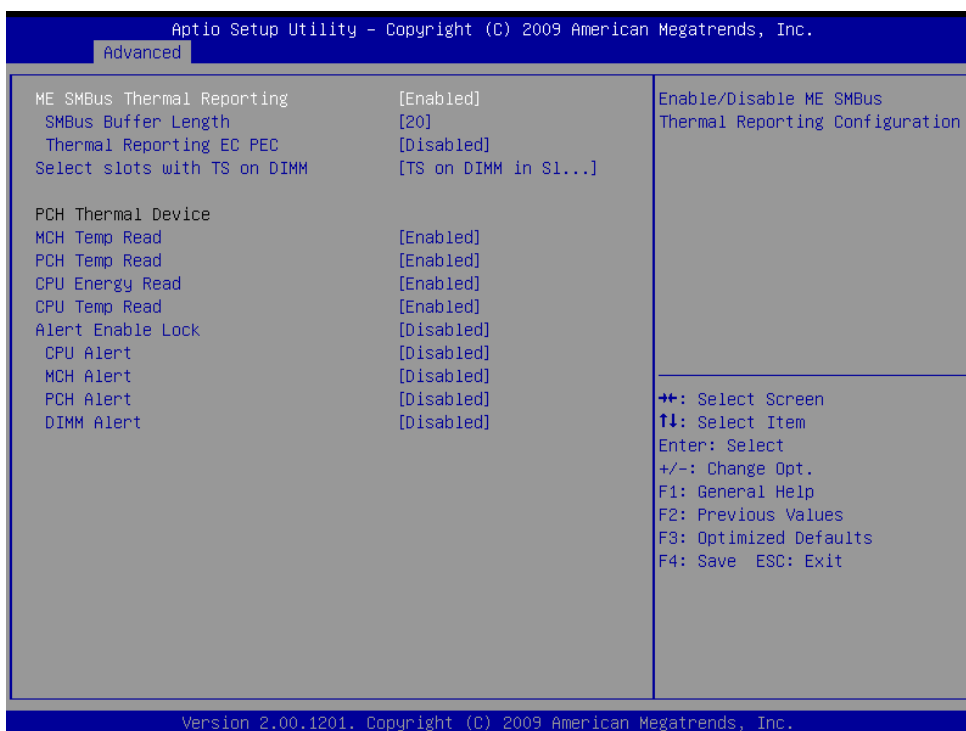

Item	Option	Description
<b>ME SMBus Thermal Reporting</b>	Disabled, Enabled	Enabled/ Disabled ME SMBus Thermal Reporting Configuration.
<b>SMBus Buffer Length</b>	1, 2, 5, 9, 10, 14, 20	SMBus Block Read message length for EC.
<b>Thermal Reporting EC PEC</b>	Disabled, Enabled	Enable Packet Error Checking (PEC) for SMBus Block Read.
<b>Select slots with TS on DIMM</b>	No TS on DIMM, TS on DIMM in Slot SODIMM0, TS on DIMM in Slot SODIMM1, TS on DIMM in Slot SODIMM0 and SODIMM1	Enable temperature reporting for slots with TS on DIMM. NOTE: SODIMM0 is one of the one closer to CUP.
<b>MCH Temp Read</b>	Disabled, Enabled	MCH Temperature Read Enabled.
<b>PCH Temp Read</b>	Disabled, Enabled	PCH Temperature Read Enabled.
<b>CPU Energy Read</b>	Disabled, Enabled	CPU Energy Read Enabled.
<b>CPU Temp Read</b>	Disabled, Enabled	CPU Temperature Read Enabled.
<b>Alert Enable Lock</b>	Enabled, Disabled	Lock all Alert Enable settings.
<b>CPU Alert</b>	Enabled, Disabled	CPU Alert pin enabled.
<b>MCH Alert</b>	Enabled, Disabled	MCH Alert pin enabled..
<b>PCH Alert</b>	Enabled, Disabled	PCH Alert pin enabled.
<b>DIMM Alert</b>	Enabled, Disabled	DIMM Alert pin enabled.

**3.6.2.11.2 Intelligent Power Sharing**

Intelligent Power Sharing configuration menu. (NOTE: DTS must be enabled for Power Sharing to function.)

The choices: Enabled, Disabled.

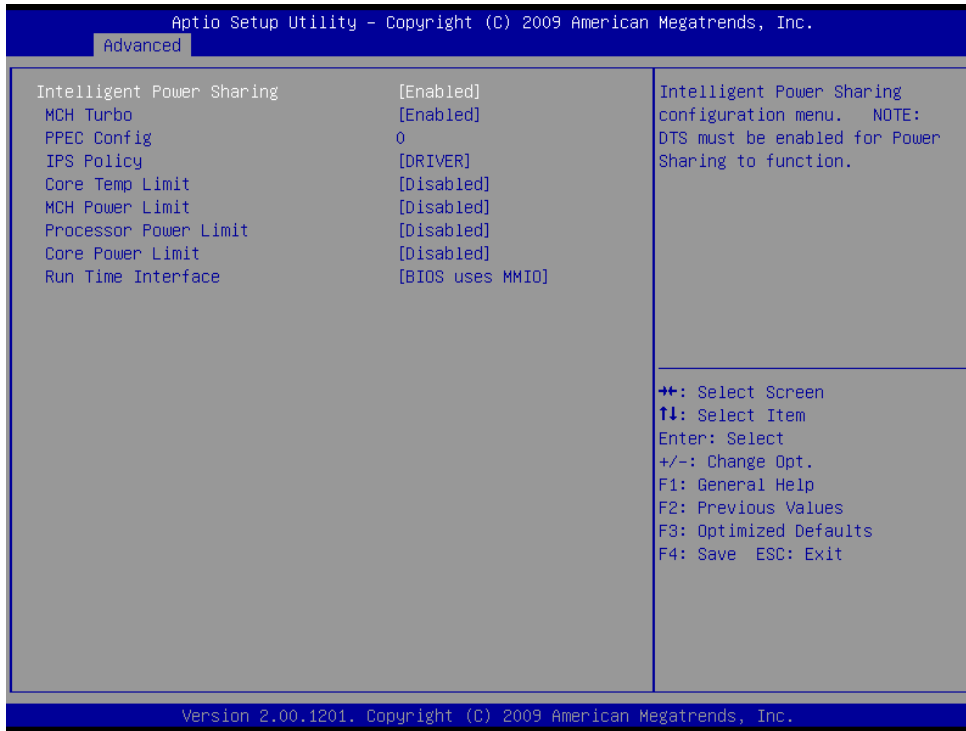

Item	Option	Description
<b>MCH Turbo</b>	Enabled, Disabled	Enable or disable MCH Turbo.
<b>PPEC Config</b>	0	Processor Power Error Correction.
<b>IPS Policy</b>	DRIVER, PROCESSOR, BALANCED, GRAPHICS	Platform BIOS Policy Preference.
<b>Core Temp Limit</b>	Enabled, Disabled	Core temperature limit.
<b>MCH Power Limit</b>	Enabled, Disabled	Max MCH power clamp.
<b>Processor Power Limit</b>	Enabled, Disabled	Max processor power clamp.
<b>Core Power Limit</b>	Enabled, Disabled	Max core power clamp.
<b>Run Time Interface</b>	EC uses SMBus,	Choose runtime interface for PCH

	BIOS uses MMIO	communication.
--	----------------	----------------

### 3.6.2.12 AMT Configuration

This item allows Advance Power Management configuration

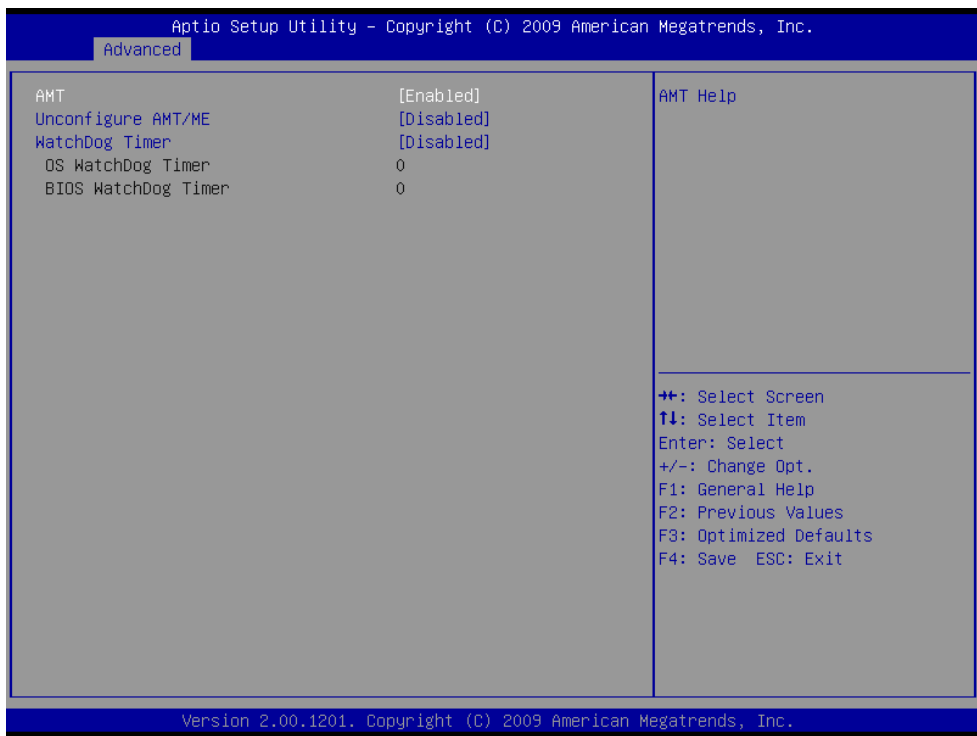

Item	Option	Description
<b>AMT</b>	Enabled, Disabled	Use AMT option to enable/disable the Intel® AMT function.
<b>Unconfigure AMT/ME</b>	Enabled, Disabled	You can use this item to perform AMT/ME unconfigure without password operation.
<b>WatchDog Timer</b>	Enabled, Disabled	This option will determine watch dog timer.

### 3.6.3 Advanced Chipset Features

This setting configures the north bridge, south bridge and ME subsystem.

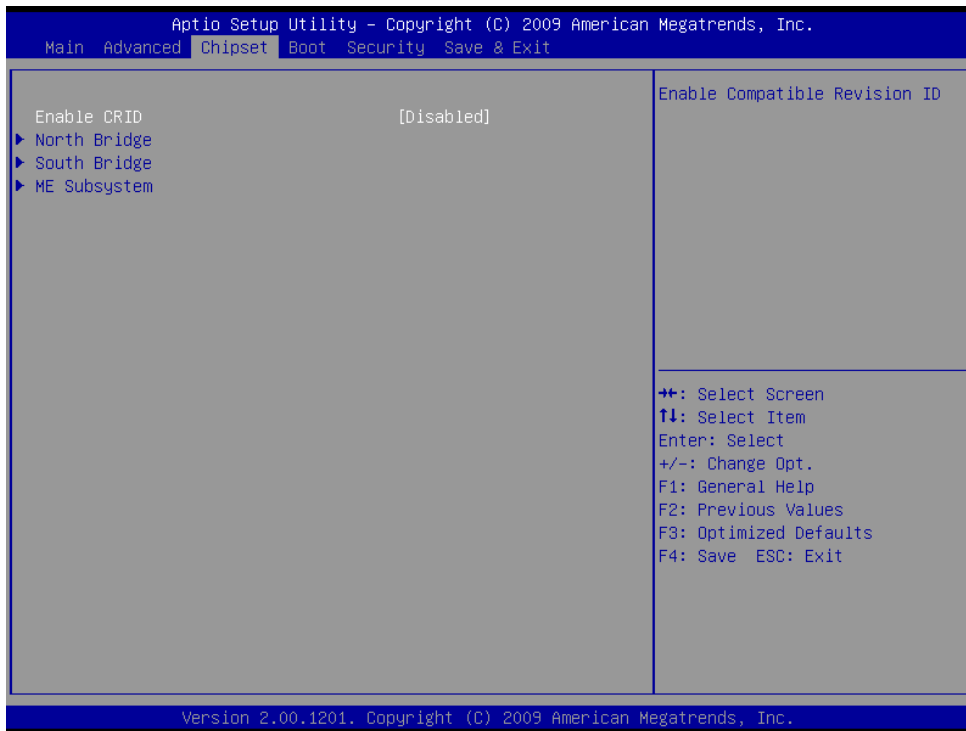

Item	Option	Description
Enable CRID	Enable	Enable/disabled Compatible Revision ID
	Disabled	

3.6.3.1 North Bridge

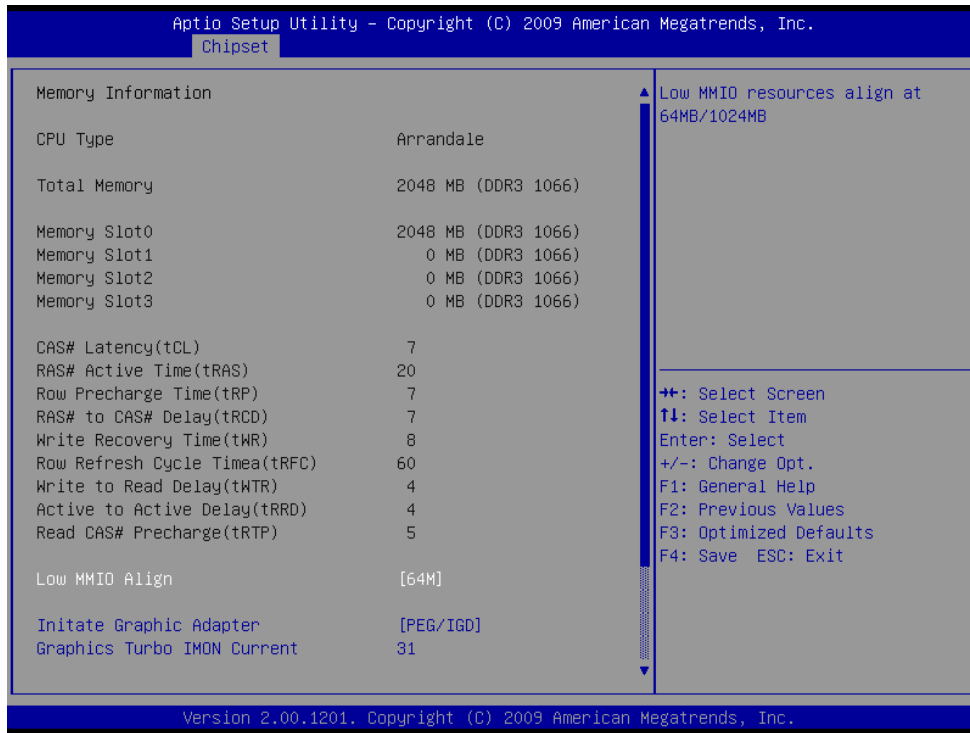

Item	Option	Description
<b>Low MMIO Align</b>	64M, 1024M	This option will determine Low MMIO resources align.
<b>Initiate Graphic Adapter</b>	IGD, PCI/IGD, PCI/PEG, PEG/IGD, PEG/PCI	This item allows you to select which graphics controller to use as the primary boot device.
<b>Graphics Turbo IMON Current</b>	Min= 14, Max= 31	Graphics turbo IMON current values supported.

### 3.6.3.2 South Bridge

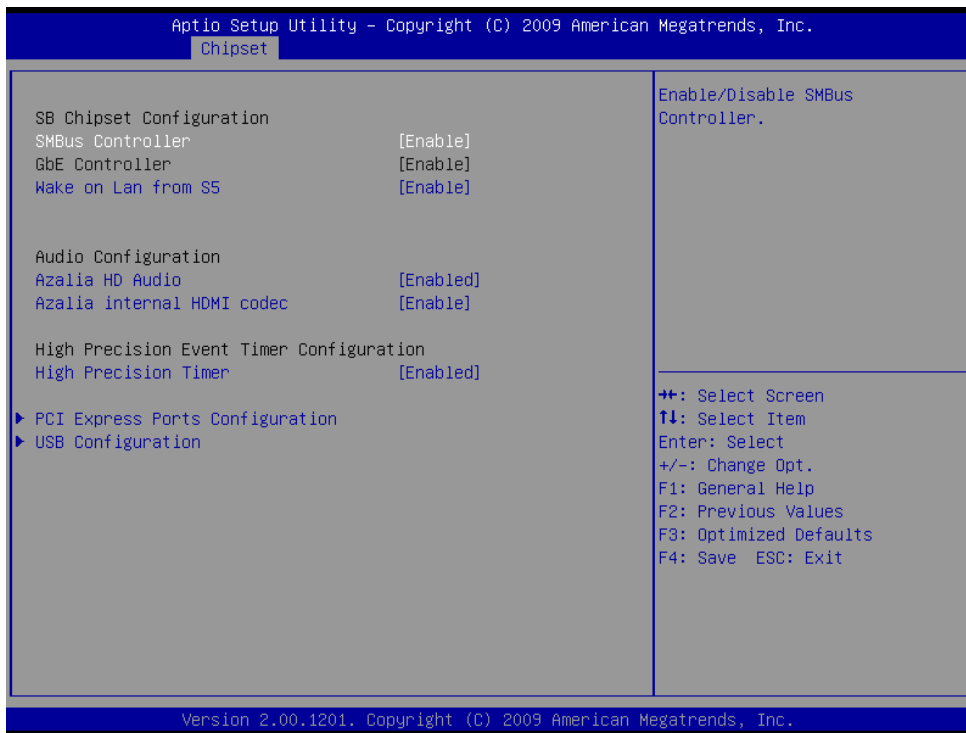

Item	Option	Description
<b>SMBus Controller</b>	Enabled, Disabled	SMBus Controller help.
<b>GbE Controller</b>	Enabled, Disabled	GbE Controller help.
<b>Wake on Lan from S5</b>	Enabled, Disabled	Wake on Lan from S5 help.
<b>Azalia HD Audio</b>	Enabled, Disabled	Use the Azalia HD Audio option to enable or disable the High Definition Audio controller.
<b>Azalia internal HDMI codec</b>	Enabled, Disabled	Enable/ Disable internal HDMI codec for Azalia.
<b>High Precision Timer</b>	Enable, Disabled	This item helps to enable or disable high precision timer.

**3.6.3.2.1 PCI Express Ports Configuration**

For the PCI Express root ports, the assignment of a function number to a root port is not fixed. This item allows you to re-assign the function numbers on a port by port basis. You can disable/hide any root port and still have functions 0 thru N-1 where N is the total number of enabled root ports.

The choices: Disable, Enabled, Auto.





### 3.6.3.2.2 USB Configuration

The USB Configuration menu is used to read USB configuration information and configure the USB settings.

Options are: Disabled, Enabled.

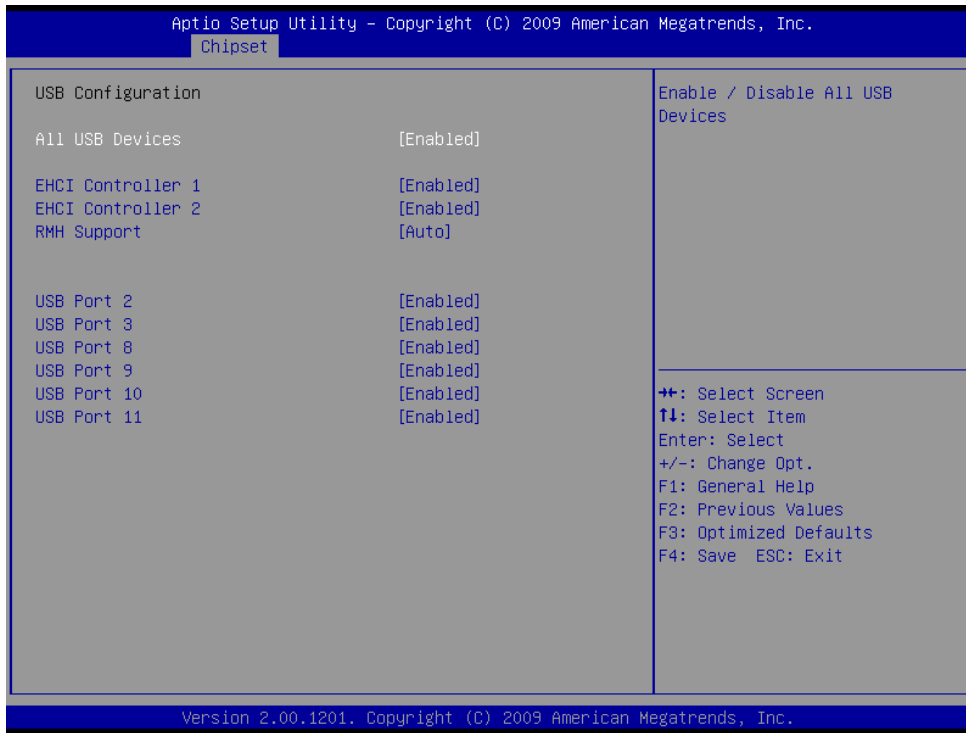

Item	Option	Description
<b>EHCI controller 1/2</b>	Enabled	Enabled/Disabled USB 2.0 (EHCI)
	Disabled	
<b>RMH support</b>	Enabled	Enabled/Disabled RMH Support; AUTO: Enable RMH support on Ibx Peak Bx stepping or above
	Disabled	
	Auto	
<b>USB Port 2/3/8/9/10/11</b>	Enabled	To enable or disable USB Ports
	Disabled	

**3.6.3.3 ME Subsystem**

Use the ME Subsystem menu to configure the Intel® Management Engine (ME) configuration options.

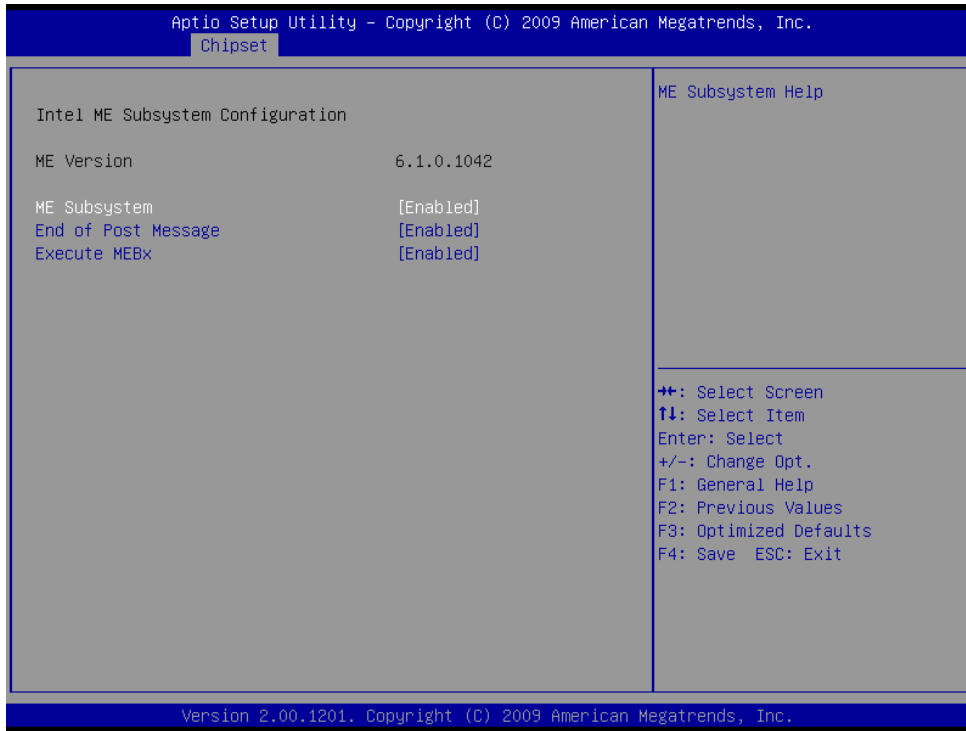

Item	Option	Description
<b>ME Subsystem</b>	Enabled, Disabled	Use the ME Subsystem option to enable or disable the Intel® ME subsystem.
<b>End of Post Message</b>	Enabled, Disabled	Use the End of Post Message option to enable or disable the end of post message of the ME Subsystem.
<b>Execute MEBx</b>	Enabled, Disabled	Use the Execute MEBx option to enable or disable the Intel® Management Engine BIOS extension (MEBx).

### 3.6.4 Boot

Use Boot menu to set system boot options.

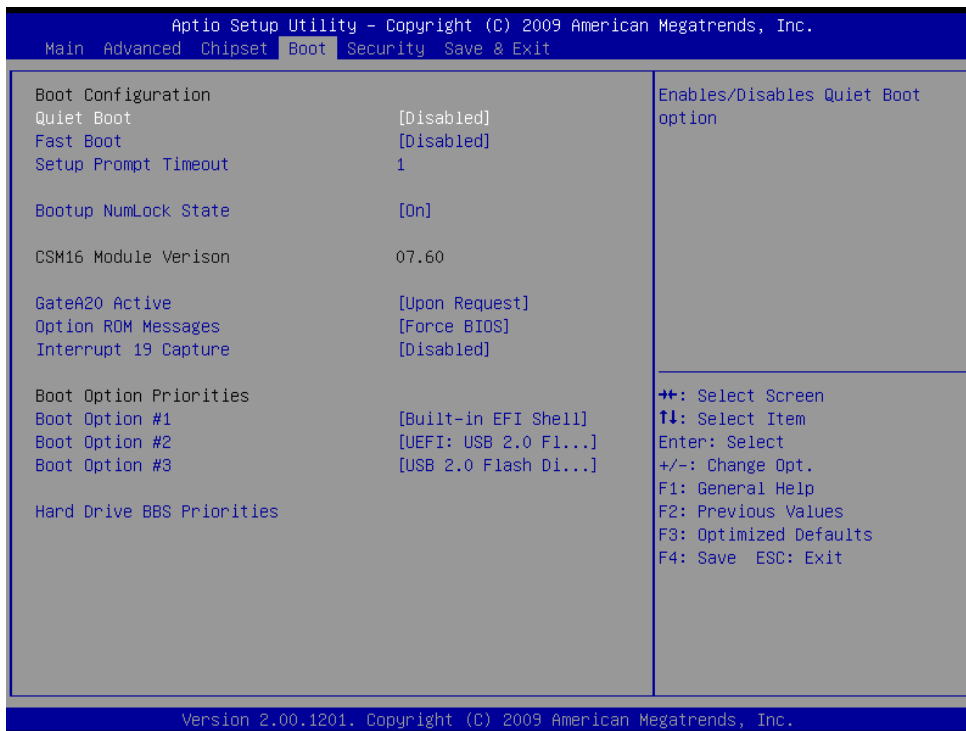

Item	Option	Description
<b>Quiet Boot</b>	Enabled, Disabled	This item can help to select the screen display when the system boots.
<b>Fast Boot</b>	Enabled, Disabled	Enabled/ Disabled boot with initialization of a minimal set of devices required to launch active boot option. Has no effect for BBS boot options.
<b>Setup Prompt Timeout</b>	1	Number of seconds to wait for setup activation key. 65535(0xFFFF) means indefinite waiting.
<b>Bootup NumLock State</b>	On, Off	Select the keyboard NumLock state.
<b>GateA20 Active</b>	Upon Request, Always	UPON REQUEST – GA20 can be disabled using BIOS services. ALWAYS – do not allow disabling GA20; this option is useful when any RT code is executed above 1MB.
<b>Option ROM Messages</b>	Force BIOS, Keep Current	Set display mode for Option ROM.
<b>Interrupt 19 Capture</b>	Enabled, Disabled	Enabled: Allows Option ROMs to trap int 19.

## ECM-QM57

<b>Boot option 1/2/3</b>	These settings specify the boot priority of hard drive devices. The highest priority device is displayed on the main Boot Option Priorities list.
<b>Hard drive BBS priorities</b>	Use this setting to access the Hard Drive BBS Priorities submenu to re-order or disable bootable hard drive devices.

### 3.6.5 Security

Use the Security menu to set system and user password.



#### 3.6.5.1 Administrator Password

This setting specifies a password that must be entered to access the BIOS Setup Utility. If only the Administrator's password is set, then this only limits access to the BIOS setup program and is only asked for when entering the BIOS setup program. By default, no password is specified.

#### 3.6.5.2 User Password

This setting specifies a password that must be entered to access the BIOS Setup Utility or to boot the system. If only the User's password is set, then this is a power on password and must be entered to boot or enter the BIOS setup program. In the BIOS setup program, the User will have Administrator rights. By default, no password is specified.

### 3.6.6 Save & Exit

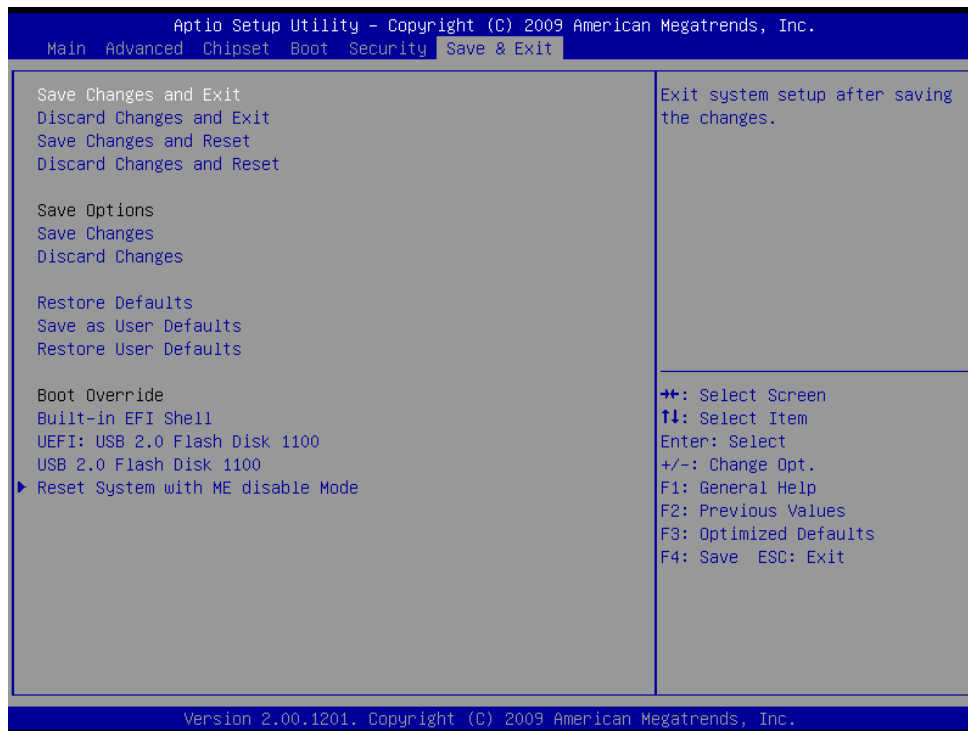

#### 3.6.6.1 Save Changes and Exit

Use the save changes and reset option to save the changes made to the BIOS options and to exit the BIOS configuration setup program.

#### 3.6.6.2 Discard Changes and Exit

Use the Discard changes and Exit option to exit the system without saving the changes made to the BIOS configuration setup program.

#### 3.6.6.3 Save Changes and Reset

Any changes made to BIOS settings are stored in NVRAM. The setup program then exits and reboots the controller.

#### 3.6.6.4 Discard Changes and Reset

Any changes made to BIOS settings during this session of the BIOS setup program are discarded. The setup program then exits and reboots the controller.

#### 3.6.6.5 Save Changes

Changes made to BIOS settings during this session are committed to NVRAM. The setup program remains active, allowing further changes.

### 3.6.6.6 Discard Changes

Any changes made to BIOS settings during this session of the BIOS setup program are discarded. The BIOS setup continues to be active.

### 3.6.6.7 Restore Defaults

This option restores all BIOS settings to the factory default. This option is useful if the controller exhibits unpredictable behavior due to an incorrect or inappropriate BIOS setting.

### 3.6.6.8 Save as user defaults

This option saves a copy of the current BIOS settings as the User Defaults. This option is useful for preserving custom BIOS setup configurations.

### 3.6.6.9 Restore as user defaults

This option restores all BIOS settings to the user defaults. This option is useful for restoring previously preserved custom BIOS setup configurations.

### 3.6.6.10 Boot override

This option lists all possible bootable devices and allows the user to override the **Boot Option Priorities** list for the current boot. If no changes have been made to the BIOS setup options, the system will continue booting to the selected device without first rebooting. If BIOS setup options have been changed and saved, a reboot will be required and the boot override selection will not be valid.

### 3.6.6.11 Reset system with ME disable mode

This option allows or prevents firmware local update in the field. When the “Enabled” option is selected, the IT-admin is able to update the ME locally via the local Management Engine interface or via the local secure interface.. Once the local update is complete, this setting is automatically set to “Disabled”. This option must be set to “Enabled” when a local update is needed.

# 4. Drivers Installation

---



**Note:** Installation procedures and screen shots in this section are for your reference and may not be exactly the same as shown on your screen.

## 4.1 Install Chipset Driver (For Intel QM57)

Insert the Supporting DVD-ROM to DVD-ROM drive, and it should show the index page of Avalue's products automatically. If not, locate Index.htm and choose the product from the menu left, or link to \Driver\_Chipset\Intel\ QM57.



**Note:** The installation procedures and screen shots in this section are based on Windows XP operation system. If the warning message appears while the installation process, click Continue to go on.

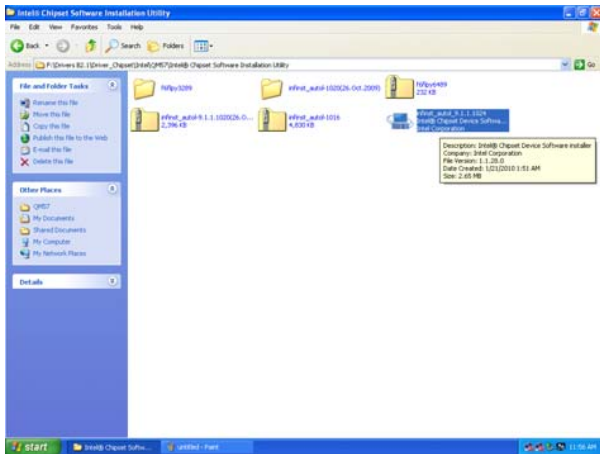

**Step 1.** Locate 「\Driver\_Chipset\Intel\ QM57\ \infinst\_autol.exe」.



**Step 2.** Click **Next**.



**Step 3.** Click **Next**.



**Step 4.** Click **Finish** to complete setup.



## 4.2 Install Display Driver (For Intel QM57)

Insert the Supporting DVD-ROM to DVD-ROM drive, and it should show the index page of Avalue's products automatically. If not, locate Index.htm and choose the product from the menu left, or link to \Driver\_Video\Intel\QM57.



**Note:** The installation procedures and screen shots in this section are based on Windows XP operation system.

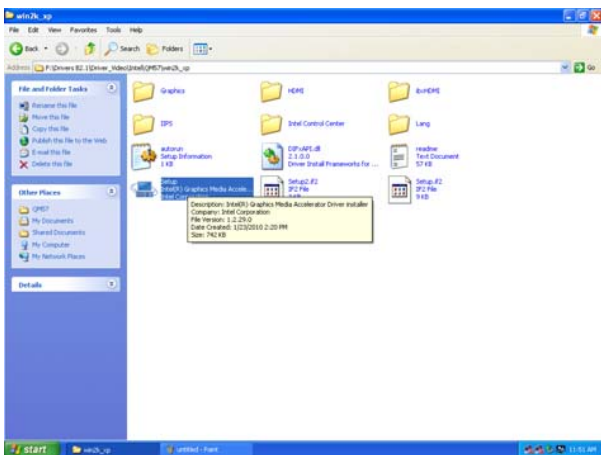

**Step 1.** Locate 「Driver\_Video\Intel\QM57\Setup.exe」.

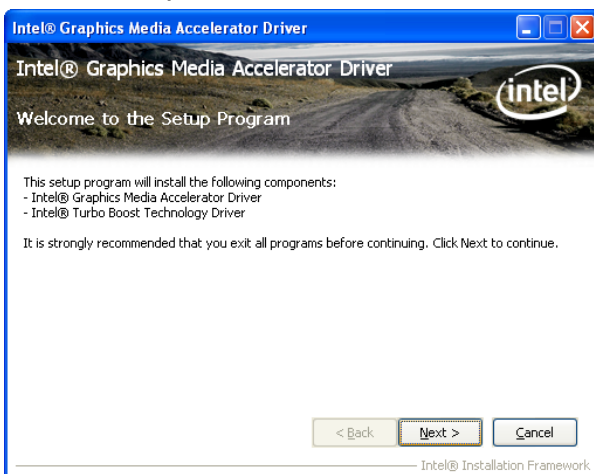

**Step 2.** Click **Next**.

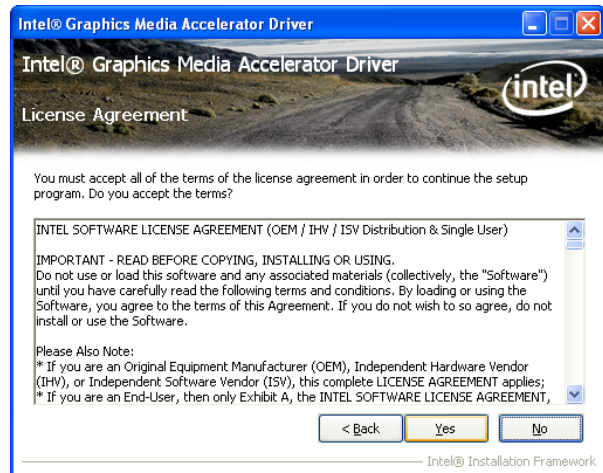

**Step 3.** Click **Yes**.

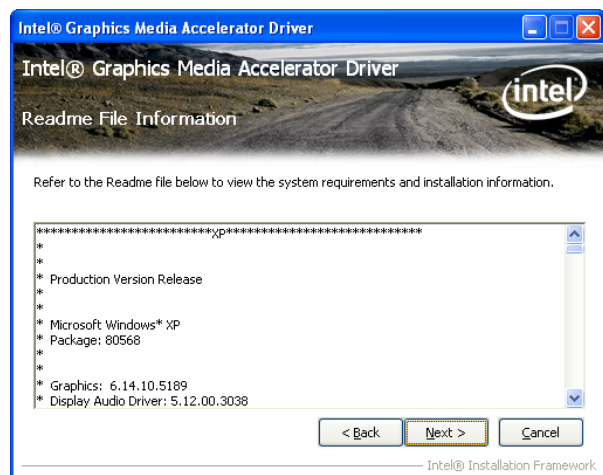

**Step 4.** Click **Next**.



**Step 5.** Click **Finish** to complete setup.

## 4.3 Install Audio Driver (For Realtek ALC888)

Insert the Supporting CD-ROM to CD-ROM drive, and it should show the index page of Avalue's products automatically. If not, locate Index.htm and choose the product from the menu left, or link to \Driver\_Audio\Realtek \ALC888.



**Note:** The installation procedures and screen shots in this section are based on Windows 2000 operation system.

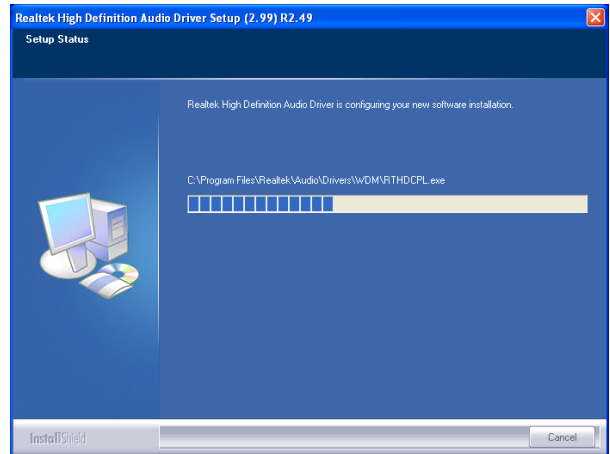

**Step 3.** Select **Next** to the next step.

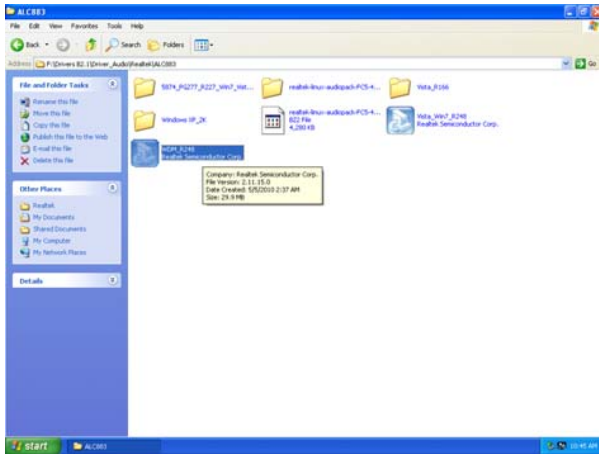

**Step 1.** Locate 「\Driver\_Audio\Intel\6300ESB ALC888\setup.exe」.



**Step 4.** Click **Finish** to complete the setup.



**Step 2.** Select **Next** to the next step.

## 4.4 Install Ethernet Driver (For Intel 82574L/ 82577LM)

Insert the Supporting DVD-ROM to DVD-ROM drive, and it should show the index page of Avalue's products automatically. If not, locate Index.htm and choose the product from the menu left, or link to **D:\Driver\_Gigabit\Intel\ 82574L or 82577LM**.



**Note:** The installation procedures and screen shots in this section are based on Windows XP operation system.

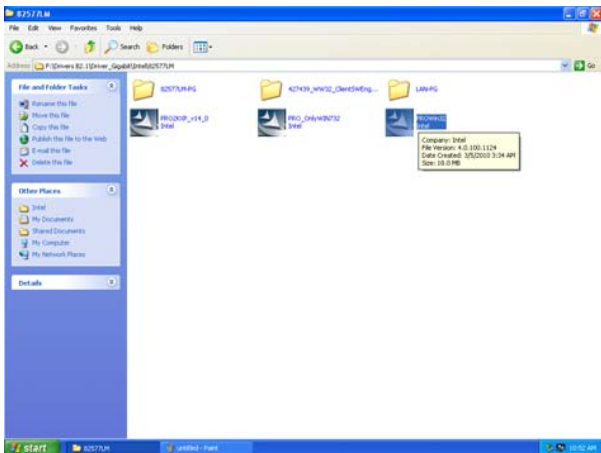

**Step 1.** Locate 「\Driver\_Gigabit\Intel\ 82574L or 82577LM 」 and choose your system OS.

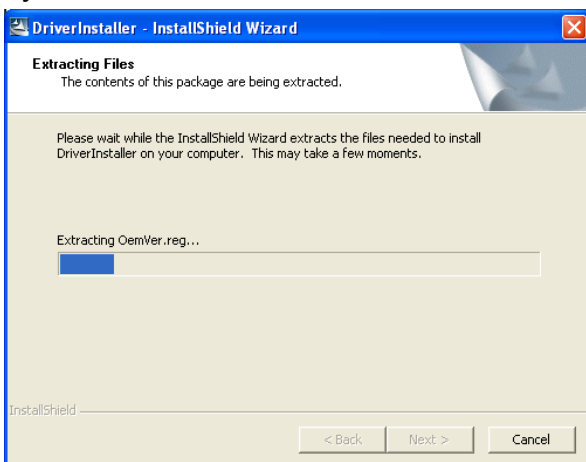

**Step 2.** Click **Next**.

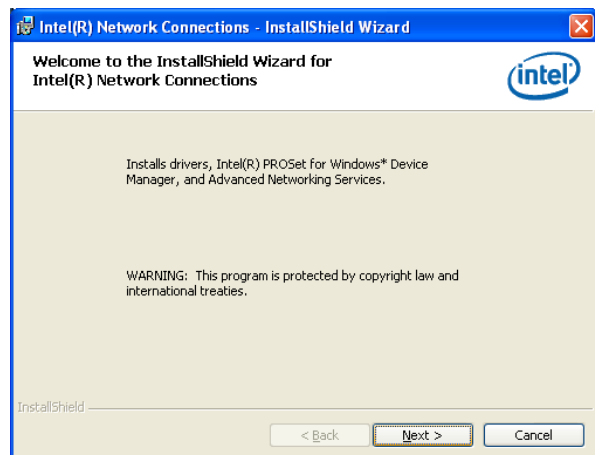

**Step 3.** Click **Next** to run the installation.

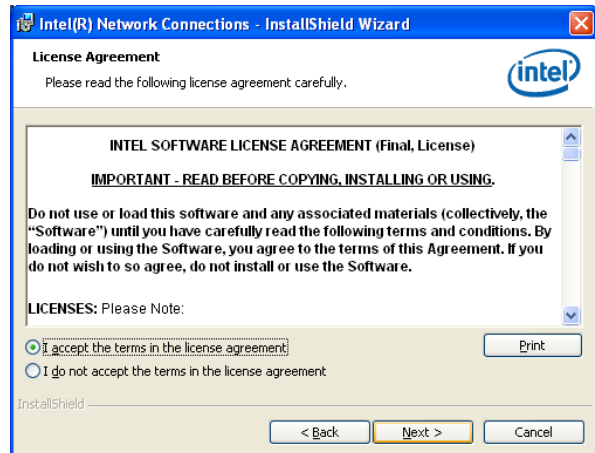

**Step 4.** Click **Accept** to continue.

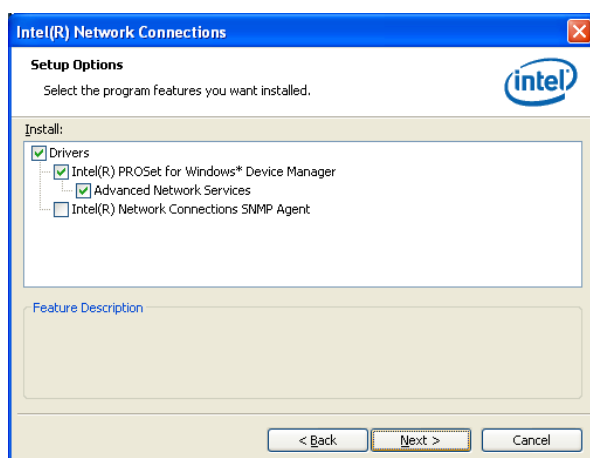

**Step 5.** Click **Next**.

## ECM-QM57

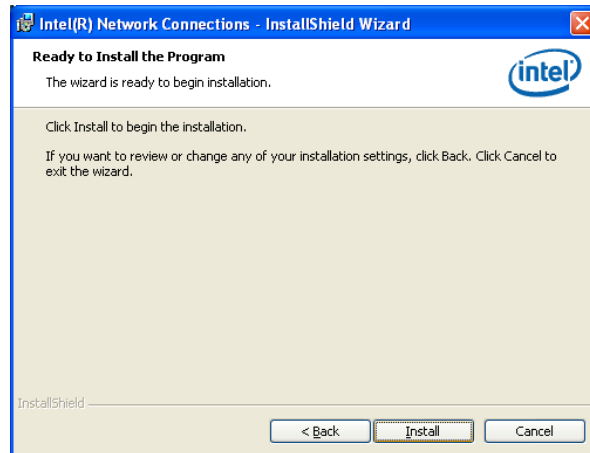

**Step 5.** Click **Install** to next step.

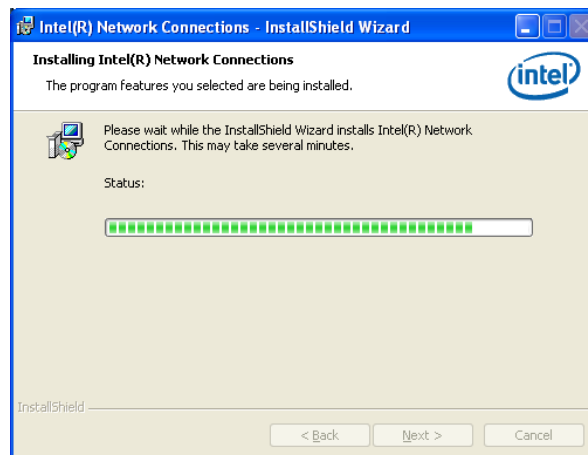

**Step 6.** Click **Next** to next step.

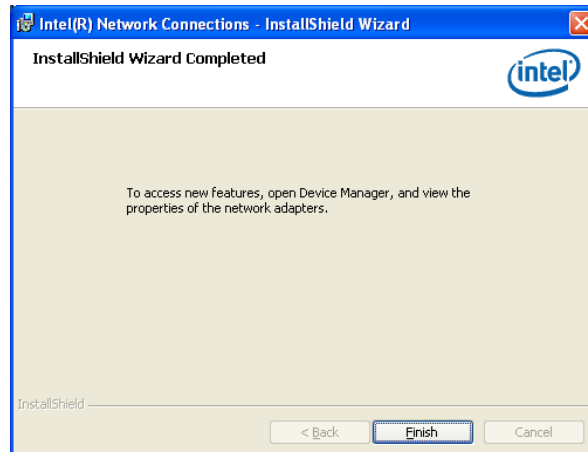

**Step 7.** Click **Finish** to complete the setup.

# 5. Mechanical Drawing

---

ECM-QM57

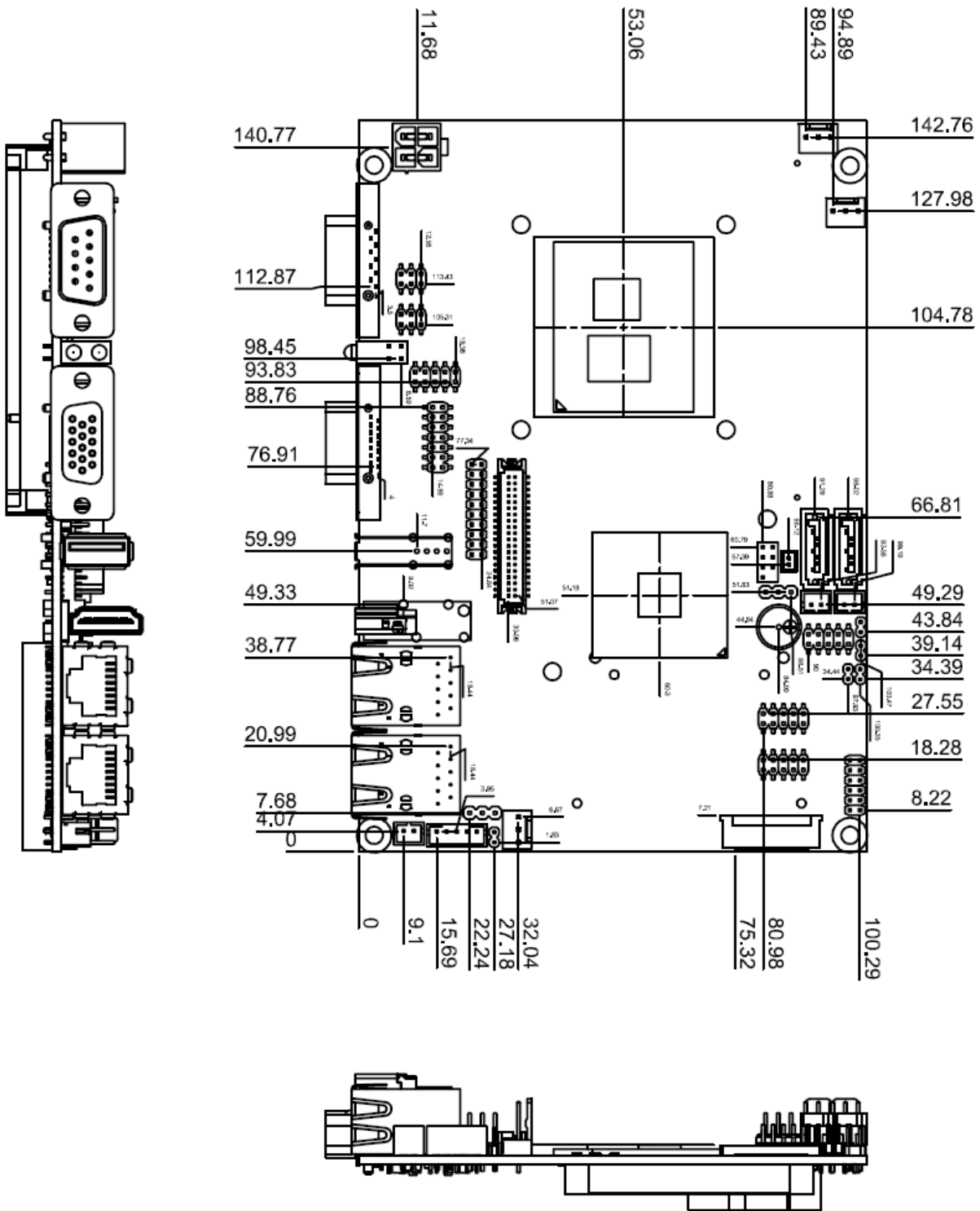

Unit: mm

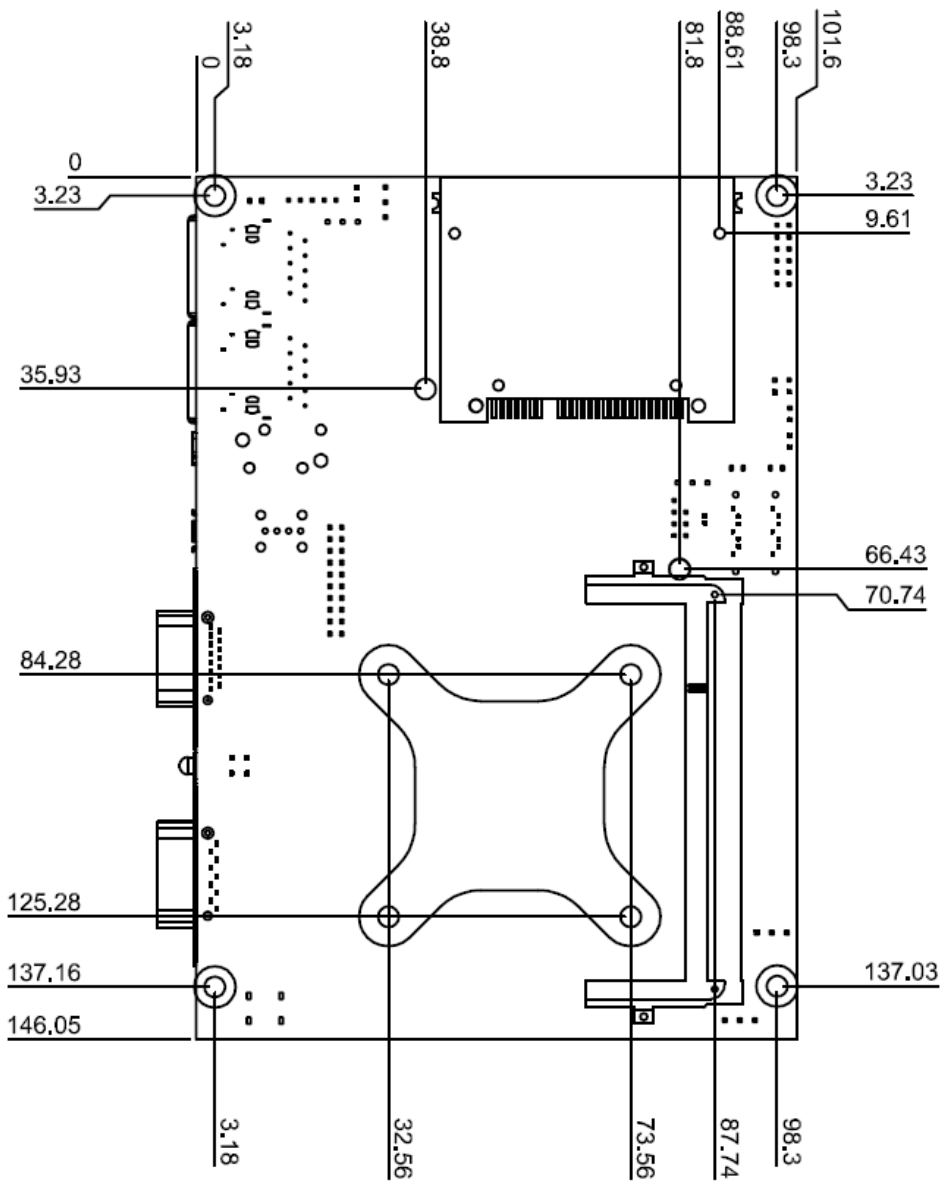

Unit: mm



# DATA MODUL

DISPLAYS AND EMBEDDED SOLUTIONS



## **DATA MODUL Headquarters Munich**

Landsberger Str. 322  
D-80687 Munich - Germany  
Phone: +49-89-56017-0  
Fax: +49-89-56017-119  
[www.data-modul.com](http://www.data-modul.com)

## **Sales Office Hamburg**

Borsteler Chaussee 51  
D-22453 Hamburg - Germany  
Phone: +49-40-42947377-0

## **Sales Office Duesseldorf**

Fritz-Vomfelde-Str. 8  
D-40547 Duesseldorf - Germany  
Phone: +49-211-52709-0

## **Sales Office Scandinavia**

Lundsmindevej 5  
DK-6000 Kolding - Denmark  
Phone: +45-75-224477

## **DATA MODUL FRANCE**

7 rue Saint Christophe  
F-60300 BARON - FRANCE  
Phone: +33-3-44549699

## **DATA MODUL Italy, S.r.l.**

Regus Center Senigallia  
Via Senigallia 18/2  
I-20161 Milano - Italy  
Phone: +39-02-64672509

## **DATA MODUL Iberia, S.L.**

c/ Adolfo Pérez Esquivel 3  
Edificio Las Americas III Oficina 40  
28230 Parque Empresarial  
Las Rozas / Madrid - Spain  
Phone: +34-916-366458

## **DATA MODUL Suisse GmbH**

Stationsstr. 57  
CH-8606 Nänikon - Switzerland  
Phone: +41-44-94091-50

## **DATA MODUL Ltd. / UK**

Collins Building  
3 Vigo Place - Aldridge - Walsall  
WS9 8UG - United Kingdom  
Phone: +44-1922-457358

## **DATA MODUL Inc. / USA**

275 Marcus Blvd, Unit K  
Hauppauge, NY 11788 - USA  
Phone: +1-631-951-0800