

PCM-9578

Socket 370

**Celeron™/Pentium® III SBC with
4 Ethernet, CFC and GPIO**

Users' Manual

Copyright

This document is copyrighted, © 2003. All rights are reserved. The original manufacturer reserves the right to make improvements to the products described in this manual at any time without notice.

No part of this manual may be reproduced, copied, translated or transmitted in any form or by any means without the prior written permission of the original manufacturer. Information provided in this manual is intended to be accurate and reliable. However, the original manufacturer assumes no responsibility for its use, nor for any infringements upon the rights of third parties that may result from such use.

Acknowledgements

IBM, PC/AT, PS/2 and VGA are trademarks of International Business Machines Corporation.

Intel and StrongARM are trademarks of Intel Corporation.

Microsoft Windows® CE.NET is a registered trademark of Microsoft Corp.

All other product names or trademarks are properties of their respective owners.

For more information on this and other Advantech products, please visit our websites at: **<http://www.advantech.com>**

<http://www.advantech.com/epc>

For technical support and service, please visit our support website at:

<http://support.advantech.com>

This manual is for the PCM-9578F, rev. A1.

Part No. 2006957810

1st Edition: January, 2003

Packing List

Before you begin installing your card, please make sure that the following materials have been shipped:

- 1 PCM-9578F all-in-one single board computer
- 1 CD disc with utility and drivers
- 1 Startup Manual
- 1 mini jumper package [10 pcs] (p/n: 9689000002)
- 1 EBX 7P - 4P power cable

If any of these items are missing or damaged, contact your distributor or sales representative immediately.

Please refer to Appendix C for the optional interface wiring kit.

Additional Information and Assistance

Step 1. Visit the Advantech web site at **www.advantech.com/risc** where you can find the latest information about the product.

Step 2. Contact your distributor, sales representative, or Advantech's customer service center for technical support if you need additional assistance. Please have the following information ready before you call:

- Product name and serial number
- Description of your peripheral attachments
- Description of your software (operating system, version, application software, etc.)
- A complete description of the problem
- The exact wording of any error messages

Contents

Chapter 1	General Information	2
1.1	Introduction	2
1.2	Features	3
1.3	Specifications	3
1.4	Dimensions and Board Layout	5
	Figure 1.1:PCM-9578 dimensions	5
Chapter 2	Installation	8
2.1	Jumpers	8
	Table 2.1:Jumpers	8
2.2	Connectors	9
	Table 2.2:Connectors on the PCM-9578	9
2.3	Locating Jumpers	10
	Figure 2.1:Locating Jumpers	10
2.4	Locating Connectors	11
	Figure 2.2:Locating Connectors (component side).....	11
	Figure 2.3:Locating Connectors (solder side).....	12
2.5	Setting Jumpers	13
2.6	CPU installation and upgrading	14
	2.6.1 Installing a CPU in the ZIF socket.....	14
	2.6.2 CMOS clear (J4)	15
	Table 2.3:CMOS clear (J4).....	15
2.7	Installing DRAM (SODIMMs)	15
	2.7.1 Introduction	15
	2.7.2 Installing SODIMMs	16
2.8	IDE Hard Drive Connector (CN8)	16
	2.8.1 Connecting the hard drive	16
2.9	Floppy drive connector (CN14, optional)	17
	2.9.1 Connecting the floppy drive	17
2.10	Parallel port connector (CN9)	17
2.11	Keyboard and PS/2 mouse connector (CN11)	18
2.12	Power & HDD indicator LED connector (CN4)	18
	2.12.1 Reset switch	18
2.13	Power connectors (CN1, CN10, CN25, CN29)	18
	2.13.1 Main power connector, +5 V, +12 V (CN29).....	18
	2.13.2 Fan power connector (CN1, CN10, CN25, CN7).....	18
2.14	ATX power control connector (CN22, CN23).....	19
	2.14.1 ATX feature conn (CN23) & power button (CN22).....	19
	Figure 2.4:Wiring for ATX power switch function	19
2.15	COM-port connector (CN13, CN16)	20
2.16	VGA interface connections (CN18).....	20

2.17	Ethernet configuration.....	20
2.17.1	100Base-T connector (CN1, CN4, CN5).....	20
2.17.2	Network boot	20
2.18	Ethernet 3, Ethernet 4 bypass function.....	21
2.19	USB connectors (CN12).....	21
2.20	Digital I/O (CN5).....	21
Chapter 3	Award BIOS Setup.....	24
3.1	System test and initialization.....	24
3.1.1	System configuration verification.....	24
3.2	Award BIOS setup	24
3.2.1	Entering setup	25
	Figure 3.1:Setup program initial screen.....	25
3.2.2	Standard CMOS setup	26
	Figure 3.2:CMOS setup screen	26
3.2.3	BIOS features setup	27
	Figure 3.3:BIOS features setup.....	27
3.2.4	Chipset features setup	28
	Figure 3.4:Chipset features setup.....	28
3.2.5	Power management setup	29
	Figure 3.5:Power management setup.....	29
3.2.6	PnP/PCI configuration	30
	Figure 3.6: PnP/PCI configuration.....	30
3.2.7	Integrated peripherals	31
	Figure 3.7:Integrated peripherals.....	31
3.2.8	Load BIOS defaults	32
	Figure 3.8:Load BIOS defaults	32
3.2.9	Change password	33
3.2.10	Auto detect hard disk	34
	Figure 3.9:IDE HDD auto detection screen.....	34
3.2.11	Save & exit setup	34
3.2.12	Exit without saving	34
Chapter 4	AGP SVGA Setup	36
4.1	Introduction	36
4.1.1	Chipset	36
4.1.2	Display types.....	36
4.1.3	Dual/simultaneous display.....	36
	Figure 4.1:Selecting display settings	37
4.2	Installation of SVGA driver	37
4.3	Installation for Windows 98 and 2000	38
4.4	Installation for Windows NT.....	43
4.5	Further information	47

Chapter 5	PCI Bus Ethernet Interface.....	50
5.1	Introduction	50
5.2	Installation of Ethernet driver	50
5.2.1	Installation for MS-DOS and Windows 3.1.....	50
5.3	Installation for Windows 95/98/2000.....	51
5.4	Installation for Windows NT.....	53
5.5	Further information	55
Appendix A	Pin Assignments	58
A.1	Ethernet 10/100Base-T (CN26, CN24, CN20, CN17)...	58
A.2	ATX Power Feature Connector (CN23)	58
A.3	Keyboard and PS/2 Mouse Connector (CN11).....	59
A.4	Main Power Connector (CN29)	60
A.5	Floppy Disk Drive Connector (CN14).....	61
A.6	IDE Hard Drive Connector (CN8)	62
A.8	CRT Display Connector (CN18).....	64
A.9	Power & HDD LED Connector(CN4)	64
A.10	USB Connector (CN12)	65
A.11	Serial Port 1 connector DB-9 (CN13).....	66
A.12	Serial Port 2 connector (CN16).....	66
A.13	CompactFlash™ Card Connector (CN30)	67
A.14	CPU fan power connector (CN10, CN1)	68
A.15	System fan power connector (CN25).....	68
A.16	Fan failure LED (CN7)	68
Appendix B	System Assignments	70
B.1	System I/O Ports.....	70
B.2	1st MB memory map.....	71
B.3	DMA channel assignments.....	71
B.4	Interrupt assignments	72
Appendix C	Optional Extras	74
C.1	PCM-10586-5E cable kit for PCM-9578	74
Appendix D	Mechanical Drawings.....	76
D.1	Component Side	76
D.2	Solder Side	77

General Information

This chapter gives background information on the PCM-9578.

Sections include:

- Introduction
- Features
- Specifications
- Board layout and dimensions

Chapter 1 General Information

1.1 Introduction

The PCM-9578F is an all-in-one Celeron™ Pentium® III level single board computer (SBC) with quadruple Ethernet interfaces, 2 COM, 8 GPIO and one PCI expansion slot. The PCM-9578F supports Pentium III (Tualatin) processors up to 1.26 GHz. It has an optional LAN3/LAN4 bypass function. This compact unit is only 203 x 146 mm (8" x 5.75"). It offers all the functions of a single board industrial computer, but still fits in the space of a 5.25" CD ROM drive, and 1 U chassis for the networking appliance market.

On-board features include two serial ports, one multi-mode parallel (ECP/EPP/SPP) port, two USB (Universal Serial Bus) ports, one CompactFlash socket for CFC, and a keyboard/PS/2 mouse interface. The built-in high-speed PCI IDE controller supports PIO, UDMA/33 and bus master modes. Up to two IDE devices can be connected, including large hard disks, CD-ROM drives and tape backup drives.

The PCM-9578F features power management to minimize power consumption. It complies with the “Green Function” standard and supports doze, standby and suspend modes. In addition, the board's watchdog timer can automatically reset the system or generate an interrupt in case the system stops due to a program bug or EMI.

The PCM-9578F has been certified as complying with FCC Class A and CE Marking Class A.

Quad Ethernet for Communication Appliances

The PCM-9578 supports 4 Ethernet interfaces designed for the Communication Market. It can be used for firewall and VPN applications. A PCI slot is available so the customer can add a fifth ethernet or use a VPN & security PCI card.

1.2 Features

- Supports Pentium® III(Tualatin) /Celeron™ processors up to 1.26GHz
- Supplies scalable ethernet, 3 or 4 10/100 Mbps ports
- Optional LAN3–LAN4 bypass function
- Supports redirection function to control console via serial port
- PCI slot for hardware expansion
- 8 general purpose input/outputs (GPIO)

1.3 Specifications

Standard SBC functions

- **CPU:** Socket 370 supports FC-PGA & FC-PGA2 type Intel Pentium III/Celeron with 512K (Tualatin) processor up to 1.26GHz
- **Note:** Does not support PPGA type Pentium III/Celeron
- **BIOS:** Award 256 KB Flash memory
- **System memory:** One SODIMM socket accepts 64 MB up to 512 MB SDRAM
- **2nd cache memory:** 128KB/256KB/512KB on the processor
- **System Chipset:** Intel 815E chipset, 82815 GMCH and 82801BA ICH2
- **Enhanced IDE interface:** One channels supports up to two EIDE devices. BIOS auto-detect, PIO Mode 3 or Mode 4, UDMA 33 mode.
- **FDD interface:** Supports up to two FDDs (optional)
- **Serial ports:** Two serial RS-232 ports
- **Parallel port:** One parallel port, supports SPP/EPP/ECP mode
- **Keyboard/mouse connector:** Supports standard PC/PS/2 keyboard and a PS/2 mouse
- **Power management:** Supports power saving modes including Normal/Standby/Suspend modes. APM 1.2 compliant
- **Watchdog timer:** 62 level timer intervals

- **USB:** Two universal serial bus ports, USB 1.1 compliant
- **GPIO:** 8 General Purpose programmable I/Os

Solid State Disk

- Supports one 50-pin socket for CFC type I/II

VGA/LCD Interface

- **Chipset:** Intel 82815 GMCH
- **Frame buffer:** Supports 8/16/32 MB frame buffer with system memory
- **Interface:** direct AGP interface
- Display modes:
- CRT Modes: 1600 x 1200 @8bpp (75Hz),
- 1280 x 1024@24bpp (85Hz),
- 1024 x 768 @24bpp (85Hz)

Ethernet interface

- Chipset: Intel 82562 + 82559ER x 3 (optional 3 x 82559 or 3 x RTL 8139C+)
- Ethernet interface: IEEE 802.3u 10/100BASE-T Fast Ethernet compatible
- I/O address switchless setting

Mechanical and Environmental

- Dimensions (L x W): 203 X 146mm (8" x 5.75")
- Power supply voltage: +5 V, $\pm 5\%$
- Power requirements:
- max 10A @ +5V
- typical 5.6A @ +5V,
(with 256 MB DRAM, Intel PIII 1.26GHz CPU)
- Operating temperature: 0 ~ 60°C (32 ~ 140°F)
- Operating Humidity: 0% ~ 90% Relative Humidity, noncondensing

1.4 Dimensions and Board Layout

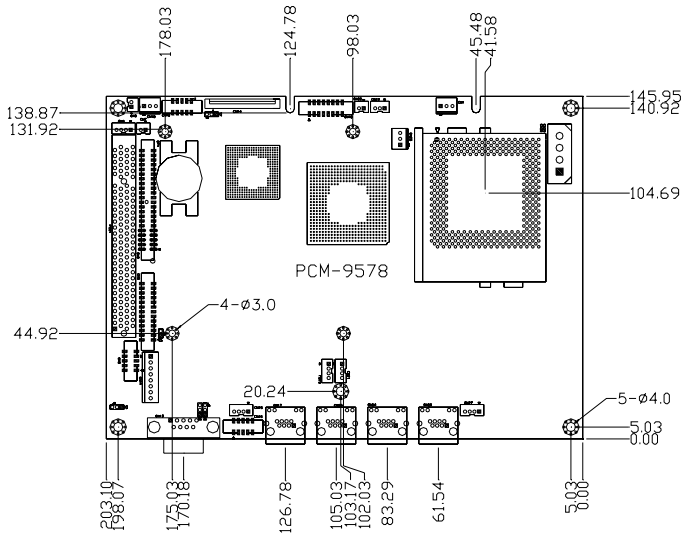

Figure 1.1: PCM-9578 dimensions

Installation

This chapter tells how to set up the PCM-9578F hardware, including instructions on setting jumpers and connecting peripherals, switches and indicators. Be sure to read all the safety precautions before you begin the installation procedure.

Chapter 2 Installation

2.1 Jumpers

The PCM-9578F has a number of jumpers that allow you to configure your system to suit your application. The table below lists the function of each of the board's jumpers:

Table 2.1: Jumpers

Jumper	Function
J1	PCI VIO select
J2	LAN3, LAN4 bypass function select (optional)
J3	LAN3, LAN4 bypass function select (optional)
J4	CMOS clear jumper
J5	Firmware Hub Lock read/write enable

2.2 Connectors

On-board connectors link the PCM-9578F to external devices such as hard disk drives, a keyboard, or floppy drives. The table below lists the function of each of the board's connectors:

Table 2.2: Connectors on the PCM-9578

Label	Function
CN1	System fan1
CN4	Power & HDD LED connector
CN5	Digital I/O
CN6	Reset button connector
CN7	Fan fail LED
CN8	IDE1
CN9	Printer port
CN10	System fan1
CN11	Keyboard and PS2 mouse
CN12	USB
CN13	Serial port 1
CN14	FDD (Optional)
CN15	LAN4 LED
CN16	Serial port2
CN17	LAN4 RJ45
CN18	VGA
CN19	LAN3 LED
CN20	LAN3 RJ45
CN21	LAN2 LED
CN22	ATX power on/off button
CN23	ATX power suspend 5V & PS_ON signal
CN24	LAN2 RJ45
CN25	CPU fan
CN26	LAN1 RJ45
CN27	LAN1 LED
CN29	EBX power

2.3 Locating Jumpers

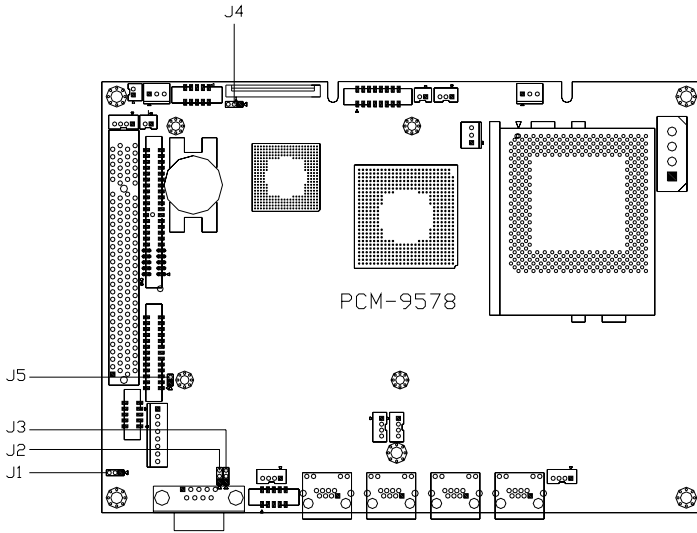

Figure 2.1: Locating Jumpers

2.4 Locating Connectors

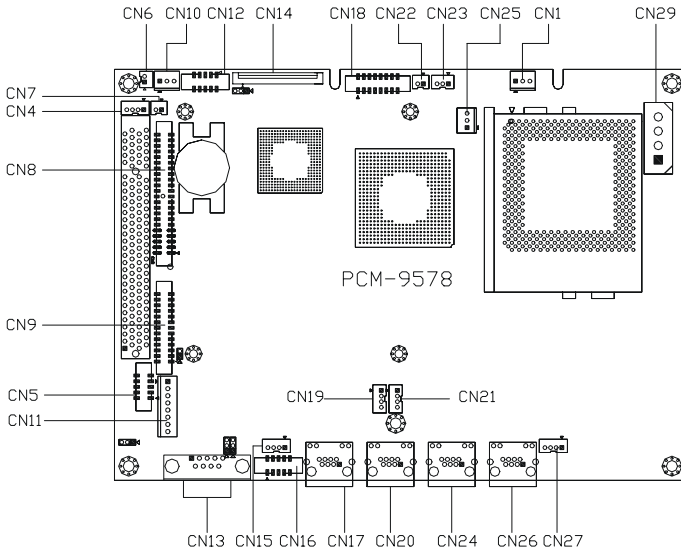

Figure 2.2: Locating Connectors (component side)

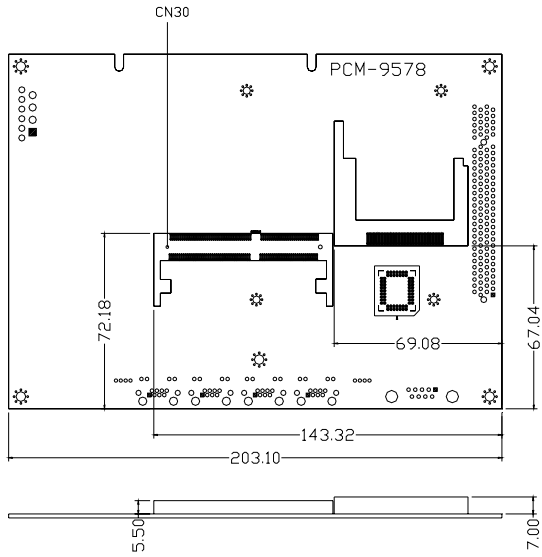
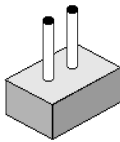

Figure 2.3: Locating Connectors (solder side)

2.5 Setting Jumpers

You may configure your card to match the needs of your application by setting jumpers. A jumper is a metal bridge used to close an electric circuit. It consists of two metal pins and a small metal clip (often protected by a plastic cover) that slides over the pins to connect them. To “close” a jumper, you connect the pins with the clip. To “open” a jumper, you remove the clip. Sometimes a jumper will have three pins, labeled 1, 2 and 3. In this case you would connect either pins 1 and 2, or 2 and 3.



open

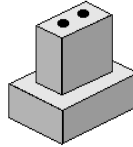

closed

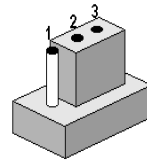

closed 2-3

The jumper settings are schematically depicted in this manual as follows:

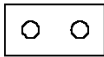

open



closed

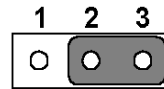

closed 2-3

A pair of needle-nose pliers may be helpful when working with jumpers.

If you have any doubts about the best hardware configuration for your application, contact your local distributor or sales representative before you make any changes.

Generally, you simply need a standard cable to make most connections.

2.6 CPU installation and upgrading

You can upgrade to a higher power Pentium processor at any time. Simply remove the old CPU, install the new one, and set the jumpers for the new CPU type and speed.

Warning! *Always disconnect the power cord from your chassis when you are working on it. Do not make connections while the power is on as sensitive electronic components can be damaged by the sudden rush of power. Only experienced electronics personnel should open the PC chassis*



Caution! *Always ground yourself to remove any static charge before touching the PC board. Modern electronic devices are very sensitive to static electric charges. Use a grounding wrist strap at all times. Place all electronic components on a static-dissipative surface or in a static-shielded bag when they are not in the chassis.*



2.6.1 Installing a CPU in the ZIF socket

The PCM-9578F provides a Zero Insertion Force (ZIF) socket for easy CPU installation.

1. Make sure the ZIF socket lever is in the upright position. To raise the lever, pull it out to the side a little and raise it as far as it will go.
2. Place the CPU in the empty socket. Follow the instructions that came with the CPU. If you have no instructions, do the following: Carefully align the CPU so it is parallel to the socket and the notch on the corner of the CPU corresponds with the notch on the inside of the socket. Gently slide the CPU in. It should insert easily. If it doesn't, pull the lever up a little more.
3. Press the lever down. The plate will slide forward. You will feel some resistance as the pressure starts to secure the CPU in the socket. This is normal and will not damage the CPU.

When the CPU is installed, the lever should snap into place at the side of the socket.

Note: To remove a CPU, pull the lever out to the side a little and raise it

2.6.2 CMOS clear (J4)

Warning! To avoid damaging the computer, always turn off the power supply before setting “Clear CMOS.” Set the jumper back to “3V Battery On” before turning on the power supply.

The procedure for clearing CMOS is:

1. Turn off the system.
2. Short pin 2 and pin 3.
3. Return jumper to pins 1 and 2.
4. Turn on the system. The BIOS is now reset to its default setting

Table 2.3: CMOS clear (J4)

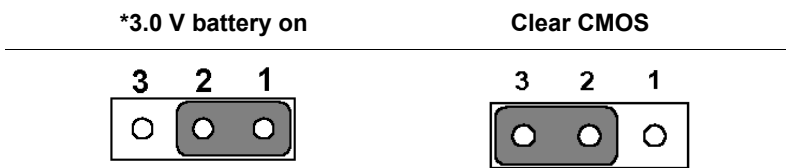

* default setting

2.7 Installing DRAM (SODIMMs)

2.7.1 Introduction

You can install anywhere from 16 MB to 512 MB of on-board DRAM memory using 16, 32, 64 or 128, 256 MB 144-pin SODIMMs (Small Outline Dual In-Line Memory Modules).

2.7.2 Installing SODIMMs

Note: The modules can only fit into a socket one way, and their gold pins must point down into the SODIMM socket.

The procedure for installing SODIMMs appears below. Please follow these steps carefully.

1. Ensure that all power supplies to the system are switched Off.
2. Install the SODIMM card. Install the SODIMM so that its gold pins point down into the SODIMM socket.
3. Slip the SODIMM into the socket at a 45 degree angle and carefully fit the bottom of the card against the connectors.
4. Gently push the SODIMM into a perpendicular position until the clips on the ends of the SODIMM sockets snap into place.
5. Check to ensure that the SODIMM is correctly seated and all connector contacts touch. The SODIMM should not move around in its socket.

To **remove** the memory module, just push both handles outward, and the module will be ejected from the socket.

2.8 IDE Hard Drive Connector (CN8)

You can attach one or two Enhanced Integrated Device Electronics hard disk drives to the PCM-9578's internal controller. The PCM-9578's IDE controller uses a PCI local-bus interface. This advanced IDE controller supports faster data transfer, PIO mode 3, mode 4.

2.8.1 Connecting the hard drive

Connecting drives is done in a daisy-chain fashion and requires one of two cables (not included in this packing), depending on the drive size.

1.8" and 2.5" drives need a 1 x 44-pin to 2 x 44-pin flat-cable connector. 3.5" drives use a 1 x 44-pin to 2 x 40-pin connector.

Wire number 1 on the cable is red or blue, and the other wires are gray.

1. Connect one end of the cable to CN8. Make sure that the red (or blue) wire corresponds to pin 1 on the connector, which is labeled on the board (on the right side).
2. Plug the other end of the cable to the Enhanced IDE hard drive, with pin 1 on the cable corresponding to pin 1 on the hard drive. (See your hard drive's documentation for the location of the connector.)

Connect a second drive as described above.

Unlike floppy drives, IDE hard drives can connect to either end of the cable. If you install two drives, you will need to set one as the master and one as the slave by using jumpers on the drives. If you install just one drive, set it as the master.

2.9 Floppy drive connector (CN14, optional)

You can attach up to two floppy drives to the PCM-9578F's on-board controller. You can use 3.5" (720 KB, 1.44 MB, and 2.88 MB) drives.

A 26-pin daisy-chain drive connector cable is required for a dual-drive system. On one end of the cable is a 34-pin flat-cable connector. On the other end are two sets of floppy disk drive connectors. Each set consists of a 34-pin flat-cable connector (usually used for 3.5" drives).

2.9.1 Connecting the floppy drive

1. Plug the 26-pin flat-cable connector into CN14. Make sure that the red wire corresponds to pin one on the connector.
2. Attach the appropriate connector on the other end of the cable to the floppy drive(s). You can use only one connector in the set. The set on the end (after the twist in the cable) connects to the A: drive. The set in the middle connects to the B: drive.

If you need to make your own cable, you can find the pin assignments for the board's connector in Appendix A.

2.10 Parallel port connector (CN9)

Normally, the parallel port is used to connect the card to a printer. The PCM-9578F includes a multi-mode (ECP/EPP/SPP) parallel port, accessed through CN9, a 26-pin flat-cable connector. You will need an adapter cable if you use a traditional DB-25 connector. The adapter cable has a 26-pin connector on one end and a DB-25 connector on the other.

The parallel port is designated as LPT1 and can be disabled or changed to LPT2 or LPT3 in the system BIOS setup.

The parallel port interrupt channel is designated to be IRQ7.

You can select ECP/EPP DMA channel via BIOS setup.

2.11 Keyboard and PS/2 mouse connector (CN11)

The PCM-9578F board provides a keyboard connector that supports both a keyboard and a PS/2 style mouse. In most cases, especially in embedded applications, a keyboard is not used. The standard PC/AT BIOS will report an error or fail during power-on self-test (POST) after a reset if the keyboard is not present. The PCM-9578F's BIOS standard setup menu allows you to select "All, But Keyboard" under the "Halt On" selection. This allows no-keyboard operation in embedded system applications without the system halting under POST (power-on-self-test).

2.12 Power & HDD indicator LED connector (CN4)

Next, you may want to install external switches to monitor and control the PCM-9578F. These features are optional - install them only if you need them. The front panel connector (CN4) is an 4-pin wafer box header, and provides connections for a hard disk access indicator, power on indicator, and an input switch for resetting the card.

2.12.1 Reset switch

If you install a reset switch, it should be an open single pole switch. Momentarily pressing the switch will activate a reset. The switch should be rated for 10 mA, 5 V.

If you need to make your own cable, you can find the pin assignments for the board's connector in Appendix C.

2.13 Power connectors (CN1, CN10, CN25, CN29)

2.13.1 Main power connector, +5 V, +12 V (CN29)

Supplies main power to the PCM-9578F (+5 V) and devices that require +12 V.

2.13.2 Fan power supply connector (CN1, CN10, CN25, CN7)

The PCM-9578F provides two system FAN connectors (CN1, CN10) for system intergrator options, and one CPU fan connector (CN25) to connecting an optional CPU cooling fan. The PCM-9578 also provides a CPU fan (CN25) failure LED connector (CN7) that helps users manage the system.

2.14 ATX power control connector (CN22, CN23)

2.14.1 ATX feature connector (CN23) and power button (CN22)

The PCM-9578F can support an advanced power button if an ATX power supply is used. To enable the power button:

1. Take the specially designed ATX-to-PS/2 power cable PCM-9578F optional item, P/N 1703070101.
2. Connect the 3-pin plug of the cable to CN23 (ATX feature connector).

Connect the power on/off button to CN22. (A momentary type of button should be used.)

Important Be sure that the ATX power supply can take at least a 10 mA load on the 5 V standby lead (5 VSB). If not, you may have difficulty powering on your system.

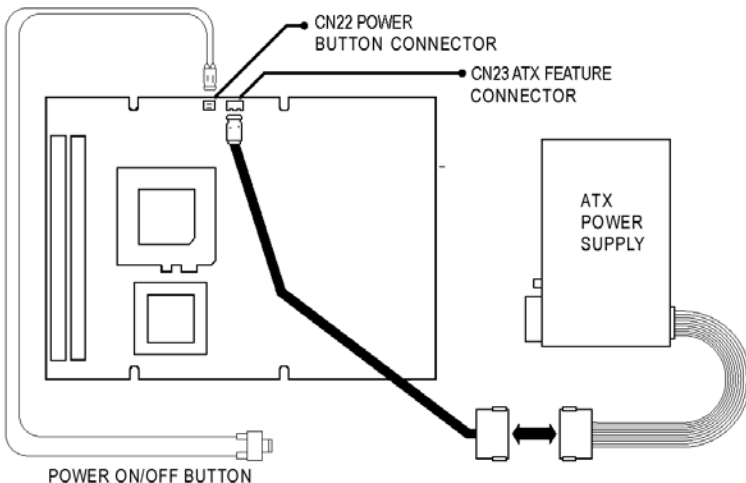

Figure 2.4: Wiring for ATX power switch function

2.15 COM-port connector (CN13, CN16)

The PCM-9578F provides two RS-232 serial ports in one COM port connector. The COM port connector consists of a DB-9 connector on board and a 10-pin, dual-in-line male header, and provides connections for serial devices (a mouse, etc.) or a communication network. You can find the pin assignments for the COM port connector in Appendix A.

2.16 VGA interface connections (CN18)

The PCM-9578F's PCI SVGA interface can drive conventional CRT displays. The board has one DB-9 connector to support standard CRT VGA monitors.

Pin assignments for CRT display connector CN18 are detailed in Appendix A.

2.17 Ethernet configuration

The PCM-9578F is equipped with a high performance 32-bit PCI-bus Ethernet interface which is fully compliant with IEEE 802.3U 10/100Mbps CSMA/CD standards. It is supported by all major network operating systems.

2.17.1 100Base-T connector (CN26, CN24, CN20, CN17)

The PCM-9578F provides 3 ethernet interfaces. They are CN26 (1st LAN), CN24 (2nd LAN), CN20 (3rd LAN), and CN17 (4th LAN). When users use only three ethernet interfaces, they must use the 1st three LAN interfaces (CN26, CN24, CN20).

2.17.2 Optional Network boot (for Used RTL8139 or Intel 82559 Ethernet chip)

The Network Boot feature can be utilized by incorporating the Boot ROM image files for the appropriate network operating system. The Boot ROM BIOS files are on the included utility disk.

2.18 Ethernet 3, Ethernet 4 bypass function

The PCM-9578F provides an optional LAN3, LAN4 bypass function. The bypass function can be controlled by power on/off or by GPIO with a jumper setting as detailed below.

Table 2.4: J2, J3 LAN 3, LAN 4 bypass function control

PINS	auto-detect*	by GPIO	always enable
J2 1-2	closed	closed	open
J2 2-3	NA†	NA	open
J3 1-2	closed	NA	open
J3 2-3	NA	closed	open
J2 1-2	closed	closed	open

*default setting

† note: The auto detect function can also be set by closing J2 2-3, in which case J3 can be *either* open or closed.

2.19 USB connectors (CN12)

The PCM-9578F board provides two USB (Universal Serial Bus) interfaces which gives complete plug and play, hot attach/detach for up to 127 external devices. The USB interfaces comply with USB specification rev. 1.1 and are fuse protected.

The USB interfaces are accessed through a 5 x 2 -pin flat-cable connectors, CN12. You will need an adapter cable if you use a standard USB connector. The adapter cable has a 5 x 2 -pin connector on one end and an USB connector on the other.

The USB interfaces can be disabled in the system BIOS setup.

2.20 Digital I/O (CN5)

The PCM-9578F supports general purpose out through CN5. The 8 digital outputs can be programmed to control input/output devices.

CHAPTER 3

Award BIOS Setup

This chapter describes how to set BIOS configuration data.

Chapter 3 Award BIOS Setup

3.1 System test and initialization

These routines test and initialize board hardware. If the routines encounter an error during the tests, you will either hear a few short beeps or see an error message on the screen. There are two kinds of errors: fatal and non-fatal. The system can usually continue the boot up sequence with non-fatal errors. Non-fatal error messages usually appear on the screen along with the following instructions:

press <F1> to RESUME

Write down the message and press the F1 key to continue the bootup sequence.

3.1.1 System configuration verification

These routines check the current system configuration against the values stored in the board's CMOS memory. If they don't match, the program outputs an error message. You will then need to run the BIOS setup program to set the configuration information in memory.

There are three situations in which you will need to change the CMOS settings:

1. You are starting your system for the first time
2. You have changed the hardware attached to your system
3. The CMOS memory has lost power and the configuration information has been erased.

The PCM-9578's CMOS memory has an integral lithium battery backup. The battery backup should last ten years in normal service, but when it finally runs down, you will need to replace the complete unit.

3.2 Award BIOS setup

Award's BIOS ROM has a built-in Setup program that allows users to modify the basic system configuration. This type of information is stored in battery-backed CMOS RAM so that it retains the Setup information when the power is turned off.

3.2.1 Entering setup

Power on the computer and press immediately. This will allow you to enter Setup.



Figure 3.1: Setup program initial screen

3.2.2 Standard CMOS setup

When you choose the Standard CMOS Setup option from the Initial Setup Screen menu, the screen shown below is displayed. This standard Setup Menu allows users to configure system components such as date, time, hard disk drive, floppy drive and display. Once a field is highlighted, on-line help information is displayed in the left bottom of the Menu screen.

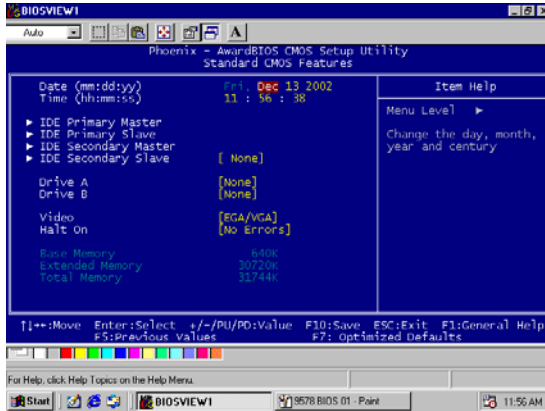

Figure 3.2: CMOS setup screen

3.2.3 BIOS features setup

By choosing the BIOS FEATURES Setup option from the Initial Setup Screen menu, the screen below is displayed. This sample screen contains the manufacturer's default values for the PCM-9578.

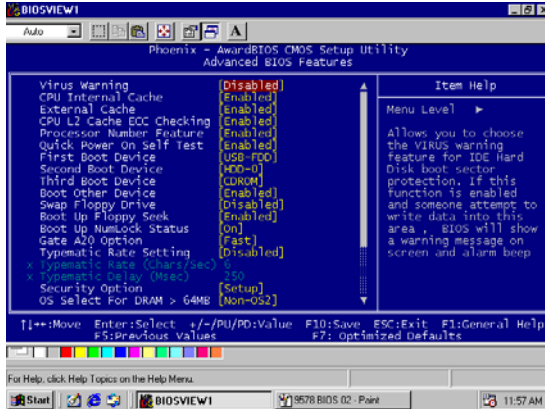

Figure 3.3: BIOS features setup

3.2.4 Chipset features setup

By choosing the CHIPSET FEATURES Setup option from the Initial Setup Screen menu, the screen below is displayed. This sample screen contains the manufacturer's default values for the PCM-9578

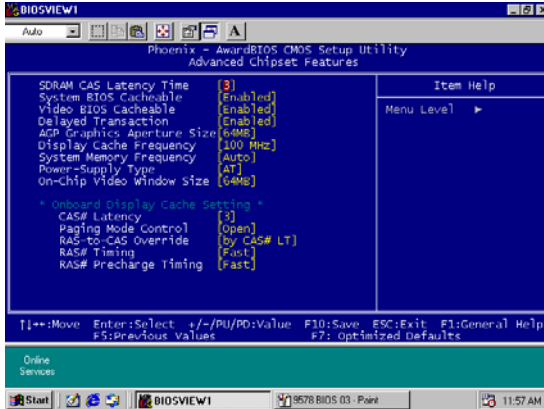

Figure 3.4: Chipset features setup

3.2.5 Power management setup

By choosing the POWER MANAGEMENT Setup option from the Initial Setup Screen menu, the screen below is displayed. This sample screen contains the manufacturer's default values for the PCM-9578.



Figure 3.5: Power management setup

3.2.6 PnP/PCI configuration

By choosing the PnP/PCI CONFIGURATION option from the Initial Setup Screen menu, the screen below is displayed. This sample screen contains the manufacturer's default values for the PCM-9578.

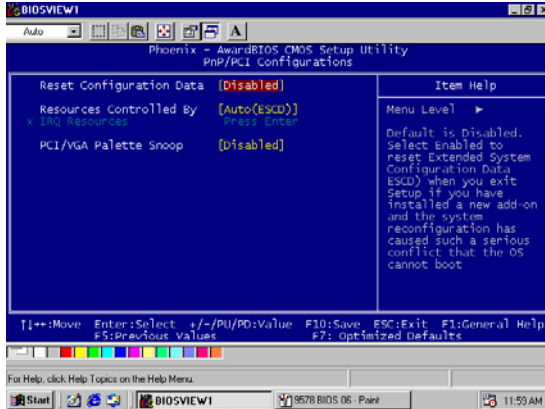

Figure 3.6: PnP/PCI configuration

3.2.7 Integrated peripherals

By choosing the INTEGRATED PERIPHERALS option from the Initial Setup Screen menu, the screen below is displayed. This sample screen contains the manufacturer's default values for the PCM-9578.

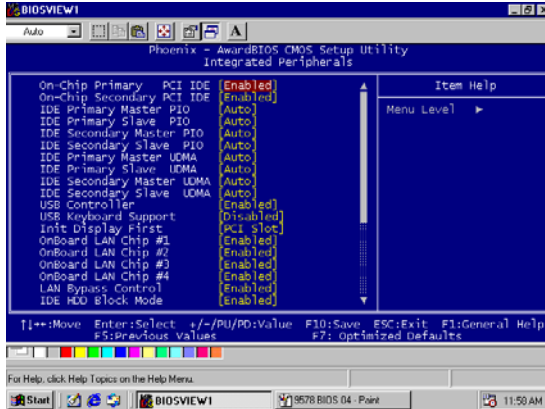
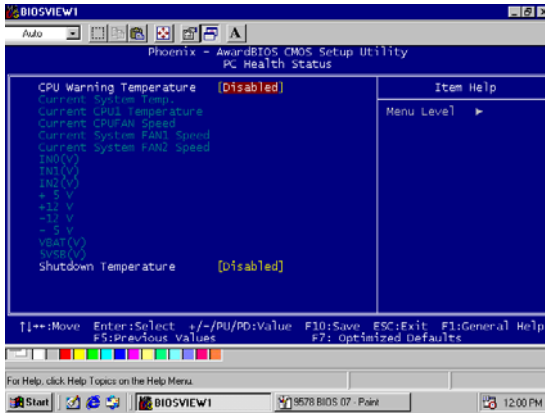

Figure 3.7: Integrated peripherals

3.2.8 PC Health Status

By choosing the PC Health Status option from the initial SetupScreen manual, the screen below is displayed. This sample screen contains the Manufacturer's default values for the PCM-9578. The CPU warning tem-

perature set to enable that System will auto warning by buzzer while CPU temperature over the setting of BIOS



3.2.9 Frequency/ Voltage control

By choosing the PC Health Status option from the initial SetupScreen manual, the screen below is displayed. This sample screen contains the Manufacturer's default values for the PCM-9578. Auto detect DIMM/PCI clk set to enable meaning system can auto detect DIMM speed (100 or 133MHz) and PCI speed. The spread spectrum setting is for EMI consideration.

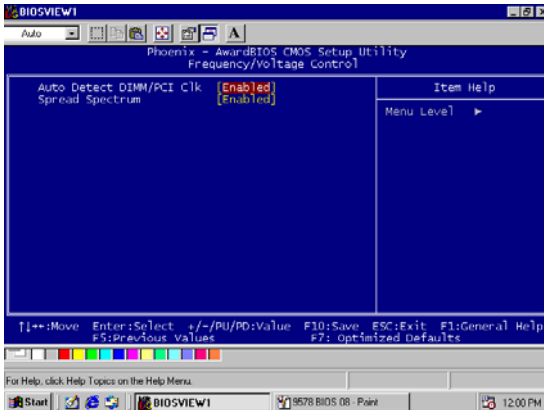

3.2.10 Load BIOS defaults

LOAD BIOS DEFAULTS loads the default system values directly from ROM. If the stored record created by the Setup program becomes corrupted (and therefore unusable), these defaults will load automatically when you turn the PCM-9578 on.

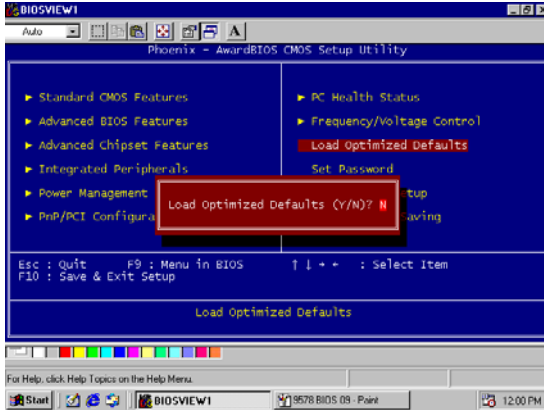

Figure 3.8: Load BIOS defaults

3.2.11 Change password

To change the password, choose the PASSWORD SETTING option from the Setup main menu and press <Enter>.

1. If the CMOS is bad or this option has never been used, a default password is stored in the ROM. The screen will display the following messages:
Enter Password:
Press <Enter>.
 2. If the CMOS is good or this option has been used to change the default password, the user is asked for the password stored in the CMOS. The screen will display the following message:
Confirm Password:
Enter the current password and press <Enter>.
 3. After pressing <Enter> (ROM password) or the current password (user-defined), you can change the password stored in the CMOS. The password can be at most eight (8) characters long.
- Remember - to enable this feature, you must first select either Setup or System in the BIOS FEATURES SETUP.

3.2.12 Auto detect hard disk

The IDE HDD auto detection utility can automatically detect the IDE hard disk installed in your system. You can use it to self-detect and/or correct the hard disk type configuration.



Figure 3.9: IDE HDD auto detection screen

3.2.13 Save & exit setup

If you select this option and press <Enter>, the values entered in the setup utilities will be recorded in the chipset's CMOS memory. The microprocessor will check this every time you turn your system on and compare this to what it finds as it checks the system. This record is required for the system to operate.

3.2.14 Exit without saving

Selecting this option and pressing <Enter> lets you exit the Setup program without recording any new values or changing old ones.

AGP SVGA Setup

Sections include:

- Introduction
- Installation of SVGA driver for
 - Windows 98 and 2000
 - Windows NT

Chapter 4 AGP SVGA Setup

4.1 Introduction

The PCM-9578 has an on-board AGP flat panel/VGA interface. The specifications and features are described as follows:

4.1.1 Chipset

The PCM-9578 makes use of the display properties of the Intel 815E AGP/SVGA controller. It supports interlaced and non-interlaced analog monitors (color and monochrome VGA) in high-resolution modes while maintaining complete IBM VGA compatibility. Digital monitors (i.e. MDA, CGA, and EGA) are NOT supported. Multiple frequency (multi-sync) monitors are handled as if they were analog monitors.

4.1.2 Display types

CRT and panel displays can be used simultaneously. The PCM-9578 can be set in one of three configurations: on a CRT, on a flat panel display, or on both simultaneously. The system is initially set to simultaneous display mode. The BIOS setup can be used to configure the display. In BIOS, select "Integrated Peripherals", then "Boot-up display type." You can then choose one of the following modes: "CRT only", "Panel only", or "Simultaneous."

4.1.3 Dual/simultaneous display

The PCM-9578 uses the Intel 815e controller that is capable of providing multiple views and simultaneous display with mixed video and graphics on a flat panel and CRT.

To set up dual display under Windows 98, follow these steps:

1. Select "Windows98", "Control panel", "Display", "Settings".
2. Select "1" for current display, or "2" for second display.
3. Enable "Extend my Windows desktop onto this monitor".

4. Click “OK”.

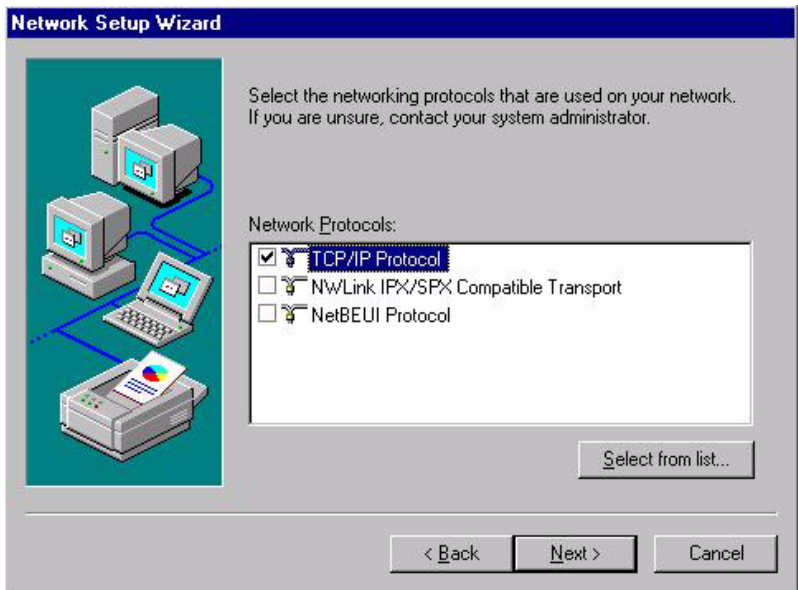

Figure 4.1: Selecting display settings

4.2 Installation of SVGA driver

Complete the following steps to install the SVGA driver. Follow the procedures that apply to the operating system that you are using within your PCM-9578.

Important: The following windows illustrations are examples only. You must follow the instructions which appear on your screen.

4.3 Installation for Windows 98 and 2000

Insert the disk, or otherwise make the files available to the system, and run setup. Then proceed as directed by the prompts...

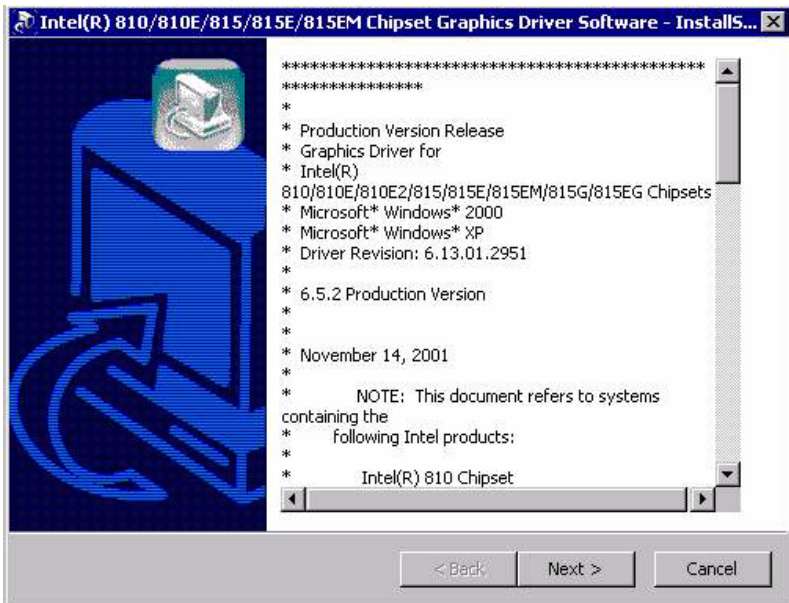
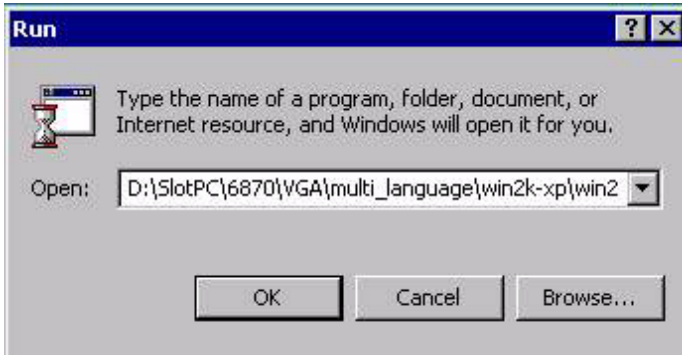

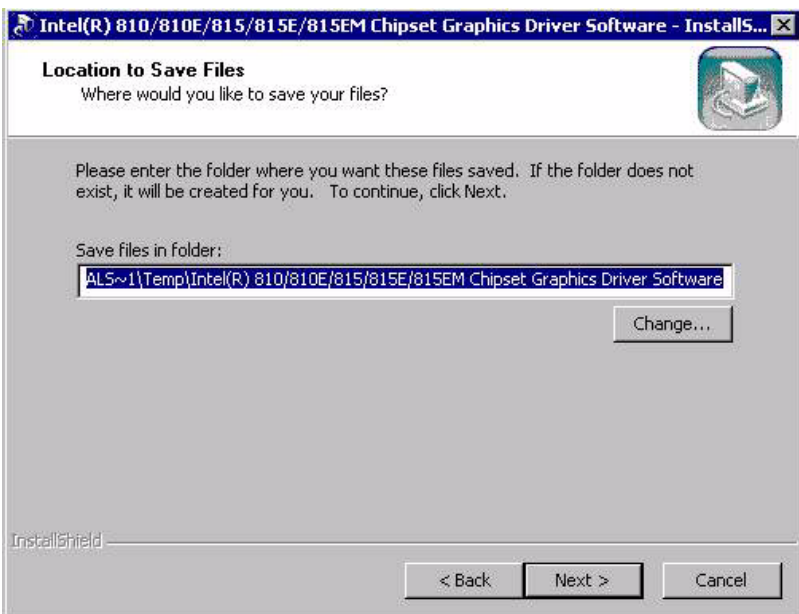

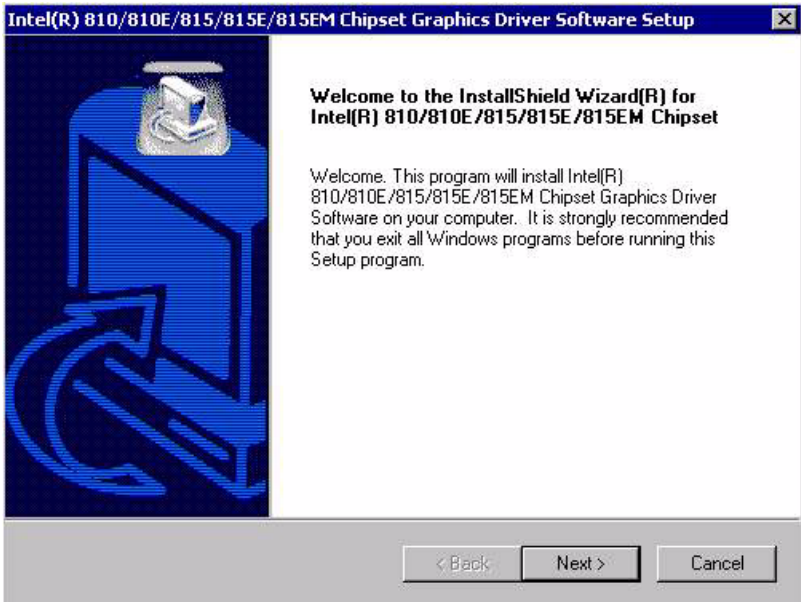

License Agreement

Please read the following license agreement carefully.



Press the PAGE DOWN key to see the rest of the agreement.

INTEL SOFTWARE LICENSE AGREEMENT (DEM / IHV / ISV Distribution & Single User)

IMPORTANT - READ BEFORE COPYING, INSTALLING OR USING.
Do not use or load this software and any associated materials (collectively, the "Software") until you have carefully read the following terms and conditions. By loading or using the Software, you agree to the terms of this Agreement. If you do not wish to so agree, do not install or use the Software.

Please Also Note:
* If you are an Original Equipment Manufacturer (OEM), Independent Hardware Vendor

Do you accept all the terms of the preceding License Agreement? If you choose No, the setup will close. To install Intel(R) 810/810E/815/815E/815EM Chipset Graphics Driver Software, you must accept this agreement.

InstallShield

< Back Yes No

Intel(R) 810/810E/815/815E/815EM Chipset Graphics Driver Software Setup



InstallShield(R) Wizard Complete

The InstallShield(R) Wizard has successfully installed Intel(R) 810/810E/815/815E/815EM Chipset Graphics Driver Software. Before you can use the program, you must restart your computer.

- Yes, I want to restart my computer now.
- No, I will restart my computer later.

Remove any disks from their drives, and then click Finish to complete setup.

< Back

Finish

Cancel

4.4 Installation for Windows NT

Insert the disk, or otherwise make the files available to the system, and run setup. Then proceed as directed by the prompts.



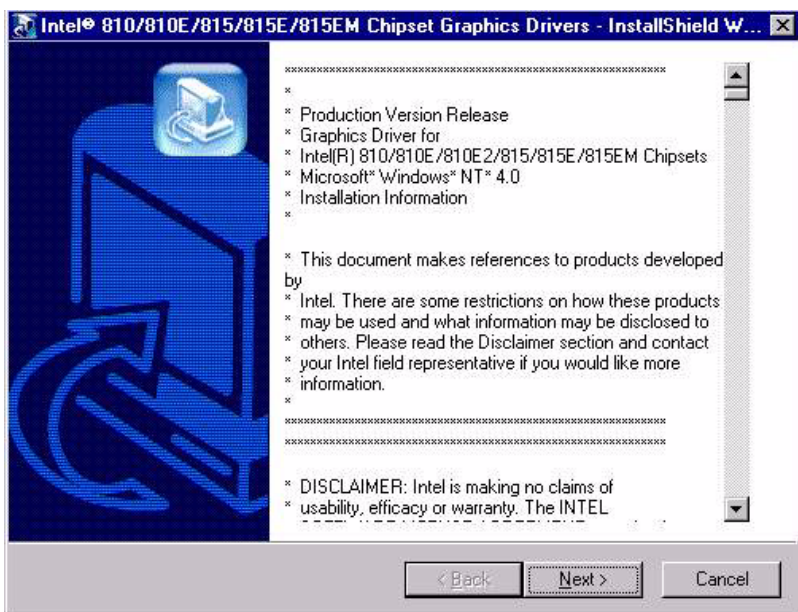

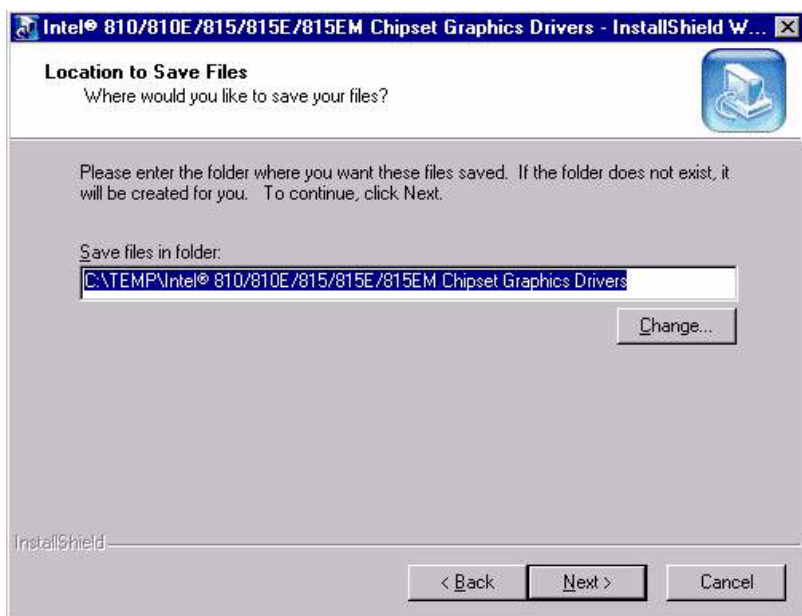

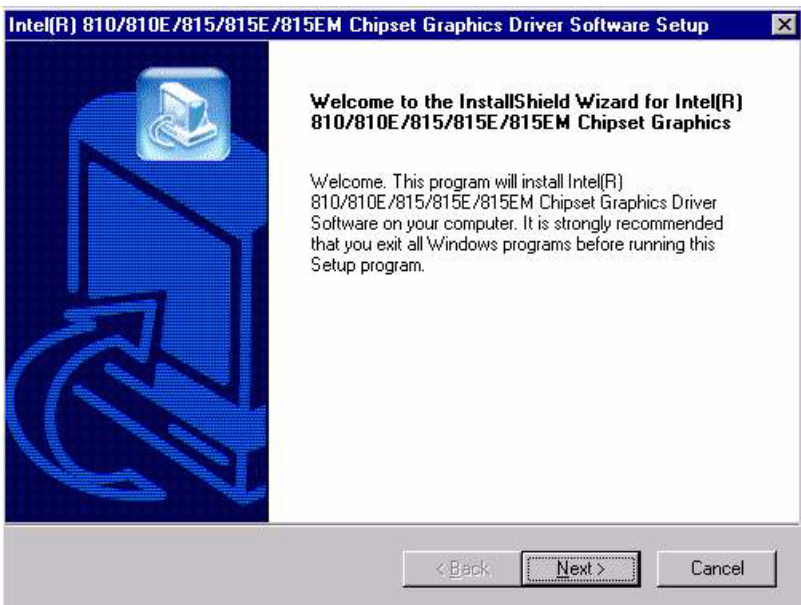

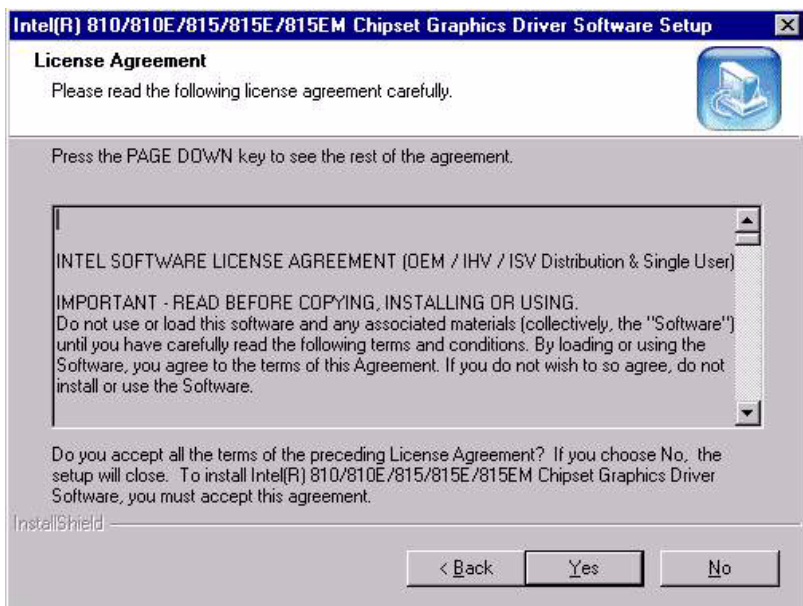

4.5 Further information

For further information about the AGP/SVGA installation in your PCM-9578, including driver updates, troubleshooting guides and FAQ lists, visit the following web resources:

Trident website: www.trid.com

Advantech websites: www.advantech.com
www.advantech.com.tw

PCI Bus Ethernet Interface

This chapter provides information on Ethernet configuration.

Sections include:

- Introduction
- Installation of Ethernet driver
 - Installation for Windows 95/98
 - Installation for Windows NT
- Further information

Chapter 5 PCI Bus Ethernet Interface

5.1 Introduction

The PCM-9578F is equipped with high performance 32-bit Ethernet chipsets: Intel 82562ET for LAN4 and 82559ER for LAN 1~3. They are fully compliant with IEEE 802.3 100 Mbps CSMA/CD standards. It is supported by major network operating systems. It is also both 100Base-T and 10Base-T compatible.

5.2 Installation of Ethernet driver

Before installing the Ethernet driver, note the procedures below. You must know which operating system you are using in your PCM-9578, and then refer to the corresponding installation flow chart. Then just follow the steps described in the flow chart. You will quickly and successfully complete the installation, even if you are not familiar with instructions for MS-DOS or WINDOWS.

Note: The windows illustrations in this chapter are examples only. Follow the flow chart path and pay attention to the instructions which appear on your screen. Since the PCM-9578 supports four LANs, users need to install the Ethernet driver four times.

5.2.1 Installation for MS-DOS and Windows 3.1

If you want to set up your Ethernet connection under the MS-DOS or Windows 3.1 environment, you should first check your server system model. For example, MS-NT, IBM-LAN server, and so on.

Then choose the correct driver to install in your panel PC.

The installation procedures for various servers can be found in the directory path "LAN/TXT/*" of the drivers and utilities disks, where * is your server model.

5.3 Installation for Windows 95/98/2000

1. a. Select "Start", "Settings", "Control Panel".
b. Double click "Network".



2. a. Click "Add" and prepare to install network functions.

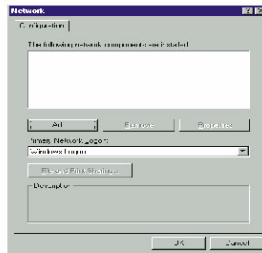

3. a. Select the "Adapter" item to add the Ethernet card.

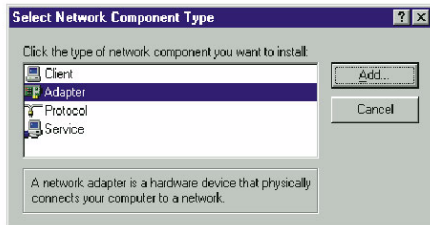

4. a. Click "Have Disk" to install the driver.

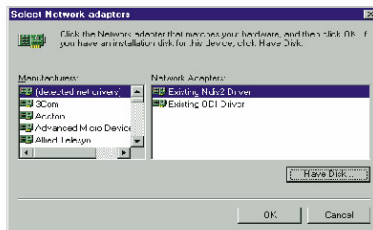

5.

- a. Insert the utility disc into the CD-ROM drive.
- b. Type: D:\BISCUIT\9578\Lan\82559ER
- c. Click "OK".

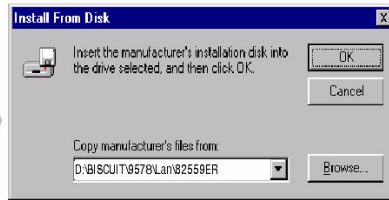

6.

- a. Choose the "82559ER" item.
- b. Click "OK".

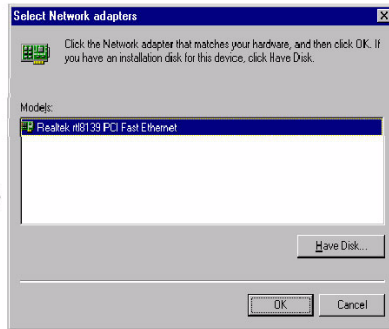

7.

- a. Make sure the configurations of relevant items are set correctly.
- b. Click "OK" to reboot.

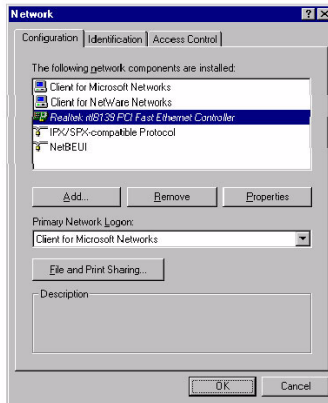

END

Note: For LAN4 (82562ET) installation, users have to choose the 82562ET item in steps 5 and 6.

5.4 Installation for Windows NT

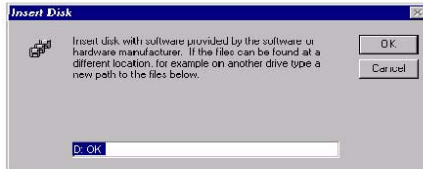
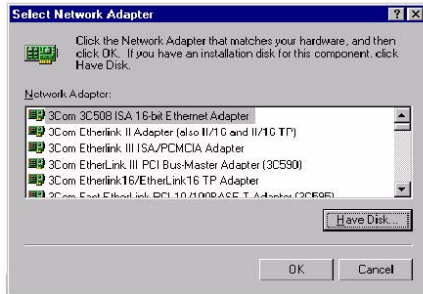
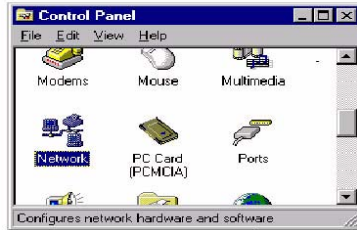
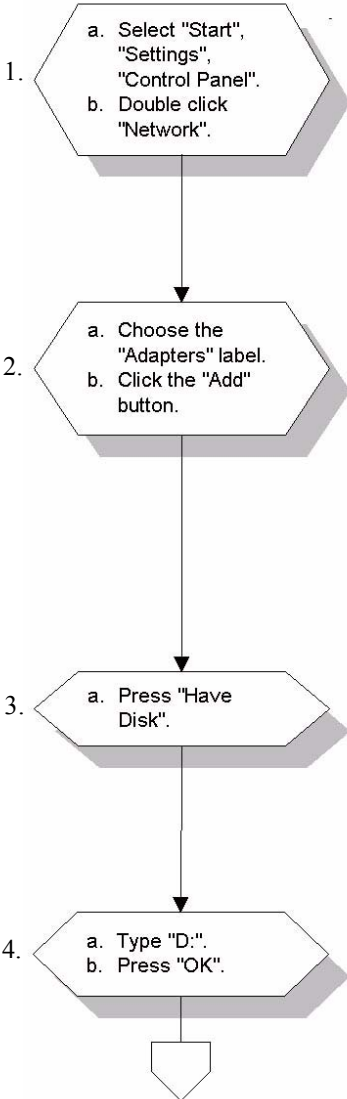

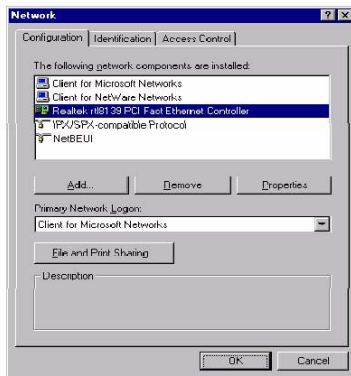
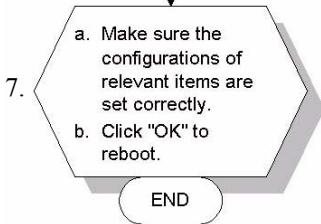
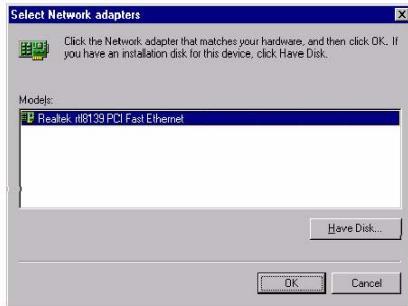
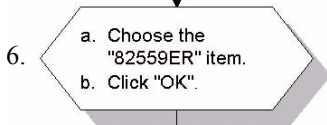
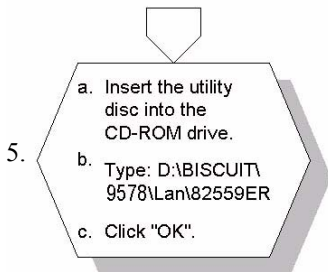

Note: For LAN4 (82562ET) installation, users have to choose the 82562ET item in steps 5 and 6.

5.5 Installation for Windows XP

1. Click “Properties” under “My Computer”



2. Click on the “Hardware” tab

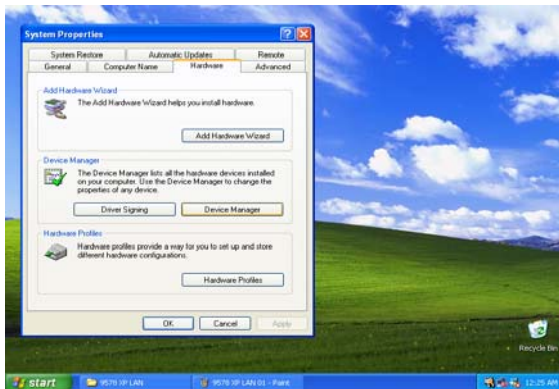

3.Under “Other devices” select “Ethernet Controller”

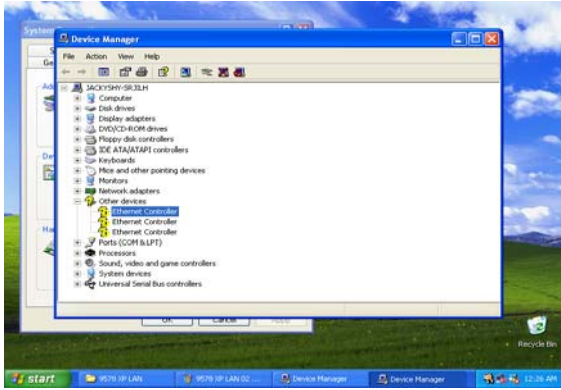

4.Click on the “Driver” tab

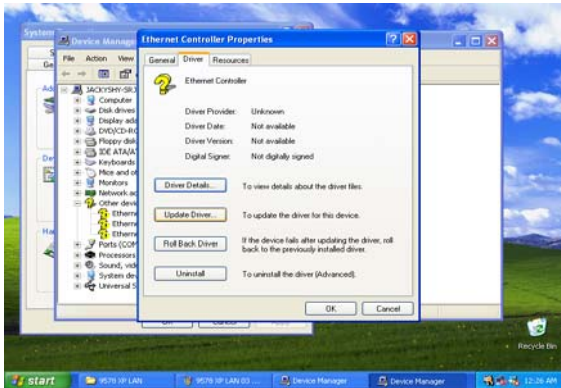

5. Click “Install from a list or specific location (advanced)”

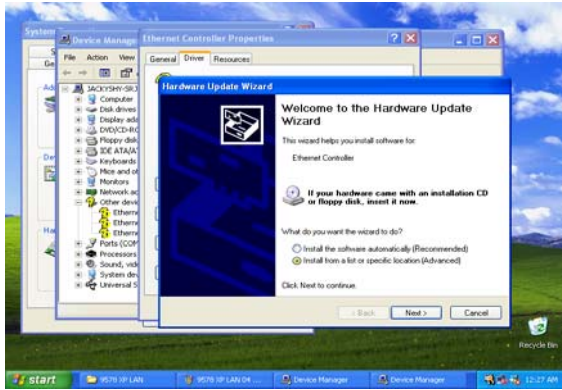

6.

Click on “Don’t search, I will choose the driver”

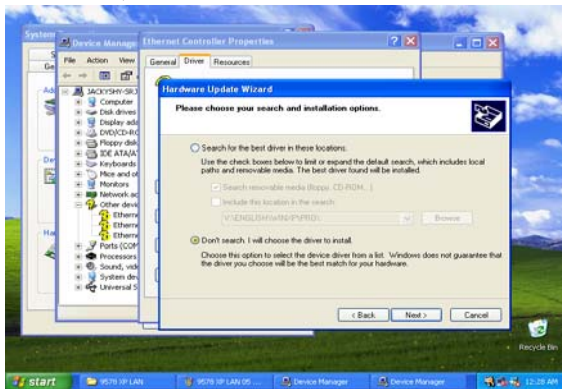

7. Select “Network adapters”

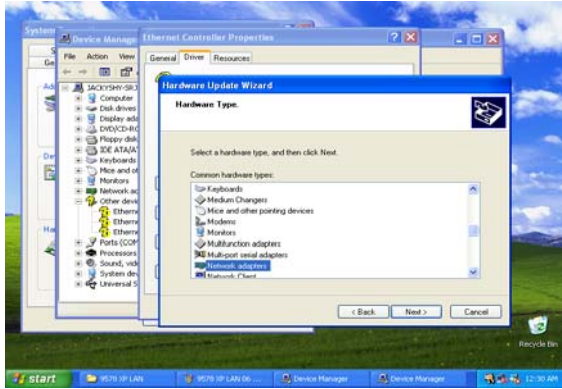

8. Click on “Acer” and select “Acer NIC-559A PRO/100+ with Alert On LAN 2”

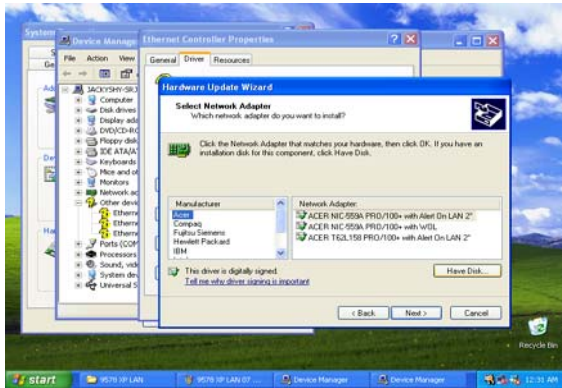

9. Install from disk

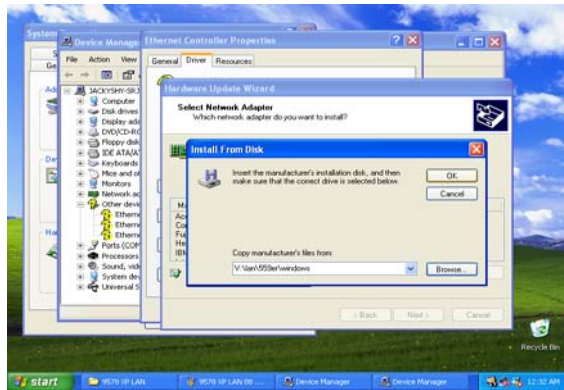

10. Click "Next"

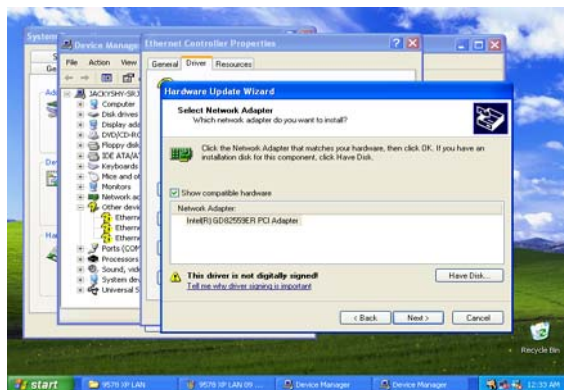

11. Click “Finish”

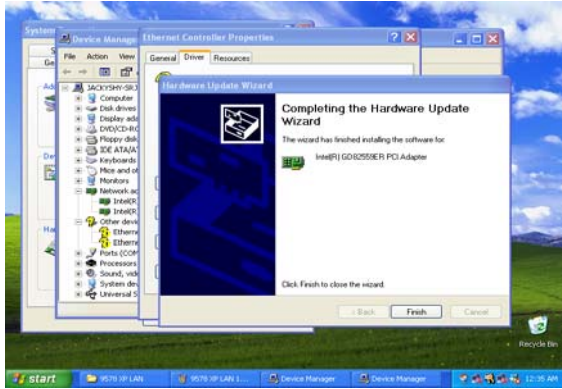

5.6 Further information

Intel® website: www.intel.com

Advantech websites: www.advantech.com
www.advantech.com/support

Pin Assignments

This appendix contains information of a detailed or specialized nature. It includes:

- Ethernet 10/100Base-T connector (CN26, 24, 20, 17)
- Ethernet LED connector (CN27, 21, 19, 15)
- ATX power feature connector (CN23)
- Keyboard and PS/2 mouse connector (CN11)
- Main power connector (CN29)
- Floppy drive connector (CN14)
- IDE hard drive connector (CN8)
- Parallel port connector (CN9)
- CRT display connector (CN18)
- Power & HDD LED connector (CN4)
- USB connectors (CN12)
- Serial port 1 connector (CN13)
- Serial Port 2 (CN16)
- CompactFlash™ card connector (CN30)
- CPU fan power connector (CN10, CN1)
- Fan failure LED (CN7)
- Digital I/O (CN5)

Appendix A Pin Assignments

A.1 Ethernet 10/100Base-T Connector (CN26, CN24, CN20, CN17)

Table A.1: Ethernet 10/100Base-T connector (CN26, CN24, CN20, CN17)

Pin	Signal
1	XMT+
2	XMT-
3	RCV+
4	N/C
5	N/C
6	RCV-
7	N/C
8	N/C

A.2 ATX Power Feature Connector (CN23)



Table A.2: ATX Power Feature Connector (CN23)

Pin	Signal
1	5VSB (Stand by voltage)
2	NC
3	5 V SB (VPSON)

A.3 Keyboard and PS/2 Mouse Connector (CN11)



Table A.3: Keyboard and mouse connector (CN11)

Pin	Signal
1	GND
2	MS VCC
3	MS DATA
4	MS CLOCK
5	GND
6	KB VCC
7	KB DATA
8	KB CLOCK

A.4 Main Power Connector (CN29)

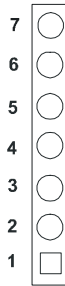

Table A.4: Main Power Connector (CN29)

Pin	Signal
1	+5 V
2	GND
3	GND
4	N.C.
5	N.C.
6	GND
7	+5 V

A.5 Floppy Disk Drive Connector (CN14)

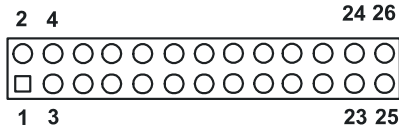

Table A.5: Floppy Disk Drive Connector (CN14)

Pin	Signal
1	Vcc (5 V)
2	INDEX
3	Vcc (5 V)
4	DRIVE SELECT 0
5	Vcc (5 V)
6	DISK CHANGE
7	NC
8	NC (READY)
9	NC (HD OUT)
10	MOTOR ON
11	NC
12	DIRECTION SELECT
13	NC (1.6 MB IN)
14	STEP
15	GND
16	WRITE DATA
17	GND
18	WRITE GATE
19	GND
20	TRACK 00
21	GND
22	WRITE PROTECT
23	GND
24	READ DATA
25	GND
26	SIDE SELECT

*low active

A.6 IDE Hard Drive Connector (CN8)

Table A.6: IDE HDD connector (CN8)

Pin	Signal	Pin	Signal
1	IDE RESET*	2	GND
3	DATA 7	4	DATA 8
5	DATA 6	6	DATA 9
7	DATA 5	8	DATA 10
9	DATA 4	10	DATA 11
11	DATA 3	12	DATA 12
13	DATA 2	14	DATA 13
15	DATA 1	16	DATA 14
17	DATA 0	18	DATA 15
19	SIGNAL GND	20	N/C
21	HDD 0	22	GND
23	IO WRITE	24	GND
25	IO READ	26	GND
27	HD READY	28	N/C
29	HDACK 0*	30	GND
31	IRQ14	32	N/C
33	ADDR 1	34	N/C
35	ADDR 0	36	ADDR 2
37	HARD DISK SELECT 0*	38	HARD DISK SELECT 1*
39	IDE ACTIVE*	40	GND
41	VCC	42	VCC
43	GND	44	N/C

* low active

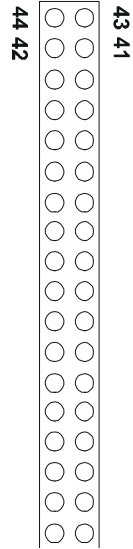

A.7 Parallel Port Connector (CN9)

Table A.7: Parallel Port Connector (CN9)

Pin	Signal	Pin	Signal
1	STROBE*	2	AUTOFD*
3	D0	4	ERR
5	D1	6	INIT*
7	D2	8	SLCTINI*
9	D3	10	GND
11	D4	12	GND
13	D5	14	GND
15	D6	16	GND
17	D7	18	GND
19	ACK*	20	GND
21	BUSY	22	GND
23	PE	24	GND
25	SLCT	26	N/C

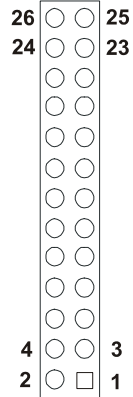

* low active

A.8 CRT Display Connector (CN18)

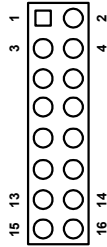

Table A.8: CRT Display Connector (CN18)

Pin	Signal	Pin	Signal
1	RED	9	Signal GND
2	DCC power	10	H-sync
3	GREEN	11	Signal GND
4	Signal GND	12	V-sync signal
5	BLUE	13	Signal GND
6	N/C	14	NC
7	N/C	15	Signal GND
8	DCC_DAT	16	Chassis GND

A.9 Power & HDD LED Connector(CN4)

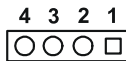

Table A.9: Power & HDD LED Connector (CN4)

Pin	Signal
1	HDD LED- (HARD DISK ACTIVE)
2	HDD LED+ (V _{cc})
3	power LED-
4	Power LED+

A.10 USB Connector (CN12)

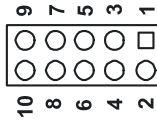

Table A.10: USB Connector (CN12)

Pin	Signal	Pin	Signal
1	+5 V	2	+5 V
3	UV0-	4	UV1-
5	UV0+	6	UV1+
7	GND	8	GND
9	Chassis GND	10	N/C

A.11 Serial Port 1 connector DB-9 (CN13)

Table A.11: Serial Port 1 connector (CN13)

Pin	Signal
1	DCD
2	RXD
3	TXD
4	DTR
5	GND
6	DSR
7	RTS
8	CTS
9	RI

A.12 Serial Port 2 connector (CN16)

Table A.12: Serial Port 2 connector (CN16)

Pin	Signal	Pin	Signal
1	DCD	2	DSR
3	RXD	4	RTS
5	TXD	6	CTS
7	DTR	8	RI
9	GND	10	NC

A.13 CompactFlash™ Card Connector (CN30)

Table A.13: CompactFlash Card Connector (CN30)

Pin	Signal	Pin	Signal
1	GND	2	D03
3	D04	4	D05
5	D06	6	D07
7	*CS0	8	A10
9	*ATA SEL	10	A09
11	A08	12	A07
13	+5 V	14	A06
15	A05	16	A04
17	A03	18	A02
19	A01	20	A00
21	D00	22	D01
23	D02	24	-IOCS16
25	*CD2	26	-CD1
27	D11	28	D12
29	D13	30	D14
31	D15	32	-CS1
33	*VS1	34	-IORD
35	*IOWR	36	-WE
37	INTRQ	38	+5 V
39	*CSEL	40	-VS2
41	*RESER	42	IORDY
43	*INPACK	44	-REG
45	*DASP	46	-PDIAG
47	D08	48	D09
49	D10	50	GND

* low active

A.14 CPU fan power connector (CN10, CN1)



Table A.14: CPU fan power connector (CN10, CN1)

Pin	Signal
1	Fan speed signal
2	+12 V
3	GND

A.15 System fan power connector (CN25)



Table A.15: System fan power connector (CN25)

Pin	Signal
1	Fan speed signal
2	+12 V
3	GND

A.16 Fan failure LED (CN7)



Table A.16: Fan failure LED (CN7)

Pin	Signal
1	FAN failure LED+
2	FAN failure LED-

A.17 Digital I/O connector (CN5)

Pin	Signal
1	IO0
2	IO1
3	IO2
4	IO3
5	IO4
6	IO5
7	IO6
8	IO7
9	GND
10	GND

System Assignments

- System I/O ports
- 1st MB memory map
- DMA channel assignments

Appendix B System Assignments

B.1 System I/O Ports

Table B.1: System I/O ports

Addr. range (Hex)	Device
000-01F	DMA controller
020-021	Interrupt controller 1, master
040-05F	8254 timer
060-06F	8042 (keyboard controller)
070-07F	Real-time clock, non-maskable interrupt (NMI) mask
080-09F	DMA page register
0A0-0BF	Interrupt controller 2
0C0-0DF	DMA controller
0F0	Clear math co-processor
0F1	Reset math co-processor
0F8-0FF	Math co-processor
1F0-1F8	Fixed disk
200-207	Reserved (Game I/O)
278-27F	Parallel printer port 2 (LPT 3)
2E8-2EF	Reserved (Serial port 4)
2F8-2FF	Serial port 2
300-31F	Prototype card
360-36F	Reserved
378-37F	Parallel printer port 1 (LPT 2)
380-38F	SDLC, bisynchronous 2
3A0-3AF	Bisynchronous 1
3B0-3BF	Monochrome display and printer adapter (LPT1)
3C0-3CF	Reserved
3D0-3DF	Color/graphics monitor adapter
3E8-3EF	Reserved (Serial port 3)
3F0-3F7	Diskette controller
3F8-3FF	Serial port 1

* PNP audio I/O map range from 220 ~ 250H (16 bytes)
MPU-401 select from 300 ~ 330H (2 bytes)

B.2 1st MB memory map

Table B.2: 1st MB memory map

Addr. range (Hex)	Device
F0000h - FFFFFh	System ROM
*CC000h - EFFFFh	Unused (reserved for Ethernet ROM)
C0000h - CBFFFh	Expansion ROM (for VGA BIOS)
B8000h - BFFFFh	CGA/EGA/VGA text
B0000h - B7FFFh	Unused
A0000h - AFFFFh	EGA/VGA graphics
00000h - 9FFFFh	Base memory

* If Ethernet boot ROM is disabled. For use with the optional RTL 8139 and Intel 82559 Ethernet chip only.

B.3 DMA channel assignments

Table B.3: DMA channel assignments

Channel	Function
0	Available
1	Available
2	Reserved (Floppy disk)
3	Available (parallel port*)
4	Cascade for DMA controller 1
5	Available
6	Available
7	Available

* Parallel port DMA select 1 (LPT2) or 3 (LPT1)

B.4 Interrupt assignments

Table B.4: Interrupt assignments

Interrupt#	Interrupt source
IRQ 0	Interval timer
IRQ 1	Keyboard
IRQ 2	Interrupt from controller 2
IRQ 3	COM2
IRQ 4	COM1
IRQ 5	Reserved (COM4)
IRQ 6	FDD
IRQ 7	LPT1
IRQ 8	RTC
IRQ 9	Reserved
IRQ 10	Reserved (COM3)
IRQ 11	Reserved (watchdog timer)
IRQ 12	PS/2 mouse
IRQ 13	INT from co-processor
IRQ 14	Primary IDE
IRQ 15	Reserved (CompactFlash)

* Ethernet interface IRQ select: 5, 9, 10, 11, 12, 15

* PnP USB IRQ select: 5, 9, 10, 11, 12, 15

Appendix

C

Optional Extras

Appendix C Optional Extras

C.1 PCM-10586-5E cable kit for PCM-9578

The PCM-9578 requires several cables for normal operation. You can make them yourself or purchase the optional cable kit assembly, which includes the following:

Table C.1: PCM-10586-5E Cable Table

Part No.	Cable description	PCM-9578 connector	Terminating connector
1701440350	2.5" and 1.8" IDE, IDC44P/IDC44P, IDC44P	CN8	44-pin, 2 mm, female IDC (350 mm)
1700260250	Parallel port	CN9	25-pin female D-SUB (2.0 mm)
1701160101	VGA GRT	CN18	15-pin D-SUB (2.0 mm)
1700060200	Keyboard and PS/2 mouse	CN11	5-pin circular DIN, 6-pin circular DIN
1906000001*	FDD Cable	CN14	FPC for slim FDD 12cm
1703100260*	USB Cable	CN12	10pin, 26cm
1701100300	COM2 Cable	CN16	10-pin, 9-pin male D-SUB (30cm)

* this cable is optional

Appendix

D

Mechanical Drawings

Appendix D Mechanical Drawings

D.1 Component Side

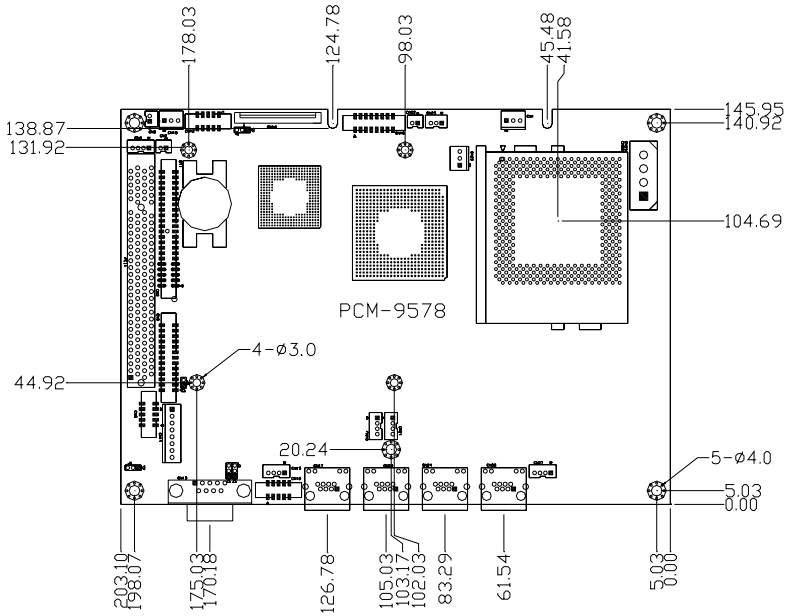

Figure D.1: PCM-9578 Mechanical Drawing-Component Side

D.2 Solder Side

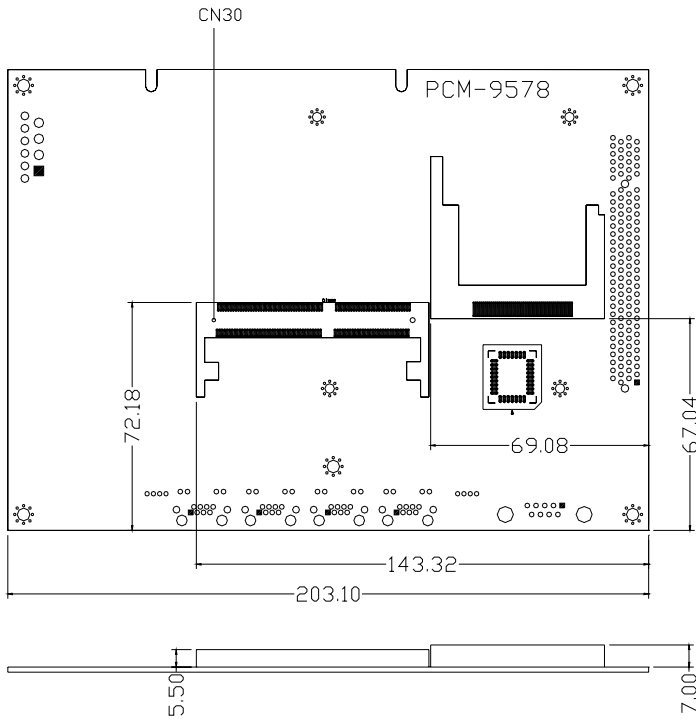

Figure D.2: PCM-9578 Mechanical Drawing-Solder Side

