

PREFACE

Thank you for purchasing the LogiTouch integrated development software, "LogiTouch Editor Ver. 1.0", hereafter referred to as the "LT Editor".

Please read this manual carefully in order to use this software properly, and be sure to keep this manual handy for future reference.

NOTES

- (1) The copyrights to all programs and manuals included in the LT Editor Ver. 1.0 Operation Manual - Screen Creation Guide (hereinafter referred to as "this product") are reserved by the Digital Electronics Corporation. Digital grants the use of this product to its users as described in the "Software Operating Conditions" documentation, included with this product's CD-ROM. Any actions violating the above-mentioned conditions are prohibited by both Japanese and foreign regulations.
- (2) The contents of this manual have been thoroughly inspected. However, if you should find any errors or omissions in this manual, please inform your local LT Editor representative of your findings.
- (3) Regardless of article (2), the Digital Electronics Corporation shall not be held responsible for any damages or third party claims resulting from the use of this product.
- (4) Differences may occur between the descriptions found in this manual and the actual functioning of this product. Therefore, the latest information on this product is provided in data files (i.e. Readme.txt files, etc.) and in separate documents. Please consult these sources as well as this manual prior to using the product.
- (5) Even though the information contained in and displayed by this product may be related to intangible or intellectual properties of the Digital Electronics Corporation or third parties, the Digital Electronics Corporation shall not warrant or grant the use of said properties to any users and/or other third parties.
- (6) The specifications set out in this manual are for overseas products only. As a result, some differences may exist between the specifications given here and for those of the identical Japanese product.

© Copyright 2001 Digital Electronics Corporation. All rights reserved.
Digital Electronics Corporation, May 2001

For the rights to trademarks and trade names, see "TRADEMARK RIGHTS".

TRADEMARK RIGHTS

All company or product names used in this manual are the trade names, trademarks (including registered trademarks), or service marks of their respective companies.

This product omits individual descriptions of each of these rights.

| Trademark / Trade Name | Right Holder |
|---|---|
| Microsoft, MS, MS-DOS, Windows, Windows 95, Windows 98, Windows Me, Windows NT, Windows 2000 Windows Explorer, Microsoft Excel 95 | Microsoft Corporation, USA |
| Intel, Pentium | Intel Corporation, USA |
| Pro-face, Flex Network | Digital Electronics Corporation (in Japan and other countries) |
| Ethernet | Western Digital Electric Corporation, USA |
| IBM, VGA, PC/AT | International Business Machines Corporation (IBM), USA |

The following terms differ from the above mentioned formal trade names and trademarks.





| Term used in this manual | Formal Trade Name or Trademark |
|--------------------------|---|
| Windows 95 | Microsoft® Windows® 95 Operating System |
| Windows 98 | Microsoft® Windows® 98 Operating System |
| Windows Me | Microsoft® Windows® Me Operating System |
| Windows NT | Microsoft® Windows NT® Operating System |
| Windows 2000 | Microsoft® Windows® 2000 Operating System |
| MS-DOS | Microsoft® MS-DOS® Operating System |

MANUAL SYMBOLS AND TERMINOLOGY

This manual uses the following symbols and terminology.





■ Safety Symbols and Terms

This manual uses the following symbols and terms to identify important information related to the correct and safe operation of this product.

| Symbol | Description |
|--|--|
|  | Indicates a potentially hazardous situation that could result in serious injury or death. |
|  | Indicates a potentially hazardous situation that could result in minor injury or equipment damage. |
|  | Indicates a potentially damaging action or dangerous situation that could result in abnormal equipment operation or data loss. |
|  | Indicates instructions or procedures that must be performed to ensure correct product use. |
|  | Indicates instructions or procedures that must not be performed. |

■ General Information Symbols and Terms









This manual uses the following symbols and terms for general information.

| Symbol | Description |
|---|---|
|  | Provides hints on correct product use, or supplementary information. |
|  | Indicates an item's related information (manual name, page number). |
|  | Refers to keys on the computer keyboard.  ■ Keyboard Compatibility List |
| External Device | Indicates an external device (temperature controller, inverter, etc.). Does not include devices connected via the Flex Network or DIO. |
| LT | Generic name for the "LogiTouch Series" Graphic Logic Controller made by Digital Electronics Corporation. |
| LT Editor | Indicates LogiTouch Editor Version 1.0 (hereinafter referred as "this product"), LogiTouch integrated development software made by Digital Electronics Corporation. |

■ Keyboard Compatibility List

This manual uses the following symbols to indicate computer keyboard keys.

The key names used by your computer keyboard may differ. Please use the chart below for reference.

| Symbol \ Type | PS/2 Compatible 101 Keyboard |
|---|---|
|  | Esc |
|  | Tab  |
|  | Ctrl |
|  | ↑ Shift |
|  | Alt |
|  | Delete |
|  | Backspace |

LOGITOUCH SERIES

The LT Editor supports the following LT models.

| Series | Type | Product | Model |
|------------------|---------|----------------|------------------------|
| LogiTouch Series | Type-A1 | GLC150B-XY32SK | GLC150-BG41-XY32SK-24V |
| | Type-A1 | GLC150B-XY32SC | GLC150-BG41-XY32SC-24V |
| | Type-B | GLC150B-RSFL | GLC150-BG41-FLEX-24V |
| | Type-C | GLC150B-XY32SK | GLC150-BG41-RSFL-24V |



Note: For the types of external devices supported by the LT Editor, please refer to the "External Device Connection Manual".

Reference *HOW TO USE THIS MANUAL*

HOW TO USE THIS MANUAL

■ Structure of the Manual

The "LogiTouch Editor Ver. 1.0 Operation Manual - Screen Creation Guide" is the first in a series of manuals for this product and explains how to use the LT Editor. There are three other manuals in the series as well as online help. Please refer to "Chapter 1 LT EDITOR FUNDAMENTALS" for an overview of this product.

▼ **Reference** ▲ *1.6 LT Editor Manuals and Help*

In addition to these manuals, data files containing supplemental information on updated functions are also provided. To read these additional data files, click on the [Start] button in your Windows OS main screen and select the [Programs]→[LogiTouch] menu. Then, click on the [Readme] selection.

For detailed information on LT series of operator interfaces, please refer to the "LogiTouch Series User Manual". (Separately sold)

| | | |
|-----------------------------------|--|--|
| Included on CD-Rom | LT Editor Operation Manual (this manual) | Describes the operating procedures for the LT Editor and all functions except for Logic Program development (provided as a PDF file). |
| | LT Editor Programming Manual | Describes logic program development. The manual consists of two parts, "Programming" which focuses on the tutorial lesson to help users to learn the operation procedures, and "Functions" which explains the software settings required for the combination of the LT main unit and the LT Editor (provided as a PDF file). |
| | Parts List | Describes the LT Editor's pre-made Parts and symbols (provided as PDF data). |
| | External Device Connection Manual | Describes the methods for connecting the LT to external devices of various manufacturers (provided as a PDF file). |
| Available on the LT Editor screen | Online Help | Describes the methods for setting the LT Editor's windows and dialog boxes, instructions and functions of logic programs as well as how to set each driver. |



Note:

- Address settings described in these manuals are for explanatory purposes only. Appropriate addresses must be set according to your requirements.

▼ **Reference** ▲ *External Devices Connection Manual*

- If you have any questions about the contents of this manual, please contact your local LT distributor. LT distributors will answer to your technical inquiries and provide you with technical consultation.

▼ **Reference** ▲ *Software Trouble Report*

If you have any question about your personal computer or Microsoft® Windows®, please contact your PC distributor or manufacturer.

■ Chapter Breakdown

This manual contains 10 chapters and an appendix.
The following is a general description of each chapter:

◆ CHAPTER 1: FUNDAMENTALS OF LOGITOUCH EDITOR

This chapter describes the operation of the LT Editor from start to finish. It also explains the overall structure of the LT Editor Project Manager, Logic Program Editor, and Screen Editor areas.

◆ CHAPTER 2: CREATING BASE SCREENS

This chapter describes the basic operations and terminology used for drawing functions, such as “Part”, “Library”, and “D-Script”.

◆ CHAPTER 3: DRAWING APPLICATIONS: CREATING AND USING SCREENS

This chapter describes the procedures for creating and using various screens, such as the M (Mark) Screen and I (Image Library) screens, which enable you to create high-quality images and provide advanced-level functionality.

◆ CHAPTER 4: SCREEN AND PROJECT MANAGEMENT

This chapter describes the procedures for editing and saving created screens and project files, and information management procedure.

◆ CHAPTER 5: CREATING AND EDITING ALARMS

This chapter describes the alarm creating and editing procedures.

◆ CHAPTER 6: LT INITIAL AND SYSTEM SETTINGS

This chapter describes the initial setup procedure required to use the LT display unit. For details, please refer to the online help or the users’ manual for the LT main unit.

◆ CHAPTER 7: TRANSFERRING DATA

This chapter describes the procedures for sending screens and logic programs created with the LT Editor to an LT display unit.

◆ CHAPTER 8: SIMULATION

This chapter describes the procedures for simulating the operation between an LT and LT Editor.

◆ CHAPTER 9: PRINTING

This chapter describes the procedure for printing created screens.

◆ CHAPTER 10: ADVANCED FEATURES

This chapter describes the procedures for using the LT Editor's advanced functions such as filing data (recipe) and logging functions.

◆ APPENDIX

- **Error Messages**

Lists the error messages, causes of the errors and solutions that will be displayed during operation of LT Editor.

- **Troubleshooting**

Provides information for diagnosis and corrective actions for dealing with errors or abnormal operation.

- **Address Conversion Tables**

Lists the addresses for each manufacturer's product.

- **Software Trouble Report**

This is a form in which you can write down any trouble you might have with the LT Editor and your LT Editor's operating conditions that can then be sent to us by facsimile. If you have any inquires about the LT Editor, please use this form.

PRECAUTIONS

■ CD-ROM Usage Precautions

To prevent CD-ROM damage or malfunctions, please observe the following instructions:



- Do not remove the CD-ROM from the CD-ROM drive while the drive's operation lamp is lit.
- Do not touch the CD-ROM recording surface.
- Do not place CD-ROMs in a place where they may be exposed to extremely high or low temperatures, high humidity, or dust.

■ Product Usage Precautions

To prevent program malfunction or accidents, be sure to observe the following instructions:



Warning

Touch panel switches should NOT be used for a device's Emergency Stop Switch. Generally speaking, all industrial machinery/systems must be equipped with a mechanical, manually operated emergency stop switch. Also, for other kinds of systems, similar mechanical switches must be provided to ensure safe operation of those systems.



- Do not turn off your personal computer's power switch during the execution of a program.
- Do not change the contents of this product's project files using the Text Editor software.

◆ Drawing

- The LT Editor's display screen and descriptions used in the manuals are based on the color display when the LT main unit is in the "REVERSE" LCD mode. Please note that white/black color on the LT Editor screen and LT main unit screen will be reversed when the LCD is in the "NORMAL" mode.

▼ **Reference** ▲ "LogiTouch Series User Manual"

- When an LT unit is vertically installed, the panel's coordinates will differ from those used on the screen editor software. Therefore, when you enter screen coordinates using tags or D-Script, please consider the LT's orientation.

(0. 0) on the screen editor software

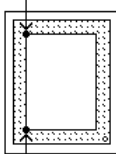

(0. 0) on the LT series' panel

◆ Functions and Settings

- Certain functions and settings supported by the LT unit are not supported by the LT Editor program, and vice versa.

[Setting and functions set via the LT unit (Not by LT Editor)]

- Language Font selection
- LT Date/Time settings
- LT Self-Diagnosis Function

[Functions and settings supported by LT Editor only (Not by the LT unit)]

The following settings are included in the "LT System Settings" area:

- "Checksum Verification" settings
- Screen Change Order in hierarchical display mode
- Screen Change according to standby mode time
- Shift to OFFLINE mode settings
- Setting the frequency of Keypad Display processing performed per scanning time
- LT unit's internal memory (LS area) backup function settings
- "Error Display Reset" settings
- "Watch Dog" settings
- Communication Monitoring Period settings (Designate transmission wait time)

◆ Logic Program Restrictions

- LT variables are handled using 32-bit device Low/High order.
- Display function by parts cannot handle real numbers.
- Values different from the input values may display during monitoring due to the difference in the real number accuracy between a personal computer and the LT.
- If the LT's logic time (scan time) becomes too long, the sampling time designated for the trend graph may not be accurately maintained.
- When using the Memory Link Method, the change in the value of variables cannot be entirely displayed by a trend graph.
- All LT Retentive Variable data is retained by SRAM backup memory that uses a lithium battery. The battery's back up period lasts approximately 60 days in its initial condition (fully charged), and approximately 6 days when the battery life is almost finished. If you need to back up data for a longer period, you need to either use back up data in your host computer, or configure the Editor system so that the Editor can back up data.

TABLE OF CONTENTS

| | |
|--------------------------------------|-----------|
| PREFACE | 1 |
| Trademark Rights | 2 |
| Manual Symbols and Terminology | 3 |
| LogiTouch Series | 4 |
| How to Use This Manual | 5 |
| PRECAUTIONS | 8 |
| TABLE OF CONTENTS | 11 |

CHAPTER1: LT EDITOR FUNDAMENTALS

| | |
|---|-------------|
| 1.1 Overview..... | 1-2 |
| 1.1.2 Prior to Operating the LT | 1-3 |
| 1.2 From Start to Finish..... | 1-4 |
| 1.2.1 Getting Started | 1-4 |
| 1.2.2 Creating/Selecting/Saving a Project | 1-5 |
| 1.2.3 Creating/Editing/Saving a Logic Program | 1-10 |
| 1.2.4 Opening/Closing/Saving a Screen | 1-12 |
| 1.2.5 Quitting LT Editor | 1-17 |
| 1.3 Project Manager | 1-18 |
| 1.3.1 Project Manager Areas and Functions | 1-18 |
| 1.4 Logic Program Editor | 1-20 |
| 1.4.1 Logic Program Editor Item Names and Functions | 1-20 |
| 1.5 Screen Editor..... | 1-22 |
| 1.5.1 Screen Editor Item Names and Functions | 1-23 |
| 1.5.3 Tool/Icon Display | 1-25 |
| 1.5.2 Display Area (50%, 100%, 200%) | 1-25 |
| 1.6 LT Editor Manuals and Help | 1-26 |
| 1.6.1 Browsing Help Topics | 1-27 |
| 1.6.2 Browsing the Home Page | 1-29 |

CHAPTER2: CREATING BASE SCREENS

| | |
|-------------------------------|------------|
| 2.1 Parts | 2-2 |
| 2.1.1 Bit Switches | 2-17 |
| 2.1.2 Word Switches | 2-21 |
| 2.1.3 Function Switches | 2-24 |

Preface

| | | |
|------------|-----------------------------|--------------|
| 2.1 | Parts | 2-2 |
| 2.1.1 | Bit Switches | 2-14 |
| 2.1.2 | Word Switches | 2-17 |
| 2.1.3 | Function Switches | 2-20 |
| 2.1.4 | Lamps | 2-23 |
| 2.1.5 | Bar Graphs | 2-26 |
| 2.1.8 | Pie Graphs | 2-31 |
| 2.1.7 | Half Pie Graphs | 2-36 |
| 2.1.8 | Meters | 2-41 |
| 2.1.9 | Trend Graphs | 2-46 |
| 2.1.10 | Keypad Display | 2-51 |
| 2.1.11 | Alarm Display | 2-57 |
| 2.1.12 | File Name Display | 2-61 |
| 2.1.13 | Data Logging Display | 2-67 |
| 2.1.14 | Numeric Displays | 2-73 |
| 2.1.15 | Message Display | 2-77 |
| 2.1.16 | Date Displays | 2-83 |
| 2.1.17 | Time Displays | 2-86 |
| 2.1.22 | Picture Displays | 2-88 |
| 2.2 | Drawing | 2-94 |
| 2.2.1 | Dot | 2-95 |
| 2.2.2 | Line/Poly-line | 2-96 |
| 2.2.3 | Square/Rectangle | 2-98 |
| 2.2.4 | Circle/Oval | 2-100 |
| 2.2.5 | Arc/Pie | 2-102 |
| 2.2.6 | Fill | 2-104 |
| 2.2.7 | Filled Polygon | 2-106 |
| 2.2.8 | Scale | 2-108 |
| 2.2.9 | Tex | 2-111 |
| 2.2.10 | Load Screens | 2-115 |
| 2.2.11 | Load Mark | 2-118 |
| 2.3 | Object Editing | 2-119 |
| 2.3.1 | Selecting Objects | 2-120 |
| 2.3.2 | Moving Objects | 2-126 |
| 2.3.3 | Scaling Up/Down | 2-127 |
| 2.4.4 | Cut | 2-128 |
| 2.3.5 | Copy | 2-129 |
| 2.3.6 | Paste | 2-130 |

| | | |
|------------|--|--------------|
| 2.3.7 | Pasting Instruction Data | 2-131 |
| 2.3.8 | Duplicate | 2-137 |
| 2.3.9 | Delete | 2-140 |
| 2.3.10 | Align | 2-141 |
| 2.3.11 | Rotate Left/ Rotate Right | 2-142 |
| 2.3.12 | Mirror X/ Mirror Y | 2-143 |
| 2.3.13 | Group/ Ungroup | 2-144 |
| 2.3.14 | Bring to Front/ Send to Back | 2-146 |
| 2.3.15 | Changing Attributes | 2-147 |
| 2.3.16 | Changing Coordinates | 2-149 |
| 2.3.17 | Editing the Node of a Multi-segment Line | 2-150 |
| 2.4.18 | Convert (Import) Bit map | 2-151 |
| 2.3.19 | Transferring a Screen to the Clipboard | 2-153 |
| 2.3.20 | Converting a Screen to a Bitmap File | 2-154 |
| 2.3.21 | Redraw Screen | 2-156 |
| 2.3.22 | Undo | 2-157 |
| 2.3.23 | Redo | 2-157 |
| 2.4 | Library Items | 2-158 |
| 2.4.1 | Registering Library Items | 2-162 |
| 2.4.2 | Placing Library Items | 2-166 |
| 2.4.3 | Editing Library Items | 2-168 |
| 2.4.4 | Saving Libraries and Quitting | 2-173 |
| 2.5 | D-Script/Global D-Script | 2-175 |
| 2.5.1 | D-Script Settings | 2-176 |
| 2.5.2 | D-Script Commands | 2-183 |
| 2.5.3 | D-Script / Global D-Script Limitations | 2-198 |
| 2.5.4 | Notes on Operation Results | 2-200 |
| 2.5.5 | Logical Operation Examples | 2-201 |
| 2.5.6 | Bit Operation Examples | 2-202 |
| 2.5.7 | Conditional Branches | 2-203 |
| 2.5.8 | Application Example (1) | 2-204 |
| 2.6 | Data Sampling..... | 2-207 |
| 2.9.1 | Grid/Snap | 2-207 |
| 2.6.1 | Data Sampling Settings | 2-207 |
| 2.7 | Efficient Drawing Techniques..... | 2-213 |
| 2.9.1 | Grid/Snap | 2-213 |
| 2.7.1 | Grid/Snap | 2-213 |
| 2.7.2 | Screen Property Settings | 2-215 |

Preface

| | | |
|------------|---|--------------|
| 2.7.3 | Preview Screen | 2-219 |
| 2.7.4 | Screen Data List | 2-219 |
| 2.7.5 | Part Reference List | 2-221 |
| 2.7.6 | Data Sampling List | 2-223 |
| 2.7.7 | Cross Reference List | 2-225 |
| 2.7.8 | Load Screen List | 2-228 |
| 2.7.9 | Display of Screen Level Change Structure | 2-229 |
| 2.8 | DXF Conversion | 2-230 |
| 2.8.1 | Conversion from DXF File to Base Screen (DXF® Screen) | 2-230 |
| 2.8.2 | Conversion from Base Screen to DXF File (Screen DXF®) | 2-236 |

CHAPTER 3: DRAWING APPLICATIONS - CREATING and USING SCREENS

| | | |
|------------|---|-------------|
| 3.1 | Creating a Mark: the Mark Screen | 3-2 |
| 3.2 | Creating an Image: the Image Screen..... | 3-23 |

CHAPTER 4: SCREEN AND PROJECT MANAGEMENT

| | | |
|------------|--|-------------|
| 4.1 | Screen Editing | 4-2 |
| 4.1.1 | Listing/Copying/Deleting Screen | 4-2 |
| 4.1.2 | Copying Screens from Other Projects | 4-7 |
| 4.2 | Project Editing | 4-11 |
| 4.2.1 | Deleting Project Files | 4-11 |
| 4.2.2 | Rebuilding A Project (Rebuild)..... | 4-12 |
| 4.2.3 | Converting Addresses and Device Codes | 4-15 |
| 4.2.4 | Convert Load Screens..... | 4-17 |
| 4.2.5 | Symbol Editor | 4-19 |
| 4.2.6 | Changing a Project's LT Type | 4-27 |
| 4.2.7 | Changing Your Project's External Device | 4-28 |
| 4.3 | Project Compression/Decompression | 4-29 |
| 4.3.1 | Compressing a Project File | 4-30 |
| 4.3.2 | Decompressing a Project File | 4-33 |
| 4.4 | Information Display | 4-35 |
| 4.4.1 | Project Information | 4-35 |
| 4.4.2 | Screen Information | 4-37 |
| 4.4.3 | Version Information | 4-37 |

CHAPTER 5 CREATING AND EDITING ALARMS

| | |
|---|------------|
| 5.1 Alarm Creation and Editing | 5-2 |
| 5.1.1 Alarm Editor | 5-2 |
| 5.1.2 Creating an Alarm | 5-4 |
| 5.1.3 Editing Alarm Data | 5-5 |
| 5.1.4 Alarm Import/Export | 5-12 |

CHAPTER 6: LT INITIAL AND SYSTEM SETTINGS

| | |
|---|------------|
| 6.1 Menu Setting Items: LT Setup | 6-2 |
|---|------------|

CHAPTER 7: TRANSFERRING SCREENS

| | |
|--|-------------|
| 7.1 Prior to Transferring Data | 7-2 |
| 7.1.1 LT Screen Transfer Cable | 7-2 |
| 7.2 Transferring Data and Logic Programs | 7-3 |
| 7.2.1 Transfer Settings | 7-4 |
| 7.2.2 Passwords | 7-7 |
| 7.2.3 Transfer Preparation | 7-9 |
| 7.2.4 When Sending Screens and Logic Programs Together To the LT | 7-10 |
| 7.2.5 When Sending Logic Programs | 7-12 |
| 7.2.6 When Receiving Data From the LT | 7-13 |
| 7.2.7 Sending Programs with the Logic Program Editor | 7-14 |
| 7.3 Options | 7-16 |
| 7.3.1 LT Internal Screen Data Information | 7-16 |

CHAPTER 8: SIMULATION

| | |
|--|------------|
| 8.1 Overview | 8-2 |
| 8.1.1 General Description of the Simulation Screen | 8-3 |
| 8.1.2 Transferring Simulation Protocol | 8-8 |
| 8.1.3 Performing a Simulation | 8-9 |

CHAPTER 9: PRINTING

| | |
|---------------------------------|------------|
| 9.1 Print Settings | 9-2 |
| 9.1.1 Printing | 9-2 |
| 9.1.2 Print Preview | 9-6 |

CHAPTER 10: ADVANCED FEATURES

| | |
|--|--------------|
| 10.1 Filing Data (Recipe) | 10-2 |
| 10.1.1 Filing Data (Recipe) Function | 10-3 |
| 10.1.2 Filing Data Setting | 10-9 |
| 10.1.3 Filing Data List | 10-12 |
| 10.1.4 Automatic Filing Data Transmission | 10-15 |
| 10.1.5 Manual Filing Data Transmission Example | 10-16 |
| 10.1.6 Manual Filing Data Transmission Example | 10-22 |
| 10.2 Logging Function | 10-27 |
| 10.2.1 Logging Function | 10-27 |
| 10.2.2 Logging Data Read Timing | 10-31 |
| 10.2.3 Data Logging Settings | 10-32 |
| 10.2.4 Display Settings | 10-44 |

APPENDICES

| | |
|--|-------------|
| A.1 Error Messages | A-2 |
| A.2 Troubleshooting | A-17 |
| A.3 Address Conversion Tables | A-19 |
| A.4 Software Trouble Report | A-25 |

This chapter describes LT Editor basic operations such as how to start and quit the software. It also explains the Project Manager and Screen Editor areas, which are used for the majority of screen creation work. Also, a number of tools are introduced here, such as online help, which provide explanations of LT Editor functions and operations.

| | | |
|-----|-------|-----------------------------------|
| 1.1 | | Overview |
| 1.2 | | From Start to Finish |
| 1.3 | | Project Manager |
| 1.4 | | Logic Program Editor |
| 1.5 | | Screen Editor |
| 1.6 | | LT Editor Manuals and Help |

1.1 Overview

The LT provides I/O control functions and can also be used as an operating panel and a display.

LT Editor is the LogiTouch integrated development software, providing both an LT Logic Programming environment and screen creation and editing capabilities for creating LT display screens.

■ Programming Functions

Utilizing Window's easy-to-use interface, you can quickly and easily develop logic programs that conform to the IEC 1131-3 standard .

LT Editor provides I/O drivers that can be selected according to the LT type.

Logic programs are developed with the LT Editor's Logic Program Editor.

For more information on the Logic Program Editor, please refer to the online help. Also, the "Logic Programming Operation Manual" provides tutorials for learning logic programming procedures as well as providing lists of instructions and variables used in Logic Programs. It also explains the operation of the LT main unit.

■ Drawing Functions

You can create a screen by drawing objects and placing Parts.

A large variety of pre-made Parts and D-Scripts allow you to quickly display various operations and objects.

A set of logic programs created with the Logic Program Editor and a Part's display function enable you to make a drawing that corresponds to logic program operations. For example, you can show the variables on the LT screen and set a value to the variable using a touch panel switch.

1.1.1 Prior to Operating the LT

Follow the procedure below to create projects for the LT unit.

- 1. Preparation** – Before using the LT, make sure that you have all the required hardware and have read all the specifications, wiring, and installation information.

▼ **Reference** ▲ *Chapter 2 – “Specifications” and Chapter 3 – “Installation and Wiring”*

- 2. Design Screen** – Design a screen layout and create a logic program.

- 3. Install the LT Editor** – Install the LT Editor on a PC.

▼ **Reference** ▲ *LogiTouch Editor CD Jacket (included with the LT Editor)*

- 4. Develop Logic Program** – Use the LT Editor to develop a logic program and set the operation mode.

▼ **Reference** ▲ *LogiTouch Editor Operation Manual – Logic Programming Guide*

- 5. Create Screen/Run Screen Setup** – Use the LT Editor to set up the screen and parts based on your screen design.

▼ **Reference** ▲ *LogiTouch Editor Operation Manual – Screen Creation Guide*

- 6. Transfer the Screen Data and a Logic Program** – Use the LT Editor on your PC to transfer the data and a logic program to the LT unit.

▼ **Reference** ▲ *LogiTouch Editor Operation Manual – Screen Creation Guide*

- 7. Monitor Logic Program** – Check the transferred logic program through the monitor feature of the LT Editor.

▼ **Reference** ▲ *LogiTouch Editor Operation Manual – Logic Programming Guide*

- 8. Initialize the LT** – Initialize the LT, based on how you will use it.

▼ **Reference** ▲ *Chapter 6 – “Initializing the LogiTouch” and LT Editor External Device Connection Manual*

- 9. Operation** – Run the LT by connecting it to an External Device.

▼ **Reference** ▲ *LT Editor External Device Connection Manual*

1.2 From Start to Finish

This section describes the LT Editor program’s operation flow from start to finish.

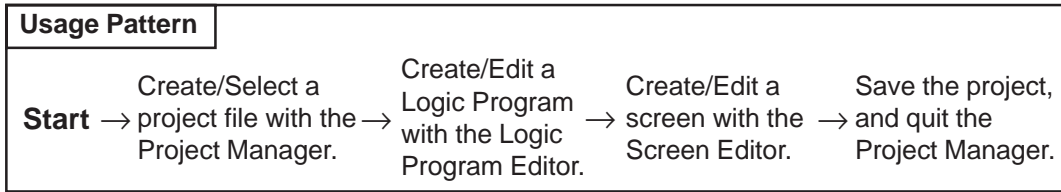

1.2.1 Getting Started

■ Starting LT Editor

The following explanation assumes your PC is turned on and the Windows desktop has appeared.

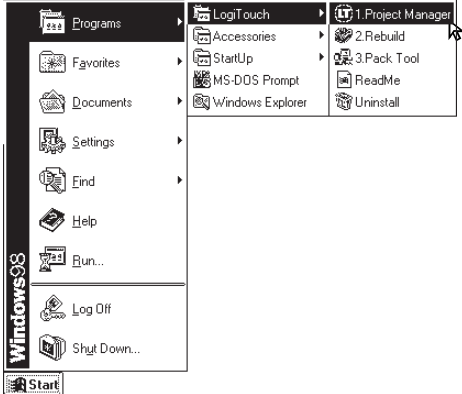
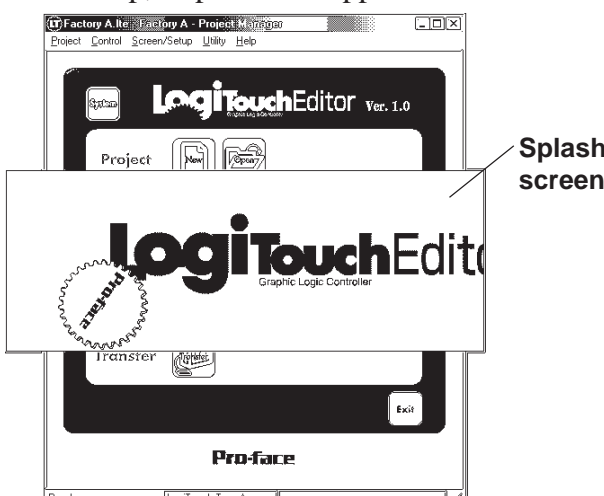
| PROCEDURE | REMARKS |
|--|---|
| <p>(1) Click on the [Start] button, and point to the [Programs] - [LogiTouch] menu. Then, click on the [1. Project Manager] command.</p>  | <p>If you double-click directly on a previously made project file (*.ltx file) in Windows Explorer, LT Editor will automatically start.</p> |
| <p>(2) The Project Manager starts.</p> <p>At start-up, a splash will appear.</p>  | <p>Click on the splash screen to close it.</p> |

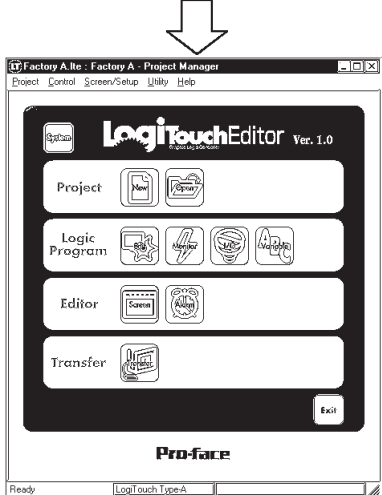
| PROCEDURE | REMARKS |
|---|--|
|  | <p>When 256 colors is selected on the [Display Properties] screen of the Control Panel, the display of the Project Manager may change, but its functioning will not be affected.</p> |

1.2.2 Creating/Selecting/Saving a Project

A project file (LTE file) normally contains multiple screens and a logic program intended for the operation of a certain system. LT Editor creates one project file for the operation of one system, enabling system management by project file units.

After you have transferred a project file and set up an LT, you can transfer updated logic programs individually to the LT.

■ **Creating a New Project**

When you create a new project, you must designate the LT and External Device information, according to your current application.

◆ **LT Type**

Select your type of LT.

▼ **Reference** ▲ *LogiTouch Series*

If your LT will be installed vertically instead of horizontally, be sure to select a vertical type LT. The Screen Editor will automatically create a vertical drawing area for you.

| LT machine type | LT type of project |
|-----------------|--------------------|
| Type-A1 | LogiTouch Type-A |
| Type-A2 | |
| Type-B | LogiTouch Type-B |
| Type-C | LogiTouch Type-C |

◆ **External Device Type**

Select the type of External Device to be connected to your LT unit.

This setting is required only when the LT is a Type-C.

▼ **Reference** ▲

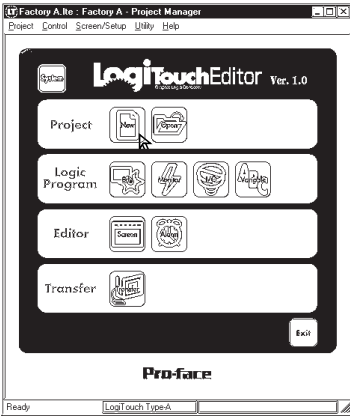
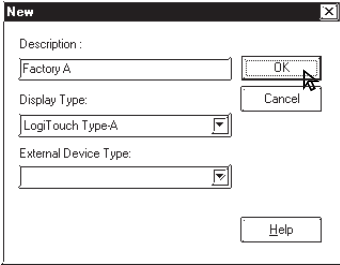
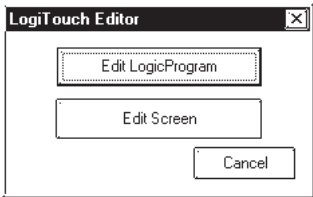
| PROCEDURE | REMARKS |
|--|--|
| <p>(1) Select the Project Manger's [Project] menu - [New] command, or click on .</p>  <p>(2) Enter a description and select the LT (Display) and External Device. Then, click on <input type="button" value="OK"/>.</p>  <p>(3)The LT Editor will then ask you if you wish to create a logic program or a screen. If you click on the <input type="button" value="Edit LogicProgram"/> button, the Logic Program Editor will start. If you click on the <input type="button" value="Edit Screen"/> button, the Screen Editor will start. If you click on the <input type="button" value="Cancel"/> button, you will go back to the Project Manager Screen.</p>  | <p>When entering a description, you can use up to 60 single-byte characters.</p> <p>Reference To set the External Device, see “<i>LT Editor External Device Connection Manual</i>”.</p> <p>Reference 1.2.3 Creating/Editing/Saving a Logic Program, 1.2.4 Opening/Closing/Saving a screen.</p> |



Note:

If you attempt to create another project file without saving a newly created project file, the system asks if you wish to save the current file. If you click on the button, the [Save As] dialog box appears. If you click on the button, the system opens a new screen without saving the current project file.

Reference 1.2.2 ■ *Saving a Project File under a Different Name*

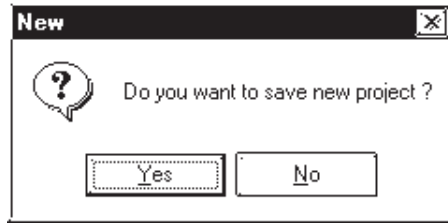

■ **Selecting an Existing Project**

Select the Project Manger's [Project] menu - [Select] command, or click on



. When you select a project, the following setting screen appears:

Used to select the folder containing the target project file

Lists the current folder and existing project files

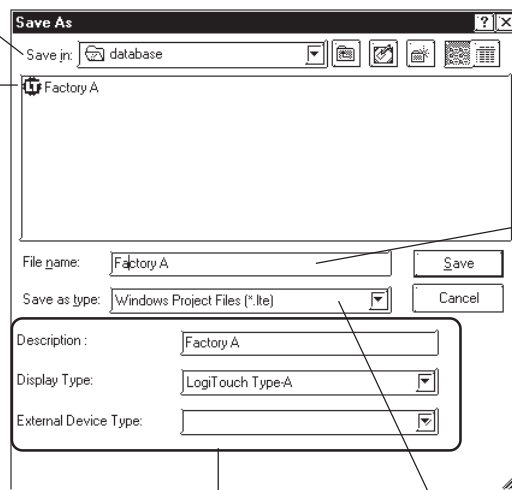

Displays the project file name selected from the list. You can specify the project file by typing the file name.

Displays the project file's comment and the selected LT unit and External Devices

Used to select the project file type desired

◆ **File Types**

The only project file that can be selected is the one created with the LT Editor (*.lte).







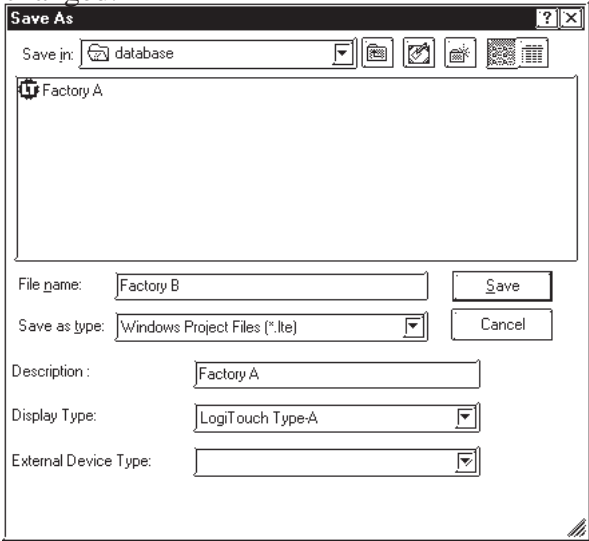
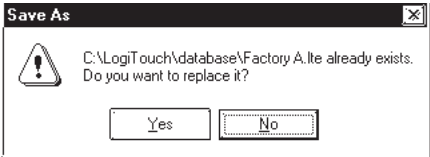

Note:

Double-clicking on the file (project file: *.lte) itself in Explorer automatically starts LT Editor and opens the file.

■ **Saving a Project File under a Different Name**

You can save an existing project file under a different name or with different LT type/External Device settings.

| PROCEDURE | REMARKS |
|---|--|
| <p>(1) Select the [Project] menu - [Save As] command in the Project Manager.</p> <p>(2) The comment, LT type and External Device of the currently opened project file are displayed.</p> <p>Enter the desired file name, and enter the items to be changed.</p>  <p>(3) Click on the <input type="button" value="Save"/> button to save the file.</p> <p>If a project file with the same name exists, LT Editor will ask if you want to replace (overwrite) the existing project file with the project file you are attempting to save.</p> <p>If so, click on the <input type="button" value="Yes"/> button. If you do not wish to overwrite the existing project file, click on the <input type="button" value="No"/> button.</p>  | <p>The file name can contain up to 255 characters (including the path-name and extension.)</p> <p> Important <i>Before changing the LT type, check the preset data, since the drawing area and functions vary depending on the type of the LT unit.</i></p> <p> Reference 4.2.6 Changing a Project's LT Type</p> <p> Important <i>Once the External Device is changed, you must change the addresses of the Parts, D-Scripts and alarms, and perform the LT system setup again.</i></p> <p> Reference 4.2.7 Changing Your Project's External Device</p> <p> Reference To open another project file, see "1.2.2 ■ Creating a New Project or ■ Selecting an Existing Project".</p> <p> Reference To close LT EDITOR for Windows, see "1.2.5 Quitting LT Editor for Windows".</p> |



- When a Vertical LT unit is replaced with the horizontal type, or vice-versa, the displayed screen will rotate 90° relative to the original data. In this case, you must edit the displayed data using the [Rotate] command. After editing, be sure to check the displayed data.

Example)

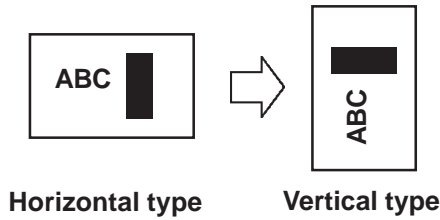

1.2.3 Creating/Editing/Saving a Logic Program



To create a logic program, you must move from the Project Manager to the Logic Program Editor. Only one logic program can be created for one project.

■ Creating/Editing a Logic Program

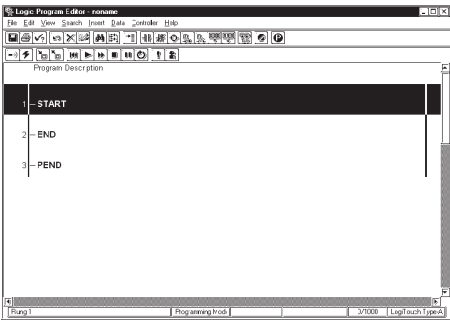
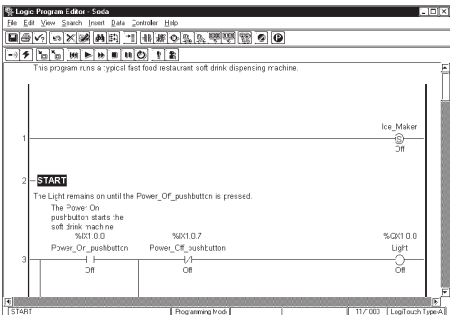

When the Logic Program Editor is started, the logic program being created in the current project file is displayed.

| PROCEDURE | REMARKS |
|---|--|
| <p>(1) Select the Project Manager's [Controls] menu-[Create/Edit Controls] command, or click on  .</p> <p>The Logic Program Editor starts.</p>  | |
| <p>(2) Create/Edit a logic program.</p> <p>You can insert a rung and instructions as well as set I/O configuration.</p>  | <p>For details on logic program development, please refer to the "Logic Programming Operation Manual".</p> |

■ Saving a Logic Program

| PROCEDURE | REMARKS |
|---|---|
| <p>(1) Select the Logic Program Editor's [File] menu- [Save(s)] command, or click on  .</p> <p>The logic program you are saving will replace the existing program.</p> | <p>After saving the program, the Logic Program Editor remains open.</p> <p>When saving a logic program, variables registered with the Logic Program Editor will be registered with the Symbol Editor as Logic symbols.</p> <p>Reference 4.2.5 Symbol Editor</p> <p> <i>important</i></p> <p>When variables are used in a drawing, be sure to make a drawing after saving a logic program.</p> |

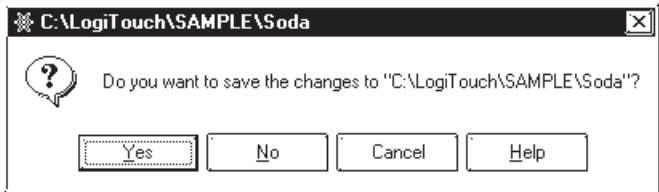



■ Closing a Logic Program

| PROCEDURE | REMARKS |
|--|--|
| <p>(1) Select the Logic Program Editor's [File] menu - [Exit] command.</p> <p>(2) The Logic Program Editor will close.</p> <p>If you attempt to close an updated logic program without saving it, the system asks if you wish to save the current program. If you click on the <input type="button" value="Yes"/> button, the system saves the updated data. If you click on the <input type="button" value="No"/> button, the system closes the Logic Program Editor without saving the updated data.</p>  | <p>You can also close the logic program by clicking on the x button at the upper right corner of the Logic Program Editor.</p> <p>When saving a logic program, variables registered with the Logic Program Editor will be registered with the Symbol Editor as Logic symbols.</p> <p>Reference 4.2.5 Symbol Editor</p> <p> <i>important</i></p> <p>When variables are used in a drawing, be sure to make a drawing after saving a logic program.</p> |

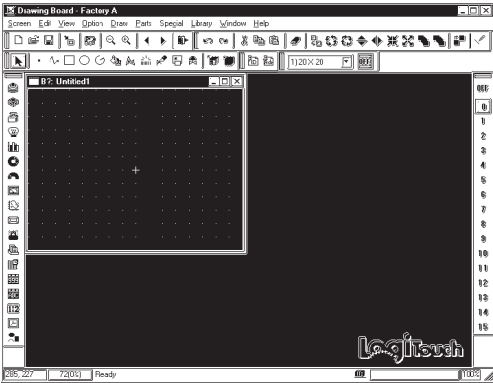

1.2.4 Opening/Closing/Saving a Screen

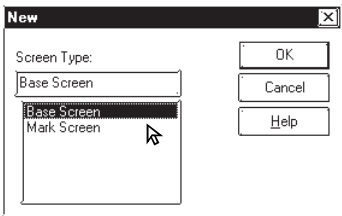
To create a screen, you must switch from the Project Manager to the Screen Editor, and open a screen. This section describes the procedures for opening, closing, and saving a screen.

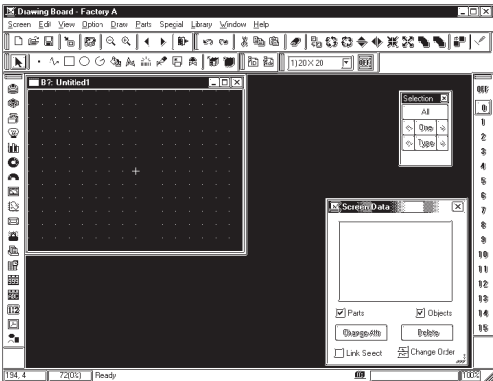
■ Opening a New Screen

| PROCEDURE | REMARKS |
|---|---|
| <p>(1) Select the Project Manger's [Screen/Setup] menu - [Editor] command, or click on .</p> <p>The Screen Editor's opening screen will appear.</p>  | <p>When the Screen Editor has already been started, skip step (1).</p> |
| <p>(2) Select the Screen Editor [Screen] menu's - [New] command, or click on .</p> <p>(3) Select the screen type.</p>  | <p>Selecting the [Screen] menu's - [Open] command or clicking on  and entering an unregistered screen number can also be used to open a new screen.</p> <p>Enter the screen number and title when saving the screen.</p> <p>▼Reference▲ 1.2.4 ■ Saving a Screen under a Different Name</p> |
| <p>(4) Click on the  button to create the desired type of screen.</p> <p>A screen corresponding to the designated LT type will appear.</p>  | <p>Up to twenty screens can be simultaneously opened.</p> <p>Multiple types of windows can be opened on any one screen at the same time.</p> |

■ Opening a Previously Saved Screen

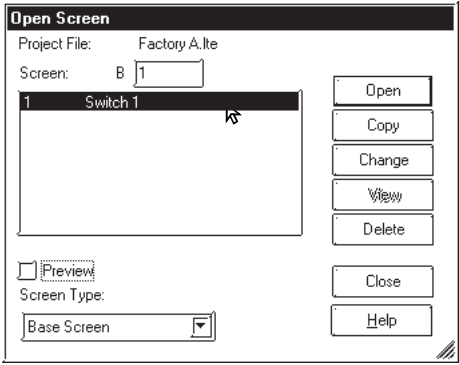
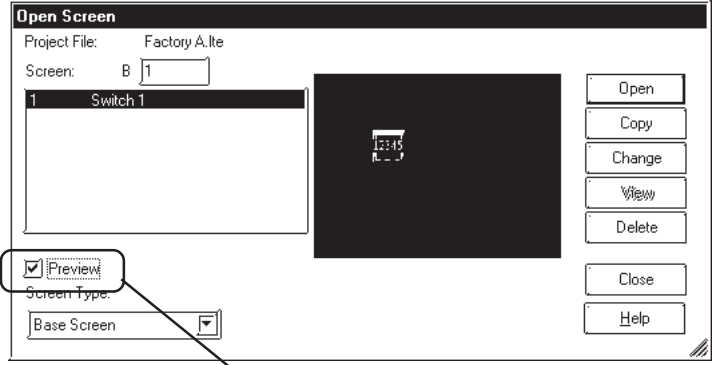
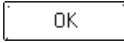
| PROCEDURE | REMARKS |
|--|--|
| <p>(1) Select the [Screen/Setup] menu's - [Editor] command, or click on  in the Project Manager. The Screen Editor's opening screen will appear.</p> <p>(2) Select the [Screen] menu's - [Open] command or click on .</p> <p>(3) Use this screen to select a screen name from the list, or select the screen type and enter the screen number. When checking the [Preview] check box, the selected screen image can be viewed in the dialog box.</p>  <p style="text-align: center;">↓</p>  <p style="text-align: center;">Preview Check Box</p> | <p>When the Screen Editor has already been started, skip step (1).</p> <p>When you double-click on the desired screen number in step (3), you can skip the operation of the  button.</p> <p>If you enter a screen number that has not been registered in the list, a new screen will be opened and that number will be assigned to it.</p> <p>When selecting multiple screens, a screen with the smallest screen number of them will be displayed.</p> |

| PROCEDURE | REMARKS |
|-----------|---------|
|-----------|---------|

(4) Click on the **Open** button to open the screen.

The selected screen will open.

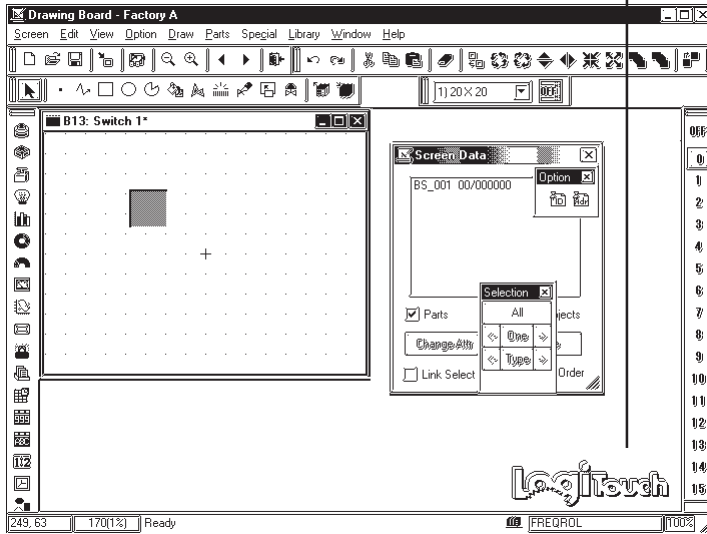

Note:

Up to twenty screens can be open at the same time.

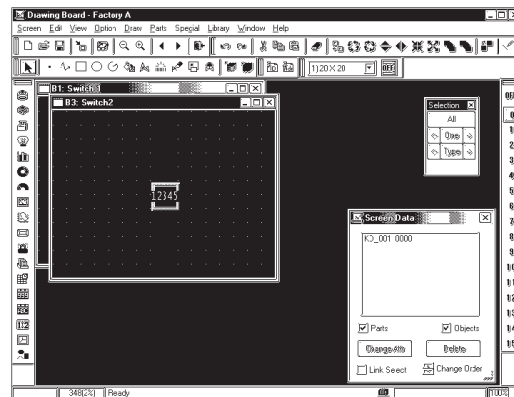
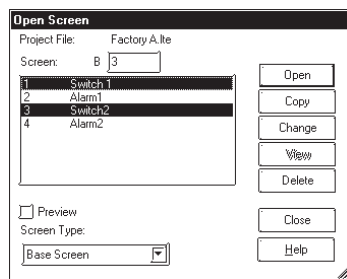

To select several screens simultaneously, while pressing the **Shift** key, click on a screen and drag the mouse over desired adjacent screens; or, you can select screens individually by clicking on them while pressing the **Ctrl** key.



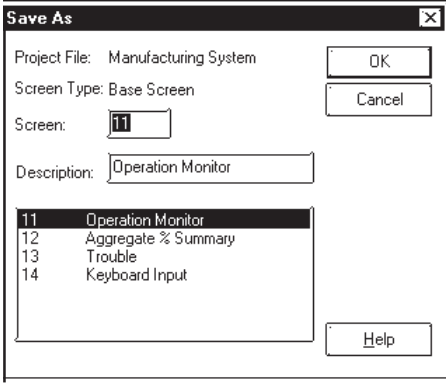
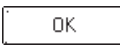
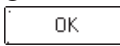
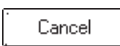

■ Saving a Screen

| PROCEDURE | REMARKS |
|--|---|
| <p>(1) Select the [Screen] menu- [Save] command, or click on  in the Screen Editor</p> <p>The current screen will be saved, overwriting the previous one.</p> | <p>After the screen is saved, it will remain open.</p> <p>When you attempt to save a new screen, the [Save As] dialog box will appear.</p> <p>Reference 1.2.4 ■ Saving a Screen under a Different Name</p> |

■ Saving a Screen under a Different Name

| PROCEDURE | REMARKS |
|---|--|
| <p>(1) Select the [Screen] menu - [Save As] command in the Screen Editor.</p> <p>(2) The type, number, and title of the current screen is displayed.</p> <p>You can change the setting of a desired item; however, the screen’s type cannot be changed.</p>  <p>(3) Click on the  button to register the above settings.</p> <p>If a screen with the same number exists, the system asks if you want to replace the existing screen with the screen you are attempting to save. If so, click on the  button. If you do not wish to overwrite the existing screen, click on the  button.</p>  | <p>A “,” (comma) cannot be used in a description.</p> <p>After the screen is saved, it will remain open.</p> <p>If the screen is saved as a different screen number, the screen of the updated number will be displayed.</p> |

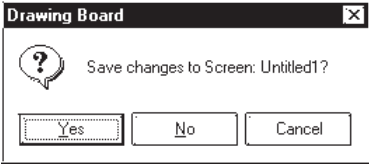
■ Closing a Screen

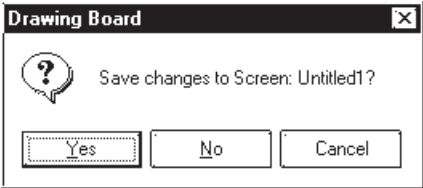

| PROCEDURE | REMARKS |
|---|--|
| <p>(1) Select the [Screen] menu - [Close] command in the Screen Editor.</p> <p>(2) The screen will close.</p> <p>If you attempt to close an updated screen without saving it, the system asks if you wish to save the current screen. If you click on the <input type="button" value="Yes"/> button, the system saves the updated data. If you click on the <input type="button" value="No"/> button, the system closes the screen without saving the updated data.</p>  | <p>You can also close the screen by clicking on the  button at the upper right corner of the window (drawing area).</p> <p>When you attempt to save a new screen, the [Save As] dialog box appears.</p> <p>Reference 1.2.4 ■ <i>Saving a Screen under a Different Name</i></p> |

■ Quitting the Screen Editor

| PROCEDURE | REMARKS |
|--|--|
| <p>(1) Select the [Screen] menu - [Exit] command, or click on  in the Screen Editor.</p> <p>(2) The Screen Editor will close.</p> <p>If you attempt to close the Screen Editor without first saving the currently edited screen, LT Editor asks if you wish to save the updated screen. If you click on the <input type="button" value="Yes"/> button, LT Editor saves the updated data. If you click on the <input type="button" value="No"/> button, LT Editor quits the Screen Editor without saving the updated data.</p>  | <p>When you save a new screen, the [Save As] dialog box appears.</p> <p>Reference 1.2.4 ■ <i>Saving a Screen under a Different Name</i></p> |

1.2.5 Quitting LT Editor

■ **Quitting LT Editor**

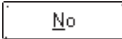
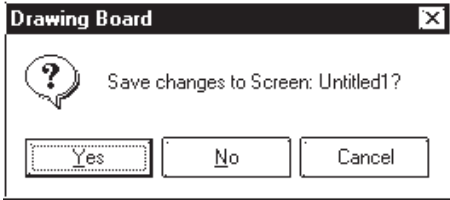
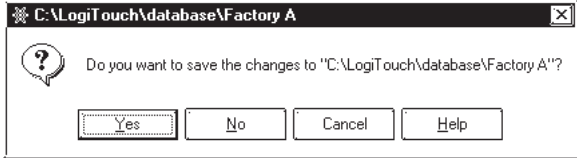
| PROCEDURE | REMARKS |
|---|--|
| <p>(1) Select the [Project] menu - [Exit] command, or click on  in the Project Manager.</p> <p>(2) The Project Manger will quit.</p> <p>If you attempt to close the Project Manager without saving the currently opened screen’s updated data, LT Editor asks if you wish to save your project’s data. If you click on the  button, LT Editor saves the updated data. If you click on the  button, LT Editor quits (closes) without saving the updated data.</p> <p>Saving the screen</p>  <p>Saving the Logic Program</p>  | <p>When you are working on the Screen Editor or the Logic Program Editor, quit the Screen Editor or the Logic Program Editor, or select the Project Manager.</p> <p>Reference 1.2.4 ■ <i>Quitting the Screen Editor</i></p> |

1.3 Project Manager

All LT Editor system level settings and functions are controlled via the Project Manager.

1.3.1 Project Manager Areas and Functions

Here, each of the Project Manager's features is explained. To begin working with LT Editor, simply click on the desired button.

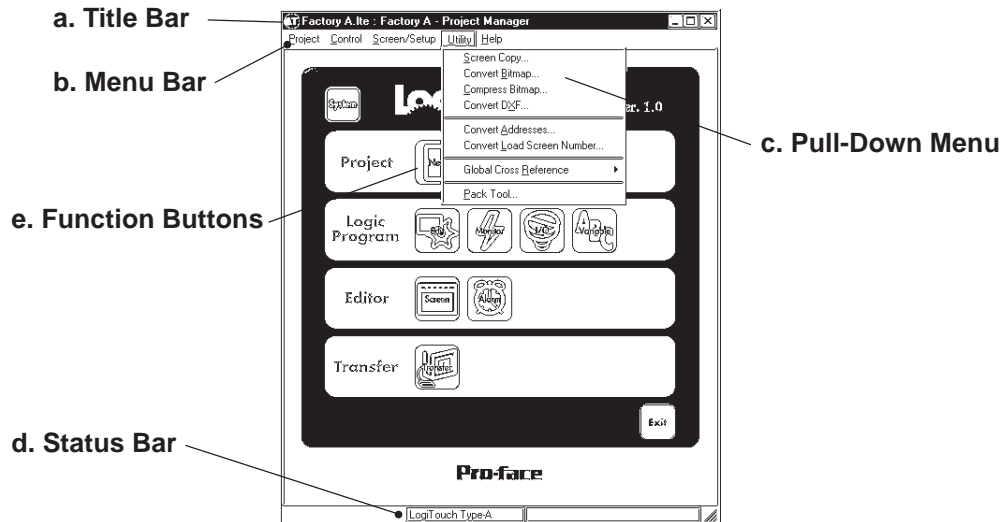

a. Title Bar:

Displays the current project's file name and title.

b. Menu Bar:

Displays the menus used for the operation of LT Editor. When you select a desired menu using the mouse or keyboard, one of the pull-down menus described below will appear.

c. Pull-Down Menu:

When you select a desired item on the menu bar, its pull-down menu appears. These menus include a variety of commands.

d. Status Bar:

Displays LT and External Devices as well as LT Editor operation related messages.

e. Function Buttons

These buttons indicate the LT Editor program’s main functions (e.g. creating screens, alarms, printing, etc.). You can start each function by simply clicking on that function’s button. You can also start these functions by selecting the corresponding command from the Project Manager’s pull-down menu.

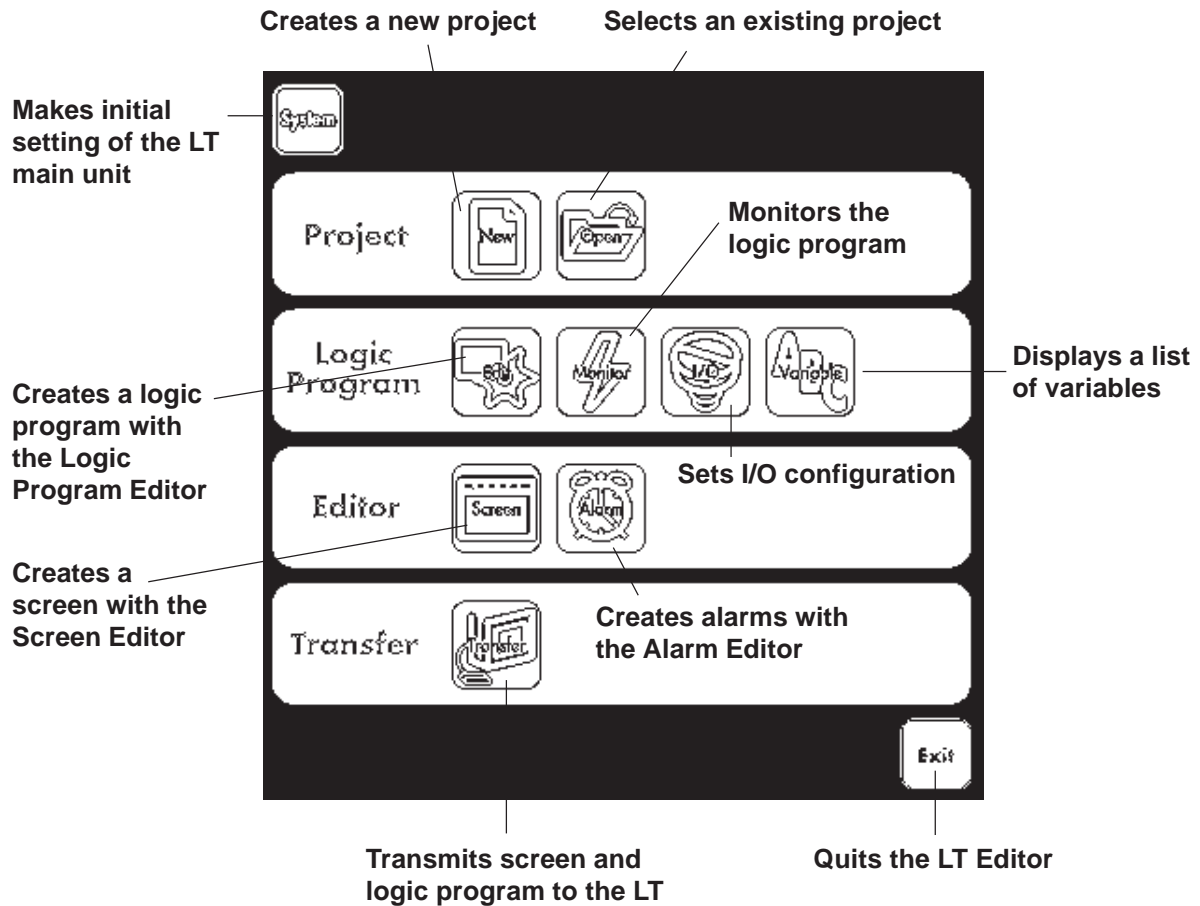

1.4 Logic Program Editor

Logic programs are created with the Logic Program Editor.

The online help provides you with detailed information on the Logic Program Editor.

Also, the "Logic Programming Operation Manual" explains procedures using tutorials. It also explains instructions and settings required for combining the LT main unit with the LT Editor.

1.4.1 Logic Program Editor Item Names and Functions

Here, basic item names and functions of the Logic Program Editor main window are explained.

Reference For details, please refer to online help.

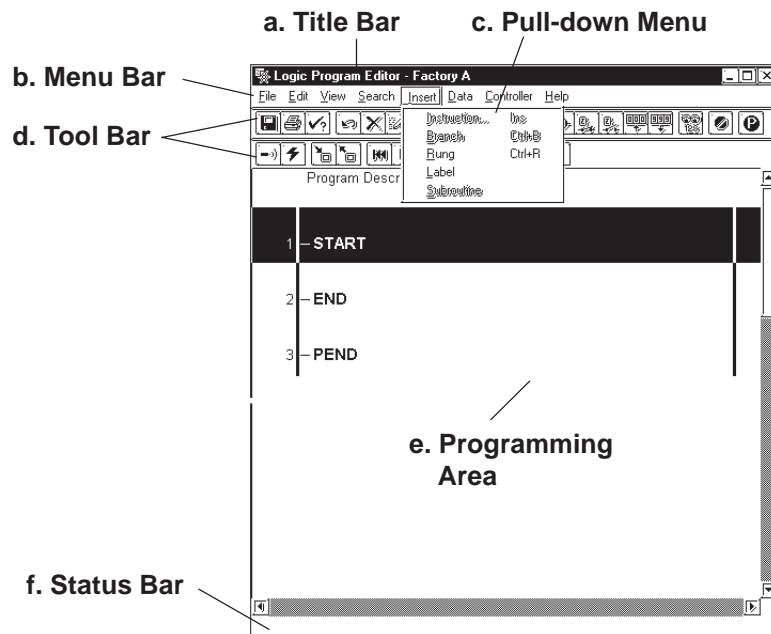

a. Title Bar

Displays the project file name, screen number and title.

b. Menu Bar

Displays the menus used to operate LT Editor. When you select a desired menu using the mouse or keypad, the pull-down menu (c) appears.

c. Pull-down Menu

When you select a desired menu from the menu bar, the pull-down menu appears. This menu includes various commands.

d. Tool Bar

The Tool Bar provides icons representing such commands as Creating/Editing a Logic Program and RUN/STOP. Clicking one of these icons performs that command. The Tool Bar can either be hidden or displayed.

e. Programming Area

Creates a logic program.

The entire program may not display depending on the size of the window or program. In such cases, use the window's scroll bar to change the display area.

f. Status Bar

Displays information on the edited logic program and messages concerning the operation.

1.5 Screen Editor

To create a screen, start the Screen Editor via the Project Manager.

There are three types of screens used for different purposes; Base Screen, Mark Screen and Image Screen.

| Screen Type | Screen Number | Contents | Maximum Size per Screen |
|------------------|---------------|--|-------------------------|
| Base(B) Screen | B1 to B8999 | This screen is displayed when the LT is in RUN mode. Shared drawings and Active images loaded on another base screen can be used. One part of a Base Screen can be registered as a window. | Approx. 16 KB |
| Mark (M) Screen | M1 to M8999 | Used to create marks and foreign characters on a 48 x 48 dot screen. These marks and foreign characters are displayed as still or Active images on a Base Screen. | 576 bytes max. |
| Image (I) Screen | I1 to I8999 | Bitmap image data can be registered here as LT screen data. Image screens are displayed as still or Active images on a Base Screen. | Approx. 58 KB |



Note:

- *Although screen files can be numbered from 1 to 8999, the maximum number of screens that can be created for and used by a LT depends on your PC's hard disk capacity and the amount of RAM (memory) available.*
- *The number of screens that can be transferred to the LT will depend on how much internal memory the LT has. The actual screen size and total number of transferable screens can be viewed in the "Project Manager" window by selecting the [Project] menu, and then [Project Information].*

Reference 4.4.1 ■ Project Information

1.5.1 Screen Editor Item Names and Functions

The names and functions of the LT Editor editor's screen items are as follows:

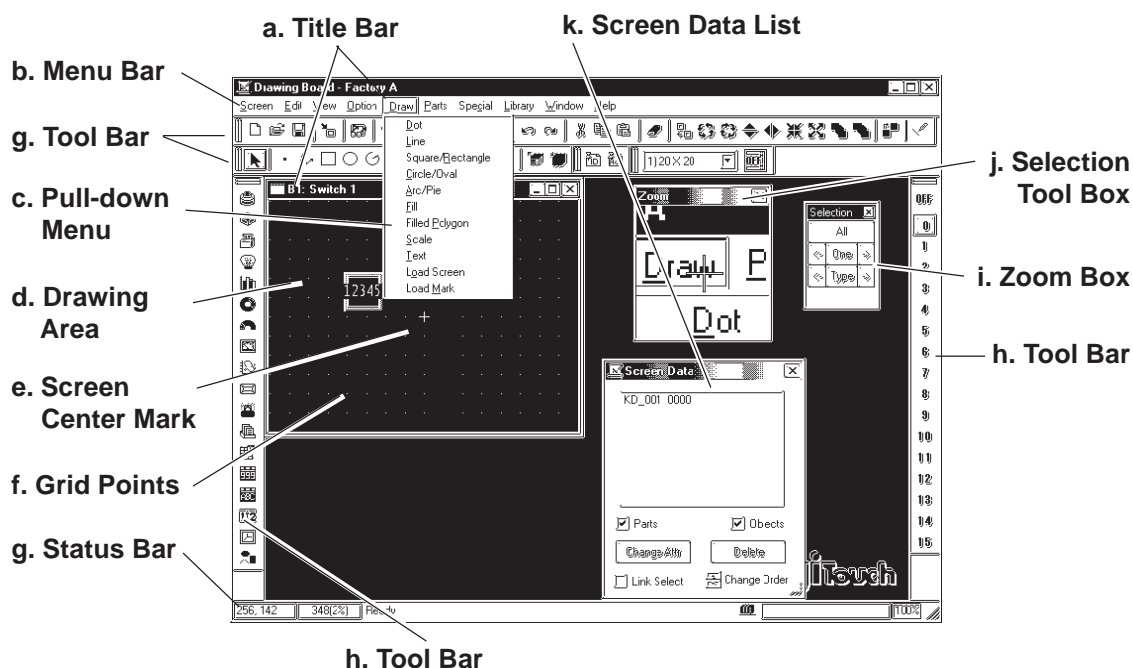

a. Title Bar

Displays the project file name, screen number and title.

b. Menu Bar

Displays the menus used to operate LT Editor. When you select a desired menu using the mouse or keypad, the pull-down menu (c) appears.

c. Pull-down Menu

When you select a desired menu from the menu bar, the pull-down menu appears. This menu includes various commands.

d. Drawing Area

Here, you can create a screen for your LT unit. The size of the screen you see here is designated via the "LT Type" setting you entered when you first created the project file.

Depending on the size of your PC's display, the screen's entire display area may not be displayed. In this case, simply scroll up or down to view the entire screen.

e. Screen Center Mark

Indicates the center of the screen. This mark is not displayed when the data is sent to the LT unit.

f. Grid Points

Used as reference points when you draw or paste an object in the drawing mode. Grid points will not be displayed on the LT unit's screen. The Option area's "Snap" function allows you to position your screen objects using a pre-made grid. You can also set the interval and display ON/OFF status of the grid points.

Reference 2.7.1 Grid/Snap

g. Status Bar

Displays information related to the current screen and provides messages explaining the screen operation you are currently performing.

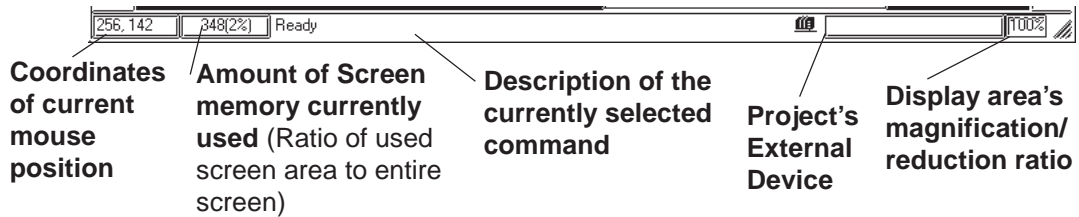

h. Tool Bar

The Tool Bar provides easy to use icons for drawing and editing. Clicking on one of these icons performs that command. The Tool Bar can either be hidden or displayed, and individual Tool Bar areas can be moved freely around the Screen Editor screen, i.e. top, bottom, left, or right.

The following Tool Bar areas are available:

- Main Tool Bar
- Edit Tool Bar
- Draw Tool Bar
- Option Tool Bar
- Grid/Snap Tool Bar
- Parts Tool Bar
- Parts State Change Tool Bar

i. Zoom Box

Shows the cursor's current position at three times magnification.

j. Selection Tool Box

Used to select objects to be edited (Parts and figures). Using the commands included in this tool box, you can select objects using a variety of methods.



k. Screen Data List

Lists the settings and layout conditions of the objects (Parts and figures) that have been arranged on the screen. You can select a desired object from the list.

Reference 2.7.4 Screen Data List

1.5.2 Display Area (50%, 100%, 200%)

You can enlarge or reduce the drawing area by selecting a magnification/reduction ratio.

To change the display area, select the  or  icon on the tool bar, or select the [50%], [100%], or [200%] command from the [View] menu.

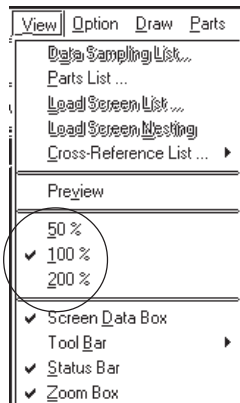

Zoom out Zoom in

Zoom out: Used to reduce the current display area to 50%.

Zoom in: Used to enlarge the current display area to 200%.



Note: In the [50%] display mode, the created screen data is reduced. In this case, the displayed screen data may be different from the actual data. We recommend you to use a [100%] or larger display area.

1.5.3 Tool/Icon Display

The Parts tool box, tool bar, and status bar can be designated as either shown (displayed) or not shown (not displayed). Each time you select the [View] menu's [Screen Data Box], [Status Bar], or [Zoom Box], as well as the [Tool Bar] command's [Main], [Edit], [Draw], [Option], [Grid/Snap], [Parts], or [Parts State Change] sub-commands, these View/Hide settings will toggle ON or OFF.

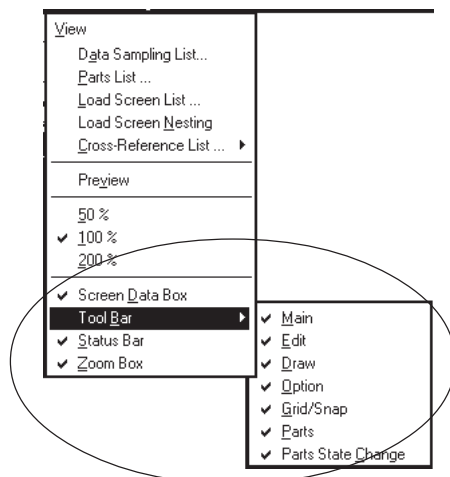

1.6 LT Editor Manuals and Help

While you are learning how to use the LT Editor software, please refer to the following learning aids:

- Related User Manuals
- On-line Help Topics
- Digital's Home Page

For the help concerning the operation of the Windows operating system, see the Windows software's manuals and help screens.

■ Using LT Editor Manuals

The following manuals have been created for the LT Editor software.

CD Jacket: Describes LT Editor's installation procedures and system requirements.

Drawing Operation Manual: Provides detailed explanation of operating procedures for all LT Editor's commands except those for logic program development.

Logic Programming Operation Manual: Provides tutorials to help you to learn operating procedures of Logic Program Editor. Also describes operation of the LT main unit as well as instructions and variables used in logic programs.

Parts List: Describes the LT Editor's pre-made Parts and symbols.

External Device Connection Manual: Describes the methods for connecting the LT to the external devices of various manufacturers and system requirements.

■ Using the Help Feature

If you have any problems or questions during LT Editor operation, you can view the explanations for each feature and setting via each window's Help button, or from the main menu's Help feature.

The Help explains settings of each window and dialog box, instructions and functions of a logic program as well as each driver's setting.

■ Using the Home Page

You can obtain the latest LT Editor information by addressing the Digital Electronics Corporation Home Page on the LT Editor screen.

1.6.1 Browsing Help Topics

To display the help screen, select the [Help] menu or click on the  button in the dialog box.



- **When multiple screens are loaded or many Parts have been registered on the screens, the PC's system memory may not be sufficient to display the help screen.**
- **If you jump from one topic to another on the help screen, an error message may be displayed. When this happens, simply quit and then re-start help.**

■ Searching for a Topic and then Display Help

Select the [Help Topics] command from the [Help] menu, or press the [F1] key. A list of help topics will be displayed.

You can search for a topic by either trying to find it from the table of contents, or entering a keyword for that topic.

◆ Searching for a Topic from the Contents Menu

To select a topic from the contents menu, double-click on the [Contents] tab. Follow the screen instructions to search for a desired topic.

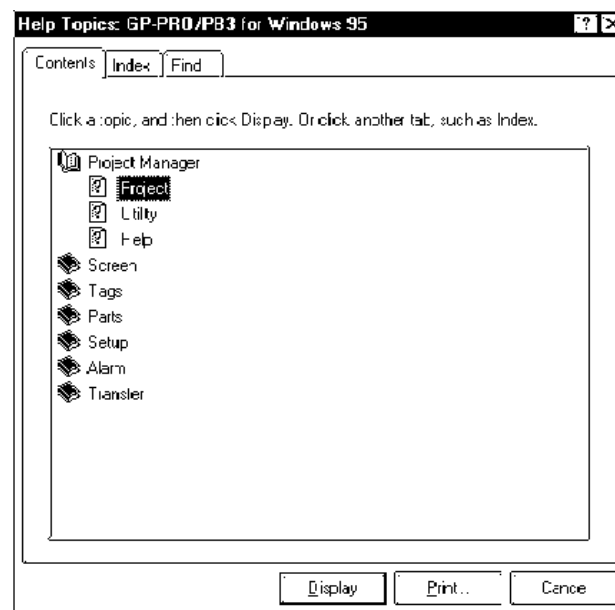

◆ Searching for a Topic by a Keyword

To enter a keyword, click on the [Index] tab.
 Search for a desired topic according to the instruction indicated on the screen.
 (When you enter initial characters of the keyword, the topics specified with these initial characters are also automatically listed)

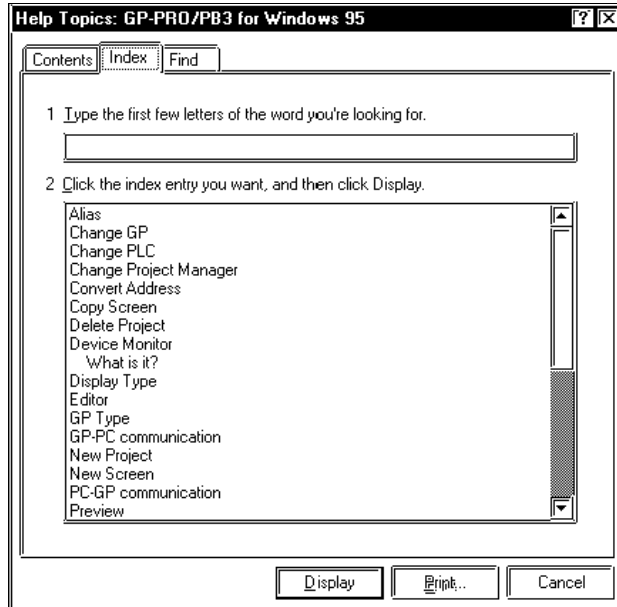

■ Calling up Help from a Dialog Box

When you click on the button in the dialog box or press the [F1] key during execution of a command, a description of the currently-executed command will be displayed.

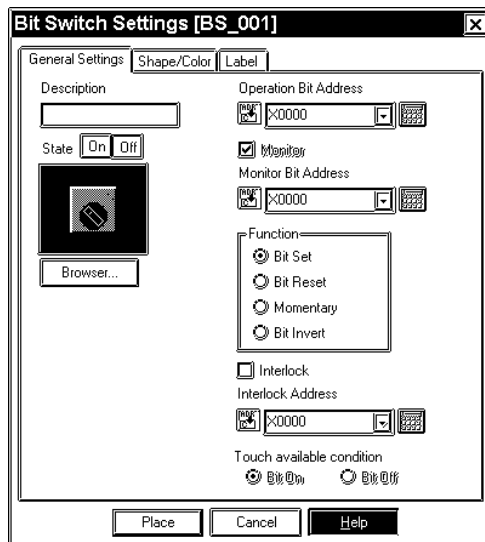

1.6.2 Browsing the Home Page

The procedure to connect to Digital Electronic Corporation's home page is described here.



- **To browse the home page, you must have hardware environment to access the Internet. You also must have a browser to view the home page, and subscribe to an Internet provider.**
- **Please understand that Digital Electronics Corporation cannot respond to any questions about your Internet connection.**

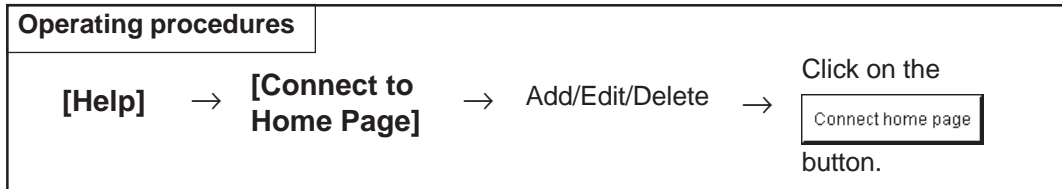

Overview of the Home Page Connection screen:

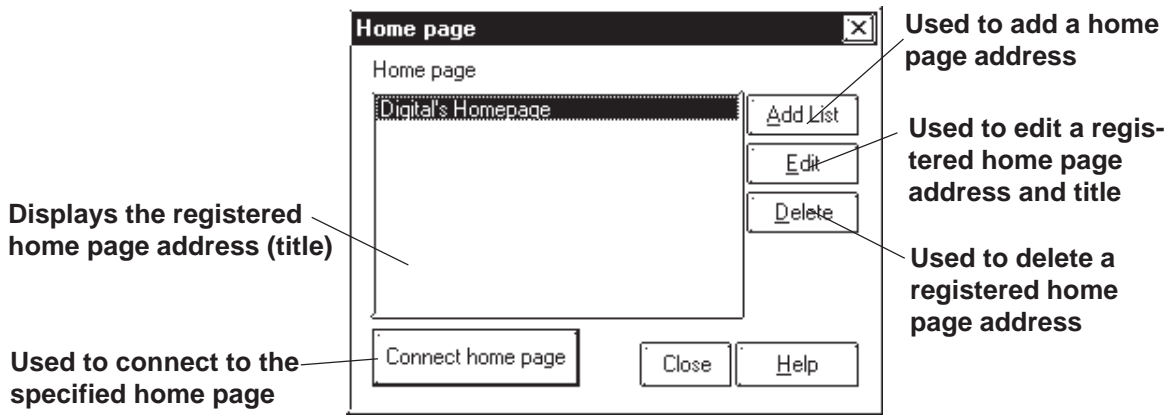

■ Registering a Home Page Address

The address of Digital Electronics Corporation's Home Page has been preregistered in your LT Editor software. When you click on the button, the address setting dialog box appears.

▼ Reference ▲ ■ How to Register a Home Page Address

■ Deleting a Home Page Address

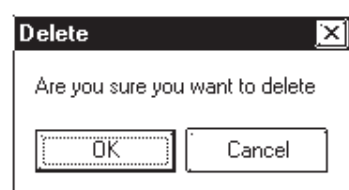

Any registered home page address can be deleted. When you select the home page address to be deleted and click on the button, the confirmation dialog box appears. If you click on the button, the selected home page address will be deleted. If you click on the button, the deleting operation will be canceled.



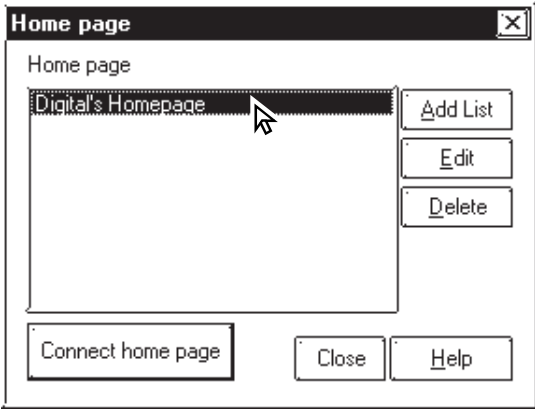

■ **Editing a Home Page Address**

The registered home page address or title can be changed. When you select the home page address to be edited and click on the button, the address setting dialog box appears (same as for the home page addition procedure), enabling you to change the title and address of the home page. If Digital Electronics Corporation's home page address is changed in the future, please edit the currently registered address.

■ **Connecting to the Home Page**

| PROCEDURE | REMARKS |
|--|--|
| <p>(1) Select the [Help] menu - [Connect to Home Page] command in the Project Manager.</p> <p>(2) Select the target home page address.</p>  <p>(3) Click on the <input type="button" value="Connect home page"/> button to start connection. The browser is started, and you will be connected to the home page.</p> | <p>If a browser has not been specified, the following dialog box appears. Specify a browser, and re-start the connecting procedure.</p>  |

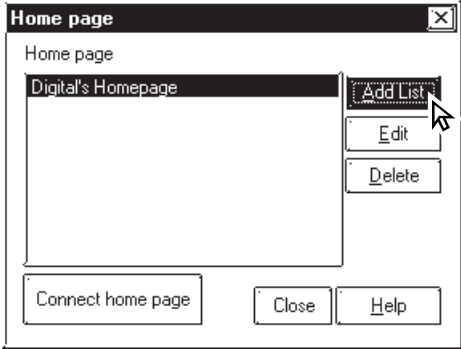
■ How To Register a Home Page Address

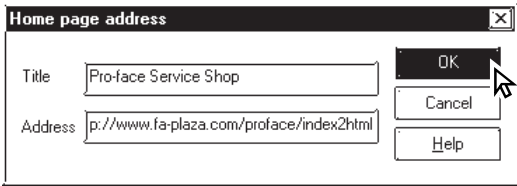
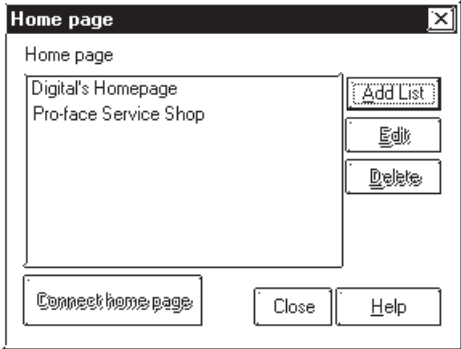
| PROCEDURE | REMARKS |
|---|---------|
| <p>(1) Select the [Help] menu - [Connect to Home Page] command in the Project Manager.</p> <p>(2) Click on the  button.</p>  <p>(3) Enter a home page title and address to be registered and click on .</p> <p>The specified home page address will be registered.</p>  <p style="text-align: center;">↓</p>  | |

Memo

To create Base screens, the Editor area's Part, Draw and Menu Bar commands can all be used. Also, Edit commands can be used to modify any Parts or objects that you have created. In addition to editing these screen objects, the procedures for registering Library Items and Windows are also explained.

| | | |
|-----|-------|-------------------------------------|
| 2.1 | | Parts |
| 2.2 | | Drawing |
| 2.3 | | Object Editing |
| 2.4 | | Libraries |
| 2.5 | | D-Script/Global D-Script |
| 2.6 | | Data Sampling |
| 2.7 | | Efficient Drawing Techniques |
| 2.8 | | DXF Conversion |

2.1 Parts

Parts such as Switches, Lamps, and Graphs can be placed on Base screens.





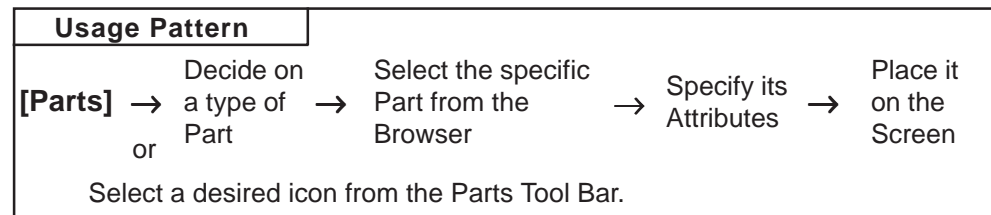







Each Part's attributes such as setting Addresses and colors will be designated via the dialog box. Switches and Lamps can be selected while viewing their images via the Browser. After designating all the necessary Part attributes, decide their position and size on the object drawing area.







The [Parts] menu's commands are effective only on Base screens.



■ LT Editor Part Type Summary

Each of the Parts used in LT Editor is listed below.

| Icon | Name | Function | Reference |
|---|---------------------|--|--------------------------|
|  | Bit Switch | Used to change a External Device's Bit Address data. | 2.1.1 Bit Switches |
|  | Word Switch | Changes a External Device's Word Address data. | 2.1.2 Word Switches |
|  | Function Switch | Used to go back to the previous screen, to switch screens, and to reset the LT. | 2.1.3 Function Switches |
|  | Lamp | Turns ON or OFF, according to whether the External Device's Monitor Bit is ON or OFF. | 2.1.4 Lamps |
|  | Bar Graph | Displays the External Device's Word Address data in a bar graph. | 2.1.5 Bar Graphs |
|  | Pie Graph | Displays the External Device's Word Address data in a pie graph. | 2.1.6 Pie Graphs |
|  | Half-Pie Graph | Displays the External Device's Word Address data in a Half-Pie graph. | 2.1.7 Half-Pie Graphs |
|  | Meter | Displays the External Device's Word Address data in a Meter graph. | 2.1.8 Meters |
|  | Trend Graph | Displays the PLC's Word Address data as absolute values in a trend graph. | 2.1.9 Trend Graphs |
|  | Keypad Display | Used to enter a PLC's Word Address data. | 2.1.10 Keypad Display |
|  | Alarm Display | When monitored Bits are turned ON, a list of "Basic" Alarm summary messages appear that have been previously registered in the Alarm Editor. | 2.1.11 Alarm Displays |
|  | Filing Data Display | Displays data registered in the Filing Data list by specifying the corresponding file number. | 2.1.12 File Name Display |

| Icon | Name | Function | Reference |
|---|-----------------|--|-----------------------------|
|  | Logging Display | Displays External Device data loaded in the data logging settings by specifying the address for the corresponding block number. | 2.1.13 Data Logging Display |
|  | Numeric Display | Displays the External Device's Word Address numeric data as an absolute value. | 2.1.14 Numeric Displays |
|  | Message Display | Displays a previously registered message, according to External Device Word Address data changes. A maximum of 16 messages can be displayed in a single Message Display. | 2.1.15 Message Displays |
|  | Date Display | Displays the current date, using the LT's internal calendar. | 2.1.16 Date Displays |
|  | Time Display | Displays the current time, using the LT's internal clock. | 2.1.17 Time Displays |
|  | Picture Display | Displays a single registered Library image (only graphic data), according to External Device Word Address data changes. A maximum of 16 different Library images can be displayed in a single Picture Display. (One at a time) | 2.1.18 Picture Displays |

■ Entering a Comment

If desired, a comment can be entered for a Part.

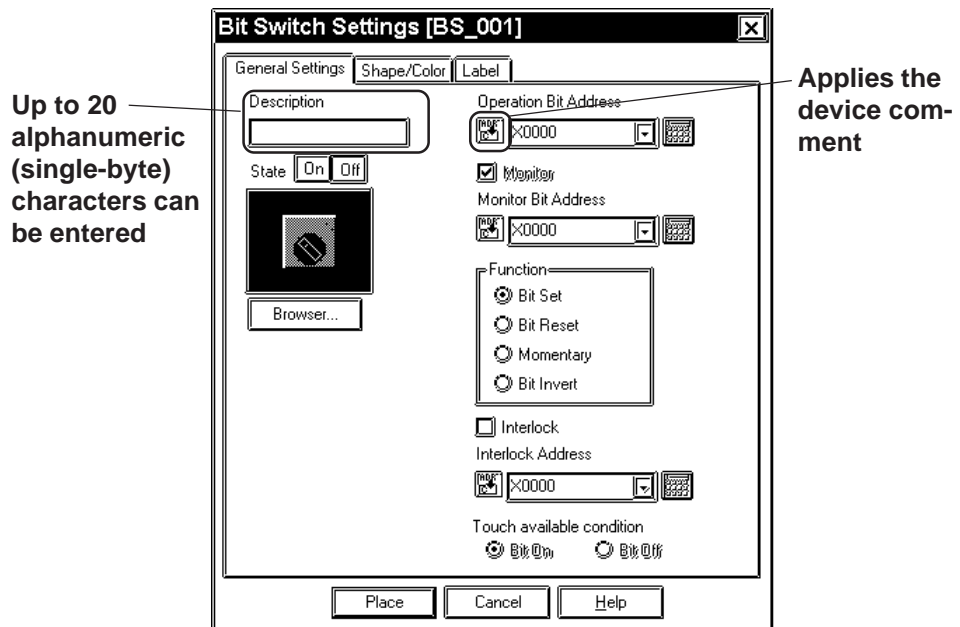

◆ Reflection of a Device Comment

If you click on the  [Apply Device Comment] button after entering an address, the device comment entered using the Symbol Editor is automatically searched for, and the comment corresponding to the entered device appears in the Description field.

Reference 4.2.5 Symbol Editor

■ Entering Addresses

Here, Addresses that are operated for Parts' functions and that are monitored are designated.

A variable to be used in a logic program (Logic symbol) can be designated as a Part's address.

▼ **Reference** 4.2.5 Symbol Editor



When a function requires consecutive addresses and a variable (Logic symbol) is used as a start address, an integer array must be designated.

For an integer array, an appropriate size required for consecutive addresses needs to be allocated.

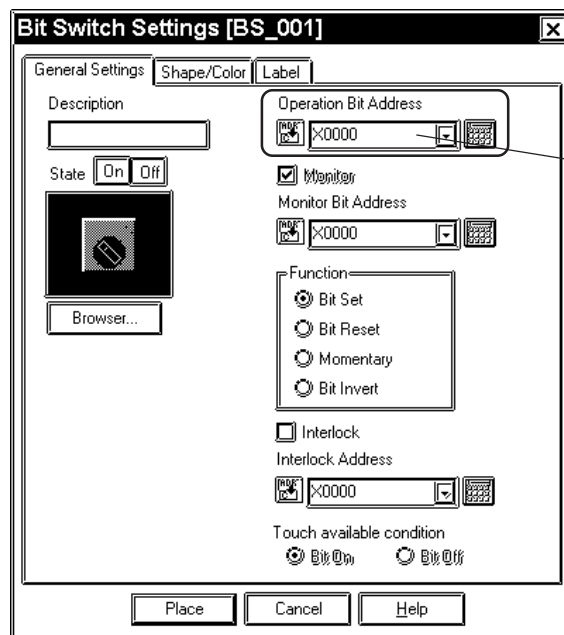

Enter the address data here

◆ Entering from a keyboard

Click on the address entering field, and the cursor will appear there, which indicates data entry is now effective. Then, enter device and address data via the keyboard.

◆ Entering from a pull-down list

Click on the ▾ box next to the Address entering field, and a pull-down list appears including symbols and Logic symbols selected via the Symbol Editor and device comments together with corresponding Addresses. Selecting a symbol, Logic symbol or device comment from the list designates an Address.

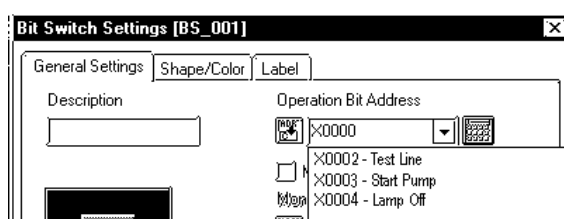

◆ Entering from the Address Keypad

Click on the [Address Keypad] icon, and the Address Keypad will appear, allowing you to enter numeric data and addresses on the screen via the mouse.

When designating a variable for a logic program (Logic symbol) by bit, use the Logic Symbol Keypad that will be displayed by clicking the [Logic] button in the Address Keypad window.

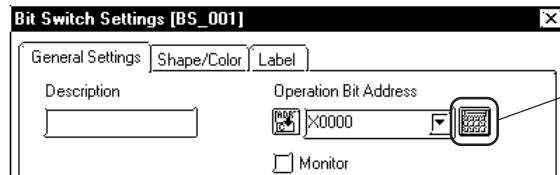

To move the Address keypad to the desired position, drag its title bar.

To display the device names in a list, click here.

Backspace key

Hexadecimal number entry key

Displays the Logic Symbol Keypad

[Address Keypad]

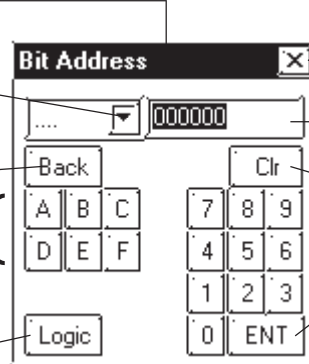

To close the pop-up keypad, click here.

Display

Clear key

Enter key

[Logic Symbol Keypad]

Designates a Logic symbol by bit

Returns to the Address Keypad

A pull down list shows Logic symbols.

The Logic symbol will be accepted with a click on the Enter key.

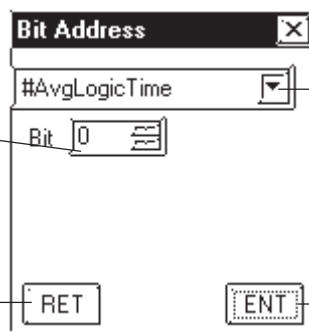

Note: A Part's specified address can be entered so that it is displayed during Base screen creation.

▼ **Reference** 2.7.2 Property Settings

Regardless of whether addresses are designated as either displayed or not displayed during Base screen creation, they will not be displayed on the LT panel after screen transfer.

■ **Selecting a Part Shape**

Click on the General Settings Area's button in the dialog box, and the Shape Browser (hereafter called "Browser") will be displayed. The Browser's Part Shapes are stored in a Part File (PDB file), separate from the main Project File (LTE file). Searching through different pre-made Part files allows you to easily find useful Part Shapes for almost any application.

Click on a Part number and then the button, or double-click directly on the Part number to select a Part Shape. (Browser disappears)



Note: Part File and Part Shape lists for each file are included in the LT Editor Parts List Manual.

The ID number of the Part Shape is displayed here. Reverse video (highlighting) indicates it is selected

Clicking here scrolls through the Part Shapes in this file

Calls up a list of the other Part files

Shows the ID number of the currently selected Part Shape

Shows the Path-name of the currently open Part File

◆ **PDB File**

Click on the button, and a list of the Part files will appear. After clicking on a Part File, the information displayed will change to reflect that file. Next, click on the button and the selected PDB File's Part Shapes will appear in the Browser.

Shows the currently open folder

Moves to the next higher file directory level

Creates a new folder

Displays file names and details

Displays file names in summary form

Lists the names of all the PDB files in this folder

Shows the currently selected PDB file's comment

Shows the name of the currently selected PDB file. A name can also be entered here to select a file



Note: When the LT Editor software is first installed, all Part Files will be included in a folder named PDB and automatically installed in the same directory/ folder as the LT Editor program. If desired, these Part Files can be moved to other folders and, to find a Part File that has been moved, use the [Look in:] area to display Part Files located in other folders.

■ **Selecting Colors**

Specify Part colors using the Shape/Color setting screen. The setting items will differ depending on the Part, i.e. the border type, ON/OFF states, graphs, and label colors.

Tiling patterns can be selected for some of the Parts, Lamps, and Graphs.

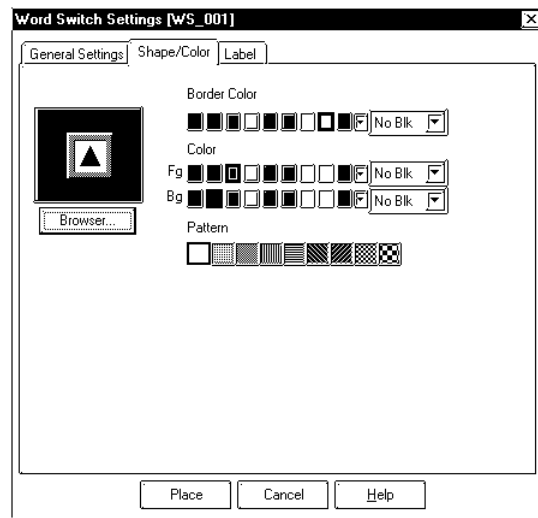

◆ **Colors**

There are 8 colors available in the color bar. Use this bar to select the foreground (Fg), background (Bg) and other colors. On a monochrome LT screen, black, blue, green, and cyan will be displayed as black (same as background); red, magenta, yellow, and white will be displayed as white.

| | | | | | | | | | |
|---------------------------|----|------------------------------|-----|--------------------------|--------------------------|----|----|----|----|
| | Fg | | Blk | <input type="checkbox"/> | | | | | |
| | Bg | | Blk | <input type="checkbox"/> | | | | | |
| Color LT unit | | BK | BL | GR | CY | RD | MG | YL | WH |
| Monochrome LT unit | | Black (not displayed) | | | White (displayed) | | | | |

◆ **Blink**

When the Blink (Blk) Check Box checked , the color bar is displayed in a darker color and the specified Part will blink on the LT's screen.



Note: When either text characters or Mark backgrounds (Bg) are specified as Black, and the Blk (Blink) feature is turned on, they will become transparent; so that even when overlaid on other objects, the rear object's color is also visible. This function is useful when overlaying text on Switches, Lamps, and other objects.

For example:

Specifying a Label's background color as Black does not allow you to see the background color.

However, specifying the Label's background color as Black and turning on Blk (blink), causes the background color to become visible.

◆ **States**

Only Parts which can have two states are displayed with this feature. Display colors for Parts can be specified separately for each state. Click on either state button to select it, and specify that state's color using the color bar.

■ Alarm Settings

In both graph and numeric value displays, Alarms can be set up. First, click on the [Alarm Settings] tab at the top of the Dialog box. When checking the Alarm Display box (Check mark appears), the Alarm setting items will appear.

◆ Alarm Type

The Alarm value can be specified as either direct (fixed value) or indirect (variable value) by simply clicking on the appropriate circle.

◆ Alarm Range

Here, you can specify the maximum and minimum Alarm values. When the Alarm value has been specified as indirect, the maximum and minimum values can also be specified as indirect. In this case, the Word Address number used to store these values will be automatically assigned continuously from the Word Address currently specified. The following example uses “n” to denote where the Word Address’ display data is stored:

<Indirect Alarm Settings>

<Relationship between display data’s storage address and Alarm register address>

With 16 Bit data

| | |
|-----|-------------------|
| n | Display Data |
| n+1 | Data value - Max. |
| n+2 | Data value - Min. |

With 32 Bit data

| | |
|-----|-------------------|
| n | Display Data |
| n+1 | |
| n+2 | Data value - Max. |
| n+3 | |
| n+4 | Data value - Min. |
| n+5 | |



When a variable (Logic symbol) is used as a start address, an integer array must be designated. For an integer array, an appropriate size required for consecutive addresses needs to be allocated.

◆ Alarm Color

Here, you can select the colors used for an Alarm display.

▼ **Reference** X 2.1 Parts ■ **Selecting Colors**

■ **Creating Labels**

Here, a Label means the text characters shown on the faces of the Switch and Lamp button Parts. Labels can be registered via the Part's Setting dialog box.



As with Parts, Label display colors can be created for each of a 2-state Part's states; up to 4 lines of text can be used for each state.

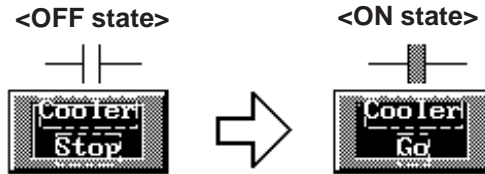

**When a lamp's Text Display changes
(This Switch's ON/OFF colors are also selected)**



Note: The Part must be large enough to display the entire Label.

When the Part has two states, the appropriate Label can be selected with these buttons switched On/Off.

Select the character's size

Selects the character's type

Enter the characters here

Copies the characters in the Description field to the label for the selected state.

Copies the characters to the label for the Off state.

Settings required only when the text extends to more than one line.

Select the label's color here

◆ **Label**

Here, you can type in the text displayed on a button. When typing in text, press the key to move to a new line. When the [Tracking] check box is checked (enabled), after the Part has been placed on the screen, if the Label's size or position is changed, for either state, the alternate state's Label size and position will be also automatically changed. If, however, the Label's size and position need to be specified independently for each state, DO NOT check this box.

▼ **Reference** 2.3.3 *Scaling Up/Down*

◆ **Copy from Description**

The characters entered in the Description field are copied to the label in the selected state.

◆ **Copy to Off (On) state**

When the state is On, the characters entered in the label are copied to the label in the Off state. When Off, the characters are copied to the label in the On state.

◆ **State**

States are displayed only for Lamps, and for those switches with two states (ON and OFF). The text displayed for each state can be specified independently. Simply click on either state button to specify its text and colors.

◆ **Character Size**

Specifies the size of character.

▼ **Reference** ▲ 2.2.9 Text

◆ **Style (Font)**

Specifies the type of character (Normal, Bold, Raised) used in each Label.

▼ **Reference** ▲ 2.2.9 Text

◆ **Text Color (ON/OFF)**

Specifies Label colors.

The default settings are Fg: White, and Bg: Transparent mode (Black + Blk).

◆ **Line space**

When the text extends to more than one line, set the line space.

◆ **Alignment (Justification)**

When the text input for a Label exceeds one line, the Alignment icons will appear. Select Left, or Right justification, or Centering.

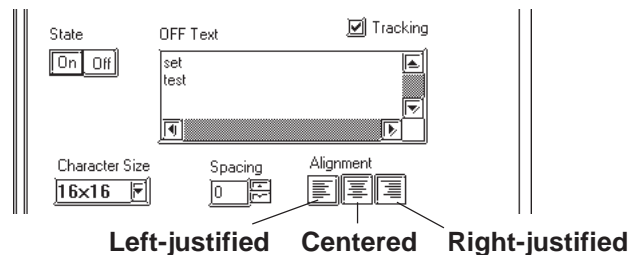

■ **ID Numbers**

When creating a Part, an ID number is automatically assigned to the Part before it is placed on the screen. This number shows how many of that kind of Part were previously placed on the current screen. When a Part is deleted from a screen, all following Part numbers will be adjusted downwards.

Example of an ID number

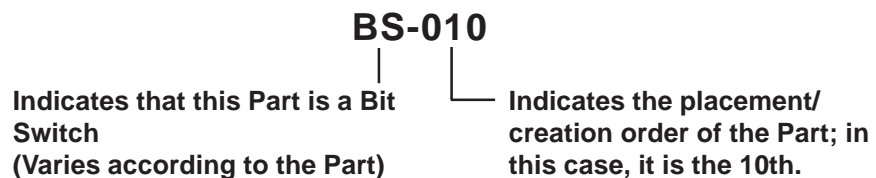

The ID number is displayed in the title bar at the top of the Setting dialog box.

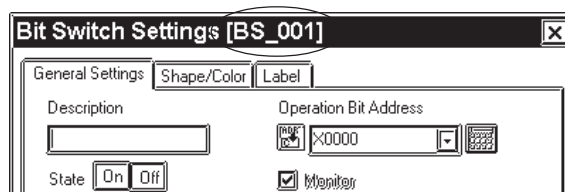



Note: The ID number can be entered so that it is displayed during Base screen drawing.

Reference 2.7.2 Screen Property Settings

Even if the ID number is entered to be displayed during Base screen drawing, it will not be displayed on the LT panel after screen data transfer.

<ID Number List>

| Part Name | ID Number |
|--|-----------|
| Bit Switch | BS-** |
| Word Switch | WS-*** |
| Function Switch | FS-*** |
| Lamp | LA-*** |
| Bar Graph | BA-*** |
| Pie Graph | PI-*** |
| Half-Pie Graph | HP-*** |
| Meter | MT-*** |
| Trend Graph | TR-*** |
| Keypad Input Display | KD-*** |
| Alarm Display | AL-*** |
| File Name Display | FD-*** |
| Data Logging Display | LG-*** |
| Numeric Display | ND-*** |
| Message Display (Operation Mode: Bit) | MB-*** |
| Message Display (Operation Mode: Word) | MW-*** |
| Date Display | DD-*** |
| Time Display | TD-*** |
| Picture Display (Motion mode: Bit) | LB-*** |
| Picture Display (Motion mode: Word) | LW-*** |

■ Maximum Number of Automatically Created Part Libraries

When a Part is used in a project, a Part Library will be automatically created in preparation for data transfer. The number of Part Library items are limited to 6000 per project. If this number exceeds 6000, all Parts in excess of 6000 cannot be transferred to the LT. To avoid this, please remember the following:

- Automatic Library creation will be performed follows: (per screen)
 - Switches: 2 (only switches with the Monitor function selected)
 - Lamps: 2
 - Messages: 2 to 16 (depending on the number of states used)
 - Picture Displays : 2 to 16 (depending on the number of states used)
 - Trends: 1 to 20 (depending on the number of channels)

However, Part Libraries using the same Parts (i.e. Part's that are the same size, same attributes, and without labels or other items) will be used commonly.

For example:

When 30 Switches (Monitor function is selected) and 20 Lamps are placed on a single Base screen, $(30 \times 2) + (20 \times 2) = 100$ Part Library items will be automatically created. Therefore, 60 of these size screens can be used in one project('s data).

- When using the same Parts for multiple Base screens, register the Part on one Base screen and then place it on other Base screens using the Load Screen function. Thus, when multiple Base screens use those Parts, only one Part Library will be used, thereby reducing the Project File's size.

■ Placing a Part in Position

After all of a Part's attributes have been entered or selected, click on the desired position on the screen to place the Part.

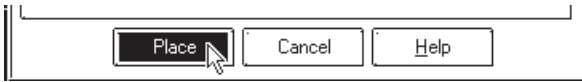
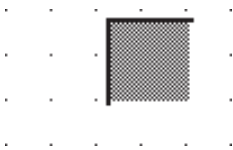
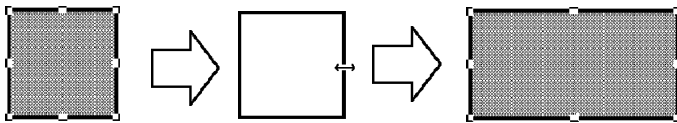
| PROCEDURE | REMARKS |
|---|---|
| <p>(1)After all of a Part's attributes have been entered or selected, click on the  button. The Part's outline will appear on the Base screen, next to your cursor.</p>  | |
| <p>(2)Click on the point where the Part's top left corner is to be placed. The selected Part will then appear on the screen.</p>  | |
| <p>(3)Adjust the Part's size, if desired. Click on the Part to select it, and drag any one of the handles to change the size of the Part. To change the size of a Part, move the cursor to a Part "handle" and click, then drag the "handle" to re-size the Part, and click again.</p>  | <p>▼Reference▲ 2.3.3 Scaling Up/Down</p> <p>After placing the Part, double-clicking on it automatically brings up its Attribute Setting dialog box.</p> <p>▼Reference▲ 2.3.15 Changing Attributes</p> |



Note: Depending on the Part, when scaling up or down, one dot error may occur in the frame width.

E.g.)



2.1.1 Bit Switches

Here, the creation of a touch panel switch, used for turning a specified Bit ON or OFF, is explained.



If the LT unit is Type C, Bit Switches with the Monitor function selected will not be displayed on the LT unit after the Project File transferred.

■ Bit Switch [General Settings] Attributes

Enter comment data here

Image of the currently selected Part Shape

Calls up the Part Shape Browser, where different Part Shapes can be selected

Sets the switch's function

Enter the Bit Switch Address

When creating a Bit Switch with two states, check this box and enter the alternate Bit Switch Address below

Sets the buzzer to ON/OFF

Selects the Interlock function state

◆ **Operation Bit Address**

Here, the Bit Address data controlled by the Switch is input.

◆ **Monitor Bit Address**

Only after the Monitor check box is checked can the Monitor Bit Address used to change the Switch's display setting be entered. The Switch's state (ON/OFF) display can be specified so that it will change according to changes in this Bit Address. Addresses input in the Bit Address area can also be done here.

Appears only when creating a Bit Switch with two states. Toggles the switch's state either ON or OFF, allowing you to set the attributes of each state.

After entering the Bit Address, if you attempt to perform another area's operation before entering the Monitor Bit's address data, the dialog box shown below will appear. Clicking on the button automatically inputs the Bit Address's data into the Monitor Bit Address. To enter a different address, click on the button and input the desired address.



◆ Function

The Bit Switch functions are as follows.

- Bit Set:** When the Bit Switch is pressed, the External Device's designated Bit Address is turned ON. This state continues (i.e. remains ON) even after the switch is released.
- Bit Reset:** When the Bit Switch is pressed, the External Device's designated Bit Address is turned OFF. This state continues (i.e. remains OFF) even after the switch is released.
- Momentary:** Only while the Bit Switch is pressed and held is the specified External Device Bit Address turned ON. Thus, when the switch is released, the specified Bit Address is turned OFF.
- Bit Invert:** Every time the Bit Switch is pressed, the External Device's designated Bit Address state is changed (from ON to OFF, or from OFF to ON).

◆ Interlock

Only when a bit designated via Interlock Address is in a state that has been selected via [Touch available condition] radio buttons, the switch becomes effective. Whether the switch is effective in ON state or in OFF state is selectable here.

| Touch Available Condition | Interlock Address Status | Touch Available/ Not Available |
|---------------------------|--------------------------|--------------------------------|
| Bit ON | ON | Touch Available |
| | OFF | Touch Not Available |
| Bit OFF | ON | Touch Not Available |
| | OFF | Touch Available |

■ Bit Switch [Shape/Color] Attributes

Here, the Switch's border color (Frame), ON/OFF state colors (On Color, Off Color), and pattern can be selected.

▼ **Reference** ▲ 2.1 Parts ■ **Selecting Colors**

The color and pattern settings available will differ depending on the switch's settings.

■ Bit Switch [Label] Attributes

Here, the text of the Label to be displayed on the Switch button is entered.

▼ **Reference** ▲ 2.1 Parts ■ **Creating Labels**

■ **Placing a Bit Switch**

An example of how to place a Bit Invert switch is shown below.

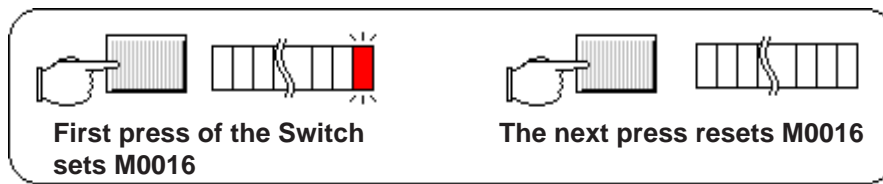

| PROCEDURE | REMARKS |
|-----------|---------|
|-----------|---------|

(1) Select the [Parts] menu - [Bit Switch] command, or click on the icon.

(2) In the [General Settings] screen, input the Bit Address and select the Bit's Function.

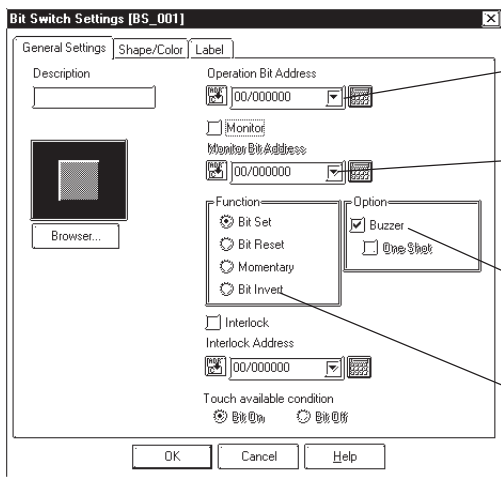

Enter **M0016**

When the switch's state can change, click here

Set the buzzer to ON or OFF

Select the **Bit Invert** function

When the Change State function selected, after entering the Bit Address, if you attempt to perform another area's operation before entering the Monitor Bit Address, the dialog box shown below will appear. Click on the button to input the same address as used for the Bit Address. To enter a different address, click on the button and input the desired address.

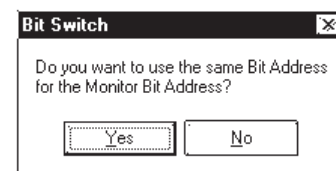

(3) Select a Part Shape from the Browser.

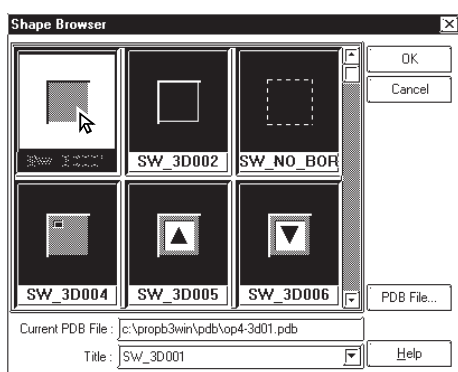

If desired, Select the desired color(s) and input a Label from the Shape/Color and Text areas.



(4) After all of a Part's attributes have been entered or selected, click on the button.

The Switch's outline will appear on the Base screen, next to your cursor.

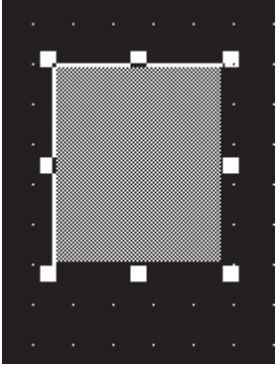
Reference 2.1 Parts ■ *Selecting a Part Shape*

| PROCEDURE | REMARKS |
|--|---|
| <p>(5) Click on the point where the Switch's top left corner is to be placed.</p> <p>If desired, use the Switch's handles to alter its size.</p>  | <p>To cancel the placement, click on the  icon.</p> <p>To change the Part's size, refer to Reference 2.3.3 <i>Scaling Up/Down</i>.</p> <p>Double-clicking on any Part placed on the screen automatically calls up that Part's Attribute Setting dialog box.</p> <p>Reference 2.3.15 <i>Changing Attributes</i></p> |

2.1.2 Word Switches

Here, a touch panel switch for setting data to a specified Word Address can be created.

Word Switch [General Settings] Attributes

Enter Comment data here

The Word Switch's image appears here

Calls up the Part Shape Browser. Parts can be selected directly from the Browser

Selects the Interlock function

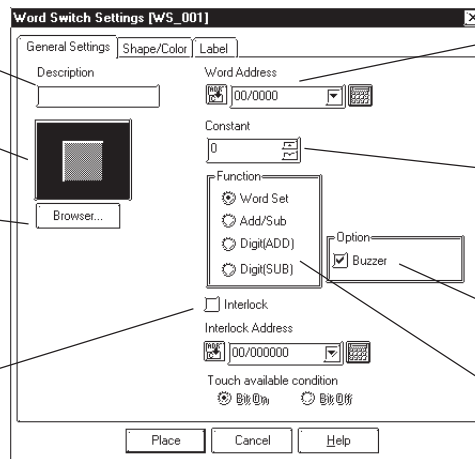

Enter the Word Address you wish to use

Enter the data for the Switch to send to the Word Address

Sets the buzzer to ON/OFF

Select the Switch's function

◆ Word Address

Here, the desired Word Address is entered.

◆ Constant

Here, number registered to the Word Address is input. The data format is Decimal (Base 10), and the input range is from -32768 to 32767.

◆ **Function**

The Word Switch’s functions are as follows:

Word Set: When the Word Switch is pressed, constant data is written to the External Device’s designated Word Address. Fixed or default values will be written to the timer, counter, etc.

Add/Sub: Every time the Word Switch is pressed, the Data value is added to the data currently in the External Device’s designated Word Address, and the result is then written to the External Device’s address. If a Data value is positive, the function will increment, and if it is negative, it will decrement.

Digit (ADD): Every time the Word Switch is pressed, the designated decimal place’s data will be added by the Constant’s value. The result will not be carried up to the next digit, so “9” simply rolls around to “0”. Select the data format from Bin and BCD.

Digit (SUB): Every time the Word Switch is pressed, the designated decimal place’s data will be subtracted by the Constant’s value. The result will not be carried down to the lower digit, so “9” simply rolls around “0”. Select the data format from Bin and BCD.

◆ **Interlock**

Only when a bit designated via Interlock Address is in a state that has been selected via [Touch available condition] radio buttons, the switch becomes effective. Whether the switch is effective in ON state or in OFF state is selectable here.

| Touch Available Condition | Interlock Address Status | Touch Available/ Not Available |
|---------------------------|--------------------------|--------------------------------|
| Bit ON | ON | Touch Available |
| | OFF | Touch Not Available |
| Bit OFF | ON | Touch Not Available |
| | OFF | Touch Available |

■ **Word Switch [Shape/Color] Attributes**

Here, a Word Switch’s color, and pattern can be selected.

▼ **Reference** ▲ 2.1 Parts ■ *Selecting Colors*

The color and pattern settings available will differ depending on the Switch’s settings, such as its shape and Change State condition.

■ **Word Switch [Label] Attributes**

Here, the text characters shown (engraved) on the Switch button face are input.

▼ **Reference** ▲ 2.1 Parts ■ *Creating Labels*

■ **Placing a Word Switch**

An example of how to place a Word Set Switch is shown below.

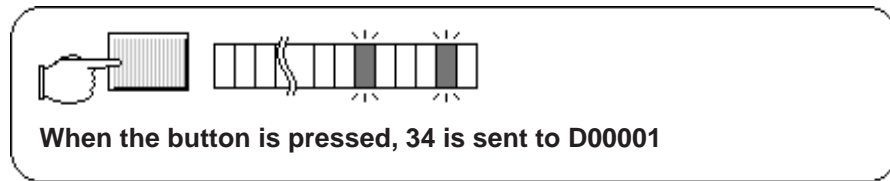

| PROCEDURE | REMARKS |
|-----------|---------|
|-----------|---------|

(1) Select the [Parts] menu - [Word Switch] command, or click on the icon.

(2) In the [General Settings] area, input the Word Address and Constant data, and select a function.

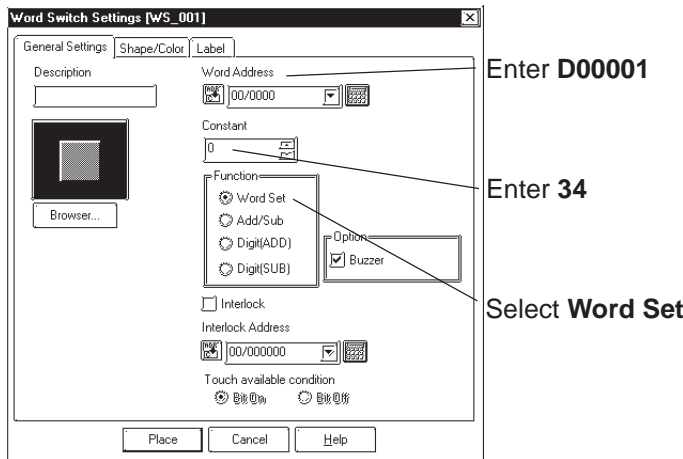

(3) Select a Part Shape from the Browser.

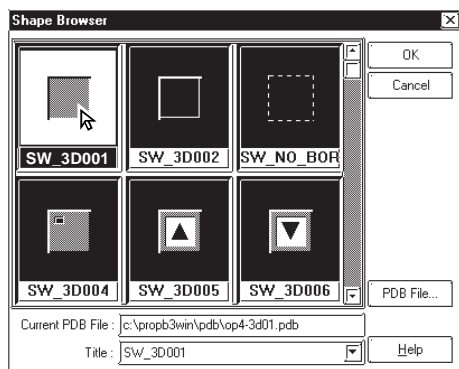

If desired, select Colors and input a Label from the Shape/Color and Label areas.

Reference 2.1 Parts ■ *Selecting a Part Shape*

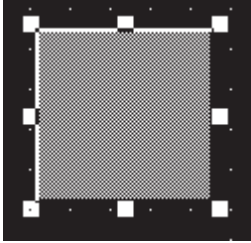

(4) After all of the Part's attributes have been entered or selected, click on the button.

The Switch's outline will appear on the Base screen, next to your cursor.

| PROCEDURE | REMARKS |
|--|---|
| <p>(5) Click on the point where the Switch's top left corner is to be placed.</p> <p>If desired, use the Switch's handles to alter its size.</p>  | <p>To cancel the placement, click on the  icon.</p> <p>Reference To change the Part's size, refer to 2.3.3 <i>Scaling Up/Down</i></p> <p>Double-clicking on any Part placed on the screen automatically calls up that Part's attribute settings.</p> <p>Reference 2.3.15 <i>Changing Attributes</i></p> |

2.1.3 Function Switches

Here, a touch panel with special functions can be created.

■ Function Switch [General Settings] Attributes

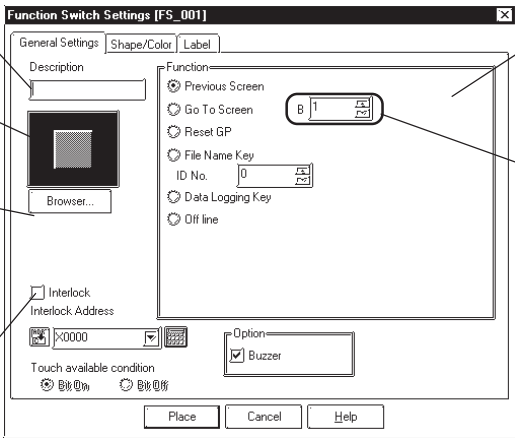

Enter Comment data here (points to Description field)

The Function Switch's image appears here (points to image preview area)

Calls up the Part Shape Browser. Parts can be selected directly from the Browser (points to Browser... button)

Selects the Interlock function state (points to Interlock checkbox)

Select the Switch's operation (points to radio buttons: Previous Screen, Go To Screen, Reset GP, File Name Key, Data Logging Key, Off line)

When "Go To Screen" is selected, the (Go To) screen's number and data format must be entered (points to ID No. field and data format dropdown)

◆ Function (Switch Operation)

The Function Switch's attributes are as follows:

- Previous Screen:** When the Switch is pressed, the currently displayed screen on the LT will change to the previously displayed one.
- Go To Screen:** When the Switch is pressed, the currently displayed screen on the LT will change to the specified screen. Input the screen number to be changed (jumped) to. The Data Format can be either Bin or BCD.



Note: If a screen number is specified in the BCD data format to place the corresponding screen, it is still displayed in the BIN data format when the screen is closed and then opened.

Reset LT:

When the Switch is pressed, the LT will be reset to the save status as when the LT's power was turned ON.



Resetting the LT turns the I/O signal off. Consider this when designing your system.

File Name Key:

This is a function switch corresponding to the File Name Display and is the same as the one that is automatically placed together with the File Name Display.

Designate the same ID number as the one of the File Name Display and select a operation mode.

Reference 2.1.13 *File Name Display*

Data Logging Key:

This is a function switch corresponding to the Data Logging Display and is the same as the one that is automatically placed together with the Data Logging Display. Designate the scroll direction and the number of lines being rolled up or down.

Reference 2.1.14 *Data Logging Display*

OFFLINE:

When this switch is pressed, the LT enters the OFFLINE mode.

◆ Interlock

Only when a bit designated via Interlock Address is in a state that has been selected via [Touch available condition] radio buttons, the switch becomes effective. Whether the switch is effective in ON state or in OFF state is selectable here.

| Touch Available Condition | Interlock Address Status | Touch Available/ Not Available |
|---------------------------|--------------------------|--------------------------------|
| Bit ON | ON | Touch Available |
| | OFF | Touch Not Available |
| Bit OFF | ON | Touch Not Available |
| | OFF | Touch Available |

■ Function Switch [Shape/Color] Attributes

The Switch's color, and pattern are selected here.

Reference 2.1 Parts ■ *Selecting Colors*

The color and pattern settings available will differ depending on the switch shape.

■ Function Switch [Label] Attributes



Here, the characters shown (drawn) on the Switch button face are entered.

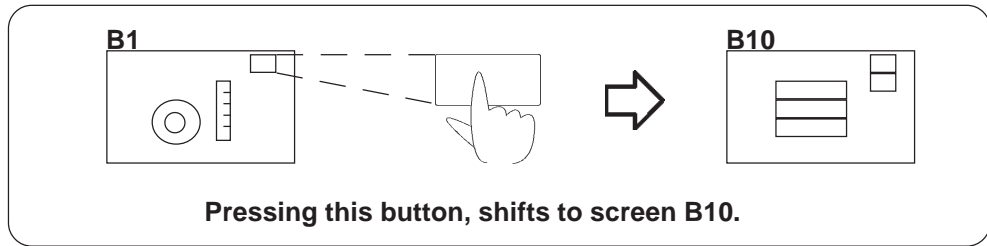

Reference 2.1 Parts ■ *Creating Labels*

■ **Placing a Function Switch**

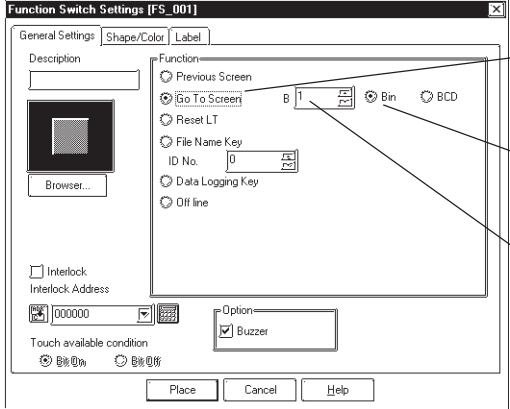
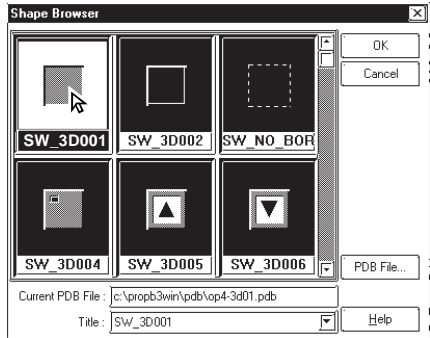
The Screen Switching (Function) Switch’s placement procedure is shown below.

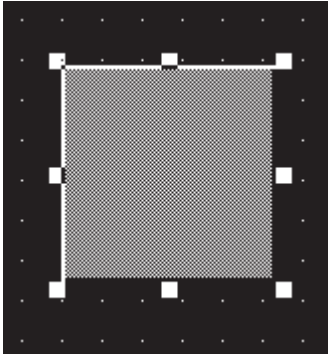

| PROCEDURE | REMARKS |
|---|--|
| <p>(1) Select the [Parts] menu - [Function Switch] command, or click on the  icon.</p> <p>(2) Designate the [Function] on the [General Settings] tab.</p>  | |
| <p>(3) Select a Part Shape from the Browser. If desired, select Colors and input a Label from the Shape/Color and Label areas.</p>  | <p>Reference 2.1 Part ■ <i>Selecting a Part Shape</i></p> |
| <p>(4) After all of Part’s attributes have been entered or selected, click on the  button.</p> <p>The Switch’s outline will appear in the Base screen, next to your cursor.</p> | |

| PROCEDURE | REMARKS |
|--|---|
| <p>(5) Click on the point where the Switch's top left corner is to be placed.</p> <p>If necessary, use the Switch's handles to alter its size.</p>  | <p>To cancel the placement, click on the  icon.</p> <p>To change the Part's size, refer to: Reference 2.3.3 <i>Scaling Up/Down</i></p> <p>Double-clicking on any Part placed on the screen calls up that Part's Attribute Setting dialog box.</p> <p>Reference 2.3.15 <i>Changing Attributes</i></p> |

2.1.4 Lamps

Here a lamp is created, which turns ON or OFF according to the External Device's Monitor Bit Address state.



Important

- **When the LT is Type C, lamps will not display on the LT unless the LT has been connected to the External Device.**
- **When placing a Lamp, DO NOT overlap it with other objects. If you do so, it may not be displayed correctly.**

■ Lamp [General Setting] Attributes

◆ Bit Address

The Bit Address to be monitored is entered here.

■ **Lamp [Shape/Color] Attributes**

Here, border colors for both ON and OFF states, and Lamp's colors and tiling pattern in each state can be selected.

▼ **Reference** 2.1 Parts ■ **Selecting Colors**

The color and pattern settings available will differ depending on each lamp shape.

■ **Lamp [Label] Attributes**

Here, the text characters shown on a Lamp button's face are entered.



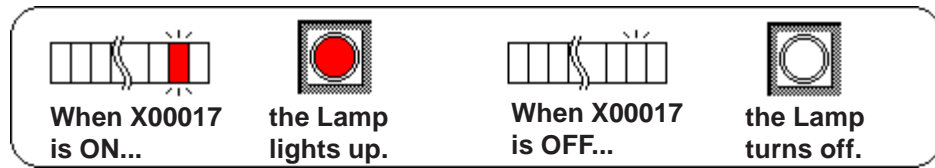

▼ **Reference** 2.1 Parts ■ **Creating Labels**

■ **Placing a Lamp**

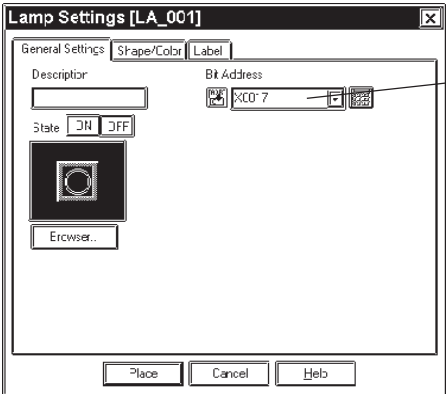
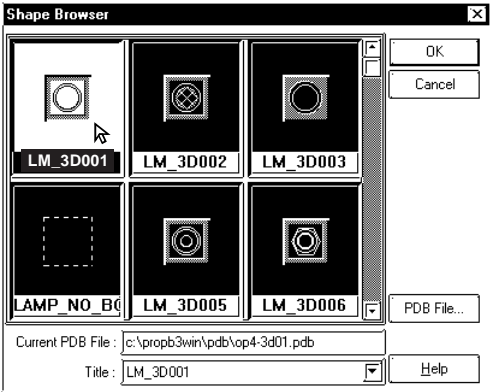
The procedures for creating and placing a Lamp are shown below.

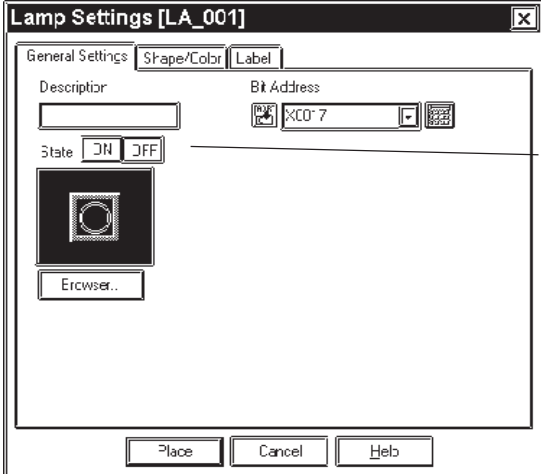

| PROCEDURE | REMARKS |
|--|---|
| <p>(1) Select the [Parts] menu - [Lamp] command, or click on the  icon.</p> <p>(2) In the [General Settings] area, enter a Bit Address.</p>  | |
| <p>(3) Select a Part Shape from the Browser. Select Colors and input a Label, if desired.</p>  | <p>▼ Reference 2.1 Parts ■ Selecting a Part Shape</p> |

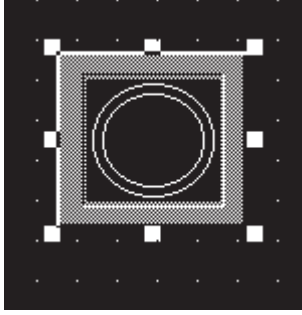
| PROCEDURE | REMARKS |
|--|---|
| <p>(4) Switch the state of the lamp with the On/Off buttons, and then select Colors and input a Label.</p>  <p>Switches the lamp On/Off</p> | <p>With the Blink check box checked , and if the Bit is turned ON, the Lamp will blink. Lamp blinking can also be seen via the pull down menu [View]'s [Preview] command.</p> <p>Reference 2.7.3 <i>Preview Screen</i></p> |
| <p>(5) After all of the Lamp's attributes have been entered or selected, click on the  button.</p> <p>The Lamp's outline will appear in the Base screen, next to your cursor.</p> | |
| <p>(6) Click on the point where the Lamp's top left corner is to be placed.</p> <p>If necessary, use the Lamp's handles to alter its size.</p> | <p>To cancel the placement, click on the  icon.</p> <p>To change the Part's size, refer to</p> |
|  | <p>Reference 2.3.3 <i>Scaling Up/Down</i></p> <p>Double-clicking on any Part placed on the screen automatically calls up that Part's attribute settings.</p> <p>Reference 2.3.15 <i>Changing Attributes</i></p> |

2.1.5 Bar Graphs

Bar Graphs are used to display External Device's Word Address numeric data in absolute or relative values. This graph's display will change according to Word Address data changes.

■ Bar Graph [General Settings] Attributes

<When displaying Word Address numeric data in absolute values>

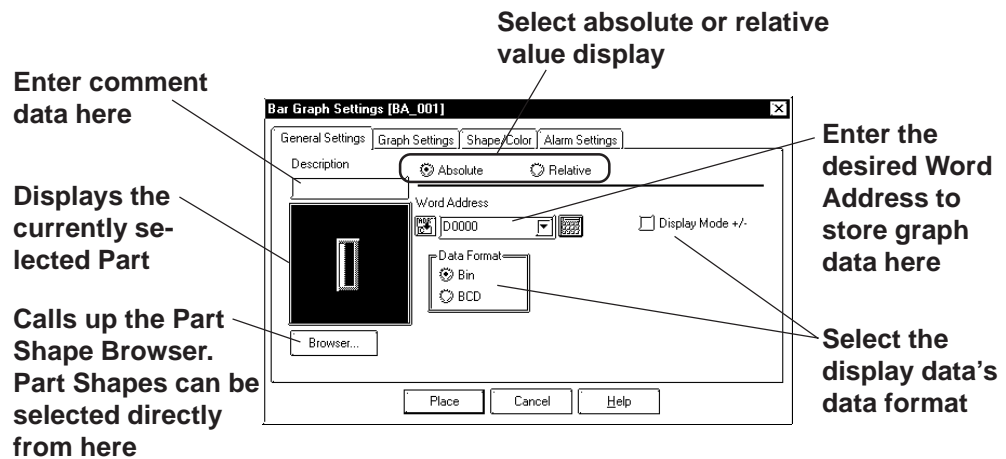

◆ Absolute

Data stored in the Word Address is displayed in absolute values from 0 to 100 (with Display Mode +/- selected, -100 to 100).

◆ Word Address

Here, enter the Word Address used for storing the Bar Graph's data.

◆ Data Format

The display data's format can be either Bin or BCD.

When Bin is selected, negative numeric data can also be displayed. In that case, check the Display Mode +/- check box.

<When displaying External Device Word Address numeric data in relative values>

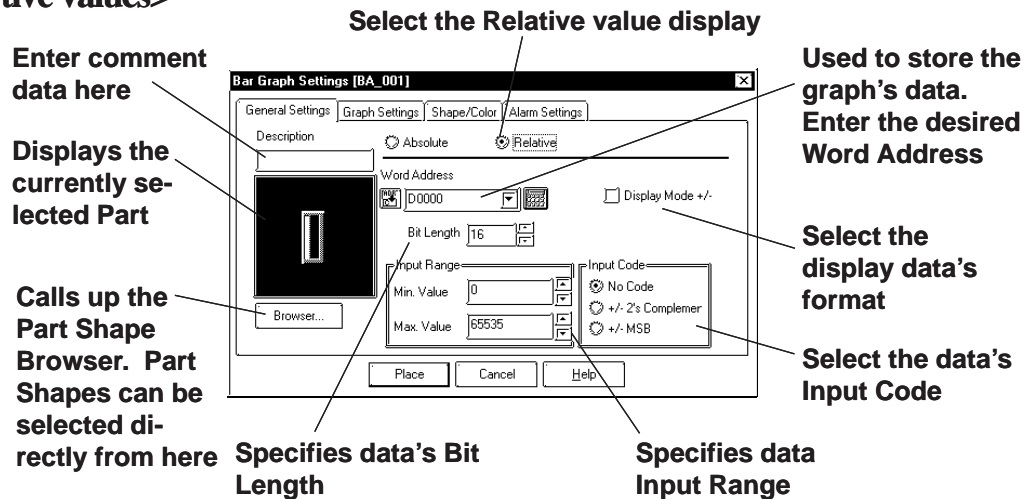

◆ Relative

According to the Input Range designated for the Word Address' data, the data is converted and displayed as relative values.

◆ Word Address

Here, enter the Word Address used for storing the Bar Graph's data.

◆ Display Mode +/-

When this check box is checked, negative numeric data can also be displayed.

◆ Bit Length

Specifies the Bit Length of data stored in the Word Address.

◆ Input Range

Specifies the data's Input Range.

◆ Input Code

When No Code is selected, only positive data can be entered. To enter negative number data, select +/- 2's Complement or +/- MSB.

■ Bar Graph [Graph Settings] Attributes

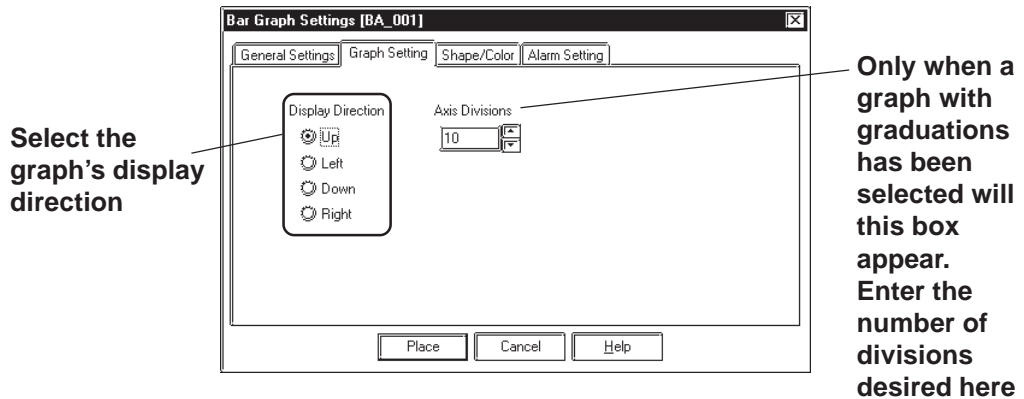

◆ Direction

The graph's display direction can be specified as either Up, Left, Down, or Right.



Note: If [Display Direction] is changed for a 3D part, its shade is rotated along with that part. To let the shade displayed properly, click on the button, and select the part again from [Shape Browser].

◆ Axis Divisions

For a graph which has graduations, the number of divisions are entered here. If the number of the divisions is specified to 10, then 11 division lines are used. When graduations are not necessary, specify the number of the divisions as 0.



Note: Whether the graduations are necessary or not will differ depending on the Part's shape.

■ Bar Graph [Shape/Color] Attributes

The graph's border color, division color (Axis Color), display data color (Graph Color), and display data patterns are selected here.

▼ **Reference** ▲ 2.1 Parts ■ *Selecting Colors*

■ Bar Graph [Alarm Settings] Attribute

If desired, an Alarm can be setup here by toggling the Alarm check box.



▼ **Reference** ▲ 2.1 Parts ■ *Setting Alarms*

■ **Placing a Bar Graph**

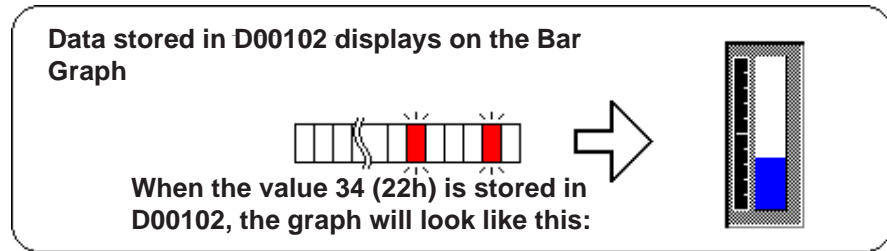
An example of the Bar Graph's creation and placement procedures are shown below.

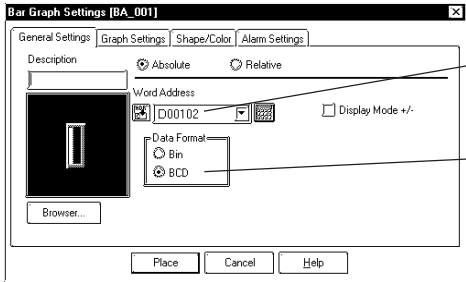
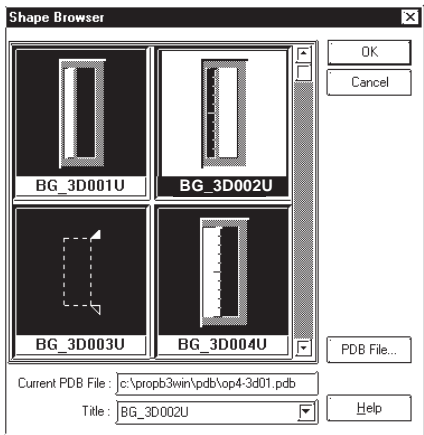
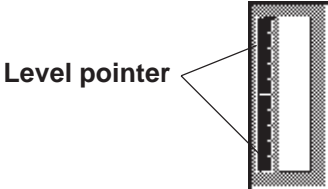

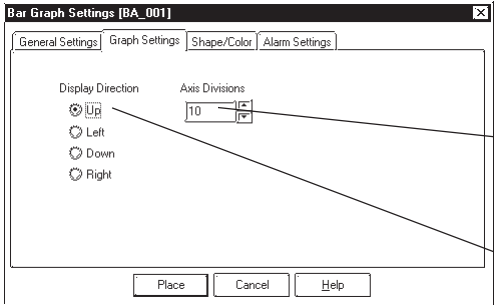
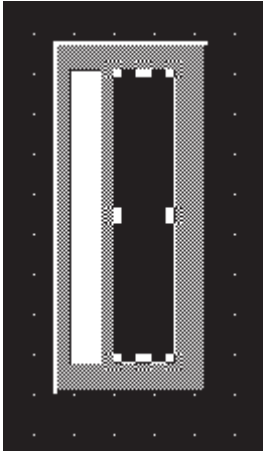
| PROCEDURE | REMARKS |
|--|---|
| <p>(1) Select the [Parts] menu - [Bar Graph] command, or click on the  icon.</p> <p>(2) In the [General Settings] tab, input a Word Address and select a Data Format.</p>  <p>(3) Select a Part Shape that has graduations from the Browser.</p> <p>Here, you can enter Alarm settings and select Colors, if desired.</p>  | <p>Reference 2.1 Parts ■ <i>Selecting a Part Shape</i></p> <p>If the Bar Graph's Alarm value is specified as Variable, a pointer showing levels will be displayed. This pointer's position will move according to the specified Alarm value.</p>  |

| PROCEDURE | REMARKS |
|--|--|
| <p>(4) In the [Graph Settings] tab, select the graph's display direction and input the number of Axis Divisions.</p>  <p>(5) After all of the graph's attributes have been entered or selected, click on the <input type="button" value="Place"/> button.</p> <p>The Bar Graph's outline will appear on the Base screen, next to your cursor.</p> <p>(6) Click on the point where the Bar Graph's top left corner is to be placed.</p> <p>If necessary, use the Bar Graph's handles to adjust its size.</p>  | <p>The area to enter the number of the divisions will appear only for a graph type which has axis divisions.</p> <p>To cancel the placement, click on the  icon.</p> <p>To change the Part's size, refer to Reference 2.3.3 <i>Scaling Up/Down</i></p> <p>Double-clicking on any Part placed on the screen automatically calls up that Part's attribute settings.</p> <p>Reference 2.3.15 <i>Changing Attributes</i></p> <p>The Bar Graph's sizing handles are located inside the graph.</p> |

2.1.6 Pie Graphs

Pie Graphs create an area where an External Device's Word Address data is displayed as absolute values. The graph's display will change to reflect changes in the designated Word Address data.

■ Pie Graph [General Settings] Attributes

<When displaying the data using absolute values>

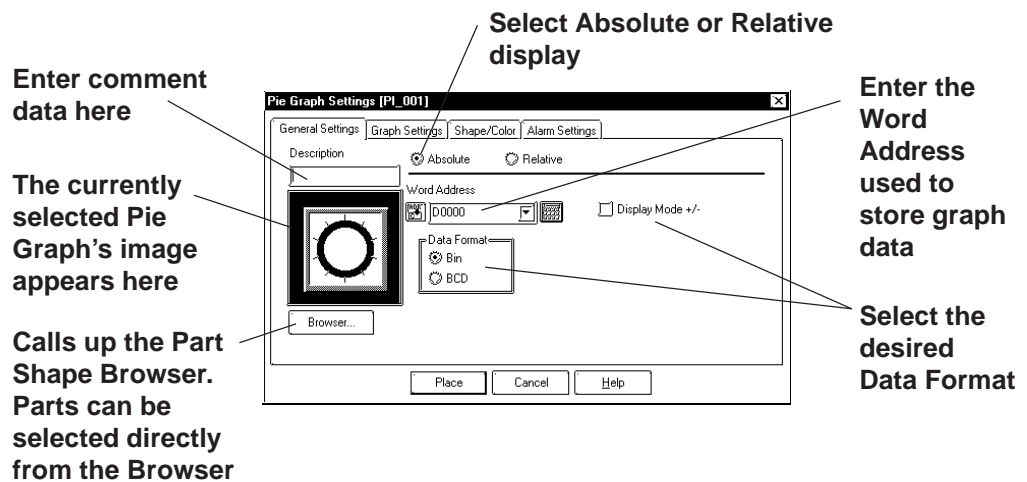

◆ Absolute

Data stored in the designated Word Address is displayed in absolute values, from 0 to 100 (with Display Mode +/- selected, -100 to 100).

◆ Word Address

Here, the Word Address' location data is entered to show where the desired data is stored.

◆ Data Format

Select either the Bin and BCD display formats.

◆ Display Mode +/-

With this check box checked and the Bin data format is selected, a negative numeric data can also be displayed.

<When displaying the data using relative values>

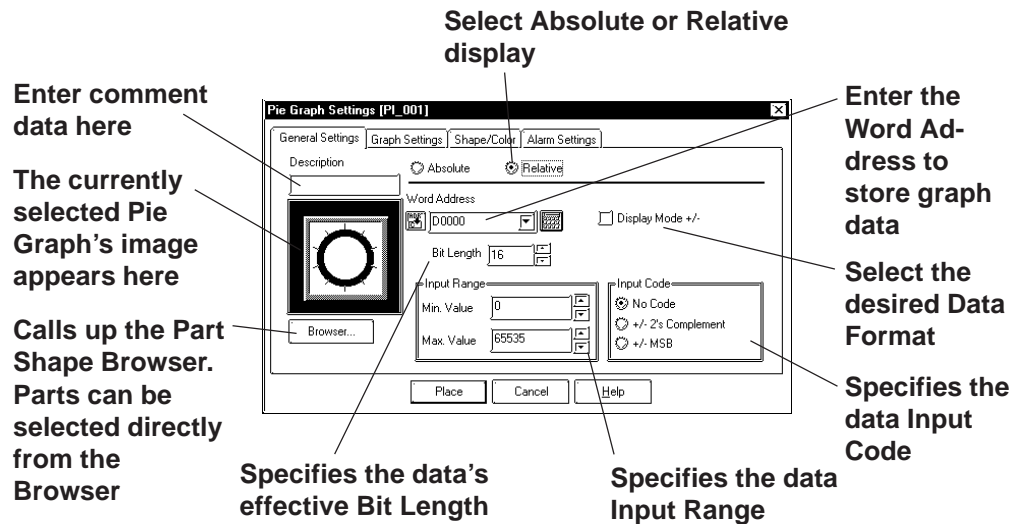

◆ **Relative**

According to the Input Range designated for the Word Address Data, the data is converted and displayed as relative values.

◆ **Word Address**

Here, enter the Word Address used to store Pie Graph data.

◆ **Display Mode +/-**

When this check box checked, negative numeric data can also be displayed.

◆ **Bit Length**

Specifies the Bit Length of all data stored in the Word Address.

◆ **Input Range**

Specifies the data's Input Range.

◆ **Input Code**

With No Code selected, only positive numeric data can be entered. To enter negative numeric data, select either +/-2's Complement or +/-MSB.

■ Pie Graph [Graph Settings] Attributes

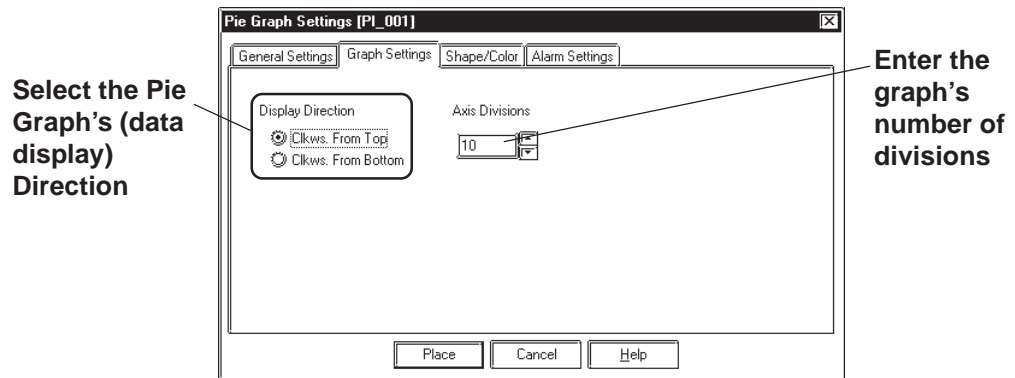

◆ Display

Here, the graph's data display start point, either Clkws. From Top or Clkws. From Bottom, can be selected.



If [Display Direction] is changed for a 3D part, its shade is rotated along with that part. To let the shade displayed properly, click on the button, and select the part again from [Shape Browser].

◆ Axis Divisions

The number of segments the Pie Graph will be divided into is entered here. If the number of Axis Divisions is specified as 10, 10 division lines will be displayed. When no divisions are necessary, simply enter 0.

■ Pie Graph [Shape/Color] Attributes

A Pie Graph's border color, division line color (Axis Color), data display color (Graph Color - Fg and Bg), and data display pattern can all be selected here.

▼ **Reference** ▲ 2.1 Parts ■ *Selecting Colors*

■ Pie Graph [Alarm Settings] Attributes

Clicking on the Alarm Display check box will call up the Alarm Settings.

▼ **Reference** ▲ 2.1Parts ■ *Setting Alarms*





■ Placing a Pie Graph

The procedure for placing a Pie Graph is shown below.

Data stored in D00102 displays on the Pie Graph

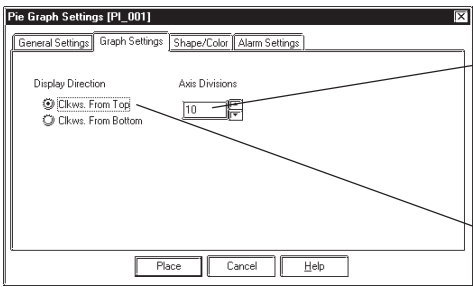
When the value 34 (22h) is stored in D00102, the graph appears like this:

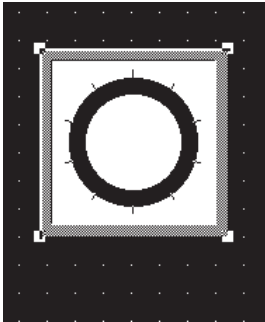
| PROCEDURE | REMARKS |
|--|---|
| <p>(1) Select the [Parts] menu - [Pie Graph] command, or click on the icon.</p> <p>(2) In the [General Settings] area, input a Word Address and select a Data Format.</p> <p>Enter D00102 here</p> <p>Select BCD</p> <p>(3) Select a Part Shape from the Browser.</p> <p>You can also use the Alarm Settings area to choose an Alarm and select Colors, if desired.</p> | <p>Reference 2.1 ■ <i>Selecting a Part Shape</i></p> |

| PROCEDURE | REMARKS |
|--|---|
| <p>(4) In the [Graph Settings] tab, select the display direction and input the number of Axis Divisions.</p>  <p>(5) After all of the Graph's attributes have been entered or selected, click on the  button.</p> <p>A Pie Graph's outline will appear on the Base screen, next to the cursor.</p> <p>(6) Click on the point where the Pie Graph's top left corner is to be placed.</p> <p>If desired, use the Pie Graph's handles to alter its size.</p>  | <p>The area to enter the number of the divisions will appear only for a graph type which has axis divisions.</p> <p>To cancel the placement, click on the  icon.</p> <p>To change the Part's size, refer to Reference 2.3.3 <i>Scaling Up/Down</i></p> <p>Double-clicking on any Part placed on the screen automatically calls up that Part's attribute settings.</p> <p>Reference 2.3.15 <i>Changing Attributes</i></p> |

2.1.7 Half Pie Graphs

This graph displays a Word Address' numeric data (received from an External Device) as absolute or relative values in a Half-Pie graph. The graph's display will also change to reflect Word Address data changes.

■ Half Pie Graph [General Settings] Attributes

<When displaying the data in absolute values>

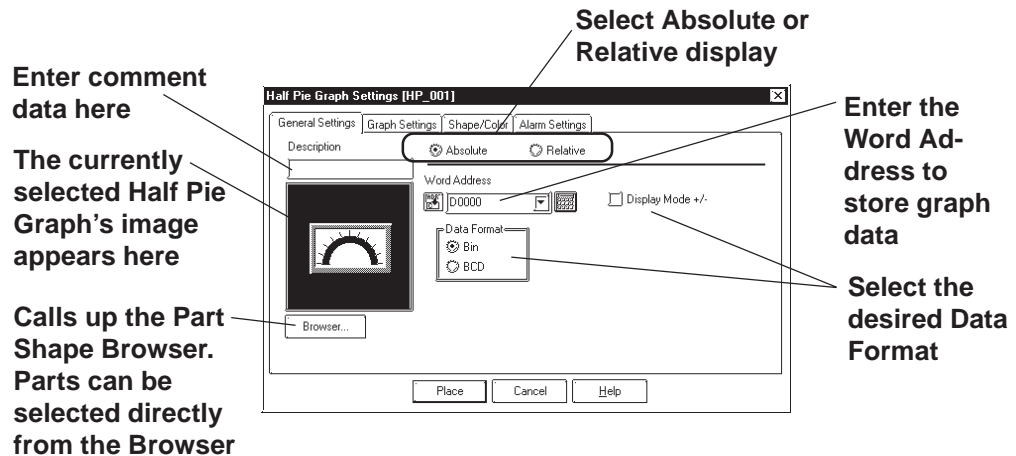

◆ Absolute

Data stored in the designated Word Address is displayed as absolute values, from 0 to 100 (with Display Mode +/- selected, -100 to 100).

◆ Word Address

Enter the Word Address where the data will be stored.

◆ Data Format

Select the display data format from Bin and BCD.

◆ Display Mode +/-

When this check box is checked and Bin data format is selected, negative numeric data can be displayed.

<When displaying the data in relative values>

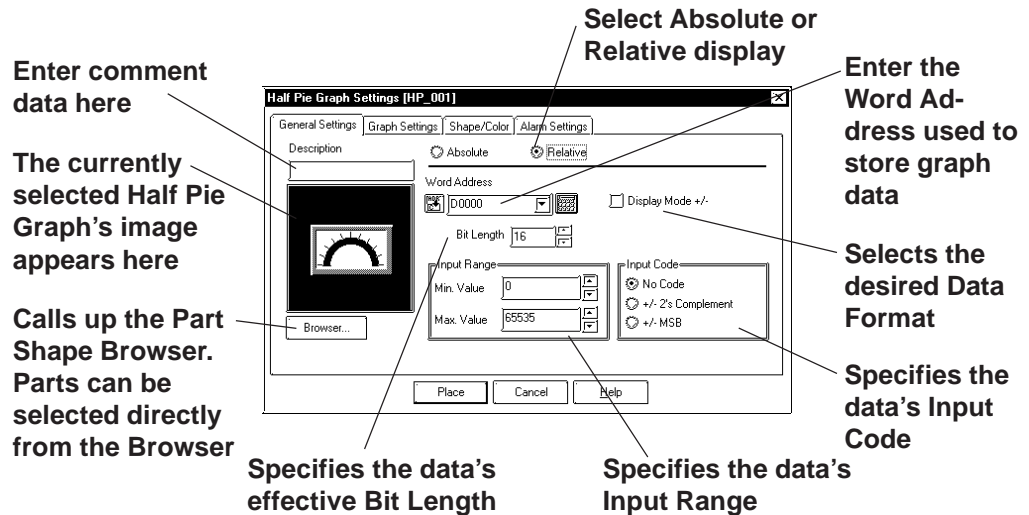
◆ **Relative**

According to the Input Range designated for the Word Address Data the data is converted and displayed as relative values.

◆ **Word Address**

Here, enter the Word Address used to store Half Pie Graph data.

◆ **Display Mode +/-**

When this check box checked, negative number data can be displayed.

◆ **Bit Length**

Specifies the Bit Length of all data stored in the Word Address.

◆ **Input Range**

Specifies the data's Input Range.

◆ **Input Code**

With No Code selected, only positive numeric data can be entered. To enter negative numeric data, select either +/-2's Complement or +/-MSB.

■ Half Pie Graph [Graph Settings] Attributes

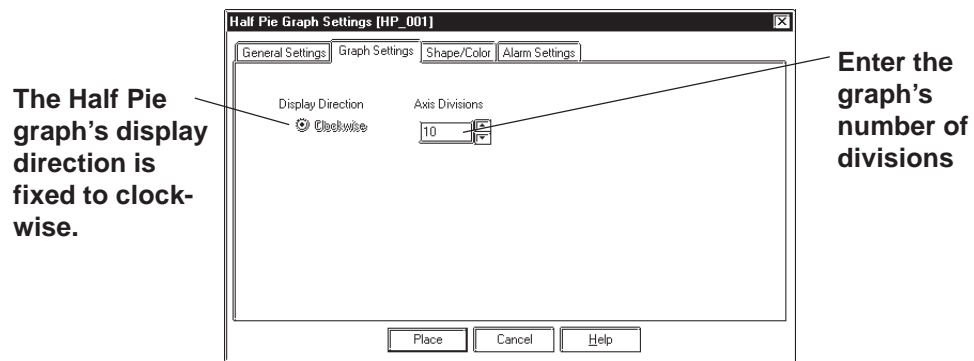

◆ Display Direction

Here, the Half Pie graph's display direction is fixed to clockwise.

◆ Axis Divisions

The data entered here determines how many pieces a Half Pie Graph is divided into. If the number of Axis Divisions is specified as 10, 11 division lines are displayed. When no divisions are necessary, specify the number of divisions as 0.

■ Half Pie Graph [Shape/Color] Attributes

Here, a Half Pie graph's border color, division color (Axis Color), display data color (Graph Color - Fg & Bg), and display data pattern are all selected.

▼ **Reference** ▲ 2.1 Parts ■ *Selecting Colors*

■ Half Pie Graph [Alarm Settings] Attributes

If desired, Alarm settings can be set here.





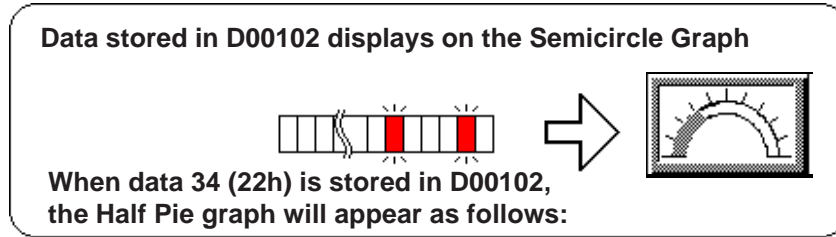

▼ **Reference** ▲ 2.1 Parts ■ *Setting Alarms*

■ **Placing a Half Pie Graph**

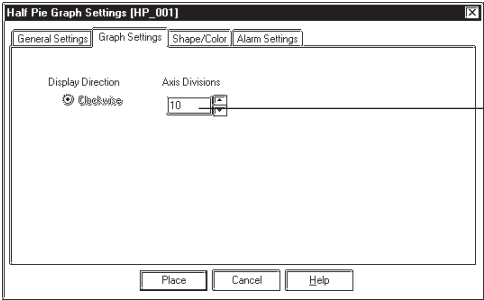
The procedure for placing a Half Pie Graph is as shown below.

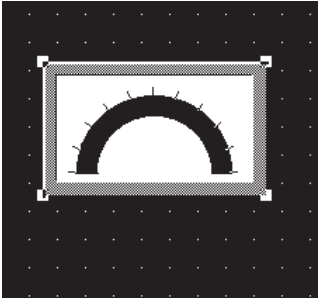

| PROCEDURE | REMARKS |
|--|--|
| <p>(1) Select the [Parts] menu - [Half Pie Graph] command, or click on the icon.</p> <p>(2) In the [General Settings] area, input the Word Address and Data Format.</p> <p>(3) Select a Part Shape from the Browser.</p> <p>You can also use the Alarm Settings area to enter Alarm settings and select Colors, if desired.</p> | <p>Reference 2.1 Parts ■ <i>Selecting a Part Shape</i></p> |

| PROCEDURE | REMARKS |
|---|---|
| <p>(4) In the [Graph Settings] tab, input the number of axis divisions.</p>  <p>Enter 10</p> <p>(5) After all of a Part's attributes have been entered or selected, click on the  button.</p> <p>The Half Pie graph's outline will appear on the Base screen, next to your cursor.</p> <p>(6) Click on the point where the Half Pie Graph's top left corner is to be placed.</p> <p>If desired, use the Half Pie graph's handles to alter its size.</p>  | <p>The area to enter the number of the divisions will appear only for a graph type which has axis divisions.</p> <p>To cancel the placement, click on the  icon.</p> <p>To change the Part's size, refer to Reference  <i>2.3.3 Scaling Up/Down</i></p> <p>Double-clicking on any Part placed on the screen automatically calls up that Part's attribute settings.</p> <p>Reference  <i>2.3.15 Changing Attributes</i></p> |

2.1.8 Meters

This Part creates an area where a External Device's Word Address' numeric data is displayed as absolute or relative values in a Meter (i.e. a needle moves to show the value). The graph's display will change to reflect External Device Word Address data changes.

■ Meter [General Settings] Attributes

<When displaying data in absolute values>

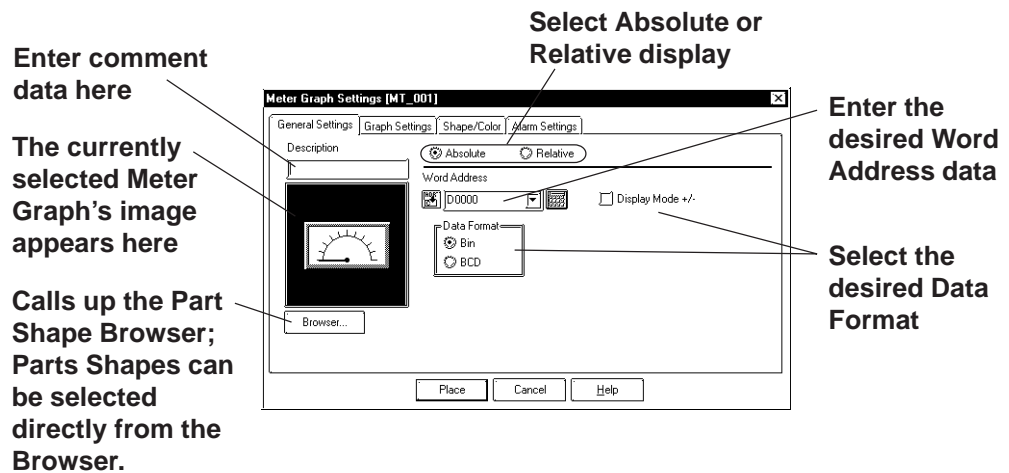

◆ Absolute

Data stored in the designated Word Address is displayed as absolute values, from 0 to 100 (with Display Mode +/- selected, -100 to 100).

◆ Word Address

Enter the Word Address where the data will be stored.

◆ Data Format

Select the display data format from Bin and BCD.

◆ Display Mode +/-

When this check box is checked and Bin data format is selected, negative numeric data can be displayed.

<When displaying data in relative values>

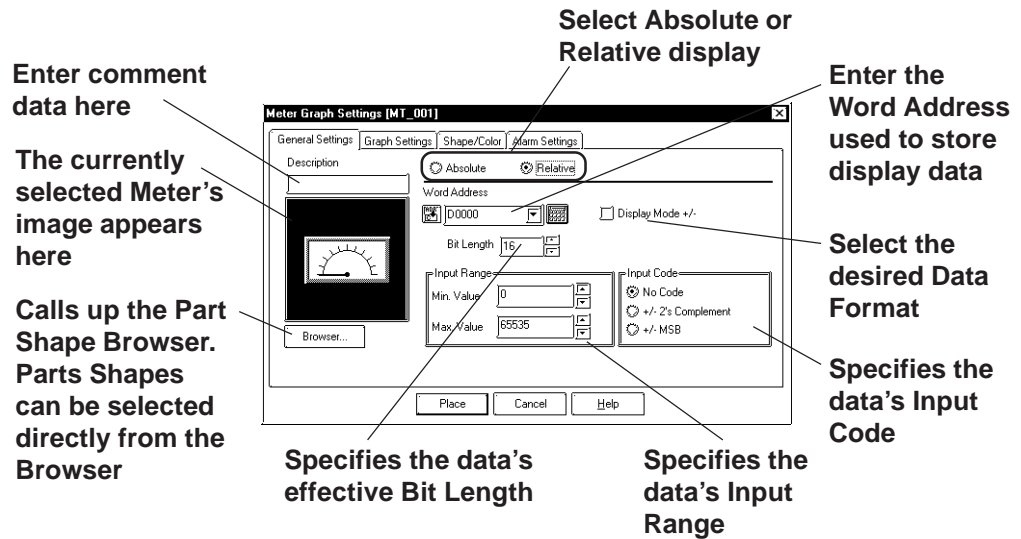

◆ **Relative**

According to the Input Range designated for the Word Address Data, the data is converted and displayed as relative values.

◆ **Word Address**

Here, enter the Word Address used to store Meter data.

◆ **Display Mode +/-**

When this check box checked, negative numeric data can also be displayed.

◆ **Bit Length**

Specifies the Bit Length of all data stored in the Word Address.

◆ **Input Range**

Specifies the data's Input Range.

◆ **Input Code**

With No Code selected, only positive numeric data can be entered. To enter negative numeric data, select either +/-2's Complement or +/-MSB.

■ Meter [Graph Settings] Attributes

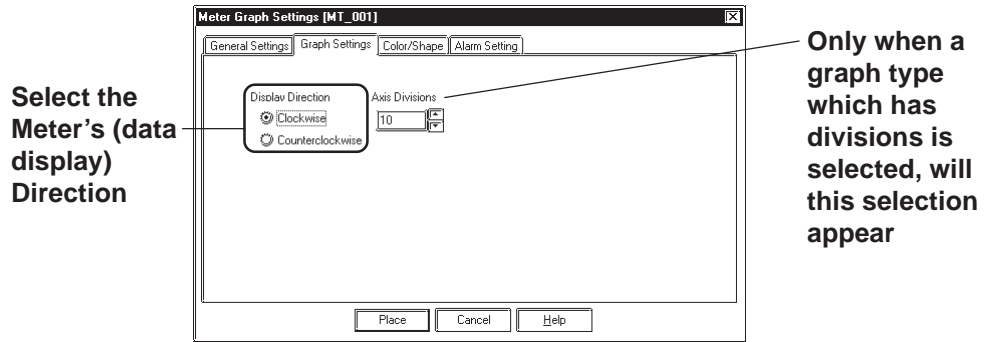

◆ Display Direction

Here, the Meter's display direction, either Clockwise or Counterclockwise can be selected.

◆ Axis Divisions

Here, the Meter increments are entered. If the number of Divisions is specified as 10, 11 division lines are displayed. When no divisions are necessary, simply enter "0".

■ Meter [Shape/Color] Attributes

Here, a Meter's border color, division color (Axis Color), and needle color (Meter Color) can be selected.

▼ **Reference** ▲ 2.1 Parts ■ *Selecting Colors*

■ Meter [Alarm Settings] Attributes

If desired, an Alarm's settings can be set here.

▼ **Reference** ▲ 2.1 Parts ■ *Setting Alarms*





■ **Placing a Meter**

The procedure for placing a Meter is as shown below.

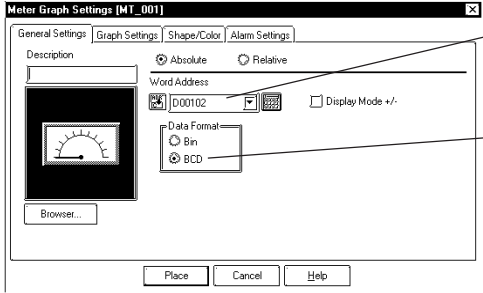
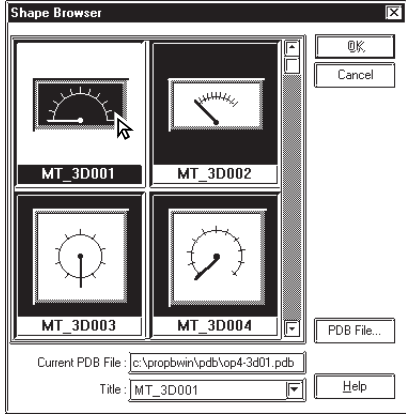
Data stored in D00102 displays on the Tank Graph

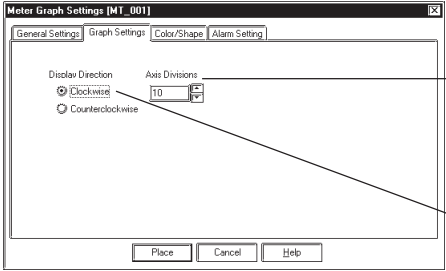
When data 34 (22h) is stored in D00102, the Meter will appear as follows:

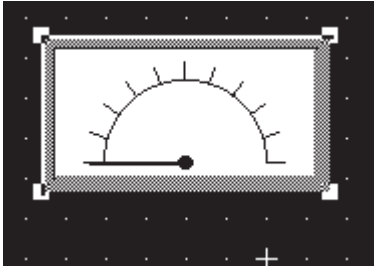
| PROCEDURE | REMARKS |
|---|---|
| <p>(1) Select the [Parts] menu - [Meter] command, or click on the icon.</p> <p>(2) In the [General Settings] area, input the Word Address and Data Format.</p> <div style="display: flex; align-items: center;">  <div style="margin-left: 20px;"> <p>Enter D00102</p> <p>Select BCD</p> </div> </div> <p>(3) Select a Part Shape from the Browser. You can also use the Alarm Settings area to enter Alarm settings and select Colors, if desired.</p> <div style="display: flex; align-items: center;">  </div> | <p style="text-align: center;">Reference 2.1 Parts ■ <i>Selecting a Part Shape</i></p> |

| PROCEDURE | REMARKS |
|--|---|
| <p>(4) In the [Graph Settings] area, input the number of divisions and data display direction.</p>  <p>(5) After all of a Part's attributes have been entered or selected, click on the  button.</p> <p>The Meter's outline will appear on the Base screen, next to your cursor.</p> <p>(6) Click on the point where the Meter's top left corner is to be placed.</p> <p>If desired, use the Meter's handle to alter its size.</p>  | <p>The Axis Divisions will appear only when Absolute display is selected.</p> <p>To cancel the placement, click on the  icon.</p> <p>To change the Part's size, refer to Reference 2.3.3 <i>Scaling Up/Down</i></p> <p>Double-clicking on any Part placed on the screen automatically calls up that Part's attribute settings. Reference 2.3.15 <i>Changing Attributes</i></p> |

2.1.9 Trend Graphs

This Part displays Word Address numeric data as absolute values on a Trend (line) graph. The graph’s display will then change to reflect Word Address data changes.

■ Trend Graph [General Settings] Attributes

Enter comment data here

The currently selected Trend Graph Shape appears here

Calls up the Part Shape Browser, displaying a list of pre-made Trend Graph Shapes. Part Shapes can be selected directly from the Browser.

Select the desired Data Format

◆ Data Format

Here, the display data format is specified as either Bin or BCD. With the Display Mode +/- check box checked, and Bin data format selected, negative numeric data can also be displayed.

■ Trend Graph [Graph Settings] Attributes

Select a graph type

Select the data display direction

Enter the No. of Samples, Scroll value, and Sampling Time

Enter the number of X and Y divisions

◆ Graph Settings

Using “Normal”: The specified Word Address’s data changes are displayed over time in a Trend Graph. Display data always starts at the “0” point. As each (time) sampling period elapses, the latest data is added in the specified display Direction. When the graph’s poly(gonal) line reaches the limit of the Trend Graph, the graph is shifted in the display Direction for the number units specified in “Scroll”.

E.g.) Display Direction: Right, Scroll: 4

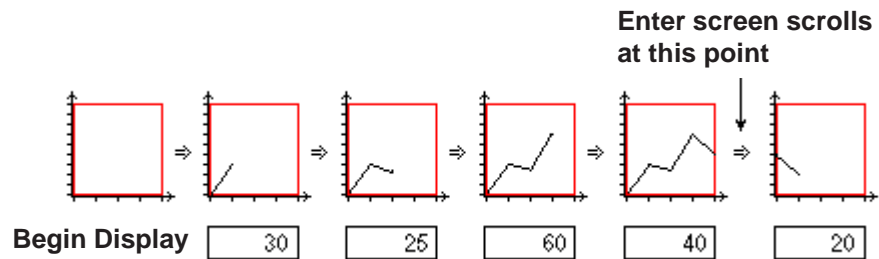

Using “Pen-Recorder”:

A specified Word Address’s data changes are displayed over time in a Trend Graph. The data’s display always begins with “0”. As each sampling period elapses, the graph’s poly(gonal) line is shifted one division opposite the specified display Direction. The latest data is always displayed at the very limit (in this example, the right side) of the Trend Graph’s display area.

E.g.) Display direction: Right

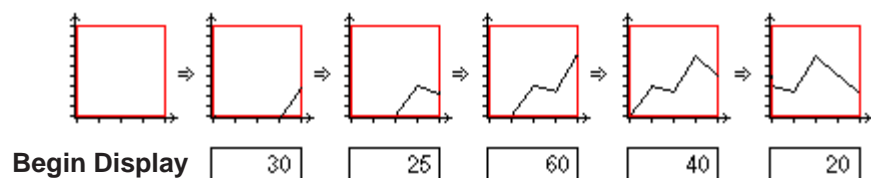

◆ Data Samples

Data Samples: The number of data “units” to be displayed in a single Trend Graph. Up to 638 can be used.

Scroll: The number of data units to be scrolled when the polygonal line reaches the limit of the Trend Graph’s display area.

Sampling Time: The data read interval (from the host External Device) is input in seconds.

◆ Display Direction

Select the Trend Graph’s display direction, either Up, Left, Down, or Right.

Note: If [Display Direction] is changed for a 3D part, its shade is rotated along with that part. To let the shade displayed properly, click on the button, and select the part again from [Shape Browser].

◆ Axis Scale

Enter the number of units that the X and Y axes are to be divided into. When no divisions are necessary, input “0”.

■ Trend Graph [Channel Settings] Attributes

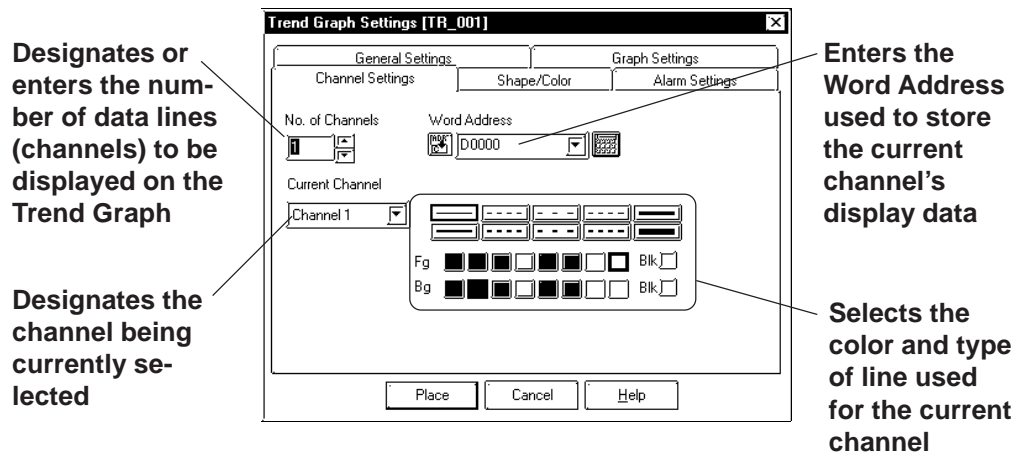

◆ Number of Channels

Enter the number of channels used in the Trend Graph. Use the “Current Channel” area to select which channel is being specified. Up to 20 channels can be entered in a Project file (LTE file, including the Data sampling frequency number).

◆ Word Address

Enter the Word Address used to indicate where the Trend graph's data is stored.

■ Trend Graph [Shape/Color] Attributes

The Trend Graph's border color, division color (Axis Color), and Trend Graph's display area color (Graph Area Color) can be selected.

Reference 2.1 Part ■ *Selecting Colors*

■ Trend Graph [Alarm Settings] Attributes

If desired, an alarm's settings can be set here.

Reference 2.1 Part ■ *Setting Alarms*

■ **Placing a Trend Graph**

An example of a Trend Graph (scrolling left to right) is shown below.

Data stored in D00102 is displayed on the Trend Graph

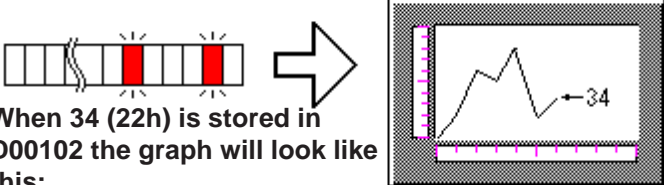

When 34 (22h) is stored in D00102 the graph will look like this:

| Axis Settings | |
|--------------------|--------|
| * Sample | 20 |
| * Scroll | 19 |
| * Sampling Time | 10 sec |
| * Axis Div. (Ver.) | 10 |
| " " (Hor.) | 10 |

| PROCEDURE | REMARKS |
|-----------|---------|
|-----------|---------|

(1) Select the [Parts] menu - [Trend Graph] command, or click on the  icon.

(2) After clicking on the [General Settings] tab, select the data format.

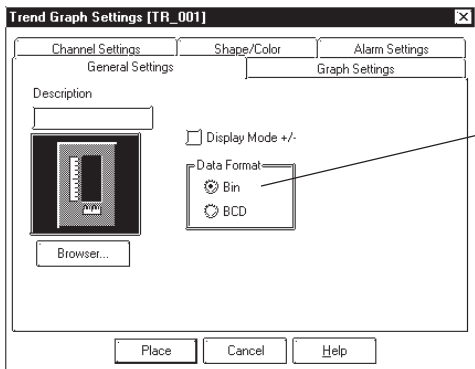

Select Bin

Data in the range of 0 to 100 can be displayed on the Trend Graph. When the data range is from -100 to 100, check the Display Mode +/- check box.

(3) Select a Part Shape from the Browser.

You can also use the Alarm Settings area to enter Alarm settings and select Colors, if desired.

Reference 2.1 Parts ■ *Selecting a Part Shape*

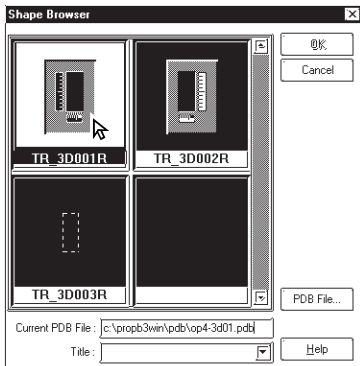

| PROCEDURE | REMARKS |
|-----------|---------|
|-----------|---------|

(4) In the [Graph Settings] area, select the Graph Type and Direction, and enter the number of Data Samples and Axis Divisions.

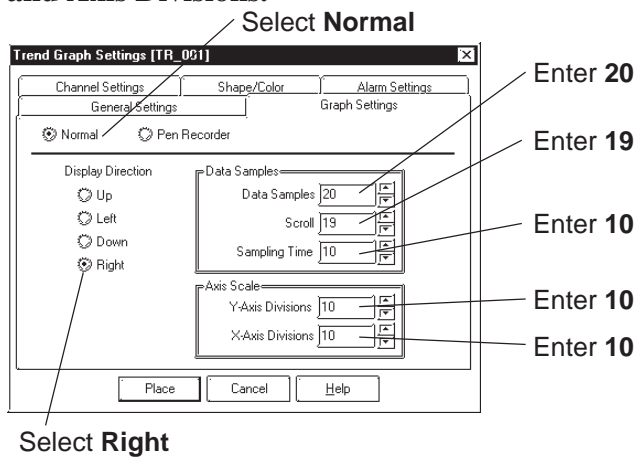

(5) In the Channel Setting area, enter the Number of Channels, then enter each channel's Word Address and select the desired colors.

In this example, since the Number of the Channels is "1", you only need to enter one Word Address.

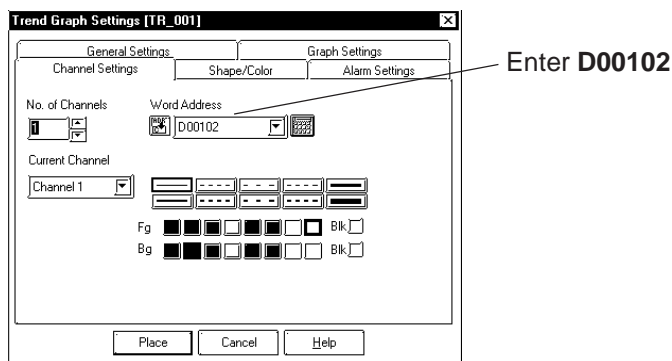

(6) After all of Part's attributes have been entered or selected, click on the  button.

The Trend Graph's outline will appear in the Base screen, next to your cursor.

(7) Click on the point where the Trend Graph's top left corner is to be placed.

If desired, use the Trend Graph's handles to alter its size, after placement.

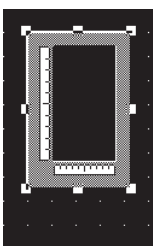

If the more than one channel is used, be sure to enter the Word Address and select the Color for each channel before placement.



A Trend Graph's channel Word Addresses should not be the same as other Part addresses, otherwise, it will cause a LT error.

Up to 20 channels can be designated for a Project file (including the Data Sampling frequency number).

Up to 8 Trend Graph display areas can be placed on a single screen.

To cancel the placement, click on the  icon.

To change a Part's size, refer to **Reference** 2.3.3 *Scaling Up/Down*

Double-clicking on any Part placed on the screen automatically calls up that Part's attribute settings.

Reference 2.3.15 *Changing Attributes*

2.1.10 Keypad Display

Here, the area used to display Pop-up Keypad data is created. When the Keypad Display is touched, a Pop-up Keypad appears, allowing you to enter a value.



Note:

When the Keypad display is placed, the Pop-up Keypad will automatically be set. You don't have to place a new keypad for entering numerical data.

■ Keypad Display [General Settings] Attributes

Enter comment data here

The currently selected Part's image will appear here

Calls up the Part Shape Browser. Parts can be selected directly from the Browser

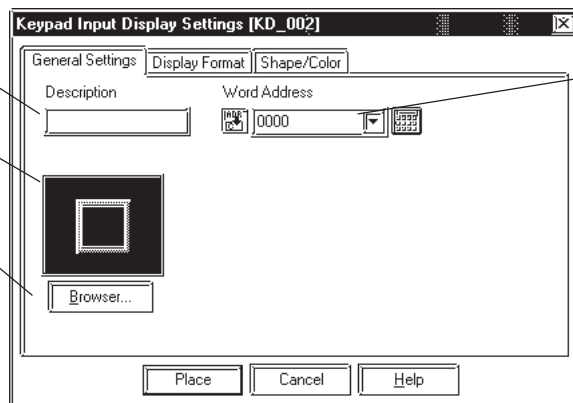

Enter the Word Address used to store display data

◆ Word Address

The Word Address is used to store the keypad display's data.

■ Keypad Display [Display Format] Attributes

When Numeric is selected, these selections appear. Select the Data Length and Data Format

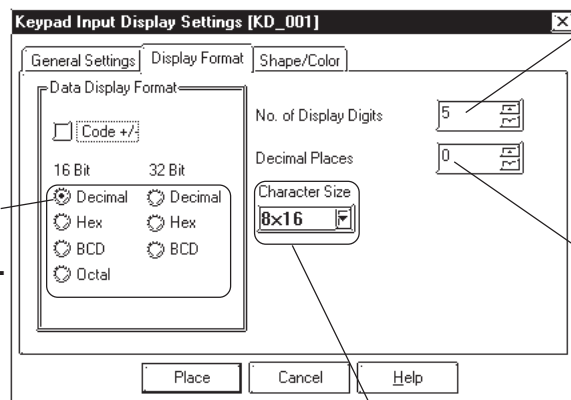

The decimal point is not included in the display digits. Enter the No. of Display Digits

Enter the No. of Digits after the decimal point

Character size can be selected here

◆ Data Display Format

Here, the data's Format, Code and Bit Length are selected. When selecting decimal, negative numeric data can also be displayed by clicking on the "Code +/-" check box.

◆ No. of Display Digits

Here, the number of digits displayed, to the right of the decimal point, is input.

◆ **Decimal Places**

Here, the number of digits to the right of the decimal point is input.

Each data format available is listed in the table below.

| Data Format | Code | Data Length | Display Digits | Decimal Places |
|-------------|------|-------------|----------------|----------------|
| Dec | +/- | 16 bit | 1-5 | 0-4 |
| Hex | + | | 1-4 | |
| BCD | + | | 1-4 | 0-3 |
| Oct | + | | 1-6 | |
| Dec | +/- | 32 bit | 1-10 | 0-9 |
| Hex | + | | 1-8 | |
| BCD | + | | 1-8 | 0-7 |

When using 32 bit data, the relationship between the top and bottom of the Word Address will differ depending on the External Device used.

▼ **Reference** ▲ *External Device Connection Manual*

 **Note:** When the No. of Display Digits is set to 5 and the Decimal Places is set to 2, a value appears on the Keypad Input Display as shown below.

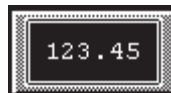

◆ **Character Size**

The label's character size is selected here.

▼ **Reference** ▲ *2.2.9 Text*

■ **Keypad Display [Color/Shape] Attributes**

The Keypad Display's border color, data display color (Text), and interior color (Plate) are selected here.

▼ **Reference** ▲ *2.1 Parts ■ Selecting Colors*

■ **Placing a Keypad Display**

The Keypad Display's placement procedures are shown below.

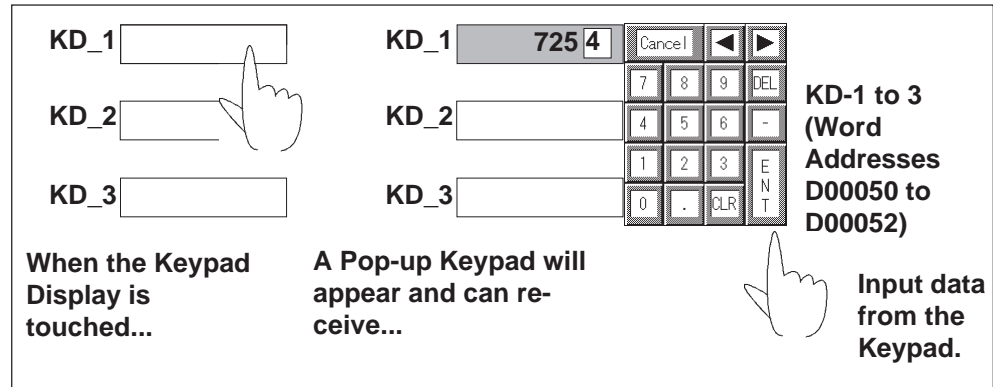

| PROCEDURE | REMARKS |
|-----------|---------|
|-----------|---------|

(1) Select the [Parts] menu - [Keypad Input Display] command, or click on the  icon.

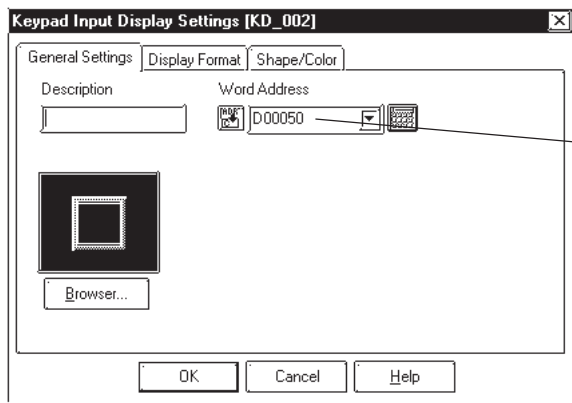

(2) In the [General Settings] area, enter the Word Address.

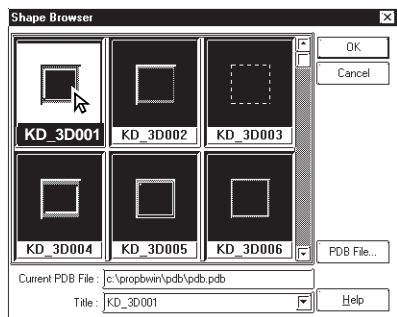

(3) Select a Part Shape from the Browser. If desired, select colors from the [Shape/Color] area.

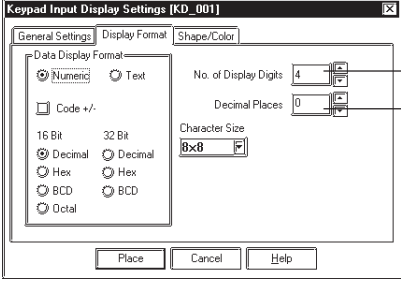

▼ **Reference** 2.1 Parts ■ *Selecting a Part Shape*

| PROCEDURE | REMARKS |
|---|--|
| <p>(4) In the [Display Format] area, specify the Data Display Format, No. of Display Digits, and Decimal Places (i.e. number of the digits after the decimal point) to be used. If desired, select the Character Size.</p>  <p>(5) After all of the Keypad Display's attributes have been entered and selected, click on the <input type="button" value="Place"/> button.</p> <p>The Keypad Display's outline will appear on the Base screen, next to your cursor.</p> <p>(6) Click on the point where the Keypad Display's top left corner is to be placed.</p> <p>If desired, use the Keypad Display's handles to alter its size.</p> <p>Even though the set value display area is scaled up or down, the character size will not change. To change the character size or position, directly select the characters inside the border.</p>  <p>(7) Repeat from step (1) to create Keypad Displays with Word Addresses "D0051" and "D0052".</p> <p>Except for the addresses, all settings should be the same.</p> | <p>To cancel the placement, click on the  icon.</p> <p>To change the Part's size, refer to Reference 2.3.3 <i>Scaling Up/Down</i></p> <p>Double-clicking on any Part placed on the screen automatically calls up that Part's attribute settings.</p> <p>Reference 2.3.15 <i>Changing Attributes</i></p> <p>If the <input type="button" value="Ctrl"/> key is pressed when the display area's border is scaled up or down, its interior characters are also scaled.</p> |

■ **Tips for using the Pop-up Keypad**

- The Pop-up Keyboard will appear on the right side of the Keypad Display. If there is not sufficient space there, the Pop-up Keyboard will automatically be placed on the upper, lower, or left side of the Keypad Display.
- If there are no spaces in all directions, the Pop-up Keypad will be shown in the lower right area of the screen. In this case, the Pop-up Keypad may hide the Keypad Display, which will prevent you from confirming the value you are entering.
- Be sure not to place the Keypad Display rotated. The Pop-up Keypad will

■ Using a Pop-up Keypad to Input Values

The procedures for entering setting values via a Pop-up Keypad on the LT screen are shown below.

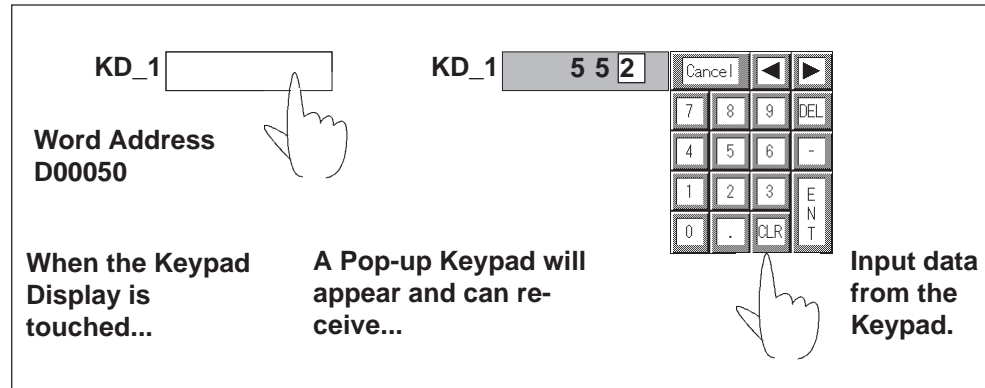

| PROCEDURE | REMARKS | | | | | | | | | | | | | | | | | | | | |
|--|---------|-----|-----|--|---|---|---|-----|---|---|---|---|---|---|---|-----|---|---|-----|---|---|
| <p>(1) Here, the Keypad Display KD_1 has been set on the LT screen.</p> <p style="text-align: center;">ID No.</p> <div style="display: flex; align-items: center;"> <div style="border: 1px solid black; width: 60px; height: 20px; margin-right: 5px;"></div> <div style="margin-left: 5px;">KD_1</div> </div> <p>(2) When the Keypad Display KD_1 is touched,</p> <div style="display: flex; align-items: center;"> <div style="margin-right: 10px;">KD_1</div> <div style="border: 1px solid black; width: 80px; height: 20px; position: relative;"> <div style="position: absolute; top: 50%; left: 50%; transform: translate(-50%, -50%); font-size: 2em;">↑</div> </div> </div> <p>(3) A Pop-up Keyboard appears. At the same time, the Keypad Display KD_1's display reverses (highlights) and waits for input. The square box shown below represents the cursor's position.</p> <div style="display: flex; align-items: center;"> <div style="border: 1px solid grey; width: 40px; height: 20px; margin-right: 5px;"></div> <div style="border: 1px solid black; padding: 2px;"> <table border="1" style="border-collapse: collapse; text-align: center;"> <tr> <td>Cancel</td> <td>◀</td> <td>▶</td> <td></td> </tr> <tr> <td>7</td> <td>8</td> <td>9</td> <td>DEL</td> </tr> <tr> <td>4</td> <td>5</td> <td>6</td> <td>-</td> </tr> <tr> <td>1</td> <td>2</td> <td>3</td> <td>ENT</td> </tr> <tr> <td>0</td> <td>.</td> <td>CLR</td> <td>T</td> </tr> </table> </div> </div> | Cancel | ◀ | ▶ | | 7 | 8 | 9 | DEL | 4 | 5 | 6 | - | 1 | 2 | 3 | ENT | 0 | . | CLR | T | <p>Reference For how to create a Keypad, refer to 2.1.11 "Placing a Keypad Display"</p> <p>When the Keypad display is placed, the Pop-up Keyboard will automatically be set.</p> |
| Cancel | ◀ | ▶ | | | | | | | | | | | | | | | | | | | |
| 7 | 8 | 9 | DEL | | | | | | | | | | | | | | | | | | |
| 4 | 5 | 6 | - | | | | | | | | | | | | | | | | | | |
| 1 | 2 | 3 | ENT | | | | | | | | | | | | | | | | | | |
| 0 | . | CLR | T | | | | | | | | | | | | | | | | | | |

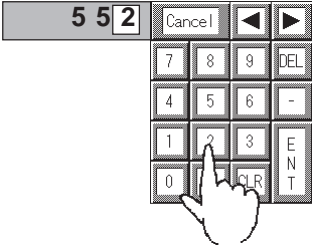
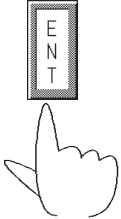
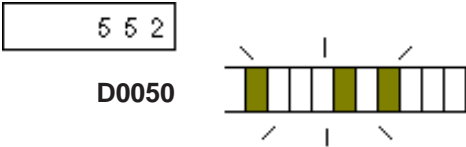
| PROCEDURE | REMARKS |
|---|---------|
| <p>(4) Press the Pop-up Keypad's keys to input the desired value.</p>  <p>(5) Press the [ENT] key to register the value.</p>  <p>(6) The registered value will then be stored in Word Address D0050, which was designated in KD_1. Then the Pop-up Keypad disappears.</p>  | |

2.1.11 Alarm Display

When the External Device's Monitor Bit has been turned ON, messages registered in the Alarm Summary by the Alarm Editor can be displayed in a list.

Reference 5.1 Creating and Editing Alarms

Message display order is decided according to which Monitor Bit is in the lowest position in the Alarm Summary display area. It is recommended that Monitor Bit assignment begins from the message with the highest priority. Be sure to input only one message per line. The characters of a message that exceed one line will be truncated.

The number of the characters that can be displayed in one line will vary depending on the character size and LT type. When the size is 1 x 1, the maximum number of characters that can be displayed per line for each LT model is 40 single-byte characters.

■ Alarm Summary [General Settings] Attributes

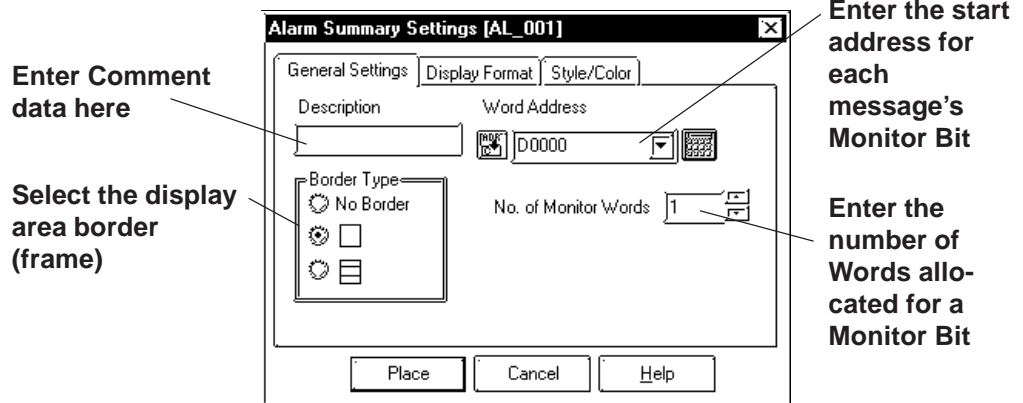

◆ Border Type

The display area frame types are No Border, Outside, and Outside + Inside.

◆ Word Address

The Monitor Bit's first address for the messages specified by the Alarm Editor is input. Input this address in word units.

E.g.) How to designate a Word Address using an external device (THERMAC NEO Series - Omron):

When designating the Word Address for the input/output or internal relay, the Word Address is designated from the Least Significant Bit.

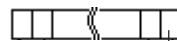

01/C0000031 to 01/C0000000

← High Low → LSB

In this case, 01/C0000000
is designated



When a variable (Logic symbol) is used as an address, an integer array must be designated. For an integer array, a size required for consecutive addresses needs to be allocated.

◆ **No. of Monitor Words**

Here, the number of words a Monitor Bit is assigned and entered. Up to 100 words can be monitored.

■ **Alarm Summary [Display Format] Attributes**

◆ **Display Start Line**

Among the messages whose Monitor Bit is turned ON, the Start Line designates from which message the display starts.



Note: When the Alarm Summary display cannot fit in a single screen, only one Alarm Summary display can be placed on a screen. When the number of messages to be displayed does not fit on one screen, create Alarm Summary displays on multiple screens, so that the screens will switch to display all the messages. To display all error messages continuously, specify each screen's Start Line as follows:

- The first screen: The starting line
- The second screen: The number of display lines on the first screen + 1
- .
- .
- .
- The nth screen: The number of display lines on any screen x (n-1) + 1

◆ **No. of Display Lines**

Designates the maximum number of alarm message lines that can be displayed on one screen. Up to 50 lines can be displayed.

◆ **No. of Display Char.**

Designates the maximum number of characters that can be displayed on a line. The screen's limit is 100 characters per line. However, the maximum number of characters for each LT unit will vary depending the model.

■ **Alarm [Style/Color] Attributes**

The display area color when a message is cleared (Clear Color) is selected.

▼ **Reference** 2.1 Parts ■ **Selecting Colors**

■ **Placing an Alarm Summary Display Area**

The Alarm Summary Display Area's setting procedure is shown below.

| | Bit Address | Type | Message |
|---|-------------|---------|-----------------------|
| 1 | M0800 | Summary | ErrorCode030 Unit 0D5 |
| 2 | M0801 | Summary | ErrorCode040 Unit 0D5 |
| 3 | M0802 | Summary | ErrorCode041 Unit 0D6 |

ErrorCode030 Unit 0D5

ErrorCode040 Unit 0D5

ErrorCode041 Unit 0D6

⋮

100 Alarm Messages, have been assigned to bits M0800 to M0896 in the Alarm Editor

Appear on the screen in a Summary Display, at 10 lines by 30 characters per display.

| PROCEDURE | REMARKS |
|-----------|---------|
|-----------|---------|

(1) Select the [Parts] menu - [Alarm Display] command, or click on the icon.

(2) In the [General Settings] tab, input the Word Address, No. of Monitor Words, and select one of the Show Border options.
 Here, since the Word Address range is from M0800 to M0896, enter "7" for the number of Monitor Words.

▼ **Reference** 2.1.12 Alarm Summary Display ■ Alarm Summary [Description] Attribute ◆ Word Address

Enter M0800

Enter 7



Select Border type

(3) In the [Display Format] tab, input the Display Start Line, No. of Display Lines, and No. of Characters. In the [Style/Color] tab, select the Clear(ing of Data) Color, if desired.

Enter 1

Enter 10

Enter 30

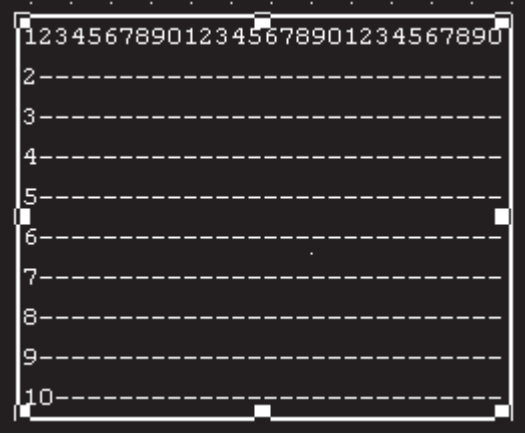
| PROCEDURE | REMARKS |
|--|---|
| <p>(4)After all of the Part’s attributes have been entered and selected, click on the  button. The Alarm Summary display area’s border will appear in the Base screen, next to your cursor.</p> <p>(5)Click on the point where the Alarm Summary display area’s top left corner is to be placed. If desired, use the Alarm Summary display handles to alter its size. When the Alarm Summary display is scaled up or down, the displayed character size will also change, according to the border’s size.</p> | <p>To cancel placement, click on the  icon.</p> <p>To change the Part size, refer to Reference 2.3.3 <i>Scaling Up/Down</i></p> <p>Double-clicking on any Part placed on the screen automatically calls up that Part’s Attribute Settings dialog box. Reference 2.3.15 <i>Changing Attributes</i></p> <p> <i>Important</i></p> <p>Be sure to use the Alarm Summary’s display area only for displaying Alarm Messages, i.e. never place, overlap, or overlay another Part or object in this area.</p> |
|  | |

2.1.12 File Name Display

Data registered in the Filing Data settings is displayed.

Reference *Tag Reference Manual; 10.1 Filing Data (Recipe) Function*

■ File Name Display [General Settings] Attributes

◆ Description

Enter a description using a maximum of 20 single-byte characters.

◆ ID No.

The File Name Display is linked to its function switch (File Name Key). Specify the number to identify this link is here. This number is available up to 255.

◆ File No.

Enter the file number registered in the Filing Data list (1 to 2047). The names under this number are displayed when the file is opened.

Reference *Tag Reference Manual; 10.1 Filing Data (Recipe) Function*

◆ Use LS Area

When Filing Data is transferred between backup SRAM and the External Device, it can be modified on the LT screen by routing it via the LS area (the data is stored temporarily in the LS area). If data transfer via the LS area is used, specify the LS area's start-word address where Filing Data will be stored from. The address where the data can be stored is from LS0020 to LS2031, and LS2096 to LS4095.

◆ External Device Transfer

If set, this bit will turn ON when transfer of filing data to the External Device is completed. Since this Bit does not turned OFF automatically, to use the External Device Transfer Completed Bit again, turn it OFF beforehand.



Note: When the External Device Transfer Completed Bit Address has been entered, in the case where filing data cannot be transferred to the External Device, the

■ File Name Display [Display] Attributes

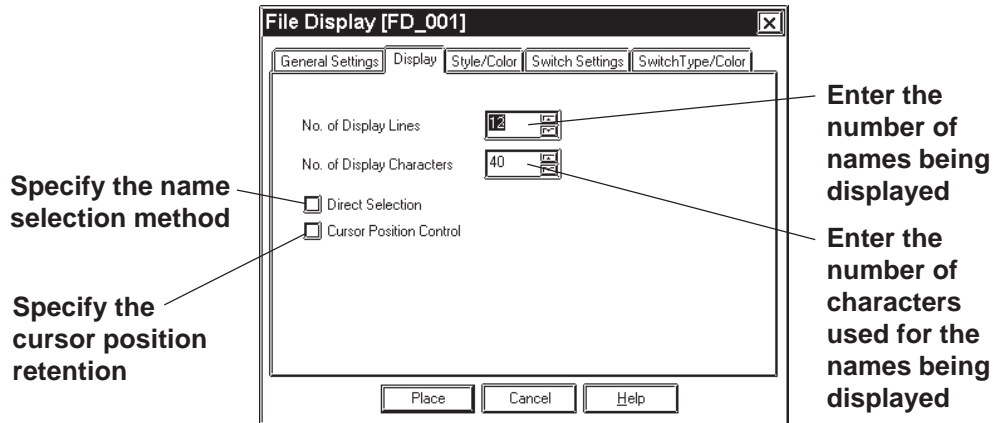

◆ No. of Display Lines

Specify the number of Filing Data rows displayed on the LT. A maximum of 50 rows may be specified.

◆ No. of Display Characters

Specify the number of Filing Data characters used on each row. A maximum of 100 characters may be specified.

◆ Direct Selection

Select a File Name Display being placed on the LT by directly touching its border. If [Direct Selection] is not used, select the file name using the data scroll switches [Roll Up/Roll Down].

▼ **Reference** ■ File Name Display [Switch Settings] Attributes

◆ Cursor Position Control

Even when the screens are changed on the LT, the current screen's cursor position can be retained. When turning the LT's main power switch ON or resetting the LT, however, the cursor will appear in the first line.



Note: The cursor position will be stored for each ID No. To retain the cursor position, be sure that the File Name Display ID Nos. will not be overlapped through all the screens.

■ File Name Display [Style/Color] Attributes

Specify a color [display color (Fg)] for characters in the Filing Data display area, and a color [display color (Bg)] of the Filing Data display area.

▼ **Reference** 2.1 ■ Selecting Colors

■ File Name Display [Switch Settings] Attributes

Set the function switches that are placed automatically.

▼ **Reference** 2.1.3 Function Switches

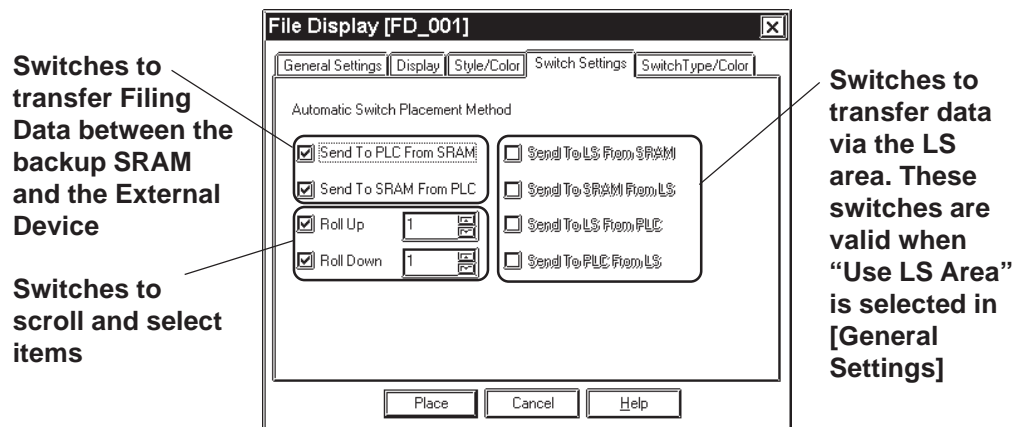

◆ **Send To External Device From SRAM**

Places the switch used to transfer Filing Data from the backup SRAM to the External Device.

◆ **Send To SRAM From External Device**

Places the switch used to transfer Filing Data from the External Device to the backup SRAM.

◆ **Roll Up**

Places the Roll Up key used to scroll through a list of items. Touching the Roll Up key once will roll up by the number specified here.

◆ **Roll Down**

Places the Roll Down key used to scroll through a list of items. Touching the Roll Down key once will roll down by the number specified here.

◆ **Send To LS From SRAM**

Places the switch used to transfer Filing Data from the backup SRAM to the LS area.

◆ **Send To SRAM From LS**

Places the switch used to transfer Filing Data from the LS area to the backup SRAM.

◆ **Send To LS From External Device**

Places the switch used to transfer Filing Data from the External Device to the LS area.

◆ **Send To External Device From LS**

Places the switch used to transfer Filing Data from the LS area to the External

■ File Name Display [Switch Type/Color] Attributes

Specify colors (border colors) for the function switches which are placed automatically.

▼Reference▲ 2.1.3 Function Switches

■ Place File Name Display

Shows how to call up the File Name Display.

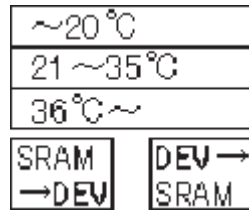



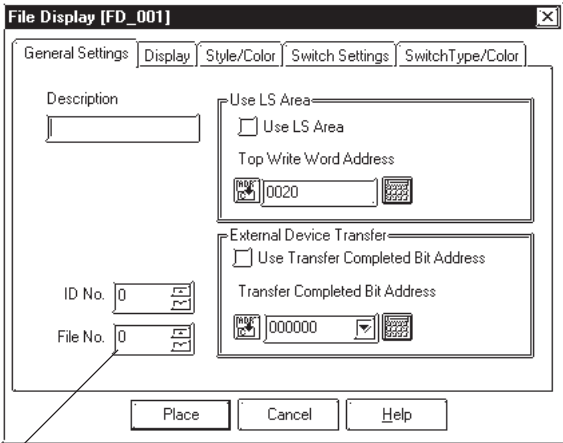

Registered File No. 1's filing data is displayed on the File Name Display with 3 display lines and 10 display characters.

By pressing a function key (File Name Key), filing data can be transferred from the SRAM to the External Device, or from the External Device to the SRAM.

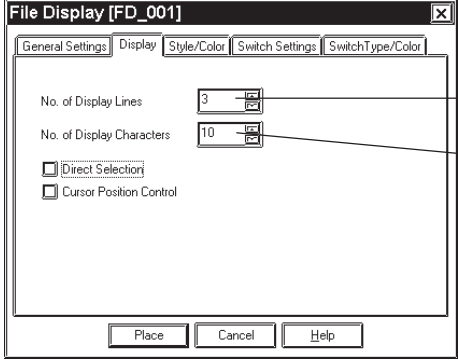
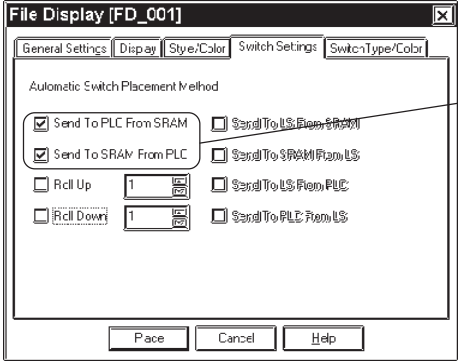
▼Reference▲ For filing data list and registering filing data, refer to 10.1 Filing Data (Recipe) Function.

| PROCEDURE | REMARKS |
|---|---|
| <p>(1) Select the [Parts] menu - [File Name Display] command, or click on the  icon.</p> <p>(2) In the [General Settings] tab, enter the File No. of filing data to be transferred and the File Name Display's ID No. Here, since File No. 1's data is transferred, enter "1" for the file number. The File Name Display's ID No. is "0".</p>  <p>Enter 1</p> | <p>▼Reference▲ ■ File Name Display [General Settings] Attributes</p> <p>To transfer Filing Data via the LS area, mark the check box for [Use LS Area] in the [Use LS Area].</p> |

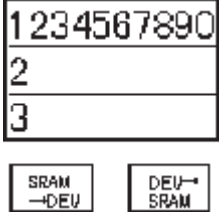
| PROCEDURE | REMARKS |
|--|---------|
| <p>(3) In the [Display] tab, specify the No. of Display Lines, Display Characters, Direct Selection, and Cursor Position Control. If necessary, specify the display color in the [Style/Color] tab.</p>  | |
| <p>(4) In the [Switch Settings] tab, select the function switches which are being placed automatically, and specify the number of lines being rolled up or down.</p>  | |
| <p>(5) Specify the border colors for the function switches in the [Switch Type/Color] tab.</p> | |
| <p>(6) After setting all the attributes, click on <input type="button" value="Place"/>. The frame of the File Name Display size will be displayed in the drawing area.</p> | |

| PROCEDURE | REMARKS |
|--|--|
| <p>(7) Click the mouse button where you want to place each attribute.</p>  <p>(8) Select the placed File Name Display. Then, select the [Edit] menu - [Ungroup] command, or click on the  icon to ungroup the File Name Display and alter each item's position and size.</p>  | <p>To cancel the placement, click on the  icon.</p> <p>The File Name Displays are grouped. To change any attribute, first ungroup the File Name Displays, and then change the attribute. Reference 2.3.12 Group/Ungroup Reference 2.3.15 Changing Attributes</p> <p>If “Use LS Area” is selected, the address for the LS area can be changed after ungrouping the File Name Displays.</p> |

2.1.13 Data Logging Display

Data created in the data logging settings can be displayed and edited on the LT unit.



After the data logging settings, place the Data Logging Display.

Reference For registering logged data, refer to *10.2 Logging Function*



- Only one Data Logging Display can be placed on each screen.
- The Data Logging Display cannot be set simultaneously with Keypad Input Display.
- Data that could not be logged due to a read error is identified with “****” in a cell.
- Data that is not logged is not displayed.

■ Data Logging Display [General Settings] Attributes

Enter a comment, if necessary

Specify whether the data edit function is enabled or disabled

Specify whether the interlock function is enabled or disabled

Using a word address, specify the block number of data being displayed

Using a bit address, specify the interlock address

◆ Block Number Address

On a block basis, specify the data being displayed. The logged data for the block number stored at the word address specified here will be displayed.

The block numbers that can be entered are between 0 and 2047, but the maximum of the effective range is [Number of Blocks] specified in [Trigger Settings] in the data logging settings. If [Number of Blocks] specified in [Trigger Settings] is 4, the block numbers are 0 to 3 (BIN values only).



- If any block number that does not exist is specified, no data will be displayed.
- When the loop function has been designated via [Trigger Settings] of the data logging settings, the Block Number Address will become ineffective.

◆ Data Edit

The logged data can be modified by directly touching the frame of each item in the Data Logging Display placed on the LT. If Data Edit is enabled, touching the cell of data that can be modified in the table will cause the buzzer to sound and allow you to enter data. If Data Edit is disabled, this touching will be invalid and the buzzer will not sound.



- Note:**
- The data that can be modified is only [Date] and [Value] that have been logged.
 - If a block or logged data is selected by changing the block number during on-screen modification of data, the data edit mode is canceled.
 - If the cell is moved beyond the display area, using the scroll keys during the data edit mode, the data edit mode is canceled.

◆ Interlock

The interlock can only be activated when the data edit capability is enabled. If the interlock is enabled, data can be modified only when the bit address for the interlock is ON. If the interlock is disabled, data can always be modified by touching it.



- Note:** If the bit address for the interlock is turned OFF during on-screen modification of data, the data edit mode is canceled.

■ Data Logging Display [Data Type] Attributes

Select a Border Type of the display area

Specify whether the scrolling of the total width data section is enabled or disabled

Enter the number of rows for the items displayed (0 to 40)

Enter the number of columns for the items displayed (0 to 25)

Enter a display interval (the number of dots) (0 to 10)

◆ Border Type

Select a border type of the display area from among three types, No Border, outer border (1-dot lines), and outer border plus inner border (the outer border and item use 2-dot lines, while the inner border uses 1-dot lines).

◆ Row

Specify the number of rows used to display logged data on the LT. A maximum of 40 rows may be specified.

◆ **Column**

Specify the number of columns used to display logged data on the LT. A maximum of 25 columns may be specified.

◆ **Spacing**

Specify spacing at which to display logged data on the LT. A maximum of 10 dots may be specified. This entry is only valid when the display area border type is specified as No. Border. Draw the border line using the drawing tool.



Note: The gap equivalent to the specified display spacing is provided between the cell and the border line. The entire cell is filled with the clear color specified in the Data Logging Display [Color] Attributes. However, the gap is not displayed in the clear color, but its background is displayed. If No Border is selected to draw an arbitrary border, ensure that the border is drawn using the same width as the specified display interval without overlapping the cell.

<Display Spacing>

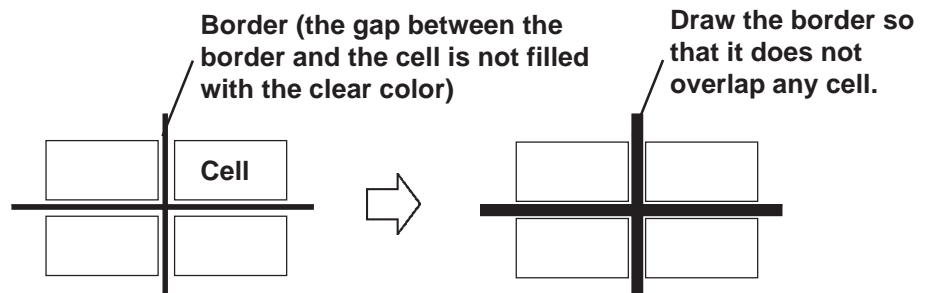

◆ **Scroll data area**

If the scroll data area is enabled, the totaling section is scrolled together with the data section. If the totaling section scroll is disabled, the totaling section always appears on the screen.

■ **Data Logging Display [Color] Attributes**

Select a color (clear color) displayed when the border of each item is cleared.

▼ **Reference** 2.1 ■ *Selecting Colors*

■ Data Logging Display [Switch Settings] Attributes

The number of rows and that of columns specified in [Data type] are displayed on the Data Logging Display. If any data exceeding these numbers exists in the LT, use the function switches to scroll the data.

▼ **Reference** ▲ 2.1.3 Function Switches

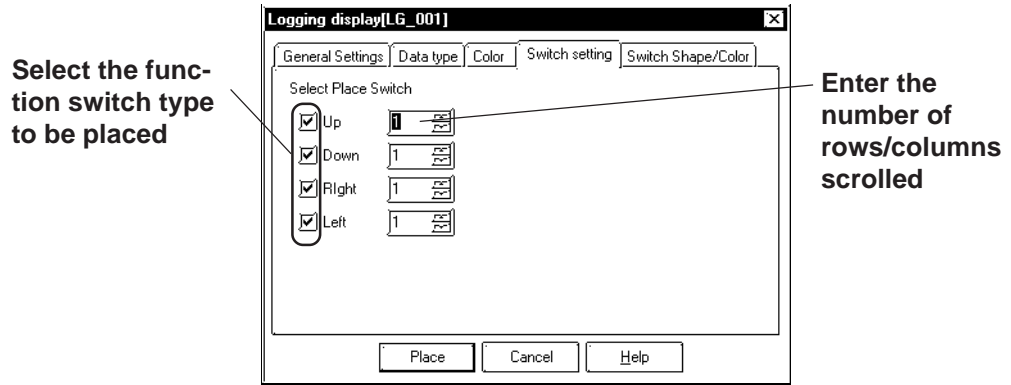

■ Data Logging Display [Switch Shape/Color] Attributes

Specify a color (border color) of each function switch.

▼ **Reference** ▲ 2.1 ■ Selecting Colors

■ Placing the Data Logging Display

The procedure for setting the Data Logging Display is described below:

The logged data for the block number stored at the block number designated address is displayed.

| | Date | Time | Data1 | |
|-------|----------|----------|-------|----|
| 1st | 98/10/16 | 09:14:00 | 144 | UP |
| 2nd | 98/10/16 | 09:14:00 | 145 | DN |
| 3rd | 98/10/16 | 09:14:01 | 146 | R |
| 4th | 98/10/16 | 09:14:01 | 147 | L |
| 5th | 98/10/16 | 09:14:01 | 148 | |
| TOTAL | | | 730 | |

If 3 is stored at D0100

The logged data in block No. 3 will be displayed.

| PROCEDURE | REMARKS |
|-----------|---------|
|-----------|---------|

(1) Select the [Parts] menu - [Data Logging Display] command, or click on the icon.



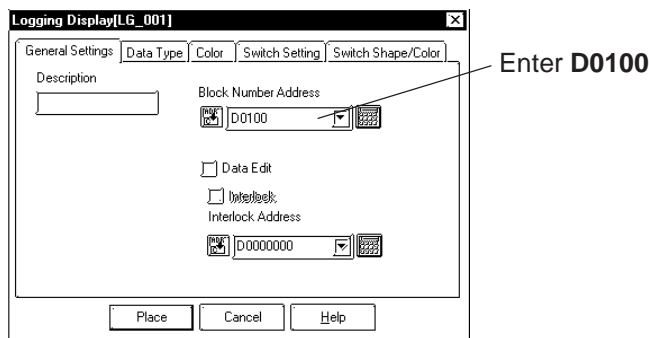

(2) In the [General Settings] tab, specify the block number designated address, data edit, and whether the interlock is enabled or disabled.
Specify D0100 for the block number designated address.

Reference 2.1.13 ■ Data Logging Display [General Settings] Attributes ◆ Block Number Address

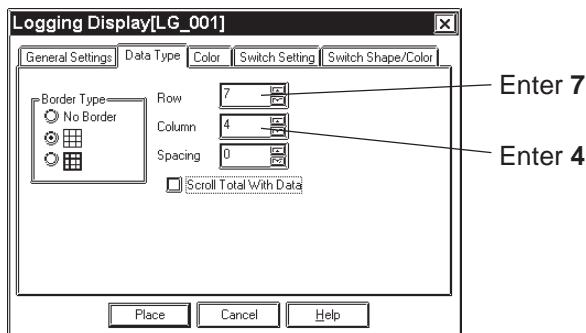

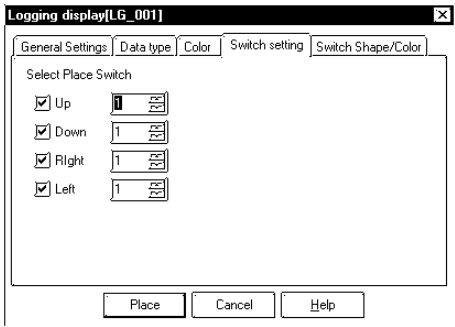
(3) In the [Data Type] tab, specify the display settings.
If necessary, select a clear color in the [Color] tab.

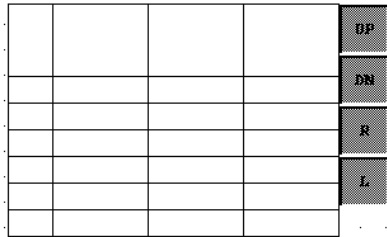

| PROCEDURE | REMARKS |
|---|--|
| <p>(4) In the [Switch Settings] tab, select the function switch type that is to be placed automatically, and specify the number of rows, columns scrolled. If necessary, select a color for the special switch in the [Switch Shape/Color] tab.</p>  <p>(5) After entering and selecting all the attributes, click on the  button. The border of the Data Logging Display size will be displayed in the drawing area.</p> <p>(6) Click on the point where the function switch will be placed.</p>  | <p>To cancel the placement, click on the  icon.</p> <p>The Data Logging Displays are grouped. To change any attribute, ungroup the Data Logging Displays by clicking on the  icon beforehand.</p> <p>Reference 2.3.13 <i>Group/Ungroup</i></p> <p>If you double-click on the function switch placed on the screen, the address confirmation screen for parts will appear, enabling you to change the address.</p> <p>Reference 2.3.15 <i>Changing Attributes</i></p> |

2.1.14 Numeric Displays

This Part displays host Word Address numeric data as an absolute value.

■ Numeric Display [General Settings] Attributes

Enter Comment data here

Displays the currently selected Part's image

Calls up the Part Shape Browser

Enter the Word Address where the display data is stored

◆ Word Address

Here, input the Word Address where the display data is to be stored.

■ Numeric Display [Display Format] Attributes

Select the Data Format and Data Length

Enter the total number of digits used (not including the decimal point) in the display

Enter the number of digits to be displayed after the decimal point

Select the size used for the label's characters

◆ Data Display Format

Here, the Data Display Format, Code, and data length are selected. Choose a data format of either Decimal (base 10), BCD, Hexadecimal (base 16), or Octal (base 8). With the Code +/- check box checked, when you select "Decimal", negative numeric data can also be displayed.

◆ No. of Display Digits

Here, enter the total number of digits used (not including the decimal point) in the display.

Note: When the No. of Display Digits is set to 5 and the Decimal Places is set to 2, a value appears on the Numeric Display as shown below.

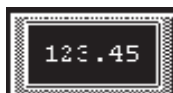

◆ **Decimal Places**

Here, enter the number of digits to be displayed after the decimal point

The types of numeric data that can be used with each data format are listed below.

| Data Format | Code | Data Length | No. of Display Digits | Decimal Places | Alarm Range | |
|-------------|--------|-------------|-----------------------|----------------|---------------------------|-----------------|
| Decimal | +/- | 16 bit | 1-5 | 0-4 | + only | 0 to 65535 |
| | | | | | +/- | -32768 to 32767 |
| | 32 bit | 1-10 | 0-9 | + only | 0 to 4294967295 | |
| | | | | +/- | -2147483648 to 2147483647 | |
| BCD | + | 16 bit | 1-4 | 0-3 | 0 to 9999 | |
| | | 32 bit | 1-8 | 0-7 | 0 to 99999999 | |
| Hex | + | 16 bit | 1-4 | / | 0 to FFFF | |
| | | 32 bit | 1-8 | | 0 to FFFFFFFF | |
| Octal | + | 16 bit only | 1-6 | | 0 to 177777 | |

The relationship between upper and lower position Word Addresses when 32 bit data is used will differ depending on each External Device.

▼ **Reference** ▲ *External Device Connection Manual*

◆ **Character Size**

The label's Character Size is selected here.

▼ **Reference** ▲ *2.2.9 Text*

■ **Numeric Display [Shape/Color] Attributes**

Here, the Numeric Display area's border color, value display color (Number color), and interior color (Plate color) are selected.

▼ **Reference** ▲ *2.1 ■ Selecting Colors*

■ **Numeric Display [Alarm Settings] Attributes**

If desired, specify a variety of Alarm settings.

▼ **Reference** ▲ *2.1 ■ Setting Alarms*

■ **Placing a Numeric Display**

The procedure for placing a Numeric Display is shown below.

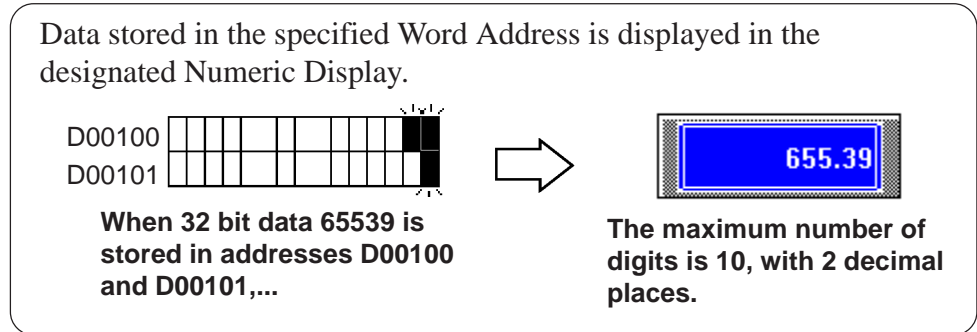

| PROCEDURE | REMARKS |
|-----------|---------|
|-----------|---------|

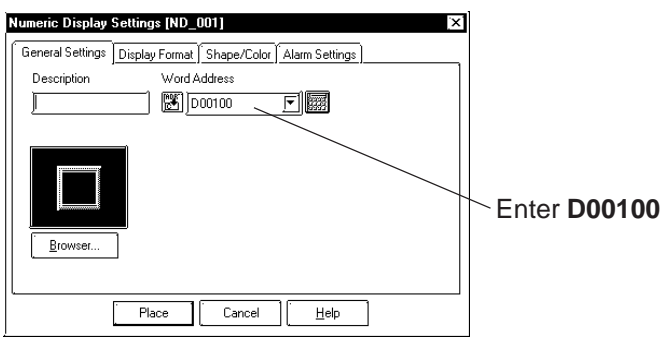

- (1) Select the [Parts] menu - [Numeric Display] command, or click on the icon.
- (2) In the [General Settings] tab, input the Word Address used to store the display data.

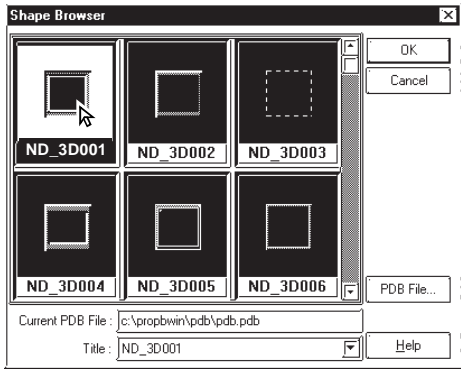

- (3) Select a Part Shape from the Browser. If desired, set an Alarm and Colors from the [Alarm Settings] and [Shape/Color] area.

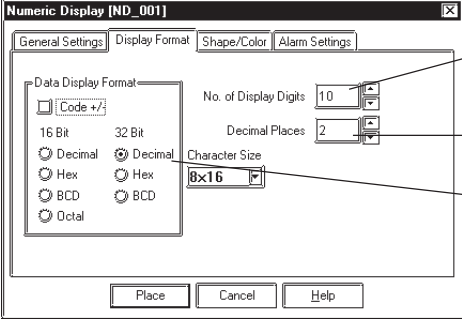

Reference 2.1 Part ■ *Selecting a Part Shape*

| PROCEDURE | REMARKS |
|--|---|
| <p>(4) In the [Display Format] area, specify the Data Display Format, and input the No. of Display Digits and the Decimal Places. Specify the Character Size, if desired.</p>  <p>Enter 10</p> <p>Enter 2</p> <p>Select 32 bit Decimal</p> | |
| <p>(5) After all of the Part's attributes have been entered and selected, click on the <input type="button" value="Place"/> button. The Numeric Display's outline will appear on the Base screen, next to your cursor.</p> | |
| <p>(6) Click on the point where the Numeric Display's top left corner is to be placed. If necessary, use the Numeric Display's handles to alter its size after placement. Regardless of whether the numeric data display area is scaled up or down, the character size will not change. To change the character size and position, select the characters inside the border directly.</p> | <p>To cancel the placement, click on the  icon.</p> <p>Reference To change a Part's size, refer to 2.3.3 Scaling Up/Down</p> |
|  | <p>Pressing the <input type="button" value="Ctrl"/> key while re-sizing an area's border will also re-size that area's characters.</p> <p>Double-clicking on any Part placed on the screen automatically calls up that Part's attribute settings.</p> <p>Reference 2.3.15 Changing Attributes</p> |

2.1.15 Message Display

This display is used to show single-line alarm messages in response to changes in External Device's Word Address data. A total of 16 messages can be displayed, in order of occurrence, in a message display area.

■ **Message Display [General Settings] Attributes**

Enter Comment data here

The currently selected Part Shape is displayed here

Calls up the Part Shape Browser; Part Shapes can be selected directly from the Browser

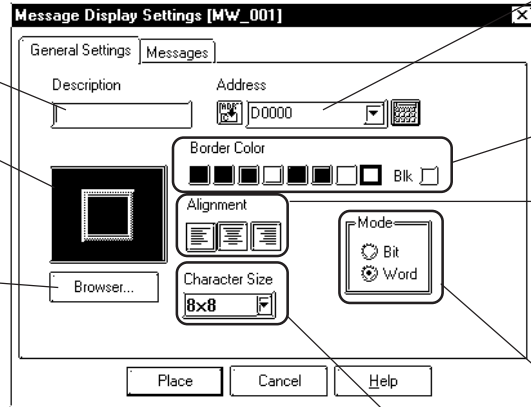

Select the Word or Bit Address to be monitored

Select a Border color

Select the type of alignment desired for the text of the Display

Select the Operation Mode

Select a Character Size

◆ **Address**

Enter an Address to be monitored. Select either Bit Address or Word Address according to (operation) Mode.

◆ **Border Color**

The Message Display's Border color can be selected.

Reference 2.1 Parts ■ *Selecting Colors*

◆ **Alignment**

Here, the text's alignment can be selected.



◆ **Mode**

There are two methods to change messages displayed on the Message Display, i.e. via Bit's turning ON/OFF and Word state changes. Here, select either mode.

Mode: When selecting Bit

Messages will change according to the specified Bit Address changes.

Mode: When selecting Word

Messages will change according to the state changes of the designated bits, consecutively from the specified Address's 00 bit.

According to the number of the messages (either 2, 4, 8, or 16), a bit is automatically assigned from the specified Address's 00 bit.

| Numbers of Messages | Number of Bits Used |
|---------------------|---------------------|
| 2 | 1 |
| 4 | 2 |
| 8 | 3 |
| 16 | 4 |

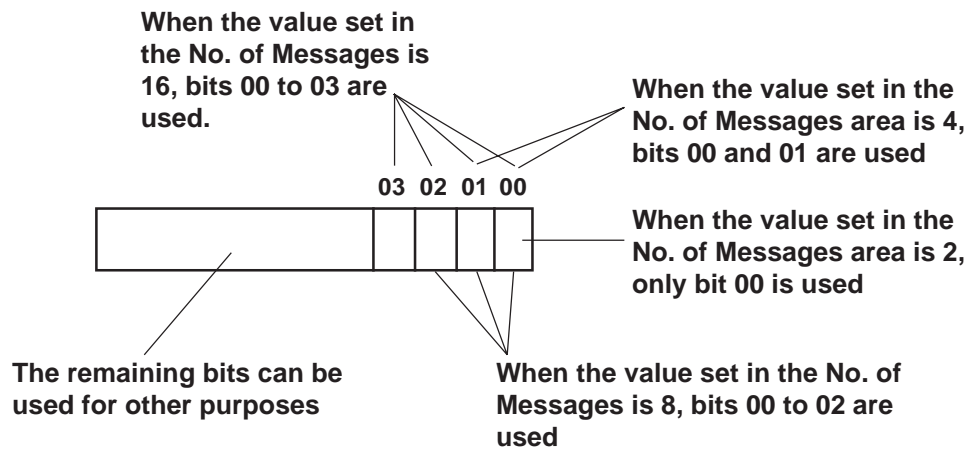

■ Message Display [Messages] Attributes

(Operation Mode example: When using Word Address)

The screenshot shows the 'Message Display Settings [MW_001]' dialog box. It has two tabs: 'General Settings' and 'Messages'. The 'Messages' tab is active. The 'No. of Messages' is set to 4. The 'Display Characters' is set to 10. The 'Message' field contains '0 1 2 3'. The 'Style' section has radio buttons for 'Normal', 'Bold', and 'Raised'. The 'Color' section has 'Text Color' and 'Plate Color' with color selection boxes and 'Blk' checkboxes. Buttons include 'Delete', 'Copy from Description', 'Copy to All', 'Place', 'Cancel', and 'Help'. Annotations point to various elements:

- Enter the message's text here**: Points to the 'Selected Message' field containing 'Operation'.
- Deletes the currently selected message, and specifies the message (and its color) as undefined.**: Points to the 'Delete' button.
- Enter the number of messages (states) here**: Points to the 'No. of Messages' spinner set to 4.
- Enter the maximum No. of Characters**: Points to the 'Display Characters' spinner set to 10.
- The state indication buttons appear according to the No. of Messages**: Points to the 'Message' field containing '0 1 2 3'.
- Select the Character Type**: Points to the 'Style' radio buttons.
- Select the message's (display) Color**: Points to the 'Color' selection area.
- Copies all the characters in the Selected Message field to all states.**: Points to the 'Copy to All' button.
- Copies the characters in the Description field to the Selected Message field.**: Points to the 'Copy from Description' button.

◆ No. of Messages

The number of the messages (number of states) can be selected from 2, 4, 8, and 16.

◆ Display Characters

Here, the maximum number of characters displayed in a message is selected. Up to 40 characters can be input. If the number of a message characters exceeds the specified value, characters that do not fit in the area will be truncated.

◆ Message

According to the No. of Messages, designate a message for each state.

Operation Mode: Bit Off On

Designate a message for each state (ON and OFF).

Operation Mode: Word 0 1 2 3

As many buttons as the number of the specified messages will be displayed. Designate a message for each state.

◆ Selected Message

Messages are entered here. After entering a message, the message will be displayed in the selected color(s). The default value setting is "Undefined".

◆ Color

Here, each message's display colors can be selected.

Default settings are = Char. color - White; Plate (background) color - Blue.

■ **Placing a Message Display**

The Message Display setting procedure is shown below. (When using a Word Address)

| | |
|--|---|
| <p>Message No. 0: None Message No. 1: Signal A Operation Message No. 2: Signal B Operation Message No. 3: Signal A & B Operation</p> <p>A message from those listed above, allocated to the specified Word Address...</p> |  |
| | <p>...displays in response to changes in the Word Address data.</p> |

| PROCEDURE | REMARKS |
|-----------|---------|
|-----------|---------|

(1) Select the [Parts] menu - [Message Display] command, or click on the  icon.

(2) In the [General Settings] tab, input a Word Address. Select the message's Border Color, Text Alignment and Character Size, if desired.

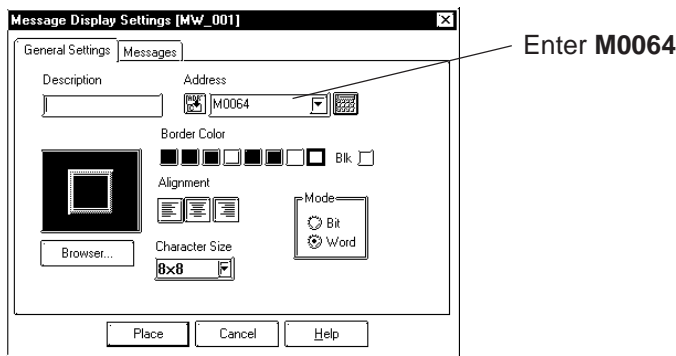

(3) Select a Part Shape from the Browser.

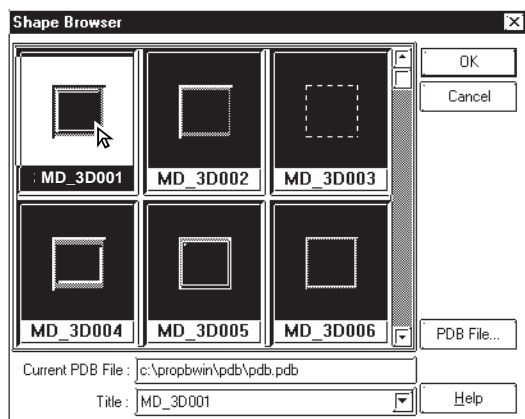

Reference  2.1 Parts ■ *Selecting a Part Shape*

| PROCEDURE | REMARKS |
|-----------|---------|
|-----------|---------|

(4) In the [Messages] area, input the number of the messages and characters used.

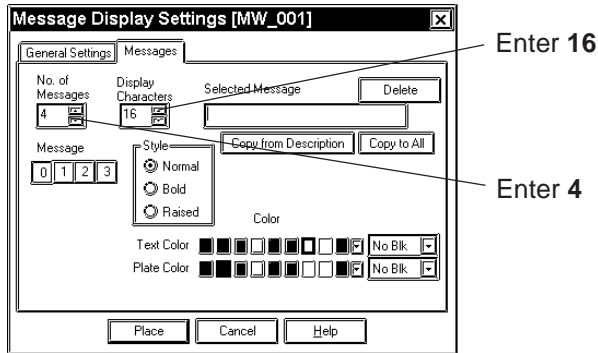

(5) Enter your Alarm Messages.

Select the message number to be registered and enter the message. When displaying a border with no message, be sure to delete the words “Undefined”. Select Colors and Character Size, if necessary.

(Example) When registering the message “A Unit Operating” as message Number 1:

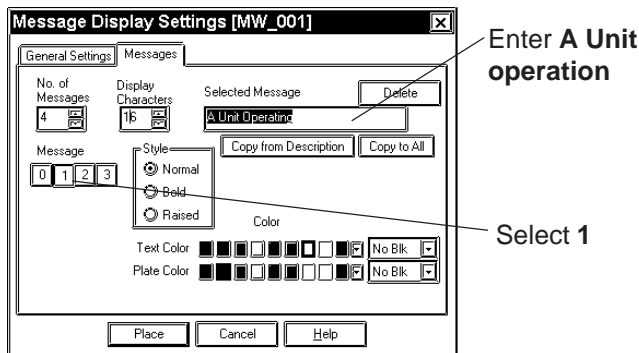

(6) After all of the Part’s attributes have been entered and selected, click on the button.



The Message Display’s outline will appear on the Base screen, next to your cursor.



Important

Any characters entered that are over the limit specified in step (4) will be cut from the LT’s display.

If the text “Undefined” is not deleted, it will be registered and then displayed as a message.

| PROCEDURE | REMARKS |
|--|---|
| <p>(7) Click on the point where the Message Display's top left corner is to be placed on the Base Screen. If necessary, use the Message Display's handles to alter its size after placement. The message, corresponding to the message number designated in the Dialog box, is displayed on the Message Display. Regardless of whether the Message Display is scaled up or down, the character size will not change. To change the character size and position, directly select a character inside the text box.</p>  | <p>To cancel the placement, click on the  icon.</p> <p>To change the Part's size, refer to Reference 2.3.3 Scaling Up/Down</p> <p>When the Message Display is scaled up (larger), the message characters may not be displayed in the correct position. In that case, use the pull down menu [Edit] menu's [Align...] command to adjust the position. Reference 2.3.10 Align</p> <p>Double-clicking on any Part placed on the screen automatically calls up that Part's Attribute Settings dialog box. Also, clicking on the message numbers allows you to view the message's display status. Reference 2.3.15 Changing Attributes</p> |



Note: · Changing the state via the Parts State Change Tool Bar after placing a Part allows you to check each state's Library display condition.

- Every time a part's screen is opened, the Part's state will be reset to 0.
- If a state which has not been defined is designated, the Message Display may show nothing. For example, when the number of messages is 16 and only states 0 to 3 actually have a message registered, designating states 4 to 15 displays only message frames.

2.1.16 Date Displays

Date display data is created using the LT's internal calendar and formatted as: February 11th, 2001, or 01/02/11; however, the date format can be changed.

■ Date Display [General Settings] Attributes

The screenshot shows the 'Date Display Settings [DD_001]' dialog box. It has a 'General Settings' tab. The 'Description' field is empty. The 'Character Size' is set to '8x16' and the 'Date Format' is 'yy/mm/dd'. There are three color selection sections: 'Border Color', 'Text Color', and 'Plate Color', each with a grid of color swatches and a 'Blk' checkbox. A 'Browser...' button is located below the 'Description' field. Callouts point to various elements: 'Enter Comment data here' points to the Description field; 'The currently selected Part's image is displayed here' points to a square placeholder; 'Calls up the Part Shape Browser. Parts can be selected directly from the Browser' points to the Browser button; 'Select the Data Format' points to the Date Format dropdown; and 'Select the Border (frame), Text and Plate (background) colors' points to the color selection sections.

◆ Data Format

The following display formats are available:

yy/mm/dd
 dd/mm/yy
 mm/dd/yy
 20yy/mm/dd*¹
 dd/mm/20yy*¹
 mm/dd/20yy*¹

(yy: year, mm: month, dd: day)

◆ Color

The Date Display's border color, character display color (Text), and interior color (Plate) can be selected here.

▼ **Reference** ▲ 2.1 Parts ■ *Selecting Colors*

◆ Character Size

The label's Character Size is selected here.

▼ **Reference** ▲ 2.2.9 *Text*

*1 The characters used for the display of 2000's first two characters ("20") are single-byte characters.

■ **Placing a Date Display**

The Date Display placement procedure is shown below.

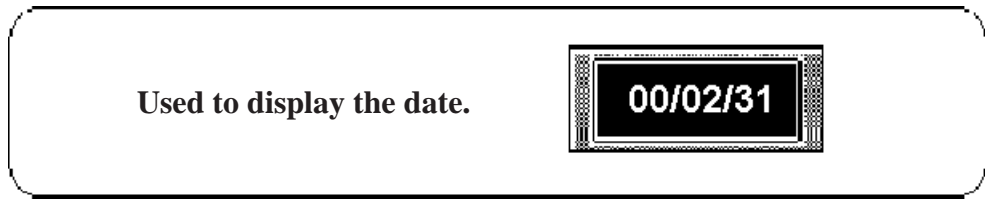

| PROCEDURE | REMARKS |
|-----------|---------|
|-----------|---------|

(1) Select the [Parts] menu - [Date Display] command, or click on the icon.

(2) In the [General Settings] area, select a display format.

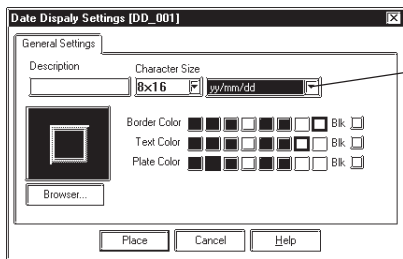

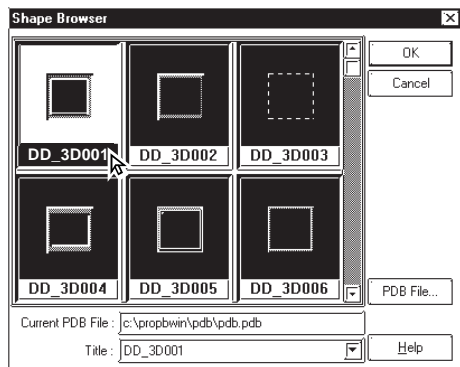

Select the **yy/mm/dd** format

(3) Select a Part Shape from the Browser. If desired, select Colors and Character Size.



Reference 2.1 Parts ■ *Selecting a Part Shape*

(4) After all of the Part's attributes have been entered and selected, click on the [Place] button. The Date Display's outline will appear in the Base screen, next to your cursor.

| PROCEDURE | REMARKS |
|---|---|
| <p>(5) Click on the point where the Date Display's top left corner is to be placed.</p> <p>If desired, use the Date Display's handles to alter its size. Regardless of whether the Date Display is scaled up or down, the character size will not change. To change the character size and position, directly select the characters inside the border.</p>  | <p>To cancel the placement, click on the  icon.</p> <p>To change a Part's size, refer to Reference 2.3.3 <i>Scaling Up/Down</i></p> <p>Double-clicking on any Part placed on the screen automatically calls up that Part's attribute settings. Reference 2.3.15 <i>Changing Attributes</i></p> <p>When scaling up or down the display area, if the  key is pressed at the same time, the characters will scale in unison with the border.</p> |

2.1.17 Time Displays

Time Display areas can be created, based on the LT's internal calendar function. Time will be expressed in 24 hour format.

(E.g.) 2:25 pm > 14:25

Only one Time Display Part can be used per screen.

Time Display [General Settings] Attributes

Enter Comment data here

The currently selected item's image appears here

Calls up the Part Shape Browser. Part Shapes can be selected directly from the Browser

Select the Character Size

Select Border, Character, and Plate colors

Color





Here, the Time Display's Border color, character display color (Text), and background color (Plate) can each be selected.

Reference 2.1 Parts ■ *Selecting Colors*

■ **Placing a Time Display**

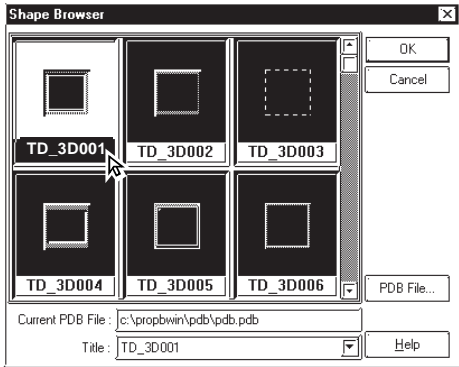
The Time Display is placed using the following procedure.



| PROCEDURE | REMARKS |
|--|---|
| <p>(1) Select the [Parts] menu - [Time Display] command, or click on the  icon.</p> <p>(2) Select a Part Shape from the Browser. If desired, select Colors and Character Size.</p>  <p>(3) After all of the Part's attributes have been entered and selected, click on the  button. The Time Display Part's outline will appear on the Base screen, next to your cursor.</p> <p>(4) Click on the point where the Time Display's top left corner is to be placed. Change the size if necessary. Regardless of whether the Time Display is scaled up or down, the character size will not change. To change the character size and position, select the characters directly.</p>  | <p>Reference 2.1 Parts ■ <i>Selecting a Part Shape</i></p> <p>To cancel the placement, click on the  icon.</p> <p>Reference To change a Part's size, refer to <i>2.3.3 Scaling Up/Down</i></p> <p>When scaling up or down the display area, if the  key is pressed simultaneously, the characters are also scaled up or down together with the border.</p> <p>Double-clicking on any Part placed on the screen automatically calls up that Part's attribute settings.</p> <p>Reference <i>2.3.15 Changing Attributes</i></p> |

2.1.18 Picture Displays

Registered Library items are displayed according to External Device Word Address changes. Parts and Tags, however, cannot be displayed in these displays. Up to 16 different kinds of Library items can be displayed on a single Picture Display.

Reference 2.4 Libraries



With the LT Type C, the Picture Displays will not be displayed on the LT when transferred, if the LT has not been communicating with the external device.

Picture Display [Description] Attributes

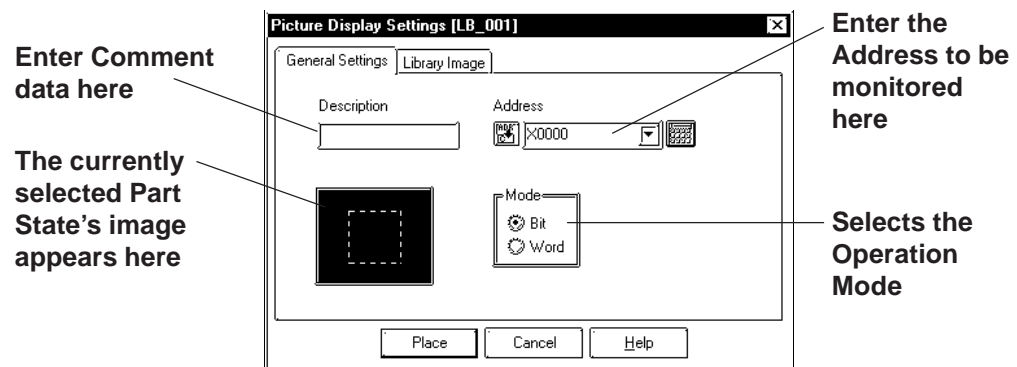

◆ Address

Here, either a Bit or Word Address is entered, after first selecting a Type (either Bit or Word).

◆ Mode

There are two methods used to switch the Library images displayed on the Picture Display; one is Bit access and the other is Word access. Select either of these.

Mode: When selecting Bit

Messages will change according to the specified Bit Address changes.

Mode: When selecting Word

Messages will change according to the state changes of the designated bits, consecutively from the specified Address's 00 bit. According to the number of the messages (either 2, 4, 8, or 16), a bit is automatically assigned from the specified Address's 00 bit.

| Numbers of Messages | Number of Bits Used |
|---------------------|---------------------|
| 2 | 1 |
| 4 | 2 |
| 8 | 3 |
| 16 | 4 |

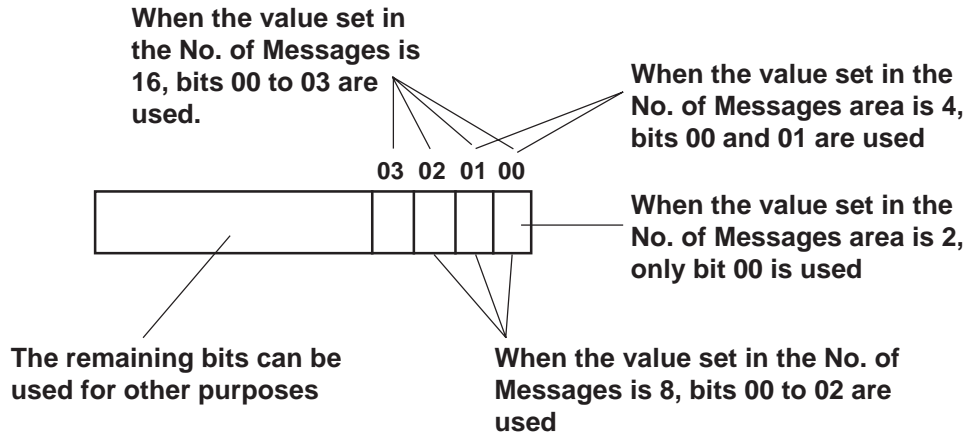

■ **Picture Display [Library Image] Attributes**

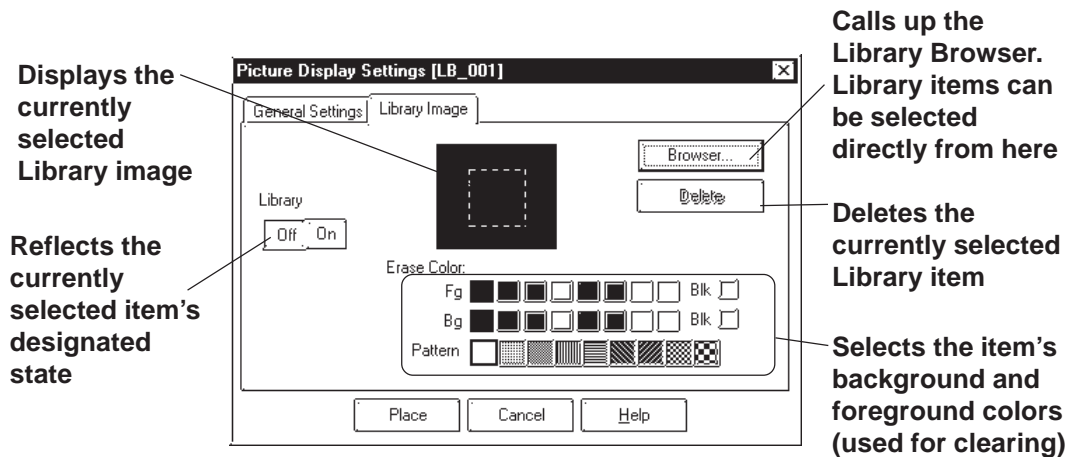

◆ **Browser**

When clicking on the button, the Library Browser (Library list) will appear. Select a desired Library from this list and drag it to the inside of the Library image display border on the Dialog box.

▼ **Reference** 2.4 Libraries

◆ **Delete**

The selected Library item is deleted and the display will disappear.

◆ **No. of Lib.**

Displays only when Type's Word is selected. The number of Library images (number of states) to be displayed on the Picture Display can then be input. Select any of 2, 4, 8, or 16.

◆ **Library**

Here, the Library item used for each state is specified. Settings will differ depending on the Type selection.

Mode: When selecting Bit

Specify a Library item's ON and OFF states, respectively.

Mode: When selecting Word

The number of buttons will match the designated number of Library items. Specify a Library item for each state.



Note: Changing the state via the Parts State Change Tool Bar after placing a Part allows you to check each state's Library display condition.

◆ **Color**

The background square colors (Clear Fg, Clear Bg) and pattern (Pattern) are selected. The default settings are black. The square colors can be selected so as to match the Picture Display placement area background's color.

<Back Ground Square>



The Library item to be displayed while the LT is running needs the filled square for the background to be the rearmost, so that the items(images) do not overlay each other when they are switched. When designating a Library item, the LT Editor program will draw this colored square automatically. Right after the Library item(s) is/are placed, the background square will match the size of the largest Library item designated. After the items are placed, it can be scaled larger or smaller, independently from the Library items. For a state with no designated Library item, only a background square will be displayed and it will become the Library's deletion screen, i.e. it will be overlaid on top of an existing item to "delete" that item.



■ **Placing a Picture Display**

The Picture Display's creation procedure is shown below.

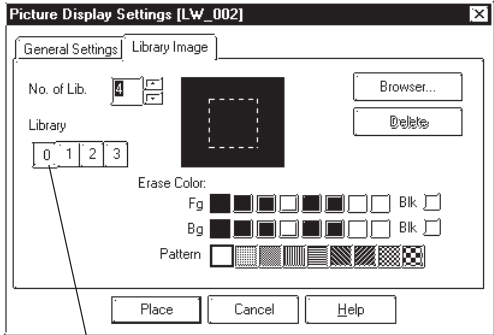
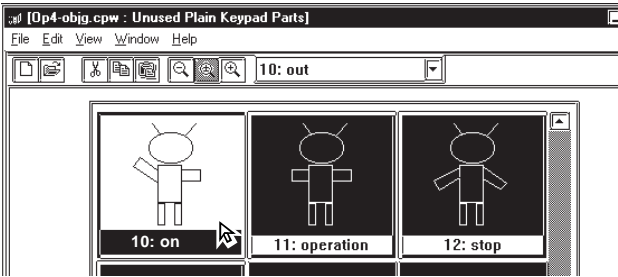
The 3 pictures registered as libraries, as illustrated above, will change in response to changes in the state of Word Address D00250.

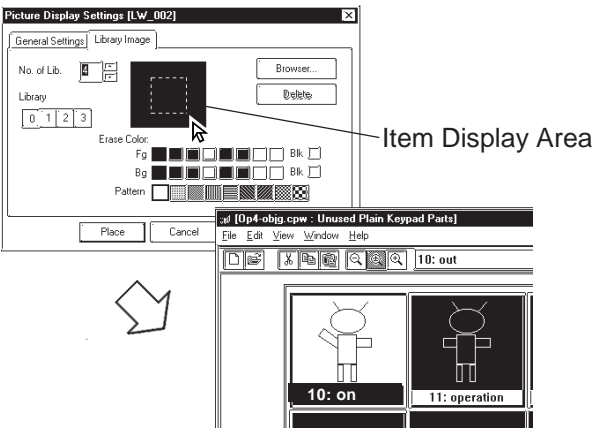
| PROCEDURE | REMARKS |
|--|---------|
| <p>(1) Select the [Parts] menu - [Picture Display] command, or click on the icon.</p> <p>(2) In the [General Settings] area, enter an Address and select a Mode.</p> <p>(3) In the [Library Image] area, input the No. of library items (No. of Lib.) used.</p> | |

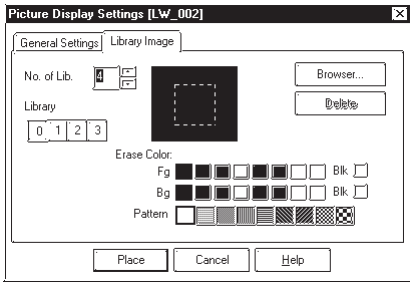
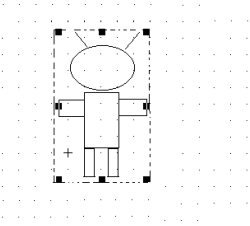
| PROCEDURE | REMARKS |
|---|--|
| <p>(4) Select a state (to register an item as), and then click on the Library... button. Here, perform settings for state 0.</p>  <p>Select 0</p> | |
| <p>(5) Select a Library to be displayed for state 0 from the Browser.</p>  | <p>Reference <i>2.4 Libraries</i></p> <p>To select a Library from a file different from the currently displayed one, click on the Library Browser's  icon.</p> |
| <p>(6) Drag the selected item to the Dialog box's black item display area. Select foreground or background Colors, if desired.</p>  <p>Item Display Area</p> | <p>Reference <i>2.4 Libraries</i></p> |

| PROCEDURE | REMARKS |
|---|--|
| <div style="text-align: center; margin-bottom: 10px;">  </div>  <p>(7) For States 1 and 2, repeat steps (4) to (6). Since State 3 is used to delete Library item from the screen, nothing is specified for it.</p> <p>(8) After all of the item's attributes have been entered and selected, click on the Place button. The Picture Display's outline will appear on the Base screen, next to your cursor.</p> <p>(9) Click on the point where the Picture Display's top left corner is to be placed. Here, the Picture Display's border (dotted line or filled square) and the Library item will appear. At this time, the Library item corresponding to the state currently selected in the Dialog box is displayed on the Picture Display. Regardless of whether the Picture Display's border is scaled up or down, the Library item's size will not change. The border size is common through all the Libraries. The Library item's size and position can be altered by clicking directly on its inside border.</p> <div style="text-align: center; margin-top: 20px;">  </div> | <p>To delete a Library item, click on the Delete button.</p> <p>To cancel the placement, click on the  icon.</p> <p>Double-clicking on any Part placed on the screen automatically calls up that Part's attribute settings. Also, switching the states allows you to view the Library display status.</p> <p>▼Reference▲ 2.3.15 Changing Attributes</p> <p>Changing the state via the Parts State Change Tool Bar after placing a Part allows you to check each state's Library display condition.</p> |



- Note:**
- Every time the screen is opened, the state will be reset to 0.
 - If a state with no Library registered is designated, nothing will be displayed on the Picture Display. For example, when the number of messages is 16 and only states 0 to 3 actually have a message registered, designating states 4 to 15 displays only background square frames.

2.2 Drawing

Straight lines, rectangles, and oval objects can be drawn, using drawing tools.

An object’s attributes such as line types and colors are designated in its dialog box. After designating the object’s attributes, move the cursor and start to draw the object directly in the drawing area.

| Usage Pattern | | | |
|---|----|--------------------------|--|
| [Draw] | → | Select a drawing command | → Set any attributes → Draw the object |
| | or | | |
| Select a desired drawing icon from the Draw Tool Bar. | | | |

■ Drawing Tools

Icons contained in the Draw Tool Bar and their corresponding drawing objects are as follows:

| Icon | Object Types | Icon | Object Types |
|------|------------------|------|----------------|
| | Dot | | Filled Polygon |
| | Line/Poly-line | | Scale |
| | Square/Rectangle | | Text |
| | Circle/Oval | | Load Screen |
| | Arc/Pie | | Load Mark |
| | Fill | | |

■ Selecting Line Types

10 selections are available for straight and poly-lines, and for graph divisions. 6 selections are available for rectangles, circles, arcs and pie sections.

The Polyline dialog box includes a preview window showing a line with a selected pattern. Below the preview is a grid of 10 different line patterns for selection. At the bottom, there are color selection options for foreground (Fg) and background (Bg), each with a 'Blk' checkbox.

Select one of these patterns

■ Selecting Colors

For color and blink attribute settings, use the procedure same as for Parts.

▼ Reference ▲ 2.1 Parts ■ Part Attributes - Selecting Colors

■ **Tiling Patterns**

Nine different tiling patterns are available. These patterns can be selected for squares, circles, filled squares and polygonal objects. When combining foreground (Fg) and background (Bg) colors, a variety of filled patterns can be drawn.

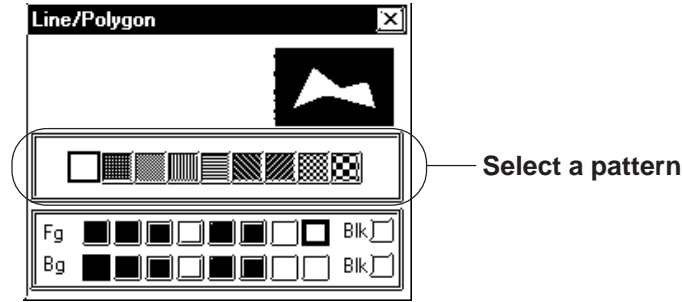

When a square or circle is drawn, only the line type will be displayed initially. To display the pattern selections, check the Fill check box. (check mark will appear)

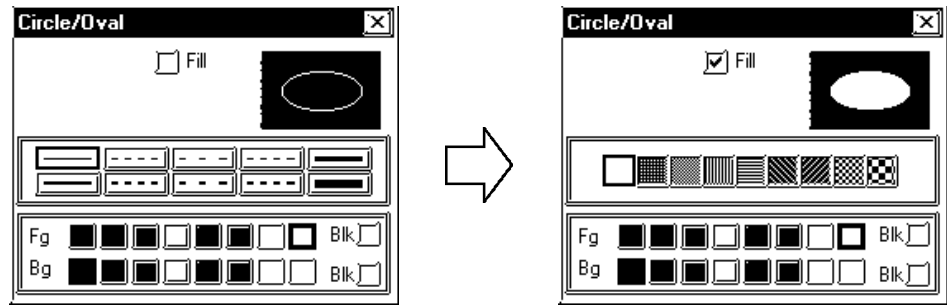



2.2.1 Dot

Dots can be drawn in 1, 2, 3, and 5 dot units. To draw a dot, simply click on the desired point.

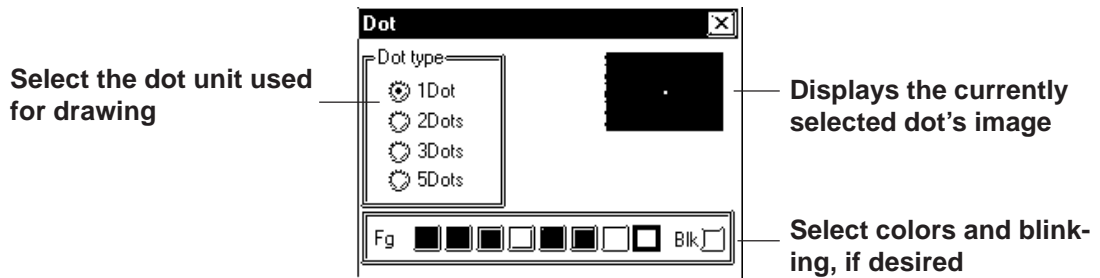
■ **Dot Attributes**

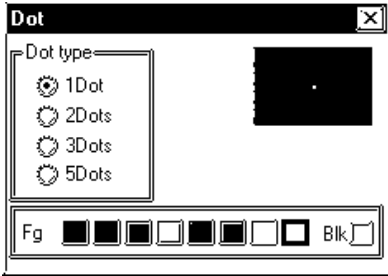
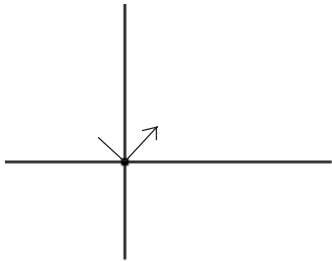

■ Creating a Dot

| PROCEDURE | REMARKS |
|--|--|
| <p>(1) Select the [Draw] menu - [Dot] command, or click on the  icon.</p> <p>(2) Set the attributes of a dot to be drawn. Select a dot type and colors, if desired.</p>  <p>(3) Move the cursor to the drawing area. A dot will be drawn at the point clicked on.</p>  | <p>When using the keyboard to draw a dot, move the cursor to the desired point and press the  key.</p> <p>To cancel/delete the dot, click on the  icon.</p> <p>Double-clicking on any object drawn on the screen automatically calls up that object's Attribute Settings dialog box.</p> <p>Reference 2.3.15 <i>Changing Attributes</i></p> |

2.2.2 Line/Poly-line

In order to draw a line, simply click to designate the line's start and end points. A continuous straight line can also be drawn; holding down the **Ctrl** key allows you to draw lines at precisely 0°, 45°, or 90° angles.

■ Line/Polyline Attributes

When drawing a polyline, check this box 

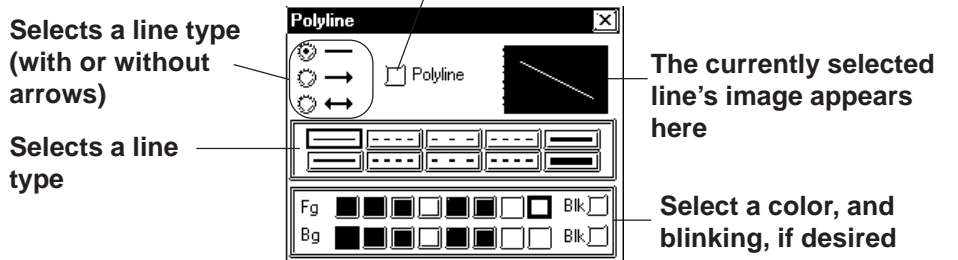



Selects a line type (with or without arrows)

Selects a line type

The currently selected line's image appears here

Select a color, and blinking, if desired

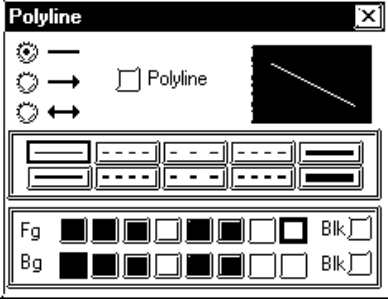
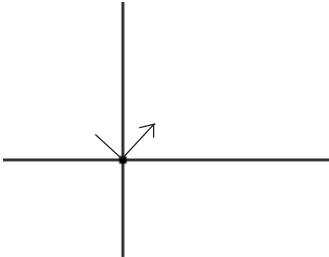
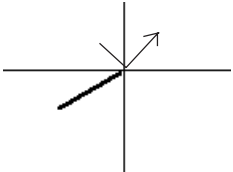
■ Drawing a (Straight) Line

| PROCEDURE | REMARKS |
|---|--|
| <p>(1) Select the [Draw] menu - [Line/Poly-line] command, or click on the  icon.</p> <p>(2) Set the attributes of a straight line to be drawn. If necessary, select the color and line type.</p>  <p>(3) Move the cursor to the drawing area, click on the line's starting point and drag the mouse to the end point.</p>  <p>(4) Click again; a straight line is drawn (registered).</p>  | <p>If an arrow (→) is selected, the line's end point will become an arrow.</p> <p>In step (4), while holding the Ctrl key down, a straight line at an angle of either 0, 45, or 90 degrees can also be drawn.</p> <p>When using the keyboard to draw a straight line, use the arrow keys to move the cursor to the start and end points and press the Enter key, to start and finish the line.</p> <p>To cancel the placement, click on the  icon.</p> <p>Double-clicking on any object drawn on the screen automatically calls up that object's attribute settings.</p> <p>Reference 2.3.15 Changing Attributes</p> |

■ Drawing Polylines

When the Polyline check box is checked, Polylines can be drawn. Click on the starting point then drag the mouse, clicking the left mouse button at each point of the desired directional change of the line; and, click on the right mouse button at the end point of the line.



- Note:**
- When drawing, if the Keyboard's **C** key is pressed instead of clicking on the mouse right button, the start and end points of a polyline object will be automatically connected.
 - You can draw a line that looks hand-drawn by holding down the mouse's left button when drawing a polyline.

2.2.3 Square/Rectangle

To draw a square, click on and designate the diagonal two points.

To draw a regular square, perform this operation while holding down the **[Ctrl]** key. By selecting a pattern before drawing, a filled square also can be drawn. Both normal (non-filled) and filled squares can be beveled.

■ Square Attributes

Check this check box when drawing a filled Square/Rectangle

Selects the type of Square/Rectangle

Selects a line (border) type

Select a Color and blinking, if desired

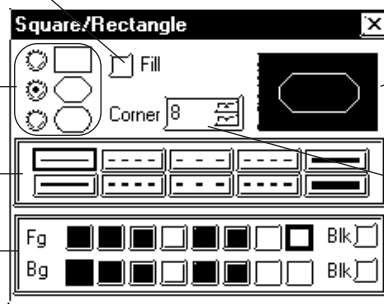

Displays the currently selected Square/Rectangle type

When selecting Corner, this number designates the number of dots used

<Filled Square/Rectangle Setting Screen>

Select one of the tiling patterns

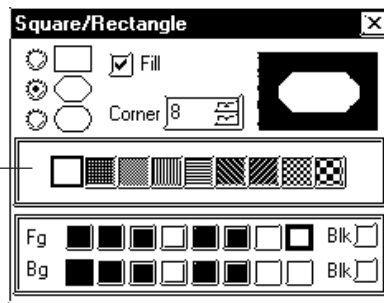

◆ Square Shapes and Beveling types



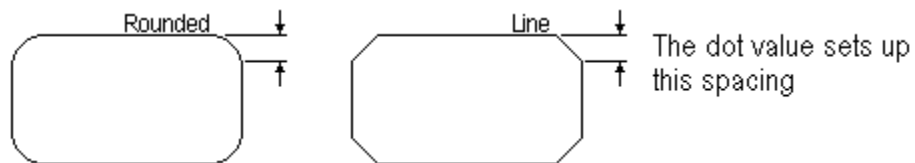

Square shapes and beveling types are as shown below.

- Not beveled.
- All corners are beveled with straight lines.
- All corners are beveled with arcs.

When selecting Beveling, input a bevel dot number.

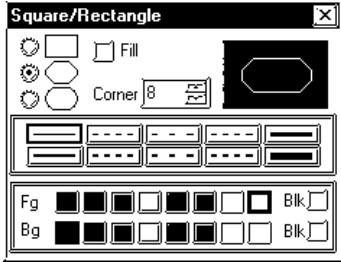
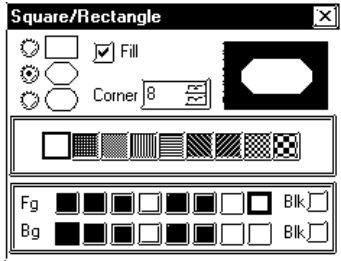
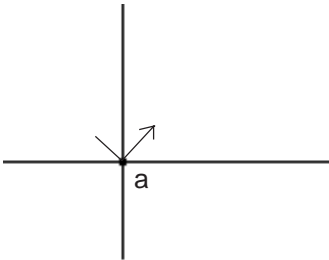
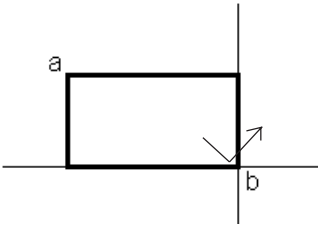

■ Drawing a Square/Rectangle

| PROCEDURE | REMARKS |
|--|--|
| <p>(1) Select the [Draw] menu - [Square/Rectangle] command, or click on the  icon.</p> <p>(2) Set the attributes of the square/rectangle to be drawn. If desired, select the colors, line types, beveling type and dot. When drawing a filled square, check the Fill check box, instead of selecting line types.</p>  <p style="text-align: center;">↓ Select a pattern</p>  <p>(3) Move the cursor to the drawing area and click on the first of the diagonal's points, "a".</p>  <p>(4) Click on the diagonal's other point "b". The rectangle is automatically drawn (registered).</p>  | <p>Reference 2.2.3 ■ <i>Square Attributes; ◆ Square Shapes and Beveling types</i></p> <p>In step (4), hold down the  key to draw a square.</p> <p>When using the keyboard to draw a square, use the arrow keys to move the cursor to the rectangle's two diagonal points and press the  key to start and finish the rectangle.</p> <p>To cancel the placement, click on the  icon.</p> <p>Double-clicking on any object drawn on the screen automatically calls up that object's attribute settings.</p> <p>Reference 2.3.15 <i>Changing Attributes</i></p> |

2.2.4 Circle/Oval

To draw a circle or an oval, click on its center point and drag the mouse to the circumference point, and click again. Holding down the **[Ctrl]** key draws a perfect circle. To draw a filled circle or oval, select the desired pattern.

Circle/Oval Attributes

Check this check box, if a filled Circle/Oval is desired

Select a Line/Border type

Select a Fg and Bg color, and blinking, if desired

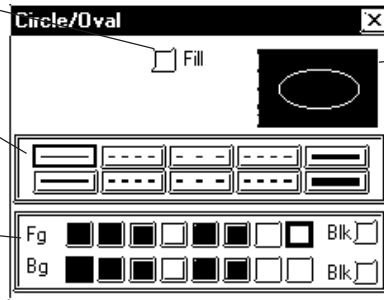

Displays the currently selected Circle/Oval image

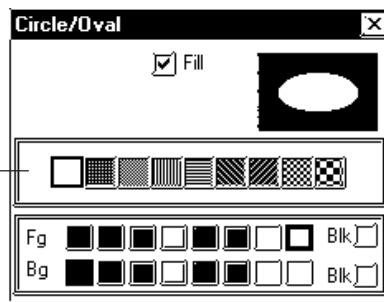

<Filled Circle/Oval Setting Screen>

Select one of the Tiling patterns

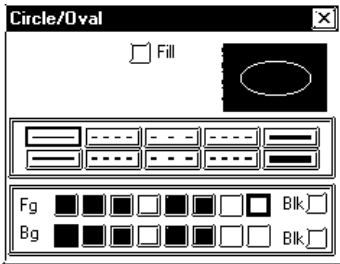

Drawing a Circle/Oval

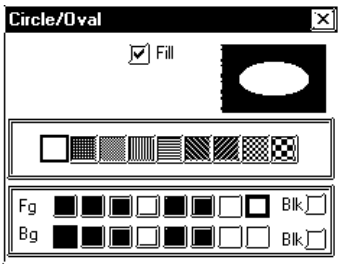
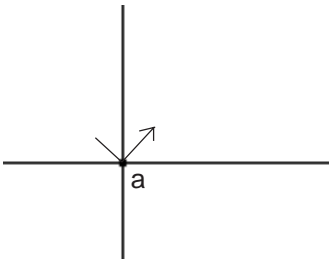
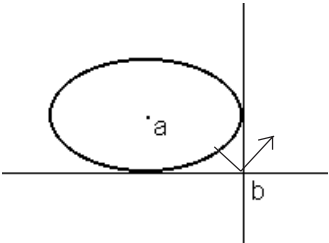
| PROCEDURE | REMARKS |
|--|---------|
| <p>(1) Select the [Draw] menu - [Circle/Oval] command, or click on the  icon.</p> <p>(2) Set attributes of an oval to be drawn. Select colors and a line type, if desired. To draw a filled oval, check the Fill check box and select a pattern, instead of selecting a line type.</p>  <p style="text-align: center;">↓ Select a Pattern</p> | |

| PROCEDURE | REMARKS |
|---|--|
| <p style="text-align: center;">↓</p>  <p>(3) Move the cursor over the drawing area, and click on the center point, shown here by “a”.</p>  <p>(4) As the cursor is moved, the oval will expand or contract. Click on the point shown by b. The drawn oval will be registered.</p>  | <p>In step (3), if the [Shift] key is held down, you can draw an oval which contacts a specified area (i.e. the side(s) of a square). This function is useful when drawing an inscribed circle and can also be used in step (4), together with the [Ctrl] key.</p> <p>To draw a regular circle, hold the [Ctrl] key down in step (4).</p> <p>When using the keyboard to draw an oval, use the arrow keys to move the cursor to the center point and then, to the point which defines its circumference (radius point), pressing the [↵] key each time.</p> <p>To cancel a drawing action, click on the  icon.</p> <p>Double-clicking on any object drawn on the screen automatically calls up that object's attribute settings.</p> <p>Reference 2.3.15 <i>Changing Attributes</i></p> |

2.2.5 Arc/Pie

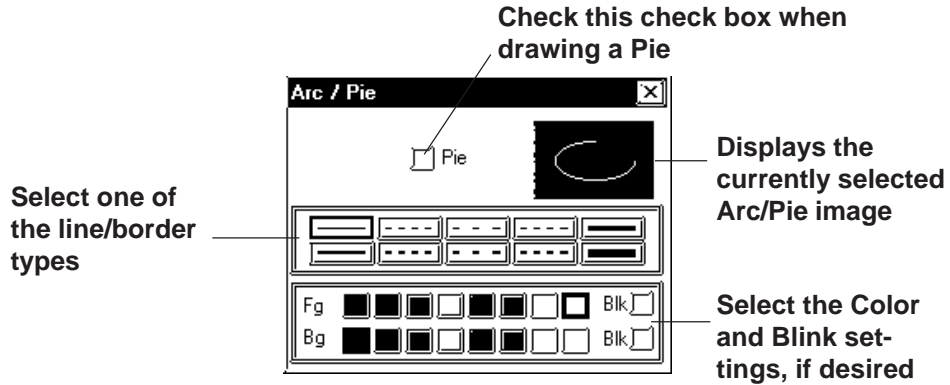

To draw an arc or pie, a portion of a circle must be selected. You will need to first draw a circle, and then, click on the arc's beginning and end points.

■ Arc/Pie Attributes

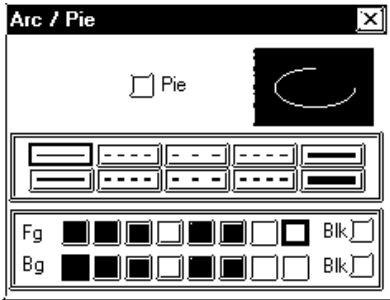
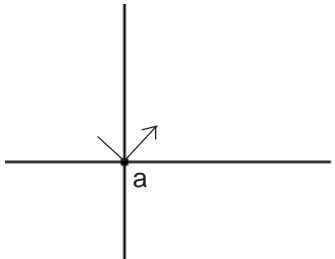

■ Drawing an Arc

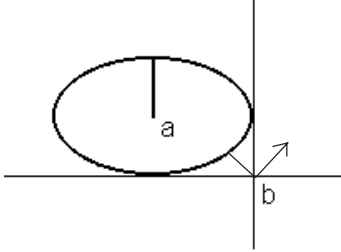
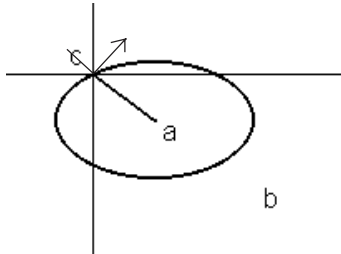
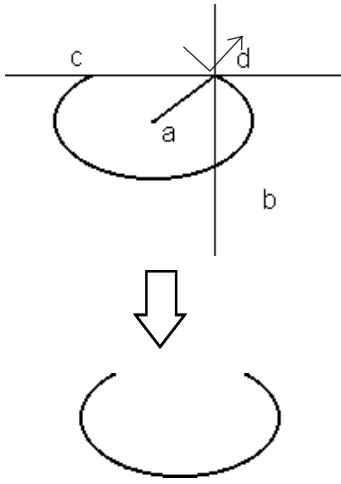
| PROCEDURE | REMARKS |
|--|--|
| <p>(1) Select the [Draw] menu - [Arc/Pie] command, or click on the  icon.</p> <p>(2) Set the Arc's attributes. Select Colors and line type, if desired.</p>  <p>(3) Move the cursor to the drawing area and click on the oval's center point "a".</p>  | <p>In step (3), if the [Shift] key is held down, you can draw an oval which contacts a specified area (i.e. the side(s) of a square). This function is useful when drawing an inscribed circle and can also be used in step (4), together with the [Ctrl] key.</p> |

| PROCEDURE | REMARKS |
|--|---|
| <p>(4) Click on the oval's radius point "b". An oval will appear and the arc's base line will be displayed.</p>  | <p>In step (4), holding down the Ctrl key draws a circular arc.</p> |
| <p>(5) Click on the arc's start point "c" or on its elongation.</p>  | <p>When using the keyboard to draw an arc, use the arrow keys to move the cursor first, to its center point, then, to another point on its circumference (radius point), and then, to its start and end points. Press the Enter key after specifying each of these points.</p> |
| <p>(6) Click on the arc's end point "d". The arc will be drawn (registered).</p>  | <p>To cancel the drawing action, click on the  icon.</p> <p>Double-clicking on any object drawn on the screen automatically calls up that object's attribute settings.</p> <p>Reference 2.3.15 <i>Changing Attributes</i></p> |

■ Drawing a Pie (Sector)

Follow the same steps used for the drawing of Arcs.

When using the same procedure to draw an Arc:

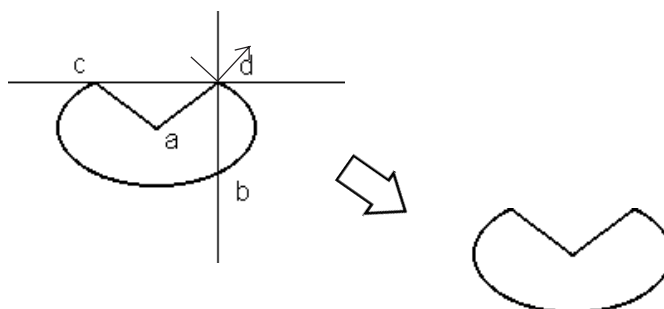

2.2.6 **Fill**

To use the Fill command, simply left-click your cursor on top of an object's enclosed area. The selected Fill pattern will then spread outward until it reaches a boundary. A boundary can be any line or Fill that is the same color as that chosen for the Fill's foreground, background, or border.



<Cautions when Filling an Object>

Be sure that the area to be filled is completely enclosed with solid lines. Dotted lines can not be used as an enclosure.

A space of only one dot on the border of an enclosed area is enough to allow Fill to leak into other areas of the screen. Be especially careful when drawing polygon vertexes and filling an object while the display is set to 50%.

DO NOT attempt to fill objects that have been designated as blinking.

When filling an image that uses an arc, Fill may leak when that image is actually displayed on the LT panel display. To prevent this, use a line to connect any gaps in the image.

■ Fill Attributes

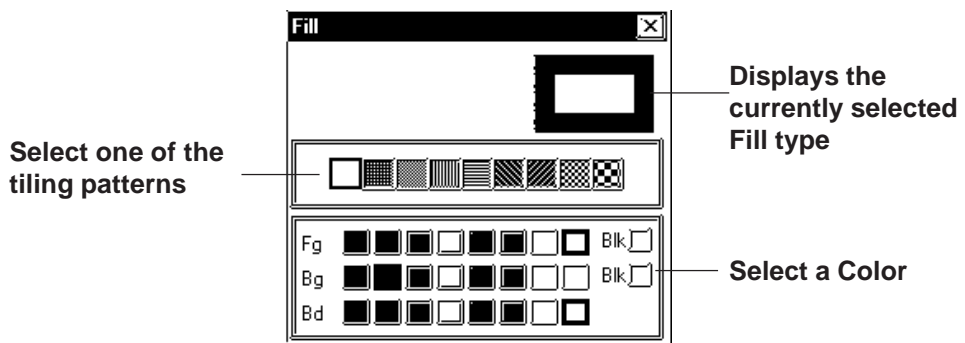





Note: · To select the background color for all the screens used, use the [Option] menu's [Screen Settings] command.

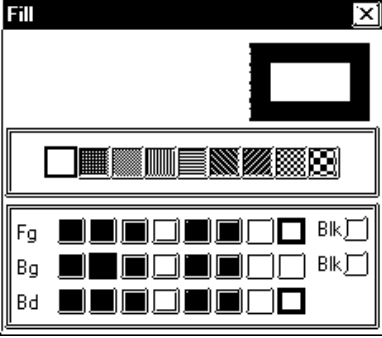
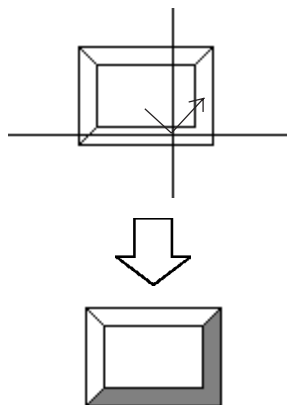
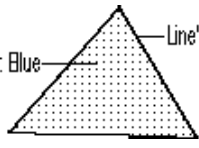

Reference 2.7.2 ■ Settings Screen Property - [Color]

· To cancel the application of a Fill due to a mistake, such as having designated the wrong Fill point, press the **Esc** key.

■ Filling an Object

| PROCEDURE | REMARKS |
|---|---|
| <p>(1) Select the [Draw] menu - [Fill] command, or click on the  icon.</p> <p>(2) Set the attributes. Select Colors and Tiling Patterns, if desired.</p>  <p>(3) Move the cursor to the drawing area and click on the area to be filled. The designated area will be filled in.</p>  | <p>Fill spreads outward from the selected point until it reaches a border with one of the colors (Fg, Bg, Bd) selected in step (2).</p> <p>Select the same color for the Bd (border) Color and boundary Fg (foreground) Color.</p> <p>E.g. </p> <p>Left-clicking on a line will not cause it to be filled. Be sure to only click in an area enclosed by lines.</p> <p>When drawing via the PC's keyboard, press the  button to indicate a fill point. Fills and fill points can be specified to either display or not display via the drawing board.</p> <p>Reference 2.7.2 <i>Screen Environment Settings</i></p> <p>To cancel Fill due to a mistake, such as designating a wrong Fill point, press the  key.</p> <p>To cancel the filling, click on the  icon.</p> <p>Double-clicking on a filling point of any filled object drawn on the screen automatically calls up that filled object's attribute settings.</p> <p>Reference 2.3.15 <i>Changing Attributes</i></p> |

2.2.7 Filled Polygon

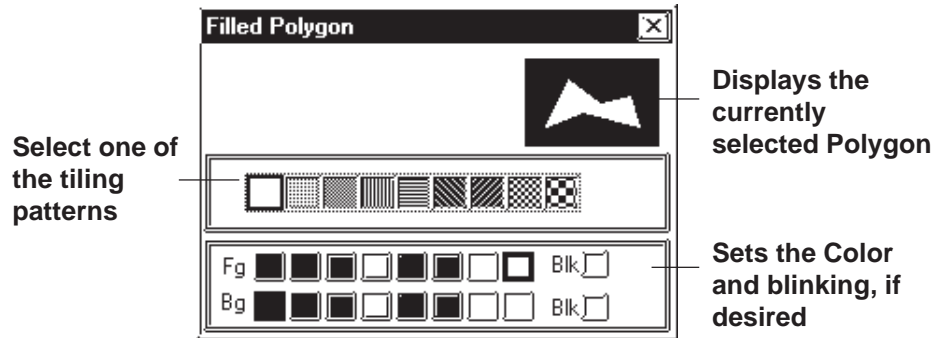

To draw a Polygon, either Left-click or press the  key to indicate the Polygon's vertices. To complete the Polygon, either right-click or press the  to automatically connect the beginning and end points. Holding down the  key while drawing a Polygon will snap the polygon's segments to 45 degree angles.

■ Polygon Attributes

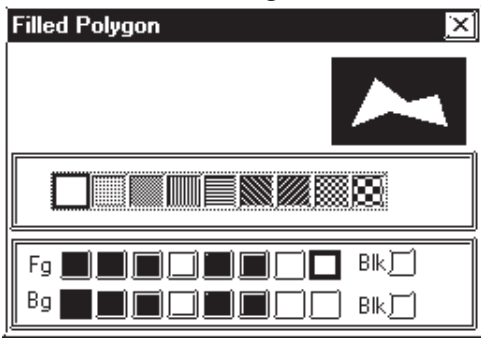
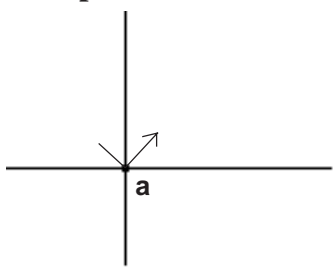

■ Drawing a Polygon

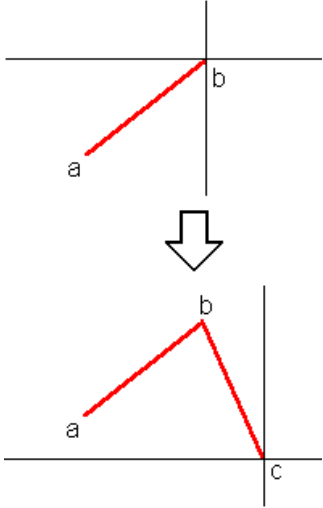
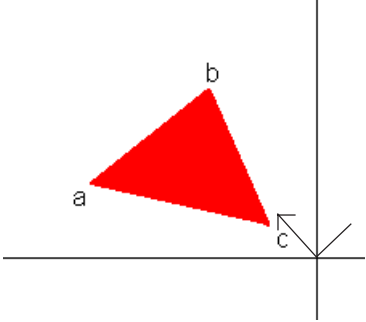
| PROCEDURE | REMARKS |
|--|---------|
| <p>(1) Select the [Draw] menu - [Filled Polygon] command, or click on the  icon.</p> <p>(2) Set attributes of a polygon to be drawn. Select Colors and Tiling Pattern, if desired.</p>  <p>(3) Move the cursor to the drawing area and click on the start point "a".</p>  | |

| PROCEDURE | REMARKS |
|---|---|
| <p>(4) Left-click to designate the positions of the Polygon's vertices. Repeat this for as many vertices as needed. Here, points b and c are also shown.</p>  | <p>Up to 100 corners (faces) can be created.</p> <p>In step (4), holding the Ctrl key causes lines to be drawn at exactly 0, 45, or 90 degree angles.</p> |
| <p>(5) After defining the final vertex, c, right-click or press C to complete and fill the Polygon. Points a and c are joined and the object is filled.</p>  | <p>To cancel the drawing, click on the  icon.</p> <p>Double-clicking on any object drawn on the screen automatically calls up that object's attribute settings.</p> <p>Reference 2.3.15 <i>Changing Attributes</i></p> |



Note: About Filling a Polygon

When a polygon's segments overlap, the filling alternates, so that areas next to each other do not display the same pattern. As a result, areas without any fill (white) may develop inside the polygon. If fill is desired in these areas as well, click on the  icon.

E.g.





2.2.8 Scale

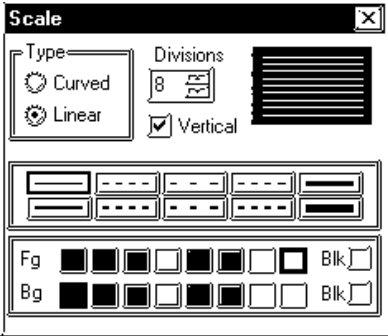

To draw or create a Scale, input the number of divisions desired and then left-click the mouse’s cursor to designate the scale’s beginning and end points. Scales can be either horizontal or vertical, linear (straight line) or curved (semi-circle).

■ **Scale Attributes**

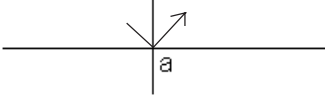
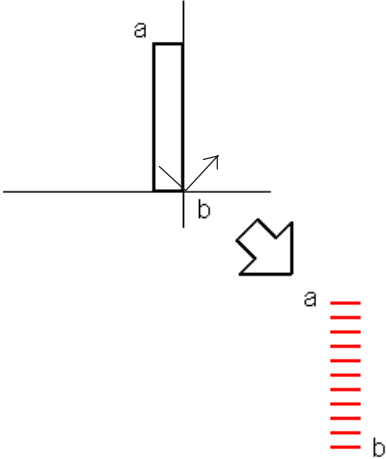
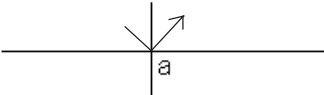
■ **Drawing a Scale**

| PROCEDURE | REMARKS |
|---|--|
| <p>(1) Select the [Draw] menu - [Scale] command, or click on the  icon.</p> <p>(2) Set the attributes of the divisions to be marked. Select the Scale’s colors, line type, and Scale type, and input the number of scale divisions. If “Linear” is selected as the type, select the orientation direction by clicking on the Vertical check box.</p>  | <p><Number of Divisions></p> <p>When the number of the divisions is specified as 8, a total of 9 division lines will be displayed.</p> |

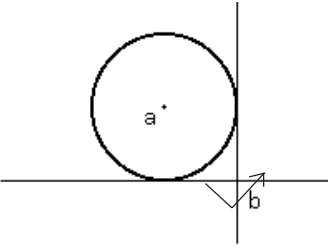
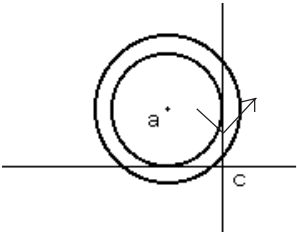
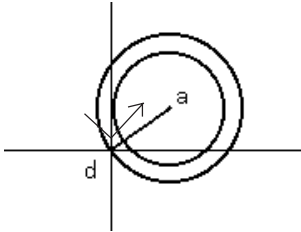
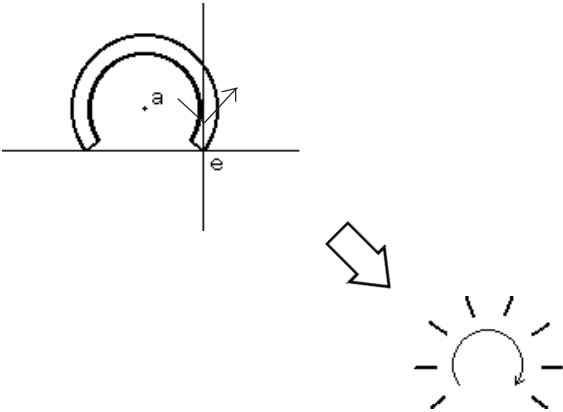
| PROCEDURE | REMARKS |
|---|---|
| <p>The following explanation is divided into two parts; first, when creating a linear type scale, and second, when creating a curved type scale.</p> <p>[Creating a Linear type scale- (Vertical, with 8 divisions)] Specify the area of division lines by a rectangle.</p> <p>(3)Use the mouse's cursor to create a rectangle in the drawing area, i.e. left-click to indicate the linear scale's start point, a.</p>  <p>(4)Complete the rectangle by left-clicking on the Scale's end point, b. The rectangle shape will disappear, and be replaced by division lines.</p>  <p>[Creating a Curved type scale- (8 divisions)] Specify the area of division lines, using double circles.</p> <p>(3)Use the mouse's cursor to create a circle on the drawing area, i.e. left-click to indicate the curved scale's start point, a.</p>  | <p>Holding down the Ctrl key while performing step (4) will draw a perfect square.</p> <p>When using the keyboard to perform drawing, press the Enter key to designate the start and finish points.</p> <p>To cancel the drawing, click on the  icon.</p> |

| PROCEDURE | REMARKS |
|---|---|
| <p>(4) Click on the radius point “b”, which is of a scale’s outer circle.</p>  | |
| <p>(5) Draw another circle inside the circle drawn in step (4) to decide the width of the scale. Click on this inner circle’s radius point “c”.</p>  | |
| <p>(6) Rotate the displayed segment and click on the scale start point “d” or on its elongation.</p>  | |
| <p>(7) Then, rotate the segment again until you reach the desired end point e, and click to designate the end of the scale’s divisions.</p> <p>Division lines appear inside the area surrounded with the double circles and the two segments. They will be drawn clockwise from the start point to the end point.</p>  | <p>When using the keyboard to draw divisions, press the  key after moving the cursor to the division circle’s center point, to the other point on its circumference (radius point), and then to the divisions’ start and end points.</p> <p>To cancel the drawing, click on the  icon.</p> <p>Double-clicking on any object drawn on the screen automatically calls up that object’s attribute settings.</p> <p>Reference 2.3.15 <i>Changing Attributes</i></p> |

2.2.9 Text

Use your PC's keyboard to enter text, and then place in on the screen with your mouse's cursor. This software has two methods of placing text on the screen. The first method defines the placement point, and the second defines the area where the text will be centered.

■ Text Attributes

Enter text here. A maximum of 100 characters can be entered per line, and 100 lines per screen

Selects the text's display direction

Specifies the character width and height



Display a sample of the current text's attributes

Selects the Character Type

Rotates the text in 90 degree increments

Selects the Fg and Bg colors, and blinking

◆ Character Size

Clicking on the font size display area, displays the current character size (used after text is placed on the drawing area). Move the cursor to where the X and Y axis lines cross, and drag the cursor. As the axis lines move, the character size will change. Click on the text block again, or press the  key to register (enter) the change.

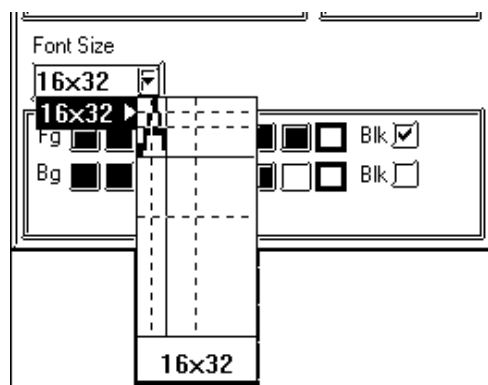

◆ Style

Characters can be either Normal, Bold, or Raised.

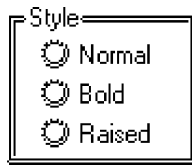

Note: When text character background (Bg) is specified to Black + Blk (Blink), transparent mode is used, thereby displaying that area as transparent. If an object has been drawn underneath these characters, they (the characters) will appear transparent, showing the object behind. This function is useful when overlaying text on objects, i.e., over the face of Switches and Lamps.

▼ **Reference** ▲ 2.2 ■ *Selecting Colors*

■ Changing to a New Text Line and Line Settings

When entering characters, simply press the  key to move to a new line. When there are 2 or more lines of text, icons will appear to allow adjustments in line spacing, and justification.

Controls the Line Spacing. Spacing is performed in dot increments

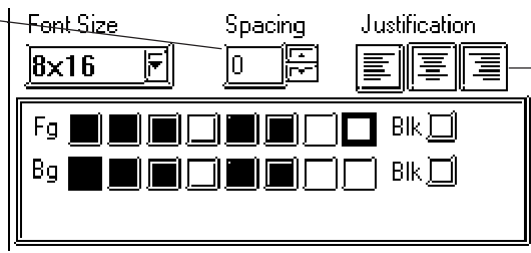



Controls the selected text's justification

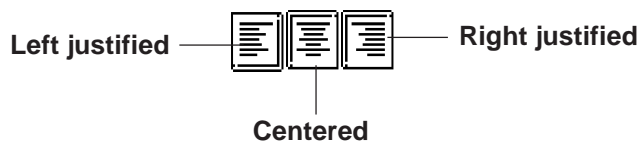

◆ Justification

Horizontal text's alignment can be changed to either Left, Center, or Right justified.

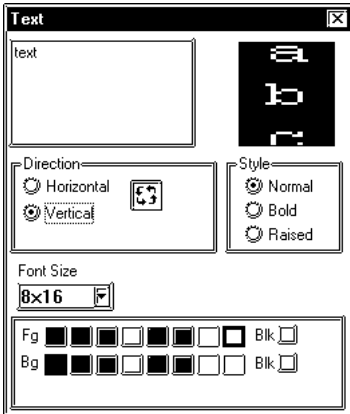
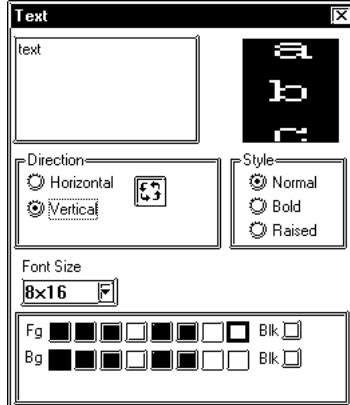
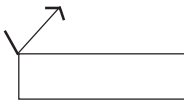

■ Entering Text

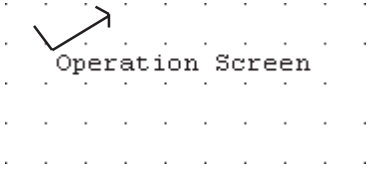
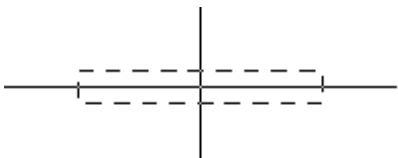
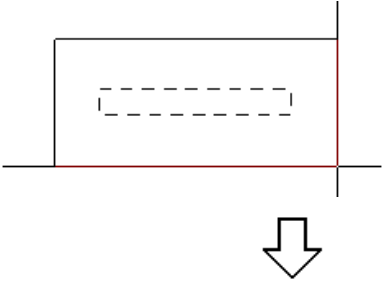
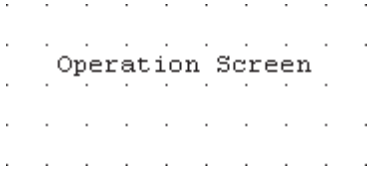
| PROCEDURE | REMARKS |
|--|---|
| <p>(1) Select the [Draw] menu - [Text] command, or click on the  icon.</p> <p>(2) Set the attributes of the characters to be input. Select Colors and Character Size, if desired.</p>  | <p>The attributes can also be entered and selected after entering text.</p> <p>When “Raised” is selected for Character Type, the border color (Bd) will become shadowed (i.e. 3-D).</p> |
| <p>(3) Click on the text field to input characters, via your PC’s keyboard.</p> <p>Simply clicking on the text field allows you to input characters there.</p>  | |
| <p>Hereafter, two text alignment cases will be explained, one not using and one using the Centering function:</p> <p><When Centering function is NOT used></p> <p>(4) Move the cursor to the drawing area and click on any desired point.</p> <p>After clicking on a point in the drawing area, a text box the size of the selected character will appear on the screen. The top left corner of the text box is the base point used for positioning.</p>  | <p>When using your PC’s keyboard to enter text, press the  key to designate a position.</p> |

| PROCEDURE | REMARKS |
|--|---|
| <p>(5) Move the cursor to the desired position and left-click the mouse to place it on the screen.</p>  <p><When the Centering function IS used></p> <p>(4) Move the cursor over the desired placement area and, while holding down the Shift key, click on any desired point.</p> <p>After clicking on a point in the drawing area, the text box will appear on the screen in dotted line.</p>  <p>(5) Select a centering area that is the same size or larger than the previously selected text area.</p> <p>The designated size's text box will appear in the center of the selected area.</p>   | <p>To cancel the placement, click on the  icon.</p> <p>Double-clicking on any object drawn on the screen automatically calls up that object's attribute settings.</p> <p>Reference 2.3.15 <i>Changing Attributes</i></p> <p>To cancel the designated area, click the right mouse button.</p> |

2.2.10 Load Screens

Graphics created on screens in a project can be loaded and used repeatedly on others with LT Editor. Thus, a single screen's contents can be used repeatedly elsewhere. The Load Screen function is also a good way to cut down on your screen's actual size, since you only need to call up items to your screen, not save them on it.

■ Screens that can be loaded to other screens

The screen currently being edited cannot be loaded on to itself.

| Current Screen | Loadable Screens |
|-----------------|------------------|
| B (Base) screen | B (Base) screen |
| | I (Image) screen |



- Note:**
- The screen currently being edited cannot be loaded on to itself.
 - If a portion of an Image screen extends over a Base screen's Y axis border, that portion will not be displayed on the LT screen. When the Image screen is placed over the Base screen laterally, however, any part that extends over the Base screen X axis border will be squeezed onto the LT screen.(i.e. not cut)

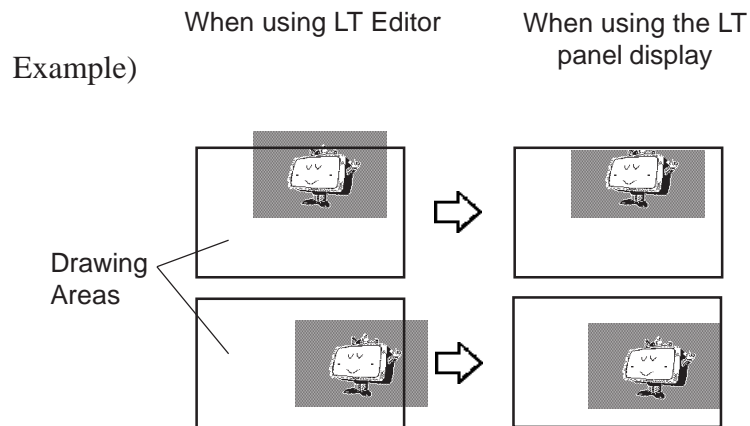

■ Nesting

Screens can be nested up to 10 times (11 layers). However, if your PC’s system memory is low, a loaded screen/object may not be displayed. Later, however, when the data is transferred to the LT, the display will appear normally.

E.g.) Nesting Objects Twice (3 layers)

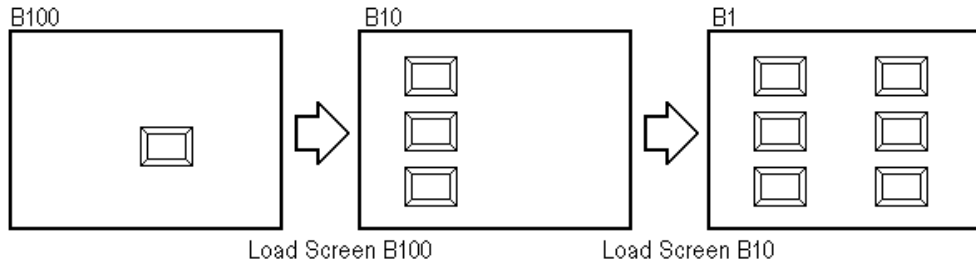



Note: The load screen nesting condition can be viewed via the load screen nesting display function.

Reference 2.7.9 Display at Screen Level Change Structure

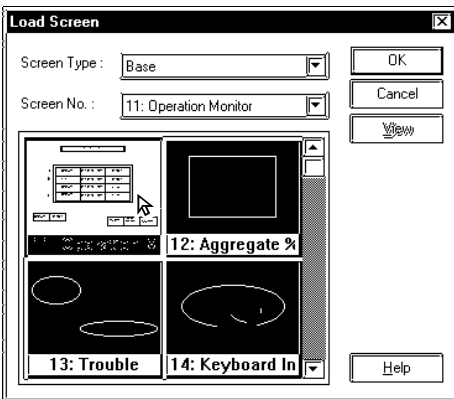
■ Loading a Screen

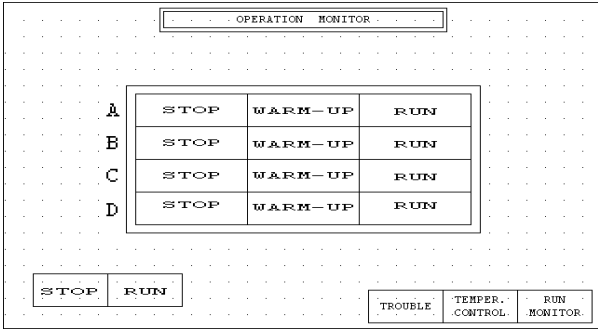
| PROCEDURE | REMARKS |
|--|---|
| <p>(1) Select the [Draw] menu - [Load Screen] command, or click on the  icon.</p> <p>(2) Select a desired screen from the list or enter that screen’s number directly on the [Screen No.] field via the keyboard, and then click on the <input type="button" value="OK"/> button. Then, the screen’s outline and center point will appear in the drawing area, next to your cursor.</p>  | <p>Only screens in the currently used Project file can be loaded. Screens in other project files can not be loaded.</p> <p>The current (selected) Screen cannot be loaded on to itself.</p> |

| PROCEDURE | REMARKS |
|--|---|
| <p>(3)Click on the point where the Screen’s top left corner is to be placed. The image’s center point is left top corner of its border, and for other objects, the screen center mark will be the placement point.</p>  | <p>A loaded screen cannot be edited while it is being used on a different (i.e. loaded) screen. You will need to open the original screen to perform any editing.</p> <p>To cancel the loading, click on the  icon.</p> |



Note: When calling up a filled object:

When the current screen’s graphics overlap loaded filled (painted) graphics, depending on the color used, unfilled areas may be created. To correct this, add a fill to the current screen’s unfilled area.

Reference 2.2.6 Fill

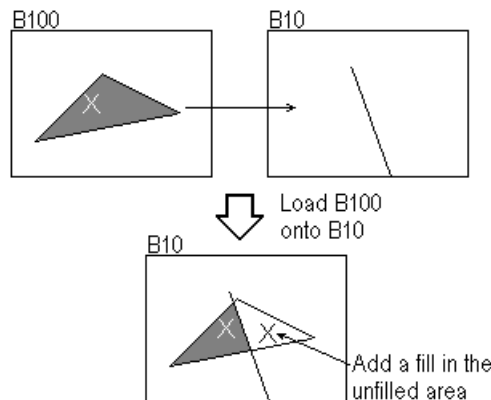



- **If a background color is selected for the screen used for screen call-up, the object placed on the screen will not be displayed on the LT.**
- **To call up the screen for which a background color has been selected, specify the center of the screen as the call-up position and then place the screen.**

2.2.11 Load Mark

Marks (dot images) created in a Mark screen can be loaded and used repeatedly on a Base screen.

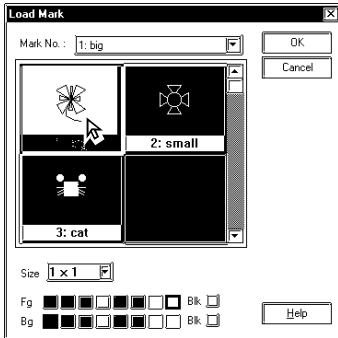
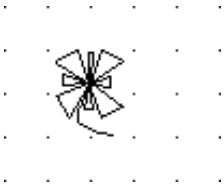
■ Loading a Mark Screen

| PROCEDURE | REMARKS |
|--|--|
| <p>(1) Select the [Draw] menu - [Load Mark] command, or click on the  icon.</p> <p>(2) Select a desired Mark screen from the list or enter that screen's number directly on the [Screen No.] field via the keyboard, and then click on the <input type="button" value="OK"/> button.</p> <p>The Mark's outline will appear in the drawing area, next to your cursor.</p> <p>Designate its color and size before clicking on the [OK] button, if desired.</p>  <p>(3) Click on the point where the Mark's top left corner is to be placed.</p> <p>If desired, use the Mark's handles to alter its size.</p>  | <p>Only Mark screens in the current project can be loaded. Mark screens in other projects are not available.</p> <p>When the screen display size is 50%, the loaded Mark may not be displayed correctly on the LT Editor software.</p> <p>To cancel the loading, click on the  icon.</p> <p>To change the Mark's size, refer to Reference 2.3.3 Scaling Up/Down</p> <p>Double-clicking on any Mark loaded on the screen automatically calls up that Mark's attribute settings.</p> <p>Reference 2.3.15 Changing Attributes</p> |





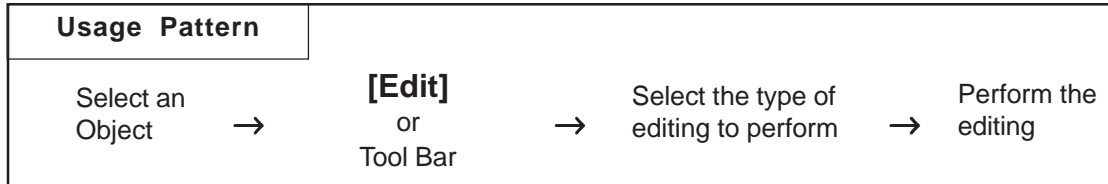











2.3 Object Editing

Parts, objects, and text previously placed or drawn (hereafter called “Objects”), can be edited using various functions, such as Copy and Delete. To edit an object, first, use the cursor to select the object, and then select the type of edit operation.



■ Types of Editing Functions

Icons contained in the Edit Tool Bar and their corresponding edit operation are as follows:

| Icon | Edit Type | Icon | Edit Type |
|---|--------------------|---|----------------------------------|
|  | Undo |  | Mirror X-axis |
|  | Redo |  | Mirror Y-axis |
|  | Cut |  | Group |
|  | Copy |  | Ungroup |
|  | Paste |  | Bring to Front |
| | Command Data Paste |  | Send to Back |
| | Duplicate |  | Change Attribute |
|  | Delete | | Change Coordinates |
|  | Align | | Convert Bitmap |
|  | Rotate Left | | Transferring Screen to Clipboard |
|  | Rotate Right | | Converting Screen to Bitmap File |
| | |  | Redraw Screen |



Note: The tools shown above can also be used from a menu by right-clicking the mouse.

2.3.1 Selecting Objects

Two methods are available for selecting objects: 1) clicking on an object directly, or 2) dragging the mouse to enclose and select single or multiple objects.

Also, you can select individual objects that have other objects either on top of, or overlapping them.

When the tool bar's  icon is clicked on (active), an object can be selected. To activate this icon, click on it directly, or select the pull down [Edit] menu's [Select] command. Also, while drawing objects, right-clicking anywhere on a desired object allows you to select it.

Either a or a mark will be displayed on the sides of the selected object. These square marks are called "handles".

Handle Types

There are two types of handles, those that can be used to scale the object and those that can not.

- : Can be used to scale the object
- : Cannot be used to scale

When an object has been selected, the Selection Tool box will automatically appear. When multiple objects are selected, all the selection Tool box's functions are available.

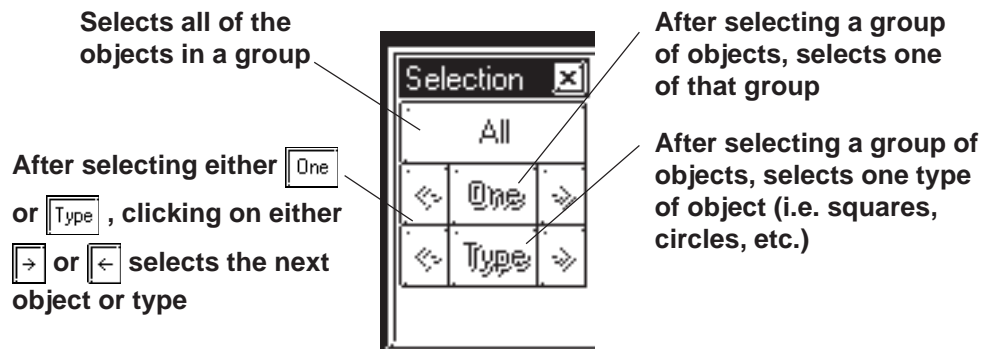

Note: Objects may be selected using the Screen Data List, instead of selecting them on the screen.

Reference 2.7.4 Screen Data List

■ How to Select a Single Object

Here, the procedure for selecting an object is explained.

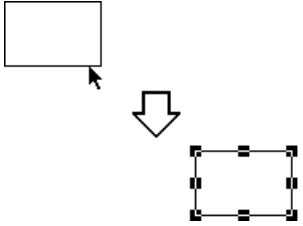
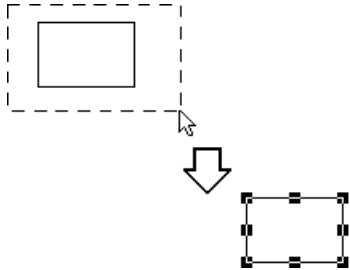
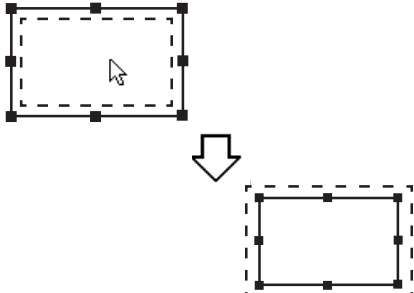



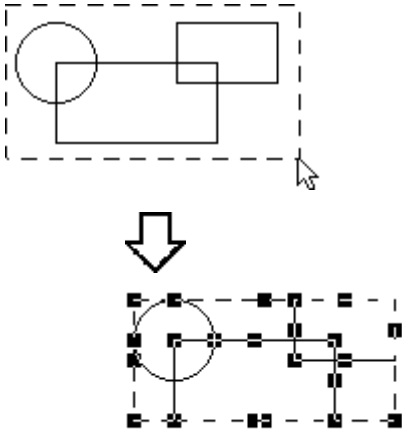
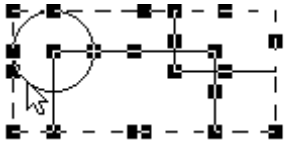

| PROCEDURE | REMARKS |
|--|---|
| <p>[Selecting an Object Directly]</p> <p>(1) Move the cursor over the object, and left-click. Handles display on the object to show that it is selected.</p>  <p>[Selecting an Object by Dragging]</p> <p>(1) Position the cursor near the object and hold the button down, then drag (this is called “Left-dragging”) the mouse over the object. As you do so, a “box” formed by a dotted line will expand to enclose the object. When the entire object is enclosed within the “box”, release the mouse button; handles display on the object to show that it has been selected. You must position the cursor relative to the object so that when you Left-drag over it, the entire object will be enclosed within the “box”; if it is not, then the object will not be selected. This method is most useful when selecting multiple objects, described below.</p>  <p>[Selecting an Object from Overlapped Objects]</p> <p>(1) While holding down the [Ctrl] key, click on an Object to be selected. That Object’s handles will appear to reveal it has been selected.</p>  | <p>When selecting grouped objects, click on any one of the objects in a group to select the group.</p> <p>A Part’s Label can be selected independently from the Part.</p> <p>Click on a Part to display its handles and then on its Label to display the Label’s handles. After selecting the Label, it can be moved or scaled independently from the Part.</p> <p>Numeric Display and text can also be selected using the above-mentioned steps.</p> <p>Left-dragging over only a part of the object will not select it. The entire object must be enclosed to select it.</p> <p>When you wish to select another object without de-selecting the previous one, hold down the [Shift] key while making the next selection. This can also be done continually to select multiple objects.</p> |

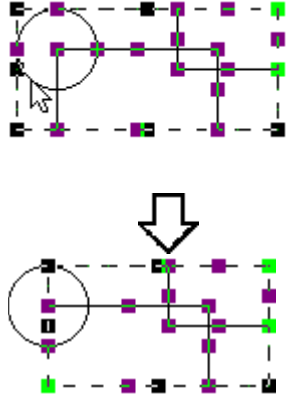
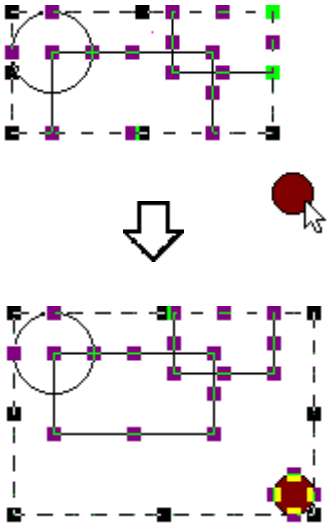
■ **How to Select Multiple Objects**

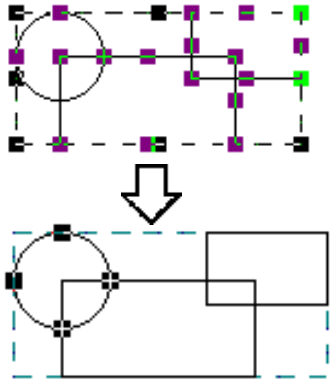
Use this operation to select multiple objects. All the objects in a designated area or on the entire screen can be selected. Also, if necessary, some of these objects can be de-selected.

| PROCEDURE | REMARKS |
|--|---|
| <p>[Selecting Multiple Objects by Dragging]</p> <p>(1) Left-drag over objects as described in Selecting an Object by Dragging (see above). Be sure to enclose all of the objects to be selected completely; if part of an object is not enclosed within the “box”, it will not be included in the multiple selection. Handles will display on the objects that have been selected.</p>  <p>[Selecting All the Objects on a Screen]</p> <p>(1) Select the pull down [Edit] menu’s [Select All Objects] command. All object handles will appear, to show that they have been selected.</p>  | <p>Left-dragging over only a part of an object will not select it. The entire object must be specified to make selection possible.</p> <p>When two or more objects are selected, the [Change Attributes] command cannot be used.</p> <p>The editing commands available depend on what objects have been selected.</p> |

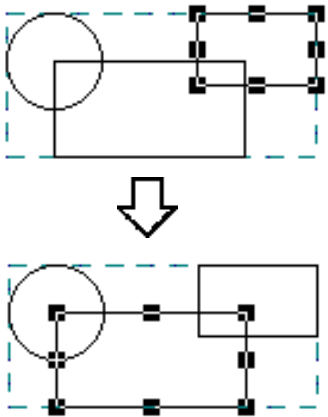
| PROCEDURE | REMARKS |
|--|---------|
| <p>[Excluding Objects From A Multiple Selection]</p> <p>(2)When multiple objects are selected, to de-select an object while preserving the selection of the other objects, first move the cursor over the object; then, while holding down the Shift key, left-click on the object. When the object's handles disappear, that object is no longer selected. Repeat this process as many times as desired.</p>  <p>[Adding Objects To A Multiple Selection]</p> <p>(2)When multiple objects are selected, to add an object, either left-click on the object or Left-drag over it, while holding down the Shift key. The imaginary “box” that encloses the multiple selection (represented by its own handles) will expand to include the added object, which now has handles. Using this process, you can add as many objects to the multiple selection as you want.</p>  | |



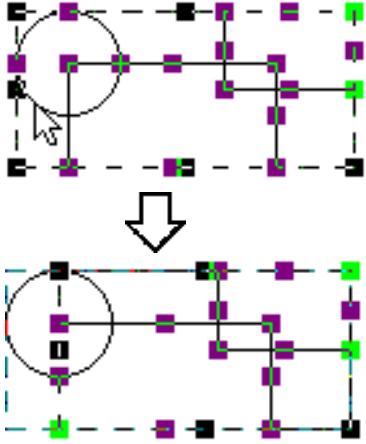
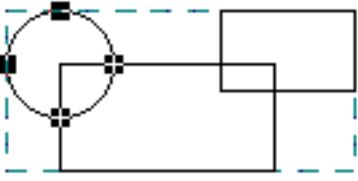



| PROCEDURE | REMARKS |
|---|--|
| <p>[Selecting One Object in a Multiple Selection]</p> <p>(2) First, make a multiple selection; then, click on the Selection Tool box's  icon. All the objects in the multiple selection will become de-selected, except for one.</p>  <p>(3) Use the  and  icons to “scroll” through all the objects originally in the multiple selection; clicking on these arrow keys will change the selected item, one at a time. Clicking on the  icon will select the next object, and clicking on the  icon will select the previous object, in the order that they were drawn.</p>  | <p>If you wish to re-select all the objects originally in the multiple selection, click on the Selection Tool box's  button.</p> <p>To select an Object from overlapped Objects.</p> <p>▼Reference▲ <i>How to Select a Single Object</i></p> |

| PROCEDURE | REMARKS |
|--|--|
| <p>[Selecting Objects by Type from a Multiple Selection]</p> <p>(2) First, make a multiple selection; then, click on the Selection Tool box's <input type="button" value="Type"/> icon.</p> <p>Selection handles will appear for only one type of object (here, only square objects are selected), while an outline remains around them all. This will effectively de-select any objects that are not the currently selected type.</p>  <p>(3) Use the <input type="button" value="←"/> and <input type="button" value="→"/> icons to select a different object type.</p> <p>As you press either arrow key, the selected object type will change.</p>  | <p>Objects are classified as follows: Parts: by each type, Objects: by each type, Loaded Screens and Marks: All as one type, respectively.</p> <p>To re-select all the objects originally in the multiple selection, click on the Selection Tool box's <input type="button" value="All"/> button.</p> |

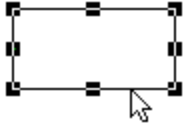
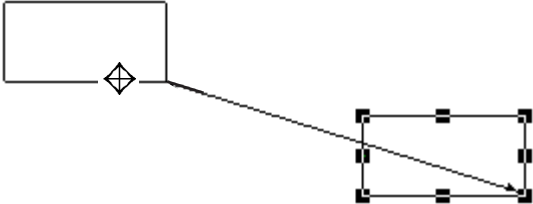
2.3.2 Moving Objects

In this section, the procedures for moving objects are described.

■ How to Move an Object

| PROCEDURE | REMARKS |
|--|---|
| <p>(1) Click on the desired object. The object's handles will appear, showing that it has been selected.</p>  <p>(2) Place the cursor over the object, away from the handles, and after the cursor changes to a four-pointed diamond, drag it to the desired location.</p>  | <p>Reference 2.3.1 <i>Selecting Objects</i></p> <p>The keyboard's , , , and  keys can also be used when the object's handles are displayed.</p> <p>If an object is too small to select and move (i.e. it is only scaled up or down), click on and drag the object while holding down the Alt key.</p> <p>Also, you can move the object by zooming out the screen or using the keyboard.</p> <p>Reference 1.5.2 <i>Display Area (50%, 100%, 200%)</i></p> <p>To cancel the movement, click on the  icon.</p> |





- Note:**
- To move an object horizontally or vertically, do so while holding the **Shift** key down. In this case, the object will be moved in either the horizontal or vertical direction where the moving distance is greater.
 - To move and scale up/down an object, designating its coordinates can be used.

Reference 2.3.16 *Changing Coordinates*

2.3.3 Scaling Up/Down

Scaling means changing the size and proportion of an object. This function allows you to easily scale an object up (larger) or down (smaller). Be sure the object's handles are displayed as (■).

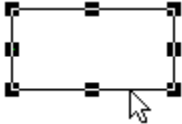
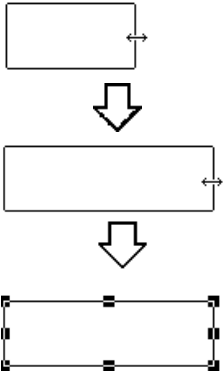
■ Scaling An Object

| PROCEDURE | REMARKS |
|--|--|
| <p>(1) Click on the object to select it. The object's handles will appear to show that it is selected.</p>  <p>(2) Place the cursor on an object's handle, and after the double arrow cursor appears, drag the handle to re-size the object.</p>  | <p>Reference 2.3.1 <i>Selecting Objects</i></p> <p>Re-sizing will depend on which handle is dragged:</p> <p>Ex. To scale a square up or down: Corner Handles = proportionally Top/Bottom handles = vertically Right/Left handles = horizontally</p> <p>Place the cursor on one of the handles of the object.</p> <p>When the cursor becomes ↔, use the keyboard's either ↑, →, ← or ↓ key to scale the object up or down in the unit of dot.</p> <p>To cancel the re-sizing, click on the  icon.</p> |









- Note:**
- When re-sizing an object while holding down the **Ctrl** key, lines will snap to 45 degree intervals, Rectangular and Scale (Linear) objects will become square-shaped objects, and ovals will become circles. Also, if the **Shift** key is held down, all selected Lines, Rectangles, Ovals, Scales, Text and loaded Marks will scale up or down proportionately. When scaling a Part with a Label, holding down the **Ctrl** key causes the Label to scale up or down together with the Part.
 - When selecting an oblique line, 8 handles will be displayed. Click on the line again and 8 handles will change to 2 handles, one at either end. Clicking and then dragging on one end's handle "fixes" the opposite end in place, and "releases" the dragged end, and allowing the line to pivot freely.
 - Multiple parts may be selected and then scaled up/down. However, the following parts are not scaled up/down, but their positions are moved: Half-pie Graphs, Pie Graphs, Meters, Trend Graphs, Alarms, Keypads, and Picture Displays.
 - To move and scale up/down an object, designating its coordinates can be used.

Reference 2.3.16 *Changing Coordinates*

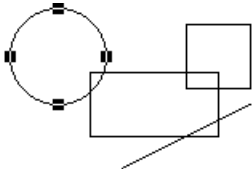
2.3.4 **Cut**

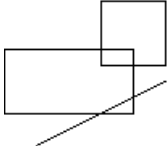
Here, the procedure for “cutting” an object (deleting it) and placing it on another screen, is explained. (When an object is “cut”, it is stored in the Clipboard*1.)

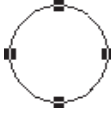
■ Cutting (Moving) an Object





| PROCEDURE | REMARKS |
|--|---|
| <p>(1) Select an object.</p>  <p>(2) Select the [Edit] menu - [Cut] command, or click on the  icon. Then, the selected object will be cut.</p>  <p>(3) Open the object’s destination screen, and select the [Edit] menu - [Paste] command, or click on the  icon. Then, the outline of the object cut from the previous screen will appear.</p> <p>(4) Position the cursor and click on the point where the object is to be placed. The object that had been Cut from the previous screen will be “pasted” at the new location.</p>  | <p>▼Reference▲ 2.3.1 Selecting Objects</p> <p>To cancel the Cutting, click on the  icon.</p> <p>To cancel the pasting, click on the  icon.</p> |

*1 An area where text, graphics, or both, that have been Cut or Copied, are temporarily stored. The contents of the Clipboard can be “pasted” (copied from the Clipboard) using the Paste function. However, once the Copy/Cut command is executed, the data stored in the Clipboard is replaced; therefore, only the data from the most recent Copy/Cut command can be Pasted.

2.3.5 Copy

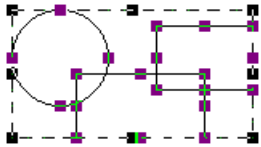
Here, the procedure for “copying” an object (without deleting it) and placing it elsewhere, is explained. (When an object is “copied”, it is stored in the Clipboard*1.)

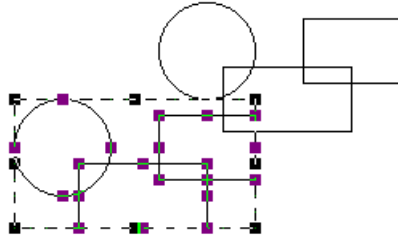
■ Copying an Object





| PROCEDURE | REMARKS |
|--|---|
| <p>(1) Select the desired object(s).</p>  <p>(2) Select the [Edit] menu - [Copy] command, or click on the  icon. The selected object(s) will be Copied to the Clipboard.</p> <p>(3) Select the [Edit] menu - [Paste] command, or click on the  icon. Then, the outline of the object copied from the previous screen to the Clipboard will appear.</p> <p>(4) Position the cursor and click on the point where the object is to be placed. The object stored in the Clipboard will be Copied to the specified location.</p>  | <p>Reference 2.3.1 <i>Selecting Objects</i></p> <p>To cancel the Copying, click on the  icon.</p> <p>When “pasting” the Copied object on another screen, be sure to open that screen first.</p> <p>Selecting and dragging an object to another screen while holding down the [Esc] key can also be used to copy the object.</p> <p>To cancel the pasting, click on the  icon.</p> |

*1 An area where text, graphics, or both, that have been Cut or Copied, are temporarily stored. The contents of the Clipboard can be “pasted” (copied from the Clipboard) using the Paste function. However, once the Copy/Cut command is executed, the data stored in the Clipboard is replaced; therefore, only the data from the most recent Copy/Cut command can be Pasted.

2.3.6 Paste

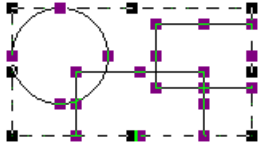
Here, the procedure for “pasting” an object, that has been Copied (or Cut) to the Clipboard*¹, is explained.

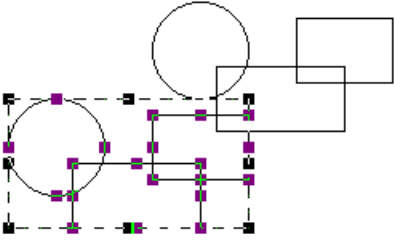
■ Pasting an Object

| PROCEDURE | REMARKS |
|---|--|
| <p>(1)First, Copy (or Cut) an object.</p>  <p>(2)Select the [Edit] menu - [Paste] command, or click on the  icon.</p> <p>Then, the outline of the object copied from the previous screen to the Clipboard will appear.</p> <p>(3)Position the cursor and click on the point where the object is to be Pasted.</p> <p>The object stored in the Clipboard will be Pasted to the new location.</p>  | <p>Reference 2.3.5 Copy</p> <p>To cancel the paste, click on the  icon.</p> <p>When an object is copied from another screen, it will be automatically placed at the same coordinates as its original ones. To place the object at different coordinates, move it after this automatic placement.</p> |

*1 An area where text, graphics, or both, that have been Cut or Copied, are temporarily stored. The contents of the Clipboard can be “pasted” (copied from the Clipboard) using the Paste function. However, once the Copy/Cut command is executed, the data stored in the Clipboard is replaced; therefore, only the data from the most recent Copy/Cut command can be Pasted.

2.3.7 Pasting Instruction Data

By copying and pasting to the Screen Editor a logic program instruction created with the Logic Program Editor, you can place a Part corresponding with the instruction.

In the same way, copying and pasting to a logic program a Part placed on the screen inserts an instruction corresponding with the Part.

■ Conversion between Instructions and Parts

Each instruction and part has counterparts that have been already determined.

◆ Conversion from Instructions to Parts

Below is the list of Parts to which each instruction is to be converted.

| Instruction | Parts |
|-------------------------|--|
| NO (a Contact) | Bit/Toggle Switch |
| NC (b Contact) | Bit/Toggle Switch |
| PT (Start Up Contact) | Bit/Toggle Switch |
| NT (Start Down Contact) | Bit/Toggle Switch |
| OUT/M (Out Coil) | Lamp |
| NEG/NM (Reverse Coil) | Lamp |
| SET/SM (Set Coil) | Lamp |
| RST/RM (Reset Coil) | Lamp |
| CTU (Up Counter) | Numeric Display/Graph/Keypad Input Display |
| CTD (Down Counter) | Numeric Display/Graph/Keypad Input Display |
| CTUD (Updown Counter) | Numeric Display/Graph/Keypad Input Display |
| TON (On Delay Timer) | Keypad Input Display |
| TOF (Off Delay Timer) | Keypad Input Display |
| TP (Pulse Timer) | Keypad Input Display |

◆ Conversion from Parts to Instructions

Below is the list of Instructions to which each Part is to be converted.



| Parts | Instruction |
|--|---|
| Bit/Toggle Switch | NO (a Contact), NC (b Contact), PT (Start Up Contact), NT (Start Down Contact) |
| Lamp | NO (a Contact), NC (b Contact), PT (Start Up Contact), NT (Start Down Contact), OUT/M (Out Coil), NEG/NM (Reverse Coil), SET/SM (Set Coil), RST/RM (Reset Coil) |
| Numeric Display/Graph/Keypad Input Display | CTU (Up Counter), CTD (Down Counter), CTUD (Updown Counter) |
| Keypad Input Display | TON (On Delay Timer), TOF (Off Delay Timer), TP (Pulse Timer) |



■ Pasting a Logic Program Instruction to the Screen

Here, the procedure for "copying and pasting" a logic program instruction to the screen is explained. When pasting the instruction, the type of Part to be converted to needs to be selected from the list.

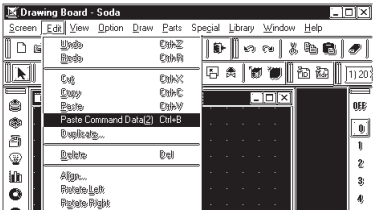

- **Before copying an instruction, you have to allocate a variable to the instruction. Instructions without a variable allocated cannot be copied to the screen.**
- **Before pasting an instruction, be sure to save the logic program.**

| PROCEDURE | REMARKS |
|--|---|
| <p>(1) Select the desired instruction on the Logic Program Editor.</p> | <p>Reference 1.2.3 Creating/Editing/Saving a Logic Program</p> |
| <p>(2) Select the Logic Program Editor [Edit] menu - [Copy] command, or click on the  icon.</p> <p>The selected instruction will be copied to the Clipboard.</p> | <p>To cancel the Copying, click on the  icon.</p> |

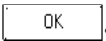
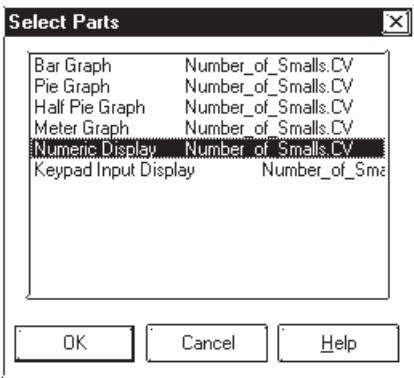
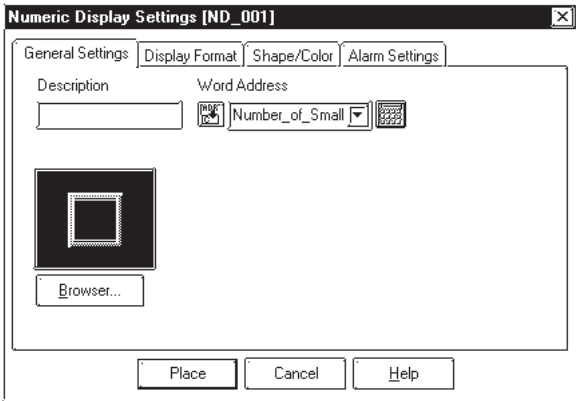
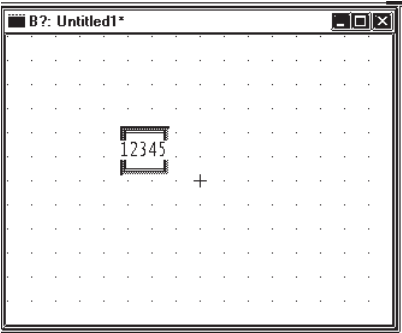
| PROCEDURE | REMARKS |
|---|--|
| <p>(3) Select the Screen Editor [Edit] menu - [Paste Command Data(2)] command, or click on the  icon.</p>  | <p>To cancel the Pasting, click on the  icon.</p> |
| <p>(4) Select the Part to convert, and determine by clicking .</p>  | <p>A list of the Parts to which the copied instruction can be converted will appear. If there is only one Part that corresponds to the instruction, the step 4 is omitted.</p> |
| <p>(5) Change the size and attributes of the Part as necessary and place it on the screen.</p>  <p style="text-align: center;">↓</p>  | <p>Reference 2.1 Parts</p> |

■ Pasting a Part placed to the screen to a Logic Program



Here, the procedure for "copying and pasting" a part placed to the screen to a logic program is explained. When pasting the Part, the type of instruction to be converted to must be selected from the list.





Before copying a Part, you have to allocate a variable (Logic symbol) to the Part. Parts without a variable allocated cannot be copied to a logic program.

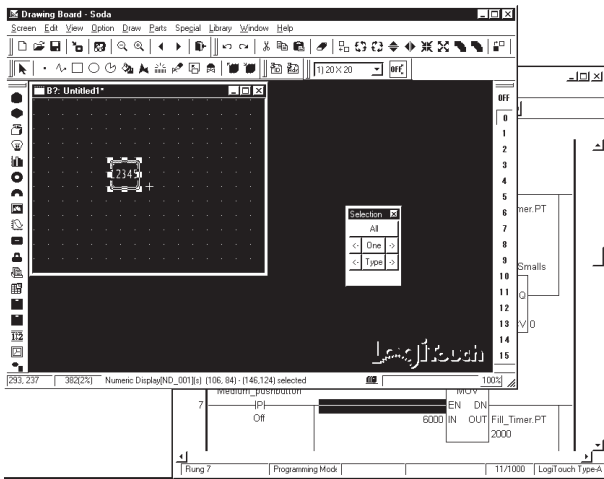

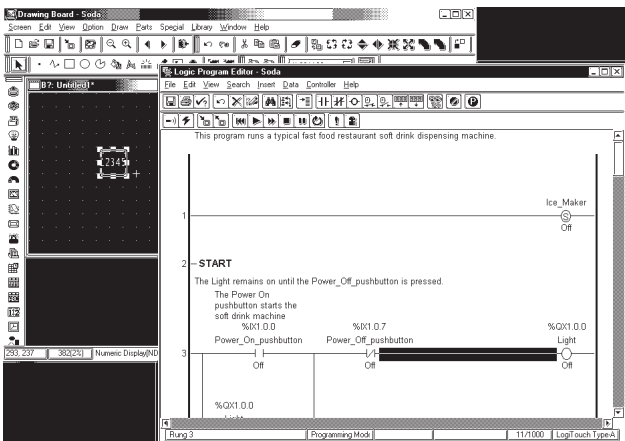
Note: A variable will be registered with the Symbol Editor as a Logic symbol when the logic program is saved.

| PROCEDURE | REMARKS |
|--|---|
| <p>(1) Select the desired Part on the Screen Editor.</p>  | <p>Reference 1.2.3 Creating/Editing/Saving a Logic Program</p> |
| <p>(2) Select the Screen Editor [Edit] menu - [Copy] command, or click on the  icon.</p> <p>The selected Part will be copied to the Clipboard.</p> | |
| <p>(3) Select the rung where you wish to insert an instruction on the Logic Program Editor, and then select [Edit] menu - [Paste] command, or click on the  icon.</p>  | |

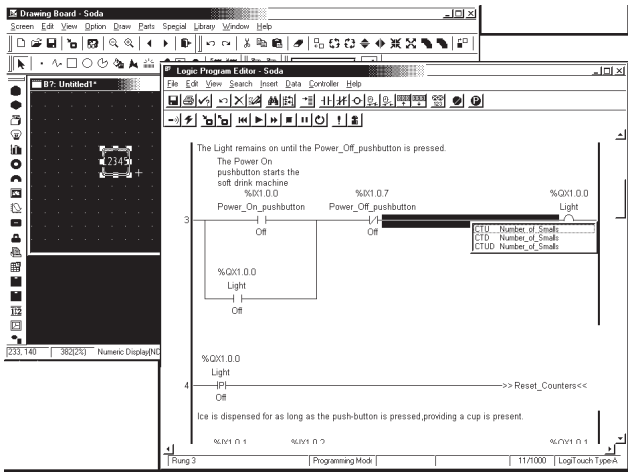
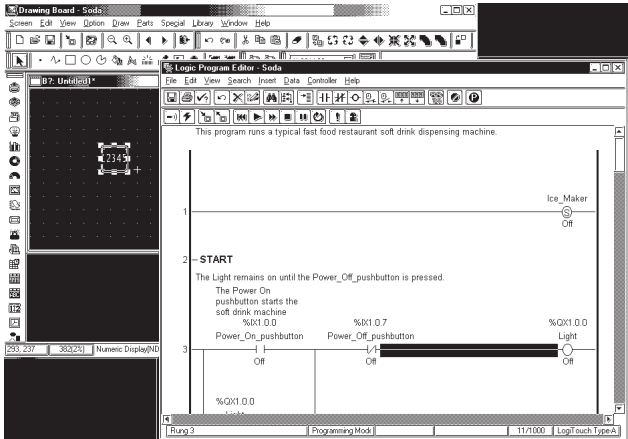
To cancel the Copying, click on the  icon.

| PROCEDURE | REMARKS |
|---|--|
| <p>(4) Select an instruction to convert, and determine by double-clicking on it. The instruction will be inserted.</p>  <p style="text-align: center;">↓</p>  | <p>A list of instructions to which the copied Part can be converted will appear.</p> <p>To cancel the Pasting, click on the  icon.</p> |

■ Dragging and Dropping

Copying and pasting of an instruction or a Part can be performed by the drag and drop operation.



Before dragging and dropping an instruction or a Part, you have to allocate a variable to the instruction or the Part. Instructions or Parts without a variable allocated cannot be dragged and dropped.

◆ Dragging and dropping of a Logic Program Instruction to a Part

By dragging a logic program instruction created with the Logic Program Editor to the Screen Editor, you can place a Part that corresponds with the instruction.



Before dragging and dropping an instruction, be sure to save the logic program.

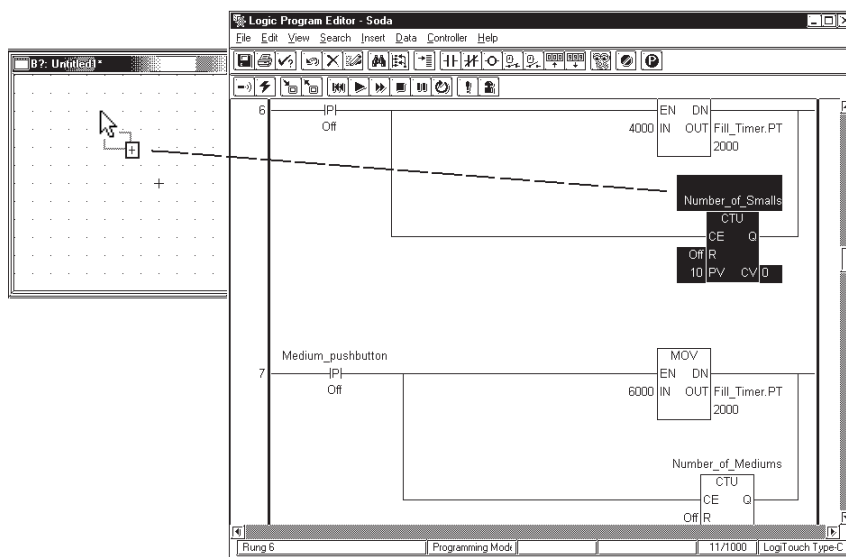

◆ Dragging and dropping of a Part to a Logic Program instruction

By dragging a Part placed on the screen to a Logic Program, you can place an instruction that corresponds with the Part. Drag the Part while holding down the **[Ctrl]** key.

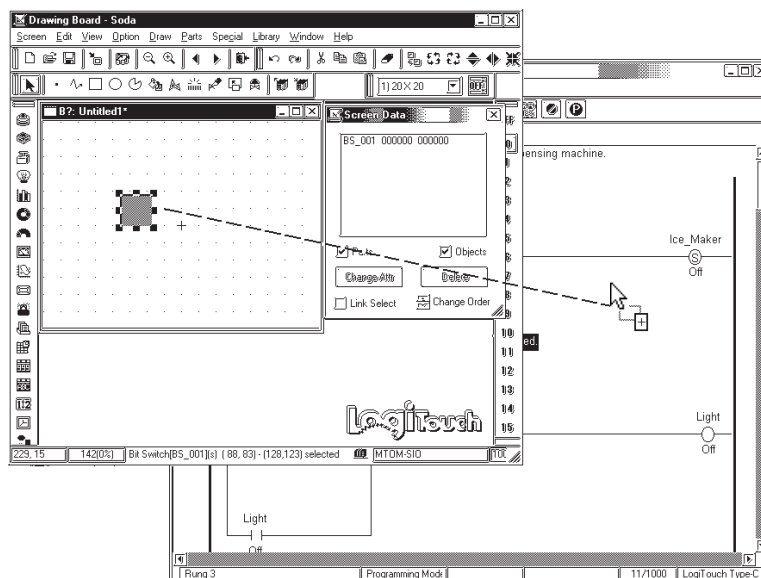

2.3.8 Duplicate

This command allows you to easily make multiple copies of any object. The address of the copies can be set up so as to increment automatically from copy to copy, or simply reuse the address of the original object.

■ Duplicate Setting Dialog Box

When this command is used, the Duplicate dialog box for entering the copy specifications, will appear as shown below.

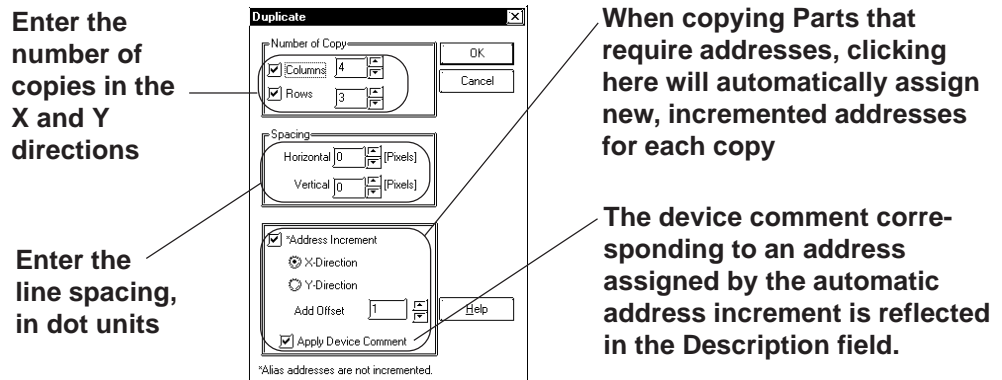

◆ Number of Copies

Here, how many times an object will be copied in the X and Y directions is entered. When "1" is entered for either direction, copying will not be performed in that direction.

The number of copies is also limited by the copied object's location, size, the Duplicate dialog box's Spacing settings, and any other related settings.

◆ Spacing

Enter the spacing interval of dot (screen pixel) units to be used when the object is copied for both the Horizontal and Vertical directions.



Note: When Duplicating an object, its positioning will be decided based on the top left handle of the copied (master) object. However, if a Bar Graph's handles are located in a graph display area, the object will be placed based on the graph display area, not the graph's border. Therefore, when setting the spacing, be sure to not overlap any of the graphs' borders.

◆ Address Increment

To copy multiple Parts, specify the direction of the automatic address increment. According to the automatic address increment, consecutive Addresses will be assigned in the designated direction. When the original object's Address is a Bit Address, the automatic address increment is performed in the unit of bit, and when it is a Word Address, the automatic address increment is performed in the unit of word.

If the automatic address increment is not used, Parts will be copied using the same address as their original ones.



Note: When the original object's Address is a symbol/Logic symbol, the automatic address increment is not performed.

E.g.) When duplicating with the settings shown below:

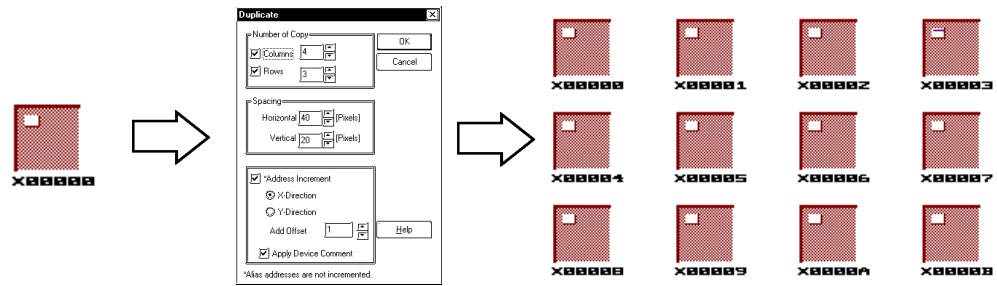



◆ Reflection of Device Comments

When the [Apply Device Comment] check box is marked with a check, the device comment corresponding to an address assigned by the automatic address increment will be reflected in the Description Field. For Parts designating multiple Addresses, however, the device comment corresponding to an Address designated as the Reflected Description Address is re-lected. The Reflected Description Addresses for different Parts are shown in the table below:

<Reflected Description Address Table>

| Object name | Automatic input address |
|----------------------|---------------------------------|
| Bit Switch | Operation bit address |
| Word Switch | Word address |
| Function Switch | |
| Toggle Switch | Operation bit address |
| Lamp | Bit address |
| Bar Graph | Word address |
| Pie Graph | Word address |
| Half-pie Graph | Word address |
| Meter Graph | Word address |
| Trend Graph | Channel 0 word address |
| Keypad Input Display | Word address |
| Alarm | Word address |
| File Name Display | |
| Data Logging Display | Block number designated address |
| Numeric Display | Word address |
| Message Display | Address |
| Date Display | |
| Time Display | |
| Graphic Display | Address |
| Data Sampling | Sampling Address |

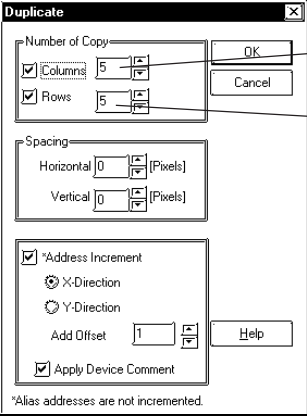
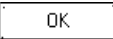
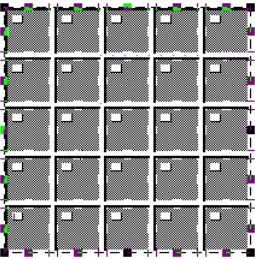



■ Duplicating

| PROCEDURE | REMARKS |
|---|---|
| <p><When Duplicating a Switch 5 times in both the X and Y directions></p> <p>(1) Select the desired object.</p>  <p>(2) Select the pull down [Edit] menu's [Duplicate] command.</p> <p>(3) Enter the number of copies to make in the X and Y directions, spacing between copies. If desired, click on the Address Increment check box, to increment addresses automatically.</p>  <p>(4) Click on the  button to duplicate the object.</p>  | <p>When duplicating an object, positioning will be decided based on the top left handle of the copied (master) object.</p> <p>To cancel the duplication, click on the  icon.</p> <p>To stop duplicating, press the  key.</p> |

2.3.9 Delete

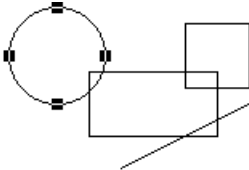
Here, the procedure for deleting an object is explained.

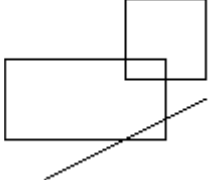
■ Deleting an Object

| PROCEDURE | REMARKS |
|---|--|
| <p>(1) Select an object.</p>  <p>(2) Select the pull down [Edit] menu's [Delete] command, or click on the  icon.</p>  | <p>Instead of selecting the [Delete] command, the computer keyboard's Delete key can also be used.</p> <p>To cancel the deletion, click on the  icon.</p> |

2.3.10 **Align**

Here, the procedure for aligning and centering object(s) are explained.

■ **Alignment Dialog Box**

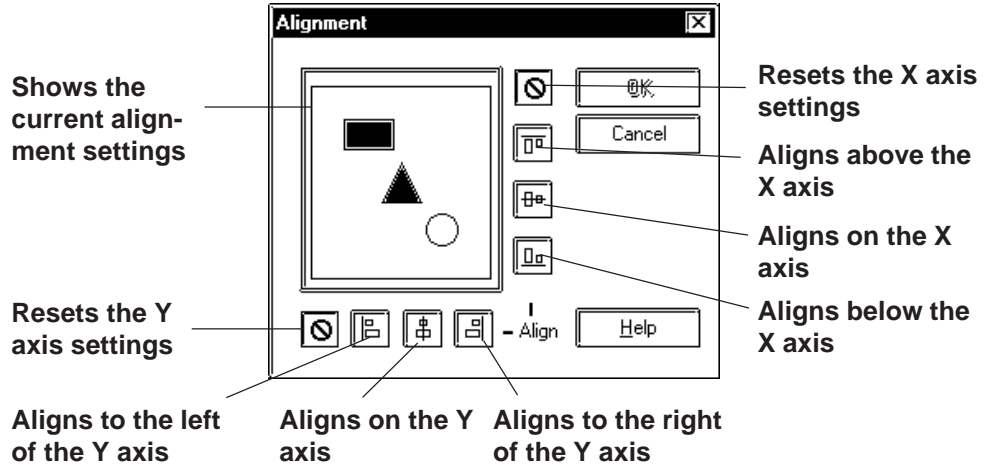





■ **Aligning Object Positions**

| PROCEDURE | REMARKS |
|--|--|
| <p>(1) Select all the desired objects to be aligned.</p> <p>(2) Select the [Edit] menu - [Align] command, or click on the icon.</p> <p>(3) Select the type of alignment from the Alignment dialog box. In this example, select the icon (X-axis: Bottom) and do not select any vertical (Y-axis) position.</p> <p>(4) Click on the button to align the objects.</p> | <p>Reference 2.3.1 <i>Selecting Objects</i></p> <p>While an individual label can be aligned, groups of labels cannot. (Click on an object to select its handles and then click on its Label to select the Label's handles.) Text characters on both Numeric or other types of Displays can be aligned in the same manner.</p> <p>To align objects, combine the selections shown below: Horizontal position: Up, Center, Bottom Vertical position: Left, Center, Right</p> <p>To cancel the alignment, click on the icon.</p> |



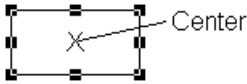

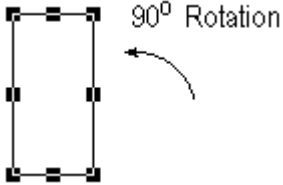
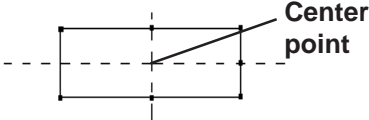
2.3.11 Rotate Left/ Rotate Right

With this command, an object can be rotated in 90° increments. However, loaded Screens and Marks, and grouped objects cannot be rotated.

Rotating an Object Counterclockwise (Left)

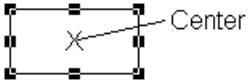
| PROCEDURE | REMARKS |
|---|--|
| <p>(1) Select an object.</p>  <p>(2) Select the [Edit] menu - [Rotate Left] command, or click on the  icon.</p> <p>The object will be rotated counterclockwise 90 degrees, relative to its center point; if necessary, repeat the command.</p>  | <p>Reference 2.3.1 <i>Selecting Objects</i></p> <p>The center point of the object is where two lines, connecting the opposite handles (other than the corner handles), cross.</p>  <p>To cancel the rotation, click on the  icon. (Clicking on the  icon one time reverses one 90 degree rotation.)</p> <p>If an object is moved outside the drawing area by rotating, the object will not be displayed on the LT screen.</p> |

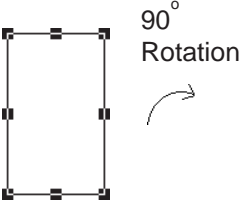
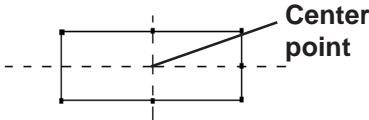



Rotating an Object Clockwise (Right)

| PROCEDURE | REMARKS |
|---|---|
| <p>(1) Select a desired object.</p>  <p>(2) Select the [Edit] menu - [Rotate Right] command, or click on the  icon.</p> <p>The object will be rotated clockwise 90 degrees, relative to its center point. If necessary, repeat the command.</p>  | <p>Reference 2.3.1 <i>Selecting Objects</i></p> <p>The center point of the object is where two lines, connecting the opposite handles (other than the corner handles), cross.</p>  <p>To cancel the rotation, click on the  icon. (Clicking on the  icon once reverses one 90 degree rotation.) If an object is moved outside the drawing area by rotating, the object will not be displayed on the LT screen.</p> |



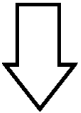
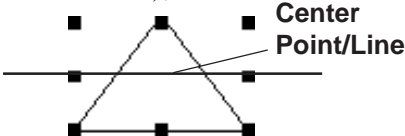

2.3.12 Mirror X/ Mirror Y

An object can be moved symmetrically around its center line with respect to the X or Y axis. The display position of Parts, Text, Load Screens, and Load Marks can only be moved symmetrically.

■ Moving Symmetrically along the X-axis

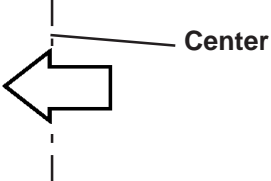
| PROCEDURE | REMARKS |
|--|--|
| <p>(1) Select an object.</p>  <p>(2) Select the [Edit] menu - [Mirror X-axis] command, or click on the  icon.</p> <p>The object will move symmetrically with respect to the X-axis.</p>  | <p>Reference 2.3.1 <i>Selecting Objects</i></p> <p>The center point of the object is where two lines, connecting the opposite handles (other than the corner handles), cross.</p>  <p>If an object is moved outside of the drawing area by using the Mirror X function, the part of the object outside the drawing area will not be displayed on the LT screen.</p> <p>To cancel the change, click on the  icon.</p> |

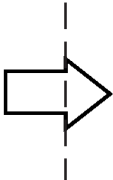
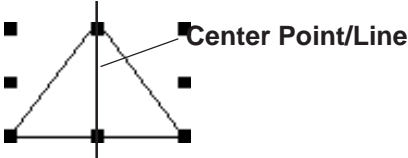



■ Moving Symmetrically along the Y-axis

| PROCEDURE | REMARKS |
|---|---|
| <p>(1) Select an object.</p>  <p>(2) Select the [Edit] menu - [Mirror Y-axis] command, or click on the  icon.</p> <p>The object will moves symmetrically around the Y axis.</p>  | <p>Reference 2.3.1 <i>Selecting Objects</i></p> <p>The center point of the object is where two lines, connecting the opposite handles (other than the corner handles), cross.</p>  <p>If an object is moved outside of the drawing area by using the Mirror Y function, the overflowing part of the object will not be displayed on the LT screen.</p> <p>To cancel the change, click on the  icon.</p> |

2.3.13 Group/ Ungroup

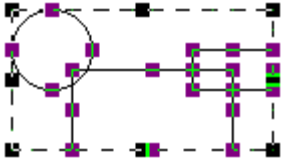
This function can be used to “group” multiple objects, enabling you to manipulate the “group” as a single object, even after changing screens or using a different editing function.

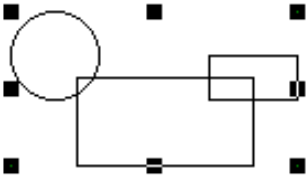
■ Grouping Objects

| PROCEDURE | REMARKS |
|--|--|
| <p>(1) Select the objects to be Grouped.</p>  <p>(2) Select the [Edit] menu - [Group] command, or click on the  icon.</p>  | <p>Reference 2.3.1 <i>Selecting Objects</i></p> <p>To cancel the Grouping, click on the  icon.</p> |







Note:

- When a Load Screen is included in a group, its handles appear as , so that the objects cannot be scaled up/down. Thus, you must first ungroup the objects in order to scale any individual object.
- When a Part is included in a group, double click on the group to bring up the Confirm Device Address dialog box, where address changes can be made.

Reference 2.3.15 *Changing Attributes*

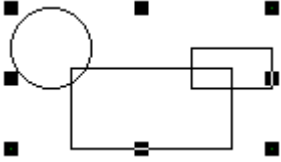
■ Ungrouping Objects

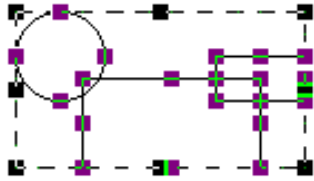







This function changes a Group of objects to a selection of multiple objects.

| PROCEDURE | REMARKS |
|--|--|
| <p>(1) Select a group of objects.</p>  <p>(2) Select the [Edit] menu - [Ungroup] command, or click on the  icon.</p>  | <p>▼Reference▲ 2.3.1 <i>Selecting Objects</i></p> <p>To cancel the ungrouping, click on the  icon.</p> |

2.3.14 Bring to Front/ Send to Back

When graphics and Parts overlap each other, you can change the order of the layers with these two commands.







■ Changing the Order of Overlapping Objects

| PROCEDURE | REMARKS |
|--|---|
| <p>In this example, you will move the oval, partially hidden by the rectangle, to the front.</p> <p>[Bringing an Object Forward]</p> <p>(1) Use the cursor to select the filled oval.</p>  | <p>Reference 2.3.1 <i>Selecting Objects</i></p> |
| <p>(2) Select the [Edit] menu - [Bring to Front] command, or click on the  icon.</p>  | <p>To cancel the movement, click on the  icon.</p> |
| <p>[Sending an Object Behind]</p> <p>(1) Use the cursor to select the black rectangle.</p>  | |
| <p>(2) Select the [Edit] menu - [Send to Back] command, or click on the  icon.</p>  | <p>To cancel the movement, click on the  icon.</p> |

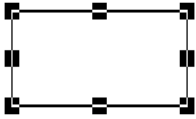
2.3.15 Changing Attributes

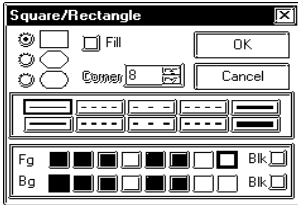
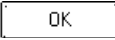
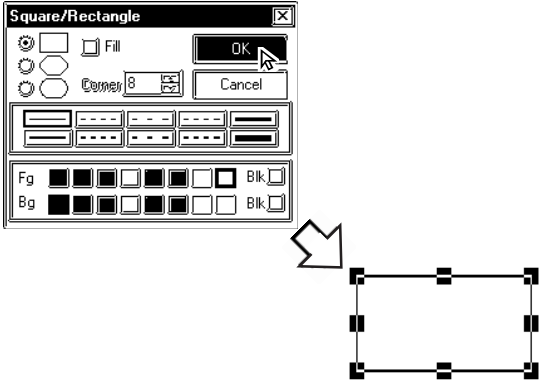
Here, you can change any of an object's attributes, i.e. its color, address, etc. Also, with objects of the same type, you can change the same attribute of all the objects of that type at the same time.

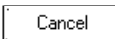
■ Changing Attributes

| PROCEDURE | REMARKS |
|---|--|
| <p>(1) First, select an object to change its attributes. In this case, an unfilled rectangle drawn with a solid line.</p>  <p>(2) Select the [Edit] menu - [Change Attribute] command, or click on the  icon.</p> <p>(3) Select a new attribute from the dialog box. Here, a dotted line is selected.</p>  <p>(4) Click on the  button to register your change.</p>  | <p>Reference 2.3.1 <i>Selecting Objects</i></p> <p>While the attributes of Grouped objects generally, cannot be changed, the same type objects can be changed at the same time. When Grouped Parts have been selected, only their addresses can be changed.</p> <p>Reference 2.3.15 ■ <i>Changing Attributes; Confirming Addresses</i></p> <p>Instead of clicking on the  icon, simply double-click on the object when selecting it, to display the Attribute Settings dialog box (skip step {2}).</p> <p>To cancel the attribute changes, click on the  button in the dialog box.</p> <p>You can reverse the attributes changes (only for the most recent change) by clicking on the  icon.</p> |



Note: You can select more than one object of the same type and change the attributes of each, at the same time. With all the desired objects selected, click on the Tool box's  button; then, proceed with step (2).

Reference 2.3.1 ■ *Selecting Objects; How to Select Multiple Objects; Selecting Objects by Type from a Multiple Selection*

■ **Confirming Addresses**

If a Part that requires an address has been grouped, the Confirm Device Address dialog box shown below will appear whenever its attributes are changed; the Part addresses are changed here.

Allows you to view either the Bit or Word Addresses of all the Parts in the currently selected group of objects

Part Addresses are displayed here

Check this box to automatically change all the addresses of the Parts in this group that have the same Device Address

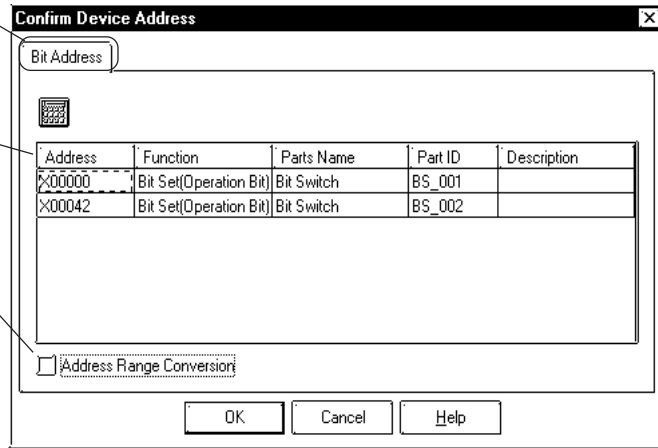

◆ **Bit and Word Addresses**

Each Part’s address is displayed. To change an address, click on the inside of each cell. As shown above, any Switches selected that have state changes will have both their Operation Bit and their Monitor Bit addresses displayed.

◆ **Address Range Conversion**

When an address is changed and this check box is checked, any other Part with the same device address will be automatically changed.



Note: The address conversion is not performed in the case of symbol/Logic symbol.

In the example above, if the first bit address is changed from X00000 to X00010, the following bit addresses will be changed as below.

Clicking on any cell other than the changed one will show the changed address

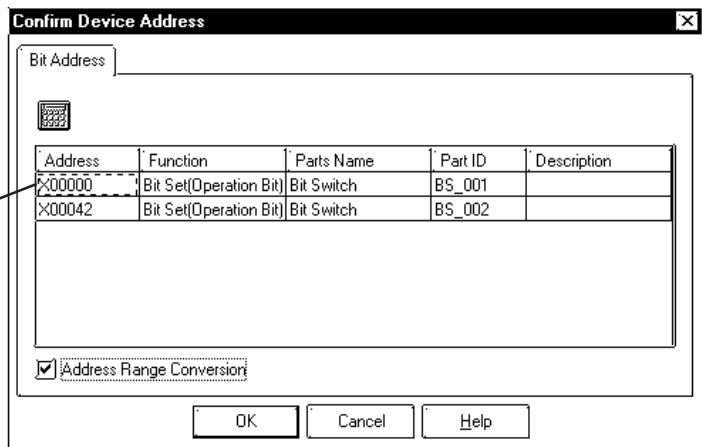

2.3.16 Changing Coordinates

Object positions and sizes can be changed by specifying their coordinates.

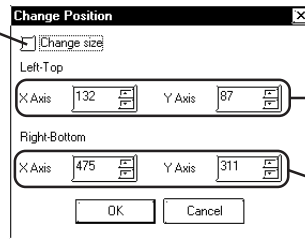

Check this check box to change the size.



Enter the object's left top coordinates.

Enter the object's right bottom coordinates.

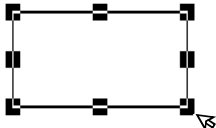
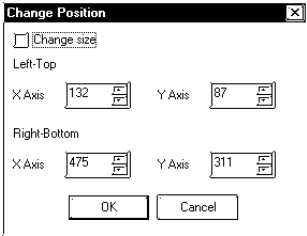
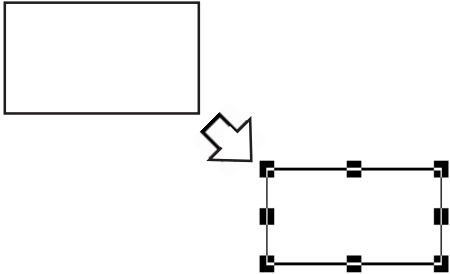
Using Coordinates to Change an Object's Position

| PROCEDURE | REMARKS |
|---|--|
| <p>(1) Select a desired object.</p>  <p>(2) Select the [Edit] menu - [Change Coordinates] command.</p> <p>(3) Enter the object's left top and right bottom coordinates.</p>  <p>(4) Click on the <input type="button" value="OK"/> button to execute the command.</p>  | <p>Reference 2.3.1 <i>Selecting Objects</i></p> <p>To change the size, check the Change size check box in step (3).</p> <p>To cancel the coordinates change, click on the <input type="button" value="Cancel"/> button.</p> <p>To undo the coordinates change, click on the  icon.</p> |

2.3.17 Editing the Node of a Multi-segment Line

Creating, Editing, or deleting a node can be performed on a multi-segment line and a filled polygon.

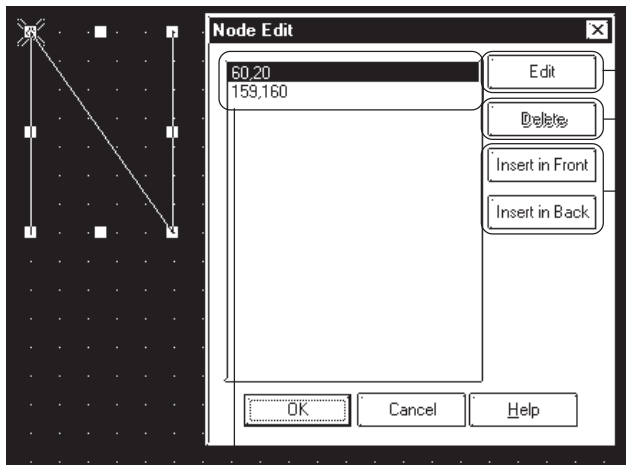

The [Node Edit] dialog displays.
 Deletes the selected peak.
 Adds a node. The added node is the same as the selected node. If the screen capacity is exceeded by the added value, the [Insert in Front] and [Insert in Back] buttons are highlighted and cannot be specified.

If the node edit is selected, the selected point in the displayed dialog is marked with a cross.

■ Editing a Node on a Continuous Line

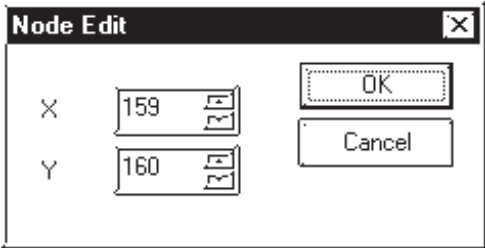

| PROCEDURE | REMARKS |
|---|--|
| <p>(1) Select the desired continuous line.</p> <p>(2) Select [Node Edit(K)] from [Edit(E)].</p> <p>(3) Select the coordinate value that you want to edit.</p> <p>(4) Click on the <input type="button" value="Edit"/> button.</p> <p>(5) Enter the X/Y coordinate values in the coordinate change dialogs.</p>  <p>(6) Click on the <input type="button" value="OK"/> button to run the coordinate change.</p> | <p>Reference 2.3.1 Selecting an Object</p> <p>To cancel the coordinate change, Click on the <input type="button" value="Cancel"/> button.</p> |



2.3.18 Convert (Import) Bit map

This section describes how to convert image data (bit map = BMP file), created using other drawing software or imported using a scanner, for use on a LT Image (I) screen (bit map conversion), which can then be placed on the Base, Trend Graph, and Keyboard screens.

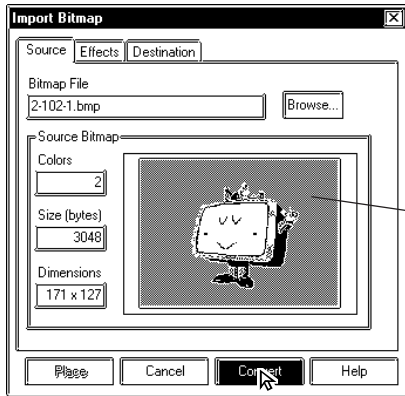
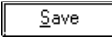
Reference For Bit Map Conversion data, refer to *3.5 Creating Image Data - Image*

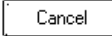
■ Converting and Placing a Bitmap

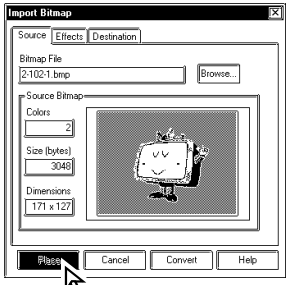
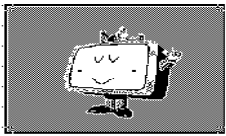
| PROCEDURE | REMARKS |
|--|---|
| <p>(1) Select the pull down [Edit] menu's [Convert Bitmap] command.</p> <p>(2) Set all conversion settings and click on the  button.</p>  | <p>Once a bit map has been converted to an image, place the image on a screen using the Load Screen function.</p> <p>Reference 2.2.10 Load Screen</p> <p>For each setting item,</p> <p>Reference 3.5 Creating Image Data - Image</p> <p>Before conversion, the image displayed in the Import Bitmap dialog box is still compressed and may appear different from the actual display (after conversion).</p> |
| <p>(3) Click on the  button. The bit map is then saved as an Image screen.</p>  | <p>To cancel bit map conversion, simply click on the  button.</p> |

| PROCEDURE | REMARKS |
|---|---|
| <p>(4)Click on the  button.</p> <p>The Image screen's border will appear on the current screen.</p>  <p>(5)Click on the point where the Image screen is to be placed.</p> <p>The Image screen will appear on your screen.</p>  | <p>To cancel the placement, click on the  icon.</p> |



Note: • If a portion of an Image screen extends over a Base screen's Y axis border, that portion will not be displayed on the LT screen. When the Image screen is placed over the Base screen laterally, however, any part that extends over the Base screen X axis border will be squeezed onto the LT screen.(i.e. not cut)

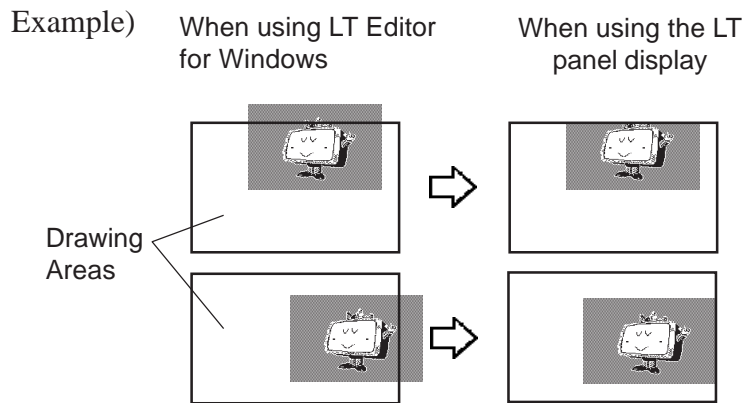

■ **Pasting Other Software's Bitmap Data**

When another drawing software's bitmap image is copied and the [Paste] command is executed with the Screen Editor, the Paste bitmap dialog box like the bitmap conversion one will automatically appear. In that case, start from step (2) in the same way. However, since a Bitmap File name does not need to be selected, the [Bitmap Conversion] tab will not be displayed. This operation can be performed only for BMP file data. When using another file format, be sure to use that software's BMP file format save option to create a BMP file.

2.3.19 Transferring a Screen to the Clipboard

The current screen is transferred as an image to the clipboard^{*1}. The transferred screen can be utilized by pasting it to other drawing software. The screen types that can be transferred to the clipboard are the Base (B) screen, Mark (M) screen.

■ Transferring a Screen to the Clipboard

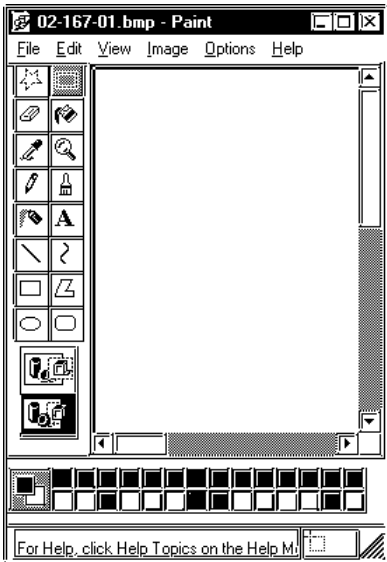
| PROCEDURE | REMARKS |
|--|---------|
| <p>(1) Select the [Screen to clipboard] command from the [Edit] menu. The current screen will be transferred to the clipboard.</p> <p>(2) Paste the screen to other drawing software.</p>  | |

*1 An area where text, graphics, or both, that have been Cut or Copied, are temporarily stored. The contents of the Clipboard can be “pasted” (copied from the Clipboard) using the Paste function. However, once the Copy/Cut command is executed, the data stored in the Clipboard is replaced; therefore, only the data from the most recent Copy/Cut command can be Pasted.

2.3.20 **Converting a Screen to a Bitmap File**

The current screen is converted into a bitmap file, and then saved. The screen types that can be converted are the Base (B) screen and Mark (M) screen.

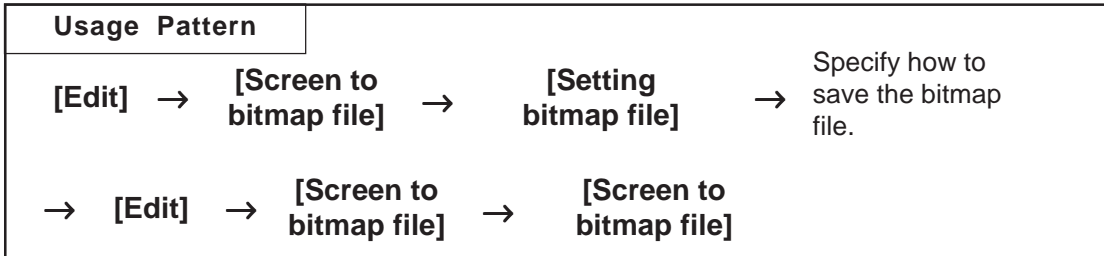

■ **Designating a Bitmap’s File Name**

Before converting the screen to a bitmap file, specify how to save the bitmap file.

Specify a file name and output destination to save the file.

Automatically creates a file name to save the file.

Specify an output destination of the file when a file name is being created automatically.

Specify how a file name is to be created automatically.

◆ **Prompt for filename when saving**

When the [Screen to bitmap file] command is executed, the Save As dialog box will appear, where you can specify the location and name of the file to be saved.

◆ **Automatically create file name**

When the [Screen to bitmap file] command is executed, a file name will be created automatically, and the file saved in a previously specified location.

Example: If the No. 1 screen of the Base (B) screen named “Menu” is converted into a bitmap file:

- Screen type + number.BMP → B1.BMP
- Screen type + number + screen title.BMP → B1 Menu.BMP

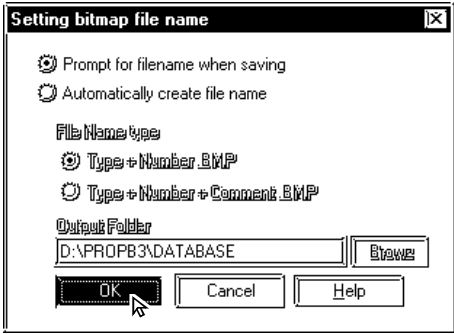
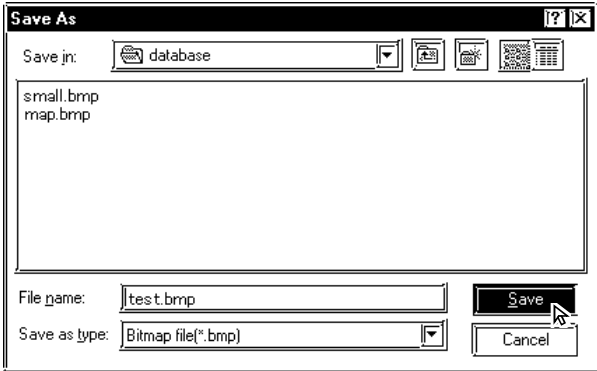

■ Converting a Screen into a Bitmap File

| PROCEDURE | REMARKS |
|---|---------|
| <p>(1) Select the [Setting bitmap file] option for the [Screen to bitmap file] command from the [Edit] menu.</p> <p>(2) Select a method for saving the bitmap file, and establish it by clicking on the <input type="button" value="OK"/> button.</p>  <p>(3) Select the [Screen to bitmap file] option for the [Screen to bitmap file] command from the [Edit] menu. When a file name is created automatically, the bitmap file is saved now.</p> <p>(4) If [Prompt for filename when saving] was selected in step (2), specify a file name and output destination, and then click on the <input type="button" value="Save"/> button.</p>  | |

2.3.21 Redraw Screen

This command updates the current drawing area display to reflect the latest drawing data. When the Auto Redraw feature is not used, filling and editing objects can cause after-images to remain on the screen. Use this function to remove these images and show the screen as it will appear on the actual LT display.

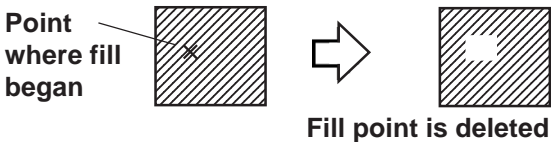
■ Redrawing a Screen

| PROCEDURE | REMARKS |
|---|---------|
| <p>Sometimes, when removing an object's filled color, only the fill point area's color will be removed, resulting in a small, non-colored square.</p>  <p>(1) Select the [Edit] menu - [Redraw] command, or click on the  icon.</p> <p>The screen will automatically be refreshed and all the fill color will be removed.</p>  | |



2.3.22 Undo

With this function, an operation can be “undone” and the screen display returned to the previous condition. Every time the  icon is clicked on, depending on memory, previous operations will be undone, in succession.



The Redraw Screen function cannot be undone.



■ Canceling an Action

| PROCEDURE | REMARKS |
|--|---|
| <p>In this example, a circle has been accidentally deleted.</p> <p>(1) Select the [Edit] menu - [Undo] command, or click on the  icon.</p> <p>The circle will reappear and the screen is displayed as it was prior to the deletion.</p>  | <p>To cancel the Undo operation, click on the  icon.</p> <p>Reference 2.3.23 Redo</p> |

2.3.23 Redo

With this function, an operation previously undone with the Undo command can be “redone”, if performed immediately after the Undo command is used.

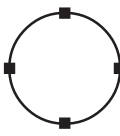
■ Redoing the Previous Undo Command

| PROCEDURE | REMARKS |
|--|---|
| <p>In this example, the undone circle deletion will be redone (i.e. deleted again).</p> <p>(1) Select the [Edit] menu - [Undo] command, or click on the  icon.</p> <p>The circle will reappear.</p>  <p>(2) Select the [Edit] menu - [Redo] command, or click on the  icon.</p> <p>The circle will disappear.</p> | <p>To cancel the Redo operation, click on the  icon.</p> <p>Reference 2.3.22 Undo</p> |

2.4 Library Items

The objects you created can be registered. These registered objects are called “Libraries”. You can call up and use the registered Libraries, whenever necessary. Like a pre-made Part Shape, the objects registered in these libraries can be viewed and selected using the Browser function. Multiple objects can be combined and registered, and Marks created on Mark screens can also be registered.

▼ Reference 3.1 Creating a Mark - the Mark Screen

These items are stored in a Library file (CPW file), separate from Project (LTE) files. When library data is a Mark, it will be saved in a Mark Library (MRK) file. Moving from one Library file to the other allows objects to be called up that were previously used in a variety of screens and Project files.

To call up an item from a Library, or save an item to a Library, either select one of the tool bar’s icons  or use the pull down menu’s [Library] commands.



Note:

With both Base and Mark screens open, when the Base screen where the Library Browser is remained open is changed to the Mark screen, the Mark Library Browser cannot be open on the Mark screen. When changing the screen, first close the Library Browser and change the screen, and then open the Library Browser on the newly opened screen.

Objects called up via the [Load Screen] or [Load Mark] command, as well as D-script cannot be registered.

■ Library Browser

When either  or  icon is clicked on, the Library Browser will appear.

Displays the currently selected item’s registration number and title; clicking on the triangle brings up a list of the items in the current library

Menu Bar

Tool Bar

Reverse video indicates that this item is currently selected

Displays the item’s registration number and title

Status Bar

Scrolls through the different items, either left, right, up, or down

■ Editing Library Items

Three Library Item editing functions are available.



Cuts a Library item (which is then moved to the Clipboard); the Library item can then be moved to another screen using the [Paste] function.



Copies the selected Library item to the Clipboard.



Pastes the Library item Cut or Copied, and temporarily stored in the Clipboard, to another screen. The Library item can also be Pasted to another Library file.



You can remove a Library item using the Delete function. To do so, select the [Delete] command from the Library dialog box's pull down [Edit] menu.

▼ **Reference** ▲ 2.4.3 Editing Library Items

■ Changing the Library's Display

The Library's image display size and type can be changed. Also, you can change from one Library file to another.

◆ Library Size

When either the , , or  icon is clicked on, or the pull down [View] menu's either [Normal], [Adjust to Fit], or [Full Screen] command is selected, and the Library display size can be changed. When Normal is selected, each Library size will be displayed relatively, allowing you to check the relationship between Libraries for their size. When the Adjust to Fit function is selected, the Library item will be enlarged until it fits inside the Library window's borders. When Full Screen is selected, the Library item will be displayed in its actual (LT) screen size.

◆ Library Type

When the pull down [View] menu's [All Objects], [Part Objects], or [Graphic Objects] is selected, the Library type(s) shown on the Browser can be selected.

| | |
|-------------------|---|
| [All Objects] | Displays all the Library items in the selected Library file. |
| [Part Objects] | Displays only those items that are Parts in the selected Library file. |
| [Graphic Objects] | Displays only those items which are not Parts in the selected Library file. |

■ **Switching Library Files**

◆ **Creating a New Library File**

When the  icon is clicked on, or the pull down [File] menu's [New] command is selected, the Dialog box shown below will appear. When a Description is input and the button is clicked on, a new Library file will appear.

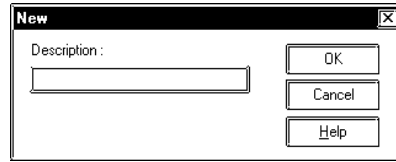

◆ **Selecting (Calling Up) another Library File**

When the  icon is clicked on, or the pull down [File] menu's [Select File] command is selected, the Library file list will appear. By selecting (dragging) the desired Library file from this list, other Library files can be called up.



Note: Library files for GP-PRO/PBIII for Windows (Digital Electronics Corporation) (CPW file) cannot be used.

Library files for GP-PRO/PBIII for Windows (Digital Electronics Corporation) (CPW file) cannot be used.

Shows the currently displayed file's folder

Lists all the files in the currently selected folder

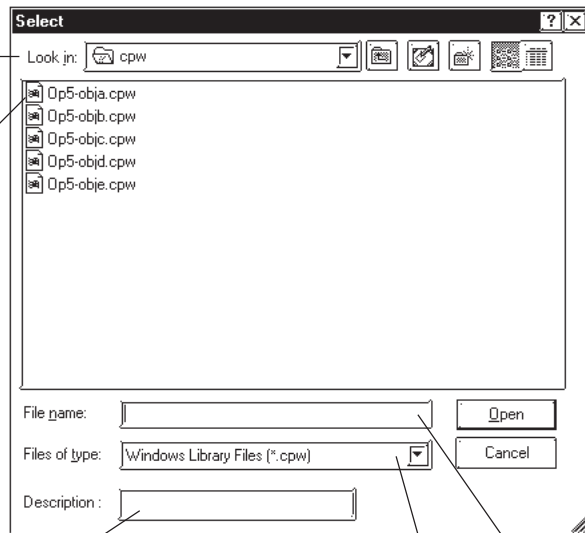

Displays the currently selected file's Description data (if any)

Currently selected file's format (type)

Currently selected file's name (If desired, can be entered)

■ Modifying Library File Names (Titles)

Library filenames can also be changed. Simply select a library from the file list, then select [Property] from the [Edit] menu, and the Property screen will appear. Type in the filename (title) that you wish to use and click on OK.

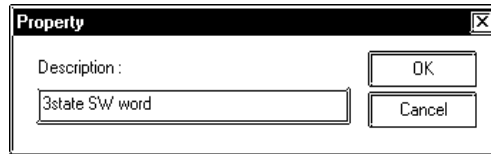









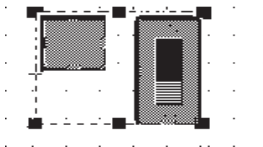

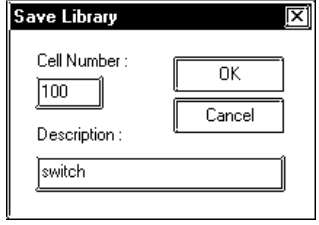
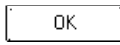
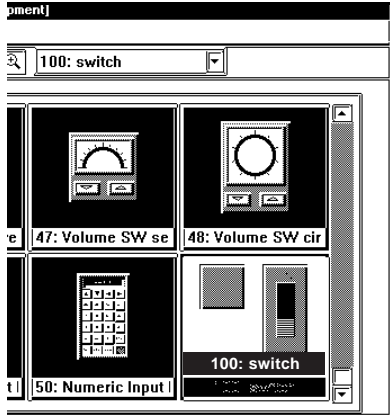

■ Displaying the Browser at the Top of the Normal Screen

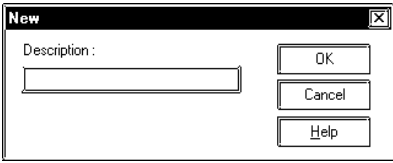

If the [Always on Top] option is selected from the [Window] menu, whenever the Library Browser is called up, it will be placed at the top of the current window. If this option is not selected, selecting another screen will place that screen over the Library screen, hiding it from view.

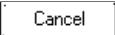
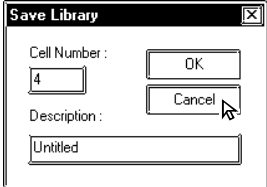
2.4.1 Registering Library Items

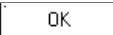
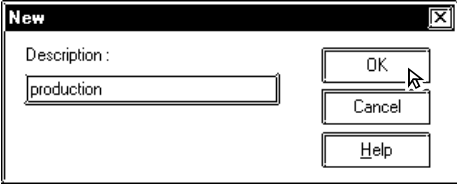
Here, the procedure for registering a Library is explained.

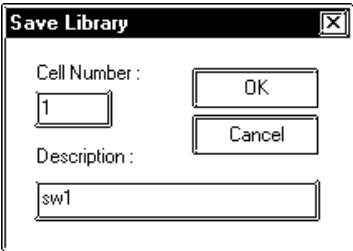
| PROCEDURE | REMARKS |
|--|--|
| <p>(1) Select objects to be registered as Library items.</p>  <p>(2) Select the [Library] menu - [Register Library] command, or click on the  icon.</p> <p><A. When registering a new Library item to the currently open Library file:></p> <p>(3) Enter the Library's registration number and description.</p> <p>In the Cell Number area, the smallest of the currently open Library file's unused numbers will be automatically displayed. To change it, simply enter the desired number.</p>  <p>(4) Click on the  button to register the number.</p> <p>The registered Library will then be displayed in the Browser.</p>  | <p>Reference 2.3.1 ■ <i>Selecting Objects; Registering Library Items</i></p> <p>If the Library Browser is already showing, click on either  or  icon in the screen editor drawing area, and the  icon in the Library Browser, which will perform the function of step (2).</p> <p>The following procedures will differ depending on the Library file registered.</p> <ul style="list-style-type: none"> • When registering a new Library item to the currently open Library file: • When no Library file is displayed: • When registering a Library item to a new Library file: • When registering a Library item to a Library file other than the currently open one: <p>Up to 200 Library items can be registered in one file.</p> |

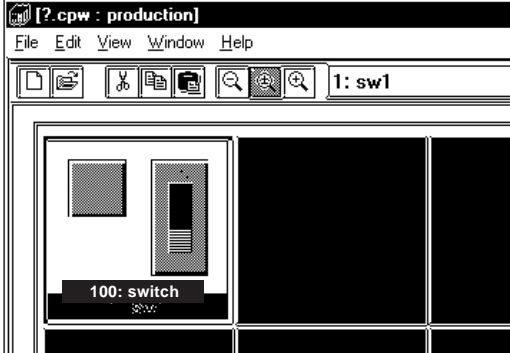
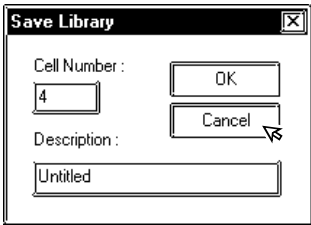
| PROCEDURE | REMARKS |
|--|---|
| <p><B. When no Library file is displayed:></p> <p>(3) The “New” dialog box will appear.</p>  <p>When registering a Library item to a new Library file. <C. When registering a Library to a new Library file>'s step (5)</p> <p>When registering a Library item to an existing Library file: Click on the  button.</p> <p><D. When registering a Library item to a Library file other than the currently open one>'s step (4)</p> <p><C. When registering a Library item to a new Library file:></p> <p>(3) Click on the  button.</p>  <p>(4) Via the Library Browser, select the [File] menu - [New] command, or click on the  icon.</p> <p>(5) Enter a comment and click on the  button.</p>  <p>(6) Via the Screen Editor, select the [Library] menu - [Register Library] command, or click on the  icon.</p> <p>(7) Enter a Cell Number and Description.</p>  | <p>Enter the file name when the Library file is saved.</p> <p>▼Reference▲ 2.4.4 Saving Libraries and Quitting ■ Saving a Library File Under Another Name</p> <p>A comment of up to 60 characters can be entered.</p> <p>Enter a description up to 60 characters.</p> <p>Enter the file name when the Library file is saved.</p> <p>▼Reference▲ 2.4.4 Saving Libraries and Quitting ■ Saving a Library File Under Another Name</p> |

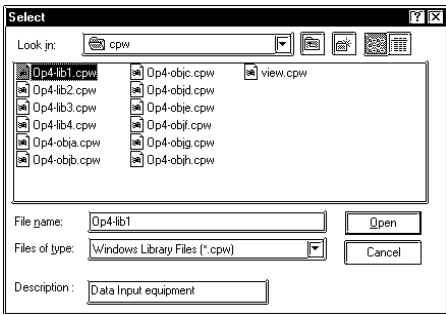
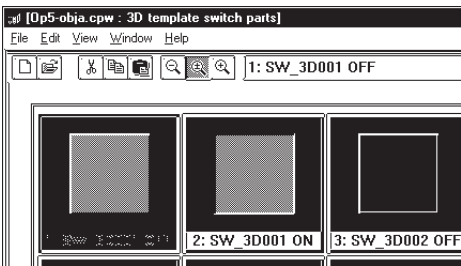
| PROCEDURE | REMARKS |
|---|--|
| <p>(8) Click on the <input type="button" value="OK"/> button. The newly registered Library item will appear in the Browser.</p>  | <p>A maximum of 200 Library items can be registered in each Library file.</p> <p>After creating a new Library item, if you attempt to create or select another Library file without first saving the item via the [Save As...] function, a prompt will appear, asking whether the newly created Library item should be saved or not.</p> |
| <p><D. When registering a Library item to a Library file other than the currently open one.></p> | <p>Reference For the procedures for saving a Library item, refer to <i>2.4.4 Saving Libraries and Quitting</i></p> |
| <p>(3) Click on the <input type="button" value="Cancel"/> button.</p>  | |
| <p>(4) Via the Library Browser, select the [File] menu - [Select File] command, or click on the  icon.</p> | |
| <p>(5) Select the desired Library file from the list, or input the Library file name in the file name area.</p> | <p>Reference <i>2.4 Libraries ■ Switching Library Files</i></p> |
|  | <p>When selecting a Library file in another directory, use the [Look in:] window.</p> |
| <p>(6) Click on the <input type="button" value="Open"/> button to display the selected Library file.</p>  | <p>In step (5), simply move the cursor to the desired Library file name and double-click on it to open it. By doing so, the <input type="button" value="Open"/> (Step 6) button does not need to be used.</p> |

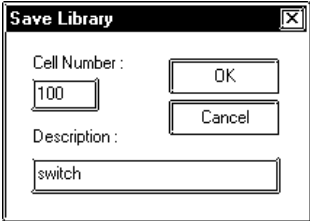
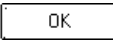
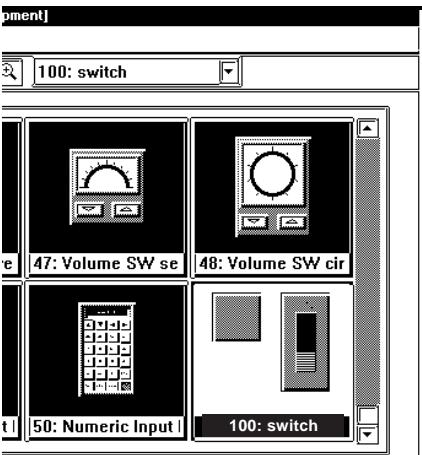



| PROCEDURE | REMARKS |
|--|---|
| <p>(7) Via the Screen Editor, select the [Library] menu - [Register Library] command, or click on the  icon on the Draw Tool Bar.</p> <p>(8) Input a Cell Number and Description. In the Cell Number area, the smallest of the currently open Library file's unused numbers will be automatically displayed. To change it, enter the desired number.</p>  <p>(9) Click on the  button to register the item. The registered Library item will appear in the Browser.</p>  | <p>Up to 200 libraries can be registered in one file.</p> |

■ Using the Cut, Copy, and Paste Functions

Library items can be Cut, Copied and Pasted from the screen drawing area to Browser. First, select the desired Library item in the drawing area, and then either Cut or Copy it; then, Paste it to the current Library Browser.

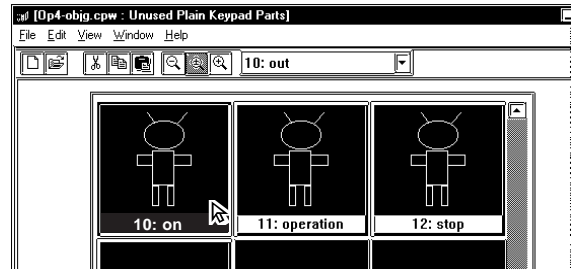
2.4.2 Placing Library Items

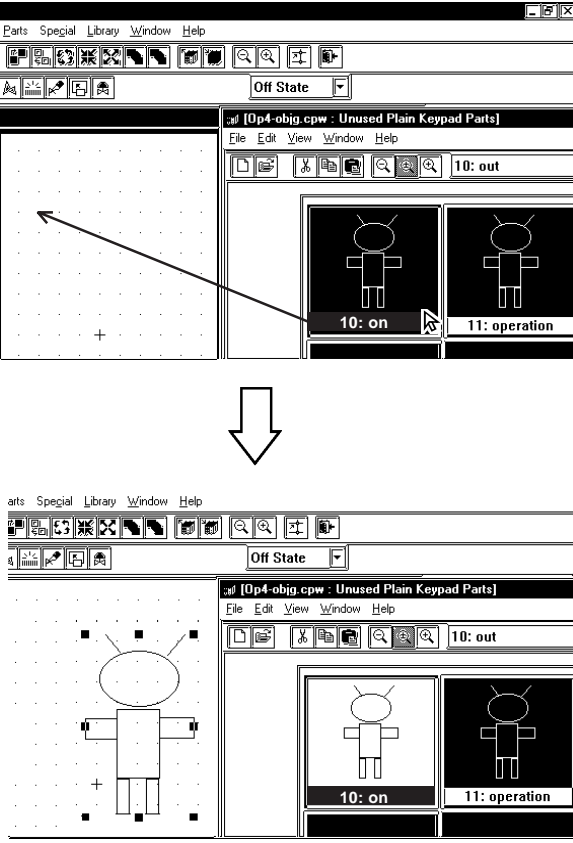
Here, items registered in a Library file are placed on a drawing area.

| PROCEDURE | REMARKS |
|---|---|
| <p>(1) Via the Screen Editor, select the [Library] menu - [Call Up Library] command, or click on the  icon on the Draw Tool Bar.</p> | |
| <p>(2) Select a Library Item to be read out from the Browser.</p>  | <p>Library items Cut, Copied, or Pasted between the screen and the Browser. Simply select the desired Library item and perform the command.</p> <p>When calling up an item from a file different than the currently displayed file, click on the  icon to bring up a file list.</p> |
| <p>(3) Drag the Library item to the desired position in the drawing area.</p> <p>The Library item can be placed on any open screens, and will be displayed in the drawing area. If desired use the sizing handles to alter the item's size.</p> | <p>Reference 2.4 Libraries Switching Library files</p> <p>The Library item's top left corner is the placement point.</p> |
|  | <p>To cancel the placement, click on the screen editor's  icon.</p> <p>Reference To change a Library item's size, refer to 2.3.3 <i>Scaling Up/Down</i></p> <p>Items called up are automatically grouped. They can be freely edited after ungrouping them by clicking on the  icon.</p> <p>Reference 2.3.13 <i>Group/Ungroup</i></p> <p>Grouped library items containing Parts cannot be scaled up or down.</p> |

When a Library that contains Parts is called up, the Confirm Device Address screen will appear. After entering each Part's address, click on the button. To cancel these settings, click on the button.

Reference 2.3.15 Changing Attributes, ■ Address Confirmation

When the Library placed on the screen is double-clicked on, the Confirm Device Address dialog box shown below will appear, allowing you to change the Part's previously entered addresses.

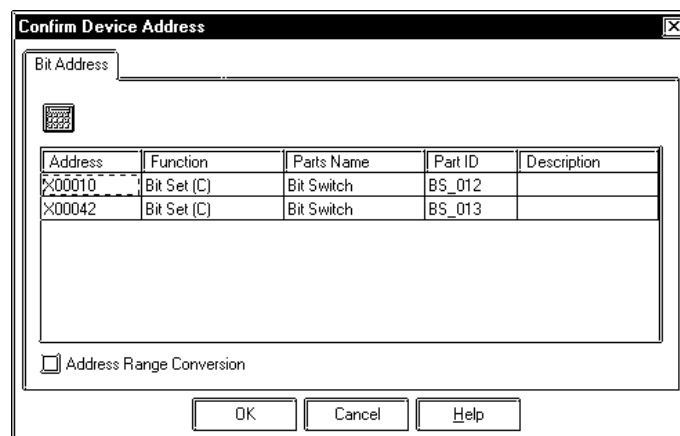

■ Using the Cut, Copy, and Paste Functions







Library items can be Cut, Copied, and Pasted from the screen drawing area to the Browser. First, select the desired Library item in the drawing area and Cut or Copy it; then, Paste it to the Library Browser.

2.4.3 Editing Library Items

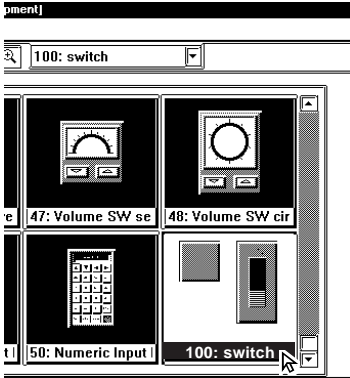
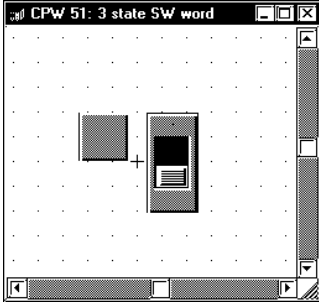
Library Items can be Edited, Deleted, Copied, Cut, or Pasted.

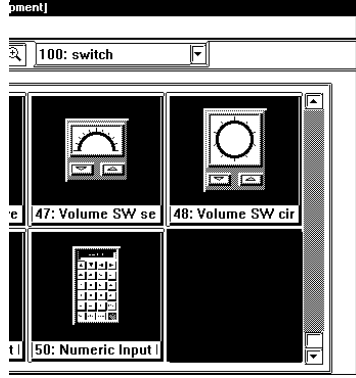

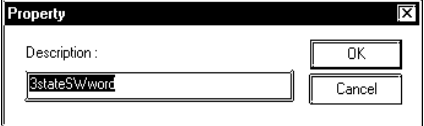

■ **Editing a Library Item**

Here, a registered Library item is edited.

| PROCEDURE | REMARKS |
|---|--|
| <p>(1) Select and double-click the Library item to be edited from the Browser.</p>  <p>(2) Edit that Library item.</p>  <p>(3) Via the Screen Editor, select the [Screen] menu - [Save] command, or click on the  icon on the Main Tool Bar.</p>  | <p>In order to call up a Library item from a Library file which is different from the currently displayed file, click on the  icon.</p> <p>Reference 2.4 Libraries Switching Library Files</p> <p>When double-clicking on a Library item's title, the title editing screen will appear. (Property Screen)</p>  <p> Important <i>Once an item is edited, it cannot be Undone.</i></p> |

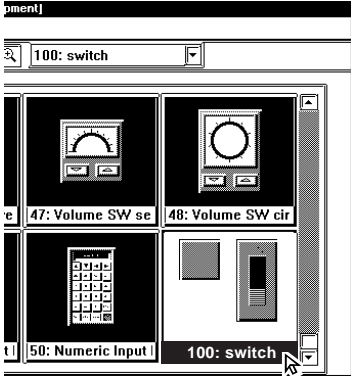
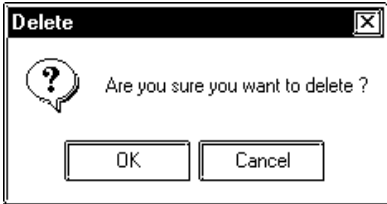
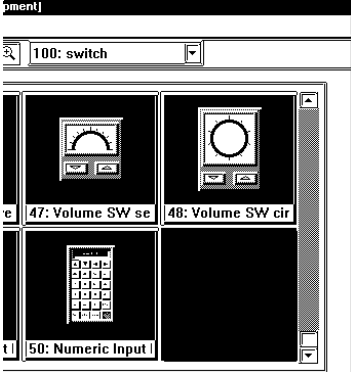





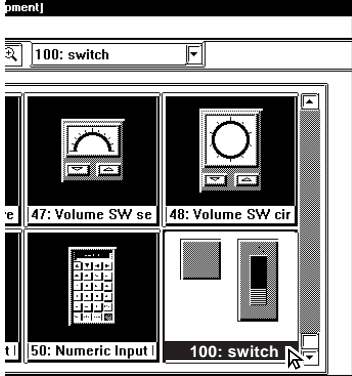

■ Deleting a Library Item

Here, a registered Library item is deleted.

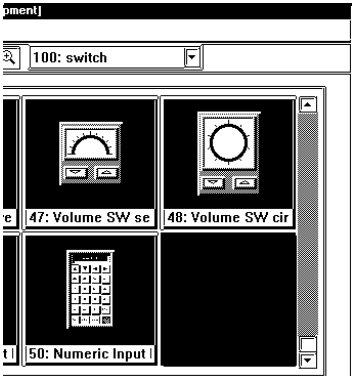
| PROCEDURE | REMARKS |
|--|---|
| <p>(1) Select the Library item to be deleted from the Browser.</p>  <p>(2) Select the [Delete] command from the Library Browser's [Edit] menu. A dialog box appears to confirm your command.</p>  <p>(3) Click on the <input type="button" value="OK"/> button, and the Library item will be deleted.</p>  | <p>In order to call up a Library item from a Library file which is different from the currently displayed file, click on the  icon.</p> <p>Reference  <i>2.4 Libraries</i> ■ Switching Library Files</p> <p> Important Once an item is deleted, it cannot be Undone.</p> |

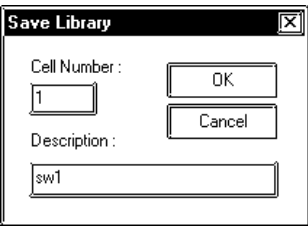
■ Cutting a Library Item (from a Library File) and Pasting





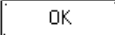
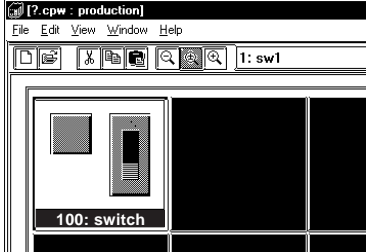

Here, a registered Library item is Cut and Pasted.

| PROCEDURE | REMARKS |
|--|---|
| <p>(1) Select a Library item to be cut (out) from the Browser.</p>  <p>(2) Via the Library Browser, select the [Edit] menu - [Cut] command, or click on the  icon. The selected Library will be cut.</p>  <p>(3) Open a desired Library file and, via the Library Browser, select the [Edit] menu - [Paste] command, or click on the  icon.</p> <p>The following steps are the same as those used for a Library Item registration.</p> <p>(4) Input the Item's Cell Number and Description.</p> <p>In the Register Number area, the smallest number in the currently open Library file's empty numbers will be automatically displayed. To change it, input the desired number.</p>  | <p>In order to call up a Library item from a Library file different than the currently displayed Library file, click on the  icon.</p> <p>▼ Reference ▲ <i>2.4 Libraries</i> ■ Switching Library Files</p> <p>To register the Library item to a new Library file, click on the  icon.</p> <p>To register the Library item to a Library file different from the currently displayed one, click on the  icon.</p> <p>▼ Reference ▲ <i>2.4 Libraries</i> ■ Switching Library Files</p> |

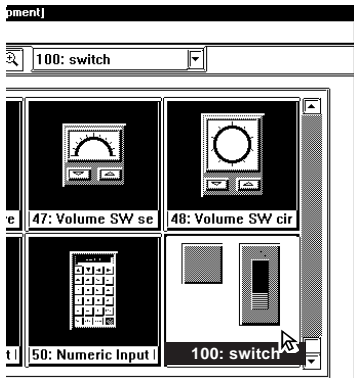
| PROCEDURE | REMARKS |
|--|---------|
| <p>(5) Click on the  button to register the Library Item.</p> <p>The registered Library will be displayed on the Browser.</p>  | |

■ Copying a Library Item

Here, a previously registered Library item will be copied.

| PROCEDURE | REMARKS |
|--|---|
| <p>(1) Open the desired Library Item's Library file and select the Library item from the Browser.</p>  <p>(2) Via the Library Browser, select the [Edit] menu - [Copy] command, or click on the  icon.</p> <p>The Library item will be copied to the Clipboard.</p> <p>(3) Open the destination Library file and select the [Edit] menu - [Paste] command, or click on the Library Browser's  icon.</p> | <p>In order to call up a Library item from a Library file different than the currently displayed Library file, click on the  icon.</p> <p>▼ Reference ▲ 2.4 Libraries ■ Switching Library Files</p> <p>To register the Library item to a new Library file, click on the  icon.</p> <p>To register the Library item to a Library file different than the current one, click on the  icon to call up a list of Library files.</p> <p>▼ Reference ▲ 2.4 Libraries ■ Switching Library Files</p> |

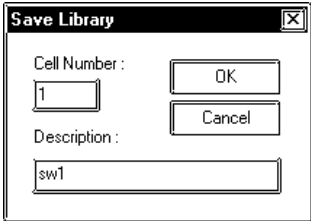
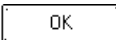
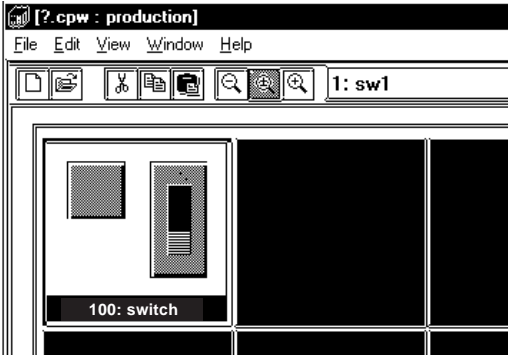
| PROCEDURE | REMARKS |
|--|---------|
| <p>Hereafter, steps are the same as Library Item Registration.</p> <p>(4) Input the Item's Cell Number and Description. In the Register Number area, the smallest of the currently open Library file's unused numbers will be automatically displayed. To change it, enter the desired number.</p>  <p>(5) Click on the  button to register the Item. The registered Item will appear in the Browser.</p>  | |

2.4.4 Saving Libraries and Quitting

When a Library file's contents are changed, the changed data will automatically overwrite the old data and be saved. However, if the Library file has been newly created, when you attempt to create or select another Library file, a prompt will appear asking if whether the new file is to be saved or not. When is clicked on, the [Save As...] Dialog box will appear.

■ Saving a Library File Under Another Name

Here, the Library File will be saved under a different name.

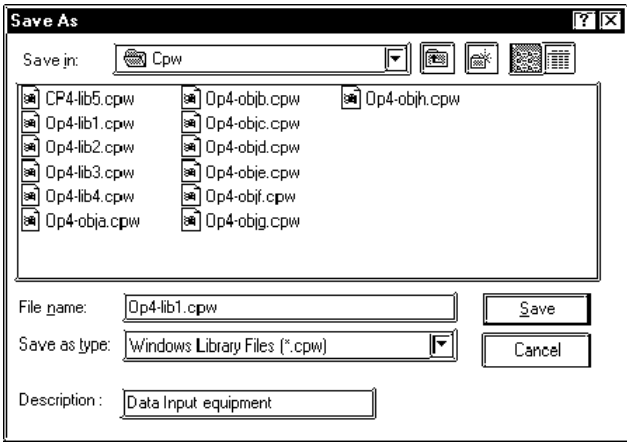
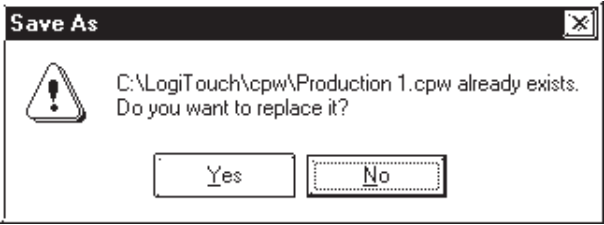
| PROCEDURE | REMARKS |
|---|--|
| <p>(1) Select the [Save As...] command from the Library Browser's [File] menu.</p> <p>(2) The currently selected Library file name and its comment data, if any, will appear. Input a new file name and change the desired settings.</p>  | <p>The file name can be input within 255 characters, including a path and extension.</p> |
| <p>(3) Click on the <input type="button" value="Save"/> button to save the Library. When a project with the same name already exists, a prompt asking whether the new name should overwrite the old name will appear; to do so, click on the <input type="button" value="Yes"/> button. When you do not want to overwrite, click on the <input type="button" value="No"/> button.</p>  | |

■ Quitting the Library Browser

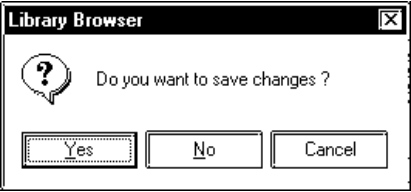
| PROCEDURE | REMARKS |
|--|--|
| <p>(1) Select the pull down menu [File]’s [Exit] command. If a newly created Library file has not been saved yet, a prompt asking whether the new Library file should be saved, will appear. When the <input type="button" value="Yes"/> button is clicked, the “Save As..” dialog box will appear, and when the <input type="button" value="No"/> button is clicked, the Library file will not be saved and the Library Browser will quit. Then, a Library file creation or selection screen will appear.</p>  | <p>Clicking on the Library Browser’s top right mark <input type="button" value="X"/> can also be used to quit.</p> <p>Reference <i>Saving a Library File Under Another Name</i></p> |

2.5

D-Script/Global D-Script

The LT Editor provides a special feature that enables you to create a program to execute functions, in addition to Parts. This feature is given by D-Scripts/Global D-Scripts. The display load on the External Device can be reduced significantly by creating and registering a program with D-Scripts/Global D-Scripts. D-Scripts are used on each screen and serve as programs that are only effective on that screen. Global D-Scripts serve as programs that are effective on all the screens.

Using D-Script, you can program separately the trigger used and the action it performs. Then, when the trigger conditions are satisfied, the script is performed. The procedures for writing a program with Global D-Scripts are the same as those for writing a program with D-Scripts.

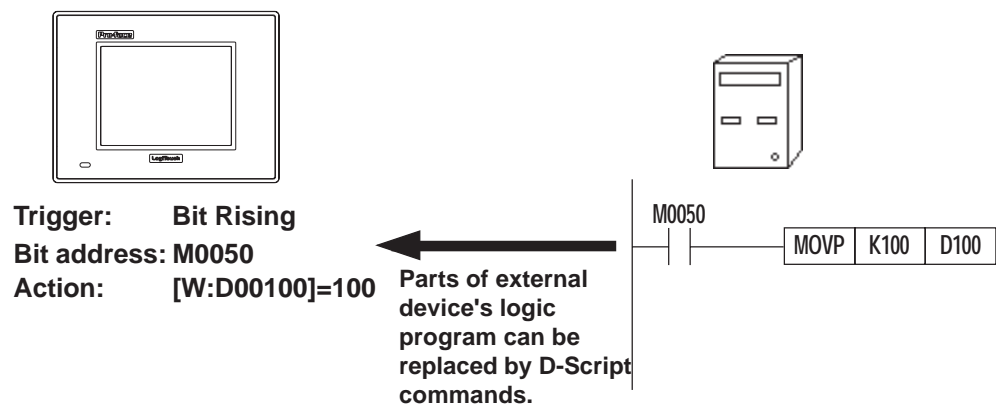

■ Overview

- To use D-Script for all of a project's screens, regardless of the current screen, select Global D-Script. To use the D-Script only for the currently displayed screen, select D-Script while creating that screen.
- D-Script allows you to perform Bin/BCD display format changes, text data changes, or other functions, all previously performed by the External Device, via the LT.
- Since D-Script is a language program, debugging can be performed easily.
- D-Script can be programmed as a trigger to sense the leading or falling edge of a bit, to activate a timer, or to detect true or false of a given condition.
- There are three elements in a D-Script, Operators, Statements, and Operands, which can be used to program conditions in the External Device.
- There are four types of commands: Drawing, Mathematical calculations, Boolean operations, and Bit operations.
- Syntax check is available during program creation.
- Syntax auxiliary function provides a pop-up keyboard for address settings to enhance programming efficiency.
- Programming commands can be entered via icons.



NEVER use the D-Script/Global D-Script function for the control of machines or actions which have the possibility of resulting in either operator injury or damage to equipment.



- *D-script and Global D-script cannot be registered as Libraries.*
- *To select [Global D-Script], open any Base screen in advance.*

2.5.1 D-Script Settings

D-Script can be added, edited and deleted on the D-Script list. D-Script is programmed with the D-Script Editor. For details of the D-Script's commands, please refer to 2.5.2.D-Script Commands

| Usage Pattern |
|---|
| [Special] → [D-Script] or [Global D-Script] → Add, Modify, or Delete → <input type="button" value="Close"/> or the key <input type="button" value="ESC"/> |

An example of the D-Script dialog box (the initial screen) is shown below.

Lists the D-Script ID numbers and descriptions

Adds a D-Script

Deletes a registered D-Script

Allows you to edit the contents of a D-Script

Copies the contents of a D-Script

Pastes the copied contents of a D-Script

■ Registering D-Script Editor

Here, additional D-Scripts can be registered. When the button is clicked on, the D-Script Editor will appear.

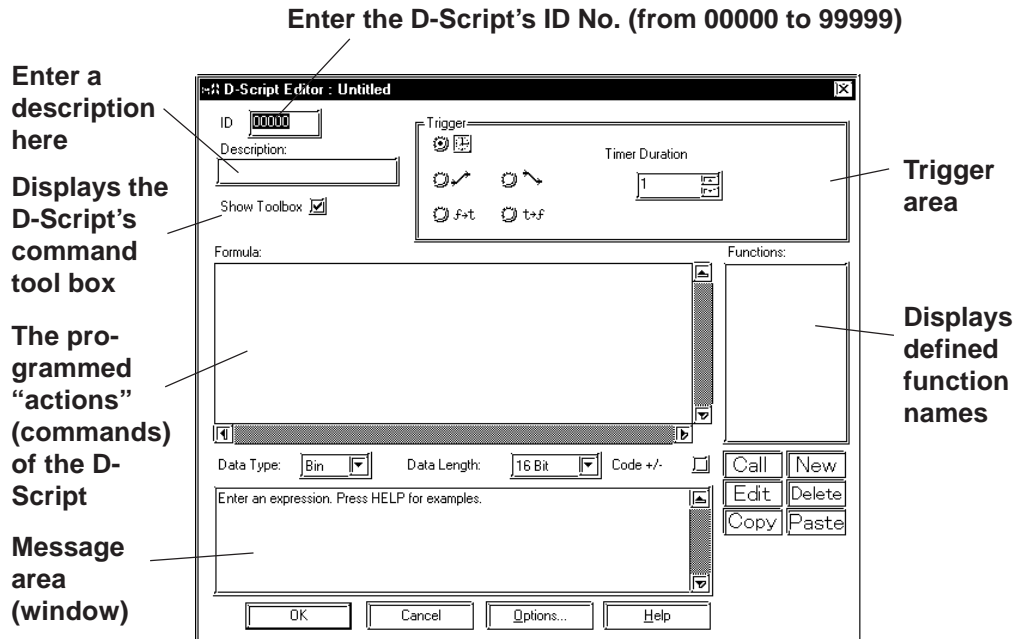

◆ ID

Each D-Script program is uniquely identified by an ID number. Enter an ID number in the range of 00000 to 99999.

◆ Description

Up to 20 Single-byte or 10 Double-byte characters can be entered here as a description about the D-Script you are to create.

◆ Show Toolbox

When checked, the tool box appears that contains the Operators, Statements, and Operands used to create the D-Script program.

◆ Data Type

Designates the D-Script data format as either Bin or BCD.

◆ Bit Length

Designates the D-Script data bit length as either 16 bits or 32 bits.

◆ +/- Code

Please refer to this table when entering negative numeric data.

| Data Format | Constant Entry | |
|-------------|----------------|------------|
| | Min. Value | Max. Value |
| Bin16 | 0 | 65535 |
| Bin32 | 0 | 4294967295 |
| Bin16+/- | -32768 | 32767 |
| Bin32+/- | -2147483648 | 2147483647 |
| BCD16 | 0 | 9999 |
| BCD32 | 0 | 99999999 |



When a D-Script's command follows another D-Script's command, enter a space between these commands.

For example, if the "not" command follows the "and" command, spacing is needed between the commands.

"andnot" : Incorrect (The operation will not be performed and an error message will display on the software screen.)

"and not" : Correct

■ Trigger

These selections designate the type of trigger used to activate your program. The possible options are "Timer", "Bit Rising", "Bit Falling", "Expression becomes Non-Zero", and "Expression becomes Zero."

◆ Timer Settings

When the designated time elapses, the statements described in the Action area of your program are performed. The timer duration can be set from 1 to 32767 seconds. The timer restarts its counting when the designated time elapses.

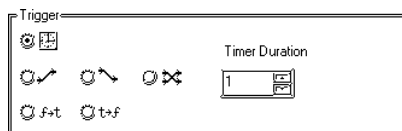

◆ Bit Rising

When the LT detects the designated bit change from 0 to 1, the statements described in the Action area are performed.

◆ Bit Falling

When the LT detects the falling edge of the designated bit, the statements described in the Action area are performed.

◆ Bit Dual Operation Trigger

When the LT detects the rising or the falling edge of the designated bit, the statements described in the Action area are performed.

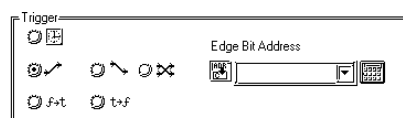

◆ **f → t (Expression becomes Non-Zero)**

When the LT detects true of a given condition in a triggering program, the statements described in the Action area are performed only one time at the detection.

◆ **t → f (Expression becomes Zero)**

When the LT detects false of a given condition in a triggering program, the statements described in the Action area are performed only one time at the detection.

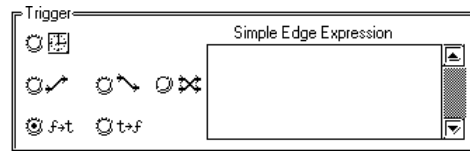

- **The bit designated for the “Bit Rising / Falling” option must be held ON or OFF for longer than the Part scanning time (stored in LS2036).**
- **Printing or drawing operation may cause a timer delay.**
- **The Timer feature, when a screen change is performed, will reset to “0” (with D-Script). When using Global D-Script, the timer continues the current counting.**
- **The timer may produce “designated time” or “Part scanning time” errors.**

▼ **Reference** External Device Connection Manual, “1.1.4/4.1.3 Special Relay”

- **Writing on the external device must be performed at an interval longer than a cycle time. If writing on the external device is frequently performed using a part scan counter of the special relay inside the LT as a trigger, communication errors may occur.**

■ **Functions**

A D-Script program can be created using Functions. A program created as a Function can be used on the same screen or on other screens. The Functions can be used commonly for D-Script and Global D-Script.

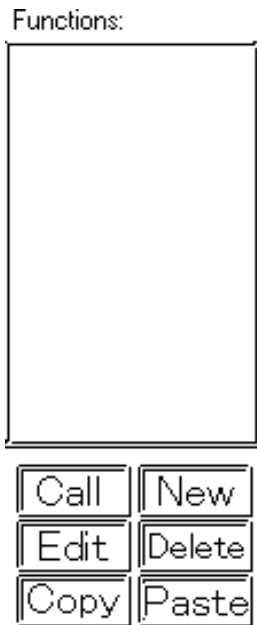

◆ **Call**

Select a Function name to be loaded and then click on this button. After clicking on the Load button, the called-up Function name will be displayed in the formula area.

◆ **Edit**

Select a Function name to be edited and then click on this button. Use the D-Script Function dialog box to perform editing.

◆ **Delete**

Click on this button to delete a created Function. First, select a Function name to be deleted and then click on the Delete button.

◆ **Copy**

Any selected function can be copied.

◆ **Paste**

Use this command to paste a copied function. Click on this button and the following dialog box will appear. Then, enter the name for the function to be pasted.

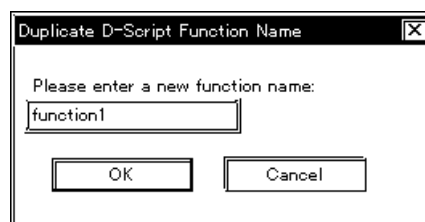

■ Definition of Functions

When the  icon is clicked on in the D-Script Editor, the D-Script function setting screen will appear.

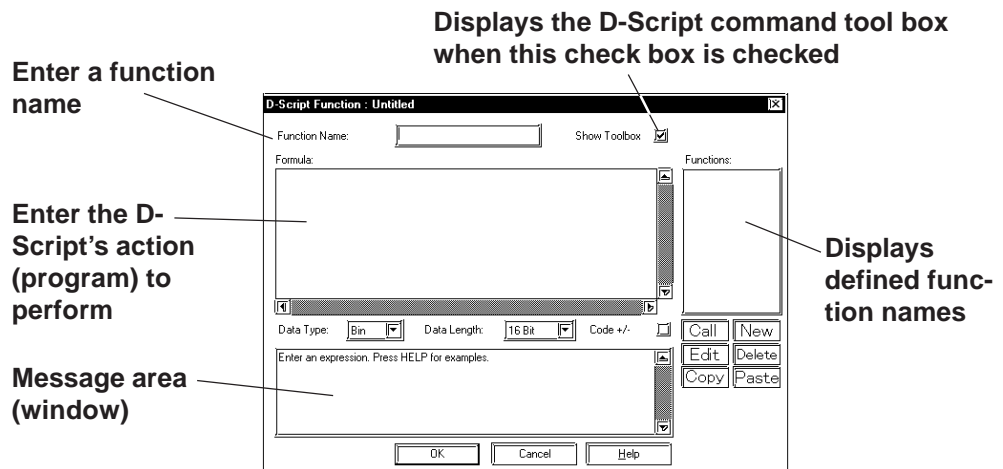

◆ Function Name

Enter the name of your Function here. Once a Function is created, that Function name is displayed in the Function area. Up to 20 characters can be used for a Function name. (Alphabet characters, numbers, and “_”)



The following function names are reserved. DO NOT use these names.

“rise”, “fall”, “rise_expr”, “timer”, “set”, “clear”, “toggle”, “if”, “else”, “endif”, “b_call”, “Bcall”, “dsp_rectangle”, “dsp_line”, “dsp_dot”, “dsp_circle”, “dsp_arc”, “Call”, “and”, “or”, “not”, “memcpy”, “memset”, “loop”, “break”, “IO-READ”, “IO-WRITE”

■ Deleting D-Script Settings

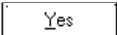
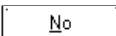
Here, existing D-Script settings can be deleted. After selecting the D-Script settings to be deleted from the listing, and clicking on the  button, the Confirm Script Delete dialog box will appear. When the  button is clicked on, the D-Script settings will be deleted. When the  button is clicked on, the deletion command will be canceled.

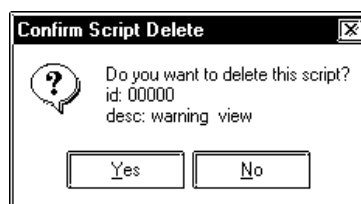

■ Editing D-Script Settings

Here, registered D-Script settings are changed. After selecting the D-Script settings to be changed from the D-Script list and clicking on the button, an additional registration screen will appear. Click on the button to change the D-Script settings. To cancel the Change command, click on the button.



- ***It is not possible to use the Project Manager [Utility]'s [Convert Address] area to modify addresses used in a D-Script. Any D-Script program that requires address conversion will need to be edited manually.***
- ***If the [Save As..] function has been used to change a project file's External Device, the D-Script program will not be able to automatically change those addresses.***
- ***Be sure to not use D-Script to perform any life-threatening, or possibly damaging actions!***

■ D-Script Settings: Copy and Paste

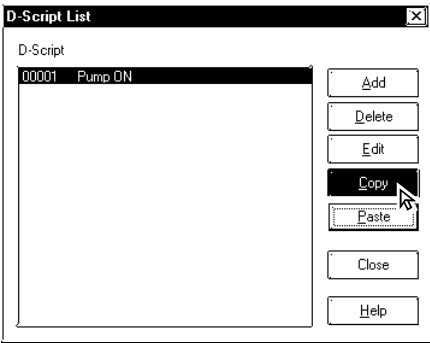
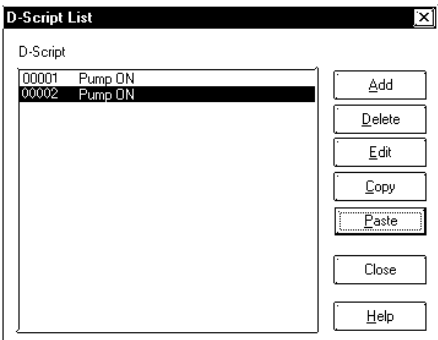
| PROCEDURE | REMARKS |
|--|--|
| <p>(1) Select the pull down [Special] menu's [D-Script] command.</p> <p>(2) Click on the <input type="button" value="Copy"/> button.</p>  <p>(3) When the <input type="button" value="Paste"/> button is clicked on, the D-Script copied in step (2) will be added. The D-Script's ID number will automatically be assigned to the smallest number currently available.</p>  | <p>This D-Script can also be copied to another screen.</p> |

2.5.2 D-Script Commands

You can enter D-Script commands, Statements and constants using D-Script tool box.

■ D-Script Tool Box

The D-Script tool box contains icons for D-Script commands and Statements and constant input icons.

When the tool box check box is checked, the following tool box will appear.

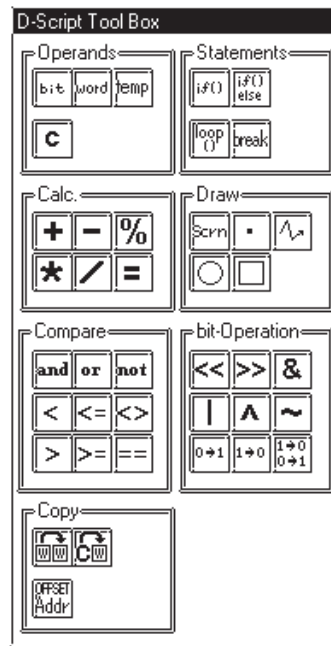

■ Operators

◆ Draw



This function is used to call up a previously registered Library Item. The designated screen (Base screen) will be called up at the designated X,Y coordinates.

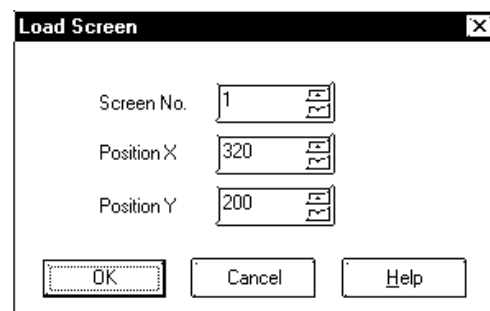

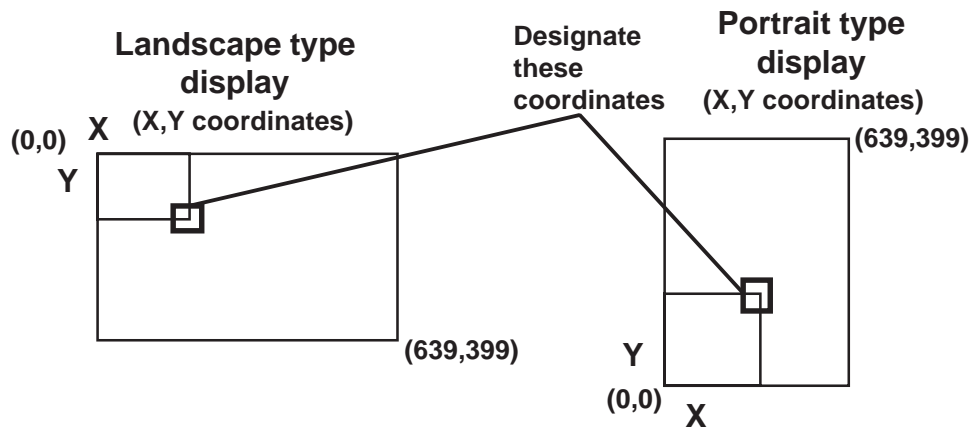

• **Dot**

Draws a dot at the designated point. Designate a dot type, its X,Y coordinates, and its display color. 2, 3, and 5 dot groups cannot be selected.

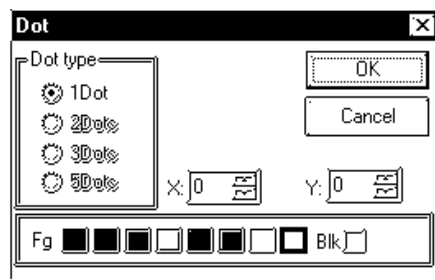

• **Polyline**

Draws a line at the designated position. Designate the line's type, color attributes, and start and end coordinates.

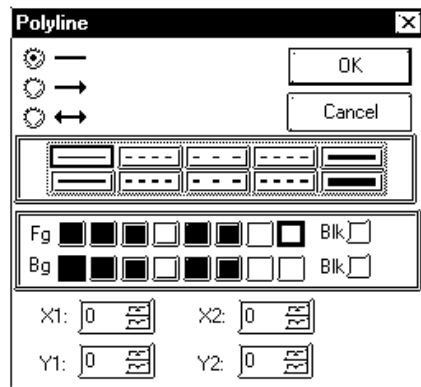

- **Circle**

Draws a circle at the designated point. When the Pattern check box is checked, a filled circle will be drawn.

Select and enter the line type (or fill pattern when selecting a pattern), color attributes, center coordinates, and radius value.

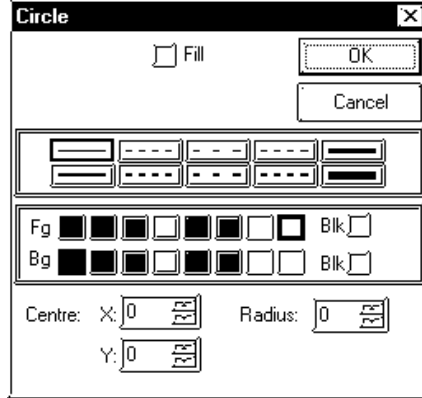

- **Square/Rectangle**

Draws a square at the designated position. When the Pattern check box is checked, a filled square will be drawn. When selecting a beveled square, a beveling dot can be entered. Select and enter the line type (or fill pattern when selecting a pattern), color attributes, and start and end coordinates.

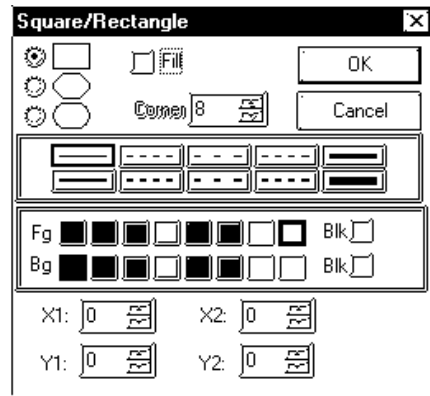

◆ **Math (Operators)**

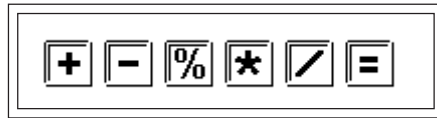

- **+ (Addition)**

Adds the data in two word addresses, or the data in a word address and a constant. Any overflowing digits resulting from the operation are rounded.

- **- (Subtraction)**

Performs subtraction on the data in two word addresses, or the data in a word address and a constant. Any overflowing digits resulting from the operation are rounded.

- **% (Remainder)**

Detects a remainder of a division performed on the data in two word addresses, or the data in a word address and a constant. The operation result may depend on the sign of the left and right sides.

- *** (Multiplication)**

Multiplies the data in two word addresses, or the data in a word address and a constant. Any overflowing digits resulting from the operation are rounded.

- **/ (Division)**

Performs division on the data in two word addresses, or the data in a word address and a constant. Decimal places and overflowing digits resulting from the operation are rounded.

- **= (Assign)**

Assigns the right side value in the left side. The left side can state a device address only, while the right side can describe both a device address and a constant. Any overflowing digits resulting from the operation are rounded.



Note: For details about overflowing digits, and errors and rounded decimal places resulting from a remainder operation:

▼ **Reference** ▲ “3.1.5 Notes on Operation Results”

◆ **Comparisons**

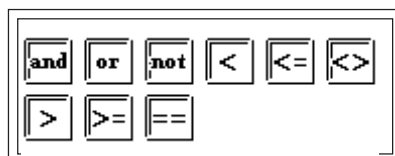

- **Boolean and (AND: Conjunction)**

ANDs the right and left sides. Value 0 (zero) is regarded as OFF, and other values, as ON. “N1 and N2” is true if both N1 and N2 are ON, and false if otherwise.

- **or (OR: Disjunction)**

ORs the right and left sides. Value 0 (zero) is regarded as OFF, and other values, as ON. “N1 or N2” is true if either N1 or N2 is ON, and false if otherwise.

- **not (NOT: Negation)**

NOTs the right side. Value 0 (zero) is regarded as 1, and other values, as 0. “not N1” is 0 if N1 is 1, and 1 if N1 is 0.

- **< (Smaller than)**

Compares the data in two word addresses, or the data in a word address and a constant. The result is true if N1 is smaller than N2 ($N1 < N2$).

- **<= (Equal to or smaller than)**

Compares the data in two word addresses, or the data in a word address and a constant. The result is true if N1 is equal to or smaller than N2 ($N1 <= N2$).

- **<> (Not equal)**

Compares the data in two word addresses, or the data in a word address and a constant. The result is true if N1 is not equal to N2 ($N1 <> (^1) N2$).

- **> (Greater than)**

Compares the data in two word addresses, or the data in a word address and a constant. The result is true if N1 is greater than N2 ($N1 > N2$).

- **>= (Equal to or greater than)**

Compares the data in two word addresses, or the data in a word address and a constant. The result is true if N1 is equal to or greater than N2 ($N1 >= N2$).

- **== (Equal)**

Compares the data in two word addresses, or the data in a word address and a constant. The result is true if N1 is equal to N2 ($N1 = N2$).



Note: For details about logical operations:

Reference “3.1.6 Logical Operation Examples”

- ◆ **Memory Control**

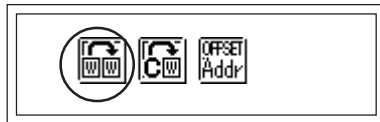

- **Memory Copy (memcpy)**

Memory Copy “memcpy”

Copies device memory all at once. Data for the number of Addresses will be copied to the copy destination Word Addresses beginning from the copy original Word Address. The number of Addresses effective is 1 to 640.

Format: memcpy ([Copy destination Word Address], [Copy original Word Address], the number of Addresses)

Example: When copying data of D0100 to D0109 to D0200 to D0209
 memcpy ([w:D0200], [w:0100], 10)



< Memory Copy (memcpy) >

- **Original copy data will be read from the External Device only once, when required. If a communication error occurs during data read, the LT's internal special relay LS2032's Bit 12 will be turned ON. When data read is completed normally, Bit 12 will be turned OFF.**
- **As the number of Addresses increases, the more time is required for writing data to the External Device. Depending on the number of Addresses, it may take from 20 seconds to several minutes.**
- **Although it will depend on the number of Addresses to be copied, data will be read from the original copy data, then divided into pieces and copied to the copy destination. Therefore, even if a communication error occurs during data read, data may be partially written.**
- **Unless data write is completed for the designated number of Addresses, screen displays such as Parts will not be updated or refreshed. Also, screen changes will not be performed.**
- **If data to be written exceeds the designated device range, a communication error occurs. In this case, you must turn the LT's power OFF and then ON again to reset the LT from the error.**
- **When the 32 bit device data is copied to a 16 bit device using D-script, and the bit length is designated as 16 bits, only the data for lower 16 bits will be copied.**

E.g.: memcpy ([w:w30.0100], [w:BD00100], 3)

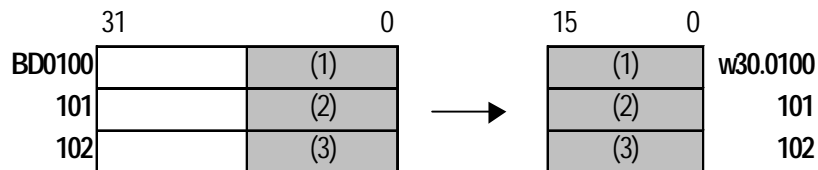

Also, when 16 bit device data is copied to a 32 bit device, the data for the lower 16 bits will be copied and "0" will be designated for the upper 16 bits.

E.g.: memcpy ([w:BD00100], [w:w30.0100])

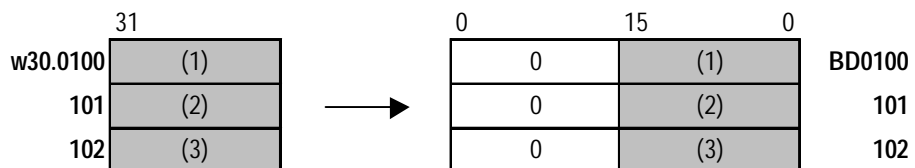

- **When 32 bit device data is copied to a 16 bit device, or when 16 bit device data is copied to a 32 bit device, if the D-script bit length designated in D-Script is 32, the copying will be as follows:**

E.g.: memcpy (W30.0100, BD0100,2)

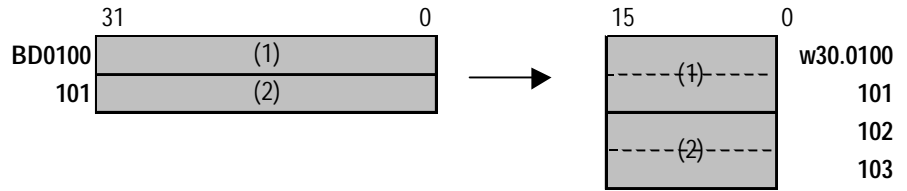

E.g.: memcpy (BD0100, W30.0100, 4)

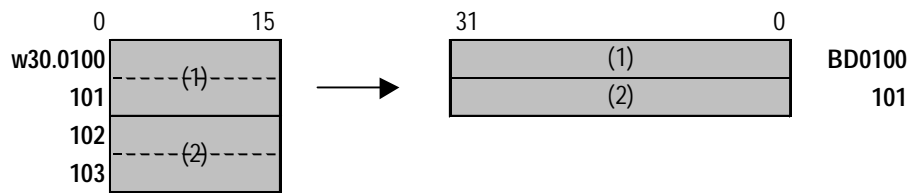

- **If the original and destination data ranges overlap, all overlapping data will be rewritten as follows:**

**E.g.: When copying “D101 to D104” to “D100 to D103”
(Data is copied to a smaller number Address)**

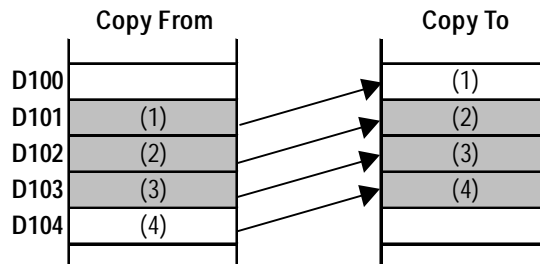

**E.g.: When copying “D100 to D103” to “D101 to D104”
(Data is copied to a larger number Address)**

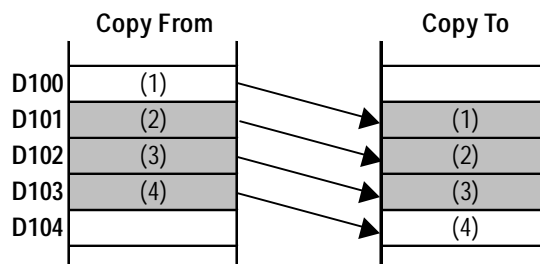

- **Although this example’s function designates 2 Addresses, these Addresses will not be counted as D-Script Addresses.**

- **When using device addresses for the Assign operation, the write values will not be assigned immediately, due to the LT to External Device transmission time.**

```
E.g.: memcpy ([w:D200], [w:D100], 10) // Copies "D100 to D109"
                                           // to "D200 to D209"
[w:D300] = [D200]                       // Assigns D200 data to D300.
```

In this case, D100's value to be written to D200 as the operation result has not yet been assigned to D300.

- **When a variable (Logic symbol) is used as an address, an integer array must be designated. For an integer array, an appropriate size required for consecutive addresses needs to be allocated.**

◆ Memory Set (memset)

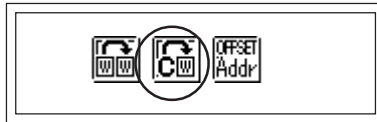

This feature initializes all devices at once. Setting data for the number of Addresses is taken from the Set Word Address. The allowable range of Addresses is from 1 to 640.

Format: memset ([Set Word Address], set data, number of Addresses)

Example: When "0" is set to addresses D0100 to D0109 - memset ([w:D0100], 0, 10)

< Memory Set (memset) >

- **As the number of Addresses increases, the more the time is required for writing data to the External Device. Depending on the number of Addresses, it may take from 20 seconds to several minutes.**
- **Although it will depend on the number of Addresses to be copied, data will be read from the original copy data, then divided into pieces and copied to the copy destination. Therefore, even if a communication error occurs during data read, data may be partially written.**
- **Unless data write is completed for the designated number of Addresses, screen displays such as Parts will not be updated or refreshed. Also, screen changes will not be performed.**
- **Although this function designates Address(es), they are not counted as D-script Address(es).**
- **When using device addresses for the Assign operation, the write values will not be assigned immediately, due to the LT to External Device transmission time.**

E.g.: memset ([w:D0100], 0, 10) // Initializes "D100 to D109" as 0
 [w:D200] = [w:D100] // Assigns D100 data to D200.

In this case, value 0 written to D100 as the operation result has not been assigned to D200 yet

- **When a variable (Logic symbol) is used as an address, an integer array must be designated. For an integer array, an appropriate size required for consecutive addresses needs to be allocated.**

◆ Offset Address

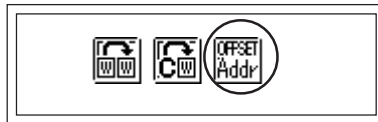

Offset Addresses can be designated.

Only temporary Word Addresses can be designated for offset value storage Addresses.

The offset Address format is as follows:
 (Word Address # Offset Value Storage Address)

<Constant Data Entry Ranges>

| Data Format | Constant | |
|-------------|-------------|------------|
| | Min. Value | Max. Value |
| Bin16 | 0 | 65535 |
| Bin32 | 0 | 4294967295 |
| Bin16+/- | -32768 | 32767 |
| Bin32+/- | -2147483648 | 2147483647 |
| BCD16 | 0 | 9999 |
| BCD32 | 0 | 99999999 |

E.g. Read → [w:D0200] = [w:D0100] # [t:0000]
 (Offset Word Address Read)

Write → [w:D0100] # [t:0000] = 100
 (Offset Word Address Write)

This Address becomes the Word Address + Temporary Word Address value. For the above example, when the value "2" is used for [t:000], the Address becomes [w:0102].



< Offset Address >

The device designated as storing the offset value is not always read from the External Device. It is read only when D-script processing is performed. If a communication error occurs during device read, the offset value will become 0, and the LT's internal special relay (LS2032 bit 12) is turned ON. When the data read is completed normally, this bit is turned OFF.

- **Clear Bit Address(1→0)**
Turns a bit OFF.
- **Toggle Bit Address(1→0 0→1)**
Toggles a bit between ON and OFF.



For details about bit operations:

Reference “3.1.7 Bit Operation Examples”

◆ Priority and Associativity

The following table shows the trigger priorities. If two or more operators have the same priority, follow the direction shown by the associativity.

| Priority | Operators | Associativity |
|-----------|--------------|---------------|
| High ↓ | () | → |
| | not, ~ | ← |
| | *, /, % | → |
| | +, - | → |
| | <<, >> | → |
| | <, <=, >, >= | → |
| | ==, <> | → |
| | &, ^, | → |
| | and, or | → |
| | ↑ Low | = |

■ Statements

◆ Branch

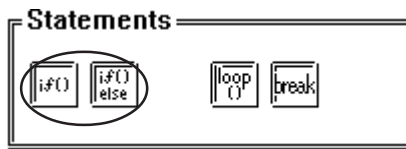

• if() if-endif

When a condition enclosed with brackets “()” becomes true, the process following the “if ()” statement is executed. The Assign “=” character cannot be used in a conditional expression.

• if()else if-else-endif

When a condition enclosed with brackets “()” becomes true, the process following the if “()” statement is executed. When the condition is false, the statement after “else” is executed. The Assign “=” cannot be used in a conditional expression.



Note: For details about the execution path:

Reference “3.1.8 Conditional Branches”

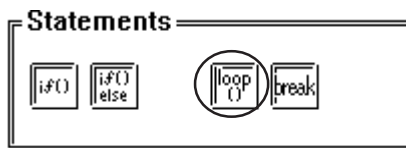

• loop() loop-endloop

Loop (repetitive) processing is repeated according to the number stored in the temporary Addresses designated in the brackets “()”.



• **The loop() format is as follows:**

E.g.

loop (number of loops) <= Designates the temporary Address where the loop repetition number is designated.

{
Mode equation

break <= Stated when escaping from the loop halfway (can be omitted)

} endloop <= Stated at the end of the loop

• **Only a temporary Word Address can be entered (in the parentheses). (e.g.: loop ([t:000]))**

• **“loop()” cannot be used for a trigger equation.**

- **The temporary Word Address value used to designate the “number of loops” will decrease every time loop operation is performed. When the value changes to 0, the loop’s operation is finished. If the temporary Word Address value designated for the “number of loops” is modified, the loop will become endless. Also, the temporary Word Address used is designated as Global. Therefore, simultaneously using this temporary Word Address for another item means the loop’s operation may be performed forever.**
- **Until loop operation finishes, screen displays of Parts, etc. will not be updated/refreshed.**
- **Only a temporary Word Address can be designated as the storage area for the “number of loops” value.**
- **The range available for the temporary Word Address value will differ depending on the data format (Bin, BCD), bit length, and code +/- used.**
- **loop() can also be nested. When it is nested, the inner-most loop() will be skipped via the “break” command.**

```

loop ([t:0000])//loop 1
{

    loop ([t:0001])//loop 2
    {

        break// Escape from loop 2
    }endloop

    break// Escape from loop 1
}endloop

```

- **If loop operation is finished without using the escape command, the temporary Word Address value becomes 0.**
- **The range available for the temporary Word Address value will differ depending on the data format (Bin, BCD), bit length, and code +/- used. If code +/- has been designated and the temporary Word Address becomes a negative value, the condition is judged at the beginning of the loop and the loop processing stops.**
- **DO NOT use a External Device device in the loop formula. Instead, use an address from the LT’s internal LS area’s user area device, or a temporary Word Address. For example, the following description preforms data write to the External Device many times in a short period (100 times in the following example). This can cause a system error since communication processing (the time required to write to the External Device) cannot be performed at this speed.**

E.g.

```
[t:0000] = 100 //Loop100 times
loop ([t:0000])
{
    [w:D0200] = [w:LS0100] //Write data to D0200
    [w:LS0100] = [w:LS0100] + 1 //Increment LS0100
} endloop
```

Change as follows:

```
[t:0000] = 100 //Loop100 times
loop ([t:0000])
{
    [w:LS200] = [w:LS0100] //Writes data to D0200
    [w:LS0100] = [w:LS0100] + 1 //Increment LS0100
} endloop
[w:D0200] = [w:LS0200] //Writes LS0200 data to D0200
```

• **If “loop” or “break” is used as a D-script function name, an error will occur.**

• **break**

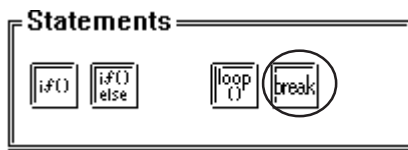

Halts loop operation while the loop() equation is being executed.



The “break” command can be used only in the { } section of loop().

■ Operands

◆ Address

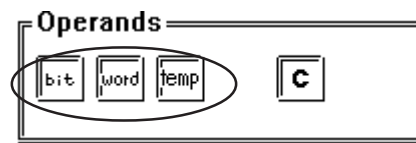

- **bit (address)**

Enter a bit address.

- **word (address)**

Enter a word address.

- **temp (temporary work address)**

Here, a LT internal Address is specified that can be used with the program. There are 90 words (from 0000 to 0089) available for Temporary Work Address. The Temporary Work Address's initial value is not fixed.

◆ Constant

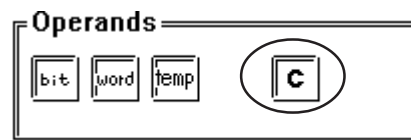

- **Constant**

Select a constant.



Note:

To identify data via the input data's format:

E.g.

Decimal: A numeric value without leading zeros →100

Hexadecimal: A numeric value preceding by 0x →0x100

Octal: A numeric value preceding by a zero →0100

Calculation examples in hexadecimal and BCD formats

Hexadecimal format only

0x270F & 0xFF00 The result is 0x2700

BCD and hexadecimal formats

9999 & 0xFF00 The result is 0x9900

2.5.3 D-Script / Global D-Script Limitations

◆ Limitations on BCD format operations

If a value which cannot be converted into BCD format is found during operation, the program stops running. These values include A to F in hexadecimal format. Do not use such values. If the program stops due to non-BCD values, bit 7 in common relay information (LS2032) in the LT turns ON. This bit does not turn OFF until the LT is turned OFF or goes offline.

E.g. $[w:D200] = ([w:D300]) \ll 2 + 80$

If D300 is 3, shifting two bits to the left results in 0x000C, which cannot be converted into BCD format interrupts program execution.

$[w:D200] = [w:D300] \ll 2$

If D300 is 3, shifting two bits to the left results in 0x000C.

Unlike the above example, 0x000C is the result of the operation to be stored in the memory, and does not cause the program to stop.

◆ Limitations of zero operations

Do not divide by zero in division (/) and remainder (*) operations. If you do, the program stops and bit 8 in common relay information (LS2032) turns ON. This bit does not turn OFF until the LT is turned OFF or goes offline.

◆ Notes on delay during assign operation

Using a device address in an assign operation may cause write delay because the LT has to read the address data from the External Device. Consider the following:

E.g. $[w:D200] = [w:D300] + 1 \dots (1)$

$[w:D201] = [w:D200] + 1 \dots (2)$

Statement (1) assigns (D300+1) into D200. However, in statement (2), the result of statement (1) has not been assigned in D200 because of time-consuming communication with the host (External Device). In such case, program so that the result of statement (1) is stored in the LS area before it is executed, as shown below.

$[w:LS100] = [w:D300] + 1$

$[w:D200] = [w:LS100]$

$[w:D201] = [w:LS100] + 1$

- As a guide for D-Script programming, three addresses occupy the same amount of memory as one Parts. The maximum number of addresses available for a script is 255. However, try to use the fewest possible addresses, since the more devices that are used, the slower the response.
- The Convert Address command in the Utility menu of the Project Manager cannot convert addresses used in D-Script. Open the D-Script Editor to change these addresses.

▼ **Reference** ▲ “4.2.3 Converting Addresses and Device Codes”

- If you have changed the external device, the addresses used by D-Script will not be converted. Be sure to use the D-Script Editor to change these addresses.

Reference “4.2.7 Changing Your Project’s External Device”

- The size of a D-Script affects the Parts scanning time. Note that using a large number of addresses may significantly degrade the performance of the program.
- Up to 9 levels of Functions can be called by a program. Do NOT create more than that.
- Up to 254 Functions can be created.
- D-Script operations activated by a trigger after the screen changes are as

| Trigger Conditions | Direct Access Method | | | | Memory Link Method | | | | |
|--------------------|----------------------------|---------|---------|-------|--------------------|---------|---------|-------|------|
| | Current Value or Condition | Bit "0" | Bit "1" | FALSE | TRUE | Bit "0" | Bit "1" | FALSE | TRUE |
| Bit rise | | X | ○ | - | - | X | X | - | - |
| Bit fall | | ○ | X | - | - | X | X | - | - |
| Bit Dual Operation | | ○ | ○ | - | - | X | X | - | - |
| Timer settings | | X | X | X | X | X | X | X | X |
| Detecting true | | - | - | X | ○ | - | - | X | ○ |
| Detecting false | | - | - | ○ | X | - | - | ○ | X |

○: Operation is performed right after the screen is changed, or the power is turned ON.

X: Operation is not performed right after the screen is changed, or the power is turned ON.

- * When the timer is operating, the timer starts counting right after the screen changes.
- * When using Global D-Script, the operations mentioned above are performed only when the LT’s power is turned ON. When the LT screen changes, however, the operation mentioned above will not be performed and the monitor operates using the trigger conditions that have been set.
- * When a Global D-Script includes a timer, the timer starts counting right after the LT’s power cord is connected.



Note:

Do not use the touch panel key to set the trigger bit or to operate the start bit in a program because the timing of the touch input may not be correct, resulting in the bit being improperly entered.

■ Limitations Specific to Global D-Script

- When the LT’s power is turned ON, the actions shown in the table above are performed. At the screen change, the above table is not applied, and the trigger conditions are continuously monitored.
- Global D-Script operation is suspended during screen changes or other LT operations.
- After the LT’s power is turned ON, Global D-Script actions are not performed until all data reads are completed for the initial screen. However, after the initial screen changes, Global-D-Script actions may be performed before the data reads are completed.
- The maximum number of devices in Global D-Script is 255. When this number exceeds 256, the D-Script does not function. Since these devices always read data regardless of the screens, be sure to use only the minimum number of device settings in your D-Script. Otherwise, operation performance can be degraded.
- The maximum number of Global D-Scripts available is 32. The currently used function also counts as one Global D-Script. When the number of the Global D-Scripts reaches 32, any new Global D-Scripts are ignored.

2.5.4 Notes on Operation Results**■ Overflowing Digits**

Overflowing digits resulting from operations are rounded.

E.g. When performing an operation on unsigned 16-bit data:

- $65535 + 1 = 0$ (Produces overflowing digits)
- $(65534 * 2) / 2 = 32766$ (Produces overflowing digits)
- $(65534 / 2) * 2 = 65534$ (Does not produce overflowing digits)

■ Difference of Residual Processing

The result of a residual processing depends on whether the left and right sides are signed or unsigned. When a remainder is produced by a division operation, an error may be created due to round up operation.

- E.g.
- $-9 \% 5 = -4$
 - $9 \% -5 = 4$

■ Rounded Decimal Places

Decimal places resulting from a division are rounded.

- E.g.
- $10 / 3 * 3 = 9$
 - $10 * 3 / 3 = 10$

■ Notes on Operating BCD data

A BCD-data operation which produces overflowing digits does not give the correct result.

2.5.5 Logical Operation Examples

■ Bit Operation Examples

- ◆ $((100 > 99) \text{ and } (200 \triangleleft 100))$

Result : ON

- ◆ $((100 > 99) \text{ and } (200 \triangleleft 200))$

Result : OFF

- ◆ $((100 > 99) \text{ or } (200 \triangleleft 200))$

Result : ON

- ◆ $((100 < 99) \text{ or } (200 \triangleleft 200))$

Result : OFF

- ◆ $\text{not}(100 > 99)$

Result : OFF

- ◆ $\text{not}(100 < 99)$

Result : ON

- ◆ $[w:D200] < 10$

Result : True if D200 is smaller than 10.(ON)

- ◆ $\text{not}[w:D200]$

Result : True if D200 is 0.(ON)

- ◆ $([w:D200] == 2) \text{ or } ([w:D200] == 5)$

Result : True if D200 is 2 or 5.(ON)

- ◆ $([w:D200] < 5) \text{ and } ([w:D300] < 8)$

Result : True if D200 is smaller than 5, and D300 is smaller than 8.(ON)

False = (OFF)

2.5.6 Bit Operation Examples

■ This section gives examples of bit operations.

◆ [w:D200] << 4

Result: The data in D200 is shifted 4 bits to the left.

◆ [w:D200] >> 4

Result: The data in D200 is shifted 4 bits to the right.

◆ 12 (0000Ch) is stored in D301, using the BIN format.

[w:D200] = [w:D300] >> [w:D301]

Result : The data in D300 is shifted 12 bits to the right and assigned to D200.

◆ Bit AND

| | |
|-----------------|-----------------|
| 0 & 0 | Result : 0 |
| 0 & 1 | Result : 0 |
| 1 & 1 | Result : 1 |
| 0x1234 & 0xF0F0 | Result : 0x1030 |

◆ Bit OR

| | |
|-----------------|-----------------|
| 0 0 | Result : 0 |
| 0 1 | Result : 1 |
| 1 1 | Result : 1 |
| 0x1234 0x9999 | Result : 0x9BBB |

◆ Bit XOR

| | |
|-------|------------|
| 0 ^ 0 | Result : 0 |
| 0 ^ 1 | Result : 1 |
| 1 ^ 1 | Result : 0 |

◆ Bit One's complement (NOT) (When the data format is Bin16 +.)

| | |
|-----|-----------------|
| ~ 0 | Result : 0xFFFF |
| ~ 1 | Result : 0xFFFE |

2.5.7 Conditional Branches

■ Control Branches Using “if-endif” and “if-else-endif”

◆ if-endif

```
if (condition)
{Process 1}
endif
```

If the condition is true, process 1 is executed. If false, process 1 is ignored.

```
E.g.      if ( [w:D200] < 5)
{
           [w:D100] = 1
}
endif
```

If the data in D200 is smaller than 5, 1 is assigned in D100.

◆ if-else-endif

```
if (condition)
{Process 1}
else
{Process 2}
endif
```

If the condition is true, process 1 is executed. If false, process 2 is executed.

```
E.g.  if ( [w:D200] < 5)
{
           [w:D100] = 1
}
else
{
           [w:D100] = 0
}
endif
```

If the data in D200 is smaller than 5, 1 is substituted in D100. Otherwise, 0 is substituted in D100.

2.5.8 Application Example

In this example, we create a program for a temperature management system, which checks an error bit in the host (External Device) to detect the temperature 70° or above and 30° or below. If an error is found, the LT displays alarm messages accordingly. This system also counts the detected errors.

Error bit : M0001
 Temperature information : D200
 Error counter (70C° or above) : LS300
 Error counter (30C° or below) : LS301
 Alarm message screen number storage address : LS302

(1) From the [Special] menu, select the [D-script] option.



(2) When the D-Script List appears, click on the [Add] button.

The D-Script Editor will appear.

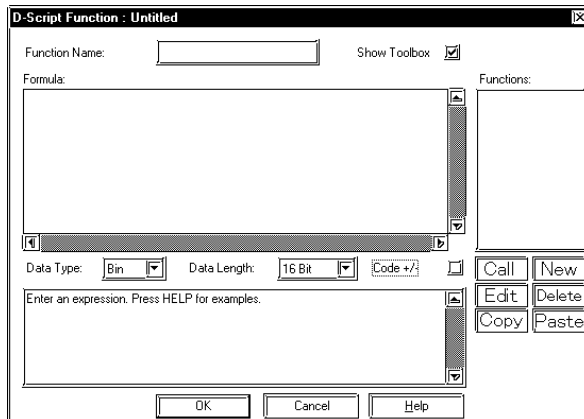
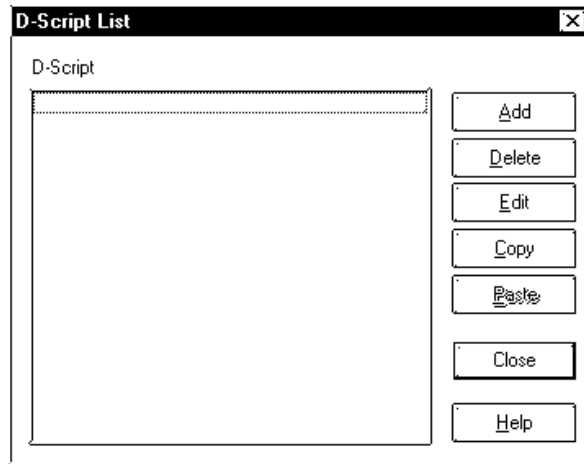

(3) Enter an ID number and Description.

In this example, enter “00000” in the ID field, and enter “Alarm Display” in the Description field.

ID

Description:

(4) Select a trigger type.

In this example, select the “Bit Rising” (left side) option and designate a bit address “M0001.”

Trigger

Edge Bit Address

(5) Create a program in the Action area by clicking the buttons in the Operators, Statements, and Operands areas.

Action

```
if ([w:D0200] >=70)
{
[w:LS00302]=100
[w:LS00300]=[w:LS00300]+1
}
endif
```

Program Example

```
if([w:D200]>=70)
{
[w:LS302]=100 //If 70C° or above //70C°-or-above alarm message screen No.100 //assigned
[w:LS300]=[w:LS300]+1 //Count up errors
}
endif
if([w:D200]<=30)
{
[w:LS302]=101 //If 30C° or below //30C°-or-below alarm message screen //No.101 assigned
[w:LS301]=[w:LS301]+1 //Count up errors
}
endif
```

(6) Click on the OK button.

The ID number and description you have entered will appear in the D-Script List window.

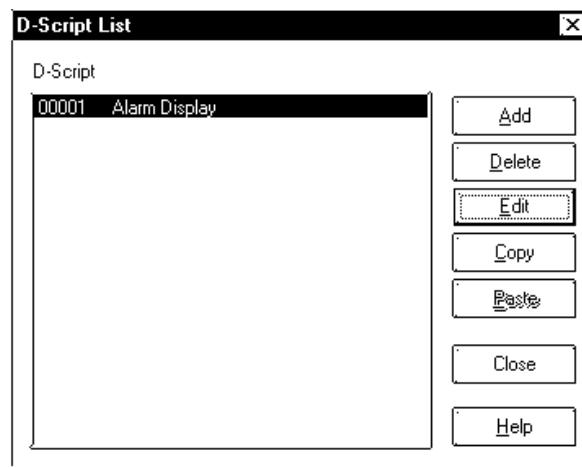

2.6 Data Sampling

Designated address data is sampled and stored (backed up) in the LT unit. When using this function for a graph (Part)'s channel, Trend graph data can also be stored (backed up).

Up to 20 sets of Data Sampling can be entered, including the number of channels; the setting attributes can also be confirmed in the [Data Sampling Settings] of the [View] menu.

Reference 2.7.6 Data Sampling List

Overview

- The specified Word Address data is sampled each specified time or with a desired time cycle and stored it into the LS Area via the trigger bit.
- Data can be sampled per word, and data for up to 640 words can be stored in series.
- Sampled data can now be backed up. The backed up data can be stored in the LS Area via the Trigger Bit.
- Decide a channel name for each piece of sampling data.
- The number of channels that can be set is up to 20 for the entire system including trend graph channels. When more than 20 channels are set, channels after 20th will be disregarded according to the following rules:
 - Data sampling will be given priority over trend graphs.
 - Data sampling channel numbering will begin from those set previously.

2.6.1 Data Sampling Settings



An example of the Data Sampling Setting dialog box is shown below.

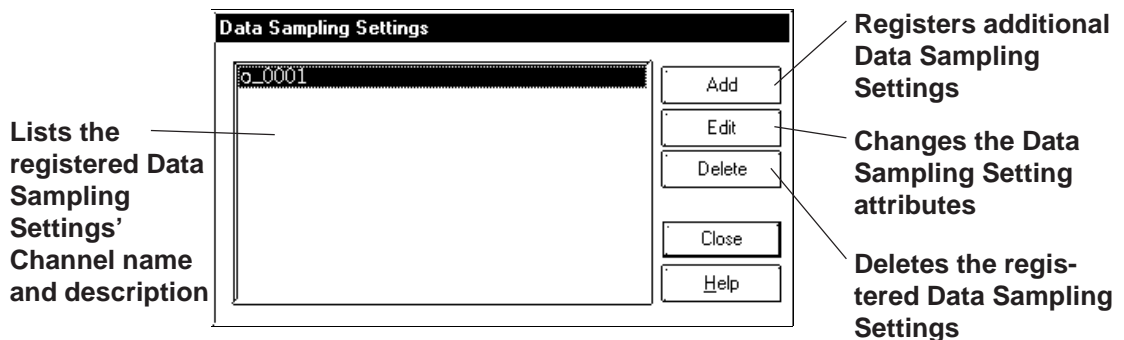

■ **Registering Data Sampling Settings**

Additional Data Sampling Settings are registered.

When the  button is clicked on, the Data Sampling Setting screen will appear.

■ **General**

The General page provides information about the current channel settings for the Trend Graph Display.

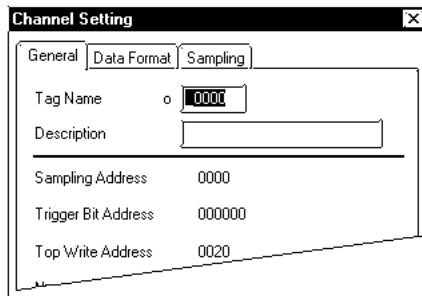

Channel Name

Must be no more than five Single-byte or two Double-byte characters long and composed of letters and/or symbols.

Description

Up to 20 Single-byte or 10 Double-byte characters can be entered as a description.

■ **Data Format**

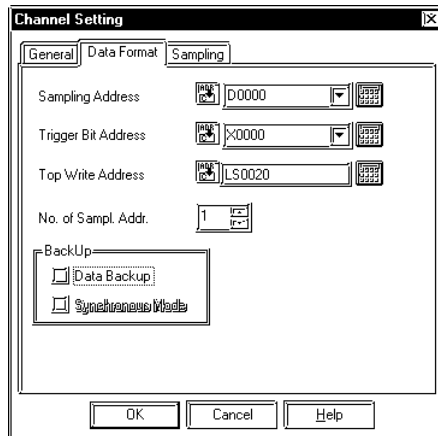

Sampling Address

Designates the Word Address to be sampled.

Trigger Bit Address

When the bit address stored here turns ON, the sampled data will be stored into the LS Area.

Top Write Address

Specifies the LS Area's data storage start address. LS0000 to LS0019 cannot be used since they are the system area. The "Start address + Sampling data count + 1" must not exceed LS2031.

No. of Sampl. Addr.

Designates the number of sampled data (items) to be stored.



When a variable (Logic Symbol) is used as a Top Write Address, an integer array must be designated. For an integer array, an appropriate size required for consecutive addresses needs to be allocated.

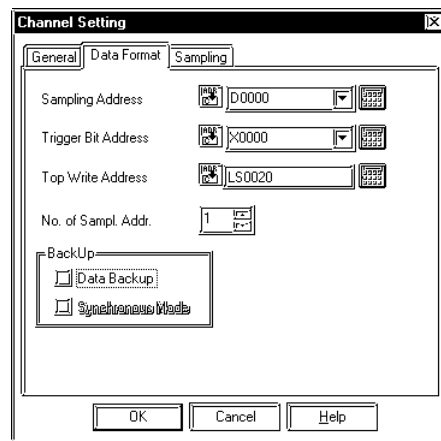

BackUp

Data Backup

The sampled data will be backed up in the LT's backup memory.

Synchronous Mode

With this mode selected, when the LT's power is turned ON, data will be sampled following that data stored before the LT's power was turned OFF. With this mode unselected, when the LT's power is turned ON, data sampling will start from the value "0". For normal operation, select this mode.



Data stored in the backup SRAM is erased when:

- The memory is initialized.
- Screen data is transmitted.
- The LT system and protocol are set up.
- The LT self-diagnosis "Internal FEPROM (screen area)" is performed.

◆ **Data Storage Example**

The following is an example of data stored from the storage start address. When the trigger bit is turned ON, the data is stored into the LS Area.

- The stored data count is stored in the storage start address.
- The stored data count number "n" is in the Bin format.
- When the stored data count is less than the sampling data count, the Word Addresses up to that number will be cleared to "0".

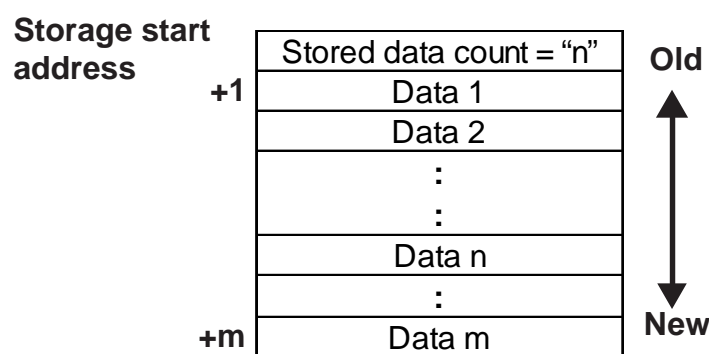

m = Sampling data count

■ Sampling

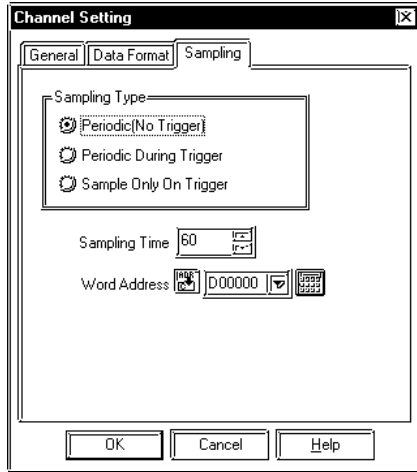

Sampling Type

The method to import data from the host (External Device) is specified from the following: Periodic, Trigger Control, and Trigger Sampling.

Periodic (No Trigger)

The host (External Device) data is imported at the setup intervals starting from when the LT is powered up.

Periodic During Trigger

The host (External Device) data is imported at the setup intervals. The data import start, pause, and clear commands will be performed according to changes to the corresponding bit in the specified Word Address.

Sample Only On Trigger

The data is sampled at the desired timing setup. Data import and data clear will be performed according to changes to the corresponding bit in the setup Word Address.

Sampling Time

Specifies the sampling time, in 1 second units, for the import of host (External Device) data.

Word Address (When Periodic During Trigger option is selected)

The 00 and 01 bits of the Word Address specified here will control the data import start, pause, and clear operations.

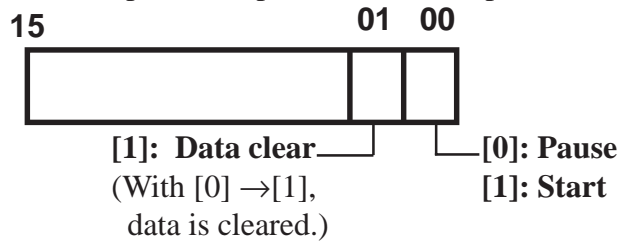

Word Address (When Sample Only On Trigger option is selected)

The 00 and 01 bits of the Word Address settings control the Data Read Start and Clear operations.

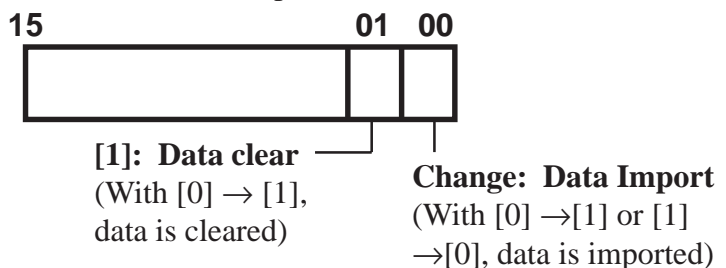



Please wait until the LT confirms the status of the control bits - i.e. whether they are "0" or "1" (For Direct Access communication, either the communication cycle time or 50ms, whichever is longer).



A delay of up to 1 second may occur from the time of data import start to actual data sampling.

■ Deleting Data Sampling Settings

Here, the registered Data Sampling Settings can be deleted. Select a Data Sampling to be deleted from the list. When the button is clicked on, a dialog box will appear to confirm your command. If you click on the

button, the Data Sampling will be deleted; if you click on the

button, the deletion will be canceled.

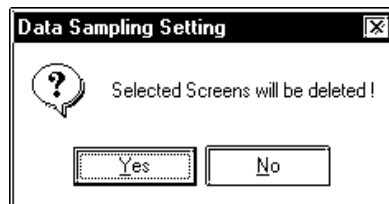

■ Editing Data Sampling Settings

Here, the registered Data Sampling Setting attributes can be changed. Select a Data Sampling to be changed from the list. When the button is clicked on, the Add (registration) dialog box will appear. If you click on the

button, the Data Sampling setting attributes will be changed, and if

you click on the button, editing will be canceled.

■ Setting Up Data Sampling

The Data Sampling setup procedure is shown below.

Data Sampling samples data stored in D0102 and stores it in the LS0020 LS area.

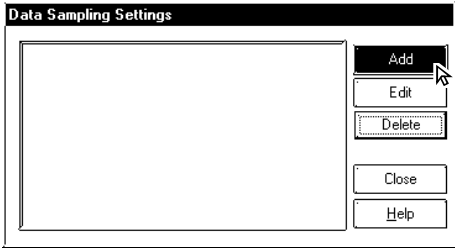
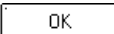
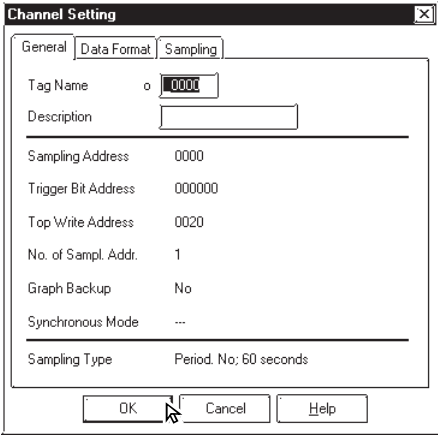
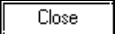
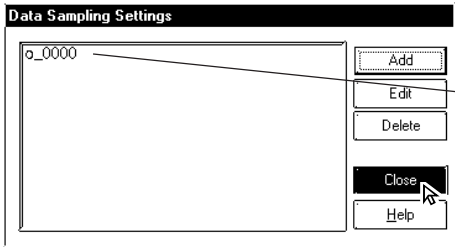
| PROCEDURE | REMARKS |
|---|--|
| <p>(1) Select [Data Sampling] from the [Special] pull down menu.</p> <p>(2) Click on the  button.</p>  <p>(3) Perform the data sampling settings. After the settings are all completed, click on the  button.</p>  <p>(4) Click on the  button to quit the registration.</p>  <p style="margin-left: 400px;">Displays the registered items</p> | <p>Up to 20 Data Sampling sets, including Trend graph channels, can be entered.</p> <p>Enter a Channel name of up to 5 characters.</p> |

2.7 Efficient Drawing Techniques

This section explains how the use of grids, changing display states, and the help function can all help to increase your drawing efficiency.

2.7.1 Grid/Snap

Grid Points are placed at regular intervals on your screen and divide the drawing area into a coordinate “grid” pattern; when the Snap to Grid function is enabled, objects that are drawn will automatically “snap” (be aligned) on this “grid” pattern. Use the Grid Point Spacing command to adjust the density of the Grid points, and to display the grid or not. Also, grid points can be displayed as grid lines, not as dots. Grid Points are not shown on the LT unit’s display.

Select the pull down menu [Option]’s [Grid/Snap] command.

■ Grid/Snap Settings dialog box

The screenshot shows the 'Grid/Snap Settings' dialog box with the following annotated components:

- Display:** A checked checkbox labeled 'Display' with an annotation: 'Turns the display of the Grid Points ON or OFF'.
- Orientation:** Radio buttons for 'Bottom' (selected) and 'Top' with an annotation: 'Designates the Grid Point display's being drawn on top of, or under, screen objects'.
- Snap:** An unchecked checkbox labeled 'Snap' with an annotation: 'Turns the Snap function ON or OFF'.
- Grid Spacing List:** A list box containing:
 - 1) 20 X 20 (highlighted)
 - 2) 40 X 40
 - 3) 8 X 16
 - 4) 16 X 16
 - 5) 32 X 32
 with an annotation: 'Registers a Grid pattern.' and 'Registers the grid pattern that has been designated in Spacing to the position highlighted in the Grid Spacing List.'
- Change:** A button below the list box.
- Spacing:** Input fields for X (3-319) and Y (3-199), both set to 20, with an annotation: 'Enters the desired Grid Point spacing'.
- Touch Area:** An unchecked checkbox with an annotation: 'Sets up the grid to the optimal 20 x 20 dot size'.
- Grid Shift Start Point:** Input fields for X (320) and Y (240), and a dropdown set to 'Standard', with an annotation: 'Enter the coordinate for the start point.' and 'Set the start point in a center area that is to be the start point for calling up the screen. (The start point is set as the default value.)'
- Style:** Radio buttons for 'Dot' (selected) and 'Line' with an annotation: 'Designates the grid display style, i.e. as dots or grid lines.'
- Buttons:** 'OK', 'Cancel', and 'Help' buttons at the bottom.

◆ Display

Sets the Grid Point display state (displayed or not displayed).

Grid pattern display can also be changed in the Grid Tool Bar’s grid pattern selection list box.

◆ Snap

When the Snap check box is checked, the cursor will “snap” to the grid; objects can only be drawn on points (start & end) along the grid.



Turning the Snap function ON or OFF can also be performed via the Grid/Snap Tool Bar's icons  and .

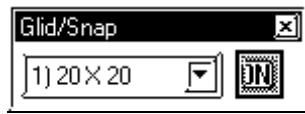

◆ **Spacing**

The Grid Point intervals are entered here. The unit is a dot. Input the interval value for the X and Y axes, respectively. The default value is 20 dots.

When clicking on [Touch Area], a 20 x 20 dot spacing will be automatically designated, which is most suitable for the touch panel.

Select a desired grid pattern in Spacing and click on the button. Then, the selected grid pattern will be reflected to the current screen and will also be displayed as the 6th selection of the Grid Tool Bar's grid pattern selection list.

◆ **Grid Spacing List**

Clicking on the button changes Grid Spacing List's highlighted set value to Spacing's set value and registers it.

The grid patterns registered here will be displayed on the Grid Tool Bar's grid pattern selection list box. A grid pattern selected from the grid pattern selection list box will be reflected to the current screen.

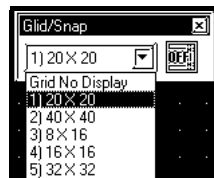

◆ **Grid Shift Start Point**

The Grid Shift Start Point is entered here. The default setting has the start point in the center of the screen. Pressing the button returns the start point to the center of the screen.

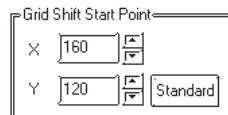

◆ Style

Select grid pattern display style from “Dot” and “Line”.

<When selecting Dot:>

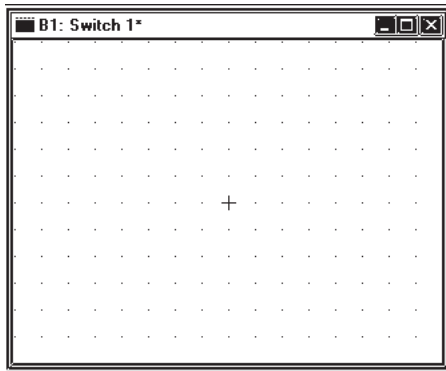

<When selecting Line:>

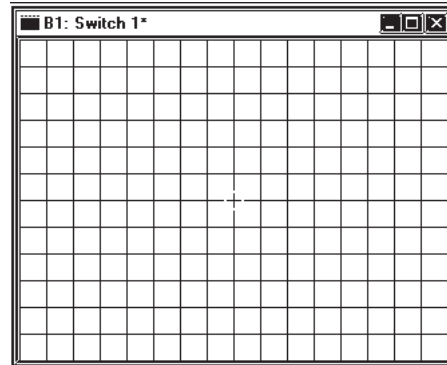

2.7.2 Screen Property Settings

Here, the screen display’s environment is set up, which effects both the method used to draw screens and displaying the Part addresses. The user’s work environment can be modified whenever necessary, helping to reduce the time required for drawing.

Select the pull down menu [Option]’s [Screen Property] command.

■ **Setting Screen Property - [Display]**

The display state (displayed or not) of the items such as object Fill and setting information on Parts can be selected on the screen Editor. Check the box of the items to be displayed. When a box is not checked, that item will not be displayed.

The settings on this screen will be applied to all the screens. Properties cannot be set up for individual screens.

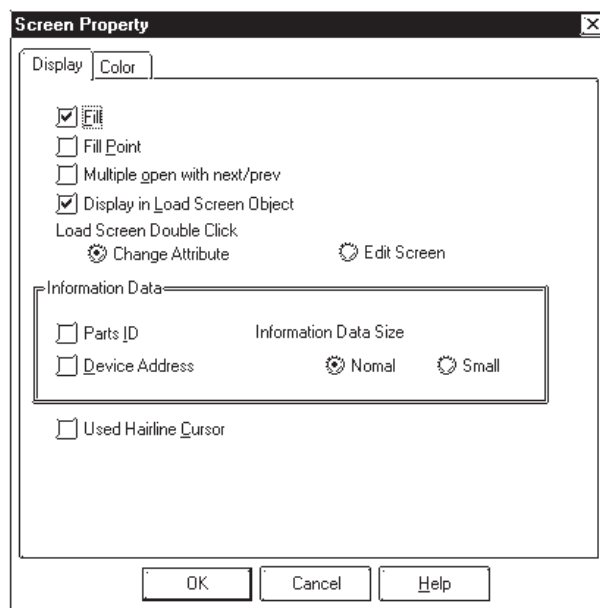



Note: The display state of ID numbers and Addresses can also be changed via the [Option] tool bar icons.

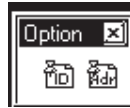

◆ Fill

When creating a screen, the drawing can be controlled so that any Fills used will either be displayed or not. If the “Fill” check box is not checked, all Fills are not shown. Using this feature will help you to speed up screen redrawing time, and thus speed up screen creation.



When the “Fill” check box is not checked, the actual screen shown on the LT unit may differ from the screen shown on your PC. To be sure the display is correct, check the “Fill” check box ON at least once, to verify the screen, before sending screen data to the LT.

◆ Fill Point

When this feature is selected, specified Fill points will appear with an “X” mark, which is especially useful when selecting Fill points.

If the Fill Points are not displayed, Fill cannot be performed while editing.



Note: The X (cursor position) mark’s color can be designated in the system’s [Color] area.

◆ Multiple Open with Next/Prev

When selecting [Previous Screen]/[Next Screen] from the [Screen] menu, or opening a screen with the Open Screen switch , specify whether the next screen is opened with the currently active screen open or after that active screen is closed. Up to 20 screens may be opened continuously.

◆ Display in Load Screen Object

You can specify whether Part addresses and ID numbers on a screen which has been called up using the [Load Screen] command are displayed or hidden.

◆ Load Screen Double Click

Specify an edit method for editing a screen that has been called up on another screen where the [Load Screen] command was executed, or for editing a screen on the Screen List.

If [Change Attribute] is specified, the Load Screen dialog box will be opened, enabling you to select a screen to be called up (screen number).

If [Edit Screen] is specified, the screen that has been called up will be opened, allowing you to edit the data.

◆Parts ID

Designates whether or not a Part's ID number is displayed on the Base screen.

◆Device Address

Designates whether or not Part Addresses are displayed on the Base screen. Part Addresses appear below the ID number.

◆Information Data Size

Selects the character size displayed from Standard (half size) and Minimized (1/4 size) for ID No. and Address.

◆Used Hairline Cursor

Changes the arrow cursor to the hairline cursor.

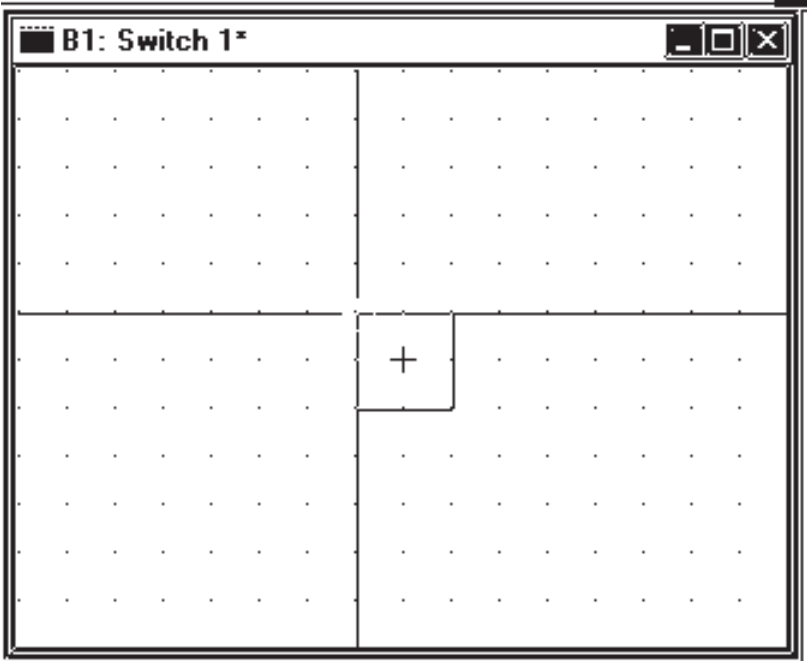

■ Setting Screen Property - [Color]

Select the Grid, Fill Point, and Screen Background colors here. When the drawn image data's and system's colors are the same, the screens will be hard to see. Here, these colors can be changed to remedy that.

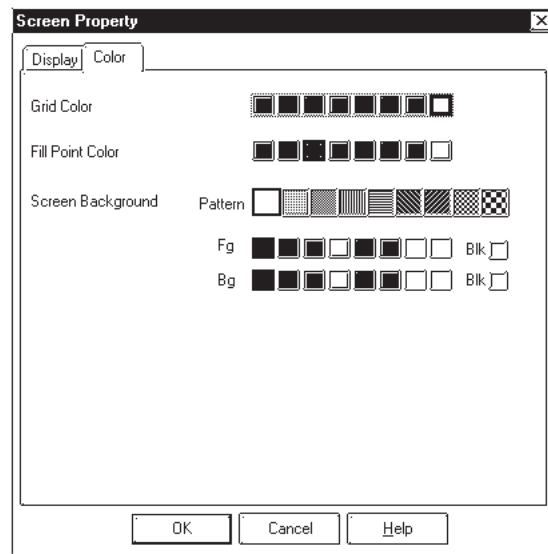

◆ Grid Color

Selects the grid point's color.

◆ Fill Point Color

Fill Points designate the point where a fill will begin; this setting determines the color of the fill point.

◆ Screen Background

Select the Base screen's background color; the color selected here is also displayed on the LT.



- ***If any background color is specified for the screen to be loaded, no on-screen object will be displayed on the LT unit.***
- ***To load a screen whose background color was specified, specify the loading position at the center of the screen.***

2.7.3 Preview Screen

With this feature, you can confirm how an image will appear on the LT unit. This image will differ depending on each LT display device type. Select the [View] menu's [Preview] selection.

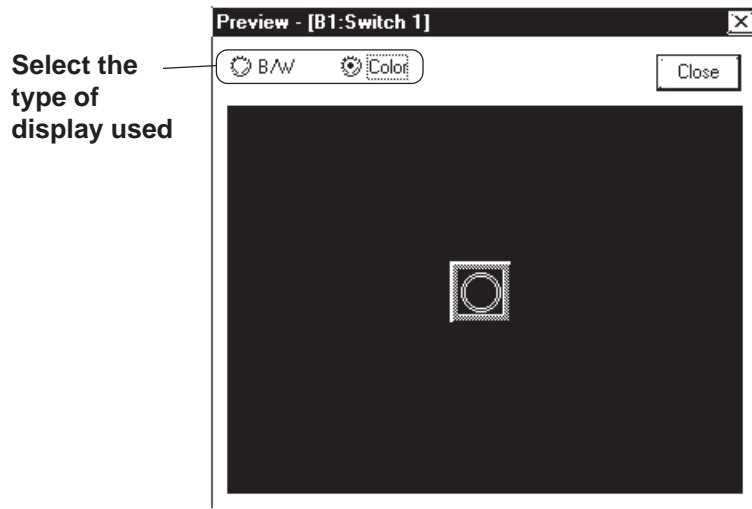

2.7.4 Screen Data List

The currently displayed screen's object locations and setting attributes are listed in the Screen Data List.

■ **Screen Data List**

An example of the Screen Data List is shown below.

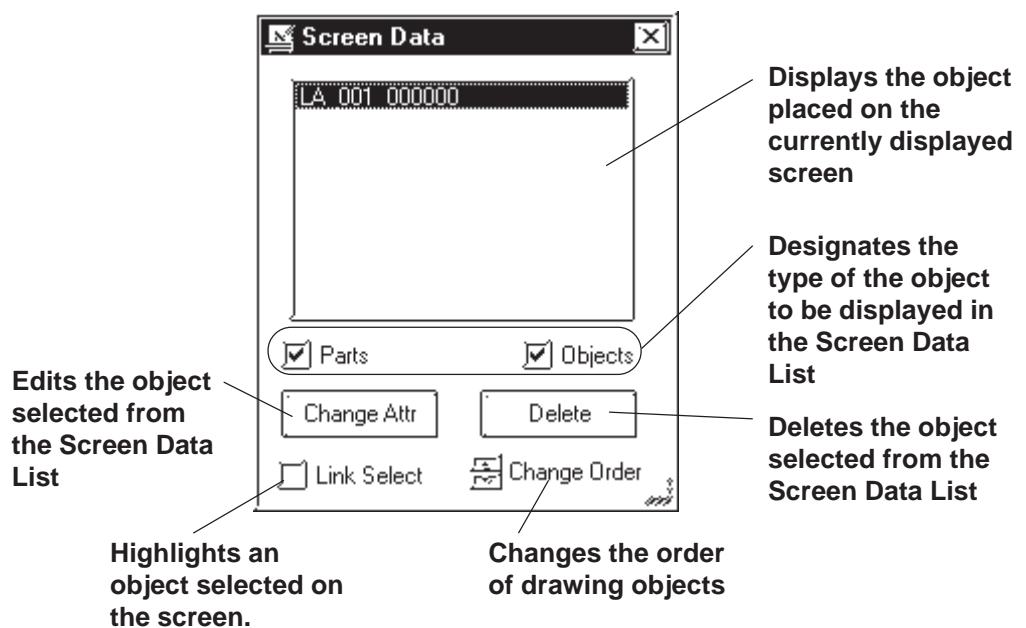

■ Screen Data Display

The designated type of object(s) data is displayed. If a grouped object contains at least one object whose type has been designated, it is displayed as an grouped object.

The Screen Data List displays the following information:

Drawing Type and coordinates of a drawing object

Part ID Number and Address

Grouped object Grouped object's coordinates and each grouped object's information



Note: D-Scripts are displayed all the time. Each D-Script shows ID and description information.

■ Selecting an Object

The object selected from the list will be displayed with handles (i.e. selected) in the Screen Editor. To select multiple objects from the list, Left-drag them, or hold the Shift or Ctrl key down and click on desired ones.

◆ Link Select

Normally, when any object is selected with the Screen Editor, it will not be displayed on the list. If the check box for [Link Select] is marked, an object selected with the Screen Editor will also be selected (highlighted) on the list.

■ Editing an Object

To edit an object, select it from the list and click on the button; or simply double-click on the object.

If the object is D-Script, D-Script Editor will be actuated.

Clicking on the button deletes the selected object.

◆ Change Order

Objects are displayed on the list in the order where they have been drawn. If the order of objects on the list is changed, the overlapping order of drawn objects and the executing order of Parts can also be changed.

◆ Copying

Any object on the list can be copied by pressing the + key, or pasted by pressing the + keys. Multiple objects can be copied at a time by selecting them.

2.7.5 Part Reference List

The settings for each Part placed on the currently edited screen are listed here, for each Part type. Part settings can also be changed on the Part Reference List.

| Usage Pattern | When either modifying or deleting... |
|-------------------------|--|
| [View] → [Parts List] → | Select Part → After selection, either modify or delete the Part → <input type="button" value="Close"/> or the <input type="button" value="Esc"/> key |

An example of the Part Reference List on a screen is shown below.

Reflection of device comment
The device comment corresponding to an entered device address overwrites the Description field.

Shows a list of the Parts on the currently selected screen. Simply click on the desired Part

Changes Part's settings

Deletes the selected Part

Copies a Part

Pastes a Part

Stores the Parts list information as a CSV file.

Use this scroll bar to view all the data on a long screen

Closes the current screen. (The key can also be used)

| Part ID | Description | Data Address | Display M. | Data Format | Bit Length | Input Code | Min. Value | Max. Value | Edit |
|---------|-------------|--------------|------------|-------------|------------|------------|------------|------------|---------------------------------------|
| 1 | Run Test | 00000 | + | Abt. Bin | ... | ... | ... | ... | <input type="button" value="Edit"/> |
| 2 | Alarm Test | 00000 | + | Abt. Bin | ... | ... | ... | ... | <input type="button" value="Delete"/> |
| 3 | Peak Test | 00000 | + | Abt. Bin | ... | ... | ... | ... | <input type="button" value="Copy"/> |
| | | | | | | | | | <input type="button" value="Paste"/> |
| | | | | | | | | | <input type="button" value="Export"/> |

Note: The tab width for each item can be adjusted by placing the mouse pointer on the border between items and then dragging it.

■ Editing Items on the Part Reference List

Part setting data can be changed directly on the Part Reference List.

Click on the left-most number of a Part to be changed, and it will be highlighted; then, click on the button, and the Part's Dialog box will appear and its settings can be changed.

Setting items, such as the Description and Address areas, can be changed via the Part Reference List. Also, items displayed in gray can be changed in the dialog box by double-clicking on the inside of their border.

| Part ID | Description | Data Address | Disp. | Data Size |
|---------|-------------|--------------|-------|-----------|
| 1 | FD_001 | 0002 | 5 | 8x1E |

Can be edited directly (points to the Description field)

Can be edited by double-clicking (points to the Data Size field)



Note: For the labels and messages of more than one line, use “\” as the carriage return.

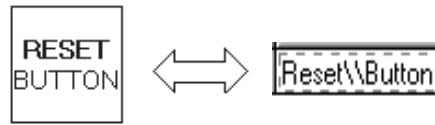

■ Deleting Items from the Part Reference List

Parts can be deleted directly from the Part Reference List.

Click in the middle of a Part to be deleted, and it will be highlighted. Then, click on the button, and a dialog box will appear. Clicking on the button will delete the Part from the Part Reference List. To close the box without deleting the Part, click on the button. When multiple Parts are selected, all the Parts will be deleted by clicking on the button, and by clicking on the button, the box will be closed.

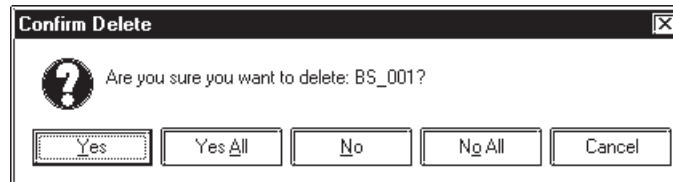

■ Copying a Part on the Parts List

Any Part can be copied on the Parts list.

Select the left-most number for the Part being copied by clicking on that number. The selected Part will be highlighted. After this selection, click on the button and then the button. The Part will be copied to the bottom line of the list.

■ Reflecting a Device Comment on the Parts List

The device comment corresponding to an entered device address can be entered on the Parts list by clicking on a specified button. This can be done in either of the following two ways:

1. Select the address setting field and click on the [Apply Device Comment] button.

The device comment corresponding to the selected address will be reflected in the Description field.

2. Select a Part by its line and click on the [Apply Device Comment] button.

If there are multiple address setting items for that Part, the description corresponding to the address specified in the [Address Table for Automatic Input of Device comment] will be reflected in the Description field.

▼ Reference ▲ 2.3.8 ◆ Reflection of Device Comments

■ Exporting to a CSV File

The Parts list information can be saved as a CSV file.

You can also select whether the currently selected page (tab)'s information will be exported or the entire page will be exported.

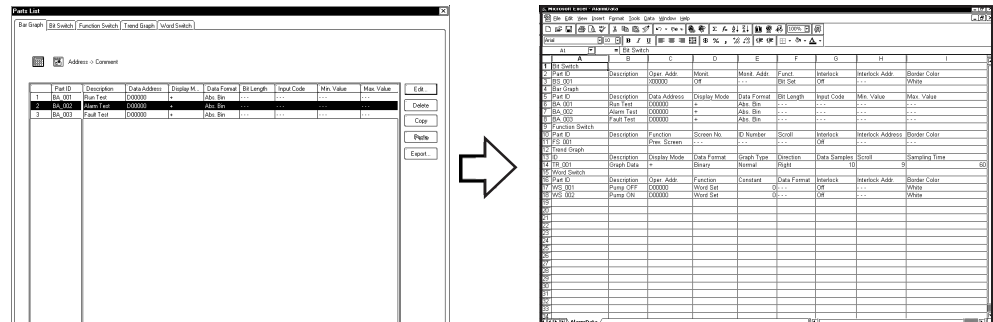

2.7.6 Data Sampling List

Data Sampling List shows data sampling settings created in the edited project file. You can confirm the status of each data sampling setting there. You can also change the data sampling settings on the list.

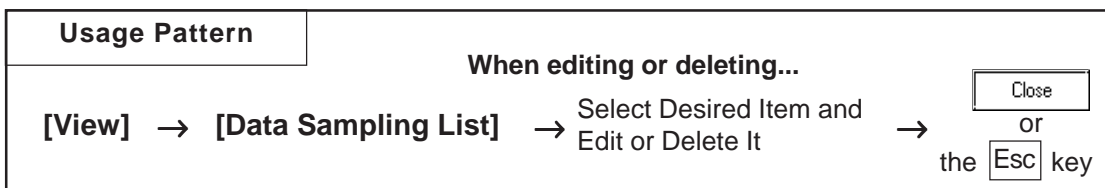

The following is the Data Sampling List (local) screen example. The edit method of this list is the same as that of the Parts list.

▼ Reference ▲ 2.7.5 Parts List

[All] tab

Using Device Comment
Here, the device comment that corresponds to an device address is automatically written in the Description field.

Click on **Close** to close the Data Sampling Setting List screen. Pressing the **[Esc]** key will also close the screen

Opens the selected Data Sampling Setting for editing

Deletes the selected Data Sampling Setting

Copies Data Sampling Setting

Pastes Data Sampling Setting

Moves Data Sampling Setting one position higher on the list

Moves Data Sampling Setting one position lower on the list

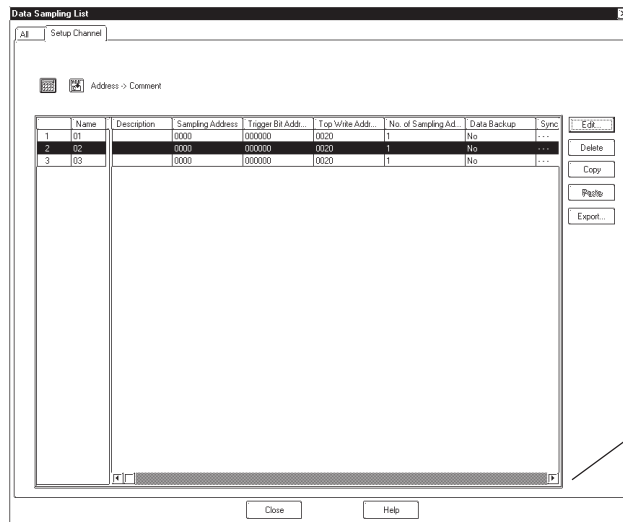
[Setup Channel] tub

Saves the Data Sampling Setting List in a CSV file

Scrolls the display left, right, up and down when the Data Sampling Setting List is bigger than the screen size



Note: The tab width for each item can be adjusted by positioning the mouse pointer on the border between items and then dragging it.

■ Changing the Data Sampling Setting Order

The Data Samplings will function in the order that they have been set up (the order displayed on all the pages of the Data Sampling List) on the LT screen. To change this order, click on either the **Move Up** or **Move Down** key. When multiple Data Sampling are grouped, that group will be moved up or down.

■ Exporting a CSV File

The Data Sampling Setting list information can be saved as a CSV file.

▼ **Reference** ▲ 2.7.5 Parts List; ■ **Exporting a CSV File**

2.7.7 Cross Reference List

The Cross Reference List feature is useful when displaying the current address condition of Parts and other items. Here, the exact address used for each Part can be checked.

Cross reference will be displayed for local settings (each screen's Parts and D-scripts), and data sampling and global D-scripts registered for all the screens. For the global cross reference, setting display will not be sorted for each functions and screens, but the address designation conditions will be displayed for the entire Project File.



- **Note:** Since, to display the global cross reference, address information for all the screen will be acquired, it can take a long period of time.
- The global cross reference does not display the condition of addresses that have been designated via [LT System Settings].

■ Cross Reference (Local, Data Sampling, Global D-script)

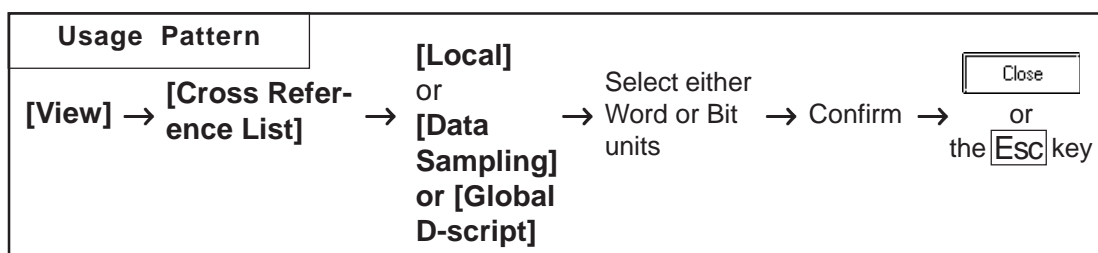

An example of the Cross Reference List dialog box (in the case of Local) is as shown below.

Select whether to display by Bit Address or Word Address

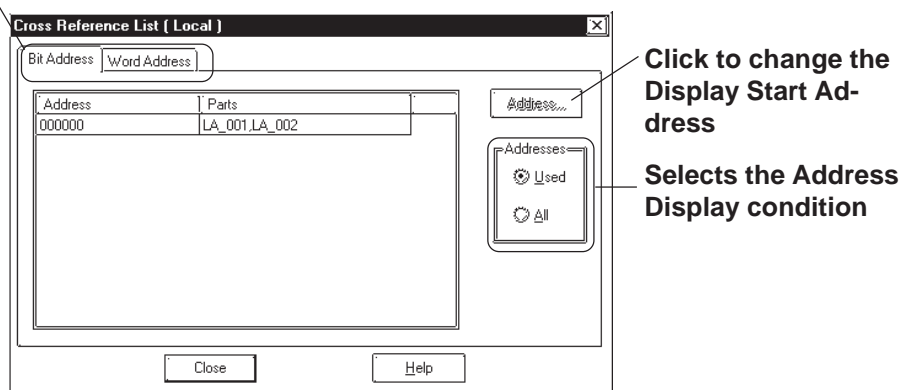

■ Global Cross Reference

The global cross reference has two display methods, i.e. list display same as the standard cross reference and address map display.

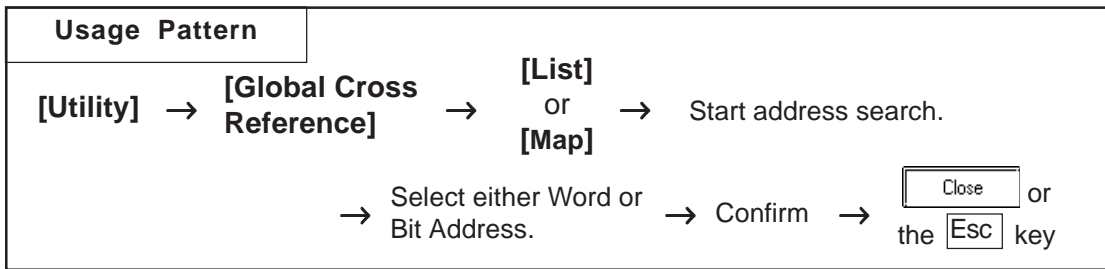

The following is the overview for the global cross reference screens.

◆ List Display

For local settings, which screen is used, and for global settings, function type will be displayed, respectively.

Selects whether setting conditions are displayed for Bit Addresses or for Word Addresses.

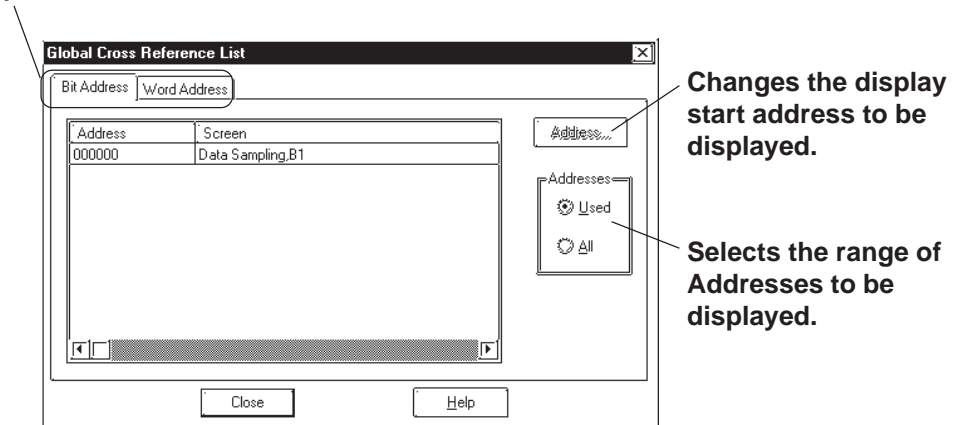

◆ Address Map Display

When selecting Word Address, the table cells from Word Address Bits 0 to 15 (for 32 bit device, from 0 to 32) will all be filled. When selecting Bit Address, only bit cells currently used will be filled.

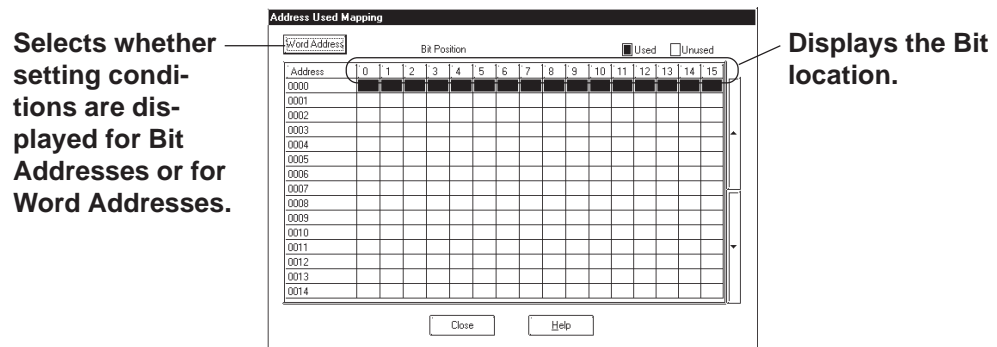



Note: Parts that corresponding to both bit addresses and word addresses are cross-referenced with both of those addresses on the Cross Reference List even if they were placed by specifying their bit addresses.

Example: A part placed at bit address X0000F is displayed as the word address X00000.

■ Changing Display Addresses

For cross reference and global cross reference list display, when selecting [Used], addresses that have been used for the Parts and other items used in the currently open screen or Project will be displayed. When selecting “All Addresses”, all the addresses beginning with the Start Address will be displayed. To change the Start Address, click on the button, and the Dialog box shown below will appear. Set the Start Address and click on the button, and the display will show from that address on.

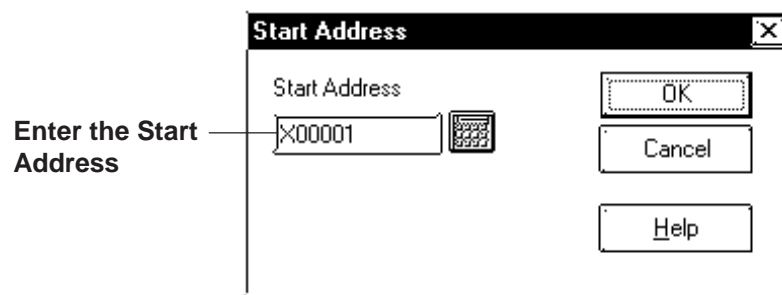

For the global cross reference’s address map display, the map display start address can be designated when toggling Bit and Word display.

When clicking on or , the following dialog box will appear. After selecting Bit or Word, designate the start address. Then, click on the button and the cross reference display will start from the designated start address.

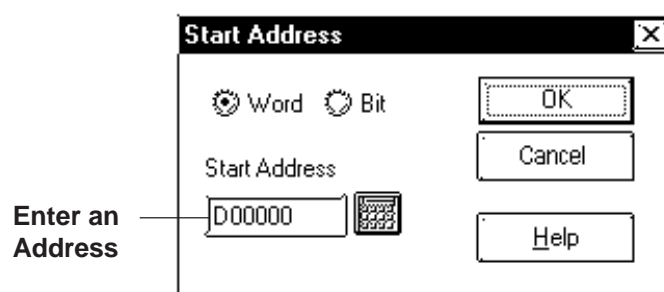

2.7.8 Load Screen List

The Load Screen List will be displayed on the currently edited screen. With this list, you can check the setting attributes of a screen to be loaded and also can change its loading location.

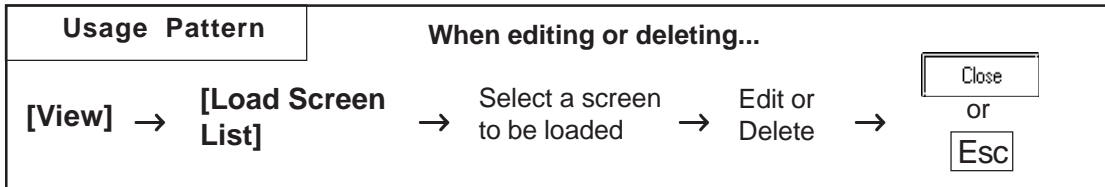

General Load Screen Summary List

Lists all the screens loaded on the currently open screen. Select the desired screen to show its setting attributes.

Click on to close the Load Screen List screen. Pressing the **ESC** key will also close the screen

Changes Load Screen List Settings

Deletes a Load Screen List

| Scr... | Position X | Position Y | Title |
|--------|------------|------------|--------------|
| 1 | 195 | 59 | Line A |
| 2 | 305 | 81 | Statistics A |
| 3 | 265 | 182 | Alarm A |

■ **Editing via the Load Screen List**

Screen settings can be changed using the Load Screen List. Clicking on the left-most number of a screen to be changed will select (highlight) it. Then, clicking on the [Edit] button will bring up the [Load Screen] dialog box or the currently called-up screen, allowing you to edit the screen. The procedure for calling up and then editing a screen varies depending on the settings in the [Load Screen Double Click].

▼ **Reference** 2.7.2 ■ *Screen Property Settings — [Display Settings]*

Any coordinate setting can be changed directly via the Load Screen List.

■ Deleting from the Load Screen List

Screens can be deleted from the Load Screen List.

Clicking on the left-most number of a screen to be changed will select (highlight) it. To delete multiple Load Screen Lists simultaneously, simply drag the cursor to select the screen numbers. Then, click on the button, and the dialog box will appear to confirm the command. If you click on button, the screen will be deleted. To cancel the request, click on the button. When selecting multiple screens, click on the to delete all of them, and click on to cancel any deletions.

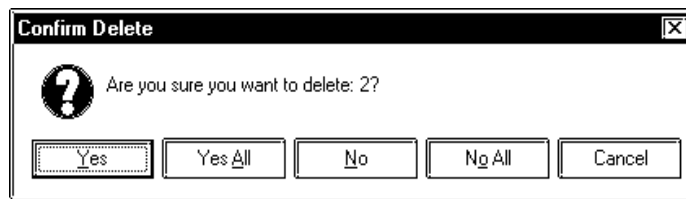

2.7.9 Display of Screen Level Change Structure

The nesting of Load Screens that have been set up on the currently edited screen is displayed. In this way, a multiple nesting condition can be viewed.

▼ Reference ▲ 2.2.10 Nesting

Select the [View] menu - [Load Screen Nesting Display] command.

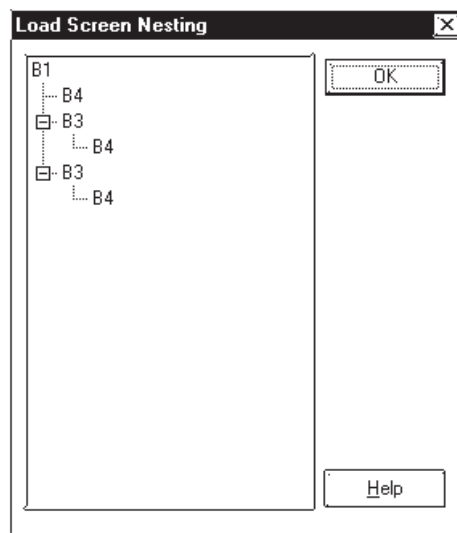

Each screen will be displayed via the following symbols:

| Screen Type | Symbol |
|--------------|--------|
| Base screen | B |
| Mark screen | M |
| Image screen | I |

2.8

DXF Conversion

This feature allows you to convert DXF (Drawing Interchange File) file data into Base screen data, and to convert Base screen data into DXF file data. (A DXF file is on Auto Cad® drawing file)



- **DXF filenames must be alphanumeric.**
- **DXF can be used for the Release 12 program. If a newer version's data is used, that data will not be converted.**
- **When each object's coordinates are converted, errors may occur, thereby slightly changing them.**
- **Once a DXF file data is converted into Base screen data, even if the Base screen is again converted back into the original DXF file, or vice-versa, the resulting data may be unusable.**
- **When converting data, be sure that the screen's width and height ratio will be the same for both the Base screen and the DXF file (Screen size settings: \$LIMMAX, \$LIMMIN). If this ratio is different, after data is converted, object locations or shapes will also be different from the original.**

2.8.1

Conversion from DXF File to Base Screen (DXF → Screen)

DXF file data is converted into Base screen data.

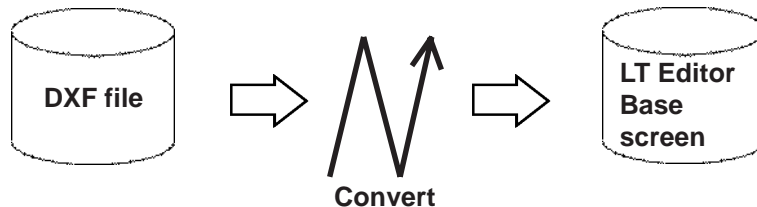

■ Requirements and Restrictions when Converting Data (DXF → Screen)

- Grouped objects (Blocks) can be nested up to 10 layers (levels deep).
- The DXF file data format is ASCII. Both “CR LF” and “LF” can be used as line feed characters and will be converted correctly.
- During conversion, when the resulting output file's size reaches 16Kbytes, the conversion will quit, and subsequent data will not be converted.
- Three dimensional data cannot be converted.
- If the X,Y coordinate screen boundaries (\$LIMMIN, \$LIMMAX) are not set up correctly in the DXF file, after the data created in the DXF file is converted into Base screen data, it may go beyond the Base screen's display area.

- After DXF file data is converted into Base screen data, the DXF file name is used as the Base screen's description.
- When a layer's attribute has been turned OFF, that layer's data will not be converted, and only ON layer data will be converted into Base screen data.
- Fill and Oval/Arc data cannot be converted.

■ Option (DXF → Screen)

Here, select and enter the color and size used when converting data. According to the specified DXF and Base screen size, data will be relatively magnified or minimized when converted.

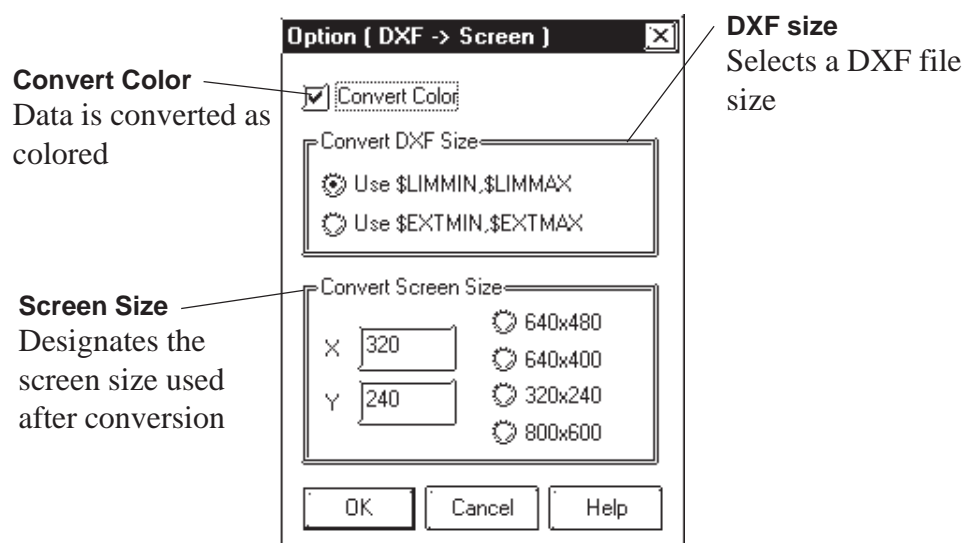

◆ Convert Color

When this box is checked, DXF file data is converted as colored. When this box is not checked, DXF file data is converted as monochrome.

▼ Reference ▲ ■ Color Conversion (DXF → Screen)

◆ Convert DXF Size

The DXF file data conversion range is selected.

When “Use \$LIMMIN, \$LIMMAX” is selected, data in the DXF file's maximum screen area (X,Y coordinate screen boundaries) will be converted. When “Use \$EXTMIN, \$EXTMAX” is selected, only data in the DXF file's object area will be converted.

◆ Convert LT Size

The Project File screen size (LT screen size) used after conversion is specified.

■ Color Conversion (DXF → Screen)

When the [Option] dialog box's [Convert Color Data] check box is checked, the DXF file's color data will be converted as follows:

| DXF File Color No. | Base Screen |
|--|-------------|
| 1 (red), 1X (red-based) | Red |
| 2 (yellow), 5X (yellow-based) | Yellow |
| 3 (green), 9X (green-based) | Green |
| 4 (light blue), 13X (light blue-based) | Light blue |
| 5 (blue), 17X (blue-based) | Blue |
| 6 (purple), 21X (purple-based) | Purple |
| 7 (white) | White |
| Other colors | White |

The background color will be converted into Black.

■ Line Type Conversion (DXF → Screen)

Each DXF file's line type will be converted as follows:

| DXF File | Base Screen |
|------------|---------------------------|
| CONTINUOUS | ————— Solid line |
| DASHED | - - - - Broken line |
| HIDDEN | - - - - Broken line |
| CENTER | - · - · - A dot-dash-line |
| PHANTOM | - · · · Two dot-dash-line |
| Other | ————— Solid line |

The user defined line types will be converted into solid lines.

■ Object Conversion (DXF → Screen)

The DXF file's objects will be converted as follows.

Colors and line types will be converted as shown above. Tiling patterns will be converted into solid Fill.

| DXF File | Base Screen |
|---|---|
| LINE | Straight line |
| POINT (dot) | Straight line (The start and end are the same point) |
| CIRCLE | Regular circle |
| ARC | Arc |
| TRACE (thick line) | Filled polygon |
| SOLID (filled object) | Filled polygon |
| TEXT (characters and signs) | Text |
| DIMENSION (dimension indicator) | Straight line |
| INSERT (inserting object) | Conversion breaks down complex objects into component parts (objects) |
| ATTRIB (attribute) | Conversion breaks down complex objects into component parts (objects) |
| POLYLINE (polyline/donut-shaped/oval/polygon/rectangle) | Continuous straight line |
| VERTEX | Vertex coordinates of a continuous straight line |

Objects other than the above will not be converted.

Each object's elements, other than colors and line types, will be converted as follows:

- ◆ **POINT (dot)**
 - A dot's pattern will be converted into "0" (point), and its display size will be converted into "0,0".
 - A dot will be converted to a straight line, with the start and end coordinates at the same point.
- ◆ **TEXT (characters and signs)**
 - A rotation angle will be converted into an angle closer to 90°, 180°, 270°, or 360°. (in 90° units)
 - The character size will be converted into a size closer to either 1, 2, 4, or 8 x magnification.
 - Special characters that will be converted are %%d (°), %%c (φ), and %%p (±).
 - When text contains more than 100 characters, it will be divided every 100 characters into records of data and then converted.
 - When more than 100 character text is divided into records of data, groups of overflowing characters after the first 100 characters will be dislocated toward the right bottom for a few dots.
 - Tilting angles, character fonts, and character spacing will not be converted.
 - Text will be converted based on the ASCII code; therefore, the character style (Standard, Bigfont, etc.) or font file settings will be ignored.
 - When text with half-sized and full-sized characters mixed in vertical lines is converted, the half-sized characters will be centered.
- ◆ **DIMENSION (Dimension Indicator)**
 - During conversion, the breaking down of a grouped object (Block) is performed by referring to the Block's sections, which indicate the Block's component Part (objects). However, dots will not be converted.
- ◆ **INSERT (Inserting Object)**
 - A grouped object defined in the Block section will be broken down into each drawing object and converted.
 - Up to 10 layers of nested data will be converted. However, since all the data will be converted into a single layer on a single screen, the objects over the limit (file capacity) will not be converted.
 - Although the rotating angles, and the number of lines and columns can be converted (lines and columns of the objects over the limit will not be converted), their ratio (scaling) will not be converted.
 - The grouped object created in Layer "0" will be converted based on the inserted layer's colors and line types, however, a grouped object created in an other layer level will not be converted based on the inserted layer's colors and line types. In this case, if BYBLOCK is specified to the grouped object, the inserted layer's colors and line types will be used.
 - Simulated object sectioning (hatching) data cannot be converted, since, when the Block section's hatching data pattern is converted into each drawing object, that data size can exceed the LT file capacity.
 - If another file's grouped object has been inserted or another file is referred, that grouped object will not be converted.
- ◆ **ATTRIB (attribute)**

ATTRIB (attribute) data is part of INSERT data.

 - Attribute data will be converted in the same manner as TEXT conversion.



◆ **POLYLINE (polyline/donut-shaped/oval/polygon/rectangle)**

- POLYLINE data will be converted connecting the following VERTEX's coordinates with a continuous straight line. Only data whose polyline flag is either "0 (default)", "1 (closed polyline)", "2 (adding the fit curve vertex)", or "4 (adding the spline curve vertex)" will be converted.
- When the number of vertices exceeds 100, data will be divided every 100 vertices and converted.
- When the converted data's coordinates are repeated at the same point, the following coordinates will be omitted.
- When a polyline has curved sections, they will not be converted. Therefore, donut-shaped lines and curved polylines will be converted into continuous straight lines, connecting each coordinate point.

◆ **VERTEX**

- Top coordinates of a polyline.
- A polyline's width will not be converted.

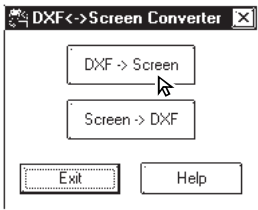
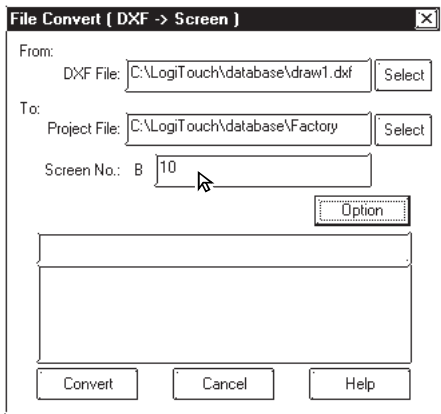
■ **Converting DXF File Data to Base Screen Data**

| PROCEDURE | REMARKS |
|---|---|
| <p>(1) Select the pull down menu [Utility]'s [Convert DXF] command.</p> <p>(2) Click on the  button.</p>  <p>(3) Designate the source (DXF file) and the destination (Project File), and enter the Base screen number.</p>  | <p>To designate a folder, click on the  button.</p> |

| PROCEDURE | REMARKS |
|-----------|---------|
|-----------|---------|

(4) Click on the **Option** button and enter the conversion conditions.

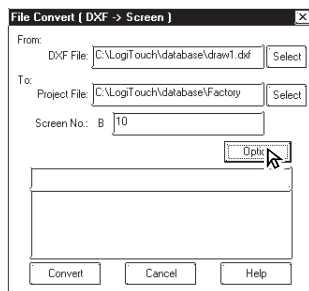

(5) After all the attributes have been entered, click on the **OK** button to registered the entered data.

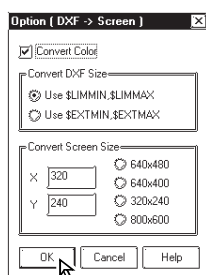

(6) Click on the **Convert** button to start conversion.

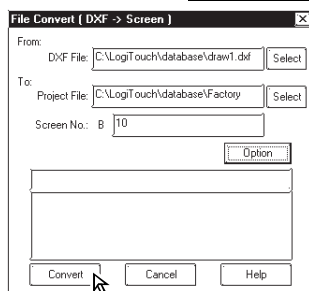

(7) After the conversion is completed, click on the **Cancel** button. The [DXF<->LTE Converter] dialog box will reappear.

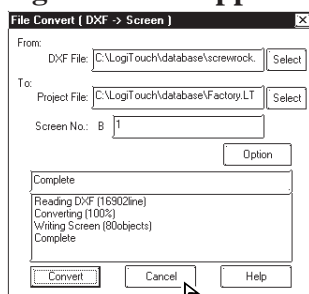

(8) Click on the **Exit** button to quit.

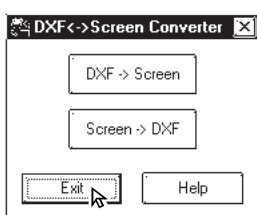

Reference 2.8.1 ■ Option (DXF → Screen)

If the designated screen number already exists, a prompt will appear, asking whether the new number should overwrite the old number. When the **OK** button is clicked on, the new number will overwrite the old one, and when the **Cancel** button is clicked on, the new number will not overwrite the old one.

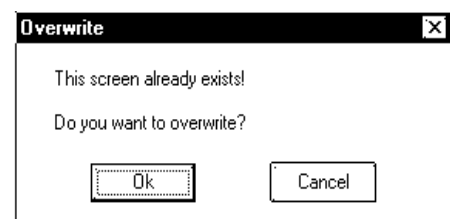

To convert another DXF file, DO NOT cancel here; rather, start from step (3) again.

2.8.2 Conversion from Base Screen to DXF File (Screen → DXF)

Base screen data is converted into DXF file (Drawing Interchange File) data.

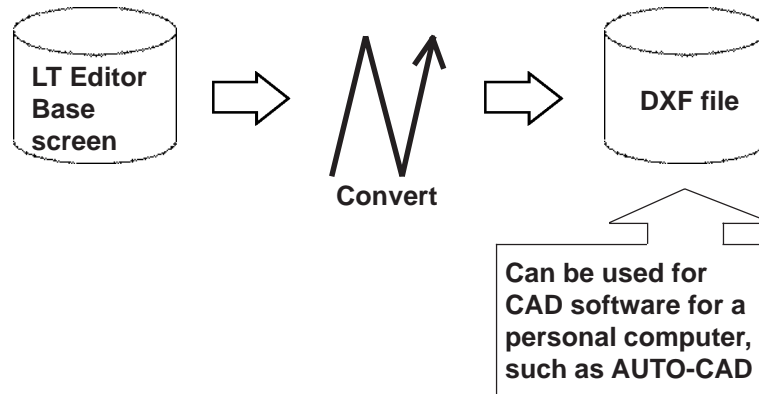

■ Requirements and Restrictions when Converting Data (Screen → DXF)

- Only Base screens can be converted.
- Image screens called up on the Base screen will not be converted.
- Tag data will not be converted, so for example, M-tag's Marks will not be displayed after conversion.
- When text is converted, the character size and position may differ from the original due to font type difference and errors created during conversion.
- Since Load Mark will be converted into a simple straight line (i.e. no width), if it has been magnified, it will be displayed differently from the original after it is converted.



If you try to convert a filled polygon that has four peaks, one of which introverts, into a DXF file, this polygon will not be converted properly.

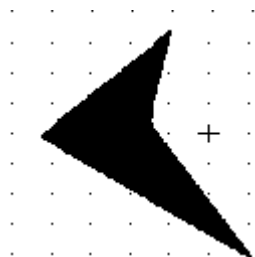

■ **Option (Screen → DXF)**

Here, select and enter color and size data used when performing data conversion.

Screen Size

Designates the LT screen size after conversion

DXF size

Designates the DXF screen size when Base screen data is converted into DXF file data

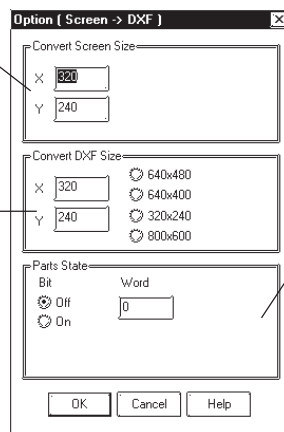

Parts State

Selects and enters the Part State when converted

◆ **Convert Screen Size**

The screen size of a LT unit specified in the Project File.

◆ **Convert DXF Size**

The DXF file size used after data is converted using data conversion is selected. The default values are the same as the Screen Size values mentioned above.

◆ **Parts State**

Bit When Part display states (ON/OFF) are specified, that Part will be converted for each display state.

Word .. Picture Display and Message Display will be converted with the display state specified here.









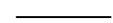

■ **Color Conversion (Screen → DXF)**

Base screen's drawing data colors will be converted as follows:

| Base Screen | DXF File Color No. |
|-------------|--------------------|
| Black | 250 (gray) |
| Blue | 5 (blue) |
| Green | 3 (green) |
| Light blue | 4 (light blue) |
| Red | 1 (red) |
| Purple | 6 (purple) |
| Yellow | 2 (yellow) |
| White | 7 (white) |

■ Line Type Conversion (Screen → DXF)

Base screen's line types will be converted as follows:

| Base Screen | DXF File |
|---|------------|
|  1-dot solid line | CONTINUOUS |
|  1-dot broken line | DASHED |
|  1-dot one-dot-dash line | CENTER |
|  1-dot two-dot-dash line | PHANTOM |
|  2-dot solid line | CONTINUOUS |
|  2-dot broken line | DASHED |
|  2-dot one-dot-dash line | CENTER |
|  2-dot two-dot-dash line | PHANTOM |
|  3-dot solid line | CONTINUOUS |
|  5-dot solid line | CONTINUOUS |

The line thickness will be converted in the same thickness for all the lines, regardless of the line types.

■ Object Conversion (Screen → DXF)

Base screen's drawing data will be converted as follows.

Colors and line types will be converted as shown in the previous page's table. The background colors will not be converted. Tiling patterns will be converted into solid Fill.

| Base Screen | DXF File |
|--|---|
| Straight line/Continuous straight line | LINE/POLYLINE |
| Square/Filled Square | POLYLINE/SOLID |
| Regular Circle/Filled | CIRCLE/CIRCLE + SOLID |
| Regular Circle | |
| Oval/Filled Oval | POLYLINE/POLYLINE + SOLID |
| Arc/Pie | ARC/ARC + POLYLINE |
| Division | Collection of lines |
| Filled Polygon | SOLID or POLYLINE |
| Load Screen | Broken down into each Part object and converted |
| Text | TEXT |
| Load Mark | POLYLINE |
| Part | Broken down into each part and converted |

Data other than the above will not be converted.

◆ Straight line/Continuous straight line





- When the number of coordinates is “2”, a straight line or continuous straight line will be converted into LINE. If this number is other than 2, it will be converted into POLYLINE.
- When a line has an arrow at one end, a solid filled triangle will be drawn at the end coordinates, and when a line has arrows at both ends, solid filled triangles will be drawn at both ends.

◆ Square/Filled Square

- Any line will be converted into POLYLINE.
- Any Fill will be converted into SOLID.

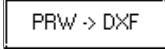
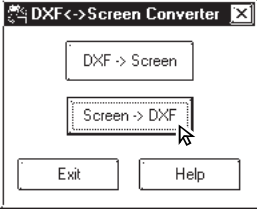
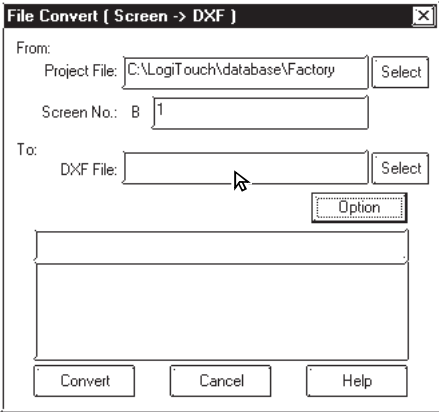
- ◆ **Regular Circle/Filled Regular Circle**
 - Filled regular circle's border will be converted into CIRCLE and its filling will be converted into SOLID.
- ◆ **Oval/Filled Oval**
 - Any lines will be converted into POLYLINE.
 - Filled oval's border will be converted into CIRCLE and its filling will be converted into SOLID.
- ◆ **Arc/Pie**
 - Pie's straight line section will be converted into POLYLINE.
- ◆ **Divisions**
 - When the divisions are marked on a straight axis, their coordinates will be calculated based on their start and end coordinates, direction, and the number of divisions, and will be converted into LINE.
 - When the divisions are marked on an arc axis, their coordinates will be calculated based on their start and end angles, external circle's radius, internal circle's radius, number of divisions, and will be converted into LINE.
- ◆ **Filled Polygon**
 - Fill will be converted into SOLID. However, if the number of vertices is more than 5, Fill will not be converted and only its trace will be converted into POLYLINE (CONTINUOUS).
- ◆ **Load Screen**
 - The screen will be retrieved from its attributes, and screen number and if it exists, and each drawing data will be converted.
 - The called up screen's data will be converted in the same layer as other drawing data.
 - Only Base screen will be converted.
- ◆ **TEXT**
 - Characters written horizontally will be converted into BIGFONT. Those written vertically will be converted into TATEGAKI (vertical type of BIGFONT).
 - 1/4-sized characters will be all converted into half-sized characters.
 - Half-sized (1/4-sized) characters written horizontally will be converted with a relative scale of 1/2 in the X direction, and other size characters will be converted with a relative scale of 1.
 - Both half and full-sized characters written vertically will be converted with a scale of 1 for their height and width. Therefore, the half-sized characters will become the same size as the full-sized characters.
 - Character types of "Bold" and "Raised" will not be converted.
 - Due to font difference and other elements, text will be different from the Base screen, after conversion.
- ◆ **Load Mark**
 - The Mark screen will be retrieved from the screen number, if that screen exists, the dot pattern will be converted into POLYLINE (CONTINUOUS).
- ◆ **Part**
 - Each Part's data will be converted into drawing data.

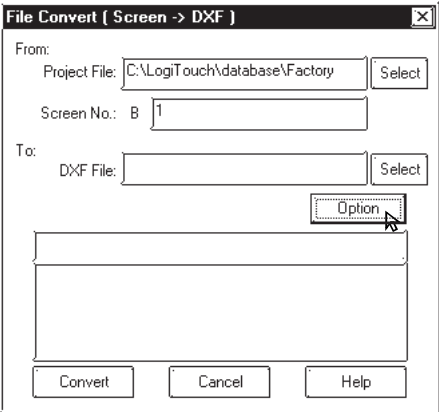
■ Converting Base Screen Data to DXF File Data

| PROCEDURE | REMARKS |
|---|---|
| <p>(1) Select the pull down menu [Utility]'s [DXF Conversion] command.</p> <p>(2) Click on the  button.</p>  <p>(3) Designate the source (Project File) and Base screen number and designate the destination (DXF file).</p>  <p>(4) Click on the  button and enter the conversion conditions.</p>  | <p>To designate a folder, click on the  button.</p> |

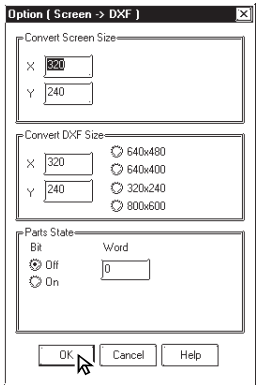
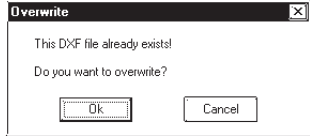
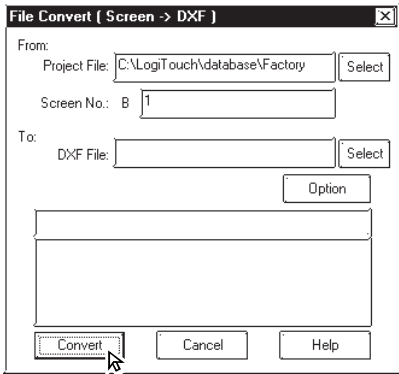
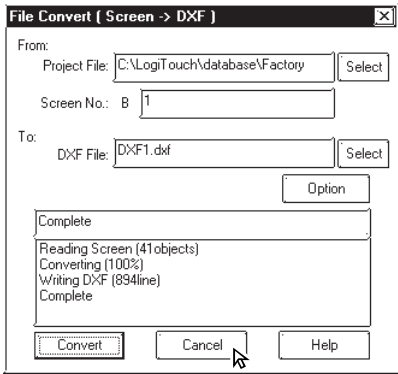
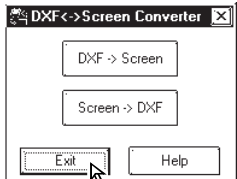
| PROCEDURE | REMARKS |
|--|--|
| <p>(5) After all the attributes have been entered, click on the OK button to registered the entered data.</p>  | <p>Reference 2.8.2 ■ Option (Screen → DXF)</p> <p>If the designated DXF file name already exists, a prompt will appear, asking whether the new name should overwrite the old name. When the OK button is clicked on, the new name will overwrite the old one, and when the Cancel button is clicked on, the new name will not overwrite the old one.</p>  <p>To convert another Base screen, DO NOT stop here; rather, start again from step (3).</p> |
| <p>(6) Click on the Convert button to start conversion.</p>  | |
| <p>(7) After the conversion is completed, click on the Cancel button. The File Convert (DXF → Screen) dialog box will reappear.</p>  | |
| <p>(8) Click on the Exit button to quit.</p>  | |

Memo

LT Editor provides various screens for specific purposes (for example: for creating marks and images), in addition to the Base screens which are the fundamental screen used for all drawing modes. Other screens can then be loaded onto Base screens as libraries.

This chapter describes the procedure for creating these screens and their applications.

3.1 Creating a Mark: the Mark Screen

3.2 Creating an Image: the Image Screen

3.1 Creating a Mark: the Mark Screen

Create a mark (dot pattern) on a “Mark” screen. Using the [Draw] menu - [Load Mark] command, you can load the created Mark onto a Base screen.

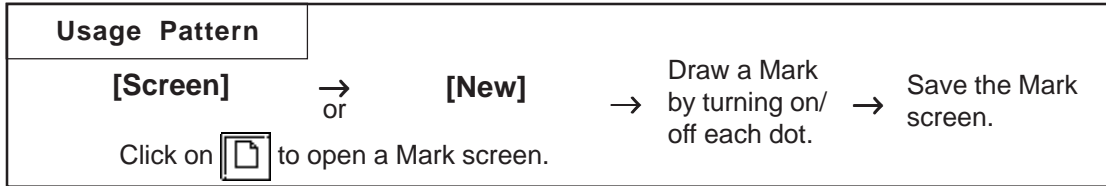



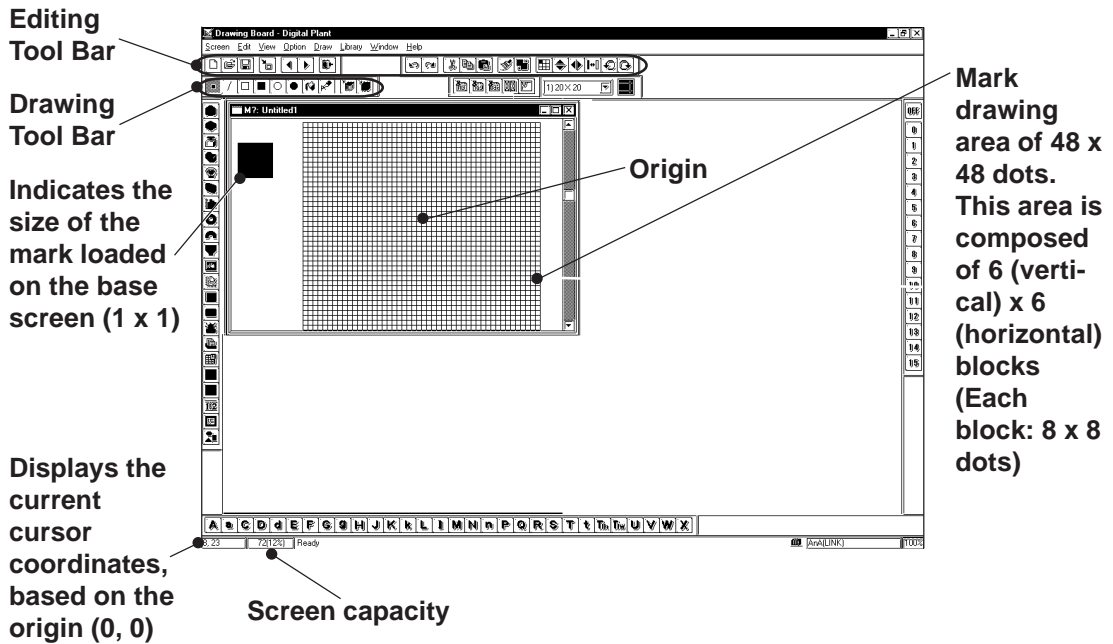

General description of the Mark screen:



■ Drawing Tools













The Drawing Tool Bar icons and their corresponding drawing objects are as follows:

| Icon | Drawing Tool | Description |
|------|----------------------------------|--|
| | Dot | Specify the ON/OFF status of each dot by clicking on each dot or dragging the mouse within a specified area. |
| | Line | Specify the start and end points of a line and draw a line by clicking on desired points. |
| | Square (Rectangle) | Draw a square or rectangle by clicking and dragging to the desired size on a diagonal axis. |
| | Filled square (Filled rectangle) | |
| | Circle/Oval | Draw a circle or oval by clicking and dragging to the desired size on a diagonal axis. |
| | Filled circle (Filled oval) | |

| Icon | Drawing Tool | Description |
|---|------------------------------|--|
|  | Fill | Fill in an area with a desired color by clicking in the area (enclosed within lines and shapes). |
|  | Text | Enter the text to be displayed in the mark drawing area. |
|  | Call Up Mark Library | Select a Mark from the Mark Library |
|  | Register Mark Library | Register a created Mark as a Mark Library. |

■ Editing Tools

The Editing Tool Bar icons and their corresponding functions are as follows:

| Icon | Editing Tool | Description |
|---|-------------------------------------|---|
|  | Cut | Used to delete an entire Mark screen and store it in the clipboard. Using the [Paste] command, you can then paste the Mark screen onto another screen. |
|  | Copy | Used to copy the data of the selected Mark screen in the clipboard. |
|  | Paste | Used to paste the data temporarily stored in the clipboard onto a desired place. |
|  | Duplicate | Used to duplicate a Mark screen's specified area. |
|  | Delete | Used to delete a mark. |
|  | Undo | Used to cancel the command executed immediately before, and return to the previous condition. (Undo) |
|  | Redo | Used to redo the command canceled with the [Undo] command. (Redo) |
|  | Mirror X | Used to move the dot pattern symmetrically relative to the vertical axis. The symmetry axis is the vertical line that divides the screen into two equal sections. |
|  | Mirror Y | Used to move the dot pattern symmetrically relative to the horizontal axis. The symmetry axis is the horizontal line that divides the screen into two equal sections. |
|  | Turn counterclockwise | Used to turn the Mark counterclockwise by 90°. |
|  | Turn clockwise | Used to turn the Mark clockwise 90°. |
|  | Reverse | Used to reverse the white/black area of a Mark. |
|  | Transparent/Background color | If no dots are turned ON in a block (8 x 8 dots), this block becomes transparent. |

■ **Mark Drawing Area Structure**

The mark drawing area has the following structure. When you edit a Mark, you can use this for your reference.

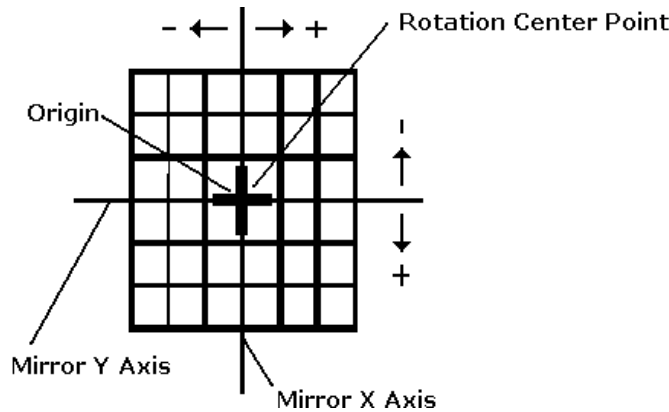

3.1.1 Drawing a Mark

When drawing a mark you can use LT Editor’s standard drawing functions. Here, the procedures for using each function are described.

■ **Drawing with Dots**

You can draw a Mark by turning ON/OFF each dot. When you click the left mouse button in the Mark drawing area, each dot turns ON (white). When you click the right mouse button in the Mark drawing area, each dot turns OFF (black).

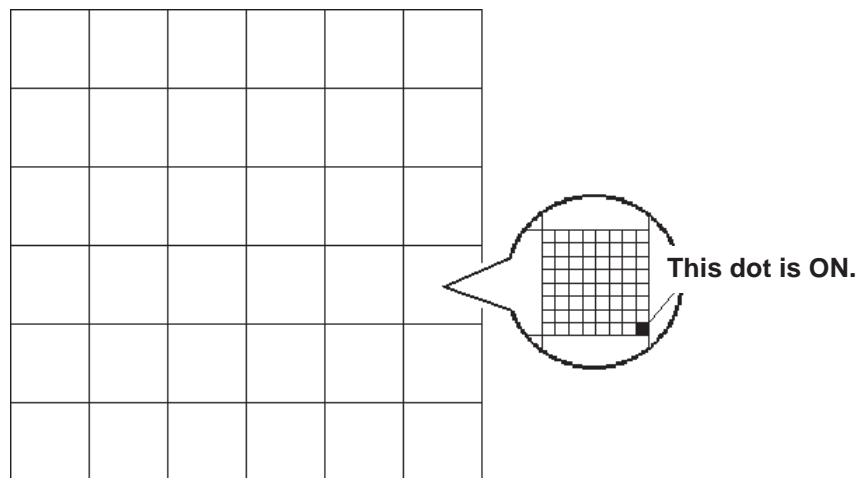

A Mark is created with dots, and displayed in a block (8 x 8 dots). If at least one dot is turned ON in a block, the whole block is displayed when the Mark screen is loaded onto a Base screen. In this status, the ON dots are displayed in the current display color (Fg), and the OFF dots are displayed in the background color (Bg).



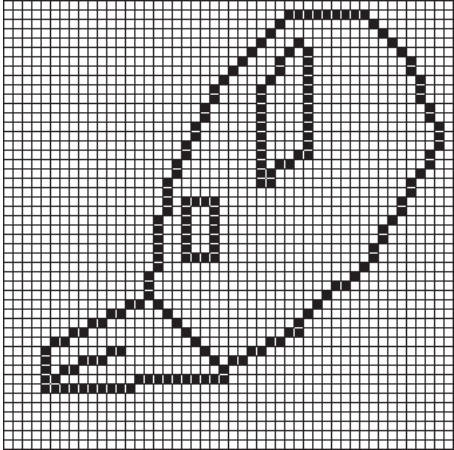

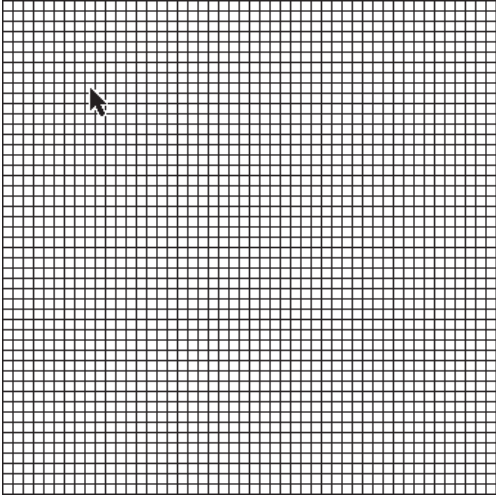
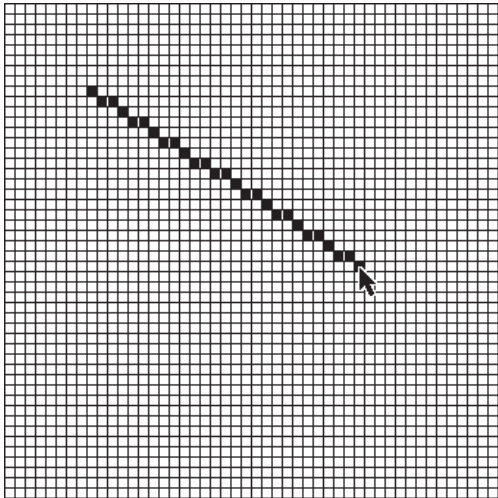

■ Freehand Drawing

| PROCEDURE | REMARKS |
|--|---------|
| <p>(1) Select the [Draw] menu - [Dot] command, or click on the  icon.</p> <p>(2) Draw a Mark by clicking on each dot or by dragging the mouse in the Mark drawing area.</p>  | |

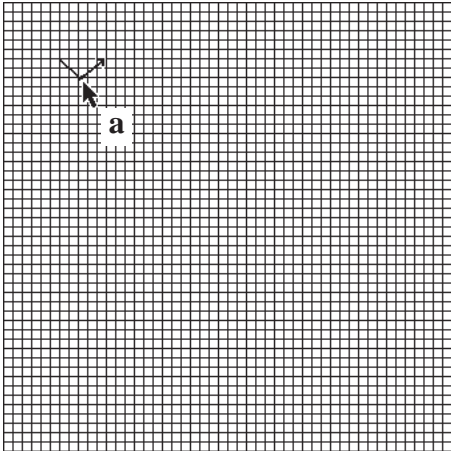
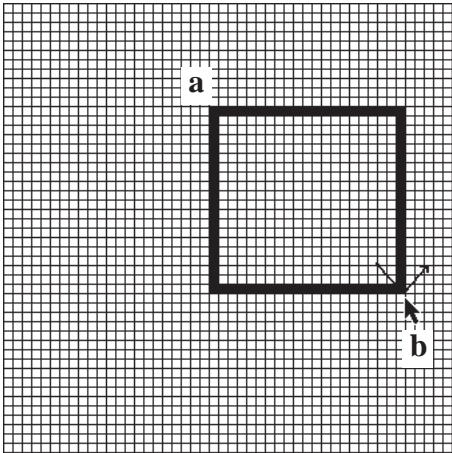

■ Drawing a Line

| PROCEDURE | REMARKS |
|--|--|
| <p>(1) Select the [Draw] menu - [Line] command, or click on the  icon.</p> <p>(2) Click on a start point in the mMark drawing area and drag the mouse.</p>  <p>(3) Click the end point in the Mark drawing area. A line is defined.</p>  | <p>If you press and hold the  key in step (2), you can draw a line at an angle of 0°, 45°, and 90°.</p> |

■ Drawing a Square (Rectangle) or Filled Square (Filled Rectangle)

| PROCEDURE | REMARKS |
|---|--|
| <p>(1) Select the [Draw] menu - [Square/Rectangle] or [Filled Square/Rectangle] command, or click on the  or  icon.</p> <p>(2) Click on a point (a) and drag the mouse on a diagonal axis in the Mark drawing area.</p>  <p>(3) Click on the end point (b). A square or rectangle is defined.</p>  | <p>If you press and hold the  key in step (2), you can draw a square.</p> |

■ Drawing Circle (Oval) or Filled Circle (Filled Oval)

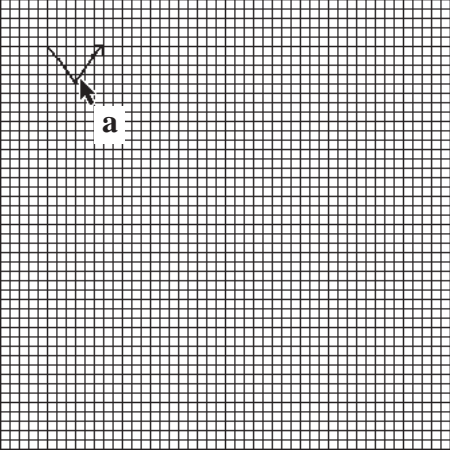
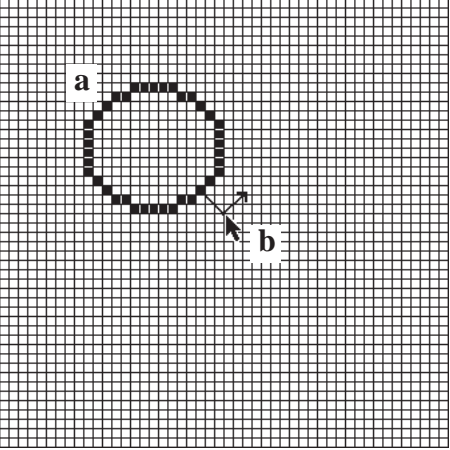

| PROCEDURE | REMARKS |
|---|--|
| <p>(1) Select the [Draw] menu - [Circle/Oval] or [Filled Circle/Filled Oval] command, or click on the  or  icon.</p> <p>(2) Click on a point (a) and drag the mouse on a diagonal axis in the Mark drawing area.</p>  <p>(3) Click on the end point (b). A circle or oval is defined.</p>  | <p>If you press and hold the Ctrl key in step (2), you can draw a circle.</p> |

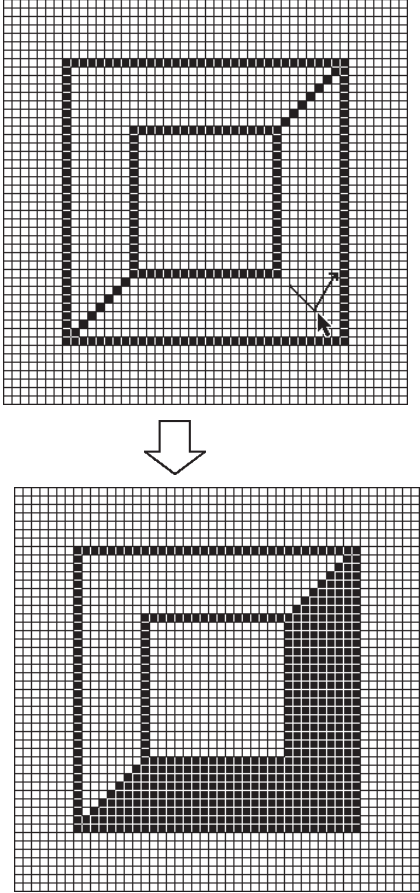
■ Filling a Mark

| PROCEDURE | REMARKS |
|--|--|
| <p>(1) Select the [Draw] menu - [Fill] command, or click on the  icon.</p> <p>(2) Click inside the area to be filled. The specified area will be filled.</p>  | <p>If you click on a line, the filling mode cannot be executed. Be sure to click inside a completely enclosed area, if you do not, the entire Mark screen may be filled.</p> |

■ Entering Text

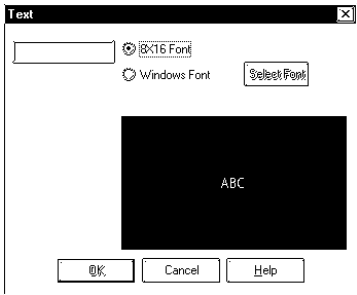
The “Text” mode allows you to enter text on a Mark screen.

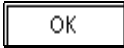
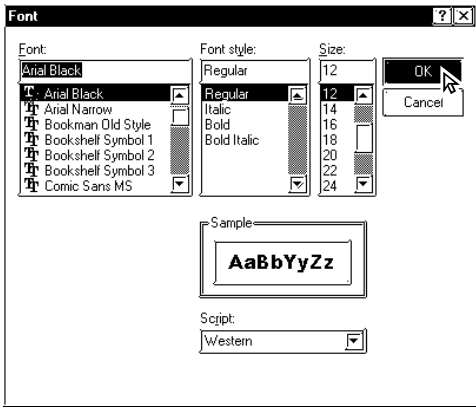
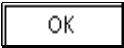
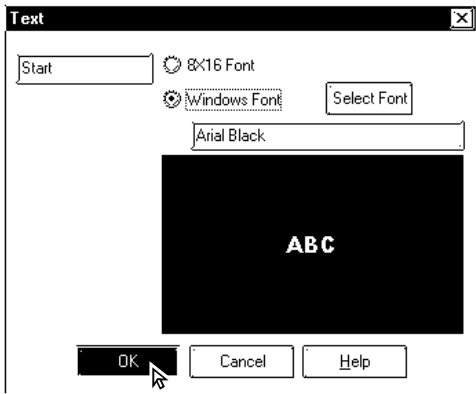
| PROCEDURE | REMARKS |
|--|---------|
| <p>(1) Select the [Draw] menu - [Text] command, or click on the  icon.</p> <p>(2) Enter character(s) and select either 8 x 16 dot font or Windows font.</p>  | |
| <p>(3) To use the Windows font, click on the  and click on the  button.</p>  | |
| <p>(4) Click on the  button.</p> <p>An outline corresponding to the entered character(s) will appear.</p>  | |

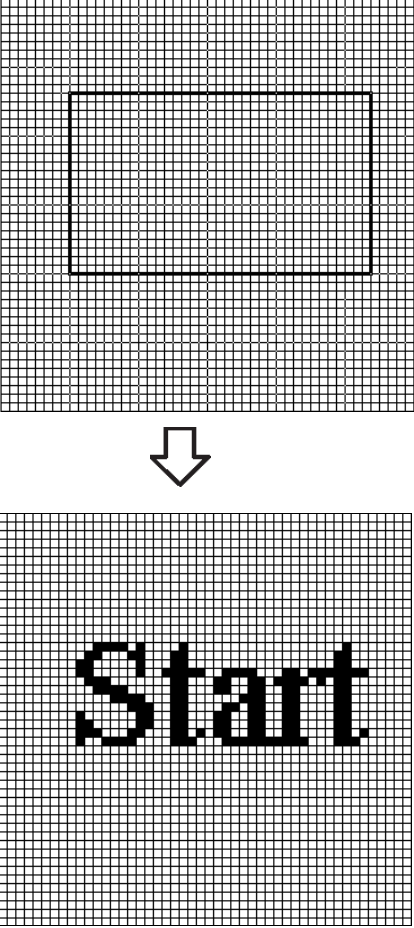

| PROCEDURE | REMARKS |
|---|---|
| <p>(5) Move the box to the desired position where the character pattern will be displayed. The character pattern is displayed in the position where you click. A Mark can be created using this pattern.</p>  | <p>If you move the character pattern to a position where another character pattern has already been created, the new pattern will overwrite the existing pattern, and the existing pattern will be deleted.</p> |

3.1.2 Editing a Mark

To edit a Mark, you can use the following editing functions. This section describes the operating procedure for each function.

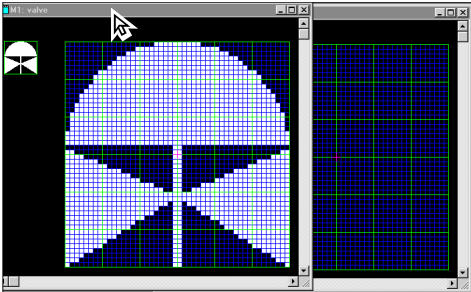

■ Cutting a Mark

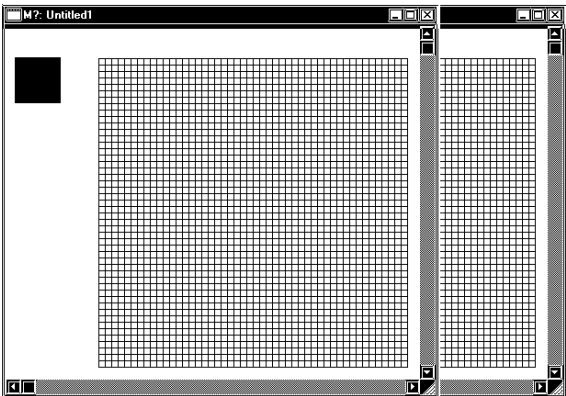
The “Cut” command deletes the data of the selected screen and stores it in the clipboard^{*1}. (The deleted screen can be moved to another screen, but cannot be moved to the original screen.) The “Cut” command can be executed for the entire screen.

| PROCEDURE | REMARKS |
|---|---|
| <p>(1) Select the original Mark screen to be cut. This description assumes that several screens have already been opened.</p>  <p>(2) Select the [Edit] menu - [Cut] command, or click on the  icon to store the Mark data in the Clipboard. Data of the original data screen will be cut.</p>  | <p>To delete the Mark screen, perform steps (1) and (2) only.</p> |

**1 When the [Copy] or [Cut] command is executed, the copied or cut data are temporarily stored in the clipboard.*

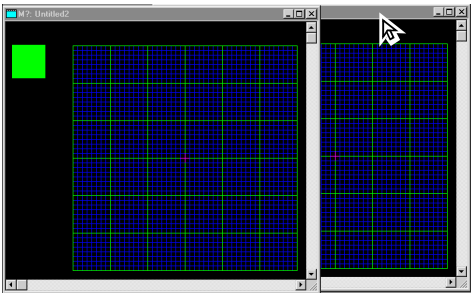
When you execute the [Paste] command, the data stored in the clipboard will be pasted to the selected position.

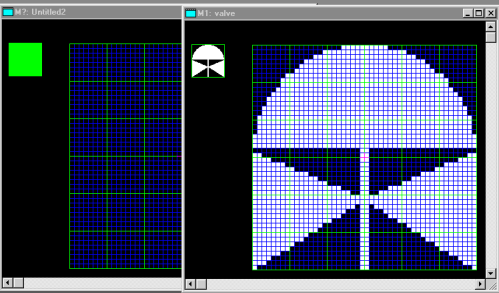



| PROCEDURE | REMARKS |
|---|---------|
| <p>(3) Select the mark screen (destination) to which the selected Mark screen will be pasted.</p>  <p>(4) Select the [Edit] menu - [Paste] command, or click on the  icon. Data of the Mark screen will be pasted.</p>  | |

■ Copying a Screen

The selected screen data are copied in the clipboard. Unlike the [Cut] command, the original screen data will not be deleted.

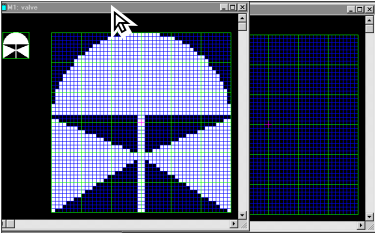

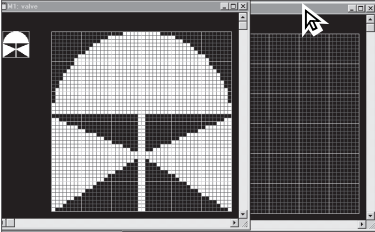

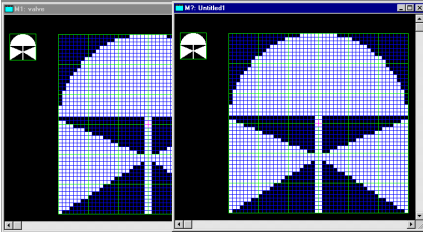
To copy a Mark into the original screen, use the [Duplicate] command.

| PROCEDURE | REMARKS |
|---|---------|
| <p>(1) Select the original Mark screen to be copied. This description assumes that several screens have already been opened.</p>  <p>(2) Select the [Edit] menu - [Copy] command, or click on the  icon to store the mark in the Clipboard.</p> <p>(3) Select the Mark screen (destination) to which the selected Mark screen will be copied.</p>  <p>(4) Select the [Edit] menu - [Paste] command, or click on the  icon. Data will be copied from the original Mark screen and pasted onto the destination Mark screen.</p>  | |

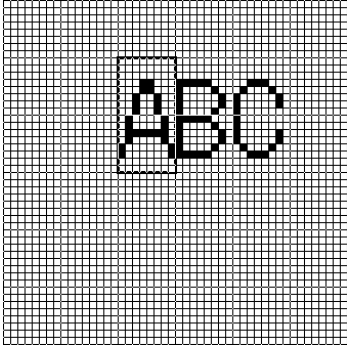

■ Copying a Specified Range : Duplication

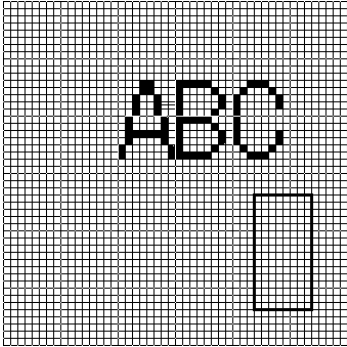
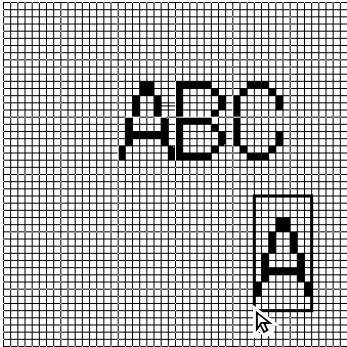
A specified range in the Mark drawing area can be duplicated by dots.

| PROCEDURE | REMARKS |
|--|--|
| <p>(1) Select the [Edit] menu - [Duplicate] command, or click on the  icon.</p> <p>(2) Specify the copy range in the same manner as drawing a square/rectangle. A box appears, indicating the specified copy range.</p> | |
|  |  <p><i>Important</i></p> <p><i>If you copy a mark into the position where another Mark has already been created, the new data will overwrite the existing data, and the existing data will be deleted.</i></p> |
| <p>(3) Move the box to a desired position where the data in the specified range will be copied. Data in the specified range will be copied to the position where you click.</p> | |
|  | <p>You can continue the copy mode until you click the right mouse button.</p> |
| <p>(4) To quit the copy mode, click the right mouse button.</p>  | |

■ **Deleting a Mark**

Delete the Mark, or a partion of it.

| PROCEDURE | REMARKS |
|--|---------|
| <p>(1) Select the [Edit] menu - [Delete] command, or click on the  icon.</p> <p>The procedures for deleting part of a Mark or deleting a whole mark are separately described:</p> <p>[Deleting Part of a Mark]</p> <p>(2) Select [Partial Clear] and click on the  button.</p> <div data-bbox="233 730 620 981" data-label="Image"> </div> <p>(3) Specify the range to be deleted in the same manner as drawing a square/rectangle.</p> <div data-bbox="226 1128 679 1581" data-label="Image"> </div> | |

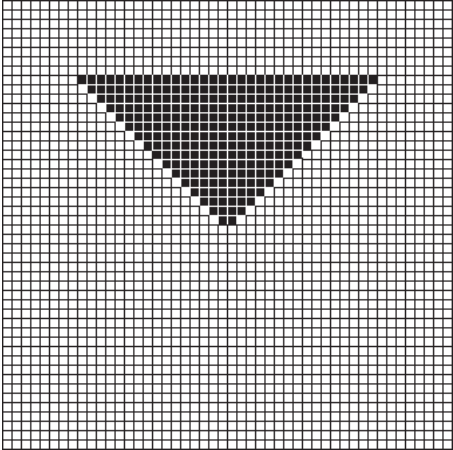
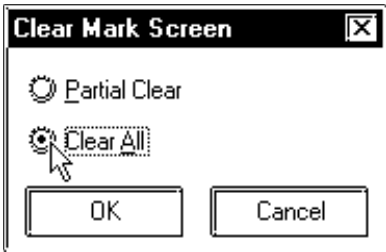
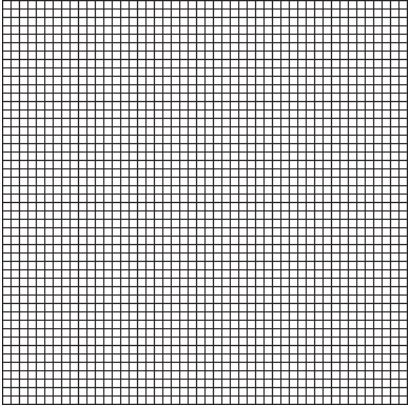
| PROCEDURE | REMARKS |
|--|---------|
| <p>(4) Click in the range to be deleted. The specified range will be deleted.</p>  <p>[Deleting the Entire Mark]</p> <p>(2) Select [Clear All].</p>  <p>(3) Click on the <input type="button" value="OK"/> button to delete the entire Mark. The entire Mark will be deleted.</p>  | |

■ Mirror X, Mirror Y

The “Mirror X” and “Mirror Y” functions move a Mark symmetrically relative to the vertical and horizontal axis, respectively.

To execute the “Mirror X” and “Mirror Y” functions, click on the   icon, respectively.

Example) Mirror X

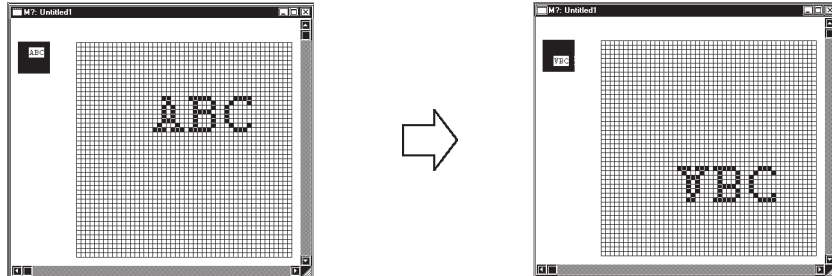

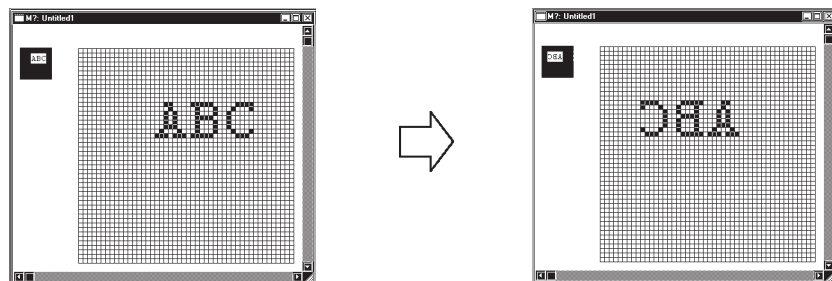

Example) Mirror Y



■ Turn Counterclockwise [O], Turn Clockwise [N]

The “Turn Counterclockwise”, “Turn Clockwise” functions turn the mark counterclockwise and clockwise 90°, respectively.

To execute the “Turn Counterclockwise” and “Turn Clockwise” functions, click on their respective the   icons respectively.

Example) Turn Counterclockwise

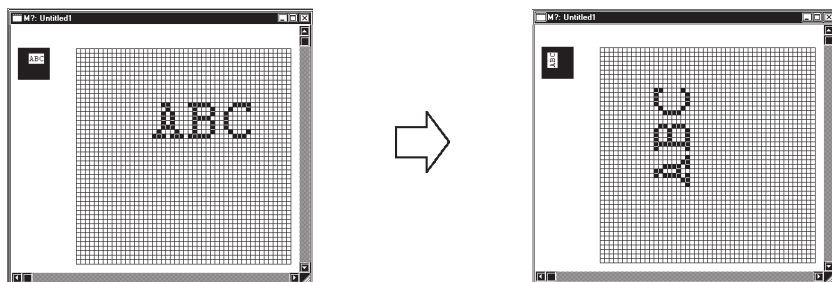

Example) Turn Clockwise

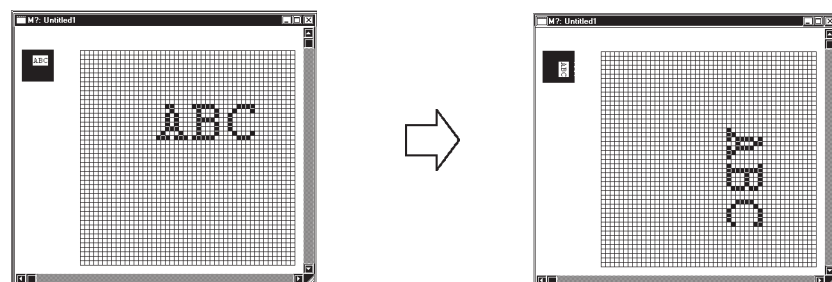

■ Reverse

This function reverses the white and black areas. In the reverse display mode, all ON dots are turned OFF, and all OFF-dots are turned ON.

To execute this function, click on the  icon.

Example)

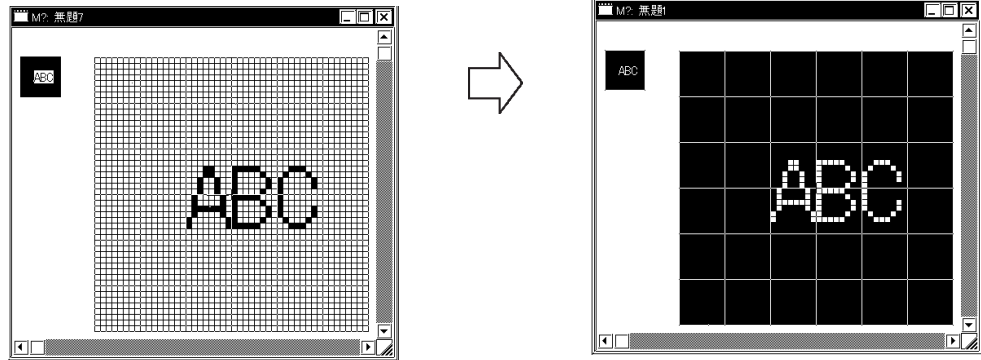

■ **Transparent/Background Color**

If no dots are turned ON in a block, this block becomes transparent. When this function is set to “Background color”, a block without any ON dots is displayed in the background color (Bg).

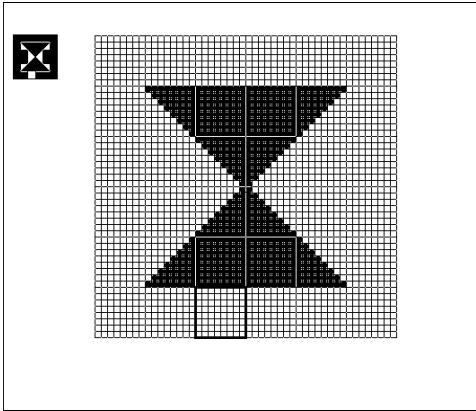
| PROCEDURE | REMARKS |
|---|---------|
| <p>(1) Select the [Edit] menu - [Background Color] command, or click on the  icon.</p> <p>(2) Click in the block to be displayed in the background color. The border line of the specified block is changed. Every time you click in the block, the color setting is switched.</p> <div style="border: 1px solid black; padding: 10px; width: fit-content; margin: 10px auto;">  </div> <p>(3) Click the right mouse button to register the above setting.</p> | |

■ **Display When Called Up to a B (Base) Screen**

When this function is set to “Transparent”:

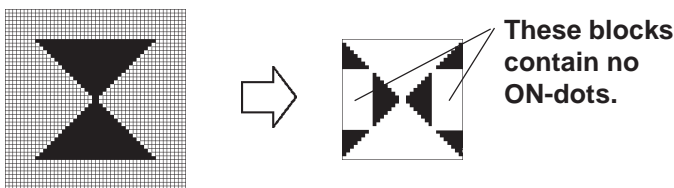

If at least one dot is ON in a block, this block is displayed in the background color. The block with no ON dots becomes transparent, and you can see the objects on the base screen.

When this function is set to “Background color”:

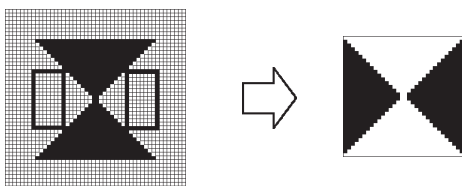

The block with no ON dots is displayed in the background color.

■ Canceling a Command: Undo

This function is used to cancel a command and return to the previous condition immediately before the command was made.

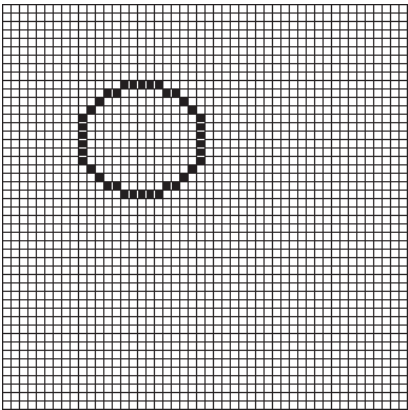

[Undo] is only effective for the command immediately before it.

| PROCEDURE | REMARKS |
|---|---------|
| <p>After deleting a circle unintentionally:</p> <p>(1) Select the  icon.</p> <p>The deleted circle is restored, and the screen returns to the previous condition.</p>  | |

■ Redo Command

This function is used to redo the command canceled with the [Undo] command.

The [Redo] command is effective only for the command immediately before it.

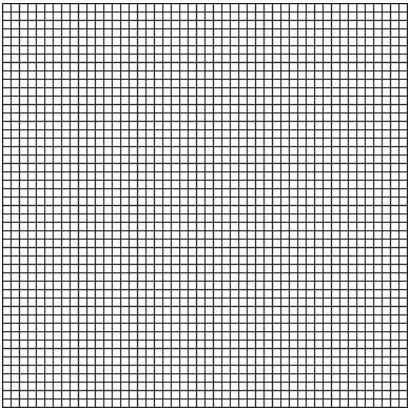
| PROCEDURE | REMARKS |
|--|---------|
| <p>After deleting a circle, you have selected the  icon to return to the previous condition, but you realize that actually, the circle must be deleted:</p> <p>(1) Select the  icon.</p> <p>The screen returns to the condition where the circle has been deleted and harmony is restored.</p>  | |

3.1.3 Registering and Placing a Mark Library Item

You can register a mark created in the mark drawing area and the registered Mark can be loaded whenever required. The Mark Library Item (mark list) can be saved as a Mark library file (MRK file). The LT Editor enables you to manage MRK files independent of project (LTE) files. This function allows you to use the same MRK for several projects, since you can select a desired Mark while checking the image displayed in the browser. Registration, placement, and other editing operations of Mark Library are performed in the same manners as those of the standard Libraries.

Reference *2.4 Libraries*



Note: LT Editor has pre-made MRK files in correspondence with the ISO7000 Series Marks and symbols.

Reference *Parts List Manual*

| Drawing symbol number | MRK file name | Title |
|-----------------------|---------------|-----------|
| 0001-0200 | IS07-1 | 0001-0200 |
| 0201-0400 | IS07-2 | 0201-0400 |
| 0401-0600 | IS07-3 | 0401-0600 |
| 0601-0800 | IS07-4 | 0601-0800 |
| 0801-1000 | IS07-5 | 0801-1000 |
| 1001-1140 | IS07-6 | 1001-1140 |

3.2 Creating an Image: the Image Screen

When you convert image data (bitmap = BMP file) read with an image scanner into an Image screen for the LT series, the image data can be displayed on the LT series panel. Even though your original image file can be up to 256 colors, since the LT can only display in 64 colors, the file's colors will be converted to the LT's 64 colors.

You can load an Image screen onto a Base screen, Trend Graph screen, or Keyboard screen by selecting the [Draw] menu - [Load Screen] command.

Reference 2.2.10 Load Screens

You can animate the Image screen by using the L-tag. However, the Image screen cannot be opened.

To convert image data into Image screen data for the LT series, use the [Utility] menu - [Convert Bitmap] command. This command can convert image data of up to 800 x 600 dots.



Note: You can also perform the bit map conversion by selecting the [Edit] menu - [Convert/Place Bitmap] command.

Reference 2.3.18 ♦ Converting and Placing a Bitmap

Image screens cannot be edited. To edit the image data, you must use the original file, and then convert this file into Image screen data. The Image screens can be checked on the screen list.

Reference 4.1.1 ■ Listing Screens

3.2.1 Bitmap Conversion

Convert image data (bitmap = BMP file) created with another editor software or read with an image scanner into an Image (I) screen for the LT series. The LT Editor can convert image data displayed in 2 colors (monochrome data), 16 colors, 64 colors, and 256 colors.

With a color Image screen, when the data volume becomes large the LT series' display speed is increased. With a monochrome Image screen, the LT series' display speed is slightly lowered, but the data volume can be reduced. Select a color or monochrome Image screen according to your purpose.

If the data volume is too large to be displayed on one screen, the converted data will be divided into several screens (up to nine screens) of 50 Kbytes each.



- Compressed BMP files cannot be converted.
- Make sure that the original image data's longitudinal dimension ("X" for the horizontal type, and "Y" for the vertical type in the figure below) is a multiple of "4" for color data, or a multiple of "8" for monochrome data. Otherwise the fractional data will be deleted from the right edge of the screen after conversion.

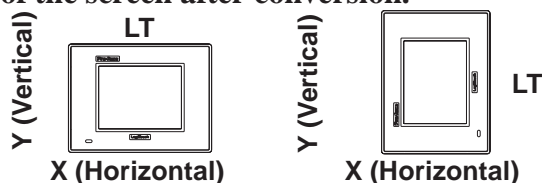

- If the longitudinal dimension of the original image data is less than "4" for color data, or less than "8" for monochrome data, the image data cannot be converted.

■ **Converting/Placing a Bitmap: [Source]**

Specify the bitmap file to be converted. The information on the specified bitmap file will be displayed.

Enter the name of the bitmap file to be converted, or select the bit map file from the file list by clicking on the [Browse] button

Displays information on data colors (e.g. 16 colors, 256 colors)

Displays the size of the bitmap file

Displays the dimensions (horizontal x vertical) of the bitmap data

Used to select the bitmap file to be converted

Displays the image of the bitmap file to be converted. However, this image is different from the image that will be displayed on the LT series

Used to register the above settings to execute the bitmap conversion. If you save the converted bitmap data, the Image screen of the screen number specified in [Screen Setting] will be created

■ **Converting/Placing a Bitmap: [Effects]**

Specify the brightness, resolution, blinking, compression, and mirror functions for the converted image data.

Used to set the brightness and display quality automatically

Used to manually set the individual options of the brightness and display quality

◆ **Use Default Effects**

When you specify Use Default Effects, the original data will be automatically converted into the image data with the optimum brightness and display quality.

◆ **Brightness**

Used to convert bitmap data according to the brightness level. The reference value can be changed between levels “0” and “15”. A larger value indicates a brighter image, and a smaller value indicates a darker image.

◆ **Dithering**

Used to set the converted data’s display quality.

- ◆ **Blink**
Used to make the converted data blink.
- ◆ **Compress**
Used to compress the original bit map data during conversion.
- ◆ **Mirror**
Used to replace the original bit map data symmetrically relative to the X-axis or Y-axis during conversion.

■ **Converting/Placing a Bit Map: [Destination]**

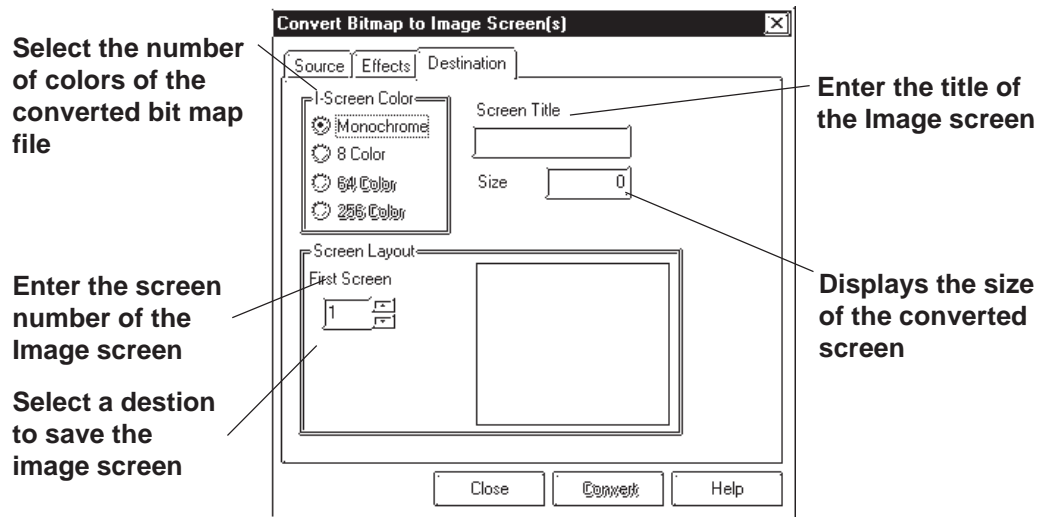

- ◆ **Screen Color**
Select the type of the converted bit map file: Monochrome, 8-colors, 64-colors or 256-colors. The screen size and the number of screen divisions vary depending on the selected type.
- ◆ **First Screen**
Enter the screen number of the Image screen. If no screen number is specified, an Image screen of the currently displayed screen number will be created.
- ◆ **Screen Title**
Enter the title of the Image screen. Even if the converted data are divided into several screens, only one title can be specified for one original file.
- ◆ **Size**
Displays the size of the converted screen.

■ Converting a Bitmap

Convert a bitmap file into Image screen data.

| PROCEDURE | REMARKS |
|-----------|---------|
|-----------|---------|

(1) Select the [Utility] menu - [Convert Bitmap] command of the Project Manager.

(2) Click on the button, and select a bitmap file to be converted.

The color type, data volume, screen size and image data of the bitmap file will be displayed.

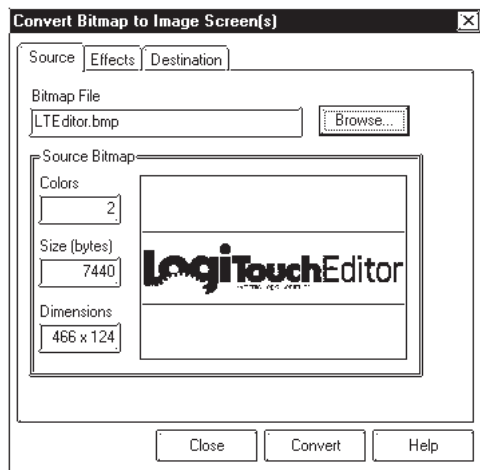

(3) Specify the conversion parameters.

If the data volume is too large to be displayed in one screen, the image data will be divided into several Image screens.

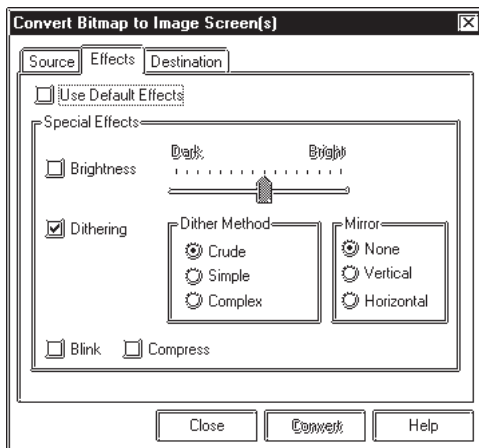



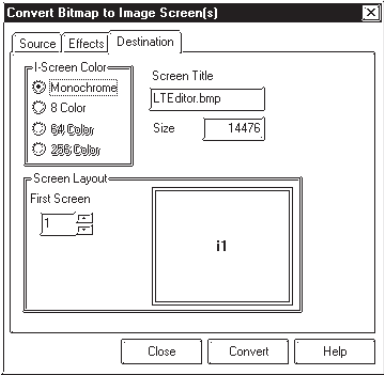
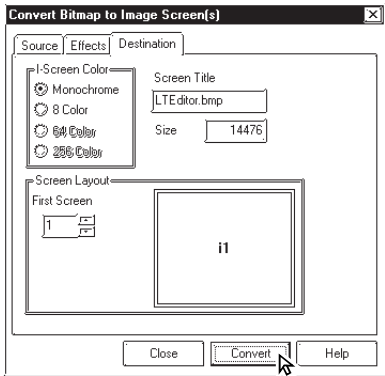
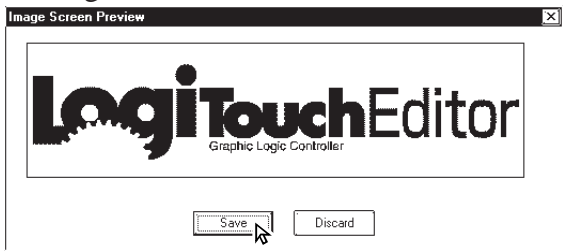
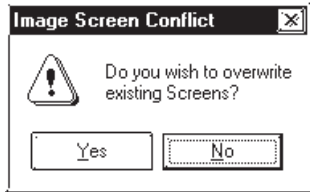
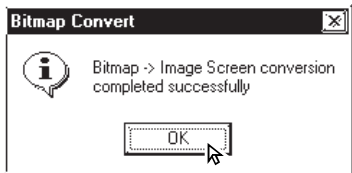

If the original data are monochrome, these conversion parameters cannot be specified.

| PROCEDURE | REMARKS |
|--|--|
| <p>(4) Enter the screen number and title of a new Image, and designate Screen Type. If you do not set a title, the title of the original BMP file will be specified.</p>  | <p>The number of colors specified for [Screen Color] must be equal to the number of display colors supported by your LT series.</p> <ul style="list-style-type: none"> · If the number of colors is different, the display speed will be lowered. · Any colors that are not supported with your LT series cannot be displayed. |
| <p>(5) Click on the <input type="button" value="Convert"/> button to perform data conversion. The image data conversion starts. Then, the converted image will be displayed.</p>  | <p>If the same screen number already exists, the system asks if you want to replace the existing screen with the one you are attempting to save. If so, select <input type="button" value="Yes"/>; otherwise, select <input type="button" value="No"/>.</p> |
| <p>(6) If the displayed image is correct, click on the <input type="button" value="Save"/> button. An Image screen is created.</p>  |  |
| <p>(7) Click on the <input type="button" value="OK"/> button to quit the conversion mode.</p>  | <p>To cancel conversion, click on the <input type="button" value="Discard"/> button.</p> <p>If data conversion is executed with the [Edit] menu - [Convert/Place Bitmap] command, the converted image will be placed in the Image screen immediately after data conversion.</p> |

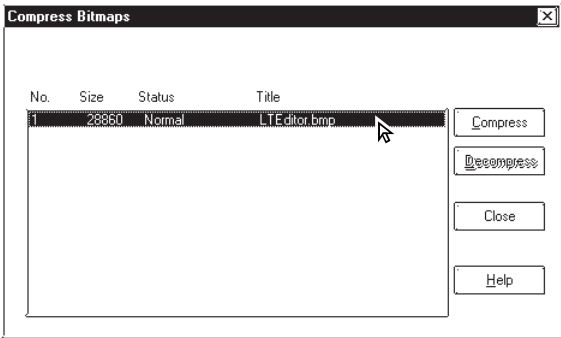
3.2.2 Compressing/Decompressing an Image Screen

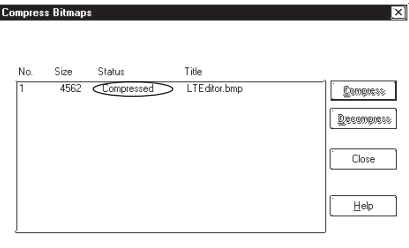
If an Image screen has a large data volume, you can compress the bitmap data to reduce the data size, and send the compressed Image screen directly to the LT series. With the compressed Image screen, however, the LT series' display speed will be lowered.

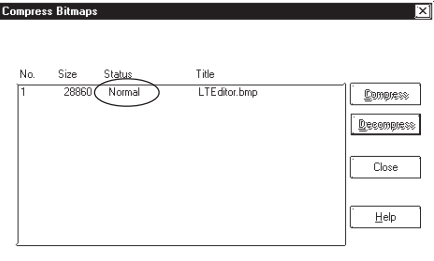
| PROCEDURE | REMARKS |
|---|---|
| <p>(1) Select the [Utility] menu - [Compress Bitmap] command of the Project Manager.</p> <p>(2) Select the screen to be compressed or decompressed from the list.</p>  <p>The compression and decompression procedures are separately described as follows:</p> <p>[Compression]</p> <p>(3) Click on the  button to execute data compression. The process is finished when the word "Compressed" appears.</p>  <p>[Decompression]</p> <p>(3) Click on the  button to perform data decompression. The process is finished when the word "Normal" appears.</p>  | <p>To compress an Image screen (bit map data) of another project, select the project.</p> <p>Reference 1.2.2 ■ <i>Selecting an Existing Project</i></p> <p>To select several screens, click on the screen numbers while pressing the [Shift] key.</p> <p>To select a specified screen, click on the screen number while pressing the [Ctrl] key.</p> |

4

SCREEN AND PROJECT MANAGEMENT

As you use the LT Editor, file management work such as copying and deleting created screens and projects will increase, thereby improving your work efficiency. This chapter covers “Information Management of your data.”

| | |
|------------|--|
| 4.1 |Screen Editing |
| 4.2 |Project Editing |
| 4.3 | Project Compression/Decompression |
| 4.4 | Information Display |

4.1 Screen Editing

This section describes the commands used to edit a screen, such as listing screens, and copying/deleting a specified screen.

4.1.1 Listing/Copying/Deleting Screen

You can list the number, size and title of all existing screens for each screen type. You can also print out this screen list.

Reference 9.1 Print Settings

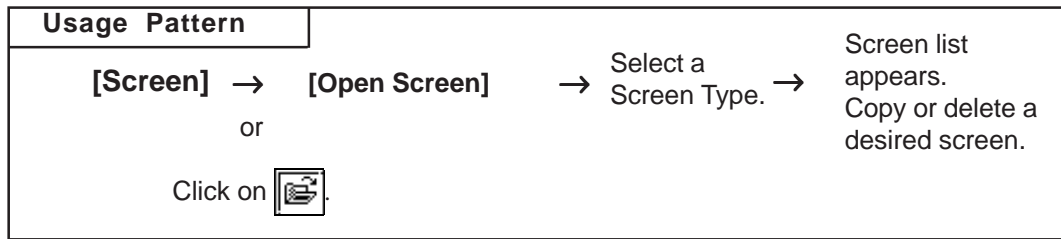

■ Listing Screens

This feature lists screens for the current project.

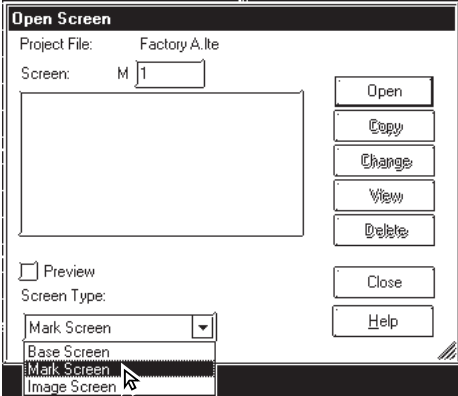
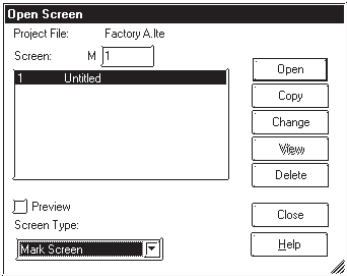
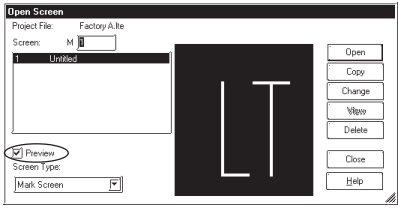
| PROCEDURE | REMARKS |
|--|--|
| <p>(1) Via the Screen Editor, select the [Screen] menu - [Open Screen] command, or click on the  icon.</p> <p>(2) Select the type of screens to be listed. The screens will be automatically listed.</p>  <p style="text-align: center;">↓</p>  | <p>By checking the [Preview] check box, the selected screen image can be viewed in the dialog box.</p>  <p>By changing the [Open Screen] dialog box's size, the screen list display area can be enlarged so that more screens can be displayed.</p> <p>Reference To print the screen list, refer to 9.1 ■ Print Settings.</p> |

■ Copying Screens

This feature copies a screen from the current project file.

| PROCEDURE | REMARKS |
|-----------|---------|
|-----------|---------|

(1) Via the Screen Editor, select the [Screen] menu - [Open Screen] command, or click on the  icon.

(2) Select a screen to be copied from the list, and click on the  button.

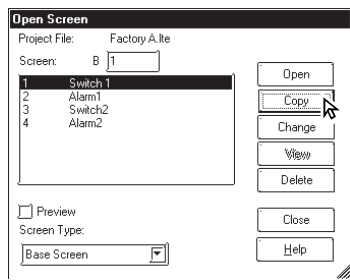

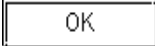
(3) Specify the Start Screen Number of the copy destination and copy count. Then, click on the  button.

The screen will be copied for the designated number, consecutively from the Start Screen No.

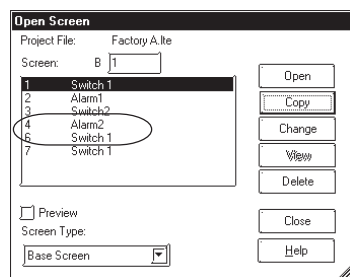
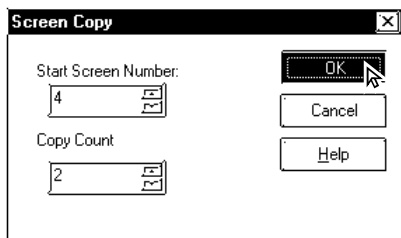

To select several screens simultaneously, drag the mouse down the list, or click on the target screens while pressing your PC's **[Shift]** key or **[Ctrl]** key.







When selecting multiple screens simultaneously, copy will be performed only one time.

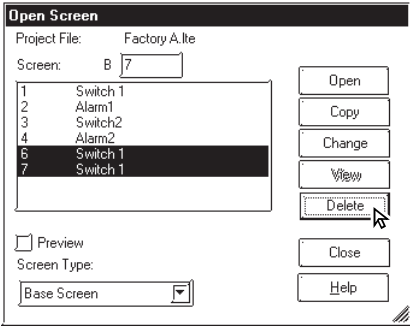

Important
Once the [Copy] command is performed, it cannot be undone.

■ Deleting Screens

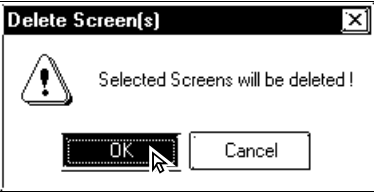
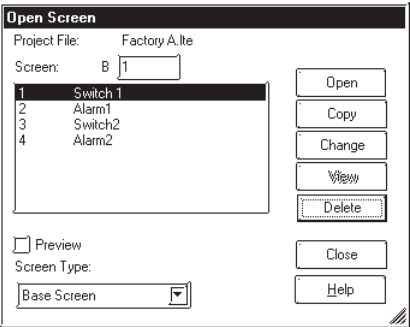
This feature deletes a screen from the current project file.

| PROCEDURE | REMARKS |
|--|---|
| <p>(1) Via the Screen Editor, select the [Screen] menu - [Open Screen] command, or click on the  icon.</p> <p>(2) Select a screen to be deleted from the list, and click on the  button.</p>  <p>(3) Click on the  button to delete the screen.</p>  <p style="text-align: center;">↓</p>  | <p>To select several screens simultaneously, drag the mouse down the list, or click on the target screens while pressing your PC's [Shift] key or [Ctrl] key .</p> <p style="text-align: center;"> Important</p> <p>Once the [Delete] command is performed, it cannot be undone.</p> |

■ **Changing Screen Numbers and Titles**

This feature allows you to change screen numbers and titles in the current project file.

| PROCEDURE | REMARKS |
|-----------|---------|
|-----------|---------|

[Changing only One Screen]

(1) Via the Screen Editor, select the [Screen] menu - [Open Screen] command, or click on the  icon.

(2) Select a screen to be changed from the list, and click on the  button.

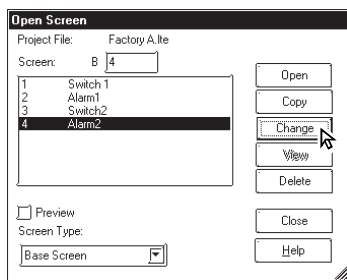

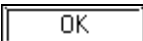
(3) Change the screen number and title, and then click on the  button to delete the screen.

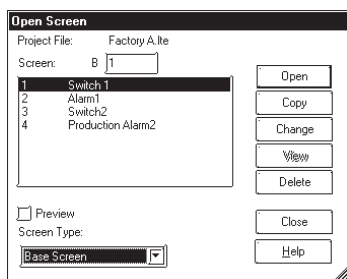
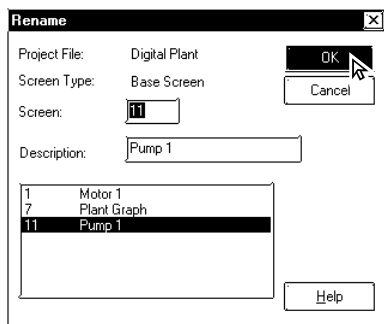

Important

If any existing screen number is specified, it will be overwritten.

The currently open screen cannot be changed.

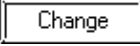
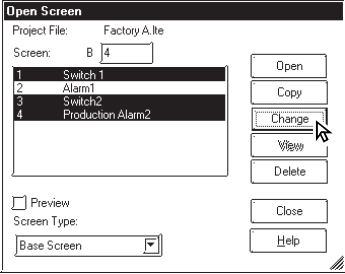
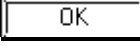
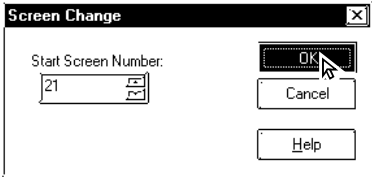
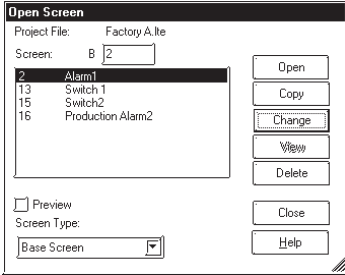
| PROCEDURE | REMARKS |
|--|--|
| <p>[Changing Multiple Screens at a Time]</p> <p>(1) Via the Screen Editor, select the [Screen] menu - [Open Screen] command, or click on the  icon.</p> <p>(2) Select multiple screens to be changed from the list, and click on the  button.</p>  <p>(3) Specify the start screen number at the destination, and then click on the  button. “13” is specified here. The specified number comes to the top, and the subsequent numbers are changed automatically with increments of offset values.</p>  <p style="text-align: center;">↓</p>  | <p>To select multiple screens at a time, drag the mouse through the desired screens on the list, or click on those screens while holding the Shift or Ctrl key down.</p> <p>The currently open screen cannot be changed.</p> <p>The difference between the start screen number and that at the source is taken as an offset value. Since the start screen number, 1 is to be changed to 13 here, the offset value is 12. This offset value is added to the subsequent screen number 2 and 5, which is then changed to 14 and 17.</p> |

4.1.2 Copying Screens from Other Projects

Screens created in any project file other than the currently open one, and other settings can be copied to the currently open screen.



Note: To copy a logic program from other project files, import a logic program file (*.wll) with the Logic Program Editor.

Reference *"Logic Programming Operation Manual"*

■ Specifying Items to Be Copied

After selecting a project file as the copying source, specify the items you want to copy, such as the screen area to be copied and other settings, and a copying method.

Specify the screen area to be copied from the project file at the copying source.

Specify the settings other than the screen to be copied from the project file at the copying source.

Specify the start screen number in the project file at the copying destination. The specified data will be copied to this and subsequent screens.

◆ Source

The project file selected as the copying source is displayed. Specify the screen area to be copied and a screen type. If you are not copying a screen, but other settings only, select [Internal Settings].

◆ Destination



The current project file is displayed. When copying a screen from another project file, specify the start screen number in the project file at the copying destination to start copying the screen.

◆ Internal Settings

Select the items to be copied among the global settings for each project file, which are not dependent on any screen. Also specify whether the settings existing in the current project file are deleted by overwriting them or merged (added) with additional settings without deleting them. If "Overwrite" is specified, the settings at the copying destination will be deleted and all the settings at the copying source will be copied. If "Merge" is specified, the settings at the copying source will be copied while those at the copying destination are left as far as possible.

When such a merge is made using [D-Script Functions] or [Filing Data], you will be prompted to confirm whether any identical existing number or function name is to be overwritten. When the combination is made using [Data Sampling] or [Global D-Script] all the settings will be merged.

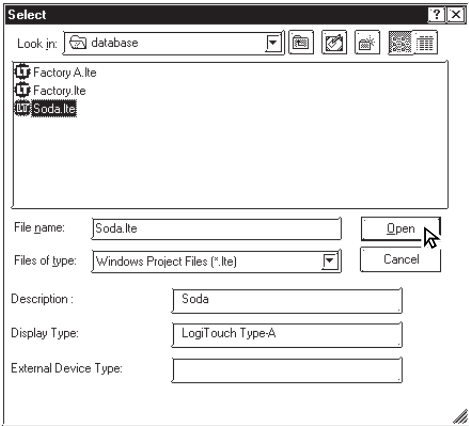
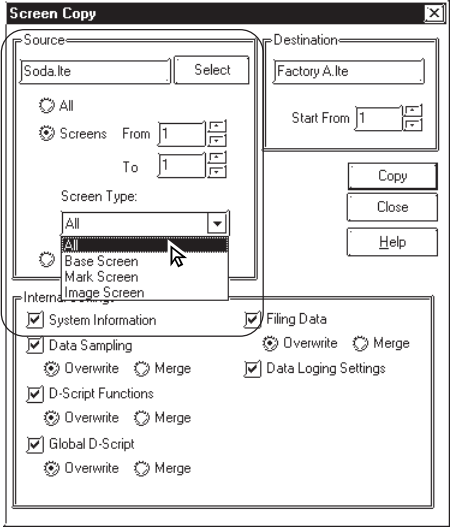
■ Copying Screens from Other Projects

| PROCEDURE | REMARKS |
|---|--|
| <p>First, open the copy designation project.</p> <p>(1) Select the Project Manager's [Utility] menu - [Screen Copy] command.</p> <p>(2) Select the project file to be copied (original project file) from the screen list, or enter the target project name, then click on the  button.</p>  <p>(3) Enter the screen type and screen number of the original screen. Those screens corresponding to the specified initial screen number through the final screen number will be copied.</p>  | <p>To select a screen located in a different folder, you must change to that folder.</p> <p>Reference 1.2.2 ■ <i>Selecting an Existing Project</i></p> <p>The currently opened project cannot be selected.</p> <p>When you double-click on the project name selected in step (2), you can skip the  command.</p> <p>If you select [All], all screens from the current project will be copied.</p> |

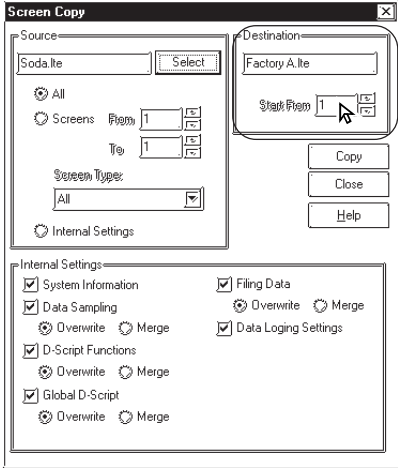
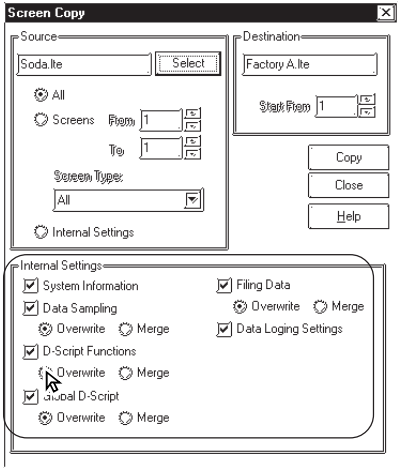
| PROCEDURE | REMARKS |
|---|---------|
| <p>(4) Enter the screen type and screen number of the destination screen.</p> <p>The screens will be copied to the Destination project, starting from the specified initial screen number onwards.</p>  | |
| <p>(5) Select the internal settings to be copied, and specify a copying method (overwrite or merge).</p>  | |
| <p>(6) After confirming your selection and designation, click on the <input type="button" value="Copy"/> button.</p> <p>If there is any screen of an identical number or function name, you will be prompted to conform whether or not to overwrite it. Selecting <input type="button" value="Yes"/> will overwrite such a screen or function name, and selecting <input type="button" value="No"/> will proceed to the next question. If <input type="button" value="Yes All"/> is selected, all the screens or settings will be overwritten. If <input type="button" value="No All"/> is selected, only the screens or settings that do not exist at the copying destination will be copied.</p> | |

| PROCEDURE | REMARKS |
|--|--|
| <div data-bbox="212 239 572 674"> </div> <div data-bbox="352 687 405 770"> </div> <div data-bbox="212 766 780 891"> </div> <p data-bbox="165 934 911 1010">(7) Click on the OK button to exit the screen copy mode.</p> <p data-bbox="199 1016 911 1090">The number of screens copied will be displayed in the dialog box.</p> <div data-bbox="212 1102 552 1449"> </div> <p data-bbox="165 1476 638 1514">(8) Click on the Close button.</p> <div data-bbox="212 1541 673 2078"> </div> | <div data-bbox="954 734 1066 840"> </div> <p data-bbox="954 813 1066 840">Important</p> <p data-bbox="954 851 1401 965">After replacing the screens, you must re-enter all Parts device addresses.</p> <p data-bbox="954 1039 1401 1189">To subsequently copy any other screen in the same project file, repeat the procedures starting with step (3).</p> |

4.2 Project Editing

4.2.1 Deleting Project Files

This feature allows you to delete a project file.

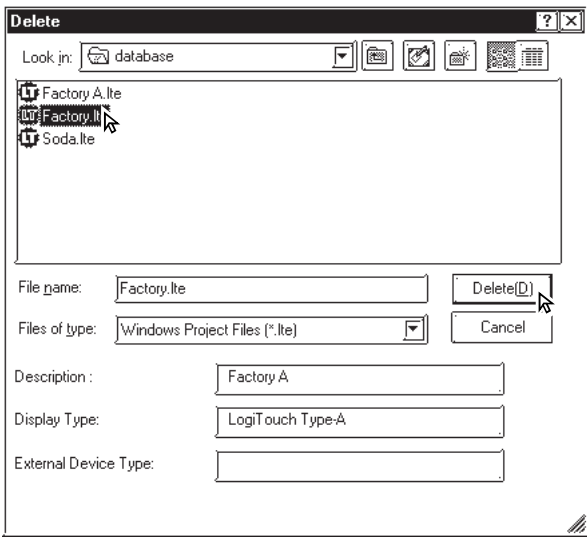
| PROCEDURE | REMARKS |
|---|--|
| <p>(1) Via the Project Manager, select the [Project] menu - [Delete] command.</p> <p>(2) Select the project to be deleted from the screen list, or enter the desired project's file name. Then, click on the <input type="button" value="Delete(D)"/> button.</p>  <p>(3) Click on the <input type="button" value="Yes"/> button to delete the project.</p> | <p>To select a project located in a different folder, change the directory to that folder.</p> <p>Reference 1.2.2 ■ <i>Selecting an Existing Project</i></p> <p>When you double-click on the project name selected in step (3), you can skip the <input type="button" value="Delete(D)"/> command.</p> <p>Important</p> <p>Once the [Delete] command is performed, it cannot be undone.</p> |

4.2.2 Rebuilding A Project (Rebuild)

The “Rebuild” tool is used to both check the contents of the LTE files, CPW files and MRK files created with LT Editor, as well as to rebuild these files if they are damaged.

In the following cases, use the “Rebuild” command to restore file data.

1. Your personal computer is either reset or shut down while you are saving data.
2. The system crashed while you were saving data.
3. Your floppy disk or hard disk is damaged.
4. Your personal computer’s disk drive is defective.
5. A system error (an error not specified in the error message list, such as a partition or checksum error) occurs while a screen is being opened or transferred.
6. The desired project file does not display as a LTE file during project selection, or an existing screen’s number is not displayed when you try to open that screen.
7. You cannot select a project file when you try to perform the [Select Project] command. (i.e. the LT Editor program cannot recognize the project file as a LTE file)
8. Parts placed on the LT Editor program screen cannot be displayed on the LT unit, or, a different screen than desired is displayed on the LT unit. (i.e. the relationship between the screen data and Parts data is not correct)
9. When you try to open a file, an error message appears, indicating that the file is damaged.

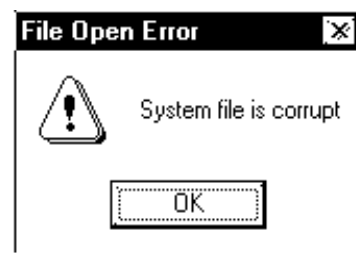

If this error message is displayed, LT Editor program cannot read the target file until this file is rebuilt.



If a file’s data cannot be completely restored with the “Rebuild” tool, the system treats this data as abnormal data and deletes it. In this case, you must edit this LTE file using LT Editor program after the “Rebuild” command is performed.

■ **Rebuilding**

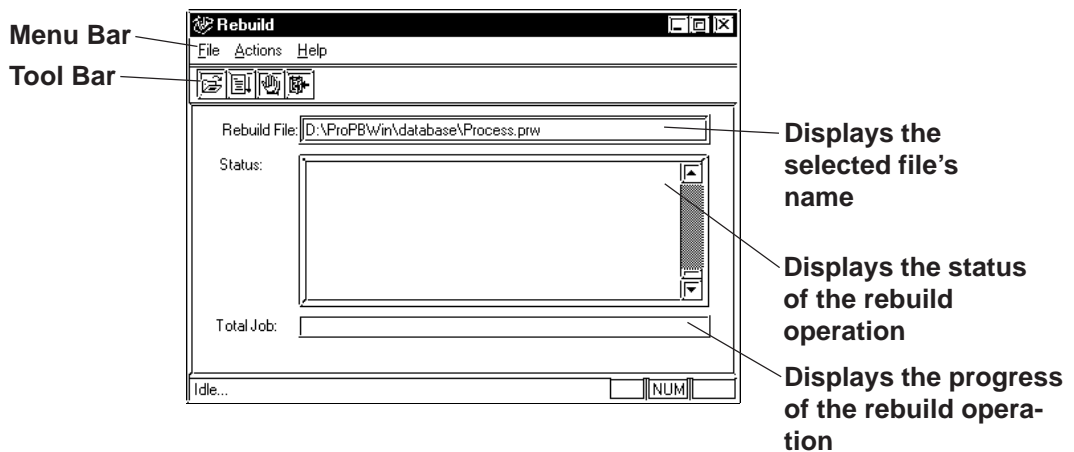
General description of the “Rebuild” screen is as follows:



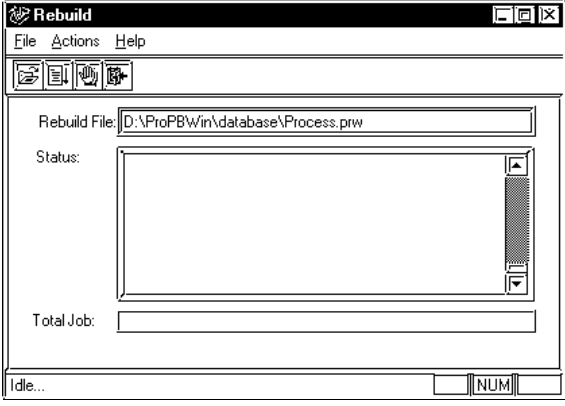
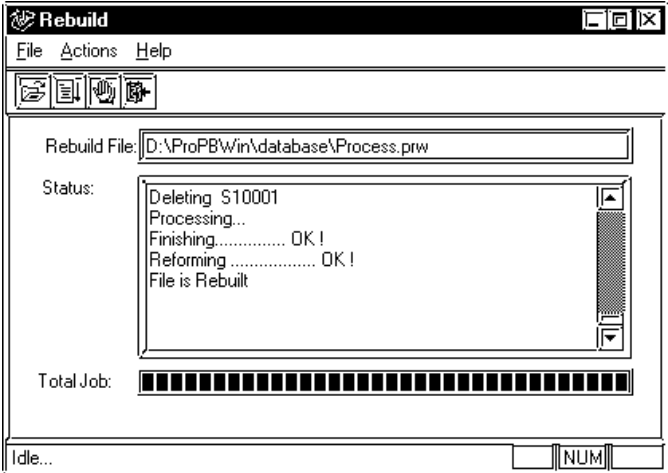

| PROCEDURE | REMARKS |
|---|---------|
| <p>(1) To rebuild a file, click on the Windows main menu’s [Start] button. Point to the [Program] - [LogiTouch] menu, and select the [Rebuild] command.</p> | |
| <p>(2) Select the [File] menu - [Open] command, or click on the icon.</p> | |
| <p>(3) Select the file to be rebuilt, or enter the file name. Then, click on the button.</p> | |

| PROCEDURE | REMARKS |
|--|--|
| <p>(4) After confirming that the file name is correct, select the [Actions] menu - [Start] command, or click on the  icon. The selected file will then be rebuilt.</p>  <p style="text-align: center;">↓</p>  <p>(5) Select the [File] menu - [Exit] command, or click on the  icon and finish the rebuild operation.</p> | <p>To cancel file rebuilding, click on the  icon.</p> |

4.2.3 Converting Addresses and Device Codes

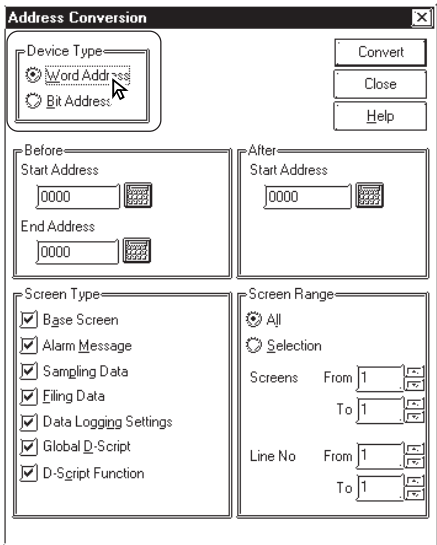
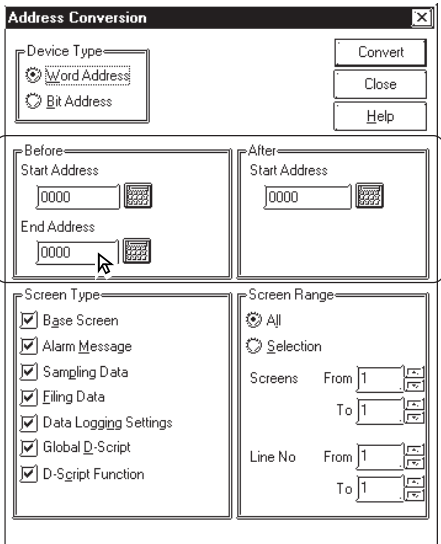
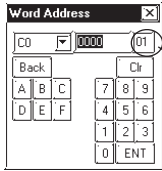
This feature allows you to change a Part's addresses. This address conversion can be performed on either word or bit addresses. This command is useful for changing both addresses or an address' device code.

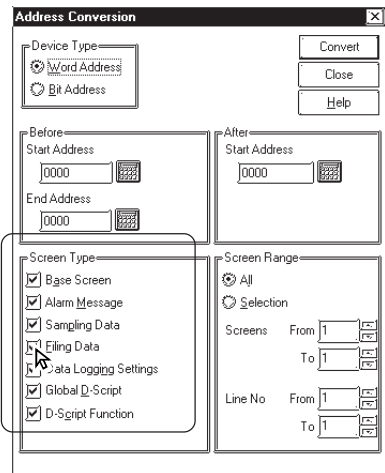
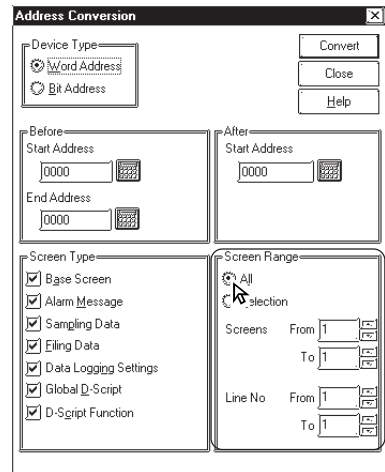
| PROCEDURE | REMARKS |
|--|--|
| <p>(1) Via the Project Manager, select the [Utility] menu - [Convert Addresses] command.</p> <p>(2) Select the type of the address conversion to perform: Word Address or Bit Address.</p>  <p>(3) Enter the address conversion range and the updated initial address.</p> <p>Before this step is performed, be sure that the first and last device codes used are the same. You cannot specify an address conversion range for a different device.</p>  | <p>In word address conversion mode, Part addresses specified by a bit address can also be changed, within a specified range.</p> <p>When using any of the following External Devices, specify the External Device number, as well: FACTORY ACE, 1:n communication (Yokogawa Electric Corp.) SDC Series (Yamatake Electric Corp.) THERMAC NEO series (OMRON)</p>  <p>External Device No.</p> <p>When converting addresses, be sure that the address settings meet the following condition: “Final address before conversion” - “Initial address before conversion” ≤ “Final address after conversion” - “Initial address after conversion”</p> <p>If the left side is larger than the right side in the above formula, the Parts corresponding to the surplus addresses will be assigned to the final address of the same device.</p> |

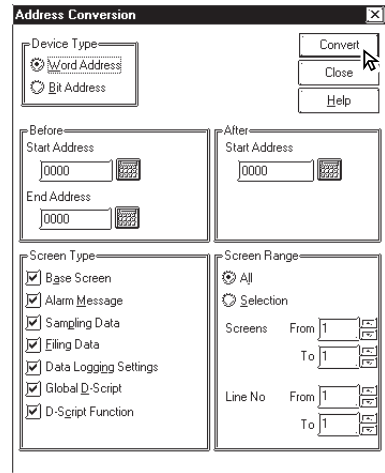
| PROCEDURE | REMARKS |
|---|--|
| <p>(4) Select the type of screen to be replaced.</p>  | |
| <p>(5) Enter the screen number to be changed. (Enter the line numbers used in the Alarm Editor)</p> <p>All the addresses between the initial screen number and the final screen number (or the addresses between the initial line number and the final line number), will now be changed.</p>  | <div style="text-align: center;">  Important </div> <p>Do not convert addresses on 2,000 screens or more at a time. Otherwise, the memory capacity might run short after this conversion. If this memory shortage occurs, re-start the LT Editor.</p> |
| <p>(6) After confirming that all the settings are correct, click on the Convert button.</p>  | |

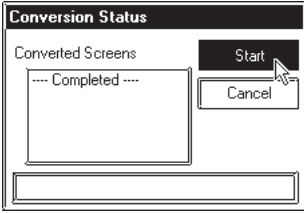
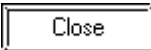
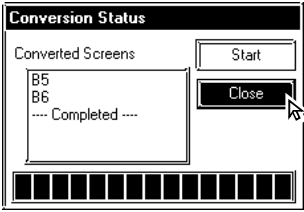
| PROCEDURE | REMARKS |
|---|---------|
| <p>(7) Click on the  button. The progress of the address conversion will be displayed.</p>  | |
| <p>(8) To stop the address conversion prior to normal completion, click on the  button.</p>  | |

4.2.4 Convert Load Screens

This feature allows you to convert the currently loaded screens to different ones via the [Load Screen] command, all at once.

■ Load Screen and Search Screen Settings

Here, specify the screens to be converted. Enter the numbers of the Search Screens on which Load Screens have been called up and called up Load Screens.

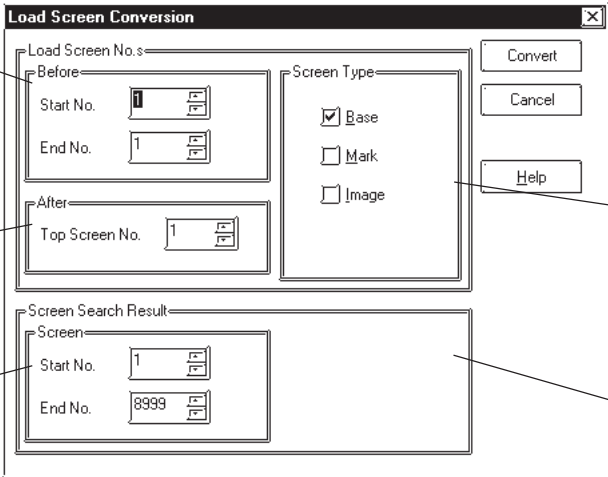

Specify the range of Load Screens before conversion. (Points to 'Before' section)

Specify the Top Screen number of the Load screens after conversion. (Points to 'After' section)

Specify the range of the Search Screens on which Load Screens have been called up. (Points to 'Screen Search Result' section)

Specify the Load Screen Type. (Points to 'Screen Type' section)

Specify the Search Screen Type. (Points to 'Screen Search Result' section)

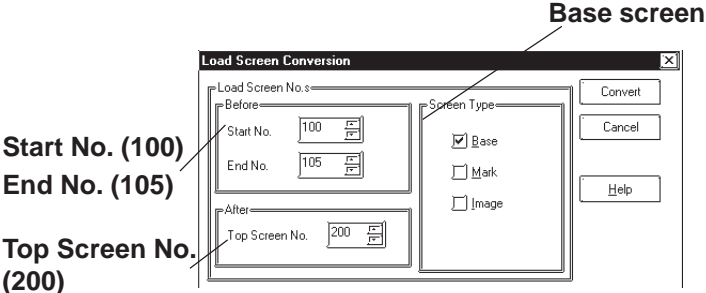
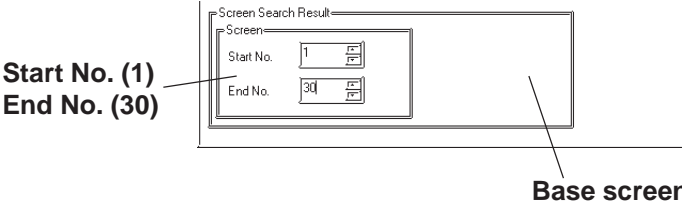
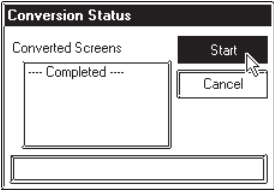
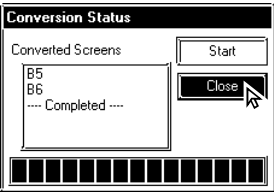
| PROCEDURE | REMARKS |
|---|---------|
| <p>Example; Load Screens B100 to B105 currently loaded on Base screens B1 to B30 are converted to B200 to B205.</p> <p>(1) Via the Project Manager, select the [Utility] menu - [Convert Load Screens] command.</p> <p>(2) Specify the type and numbers of the Load Screens to be converted and the Top Screen number of the Load Screens after conversion.</p>  <p>(3) Specify the range of the Search Screens and their type.</p> <p>The Load Screen numbers specified in step (2) will be converted and called up on Search Screens specified by the Start and End numbers, here.</p>  <p>(4) After confirming all the settings are correct, click on the Convert button.</p> <p>(5) Click on the Start button to start conversion. The conversion status will continuously be displayed.</p>  <p>(6) Click on the Close button to close the dialog.</p>  | |

4.2.5 Symbol Editor

The Symbol Editor enables you to assign an address to a symbol and then register that symbol and to assign a device comment to an address and then register it.

The “Symbol” is the registered name used to indicate the address of any Part. Thus, when you change the address corresponding to a symbol, you will automatically change a Part's address(es) without having to re-setting the Part. The “device comment” indicates a comment assigned (attached) to each address. When setting a Part's address(es), simply clicking on  ([Apply Device Comment]) reflects the registered device comment to the Part's comment field.

Reference 2.1 Parts ■ Part Attributes - Entering a Comment

In all the address entry fields, such as of Parts, addresses registered via the Symbol Editor will be displayed in a pull-down list together with the symbols or device comments. Addresses can also be specified here by selecting them from this list.

Reference 2.1 Parts ■ Part Attributes - Entering Addresses

The symbol and device comment data can be shared between multiple Projects by import and export.



Note: The registered symbol and device comment information can be printed as a symbol list.

Reference 9.1.1 Print Settings

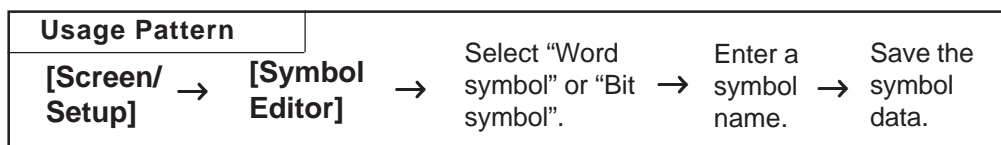

Select a desired symbol or comment.

Enter a symbol name of up to twenty characters

Pop-up Keypad

Enter the address(es) corresponding to the symbol's or description's name

■ Symbol Editor Types

There are five types of symbols: the Word symbol corresponding to a word address, the Bit symbol corresponding to a bit address, the Logic Integer symbol, the Logic Discrete symbol and the Logic Real symbol which are used in a logic program.

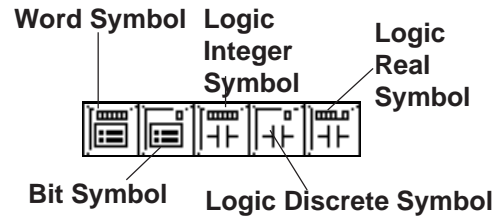

◆ Logic symbol

Logic symbol means variables used in a logic program. A new logic symbol cannot be registered with the Symbol Editor. When a logic program is saved, global variables registered on the variable list will automatically be registered with the Symbol Editor.

Only global variables are registered as logic symbols.

Variables are registered as one of the following three logic symbols depending on the variable type: **Logic Integer symbol**, **Logic Discrete symbol**, **Logic Real symbol**.

As for an array variable, each element is registered as a symbol. An array of size 5 is registered as five logic symbols. [Element Number] representing elements in an array will be <Element Number> as a Logic symbol, and an array of size 5, ALLM, will be represented as below.

| Array variable | Logic symbol |
|----------------|--------------|
| ALLM[0] | ALLM<0> |
| ALLM[1] | ALLM<1> |
| ALLM[2] | ALLM<2> |
| ALLM[3] | ALLM<3> |



Note: For details of variables, please refer to the "Logic Programming Operation Manual" or "online help".



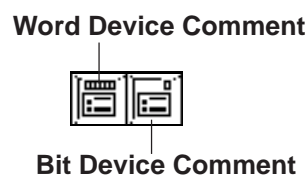

■ Device Comment Types

There are two types of bit device comments: the word device comment corresponding to a word address and the bit device comment corresponding to a bit address.



■ Edit Commands

To edit symbols, you can use the following commands:

-  Used to delete a symbol's line of data and store it on the clipboard. The Paste command allows you to then move that symbol to another line.
-  Used to copy a selected line of data to the clipboard.
-  Used to insert the line of data temporarily stored on the clipboard into the desired row, after the Cut/Copy command has been performed.
-  Used to cancel the command previously performed and return to the previous condition. However, an edited symbol character cannot be restored.





■ Using the Cut/Copy/Paste Commands

Cut/Copy/Paste commands can be used to move data between different Symbol Editor files. To do this, simply open another LBE file and select a desired line. Then, use the [Cut] or [Copy] command, and then the Symbol Editor's [Paste] command.

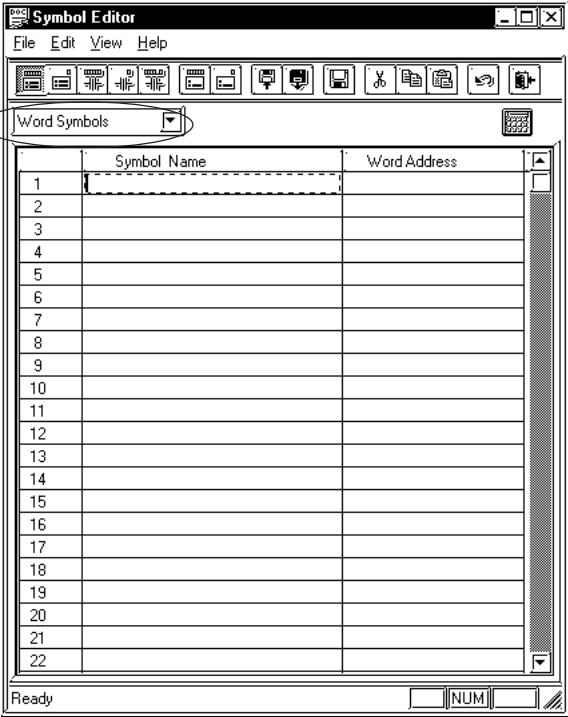
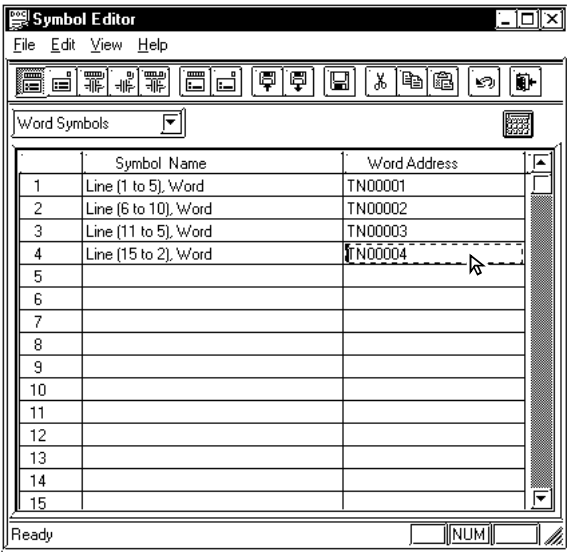

- ***Do not register the same symbol name for both a word symbol and a bit symbol.***
- ***If alphanumeric numerals are used at the end of a symbol name, executing the [Copy] and [Paste] command will automatically change the symbol's name.***
- ***When Chinese characters and numbers are used in a symbol name:***
All the Arabic numbers to the right of the Chinese character(s) will be deleted. Sequence numbers starting from "2" will be assigned after the Chinese characters.
- ***When Roman characters and Arabic numbers are used in a symbol name:***
Example) ABC123
All the Arabic numerals to the right of Roman character(s) will be deleted and replaced by a sequence number.
- ***When only Arabic numbers are used in a symbol name:***
Only the first number is retained, and all other digits are truncated and replaced with a sequence number.

■ Registering Symbols and Device Comments

| PROCEDURE | REMARKS |
|---|---|
| <p>(1) Via the Project Manager, select the [Screen/Setup] menu - [Symbol Editor] command.</p> <p>(2) Select symbol or device comment type. In this example, please select “Word Symbols”.</p>  <p>(3) Enter symbol names and addresses.</p>  <p>(4) After all the necessary items are registered, select the [File] menu - [Save] command, or click on the  icon.</p> | <p>To enter a symbol name, you can use up to twenty alphanumeric characters, or up to ten Chinese characters.</p> <p>The entered characters are not case-sensitive.</p> <p>You can perform the [Delete] or [Copy] and [Paste] commands after selecting multiple messages.</p> <p> Important</p> <p>The symbols [], \, ?, and the  key cannot be used in the Symbol Editor.</p> |

■ Importing Symbols and Device Comments

The previously saved Symbol Editor data can be imported to and shared with the currently open Symbol Editor. Files with the extension of "*.LBE" or "*.CSV" can be imported.

CSV files that have been created via a text editor, Microsoft Excel, or other applications can be used as symbol or device comment data via the Symbol Editor after imported.



Note: Logic symbols cannot be imported with the Symbol Editor.

Symbol data and device comment's CSV file formats are as follows:

<Symbol Data CSV Format>

```
"GP_SYMBOL"
"Symbol Name", "Word Address"
<Give one line feed between a word address and a bit address>
"Symbol Name", "Bit Address"
```

Example

```
"GP_SYMBOL"
"Line A (1 to 5): Word", "D00100"
"Line A (6 to 10): Word", "D00101"

"Line A (1 to 5): Bit", "X00100"
"Line A (6 to 10): Bit", "X00101"
```



One line feed

<Device Comment Data CSV Format>

```
"GP_COMMENT"
"Word Address", "Device Comment Name"
<Give one line feed between a word address and a bit address>
"Bit Address", "Device Comment Name"
```

Example

```
"GP_COMMENT"
"D00100", "Machine A stops"
"D00101", "Machine A is now operating"

"X00100", " Pump B"
"X00101", " Pump B"
```









One line feed

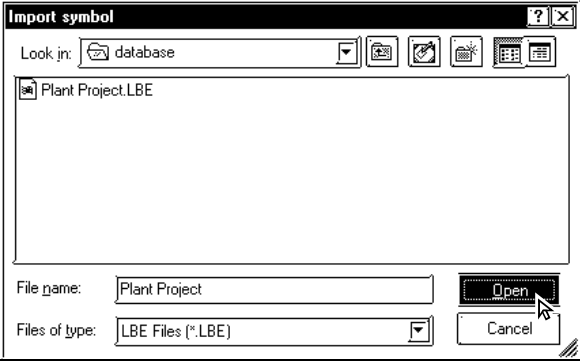
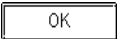
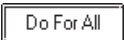

Important

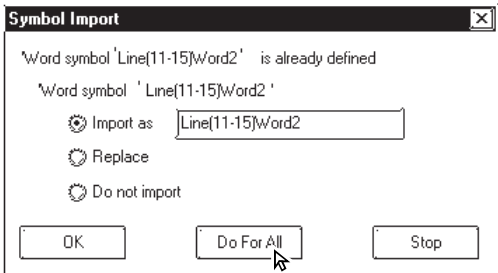
- **"GP_SYMBOL" and "GP_COMMENT" are identifiers indicating they are Symbol and Device Comment Data, respectively.**
- **Give a line feed only between a word symbol and a bit symbol. If an unnecessary line feed is given in any other place, data cannot be imported.**

| PROCEDURE | REMARKS |
|---|---|
| <p>Import symbol data.</p> <p>(1) Select the [File] menu - [Import Symbol] command, or click on the  icon.</p> <p>(2) Select a file (*.LBE or *.CSV) to be imported or enter the file name, and click on the  button.</p>  <p>If the same symbol name already exists, the system asks if you wish to replace the symbol name.</p> <p>[Import as] Enter the symbol name to be replaced. If no symbol name is entered, the original symbol name plus sequence numbers will be imported.</p> <p>[Replace] The same symbol name will be overwritten.</p> <p>[Do not import] The same symbol name will not be imported.</p> <p>(3) Select an import method and execute it.</p> <p>To import the specified symbol according to the current settings, click on the  button. To import the current Project file's all the symbols according to the current settings, click on the  button. To cancel the import, click on the  button.</p>  | <p>To import a device comment, select the [Import Device Comment] command.</p> <p> Important To import a device comment, select the [Import Device Comment] command.</p> <p>If the same symbol name exists as a Logic symbol name, [Import as] command imports the symbol name with a number added. The symbol name cannot be overwritten.</p> |





- Amount of the Symbol data created or imported via the Symbol Editor is not limited. However, the number of device comment characters is up to 20.
- Items with an inappropriate device name are not imported.

■ **Exporting Symbols and Device Comments**

Data registered via the Symbol Editor is exported and saved as an LBE or CSV file. By importing this data, the Symbol Editor data can be shared among Projects.



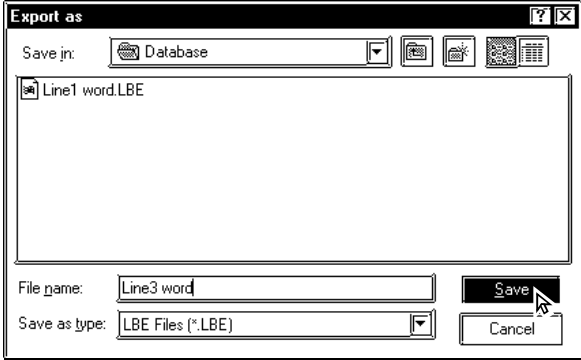
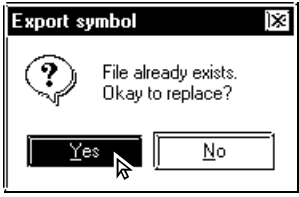

Note: Logic symbols cannot be imported with the Symbol Editor.

| PROCEDURE | REMARKS |
|---|--|
| <p>Export symbol data.</p> <p>(1) Via the Symbol Editor, select the [File] menu - [Export Symbol] command, or click on the  icon.</p> <p>(2) Specify the name and type (*.LBE or *.CSV) of the file to save the exported data with, and click on the  button.</p> <p>If the same file name already exists, the system asks if the existing file must be overwritten. If it must be overwritten, select <input type="text" value="Yes"/> . If you do not wish to overwrite it, select <input type="text" value="No"/> .</p> <div style="text-align: center;">  </div> <p style="text-align: center;">↓</p> <div style="text-align: center;">  </div> | <p>To export a device comment, select the [Export Device Comment] command.</p> |

■ Calling up Device Comments

All the comments that have already been registered with Parts can be called up on the Symbol Editor as device comments. For addresses corresponding to each Part's comment, refer to the Input Description Address Table.

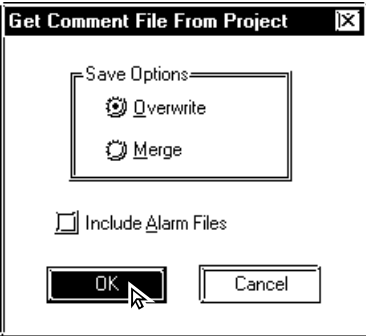
Reference 2.3.8 Duplication

| PROCEDURE | REMARKS |
|---|---|
| <p>(1) Select the [File] menu - [Get Device Comment From Project].</p> <p>(2) Select a device comment calling up method and click on the <input type="button" value="OK"/> button.</p> <p>[Overwrite] ... The device comment is called up after the already assigned address is deleted.</p> <p>[Merge] ... The device comment is called up in addition to the already assigned address.</p>  |  <p><i>Important</i></p> <p>Multiple addresses may be given to a Part depending on its type. In this case, device comments will be called up for all the assigned addresses.</p> <p>To call up an alarm message from the Alarm Editor, mark the [Include Alarm Files] check box.</p> |

4.2.6 Changing a Project's LT Type

You can change the LT type of your current project.



Note: After changing the LT type, you can save the current project using the [Project] menu - [Save As] command.

Reference 1.2.2 ■ Saving a Project Under a Different Name

| PROCEDURE | REMARKS |
|-----------|---------|
|-----------|---------|

(1) Via the Project Manager, select the [Project] menu - [Change LT Type] command.

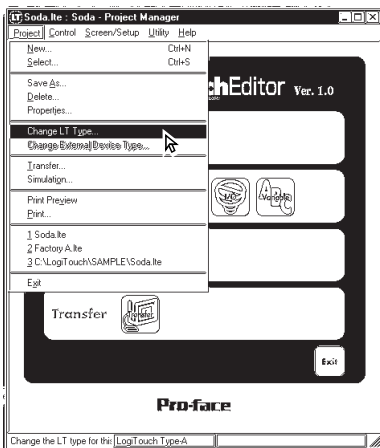

(2) To change the LT type, click on the desired LT type.

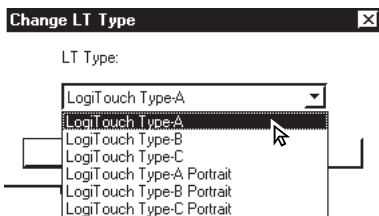

(3) Click on the button.

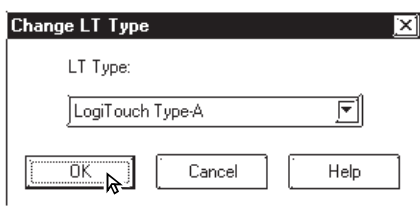

Important
The drawing area, commands and memory used by this change will vary depending on the selected LT type. Be sure to check these items before changing the LT type to be sure that your change(s) will be compatible with your existing project's data.



Important When a vertical type LT unit is replaced with a horizontal type or vice-versa, the displayed screen is rotated 90°. Therefore, you must also edit the screen using the [Rotate] command. After editing, be sure to check that the displayed data is as desired.

Example)

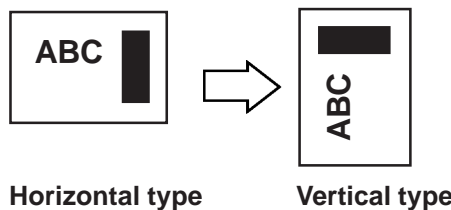

Horizontal type

Vertical type



4.2.7 Changing Your Project's External Device

You can change the External Device selected in the current project.
The External Device can be changed only when the LT is Type-C.



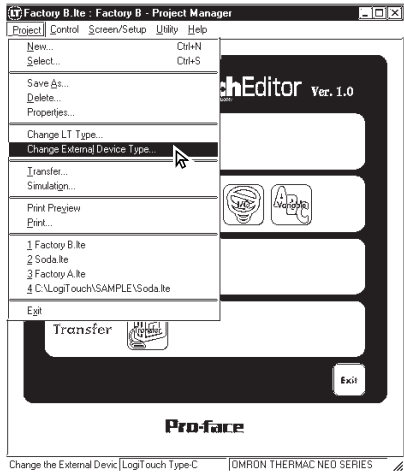
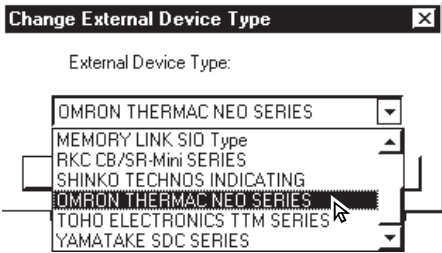
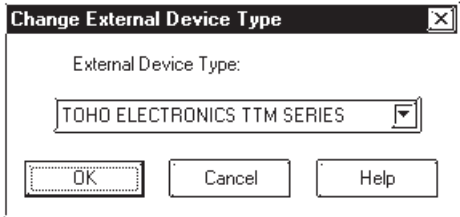

Note: After changing the External Device, you can save the current project using [Project] menu - [Save As] command.

Reference 1.2.2 ■ Saving a Project Under a Different Name

| PROCEDURE | REMARKS |
|--|--|
| <p>(1) Via the Project Manager, select the [Project] menu - [Change External Device] command.</p>  <p>(2) To change the External Device, click on the desired External Device.</p>  <p>(3) Click on the <input type="button" value="OK"/> button.</p>  |  <p>Important</p> <p>Once you change a project's External Device, you must re-enter that project's device addresses for Parts, D-script and alarms.</p> |

4.3 Project Compression/Decompression

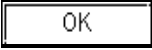
Compressing a project file reduces the size of its data to accommodate a standard floppy disk's limited capacity. A compressed project file and its screens however, cannot be edited. To edit the screens, you must first decompress the project file.

| Usage Pattern | | | |
|---------------------------------|--|--|--|
| Start → LogiTouch → Pack Tool → | | | |
| [Action] | → [Compress Project File]/ [Decompress Project File] | → Designate a Project file to be compressed or decompressed. | → Click on the  button. |
| or | | | |
| Click on |  or  . | | |

A general description of the compression tool is as follows:

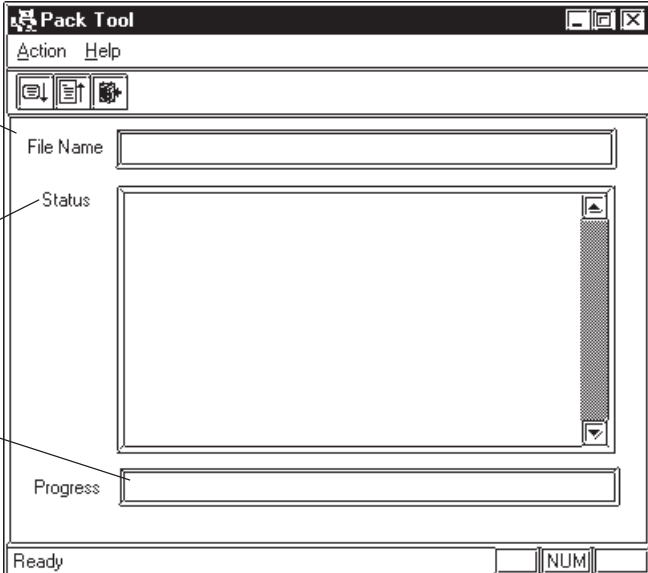

Displays the file name of the project to be compressed/ decompressed

Displays the status of the project file compression/decompression

Displays the overall progress of the project file compression/decompression

4.3.1 Compressing a Project File

A Project file can be compressed to a smaller size. At this time, a large sized file can be divided into smaller files automatically according to the specified capacity. After a project file is divided into several files during compression, serial numbers are assigned to the first character of each file extension (or assigned to the first and second characters if the file number has two digits).

Example) *.0lt, *.1lt...*.9PW, *.10W, *.11W

Enter the file name of the project file to be compressed, or select a desired file name from the list by clicking on the [Browse] button

The compressed project file is automatically divided into several files according to the specified file size

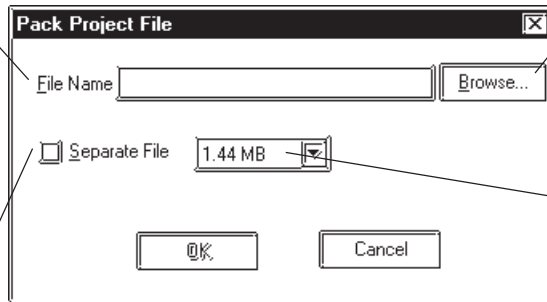



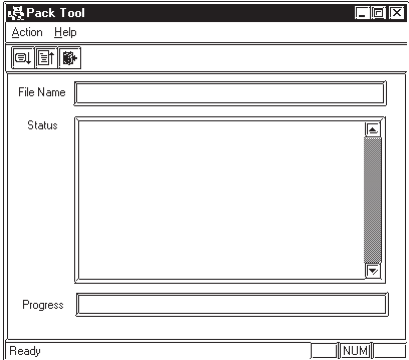
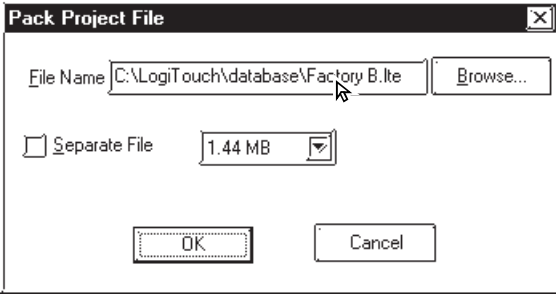
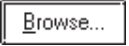
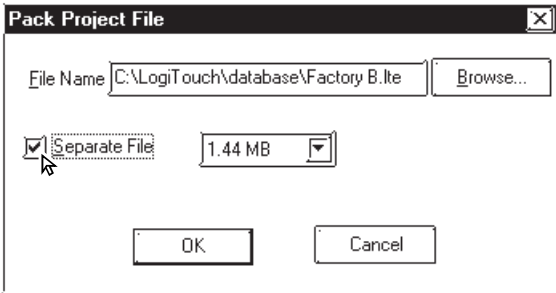

Used to locate the project file to be compressed

Used to select the file size limit

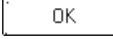
| PROCEDURE | REMARKS |
|--|---------|
| <p>(1) First, click the Windows [Start] button. Then, click on the [Programs]-[LogiTouch] menu and click the [3. Pack Tool] menu item. You can also select [3.Pack Tool...] from the Utility pull-down menu.</p> | |

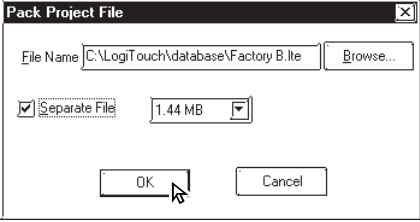
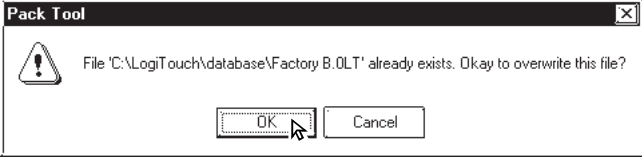
| PROCEDURE | REMARKS |
|--|---|
| <p>(2) Select the [Action] menu - [Compress Project File] command, or click on the  icon.</p>  | |
| <p>(3) Select the folder and project file to be compressed, or enter the file name. The file name of the desired project file will be displayed in the “Pack” screen.</p>  | <p>To call up a menu of all the available folders, click on the  button.</p> |
| <p>(4) To divide the project file during compression, click on the [Separate File] check box, and select the desired file size limit.</p>  | |

| PROCEDURE | REMARKS |
|--|--|
| <p>(5) Click on the  button.</p> <p>If the same file name already exists, the system asks if the existing file must be overwritten. If you select , the existing file will be overwritten. If you select , the existing file will not be overwritten, and you will return to the previous dialog box.</p>  <p style="text-align: center;">↓</p>  <p>(6) Select the [Action] menu - [Exit] command, or click on the  icon.</p> | <p>The compressed project file will be stored in the same folder as the original project file.</p> |

4.3.2 Decompressing a Project File

A compressed project file (OLT file) cannot be edited. To edit the compressed project file, you must first decompress it.

Enter the file name of the project file to be decompressed, or select the desired file name from the list by clicking on the [Browse] button

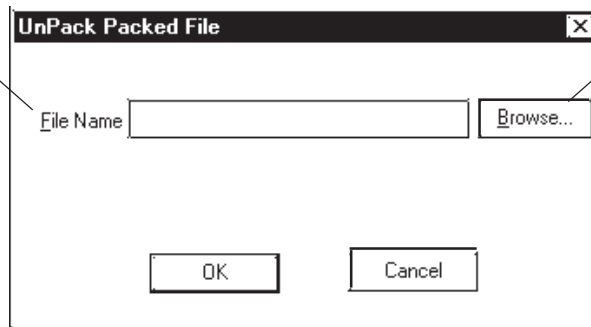

Used to locate the project file to be decompressed





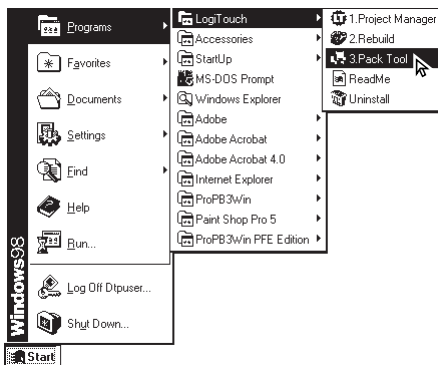

| PROCEDURE | REMARKS |
|-----------|---------|
|-----------|---------|

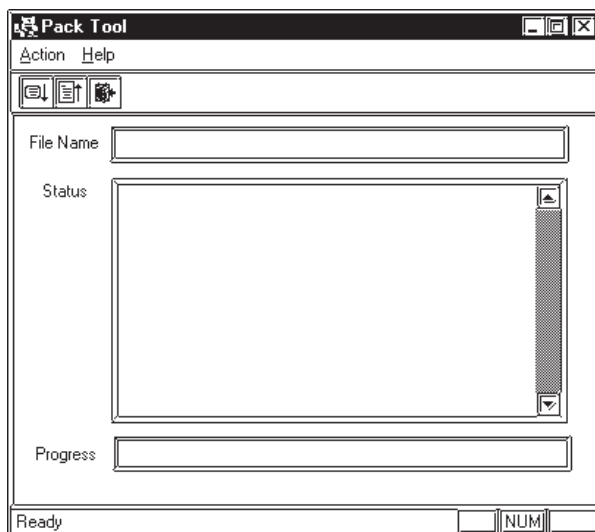
(1) Click on the Windows desktop's [Start] button. Then, point to the [Programs] - [LogiTouch] menu and click on the [4. Pack Tool] menu.

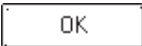
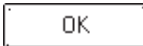

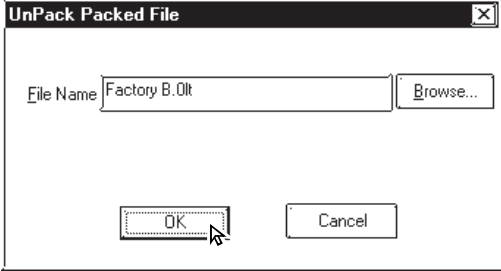
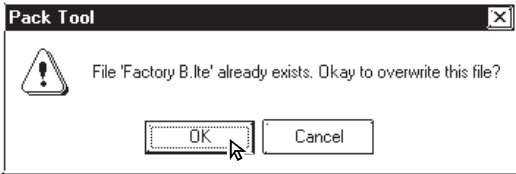
(2) Select the [Action] menu-[Decompress Project File] command, or click on the  icon.

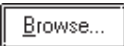

| PROCEDURE | REMARKS |
|---|--|
| <p>(3) Select a folder and Project file to be decompressed or enter the file name, and click on the  button.</p> <p>If the same file name already exists, the system asks if the existing file must be overwritten. If you select , the existing file will be overwritten. If you select , the existing file will not be overwritten, and you will return to the previous dialog box.</p>  <p style="text-align: center;">↓</p>  <p>(4) Select the [Action] menu - [Exit] command, or click on the  icon.</p> | <p>To select a folder, click on the  button.</p> <p> Important</p> <p>To decompress a compressed project file that has been divided into several files, make sure that all divided files are available.</p> <p>However, when you specify the file name to be decompressed, the system displays the first file name (*.OLT) only.</p> <p>The decompressed project file will be stored in the same folder as the compressed file.</p> |

4.4 Information Display

This section describes the types of screen and project information available.

4.4.1 Project Information

[Project Information] displays both the commands used to edit the current project, and the date and time of its last revision. To use this command, select the [Project] menu - [Project Information] command.

■ Project Information

◆ Current Project

Displays the file name of the currently selected project file.

◆ Description

Displays a comment about the current project.

◆ External Device

Displays the External Device selected in the currently opened project file.

◆ LT Type

Displays the LT type selected in the current project file.

◆ Project Size

Displays the data volume of the current project file.

If any Parts are placed in this file, the file volume will be increased.

◆ Date & Time

Displays the date and time when this file was saved last.

◆ Size of Screen To Be Sent To LT

Displays the total data volume that will be occupied in the LT unit panel, relative to the current project file. This item indicates the case where upload information is sent to the LT panel, and the case where upload information is not sent to the LT unit, separately.

The ratio of the current total data volume to the LT unit's total memory capacity is displayed in %. Referring to the LT unit's total memory capacity, you can calculate the approximate number of screens that can be accepted by the LT panel.

When the data volume is indicated as “????”, select the [Project]'s - [Transfer] menu, and then select the [Prepare] command.

▼ Reference ▲ 7.2.3 Transfer Preparation

Use this value only as a guideline. Depending on the size of the memory stored in the LT, a screen of allowable size may not be entirely transferred.

◆ Extended Screen Count

Displays the number of screens that will be created in the LT unit, relative to the current project file. Since this value includes the LT unit's internal screens, it is larger than the number of screens that have been created with LT Editor for Windows 95. To display this information, set up the current project file in the "Transfer Preparation" mode. If the project file is not in the "Transfer Preparation" mode, the number of screens is indicated as "???"

■ Screen Information

This screen shows the number of screen types, alarm messages and channels contained in the current project.

The screenshot shows the 'Project Info' dialog box with the 'Screen' tab selected. The 'Number of Screens' section includes 'Base' (1), 'Mark' (0), and 'Image' (0). Below this, 'Total Screens' is 1. The 'Number of Basic Alarm Messages' is 0 and 'Number of Channels' is 0. A list box for channels is empty. The dialog has 'OK' and 'Help' buttons.

The number of channels and the screen number that are used in the project are displayed

■ SRAM Information

The situation with the use of the backup SRAM in the current project is displayed on a function basis.

The screenshot shows the 'Project Info' dialog box with the 'SRAM Information' tab selected. It displays 'Available SRAM Size' as 96 KBytes. Below a horizontal line, it shows 'Data Sampling' (0 Bytes), 'LS Backup' (0 Bytes), 'Logging Data' (0 Bytes), and 'Filing Data' (0 Bytes). Below another horizontal line, it shows 'Remaining SRAM Size' as 98176 Bytes. The dialog has 'OK' and 'Help' buttons.

4.4.2 Screen Information

The [Screen Information] screen displays the settings for the currently open screen, as well as the date and time of its last revision. To use this command, select the [Project] menu's - [Screen Information] command.

■ Screen

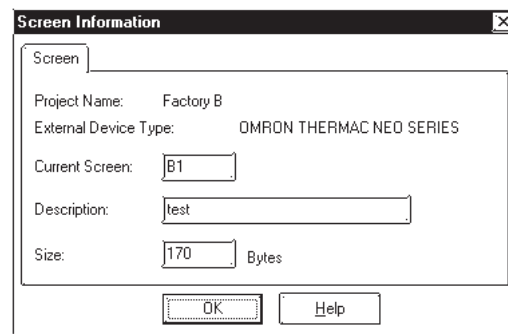

◆ Project Name

Displays the file name of the currently selected project file.

◆ External Device

Displays the External Device selected in the current project file.

◆ Current Screen

Displays the screen type and screen number of the current screen.

◆ Description

Displays the title of the current screen.

◆ Size

Displays the data volume of the current screen. If any Parts are placed on this screen, the screen data volume will be increased.

4.4.3 Version Information

[Version Information] displays the LT Editor Project Manager and Editor's version information. To see this data, select the [Help] menu - [About] command.

<Project Manager Version Information>



Memo

This feature allows you to register text data to be displayed as alarm messages. This chapter describes how to create and edit these alarm messages.

5.1 Alarm Creation and Editing

5.1 Alarm Creation and Editing

With this feature you can register the messages to be displayed in the “Alarm Summary” (Part menu’s “Alarm Display”) and “Alarm Message” (right to left scrolling display). You can also set up a monitor bit for each message. According to the monitor bit’s ON/OFF status, the specified messages are then displayed in the “Alarm Summary” or “Alarm Message” mode.

The "Alarm Summary" lists messages in the Alarm Display Part.

Reference 2.1.11 Alarm Display

With “Alarm Message” text, the horizontal and vertical size of the text is specified in the [Setup Area’s (Initial Setup screen)] menu or in the LT unit’s [Setup] mode. Character sizes can be set to either “x 1”, “x 2”, or “x 4”.

When the horizontal and vertical sizes are set to “1 x 1”, an alphanumeric character occupies 16 x 8 dots, and a Chinese character occupies 16 x 16 dots.

The “Alarm Display” and “Alarm Message” will display on the LT unit’s panel screen as shown below:

Alarm Summary
 (“Alarm Display” Part)

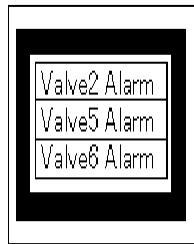

Alarm Message Display

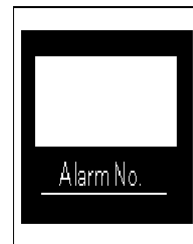

← Right to left scrolling display

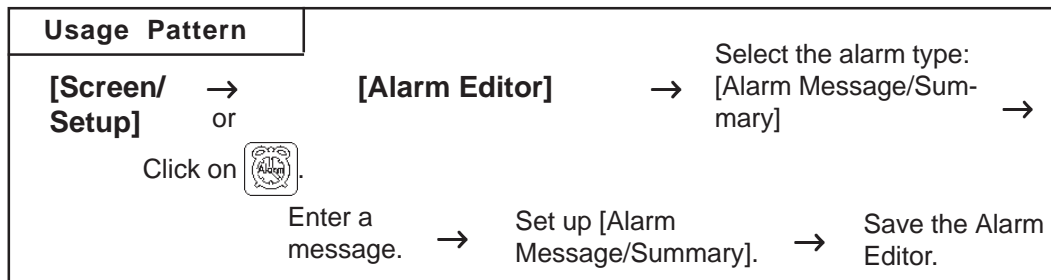

5.1.1 Alarm Editor

Via the Alarm Editor, messages and monitor bits are registered for each alarm type. An example of an Alarm Message screen used for entering a message is as follows.



Note: The tab width for each item in the Alarm Editor (messages) can be adjusted by positioning the mouse pointer on the border between items and then dragging it. The changed size will be saved, and used on the subsequently opened screens.

■ Alarm Message/Summary Screen

Here, you can register the messages to be displayed as either “Alarm Summary” (“Alarm Display” Part) or as “Alarm Message” (right to left scrolling display).

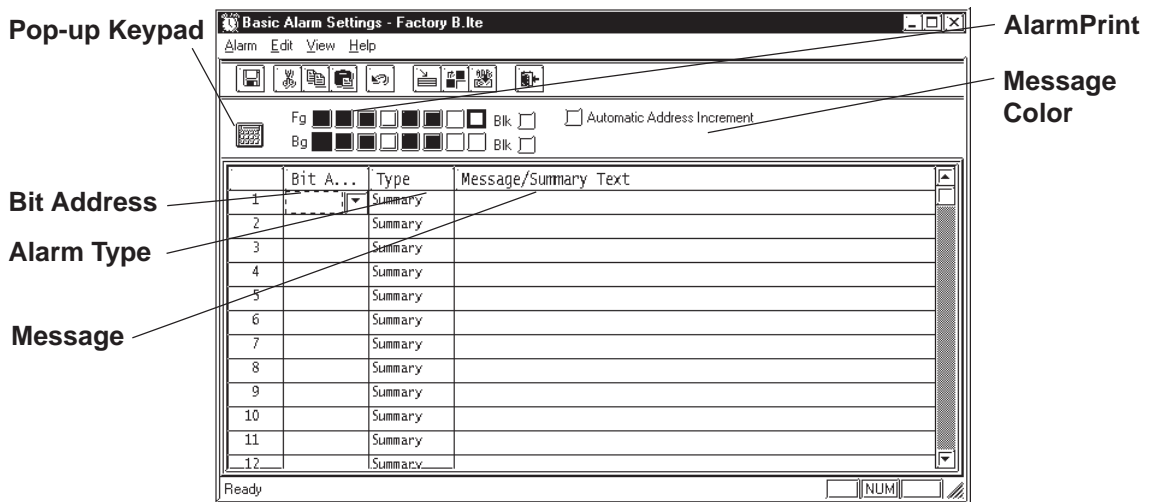

◆ Bit Address

Specifies the monitor bit. To specify the bit address for the “Alarm Summary” mode, select a device that can be specified in Word units.

Reference *LT Editor External Device Connection Manual*

◆ Alarm Type

The Alarm Editor provides two types of alarms: [Alarm Summary] and [Alarm Message].

The [Alarm Summary] mode lists messages specified by the Alarm Part.

The [Alarm Message] mode displays a scrolling message at the bottom of the LT’s screen.

Up to 128 messages can be entered into the Alarm Editor. Any message beyond this setting range will not operate on the LT unit’s panel screen.

◆ Message

Enter your message here. Up to 160 alphanumeric characters can be entered for one message.

◆ Pop-up Keypad

A pop-up keypad is displayed, allowing you to enter the bit address using the mouse.

◆ Message Color

Designates message’s color. Select the display color (Fg) and background color (Bg), and specify whether to blinking (Blk) is used or not.

◆ Automatic Address Increment





After entering and registering a message in a line and moving to the next line, an address that is one bit larger will be automatically entered for the new line.

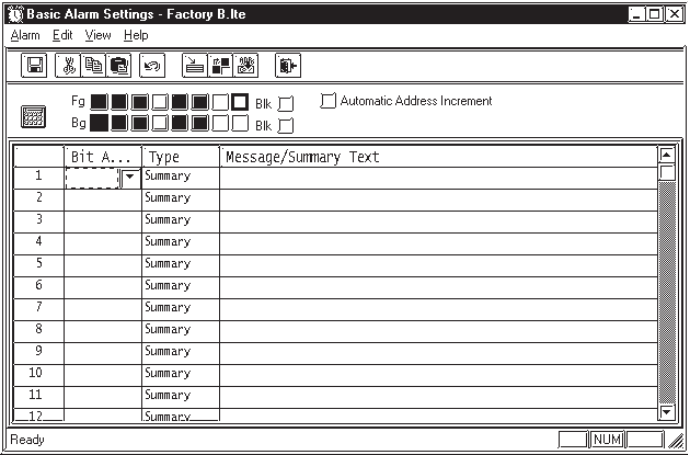
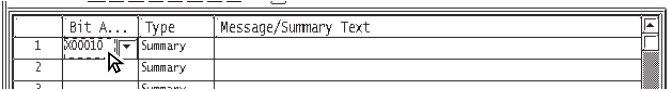

When a variable (Logic symbol) is used as an address, the automatic address increment function must be turned off. Otherwise, the correct addition will not be performed.

5.1.2 Creating an Alarm

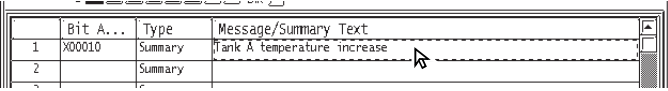
This section describes how to create and register alarm messages using Alarm Editor.

| PROCEDURE | REMARKS |
|--|--|
| <p>(1) Via the Project Manager, select the [Screen/Setup] menu - [Alarm Editor] command, or click on the  icon to open the Alarm Editor.</p>  | <p>Entering data in the Alarm Editor only does not activate the “Alarm Summary” mode. To activate the "Alarm Summary" mode, you must place the Message Display on the Base screen where the message is displayed.</p> |
| <p>(2)Specify the bit address (monitor bit).</p>  | <p> Important When designating an Alarm summary's bit address, be sure to select a device that can use word designated units.</p> |
| <p>(3)Enter a message.</p> <p>Enter the message to be displayed on the LT unit panel during alarm output. Select a message color, if desired.</p>  | <p>Reference  <i>LT Editor External Device Connection Manual, 3_*_3/4_*_3 Supported Devices</i></p> |
| | <p>Up to 160 alphanumeric characters can be entered for one Basic Alarm message.</p> <p>After selecting several messages by dragging the mouse, you can use the [Copy] and [Paste] commands</p> |

| PROCEDURE | REMARKS | | | | | | | | | | | | |
|--|----------|----------|-----------------------------|----------------------|---|-------|---------|-----------------------------|---|--|---------|--|--|
| <p>(4) Select the alarm type: Alarm “Message” or Alarm “Summary”.</p> <table border="1"> <thead> <tr> <th></th> <th>Bit A...</th> <th>Type</th> <th>Message/Summary Text</th> </tr> </thead> <tbody> <tr> <td>1</td> <td>X0010</td> <td>Summary</td> <td>Tank A temperature increase</td> </tr> <tr> <td>2</td> <td></td> <td>Summary</td> <td></td> </tr> </tbody> </table> | | Bit A... | Type | Message/Summary Text | 1 | X0010 | Summary | Tank A temperature increase | 2 | | Summary | | <p>Up to 512 alarm messages can be registered. However, set the monitor bits within 128 words.</p> <p>If a message has not been entered, the Alarm Editor data cannot be saved, even if the bit addresses have been specified.</p> |
| | Bit A... | Type | Message/Summary Text | | | | | | | | | | |
| 1 | X0010 | Summary | Tank A temperature increase | | | | | | | | | | |
| 2 | | Summary | | | | | | | | | | | |
| <p>(5) After entering all the necessary items, select the [Alarm] menu - [Save] command, or click on the  icon.</p> <p>The specified alarm data will be stored in the currently opened project file.</p> | | | | | | | | | | | | | |

5.1.3 Editing Alarm Data

This section describes how to use the Alarm Editor’s editing commands.

■ Cut/Move

Here, you can delete the selected line of alarm data and store it on the clipboard.

| PROCEDURE | REMARKS | | | | | | | | | | | | | | | | | | | | | | | | | | | | | | | |
|--|-------------|-------------|-----------------------|---------|---|-------|----------|-----------------------|---|-------|---------|-----------------------|---|-------|---------|-----------------------|---|-------|---------|--|---|-------|---------|--|---|-------|---------|--|---|-------|---------|--|
| <p>(1) Select the line of alarm data to be moved.</p> <table border="1"> <thead> <tr> <th></th> <th>Bit Address</th> <th>Type</th> <th>Message</th> </tr> </thead> <tbody> <tr> <td>1</td> <td>X0010</td> <td>Bulletin</td> <td>Tank A temperature UP</td> </tr> <tr> <td>2</td> <td>X0050</td> <td>Summary</td> <td>Tank B temperature UP</td> </tr> <tr style="background-color: #cccccc;"> <td>3</td> <td>X0051</td> <td>Summary</td> <td>Tank C temperature UP</td> </tr> <tr> <td>4</td> <td>X0052</td> <td>Summary</td> <td></td> </tr> </tbody> </table> | | Bit Address | Type | Message | 1 | X0010 | Bulletin | Tank A temperature UP | 2 | X0050 | Summary | Tank B temperature UP | 3 | X0051 | Summary | Tank C temperature UP | 4 | X0052 | Summary | | <p>If a message has not been entered, Alarm Editor data cannot be saved, even if bit addresses have been specified.</p> <p>To select several lines, drag the mouse between the target lines, or click on the target line while holding down the Shift or Ctrl key.</p> <p>To delete the selected line(s), perform steps (1) and (2) only.</p> | | | | | | | | | | | |
| | Bit Address | Type | Message | | | | | | | | | | | | | | | | | | | | | | | | | | | | | |
| 1 | X0010 | Bulletin | Tank A temperature UP | | | | | | | | | | | | | | | | | | | | | | | | | | | | | |
| 2 | X0050 | Summary | Tank B temperature UP | | | | | | | | | | | | | | | | | | | | | | | | | | | | | |
| 3 | X0051 | Summary | Tank C temperature UP | | | | | | | | | | | | | | | | | | | | | | | | | | | | | |
| 4 | X0052 | Summary | | | | | | | | | | | | | | | | | | | | | | | | | | | | | | |
| <p>(2) Select the [Edit] menu - [Cut] command, or click on the  icon to import alarm data to the Clipboard.</p> <p>The selected alarm data will be deleted and stored.</p> <table border="1"> <thead> <tr> <th></th> <th>Bit Address</th> <th>Type</th> <th>Message</th> </tr> </thead> <tbody> <tr> <td>1</td> <td>X0010</td> <td>Bulletin</td> <td>Tank A temperature UP</td> </tr> <tr> <td>2</td> <td>X0050</td> <td>Summary</td> <td>Tank B temperature UP</td> </tr> <tr> <td>3</td> <td></td> <td>Summary</td> <td></td> </tr> <tr> <td>4</td> <td>X0052</td> <td>Summary</td> <td></td> </tr> <tr> <td>5</td> <td>X0053</td> <td>Summary</td> <td></td> </tr> </tbody> </table> | | Bit Address | Type | Message | 1 | X0010 | Bulletin | Tank A temperature UP | 2 | X0050 | Summary | Tank B temperature UP | 3 | | Summary | | 4 | X0052 | Summary | | 5 | X0053 | Summary | | | | | | | | | |
| | Bit Address | Type | Message | | | | | | | | | | | | | | | | | | | | | | | | | | | | | |
| 1 | X0010 | Bulletin | Tank A temperature UP | | | | | | | | | | | | | | | | | | | | | | | | | | | | | |
| 2 | X0050 | Summary | Tank B temperature UP | | | | | | | | | | | | | | | | | | | | | | | | | | | | | |
| 3 | | Summary | | | | | | | | | | | | | | | | | | | | | | | | | | | | | | |
| 4 | X0052 | Summary | | | | | | | | | | | | | | | | | | | | | | | | | | | | | | |
| 5 | X0053 | Summary | | | | | | | | | | | | | | | | | | | | | | | | | | | | | | |
| <p>(3) Select the insertion line.</p> <table border="1"> <thead> <tr> <th></th> <th>Bit Address</th> <th>Type</th> <th>Message</th> </tr> </thead> <tbody> <tr> <td>1</td> <td>X0010</td> <td>Bulletin</td> <td>Tank A temperature UP</td> </tr> <tr> <td>2</td> <td>X0050</td> <td>Summary</td> <td>Tank B temperature UP</td> </tr> <tr> <td>3</td> <td></td> <td>Summary</td> <td></td> </tr> <tr> <td>4</td> <td>X0052</td> <td>Summary</td> <td></td> </tr> <tr style="background-color: #cccccc;"> <td>5</td> <td>X0053</td> <td>Summary</td> <td></td> </tr> <tr> <td>6</td> <td>X0054</td> <td>Summary</td> <td></td> </tr> <tr> <td>7</td> <td>X0055</td> <td>Summary</td> <td></td> </tr> </tbody> </table> | | Bit Address | Type | Message | 1 | X0010 | Bulletin | Tank A temperature UP | 2 | X0050 | Summary | Tank B temperature UP | 3 | | Summary | | 4 | X0052 | Summary | | 5 | X0053 | Summary | | 6 | X0054 | Summary | | 7 | X0055 | Summary | |
| | Bit Address | Type | Message | | | | | | | | | | | | | | | | | | | | | | | | | | | | | |
| 1 | X0010 | Bulletin | Tank A temperature UP | | | | | | | | | | | | | | | | | | | | | | | | | | | | | |
| 2 | X0050 | Summary | Tank B temperature UP | | | | | | | | | | | | | | | | | | | | | | | | | | | | | |
| 3 | | Summary | | | | | | | | | | | | | | | | | | | | | | | | | | | | | | |
| 4 | X0052 | Summary | | | | | | | | | | | | | | | | | | | | | | | | | | | | | | |
| 5 | X0053 | Summary | | | | | | | | | | | | | | | | | | | | | | | | | | | | | | |
| 6 | X0054 | Summary | | | | | | | | | | | | | | | | | | | | | | | | | | | | | | |
| 7 | X0055 | Summary | | | | | | | | | | | | | | | | | | | | | | | | | | | | | | |

PROCEDURE

REMARKS

(4) Select the [Edit] menu - [Paste] command, or click on the  icon to paste alarm data to the destination from the Clipboard.

If the same number already exists, the system asks if each file must be overwritten. If you select , the desired data will be overwritten. If you select , the desired file will not be overwritten, and the system will ask the same question for the next alarm. If you select , all existing alarms will be overwritten. If you select , you will return to the menu screen.

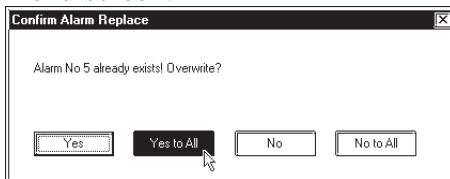



The selected alarm data is moved to the specified line.

| | Bit Address | Type | Message |
|---|-------------|---------|--------------|
| 1 | X0010 | Summary | Tank A stops |
| 2 | X0050 | Summary | Tank B stops |
| 3 | | Summary | |
| 4 | X0052 | Summary | |
| 5 | X0051 | Summary | Tank C stops |
| 6 | X0054 | Summary | |
| 7 | X0055 | Summary | |

■ Copy

Copies the selected line of alarm data, and stores it on the clipboard.

| PROCEDURE | REMARKS | | | | | | | | | | | | | | | | | | | | | | | | | | | | | | | | | | | | | | | |
|--|-------------|-------------|-----------------------|---------|---|--------|----------|-----------------------|---|--------|---------|-----------------------|---|--------|----------|-----------------------|---|--------|---------|--|---|--------|----------|--|---|--------|---------|--|---|--------|---------|--|---|--------|---------|--|---|--------|---------|--|
| <p>(1) Select the alarm line to be copied.</p> <table border="1"> <thead> <tr> <th></th> <th>Bit Address</th> <th>Type</th> <th>Message</th> </tr> </thead> <tbody> <tr> <td>1</td> <td>X00010</td> <td>Bulletin</td> <td>Tank A temperature UP</td> </tr> <tr> <td>2</td> <td>X00050</td> <td>Summary</td> <td>Tank B temperature UP</td> </tr> <tr style="background-color: #cccccc;"> <td>3</td> <td>X00051</td> <td>Summary</td> <td>Tank C temperature UP</td> </tr> <tr> <td>4</td> <td>X00052</td> <td>Summary</td> <td></td> </tr> <tr> <td>5</td> <td>X00053</td> <td>Summary</td> <td></td> </tr> </tbody> </table> | | Bit Address | Type | Message | 1 | X00010 | Bulletin | Tank A temperature UP | 2 | X00050 | Summary | Tank B temperature UP | 3 | X00051 | Summary | Tank C temperature UP | 4 | X00052 | Summary | | 5 | X00053 | Summary | | <p>Even if bit addresses have been specified, if message data has not been entered, the Alarm Editor data cannot be saved.</p> <p>To select several lines, drag the mouse between the target lines, or click on the target line while holding down the [Shift] or [Ctrl] key.</p> | | | | | | | | | | | | | | | |
| | Bit Address | Type | Message | | | | | | | | | | | | | | | | | | | | | | | | | | | | | | | | | | | | | |
| 1 | X00010 | Bulletin | Tank A temperature UP | | | | | | | | | | | | | | | | | | | | | | | | | | | | | | | | | | | | | |
| 2 | X00050 | Summary | Tank B temperature UP | | | | | | | | | | | | | | | | | | | | | | | | | | | | | | | | | | | | | |
| 3 | X00051 | Summary | Tank C temperature UP | | | | | | | | | | | | | | | | | | | | | | | | | | | | | | | | | | | | | |
| 4 | X00052 | Summary | | | | | | | | | | | | | | | | | | | | | | | | | | | | | | | | | | | | | | |
| 5 | X00053 | Summary | | | | | | | | | | | | | | | | | | | | | | | | | | | | | | | | | | | | | | |
| <p>(2) Select the [Edit] menu - [Copy] command, or click on the  icon to import alarm data to the Clipboard. The selected alarm data will be copied to the clipboard.</p> <table border="1"> <thead> <tr> <th></th> <th>Bit Address</th> <th>Type</th> <th>Message</th> </tr> </thead> <tbody> <tr> <td>1</td> <td>X00010</td> <td>Summary</td> <td>Tank A temperature UP</td> </tr> <tr> <td>2</td> <td>X00050</td> <td>Summary</td> <td>Tank B temperature UP</td> </tr> <tr> <td>3</td> <td>X00051</td> <td>Bulletin</td> <td>Tank C temperature UP</td> </tr> <tr> <td>4</td> <td>X00052</td> <td>Summary</td> <td></td> </tr> <tr> <td>5</td> <td>X00051</td> <td>Bulletin</td> <td></td> </tr> </tbody> </table> | | Bit Address | Type | Message | 1 | X00010 | Summary | Tank A temperature UP | 2 | X00050 | Summary | Tank B temperature UP | 3 | X00051 | Bulletin | Tank C temperature UP | 4 | X00052 | Summary | | 5 | X00051 | Bulletin | | | | | | | | | | | | | | | | | |
| | Bit Address | Type | Message | | | | | | | | | | | | | | | | | | | | | | | | | | | | | | | | | | | | | |
| 1 | X00010 | Summary | Tank A temperature UP | | | | | | | | | | | | | | | | | | | | | | | | | | | | | | | | | | | | | |
| 2 | X00050 | Summary | Tank B temperature UP | | | | | | | | | | | | | | | | | | | | | | | | | | | | | | | | | | | | | |
| 3 | X00051 | Bulletin | Tank C temperature UP | | | | | | | | | | | | | | | | | | | | | | | | | | | | | | | | | | | | | |
| 4 | X00052 | Summary | | | | | | | | | | | | | | | | | | | | | | | | | | | | | | | | | | | | | | |
| 5 | X00051 | Bulletin | | | | | | | | | | | | | | | | | | | | | | | | | | | | | | | | | | | | | | |
| <p>(3) Select the destination line.</p> <table border="1"> <thead> <tr> <th></th> <th>Bit Address</th> <th>Type</th> <th>Message</th> </tr> </thead> <tbody> <tr> <td>1</td> <td>X00010</td> <td>Summary</td> <td>Tank A temperature UP</td> </tr> <tr> <td>2</td> <td>X00050</td> <td>Summary</td> <td>Tank B temperature UP</td> </tr> <tr> <td>3</td> <td>X00051</td> <td>Bulletin</td> <td>Tank C temperature UP</td> </tr> <tr> <td>4</td> <td>X00052</td> <td>Summary</td> <td></td> </tr> <tr> <td>5</td> <td>X00051</td> <td>Bulletin</td> <td></td> </tr> <tr> <td>6</td> <td>X00054</td> <td>Summary</td> <td></td> </tr> <tr style="background-color: #cccccc;"> <td>7</td> <td>X00055</td> <td>Summary</td> <td></td> </tr> <tr> <td>8</td> <td>X00056</td> <td>Summary</td> <td></td> </tr> <tr> <td>9</td> <td>X00057</td> <td>Summary</td> <td></td> </tr> </tbody> </table> | | Bit Address | Type | Message | 1 | X00010 | Summary | Tank A temperature UP | 2 | X00050 | Summary | Tank B temperature UP | 3 | X00051 | Bulletin | Tank C temperature UP | 4 | X00052 | Summary | | 5 | X00051 | Bulletin | | 6 | X00054 | Summary | | 7 | X00055 | Summary | | 8 | X00056 | Summary | | 9 | X00057 | Summary | |
| | Bit Address | Type | Message | | | | | | | | | | | | | | | | | | | | | | | | | | | | | | | | | | | | | |
| 1 | X00010 | Summary | Tank A temperature UP | | | | | | | | | | | | | | | | | | | | | | | | | | | | | | | | | | | | | |
| 2 | X00050 | Summary | Tank B temperature UP | | | | | | | | | | | | | | | | | | | | | | | | | | | | | | | | | | | | | |
| 3 | X00051 | Bulletin | Tank C temperature UP | | | | | | | | | | | | | | | | | | | | | | | | | | | | | | | | | | | | | |
| 4 | X00052 | Summary | | | | | | | | | | | | | | | | | | | | | | | | | | | | | | | | | | | | | | |
| 5 | X00051 | Bulletin | | | | | | | | | | | | | | | | | | | | | | | | | | | | | | | | | | | | | | |
| 6 | X00054 | Summary | | | | | | | | | | | | | | | | | | | | | | | | | | | | | | | | | | | | | | |
| 7 | X00055 | Summary | | | | | | | | | | | | | | | | | | | | | | | | | | | | | | | | | | | | | | |
| 8 | X00056 | Summary | | | | | | | | | | | | | | | | | | | | | | | | | | | | | | | | | | | | | | |
| 9 | X00057 | Summary | | | | | | | | | | | | | | | | | | | | | | | | | | | | | | | | | | | | | | |
| <p>(4) Select the [Edit] menu - [Paste] command, or click on the  icon to paste alarm data to the destination from the Clipboard. If the same data already exists, the system asks if each file (item) must be overwritten. If you select <input type="button" value="Yes"/>, the desired file will be overwritten. If you select <input type="button" value="No"/>, the desired file will not be overwritten, and the system will ask the same question for the next alarm. If you select <input type="button" value="Yes to All"/>, all existing alarms will be overwritten. If you select <input type="button" value="No to All"/>, you will return to the menu screen.</p> | | | | | | | | | | | | | | | | | | | | | | | | | | | | | | | | | | | | | | | | |

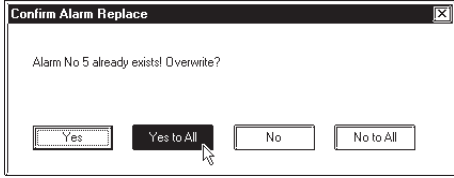
| PROCEDURE | REMARKS | | | | | | | | | | | | | | | | | | | | | | | | | | | | | | | | | | | | | | | | | | | | |
|--|-------------|-------------|--------------|---------|---|-------|----------|--------------|---|-------|---------|--------------|---|-------|---------|--------------|---|-------|---------|--|---|-------|---------|--|---|-------|---------|--|---|-------|---------|--------------|---|-------|---------|--|---|-------|---------|--|----|-------|---------|--|--|
|  <p style="text-align: center;">↓</p> <p>The selected alarm data is copied to the specified line(s).</p> <table border="1" data-bbox="213 660 810 958"> <thead> <tr> <th></th> <th>Bit Address</th> <th>Type</th> <th>Message</th> </tr> </thead> <tbody> <tr><td>1</td><td>X0010</td><td>Bulletin</td><td>Tank A stops</td></tr> <tr><td>2</td><td>X0050</td><td>Summary</td><td>Tank B stops</td></tr> <tr><td>3</td><td>X0051</td><td>Summary</td><td>Tank C stops</td></tr> <tr><td>4</td><td>X0052</td><td>Summary</td><td></td></tr> <tr><td>5</td><td>X0053</td><td>Summary</td><td></td></tr> <tr><td>6</td><td>X0054</td><td>Summary</td><td></td></tr> <tr><td>7</td><td>X0051</td><td>Summary</td><td>Tank C stops</td></tr> <tr><td>8</td><td>X0056</td><td>Summary</td><td></td></tr> <tr><td>9</td><td>X0057</td><td>Summary</td><td></td></tr> <tr><td>10</td><td>X0058</td><td>Summary</td><td></td></tr> </tbody> </table> | | Bit Address | Type | Message | 1 | X0010 | Bulletin | Tank A stops | 2 | X0050 | Summary | Tank B stops | 3 | X0051 | Summary | Tank C stops | 4 | X0052 | Summary | | 5 | X0053 | Summary | | 6 | X0054 | Summary | | 7 | X0051 | Summary | Tank C stops | 8 | X0056 | Summary | | 9 | X0057 | Summary | | 10 | X0058 | Summary | | |
| | Bit Address | Type | Message | | | | | | | | | | | | | | | | | | | | | | | | | | | | | | | | | | | | | | | | | | |
| 1 | X0010 | Bulletin | Tank A stops | | | | | | | | | | | | | | | | | | | | | | | | | | | | | | | | | | | | | | | | | | |
| 2 | X0050 | Summary | Tank B stops | | | | | | | | | | | | | | | | | | | | | | | | | | | | | | | | | | | | | | | | | | |
| 3 | X0051 | Summary | Tank C stops | | | | | | | | | | | | | | | | | | | | | | | | | | | | | | | | | | | | | | | | | | |
| 4 | X0052 | Summary | | | | | | | | | | | | | | | | | | | | | | | | | | | | | | | | | | | | | | | | | | | |
| 5 | X0053 | Summary | | | | | | | | | | | | | | | | | | | | | | | | | | | | | | | | | | | | | | | | | | | |
| 6 | X0054 | Summary | | | | | | | | | | | | | | | | | | | | | | | | | | | | | | | | | | | | | | | | | | | |
| 7 | X0051 | Summary | Tank C stops | | | | | | | | | | | | | | | | | | | | | | | | | | | | | | | | | | | | | | | | | | |
| 8 | X0056 | Summary | | | | | | | | | | | | | | | | | | | | | | | | | | | | | | | | | | | | | | | | | | | |
| 9 | X0057 | Summary | | | | | | | | | | | | | | | | | | | | | | | | | | | | | | | | | | | | | | | | | | | |
| 10 | X0058 | Summary | | | | | | | | | | | | | | | | | | | | | | | | | | | | | | | | | | | | | | | | | | | |

■ Undo

This feature allows you to cancel the previously performed command, and return to the previous condition.

| PROCEDURE | REMARKS | | | | | | | | | | | | | | | | | | | | | | | | |
|--|-------------|-------------|-----------------------|---------|---|--------|----------|-----------------------|---|--------|---------|-----------------------|---|--------|---------|-----------------------|---|--------|---------|--|---|--------|---------|--|--|
| <p>When an alarm has been unintentionally deleted:</p> <p>(1) Select the [Edit] menu - [Undo] command, or click on the  icon.</p> <table border="1" data-bbox="213 1514 890 1697"> <thead> <tr> <th></th> <th>Bit Address</th> <th>Type</th> <th>Message</th> </tr> </thead> <tbody> <tr><td>1</td><td>X00010</td><td>Bulletin</td><td>Tank A temperature UP</td></tr> <tr><td>2</td><td>X00050</td><td>Summary</td><td>Tank B temperature UP</td></tr> <tr><td>3</td><td>X00051</td><td>Summary</td><td>Tank C temperature UP</td></tr> <tr><td>4</td><td>X00052</td><td>Summary</td><td></td></tr> <tr><td>5</td><td>X00053</td><td>Summary</td><td></td></tr> </tbody> </table> | | Bit Address | Type | Message | 1 | X00010 | Bulletin | Tank A temperature UP | 2 | X00050 | Summary | Tank B temperature UP | 3 | X00051 | Summary | Tank C temperature UP | 4 | X00052 | Summary | | 5 | X00053 | Summary | | <p>Edited message characters cannot be restored with the [Undo] command.</p> |
| | Bit Address | Type | Message | | | | | | | | | | | | | | | | | | | | | | |
| 1 | X00010 | Bulletin | Tank A temperature UP | | | | | | | | | | | | | | | | | | | | | | |
| 2 | X00050 | Summary | Tank B temperature UP | | | | | | | | | | | | | | | | | | | | | | |
| 3 | X00051 | Summary | Tank C temperature UP | | | | | | | | | | | | | | | | | | | | | | |
| 4 | X00052 | Summary | | | | | | | | | | | | | | | | | | | | | | | |
| 5 | X00053 | Summary | | | | | | | | | | | | | | | | | | | | | | | |

■ Adding Alarm Data

Here, you can add alarms for the specified number of bits or words from the line whose item is enclosed with dotted lines. Addresses are automatically assigned to each alarm from the start address in series, according to the designated address adding increment. In addition, when messages have been entered, they are copied for all the alarms to be added.



When a variable (Logic symbol) is used as a start address, set the add offset to 0. Otherwise, the correct addition will not be performed.

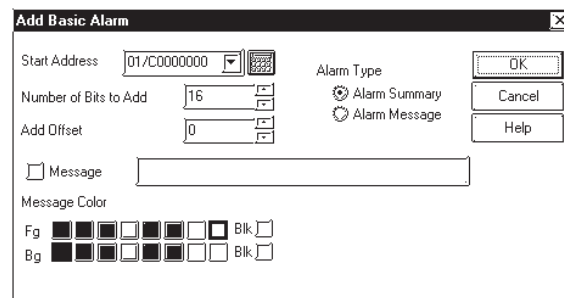

| PROCEDURE | REMARKS |
|-----------|---------|
|-----------|---------|

(1) Select the address line where the specified number of addresses will be added. (Shown here with a dotted line around its border)

| No. | Full Address | Type | Message |
|-----|--------------|----------|-----------------------|
| 1 | X0010 | Bulletin | Tank A temperature UP |
| 2 | X0001 | Summary | |
| 3 | X0002 | Summary | |
| 4 | X0003 | Summary | |
| 5 | X0004 | Summary | |

(2) Select the [Edit] menu - [Add Alarm] command, or click on the icon.

(3) After entering the necessary settings, click on the button.

If the same number already exists, the system asks if each file must be overwritten. If you select , the desired file will be overwritten. If you select , the desired file will not be overwritten, and the system will ask about the next alarm. If you select , all existing alarms will be overwritten. If you select , you will return to the menu screen.

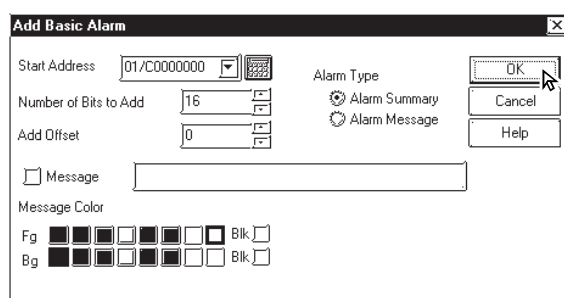

If a symbol is specified for the start address, the added addresses will be displayed as follows:

Example: Assume that the start address is TEST (← Symbol), and that the number of added bits is 4. The addresses are consecutively added as shown below:

```
TEST
TEST + 1
TEST + 2
TEST + 3
```

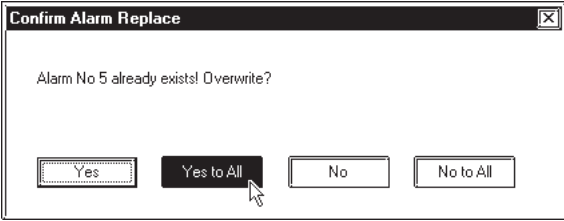
| PROCEDURE | REMARKS |
|--|---------|
|   | |

■ Changing Alarm Attributes

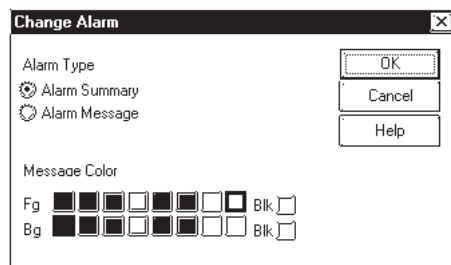

You can easily change any alarm's attributes.

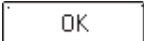
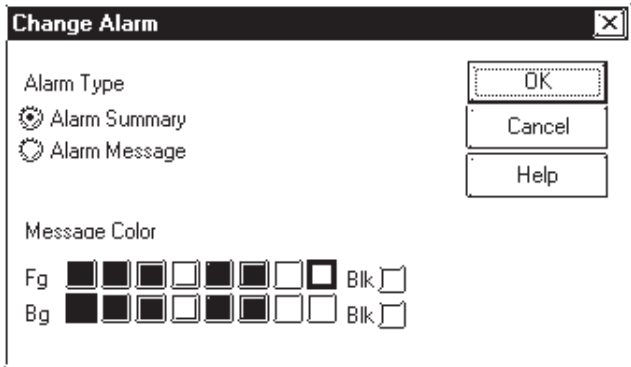

| PROCEDURE | REMARKS | | | | | | | | | | | | | | | | | | | | | | | | |
|---|-------------|-------------|-----------------------|---------|---|--------|----------|-----------------------|---|--------|---------|-----------------------|---|--------|---------|-----------------------|---|--------|---------|--|---|--------|---------|--|--|
| <p>(1) Select the line of the alarm to be changed. In this example, we will change an attribute of an item in the alarm message/alarm summary area.</p> <table border="1" data-bbox="220 1290 858 1462"> <thead> <tr> <th></th> <th>Bit Address</th> <th>Type</th> <th>Message</th> </tr> </thead> <tbody> <tr> <td>1</td> <td>X00010</td> <td>Bulletin</td> <td>Tank A temperature UP</td> </tr> <tr> <td>2</td> <td>X00050</td> <td>Summary</td> <td>Tank B temperature UP</td> </tr> <tr> <td>3</td> <td>X00051</td> <td>Summary</td> <td>Tank C temperature UP</td> </tr> <tr> <td>4</td> <td>X00052</td> <td>Summary</td> <td></td> </tr> <tr> <td>5</td> <td>X00053</td> <td>Summary</td> <td></td> </tr> </tbody> </table> <p>(2) Select the [Edit] menu - [Change Attributes] command, or click on the  icon.</p> <p>(3) After entering the necessary items, click on the  button.</p>  | | Bit Address | Type | Message | 1 | X00010 | Bulletin | Tank A temperature UP | 2 | X00050 | Summary | Tank B temperature UP | 3 | X00051 | Summary | Tank C temperature UP | 4 | X00052 | Summary | | 5 | X00053 | Summary | | <p>If several lines are selected, the attributes of the selected lines can all be simultaneously changed.</p> <p>To select several lines, drag the mouse between the desired lines, or click on the desired line while pressing the Shift or Ctrl key.</p> |
| | Bit Address | Type | Message | | | | | | | | | | | | | | | | | | | | | | |
| 1 | X00010 | Bulletin | Tank A temperature UP | | | | | | | | | | | | | | | | | | | | | | |
| 2 | X00050 | Summary | Tank B temperature UP | | | | | | | | | | | | | | | | | | | | | | |
| 3 | X00051 | Summary | Tank C temperature UP | | | | | | | | | | | | | | | | | | | | | | |
| 4 | X00052 | Summary | | | | | | | | | | | | | | | | | | | | | | | |
| 5 | X00053 | Summary | | | | | | | | | | | | | | | | | | | | | | | |

■ Reflecting Device Comments

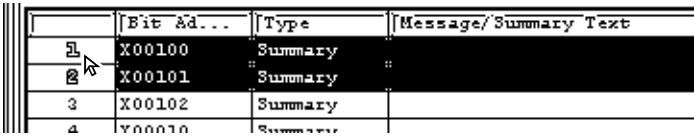
This feature is used to reflect all the comment information corresponding to a selected device in the Message field.

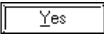
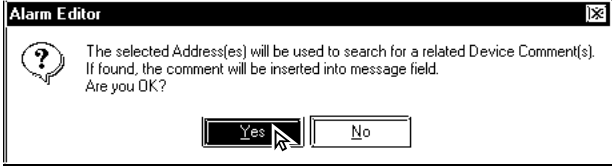
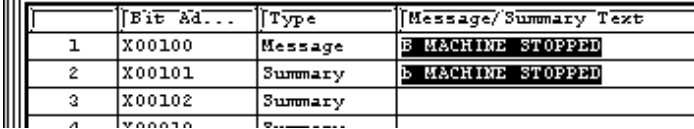
| PROCEDURE | REMARKS |
|---|---------|
| <p>(1) Select an alarm for which comment information is to be reflected, on a row basis. Here, reflect the comment in the device for the alarm message/alarm summary.</p>  | |
| <p>(2) Select the [Edit] menu - [Apply Device Comment] command, or click on the  icon.</p> | |
| <p>(3) A confirmation dialog box appears. Click on the  button to execute the command</p>  | |
| <p>(4) The device comment corresponding to the address will be included in the messages.</p>  | |

5.1.4 Alarm Import/Export

The created Alarm data can be exported to and saved as an ALA or CSV file. Then, by importing the saved alarm data, it can be shared among Projects. CSV files created via a text editor or Microsoft Excel can be imported and used on the Alarm Editor. Alarm data's CSV file formats are as follows:

| | | |
|---|---------------------------------|--|
| “Block”, “0” | Reserved 1 | |
| “Block1”, “0” | Reserved 2 | |
| “Block2”, “0” | Reserved 3 | |
| “Block3”, “0” | Reserved 4 | |
| “Basic Alarm” | Message/Summary settings | |
| “M0064”, “Function A in suspension”, “0”, “0”, “7”, “0”, “0”, “0” | | “Bit Address”, “Message” “Re- served 5”, “Fg”, “Blk”, “Bg”, “Blk” |
| “M0065”, “Function B in suspension”, “1”, “1”, “1”, “1”, “2”, “1” | | |
| “M0066”, “Function C in suspension”, “2”, “0”, “3”, “0”, “5”, “1” | | |

| | | |
|------------------------|---|---|
| Reserved 1 | 0 fixed | |
| Reserved 2 to 4 | 0 fixed | |
| Reserved 5 | 0 fixed | |
| Message Colors | Foreground color (Fg), Background color (Bg) | 0 to 7 |
| | Blink (Blk) | 0: Not blink 1: Blink 2: Not blink 3: Blink |

■ Alarm Export

Alarm data is saved as ALA or CSV files.

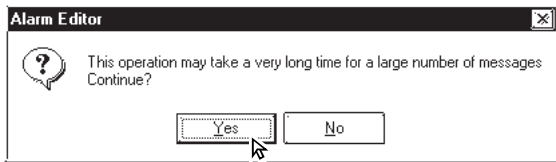
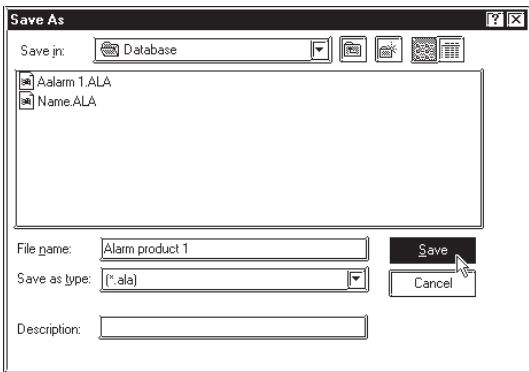
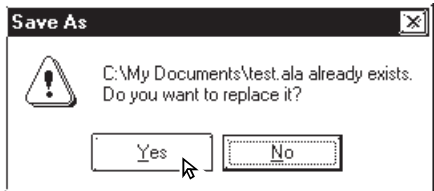
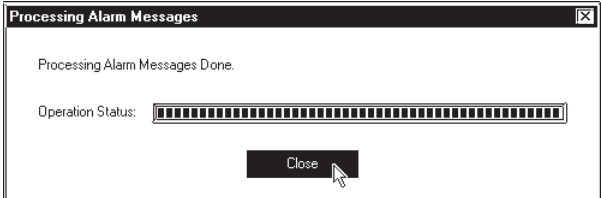



| PROCEDURE | REMARKS |
|---|---------|
| <p>(1) Select the Alarm Editor's [Alarm] menu - [Export] command.</p> <p>(2) Click on the <input type="button" value="Yes"/> button.</p>  <p>(3) Specify the file name and file type (*.ALA or *.CSV) with which the exported alarm data is saved, and click on the <input type="button" value="Save"/> button.</p> <p>Enter a comment, if desired. If the same ALA file name already exists, the system asks if the existing file must be overwritten. If it must be overwritten, select <input type="button" value="Yes"/>. If it should not be overwritten, select <input type="button" value="No"/>.</p>  <p style="text-align: center;">↓</p>  <p>(5) Click on the <input type="button" value="Close"/> button to quit the Alarm export mode.</p>  | |

■ Alarm Import

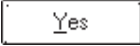
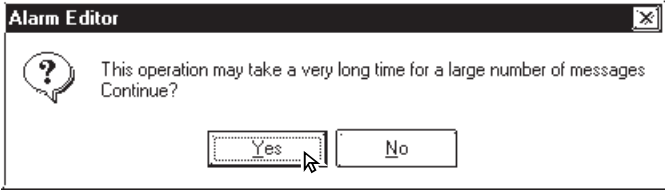
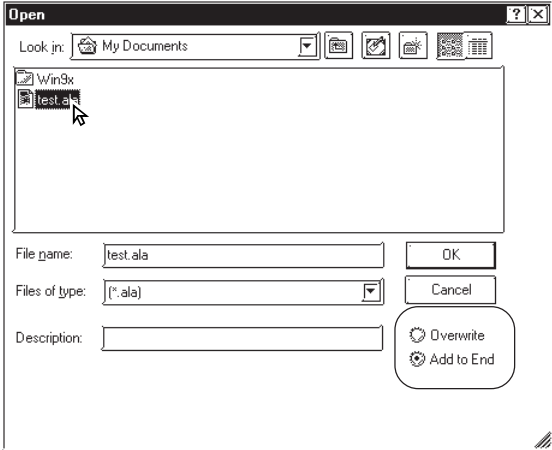
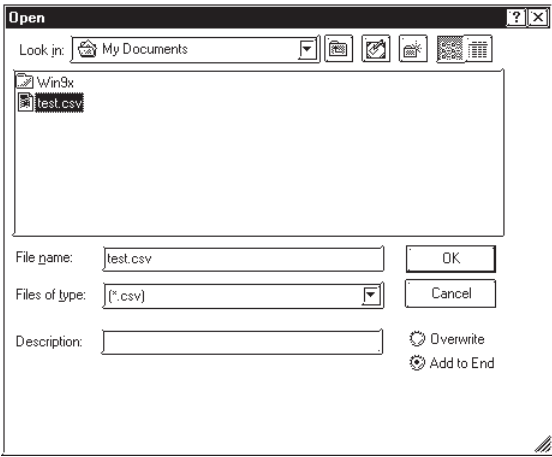
Alarm data saved as a file is imported to the currently open Alarm Editor. Files with the extension of “*.ALA” or “*.CSV” can be imported.

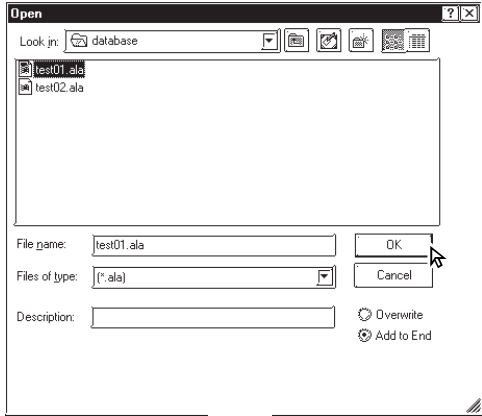
To import alarm data from a CSV file, only the specified type of alarm can be imported from all the registered alarm.

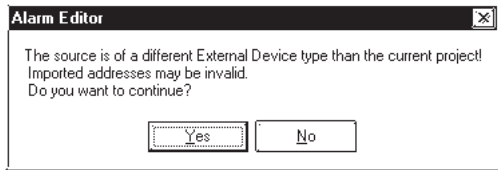
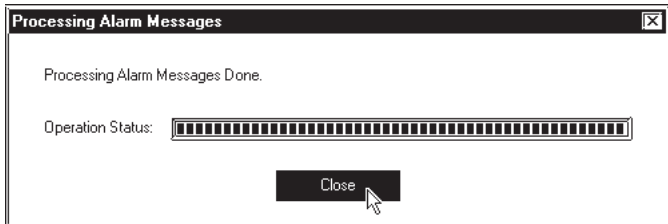
| PROCEDURE | REMARKS |
|---|---|
| <p>(1) Select the Alarm Editor’s [Alarm] menu - [Import] command.</p> | |
| <p>(2) Click on the  button.</p> | |
|  | |
| <p>(3) Select a file (*.ALA or *.CSV) to be imported, or enter the file name. Then, specify an import method.</p> | <p>[Overwrite] All current alarm registration numbers (1 to 8999) will be overwritten.</p> |
|  | <p>[Add to End] Imported messages will be added after the last message line. If there are any gaps between the current registration numbers, the sequence numbers will be re-assigned to fit into all existing lines, and the imported messages will be added after the last line.</p> |
| <p>(4) When selecting CSV file as imported file type, specify the type of alarm to be imported. Only the type of alarm specified here will be imported.</p> | <p>When selecting ALA file as imported file type, skip step (4).</p> |
|  | |

| PROCEDURE | REMARKS |
|---|---|
| <p>(5)After entering all the necessary items, click on the <input type="button" value="OK"/> button.</p> <p>If the selected External Device is different between the currently open project and the imported ALA file, the system asks if the preset addresses should be overwritten. If the preset addresses must be overwritten, select <input type="button" value="Yes"/> . If they must not be overwritten, select <input type="button" value="No"/> .</p>  <p>The 'Open' dialog box shows a file list with 'test01.ala' and 'test02.ala'. The 'File name' field contains 'test01.ala', 'Files of type' is set to '*.ala', and 'Add to End' is selected. The 'OK' button is highlighted.</p>   <p>The 'Alarm Editor' dialog box displays the warning: 'The source is of a different External Device type than the current project! Imported addresses may be invalid. Do you want to continue?' with 'Yes' and 'No' buttons.</p> <p>(6)Click on the <input type="button" value="Close"/> button to quit import mode. Since you selected [Add to End] in this example, the imported messages were added after the last line.</p>  <p>The 'Processing Alarm Messages' dialog box shows 'Processing Alarm Messages Done.' and a full progress bar. A 'Close' button is at the bottom.</p> |  <p>Important</p> <p>Once you complete the [Import] command, it cannot be undone.</p> |



· **When alarm data does not have an identifier "Block*" for the first 4 lines which indicate Reserved 1 to 4, the alarm will not be imported.**

· **If the address(es) registered in the alarm data to be imported are incorrect, set correct addresses via the Symbol Editor.**

Reference 4.2.5 Symbol Editor

· **When the number of message characters exceeds the limit, the message is imported only for the effective number of characters.**

· **When data is imported from a file in which only a message is registered, the initial value is used as an address.**

6

LT INITIAL AND SYSTEM SETTINGS

You can select many of the LT unit's initial settings through the LT Editor for Windows program. This program area is called "System Settings". When "System Settings" data is sent to the LT unit, you will not need to manually perform the initial setup of the LT unit. A description of each LT unit setting item is provided in your "LT Series User's Manual" (sold separately). For details, refer to that manual.

6.1 Menu Setting Items: LT Setup

6.1 Menu Setting Items: LT Setup

In the [System Settings] mode, you can easily select the LT unit's initial settings. By doing this, you don't need to manually set up the LT panel, since the [System Settings] data is sent to the LT panel automatically. After the [System Settings] data is sent to the LT panel, you can also change those settings via the LT unit itself.

Reference *LogiTouch Series User's Manual (sold separately), Chapter 6: INITIALIZE*

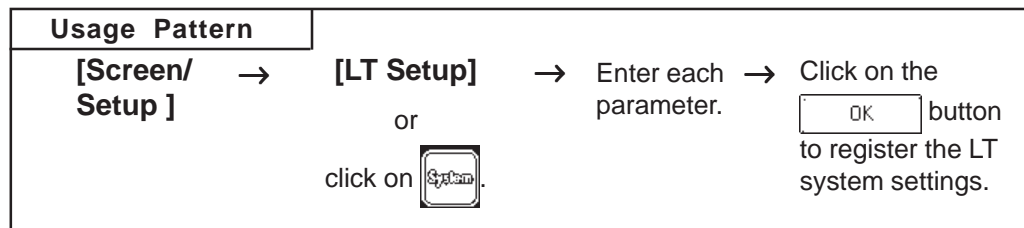

Some setting commands are supported by the LT unit but not by LT Editor for Windows, or vice versa, i.e. are supported by LT Editor for Windows but not supported by the LT unit. This section describes only the commands supported by LT Editor for Windows. For a description of other commands, refer to your "LT Editor User's Manual" (sold separately).

◆ Setting commands Supported by Only the LT Unit:

- Setting Date/Time
- Self-diagnosis command
- Font settings (English, Korean, etc.)*¹

◆ Commands Supported by Only LT Editor:

- **LT Settings: [Checksum]**
Enables checksum verification.
- **LT Settings: [Screen Level Change Flow]**
Used to switch screens in the hierarchical display mode.
- **LT Settings: [Change to Screen No.]**
Specify the number of the screen used to replace the current one after the preset standby time has passed. If you enter "0", no screen will be displayed.
- **I/O Settings: [Offline Mode]**
Specify how to change from on-line mode to off-line mode.
- **Mode Settings: [External Device]**
Displays the name of the host (External Device) connected to the LT panel.
- **Mode Settings: [Option]**

Reference *LT Editor External Device Connection Manual*

*1 If any font setting other than "Japanese" is selected, "Font Setting" requires specifying whether alphanumeric characters and symbols are to be displayed at the high quality level.

- **Extended Settings: [Keypad Display Priority]**
Designates the Keypad Display processing mode. "Standard" mode executes the processing of the Keypad Display once per scan time, and "Twice" mode executes the processing two times per scan time.
- **Extended Settings: [Backup Settings]**
Used to back up the LT panel's LS area data. Specify the initial address of the backup range, and the number of words used.
- **Extended Settings: [Delete Error Display](Only for programless type)**
Displays an error message when an communication error occurs with the LT unit panel, and deletes the error message when the communication error is reset. System errors however cannot be reset, regardless of this setting.
- **Extended Settings: [Watch Dog]**
Monitors the communication status between the LT panel and External Device. The LT unit sends "00FF" to the External Device's word address at a specified time interval. The External Device checks whether the communication is performed normally by confirming the "00FF" command at the specified time interval.
- **Communication Settings: [Send Wait]**
If the LT unit sends a command to the External Device immediately after receiving a response from the External Device, the External Device cannot receive the command, which will cause a communication error, depending on the External Device. In this case, enter a value for the transmission wait time. If a transmission wait time has been entered, the LT unit waits for the preset time duration after receiving the External Device's response, and then sends the next command to the External Device.

■ **Tab Setting Items**

Each tab's setting items are described here.



Note: The setting items may differ depending on the LT type or External Device being used.

◆ **LT Settings**

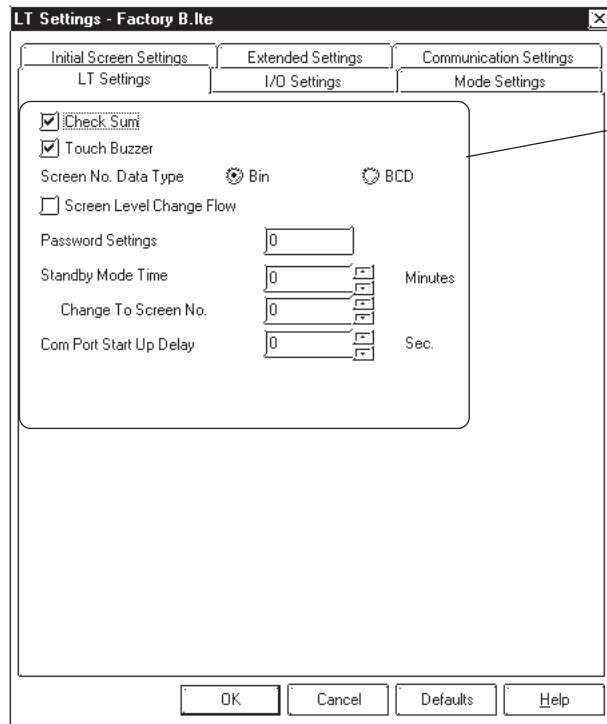

System Setting Items

◆ **I/O Settings**

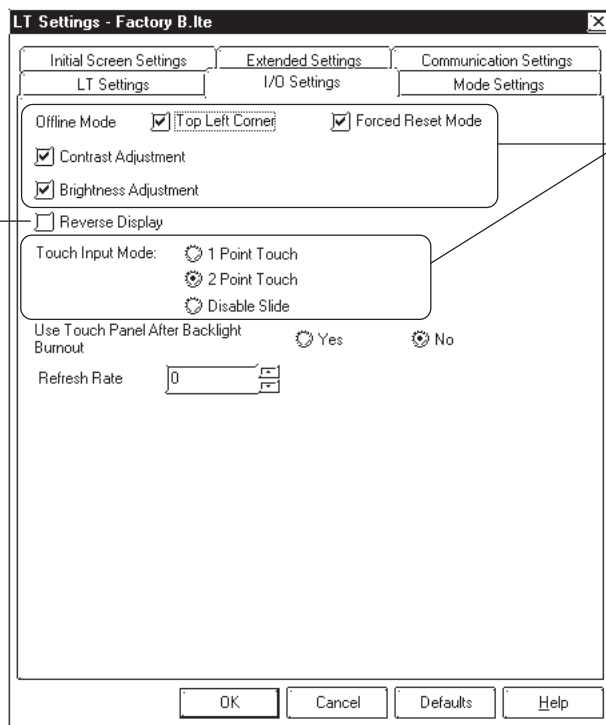

Touch Panel Settings

LCD Settings

◆ Mode Settings

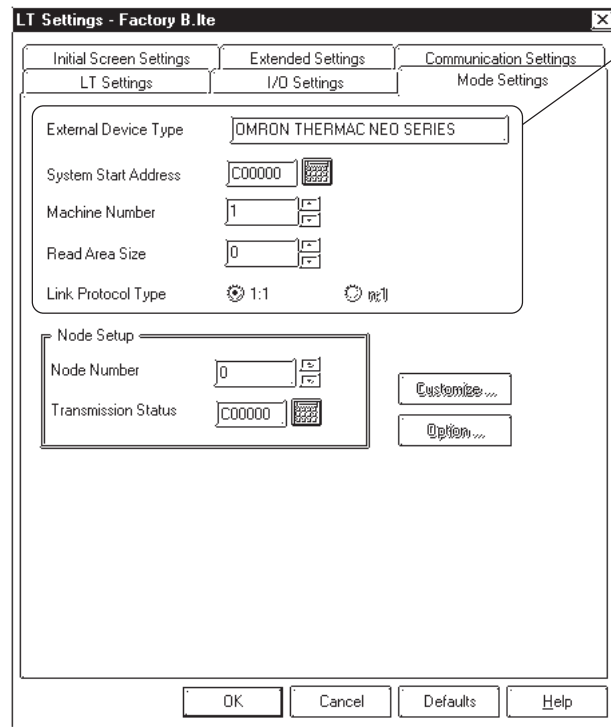

Operating Environment Settings

◆ Initial Screen Settings

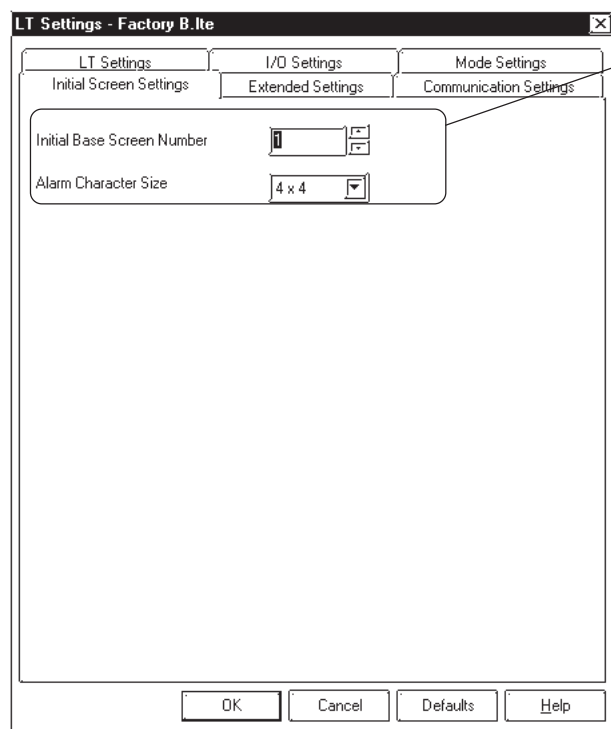

Initial Screen Settings

◆ Extended Settings

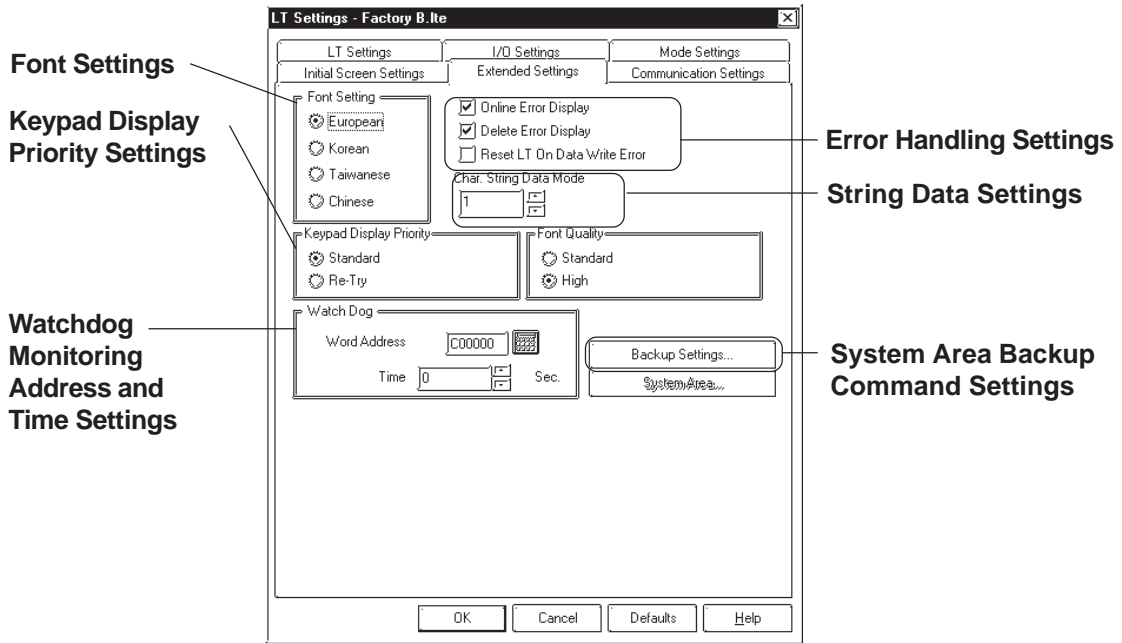

◆ Communication Settings Menu

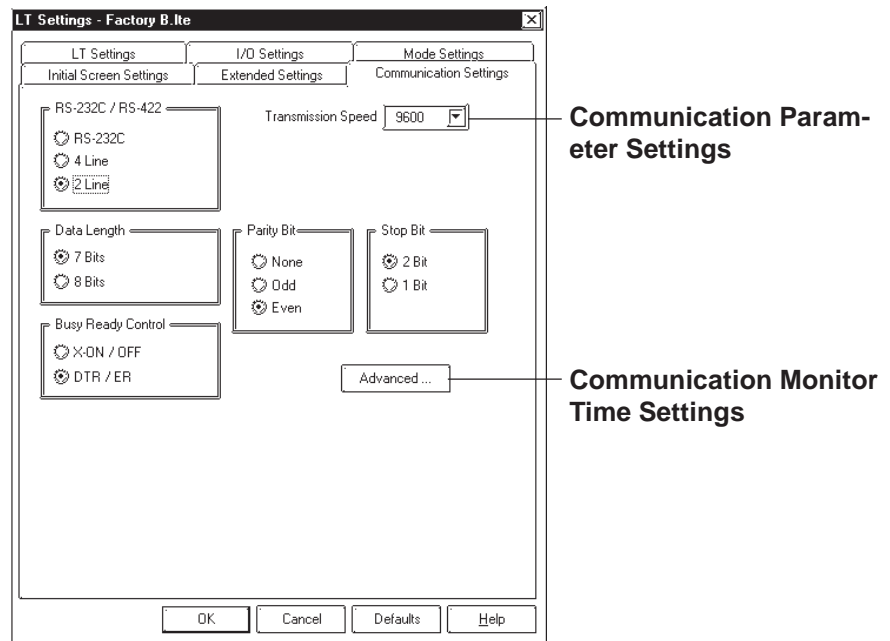

■ LT System Settings

| PROCEDURE | REMARKS |
|-----------|---------|
|-----------|---------|

(1) Via the Project Manager, select the [Screen/Setup] menu - [LT System Settings] command, or click on the  icon.

(2) Click on a desired menu tab.
Each tab's setting items will be displayed.

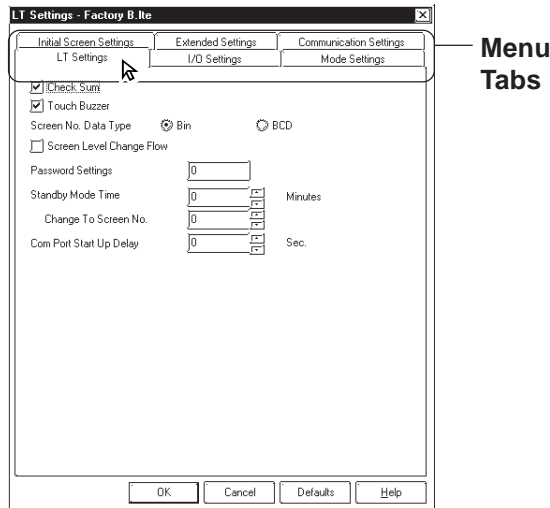

(3) After entering all the necessary items, click on the  button.

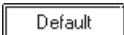
To reset each item to its default value, click on the  button.

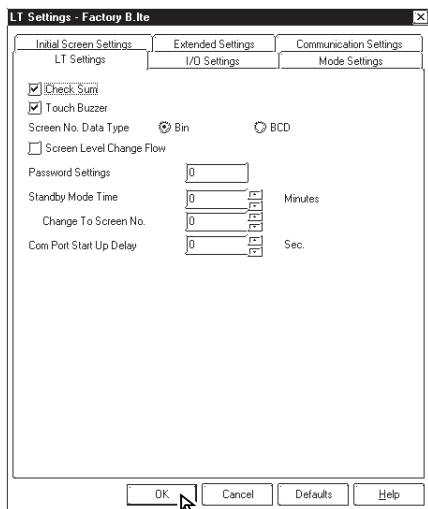

Memo

To display screens created with the LT Editor on the LT unit, or to run the created logic program on the LT unit, you must first transfer data to the LT. Conversely, you can also transfer the data stored in the LT unit back to the LT Editor.

This chapter describes how to transfer data to and from the LT unit.

- 7.1 **Prior to Transferring Data**
- 7.2 **Transferring Data and Logic Programs**
- 7.3 **Options**

7.1 Prior to Transferring Data

7.1.1 LT Screen Transfer Cable

You must first connect the Data Transfer Cable to the LT unit and your personal computer before you can transfer screen data.

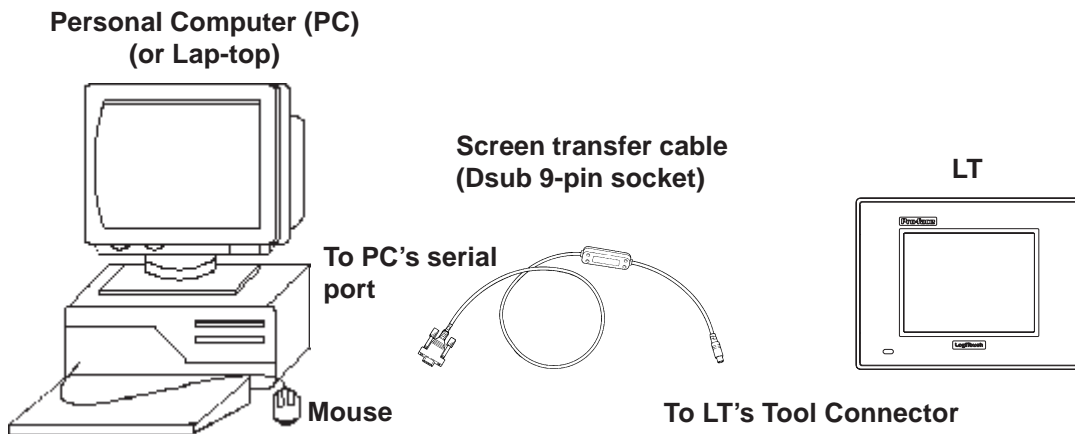

To transfer LT Editor data to the LT unit, the optional screen transfer cable (GPW-CB02) is required. This cable does not come with any interface conversion adapter for the personal computer. Supply a connector conversion adapter compatible with the interface of your personal computer.



- Use a pin adapter that fits your personal computer's serial port.
- If a serial mouse is used, be sure to connect the cable from the LT unit to a different serial port on your PC.

7.2 Transferring Data and Logic Programs

This section describes how to transfer screen data created with the LT Editor program to and from the LT unit.

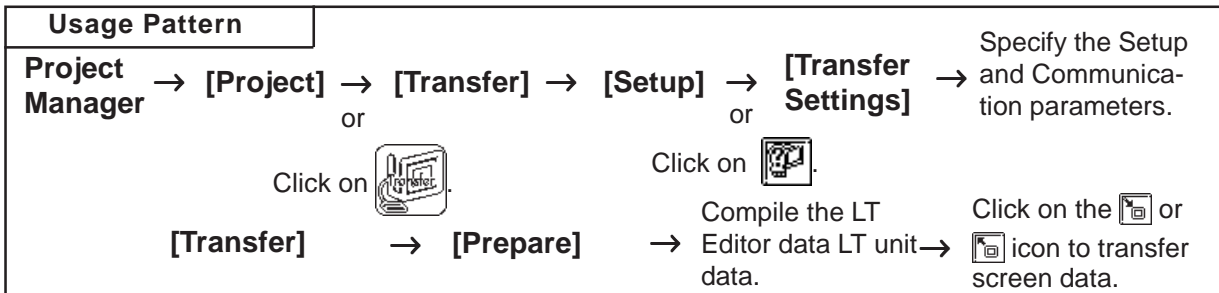

To display a screen (window) to perform data transfer, select the Project Manager's [Project] menu - [Transfer] command, or click on the icon. Or, select the Screen Editor's [Screen] menu - [Transfer] command, or click on the icon. An example of this screen (window) is as follows:

Transfers screen data and logic programs from LT Editor to the LT unit

Transfers only logic programs

Receives screen data and logic programs from the LT unit to the LT Editor.

Displays the current status of the data transfer operation

Displays the current project's comment data

Displays the transfer preparation status

Displays the progress of the data transfer operation

Displays the current project file name

Displays the currently-specified transfer mode

Displays the currently-specified setup mode

Displays the currently-specified destination type

Transfers screen data and logic programs from LT Editor to the LT unit

Transfers only logic programs

Receives screen data and logic programs from the LT unit to the LT Editor.

Displays the current status of the data transfer operation

Displays the current project's comment data

Displays the transfer preparation status

Displays the progress of the data transfer operation

Displays the current project file name

Displays the currently-specified transfer mode

Displays the currently-specified setup mode

Displays the currently-specified destination type

The tool bar icons provide the following functions:

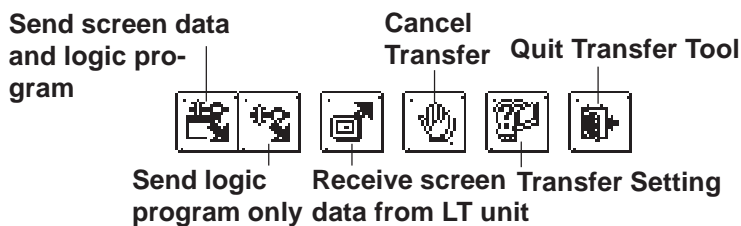

Do not turn OFF the PC or the LT unit, nor disconnect the transfer cable during the transfer of screen data. This can cause an error when the LT is started.

7.2.1 Transfer Settings

This section describes the parameter settings necessary for screen data transfer between your personal computer and the LT unit. These parameters must be reset if your personal computer has been disconnected from the LT unit, if the LT unit has been shut down, or if a nonstandard system or protocol program has been used with the LT unit.

Transfer Settings

Select the [Setup] menu - [Transfer Settings] command, or click on the  icon. Then, a dialog box to perform data transfer settings will appear.

Specify the kind of information to transfer with the screen data.

Select the transfer mode

Select the setup mode

Locate the setup information file

Select the PC serial port that will be used with the data transfer cable

Select a transfer speed.

Sends the simulation protocol to the LT unit.

Reference 8.1 Simulation Procedure

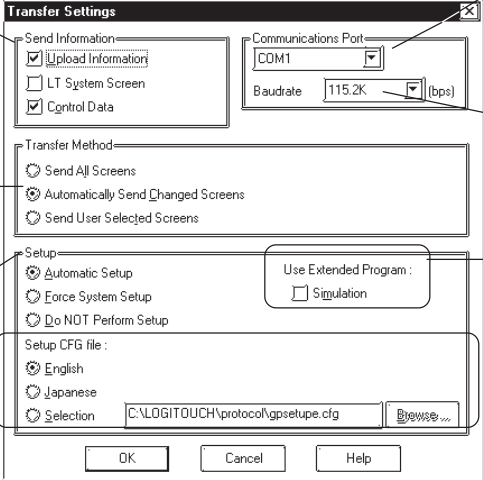
Transferring Information

Send Information

Upload Information

LT System Screen

Control Data

Upload Information

Check this box if you wish to send upload information to receive data from the LT unit.



Upload parameter data must be included to Receive data from the LT unit. If the LT unit's memory is insufficient to include the upload parameter data, data can still be transferred from your personal computer to the LT unit. However, if the upload parameter data is omitted, your personal computer cannot receive data from the LT unit.

LT System Screen

Check this box if you wish to transfer LT system settings information along with other data to the LT unit.

Control Data

Check this box if you wish to send logic programs along with other data to the LT unit. When transferring system programs or protocol programs, however, logic programs are always transferred regardless of the setting of this screen.

◆ Communication Port

Select a serial port to which the transfer cable is connected, and a transfer speed.

◆ Transfer Method

Transfer Method

Send All Screens

Automatically Send Changed Screens

Send User Selected Screens

Send All Screens

Transfers all screen data in a Project File to the LT unit.

Automatically Send Changed Screens

Any screen data that have been updated in the current Project File are automatically transferred to the LT unit. This transfer mode is only effective when screens have been previously transferred to the LT unit.



Note: When “Automatically Send Changed Screens” is used, screens that have been deleted (not just updated) from the Project File in the LT Editor program will not be automatically deleted from the Project File stored in the LT unit. To completely replace all screens of the Project File stored in the LT unit, be sure to use “Send All Screens”.

Send User Selected Screens

When transferring a screen to a Project File stored in the LT unit, you must specify the screen type.



Note: No Filing Data and logged data can be specified to transfer them.

To select screens, click on the names of desired screens while holding down the **Ctrl** key.

Select Screens to Send

Select Screens To Transfer

| Type | Number | Title |
|-----------------|--------|----------------|
| Data Sampling | | |
| Base | 2 | Alarm1 |
| Base | 13 | Switch 1 |
| Base | 15 | Switch2 |
| Base | 16 | Production Ala |
| Mark Screen | 1 | Untitled |
| Image | 1 | Logilogo.bmp |
| Message/Summary | 1 | Alarm File |

OK Cancel Help

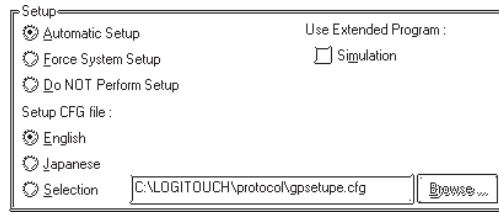
◆ **Setup****Automatic setup :**

Set up operation is performed if necessary, according to the LT's status. Normally, select this setup mode.

Force system setup :

Setup operation is performed every time screen data are transferred, regardless of the LT's status.

Do not setup :

Setup operation is not performed, and only screen data and logic programs are transferred.

Setup CFG file :

This is the file storing the setup information. Normally, you need not use this setup mode.

If you select "English" and perform setup, the OFFLINE screen on the LT unit will be displayed in English.



If you have changed from Japanese to English or vice versa, be sure to force the system setup.

Use Extended Program

When using the Simulation Function with the LT Type-C, you need to transfer a simulation protocol in advance.

▼ **Reference** ▲ *8.1 Simulation*



7.2.2 Passwords

■ Registering a Password

You can enter a password to restrict user access to the data transfer function.









- **Be sure to keep a copy of the password in a safe place. If you forget the password, the “Transfer” function cannot be executed.**
- **The password is limited to 24 characters and only alphanumeric data (no symbols) can be used.**

| PROCEDURE | REMARKS |
|---|--|
| <p>(1) Via the Project Manager, select the [Project] menu - [Transfer] command, or click on the  icon. Or, via the Screen Editor, select the [Screen] menu - [Transfer] command, or click on the  icon.</p> <p>(2) Select the [Setup] menu - [Password] command.</p> <p>(3) Enter a password.</p> <div data-bbox="252 1086 662 1456" style="border: 1px solid black; padding: 5px; margin: 10px 0;"> <p>Register Password [X]</p> <p>Please Enter Password: <input type="password"/></p> <p>Please Confirm Password: <input type="password"/></p> <p>Warning: Please remember to write down your password! If you forget your password, screen transfer cannot be performed.</p> <p style="text-align: right;"> <input type="button" value="OK"/> <input type="button" value="Cancel"/> <input type="button" value="Help"/> </p> </div> <p>(4) Enter the same password again for confirmation, and then, click on the <input type="button" value="OK"/> button.</p> <div data-bbox="252 1601 662 1971" style="border: 1px solid black; padding: 5px; margin: 10px 0;"> <p>Register Password [X]</p> <p>Please Enter Password: <input type="password"/></p> <p>Please Confirm Password: <input type="password"/></p> <p>Warning: Please remember to write down your password! If you forget your password, screen transfer cannot be performed.</p> <p style="text-align: right;"> <input type="button" value="OK"/> <input type="button" value="Cancel"/> <input type="button" value="Help"/> </p> </div> | <p>If a password has already been registered, the [Change Password] dialog box will appear.</p> <div data-bbox="1005 1635 1420 2027" style="border: 1px solid black; padding: 5px; margin: 10px 0;"> <p>Change Password [X]</p> <p>Please Enter Password: <input type="text"/></p> <p>Please Enter New Password: <input type="text"/></p> <p>Please Re-enter New Password: <input type="text"/></p> <p style="text-align: right;"> <input type="button" value="OK"/> <input type="button" value="Cancel"/> <input type="button" value="Help"/> </p> </div> |

■ Changing a Password

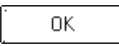
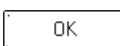
The registered password can be changed or canceled.

| PROCEDURE | REMARKS |
|---|--|
| <p>(1) Via the Project Manager, select the [Project] menu - [Transfer] command, or click on the  icon. Or, via the Screen Editor, select the [Screen] menu - [Transfer] command, or click on the  icon.</p> <p>(2) Select the [Setup] menu - [Password] command.</p> <p>(3) In order to change a password, you must first enter the currently registered password.</p>  | |
| <p>(4) Enter a new password.</p>  | <p>To cancel the password, after entering the currently registered password in step (2), DO NOT enter a new password in step (3) and simply click on the  button.</p> |
| <p>(5) Enter the same password again for confirmation, and then, click on the  button.</p>  |  |

7.2.3 Transfer Preparation

The Project File (LTE file) data created with the LT Editor program is first compiled before it is transferred to the LT unit.

Select the [Project] menu - [Prepare] command to compile your data.

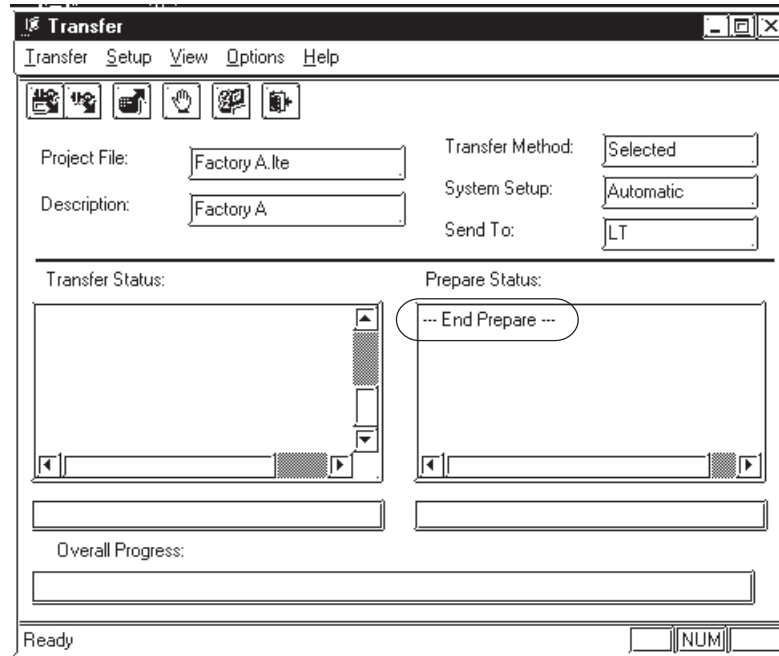

Note: • After the [Prepare] command is finished, you can check the LT unit's current memory capacity with the [Project Information] feature.

Reference 4.4.1 Project Information

- Once you use the [Prepare] command, you do not need to use it again for the same data, unless the data has been updated.
- If the Project File to be transferred is stored on your PC's floppy disk, copy it to your PC's hard disk prior to using "Prepare" to reduce transfer time.

7.2.4 When Sending Screens and Logic Programs Together To the LT





To display screen created with LT Editor and to run created logic programs on the LT panel, you must first transfer data from the LT Editor to the LT unit.

The [All Send] command transfers the screen data and logic programs at the same time. You can also send logic programs alone.

Reference 7.2.5 When Sending Logic Programs



In the case of LT Type C, if the LT is not connected to the external device when the screen data are transferred to the LT and the "Change State" function is set to "Yes", bit switches, toggle switches, lamps, and objects will not be displayed on the LT panel after data transfer.





| PROCEDURE | REMARKS |
|---|--|
| <p>(1) Via the Project Manager, select the [Project] menu - [Transfer] command, or click on the  icon. Otherwise, via the Screen Editor, select the [Screen] menu - [Transfer] command, or click on the  icon.</p> <p>(2) Select the [Transfer] menu - [Send] command, or click on the  icon.</p> <p>If the currently open Project File has not been prepared for data transfer (the Project File has not been compiled), then the system automatically compiles the Project File before transferring it to the LT unit.</p> <p>To transfer a screen to the LT unit for the first time, set up the LT unit^{*1} first, and then transfer the screen data. The number of screens transferred is displayed in [Transfer Status].</p> <p>If the external device designated in the project file to be transferred is different from the LT's existing internal data, the following message will appear. When you click on the <input type="button" value="OK"/> button, the system starts setup operation, and then transfers the screen data.</p> <div style="display: flex; justify-content: space-around;"> <div data-bbox="209 1720 587 1861"> </div> <div data-bbox="632 1720 911 1861"> </div> </div> <p>After set up is completed, the LT panel screen is automatically switched to the OFF-LINE mode. Confirm the initial setting on the LT panel, and adjust the settings as required.</p> | <p>Make sure that the LT unit is in the "Transfer Screen Data" mode or "RUN" mode.</p> <p>Reference <i>LogiTouch User's Manual (sold separately): CHAPTER 6 INITIALIZE</i></p> <p>When transferring logic programs, you must first select [Control Data] in the [Transfer Settings] dialog box.</p> <p>Reference 7.2.1 Transfer Settings</p> <p>To cancel the data transfer mode, click on the  icon.</p> <p>Data transfer mode will automatically quit when the LT unit's internal memory capacity becomes insufficient.</p> |

*1 "LT setup" means to download the system program and protocol program from LT Editor to the LT unit so that the LT unit can operate in the specified environment.

| PROCEDURE | REMARKS |
|--|---------|
| <p>(3) After screen data transfer is completed, select the [Transfer] menu - [Exit] command, or click on the  icon.</p> | |

■ **Transferring a Screen Using a Password**

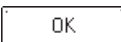
If a password has been registered, you must enter it to transfer data to the LT unit.

| PROCEDURE | REMARKS |
|--|---|
| <p>(1) Via the Project Manager, select the [Project] menu - [Transfer] command, or click on the  icon. Or, via the Screen Editor, select the [Screen] menu - [Transfer] command, or click on the  icon.</p> <p>(2) Select the [Transfer] menu - [Send] command, or click on the  icon.</p> <p>(3) Enter the registered password, and click on the  button to confirm it. The data transfer operation will start.</p> <div data-bbox="252 1370 662 1563" data-label="Image"> </div> <p>(4) After screen data transfer is completed, select the [Transferring Data and Logic Programs] menu - [Exit] command, or click on the  icon.</p> | <p>If you enter an incorrect password three times or more, data transfer cannot be performed. In this case, repeat the transfer procedure from step (2).</p> <div data-bbox="992 1249 1292 1411" data-label="Image"> </div> <p>To cancel data transfer mode, click on the  icon.</p> |

7.2.5 When Sending Logic Programs

You can also send logic programs alone to the LT that has been already set up.





Logic programs can be transferred from the Logic Program Editor as well.

Reference 7.2.7 *Sending Logic Programs with the Logic Program Editor*



Before sending logic programs alone, be sure to select the [All Send] command.

Reference 7.2.4 *When Sending Screens and Logic Programs Together To the LT*

| PROCEDURE | REMARKS |
|---|--|
| <p>(1) Via the Project Manager, select the [Project] menu - [Transfer] command, or click on the  icon. Otherwise, via the Screen Editor, select the [Screen] menu - [Transfer] command, or click on the  icon.</p> <p>(2) Select the [Only Control Send] command, or click on the  icon. If a password has been registered, enter the password.</p> <div data-bbox="205 1211 619 1406" data-label="Image"> </div> <p>(3) After the transfer is completed, select the [Transfer] menu - [Exit] command, or click on the  icon.</p> | <p>The LT unit must be set to [Screen Transfer mode] or [Running mode].</p> <p>Reference "LogiTouch Series User's Manual (optionally available) Chapter 6 Initial Settings</p> <p>Reference 7.2.2. <i>Passwords</i> If you enter an incorrect password three times or more, data transfer cannot be performed. In this case, repeat the transfer procedure from step (2).</p> <div data-bbox="954 1294 1254 1458" data-label="Image"> </div> <p>To cancel data transfer mode, click on the  icon.</p> |









7.2.6 When Receiving Data From the LT

Data stored in the LT unit can be received on a project file basis by the LT Editor.

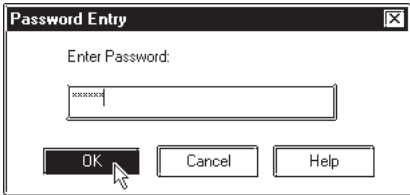
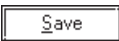

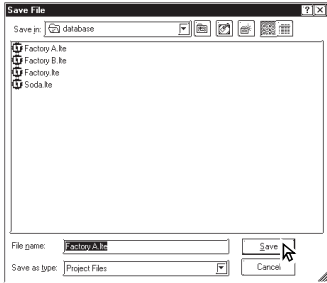
To receive transferred data with the password registered, password entry is required when receiving the data.

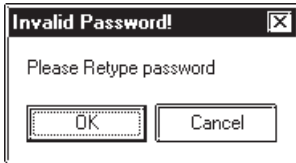

Unless [Upload Information] is selected in the [Transfer Settings] dialog box when any data is transferred to the LT unit, the data cannot be received from the LT unit.

| PROCEDURE | REMARKS |
|---|---|
| <p>(1) Via the Project Manager, select the [Project] menu - [Transfer] command, or click on the  icon. Or, via the Screen Editor, select the [Screen] menu - [Transfer] command, or click on the  icon.</p> <p>(2) Select the [Transfer] menu - [Receive] command, or click on the  icon. If a password has been registered, enter the password.</p>  <p>(3) Specify a location (directory) and Project file to store the received data. Then, click on the  button. If the same Project File name already exists, the system asks if you wish to replace it; if so, select  , otherwise select  .</p>  <p>(4) After the data transfer is completed, select the [Transfer] menu - [Exit] command, or click on the  icon.</p> | <p>Reference 7.2.2. Passwords If you enter an incorrect password three times or more, data transfer cannot be performed. In this case, repeat the transfer procedure from step (2).</p>  <p>To cancel data transfer mode, click on the  icon.</p> |

■ Receiving Logic Programs

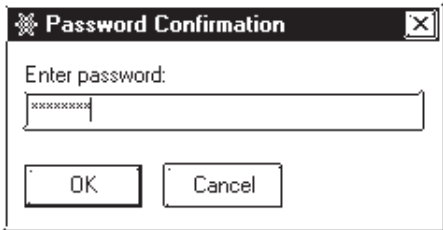
| PROCEDURE | REMARKS |
|--|--|
| <p>(1) Via the Project Manager, select [Control] menu - [Editor] command, or click on the  icon to start the Logic Program Editor.</p> <p>(2) Select the [Controller] menu - [Read from Controller] command, or click on the  icon to receive logic programs.</p> <p>If a password has been registered, enter the password.</p> <div data-bbox="240 692 684 920">  </div> <p>Logic programs alone are received.</p> | <p>Reference <i>1.2.3 Creating/Editing/Saving Logic Programs</i></p> <p>Reference <i>7.2.2 Passwords</i></p> |

7.3 Options

In addition to transferring/receiving screen data, you can check the screen information on the connected LT Unit using the LT Editor program.

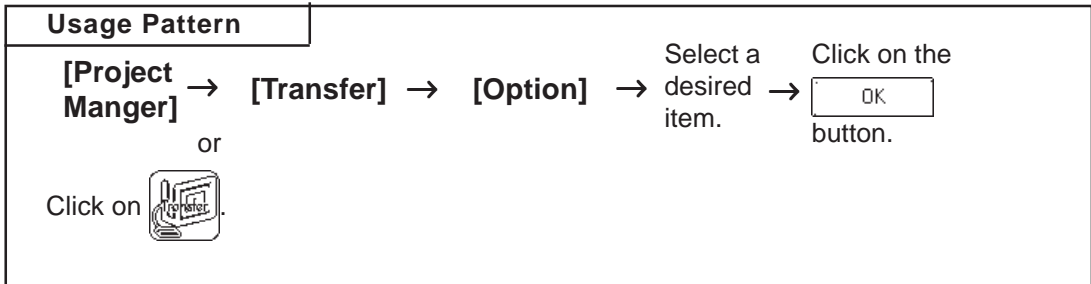

7.3.1 LT Internal Screen Data Information

LT internal information will be displayed, here. Functions such as [Screen List], [Memory Info] and [LT Version] are included.

■ List Screens

The screen name, data volume and title of the screens stored in the LT unit are listed by screen type.

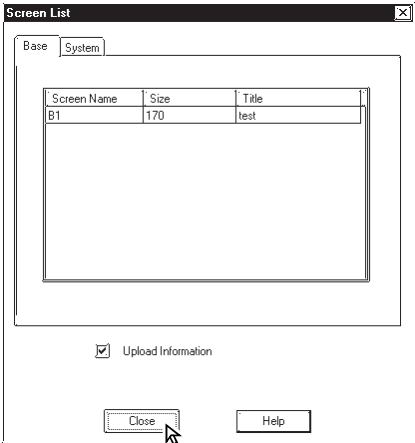
| PROCEDURE | REMARKS |
|--|--|
| <p>(1)Select the [Options] menu - [Screens List] command. Screens of the current project will be listed.</p> <p>(2)After confirming the displayed information, click on the <input type="button" value="OK"/> button to close the screen list. [Upload Information]: .. Indicates if the upload information has been transferred to the LT unit or not.</p>  | <p>Listed Screen Types</p> <ul style="list-style-type: none"> Base screens Image screens Mark screens Messages/summaries LT system settings |

■ **Memory Information**

The LT unit's current memory capacity for a specified memory area (bank) is displayed. Its maximum internal memory capacity is also displayed.

| PROCEDURE | REMARKS | | | | | | | | | | | | | | | | | | | | | | | | | | | |
|---|--------------|--------------|--|---|-------|---|---|-------|--|---|-------|--|---|-------|--|---|-------|--|---|-------|--|---|-------|--|---|-------|---|--|
| <p>(1) Select the [Options] menu - [Memory Info] command. The receiving of memory information begins.</p> <p>(2) After confirming the displayed information, click on the <input type="button" value="OK"/> button to close the memory information window.</p> <p>[Max Block Size]Displays the LT unit's allowable memory capacity.</p> <p>[Used]Displays the data volume currently used in the LT unit.</p> <p>[Free]Displays the amount of "Free" or remaining memory.</p> <div style="border: 1px solid black; padding: 5px; margin: 10px 0;"> <p>LT Memory Information ✕</p> <table border="1" style="width: 100%; border-collapse: collapse;"> <thead> <tr> <th style="width: 30%;">Memory Bank</th> <th style="width: 40%;">Free (bytes)</th> <th style="width: 30%;"></th> </tr> </thead> <tbody> <tr><td>0</td><td>38670</td><td>▲</td></tr> <tr><td>1</td><td>59526</td><td></td></tr> <tr><td>2</td><td>59526</td><td></td></tr> <tr><td>3</td><td>59526</td><td></td></tr> <tr><td>4</td><td>59526</td><td></td></tr> <tr><td>5</td><td>59526</td><td></td></tr> <tr><td>6</td><td>59526</td><td></td></tr> <tr><td>7</td><td>59526</td><td>▼</td></tr> </tbody> </table> <p>Max Block Size: <input style="width: 100%;" type="text" value="952416"/></p> <p>Used: <input style="width: 100%;" type="text" value="20856"/></p> <p>Free: <input style="width: 100%;" type="text" value="931560"/></p> <p style="text-align: center;"> <input type="button" value="OK"/> <input style="margin-left: 50px;" type="button" value="Help"/> </p> </div> | Memory Bank | Free (bytes) | | 0 | 38670 | ▲ | 1 | 59526 | | 2 | 59526 | | 3 | 59526 | | 4 | 59526 | | 5 | 59526 | | 6 | 59526 | | 7 | 59526 | ▼ | <p>Number of banks provided in the LT is 32.</p> <p>The capacity for each bank is 59526 bytes.</p> <p>A single screen file cannot be stored in several banks.</p> <p>Therefore, the sum of the remaining memory capacity for each bank is not always equal to the transferable screen data volume.</p> |
| Memory Bank | Free (bytes) | | | | | | | | | | | | | | | | | | | | | | | | | | | |
| 0 | 38670 | ▲ | | | | | | | | | | | | | | | | | | | | | | | | | | |
| 1 | 59526 | | | | | | | | | | | | | | | | | | | | | | | | | | | |
| 2 | 59526 | | | | | | | | | | | | | | | | | | | | | | | | | | | |
| 3 | 59526 | | | | | | | | | | | | | | | | | | | | | | | | | | | |
| 4 | 59526 | | | | | | | | | | | | | | | | | | | | | | | | | | | |
| 5 | 59526 | | | | | | | | | | | | | | | | | | | | | | | | | | | |
| 6 | 59526 | | | | | | | | | | | | | | | | | | | | | | | | | | | |
| 7 | 59526 | ▼ | | | | | | | | | | | | | | | | | | | | | | | | | | |

■ LT Version Information

This feature displays the LT unit version information.

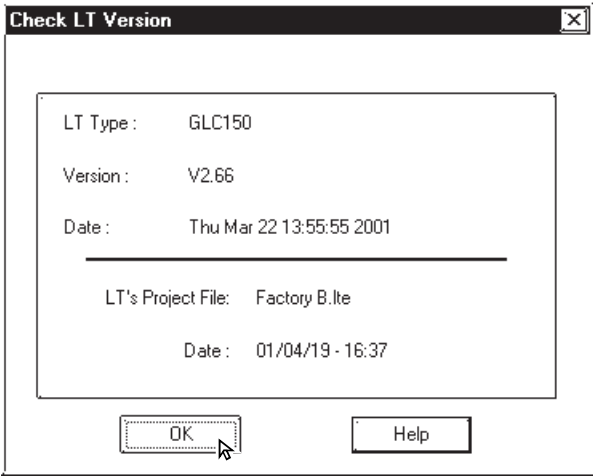
| PROCEDURE | REMARKS |
|--|---------|
| <p>(1) Select the [Options] menu - [LT Version] command. The receiving of version information begins.</p> <p>(2) After confirming the displayed information, click on the <input type="button" value="OK"/> button to close the version information window.</p>  | |

Before transferring screen data to the LT unit and connecting the LT unit to the External Device, you can check the LT panel operation by running a simulation of your LT Editor program.

This chapter describes the program simulation procedure.

8.1 Overview

8.1 Overview

Connect the LT unit to your personal computer via the transfer cable. Turn ON/OFF bits on the LT Editor program's Simulation screen, and change the data corresponding to the specified word address. This enables you to check the operation in the LT unit and the data changes resulting from the Part functions.



Note: The Simulation function can be used only when the LT is Type-C.



Important

The Simulation feature is provided for simulating External Device operations on a PC. For this is only a simulation, its performance such as processing speed may differ from the actual one which is performed when the LT unit is connected with a External Device.

Connecting method between your personal computer and the LT is the same as the one for data transfer.

Reference 7.1 Prior to Transferring Data

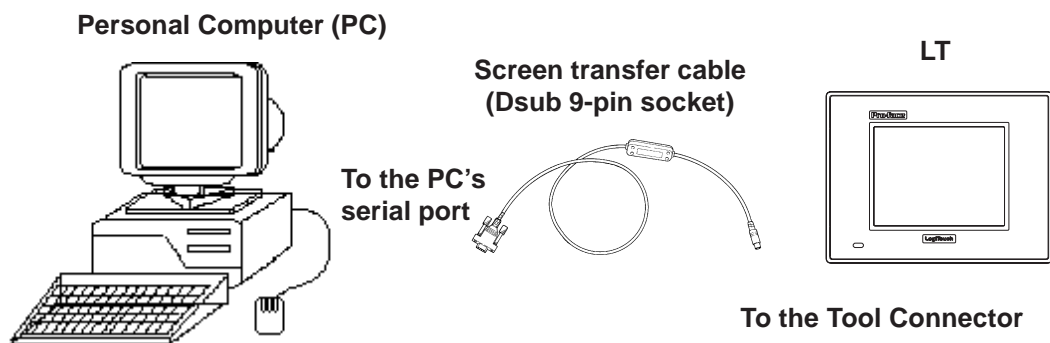

■ Precautions

When using the Simulation function keep in mind the following restrictions:

- The Simulation function can be used only when the LT is Type-C.
- When the external device is either THERMAC NEO Series (Omron) or Memory Link SIO Type", the simulation cannot be performed.
- Simulations of logic program's variables (Logic symbol) cannot be performed.
- To carry out a simulation, you need to transfer a simulation protocol at the LT set-up.

Reference 8.1.2 Transferring Simulation Protocol

- With a device specified in [LT System Setting], the simulation cannot be performed.
- If the backup function for the LS area is selected, or if a D-Script uses an LS area special relay for its start bit, no LS device can be simulated.

- If the LS device is frequently written using the D-script during the LS device simulation, actions such as a slide transition will be slow.
- DO NOT specify [LT System Settings]-[Extended Settings] tab-[Reset LT On Data Write Error].
- The screen on the LT panel cannot be changed.

8.1.1 General Description of the Simulation Screen

To perform a simulation, first transfer the screen data created with the LT Editor program and the “simulation protocol” to the LT unit.

Reference 7.2 Transferring Screens

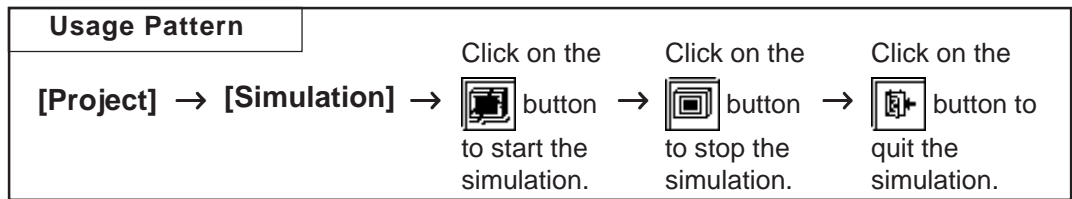

General description of the Simulation screen:

Enter the Base Screen number where device information is to be displayed

Select a function to display device information.

Displays negative values with a minus sign

Select which to screen to be displayed on the LT panel during the simulation

Selects the format of the display and input data

Starts/Stops the simulation

Register an address

Quits the simulation function

Blinks while the simulation is being executed

Displays the device information of Parts placed on each screen

Changes the device status

Changes the system status



Displays the current status of the system

| Name/Description | Function | Address | Status | Alter | No. | System Area |
|------------------|------------------------|---------|--------|-------|-----|-------------|
| W/S_001 | Word Set | D00001 | 0 | | +00 | 21 |
| W/S_002 | Word Set | D00002 | 0 | | +01 | 0 |
| BS_001 | Bit Set(Operation Bit) | X00001 | OFF | | +02 | 0 |
| BA_001 | Data Address | D00000 | 21 | | +03 | 7 |
| TR_001 | Channel 1 | D00000 | 21 | | +04 | 48 |
| BA_002 | Data Address | D00000 | 21 | | +05 | 1798 |
| BA_003 | Data Address | D00006 | 0 | | +06 | 0 |
| A_0001 | Monitor Word Address | D00000 | 21 | | +07 | 0 |
| G_0001 | Data Storage Address | D00000 | 21 | | +08 | 21 |
| W/S_003 | Word Set | D00003 | 7 | | +09 | 0 |
| BS_002 | Bit Set(Operation Bit) | X00002 | OFF | | +10 | 0 |
| BS_003 | Bit Set(Operation Bit) | X00003 | OFF | | +11 | 0 |
| | | | | | +12 | 0 |
| | | | | | +13 | 0 |
| | | | | | +14 | 0 |
| | | | | | +15 | 0 |

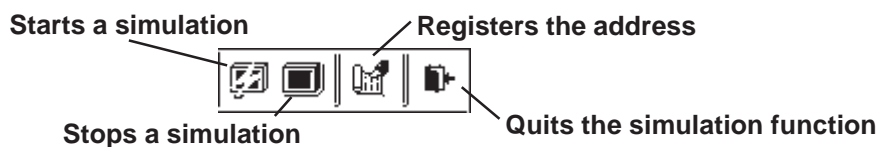
The toolbar icons have the following functions:



◆ **Chg. Scr.**

When the  Check Box is marked, the LT panel screen is changed according to the Simulation screen. When this Check Box is , the LT panel screen can be separately changed, independent of the Simulation screen.

◆ **Displayed Function Selection**

The function used to display the simulation can be changed. In addition to the settings of each screen, the devices show in the following figure that have been set with the screen-independent global functions can also be displayed.



◆ **Format**

The data format of the device status (displayed in the “Status” cell) and the device data (displayed in the “Change” cell) can be selected for “Dec” (decimal), “Hex” (hexadecimal), or “Oct” (octadecimal) format.

◆ **+/-**

Marking the “+/-” check box adds a “- (minus)” sign to the displayed values, if the word address settings displayed in the “Status” cell are negative values.

◆ **Name/Comment**

ID number of a Part or any comment is displayed. To switch the ID number or comment display mode, select [Name] of [Comment] from the [View] menu.

◆ **Function**

A general description of the device function for each specified Part is displayed.



◆ **Address**

The device specified for each Part is displayed and you can change their word address settings.

◆ **Status**

The current status of each device (bit ON/OFF status or word address setting) is displayed, and you can change their word address settings.

◆ **Alter**

You can change each device status (bit ON/OFF) or the word address settings. Every time you click on the  icon, the bit ON/OFF status is switched. When you click on the , the following Keypad will appear, enabling you to change the data.

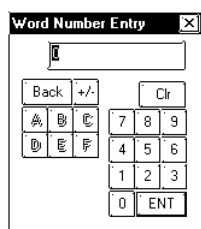

■ Selecting a Display Type

Select the types of Parts used to display device information.
Select the [Options] menu - [Display Type Settings] command.

Specify the Parts to be displayed.

When you select “All Type”, information on all Parts will be displayed.

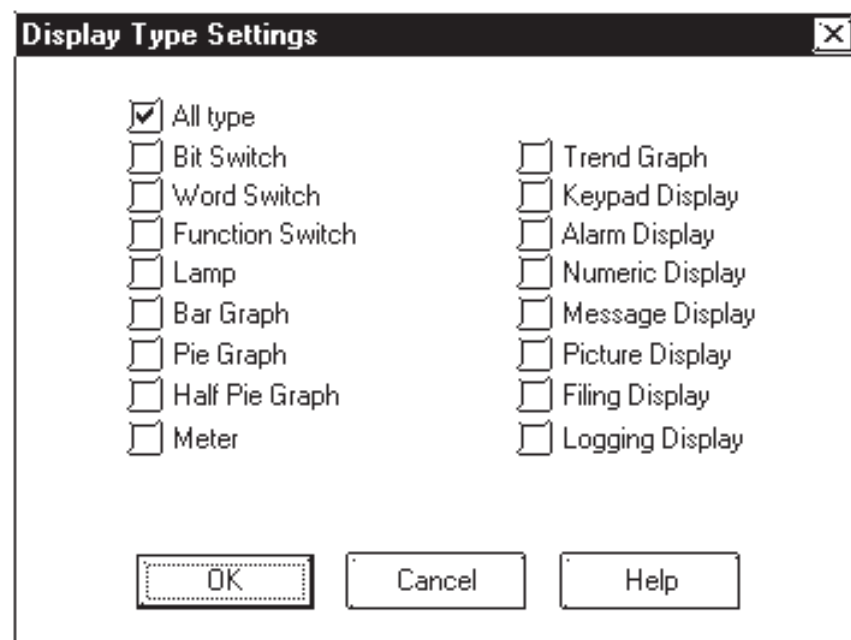

■ Setting up the Device Memory

Even after the simulation function has been closed, device information can be saved to the Project File.

Select the [Options] menu - [Device Memory Settings] command.

When the “Backup” check box is marked , device information is automatically saved when the simulation function is quit. When the simulation starts up again, the same device status will be displayed.

Clicking on the button resets all device settings to “0”.

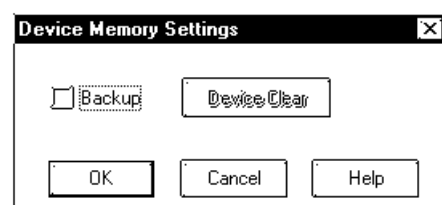

■ Movement Settings

LS devices can also be simulated in the range from LS0020 to LS2031 (excluding the read-in area). Select the [Movement Settings] command from the [Option] menu.

If the [LS Device] check box is marked, the Parts that use LS devices will be displayed when a simulation is executed.

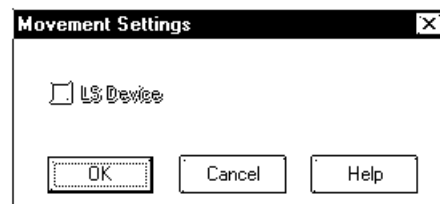

■ Address Registration

Simulation can be performed for any registered address, not for each screen or function.

The simulation result is displayed by selecting the registered address from the display function pull-down list's [Address Registration].

To register/edit an address, select the [Simulation] menu - [Address Registration] command, or click on the  icon.

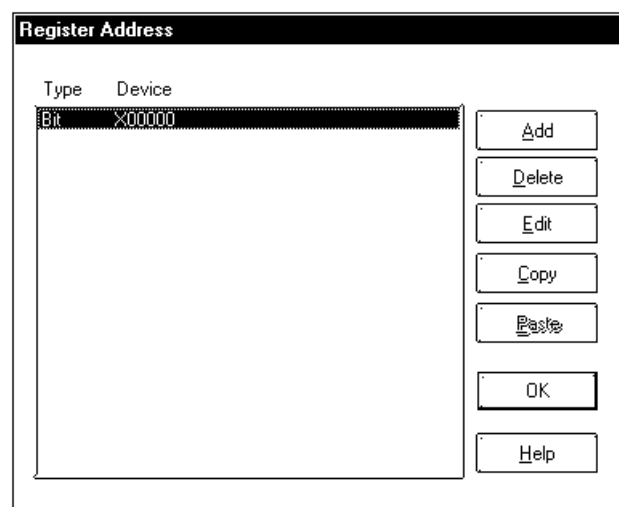

◆ Adding a registered address

You can add a new address. Click on the button, and the following dialog box will appear. Then, enter an address and the number of addresses to be added, and specify Bit or Word.

After entering a number of addresses to be added, addresses are added from the designated number in series.

You can enter a desired name as a function name with up to 20 half-sized characters.

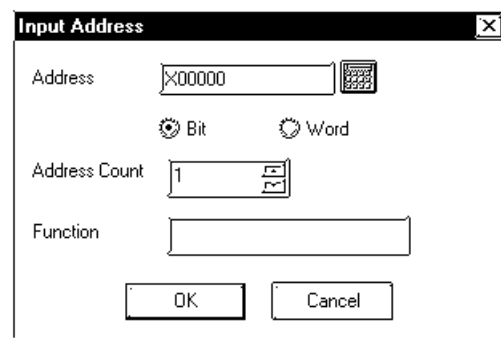

◆ Editing a registered address

You can change the registered address settings. Select an address to be edited and click on the button. Then, a dialog box that is the same as for the adding of a registered address will appear.

◆ Deleting a registered address

You can delete a registered address. Select an address to be deleted and click on the button. Then, a dialog box will appear to confirm the command. If you execute the delete command, click on the button, and if you cancel it, click on the button.

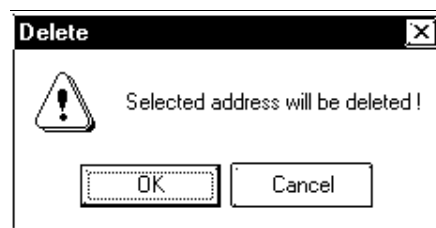

◆ Copying and pasting a registered address

Select an address to be copied and click on the button. Then, click on the button to add the copied address at the end of the list.

8.1.2 Transferring Simulation Protocol

To simulate the LT panel’s actual operation using the LT Editor program, transfer the screen data created with the LT Editor program along with the “simulation protocol” to the LT unit.

Reference 7.2 *Transferring Screens*

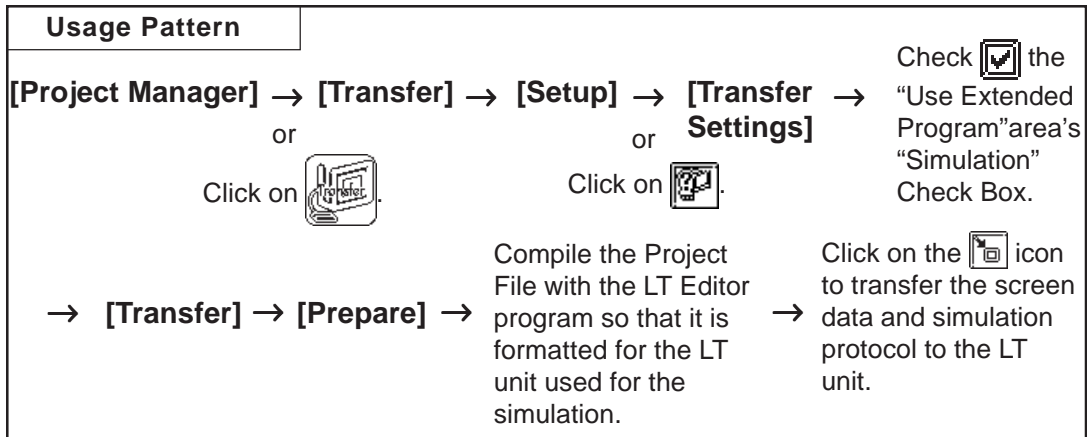

Simulation Protocol

Before executing the simulation, you must first transfer the simulation protocol to the LT unit, regardless of the External Device specified for the project file.

Check the “Use Extended Program” area’s “Simulation” Check Box in the [Transfer Settings] dialog box so that when screens are transferred, the simulation protocol will be transferred to the LT unit.

Reference 7.2.1 *Transfer Settings*



Note: When a simulation is executed, you need to transfer the simulation protocol only for the first screen transfer.

8.1.3 Performing a Simulation

To perform a simulation, first connect the LT unit to your personal computer using the Data Transfer Cable.



- **Before performing a simulation, you must transfer the simulation protocol to the LT unit.**

Reference 8.1.2 Transferring Simulation Protocol

- **Be sure not to press the touch panel switch of the LT main unit before the simulation starts. Especially, be sure not to change the screen of the LT unit. Otherwise, a system error will occur.**

PROCEDURE **REMARKS**



Connect the LT unit to your personal computer with the Data Transfer Cable.

(1) Via the Project Manager, select the [Project] menu - [Simulation] command.

(2) Click on the  button to begin communication with the LT unit.

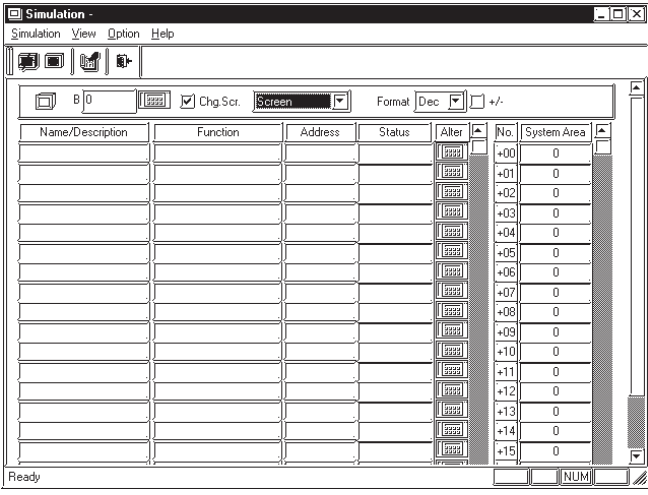
The device information on the current LT panel screen is displayed.





You can check the LT panel operation by switching screens or changing the device settings using the  or  icon displayed in the [Alter] cell. Also, you can check the device status changes via the LT's touch keys.

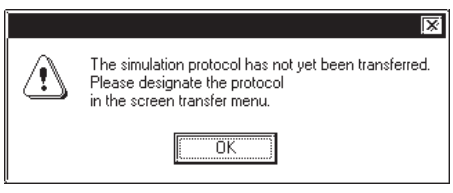

Prior to starting simulation, set the LT unit to the RUN mode.

If the simulation protocol has not been transferred to the LT unit in step (1), the following dialog box will appear, and the simulation cannot be started.



During communication, the  icon blinks, like this .

Reference 8.1.1 General Description of the Simulation Screen

| PROCEDURE | REMARKS |
|--|---|
| <p>(3) Click on the  button to quit the simulation.</p> <p>(4) Click on the  button to quit the simulation mode.</p> | <p>During simulation, screen data cannot be transferred. Click on the  icon and stop simulation before transferring screen data.</p> |

A printed copy of created screens and Part setting conditions is often useful when debugging. This chapter describes the printing procedure and print settings.

9.1 **Print Settings**

9.1 Print Settings

This section describes the procedure for printing created screens or a list of designated Parts, and options available when printing.

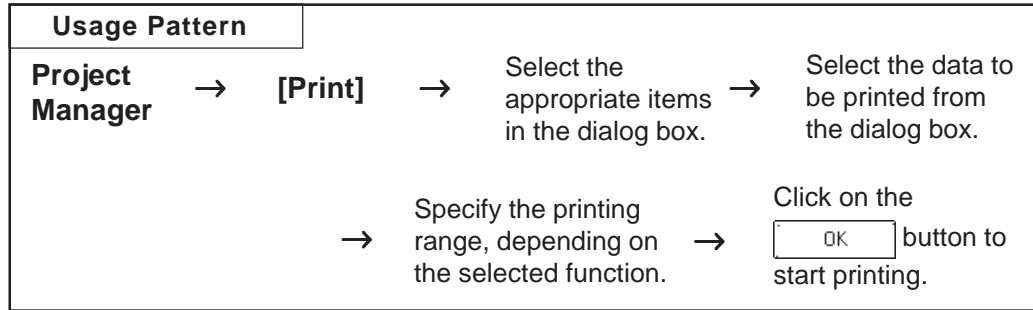

9.1.1 Printing

When you select the [Project] menu - [Print] command, the [Print] screen will be displayed.

■ Printing - [Print] Tab

Specify the printer type and other print settings on your personal computer. Only Windows-compatible printers that can be connected to your personal computer can be used to print with LT Editor for Windows.

Displays the printer name specified on your personal computer

Click on this button to display the Cover Page dialog box

Comments on the data printed can be entered to be printed out along with the data. To print comments, check this box

Displays the printing-related [Property] dialog box

If this box is checked, instead of printing a hard-copy, the data is saved as a RTF text file (*.RTF), and can be edited with other text editing software**

Enter the number of copies to be printed; the default setting is 1

Click on this button to display the [Options] dialog box

A cover page with a title, company name, date/time, name, and a bit map can be included with the document.



- Note:**
- The printing setting information can be saved by clicking on the button.
 - The printing orientation is “Vertical” (Portrait).
 - Only “A3”, “B4”, or “A4” paper can be used for printing.

◆ Cover Page Dialog Box

Check this box to print a title on the cover page

Enter a title or a company name of up to 3 lines (40 characters per line)

Check this box to include the date and time of printing on the cover page

Check this box to include a Bit-map on the cover page

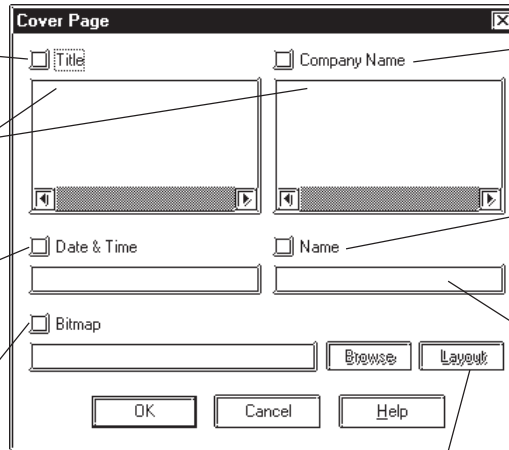

Check this box to print a company name on the cover page

Check this box to print a name on the cover page

Enter the name here

Click on this button to preview the cover page layout. When Bit-map printing is selected, the placement of the Bit-map on the cover page can be changed.

◆ Comment Information Dialog Box

Enter a comment of up to 40 lines (80 characters per line)

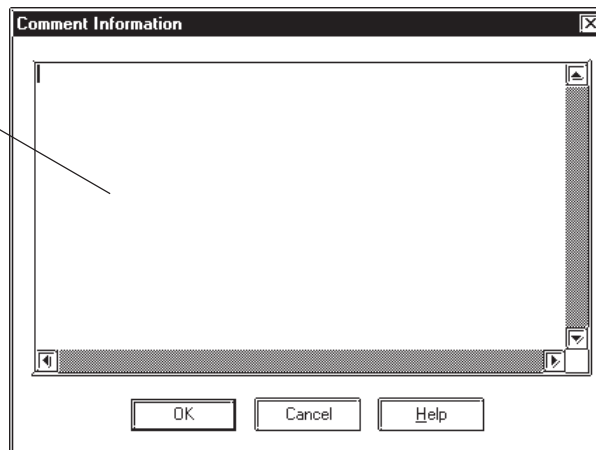

◆ Options Dialog Box

Settings in the Options dialog box allow you to format the pages of the document to be printed. You can specify the range of page numbers to be printed, the screen color, and margin size.

Prints the black/white-reversed screen color

Check this box to print the page number on each page of the document

When printing page numbers, specify if the cover page is to be numbered

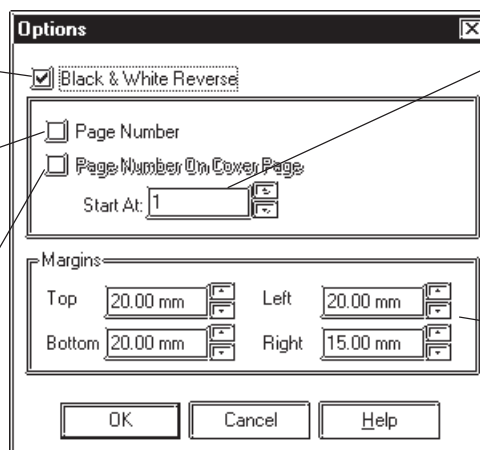

Enter the initial page number to be printed on the first page of the document

Specify the upper, lower, right and left margin sizes

■ Printing - [Project Information] Tab

You can check the created screens and Part designation status through printer output.

Prints a project information summary list

Prints the list of settings of the item marked with a check.

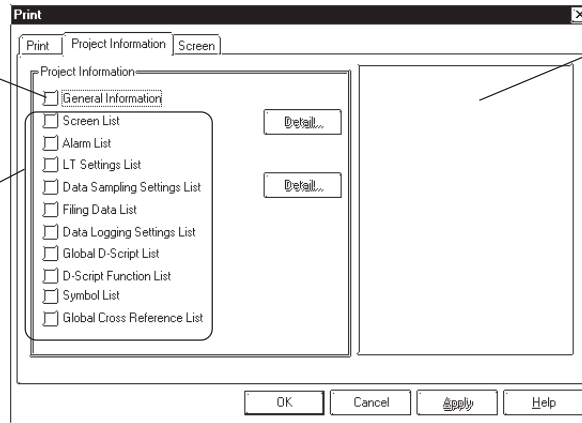

Displays the currently-selected item

◆ Details

Click on the button to specify detailed information of printing.

Screen List

Select the screen type to be printed.

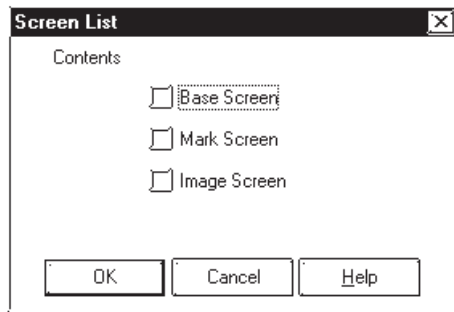

Date Sampling Settings List

Select whether to print the summary or details of the data sampling settings.

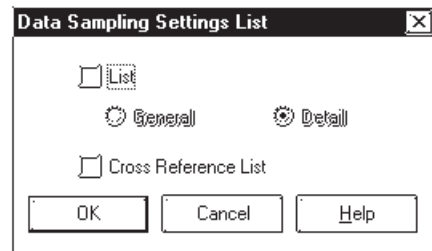

■ **Printing - [Screen] Tab**

Select the screen type and contents to be printed.

Select the screen type to be printed

Specify the printing range using individual screen numbers. When you select [All (A)], all screens will be printed.

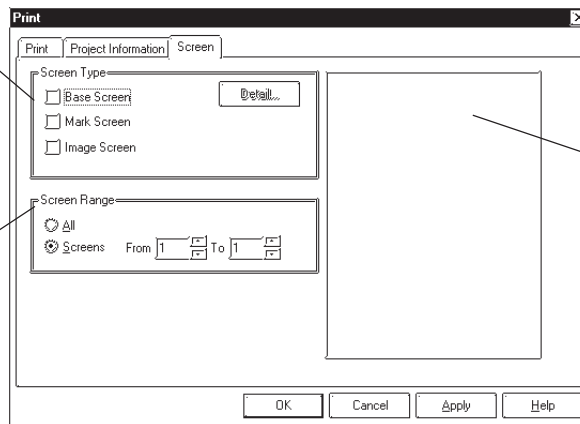

Displays the currently-selected item

◆ **Details**

Click on the button to specify detailed information of printing.

Base Screen

Specify the printing items related to a Base Screen.

Prints a list of the screens loaded onto a specified screen

Prints a list of the Parts placed on the Base Screen. Select whether to print the summary or details of the Part list

Prints the address designation for Parts. Only the "preset addresses" can be printed

Reference 2.7.7
Cross Reference/Global Cross Reference

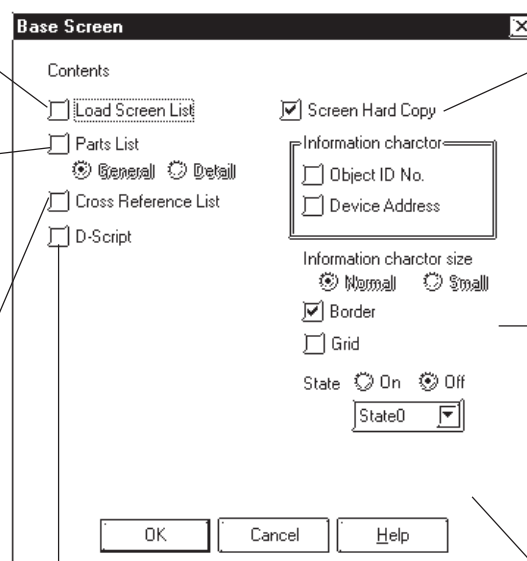

Outputs screen hard copies. The printing items can be specified

Select Information character's printing size. When selecting [Small], 1/4-sized characters are used

Prints the D-Script settings

When making a screen hard copy, The Parts' ON/OFF status can be specified. The same status is specified for all screens to be printed



Note: When the summary of the Part list is printed, its right edge may get outside the paper. In this case, open the Option dialog box by clicking on button in the [Print] tab, and then reduce the left margin.

9.1.2 Print Preview

By selecting the [Project] menu - [Print Preview], you can preview the screen image to be printed.

Setting items are the same as those of printing. Instead of clicking on the

button, click on the button.

Print Preview Screen

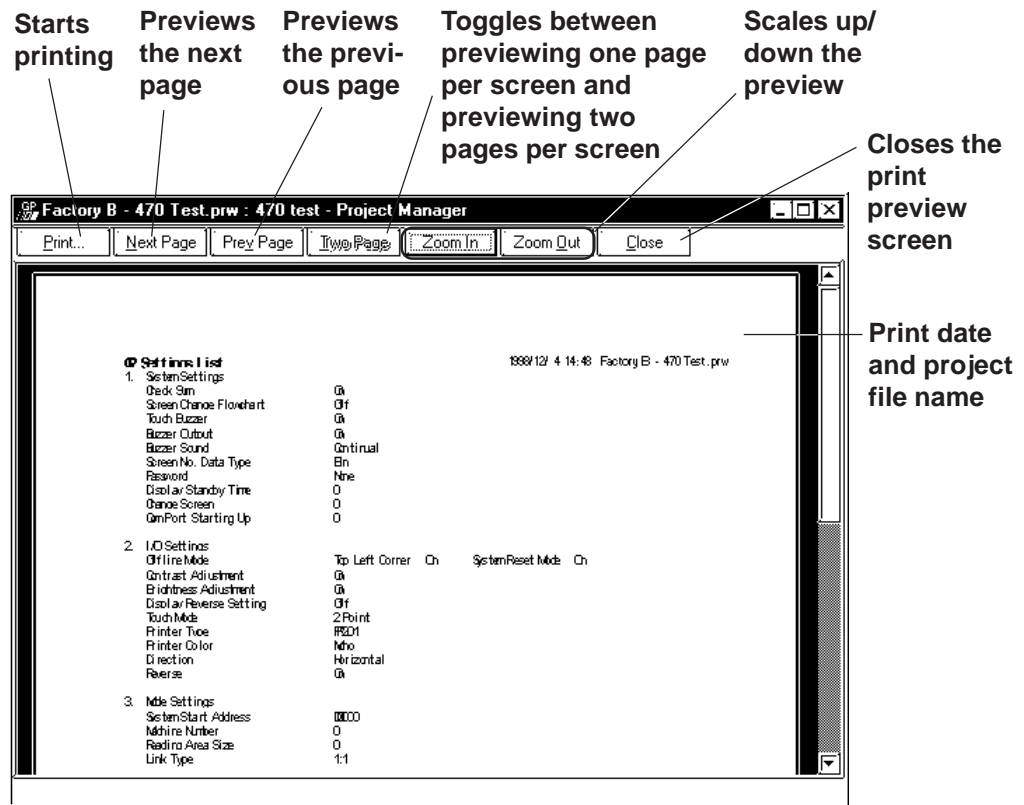

The filing data (recipe) and logging functions are advanced features that increase the performance of your LT unit.

10.1 Filing Data (Recipe) Features

10.2 Logging Feature

10.1 Filing Data (Recipe)

Setting data that you have created and stored on the LT can be easily transferred to the External Device whenever necessary, using LT touch keys or by specifying bit addresses in the External Device. Also, Filing (Recipe)Data that has been transferred to the External Device can be then sent back to the LT, edited, and then transferred again to the External Device.

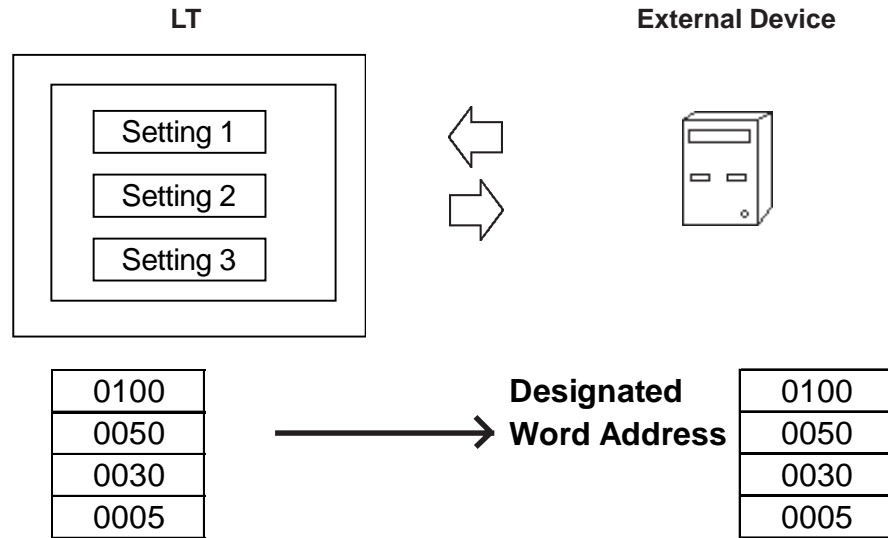

■ Overview

- There are two methods of transmitting filing data to the External Device. One is automatic transmission, where filing data is sent to the External Device via a External Device trigger. The other is manual transmission, where data selected on the LT screen is sent to the External Device.
- When using manual data transmission, select the Filing Data Display from the Tool Box or [Parts] menus.
- Filing data can be controlled by file numbers for each project file.
- Filing data can be stored in the LT’s internal memory.
- Filing data is stored in the External Device in a series of addresses.
- Setting up filing data so that it is transmitted via an LS Area allows filing data to be edited on the LT panel and then written to the External Device.

10.1.1 Filing Data (Recipe) Function

■ Filing Data Transfer Flow

Filing data is first written from the LT's internal memory, then to the LT's backup SRAM and then is transferred to the External Device, either directly or via the LS area.

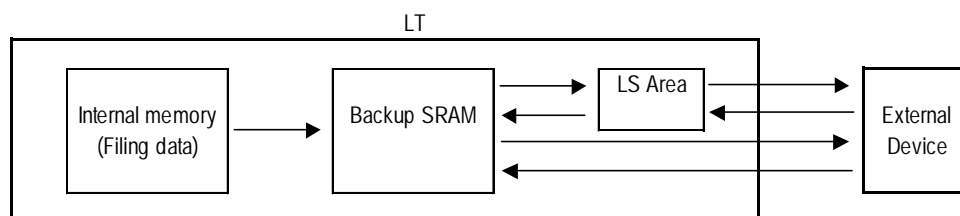

■ Managing Filing Data in Group

Filing data is organized into folders, files, blocks, and data. Also, to use as much filing data as possible, multiple folders can be used in the LT's internal memory to register multiple filing data items.

You can register multiple folders by selecting [Use Multiple Folders] from the [Filing Settings] menu.

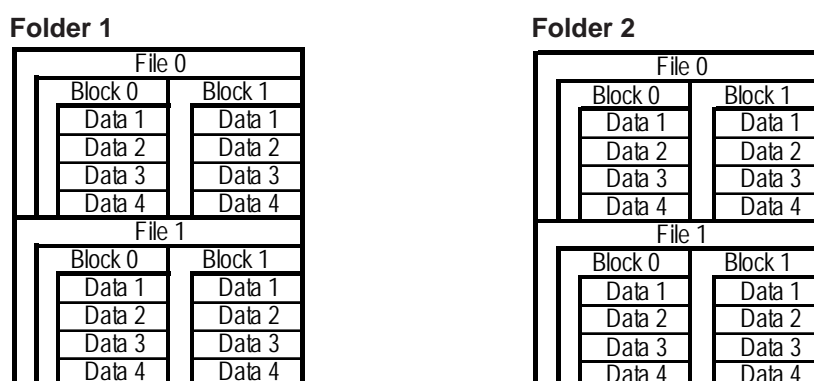

◆ When multiple folders are not used

Only 1 folder is registered. In this case, the folder number is usually not designated, however, whenever it is necessary, the number is designated as 1.

◆ When multiple folders are used

Multiple filing data folders can be registered. In the LT, the folder numbers need to be designated to transfer data to the LT's internal memory and backup SRAM. Since only one filing data folder can be used on the LT at one time, select which folder will be used.

- Multiple folders can be registered in both the LT's internal memory.
- Up to 64 folders can be registered in the LT's internal memory.
- Select a folder to be used on the LT.
- Only one folder of data can be transferred to the LT's backup SRAM.

■ **Filing Data Registration Capacity**

When saving filing data, up to 2,048 filing data files can be registered, with up to 1,650 data blocks in each file, and up to 10,000 pieces of data in each block. (However, when the data format is 32 Bits, only 5,000 data items can be registered.)

Registration capacity, however, varies depending on the use of the backup SRAM or other settings.

Up to 59520 bytes of filing data can be stored in one folder in the LT’s internal memory. (when storing only filing data to the backup SRAM).

◆ **SRAM Storage Capacity Calculation**

1 file = 96 (Fixed value) + (32 + 2 or 4 x number of data pieces) x number of data blocks

Use “2” for 16 Bit devices, and use “4” for 32 Bit device file calculation.

Total capacity of all files < 59520

The following shows Storage Capacity when using 16 Bit Device Data Format.

| No. of files | No. of data pieces | No. of data blocks | Total capacity of all files |
|--------------|--------------------|--------------------|-----------------------------|
| 1 | 2 | 1650 | 59496 |
| 1 | 640 | 45 | 59136 |
| 1 | 10000 | 2 | 40160 |

◆ **Usage priority of backup SRAM**

- 1) Data sampling
- 2) Trend graph
- 3) LS Area backup
- 4) Logging data
- 5) Filing data

SRAM Memory is used starting from item 1).

To check the LT’s available usage capacity,

▼**Reference**▲ “4.4.1 Project Information”

- **Data in backup SRAM is erased when:**
 - The LT’s memory is initialized.
 - Data is transmitted.
 - The LT system and protocol are set up.
 - LT’s self-diagnosis “Internal FEPR0M (screen area)” is performed.
- **As the number of Addresses increases, the more time is required for writing data to the External Device. Depending on the number of Addresses, it may take from 20 seconds to several minutes.**

- **When data is being written, screen displays, such as for Parts, may not be updated/refreshed or may appear slowly. Screen changes may also be performed slowly. If screens are changed at this time, screen data such as for Parts will also be read out, and data writing to the External Device will be performed at a slower than normal speed.**
 - **DO NOT perform any of the following operations at the same time.**
 - **Data transfer between the LS area and the External Device**
 - **Data transfer between SRAM and the External Device: via the File Name Display**
 - **Data transfer between SRAM and the External Device: via the Control Word Address using Transfer Settings**
- Be sure to perform data transfer after the current data transfer is completed.**
- **During the current data write, the succeeding data write operation cannot be accepted/received.**

■ **LS Area Filing Data Structure**

Designated address

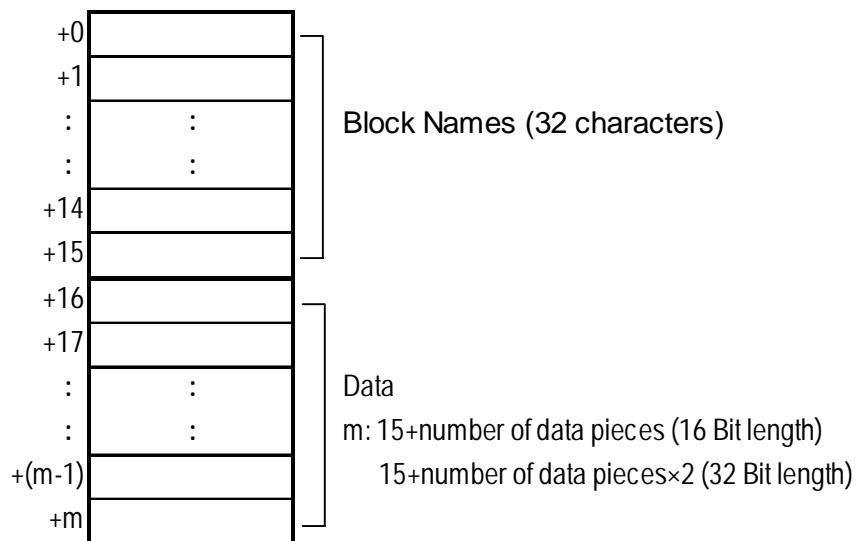

Data transmitted between the backup SRAM and LS Area will overwrite the existing Block Name and Block data.

Data transmitted from the External Device to the LS Area overwrites only file data and preserves the Block Name.

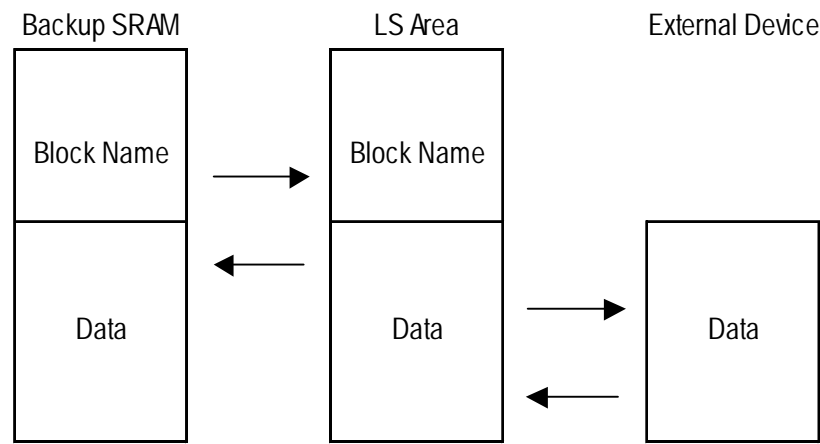

- When a device is used with a 32 Bit system start Address, filing data cannot be transmitted to the External Device via the LS Area.
- Block Name text characters are stored in order of the character input.

Reference *LogiTouch Series User's Manual 6.3.2 "Text Data Settings"*.

■ Filing Data Transmission Methods

◆ Automatic Transmission

Filing data is transmitted from the LT to the External Device via a External Device trigger. Use the Control Word Address instead of using the Filing Data Display to transfer data between the LT and the External Device (LT→External Device, External Device→LT.)

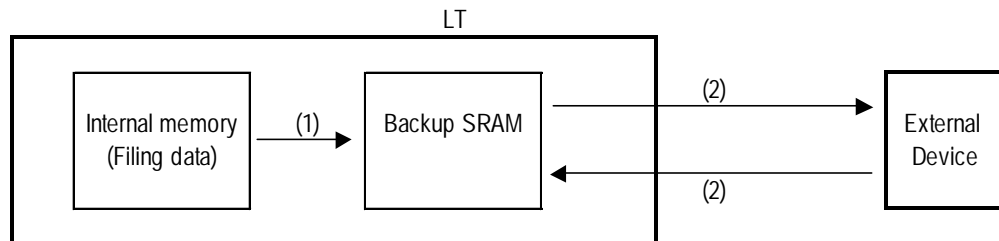

(1) External Device Trigger

Reference *"10.1.2 Filing Data Setting ◆ Control Word Address (Filing Data→SRAM)"*.

(2) External Device Trigger

Reference *"10.1.2 Filing Data Setting ◆ Control Word Address (SRAM ↔ External Device)"*.



- When a single folder is used, designate the folder number as 1.
- If the designated number's folder does not exist, data will not be transferred to backup SRAM. Also, the Write Completed Bit Address will not be turned ON.
- When data is not transferred to backup SRAM, the LT internal special relay (LS2032)'s bit 9 will turn ON.

◆ Manual Transmission - type 1

Filing data is transmitted to the External Device by touching a LT screen touch key. Use the Filing Data Display to transfer data to/from the External Device, using the “SRAM→External Device” touch key and the “External Device→SRAM” touch key.

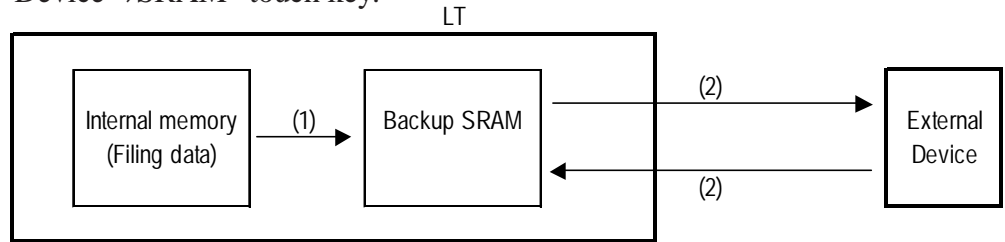

(1) External Device Trigger

▼ **Reference** “10.1.2 Filing Data Setting ◆ Control Word Address (Filing Data→SRAM)”.

(2) Screen Touch Keys

▼ **Reference** “10.1.5 Manual Filing Data Transmission Example 1/ ■ Filing Data Transmission Flow”.



Note: When filing data is sent back to the External Device from backup SRAM, the newly sent data will overwrite the old. In order to prevent this, beforehand create another data block for the return value data (See the figure below) to send the filing data to and designate that block via the Control Word Address.

| File 0 | | | |
|--------|----|----------------|----------------|
| A | B | A Return Value | B Return Value |
| 50 | 40 | 0 | 0 |
| 60 | 30 | 0 | 0 |

◆ Manual Transmission - type 2

Select the desired filing data via the screen’s touch keys, perform any data changes, and then transmit the edited data to the External Device. Use the Filing Data Display to transfer data to/from the External Device, using the “LS→External Device” touch key and the “External Device→LS” touch key.

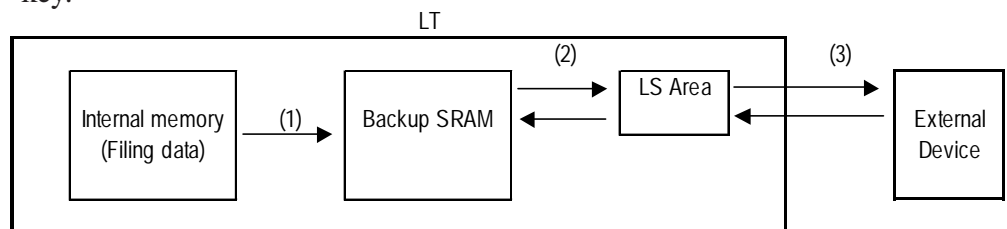

(1) External Device Trigger

▼ **Reference** “10.1.2 Filing Data Setting ◆ Control Word Address (Filing Data→SRAM)”.

(2) Screen touch keys

▼ **Reference** “10.1.6 Manual Filing Data Transmission Example 2 (1) Writing filling data to SRAM”.

(3) Screen touch keys

Reference “10.1.6 Manual Filing Data Transmission Example 2 (5) LS Area to External Device”.

■ Filing Data Setup Procedure

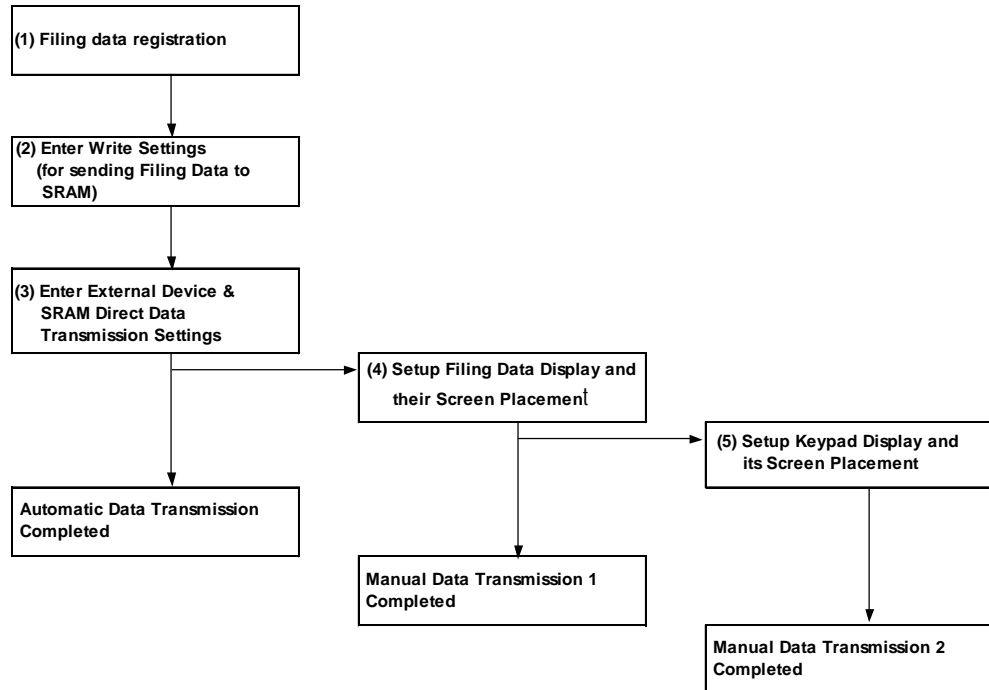

(1) Filing Data Registration via [Filing Data]/[Filing List]

(2) Setup of [Write Settings (Send Filing Data to SRAM)] via [Filing Data]/[Filing Setting]

(3) When performing automatic data transmission, setup the [External Device & SRAM Direct Data Transmission Settings] via the same dialog box.
Automatic Data Transmission is completed here.

(4) When performing manual data transmission - type 1, setup the Filing Data Display and designate its placement.
Manual Data Transmission - type 1 is completed here.

(5) When performing manual data transmission - Type 2, setup the Keypad Display and designate its placement.
Manual Data Transmission - Type 2 setting is completed here.

10.1.2 Filing Data Setting

Use the following setting items to create multiple folders and a trigger for transferring data.

Select [Filing Setting] from the [Screen/Setup] - [Filing Data] menu.

◆ Filing (ON/OFF)

Check this check box in order to use the filing data.

◆ Use Multiple Folders

Check this check box in order to register 2 or more folders.

◆ Write Settings (From Filing Data To SRAM)

In response to a trigger, filing data stored in the LT's internal memory (screen data) is written to backup SRAM. This prepares for filing data transfer. In order to transfer data to the External Device, you need to first write data to backup SRAM. Only 1 item of filing data can be written to backup SRAM.



Note: When using filing data, be sure to enter the “Write Settings” data.

◆ **Control Word Address (Filing Data → SRAM)**

Designate a Word Address to use as a trigger, or designate the mode to use when writing to backup SRAM. This trigger controls the data write timing. When using multiple filing data items, designate the folder numbers.

The Control Word Address will be as follows:

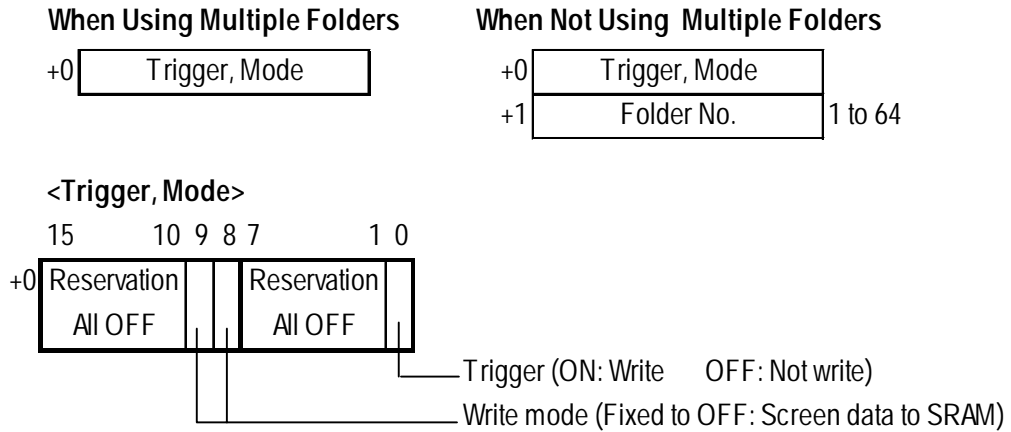

◆ **Write Completed Bit Address (Filing Data → SRAM)**

Designate a specific Bit Address to be turned ON when the data write to LT backup SRAM is completed.



Note: If data cannot be transmitted to backup SRAM due to insufficient memory, LS2032's Bit 9 will be turned ON. When data is transmitted to backup SRAM again, use either the designated communication cycle time or 150ms, whichever is longer, as the trigger's OFF time.

For communication cycle time details,

Reference *External Device Connection Manual, "1.1.4/2.1.3 Special Relays"*

| | Write Completed Bit Address | LS2032 Bit 9 |
|--------------------------|-----------------------------|--------------|
| Normal data transmission | ON | OFF |
| Data transmission error | - | ON |

◆ **External Device & SRAM Data Transmission Settings**

Here, select the method used to transmit filing data either from backup SRAM to the External Device, or from the External Device to backup SRAM. Select this setting when performing automatic data transmission using the Control Word Address feature.

◆ **External Device Controlled Transfer (SRAM ↔ External Device)**

When this check box is selected, automatic data transmission via the External Device’s trigger is set up. If this box is not checked, data must be transmitted manually using the Editor area Toolbox’s Filing Data Display.

◆ **Control Word Address (SRAM ↔ External Device)**

Designates a Word Address where the filing data transmission trigger and mode data are stored.

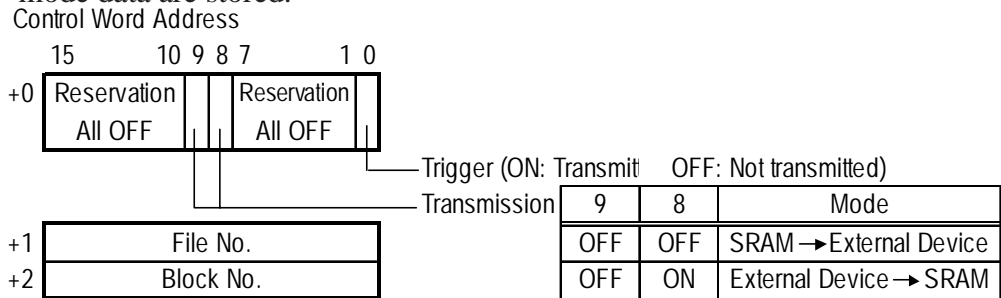

◆ **Transmit Completed Bit Address (SRAM ↔ External Device)**

Designates the Bit Address that will be turned ON when filing data transmission is completed.



- Use binary numbers to designate file and block numbers.
- If data transmission cannot be performed, LS2032’s Bit 10 is turned ON. To transmit data to the External Device, use either your standard communication cycle time or 150ms, whichever is longer, as the trigger OFF time.

For Communication cycle time details,

▼ **Reference** ▲ *External Device Connection Manual “1.1.4/2.1.3 Special Relay”*

| | Transmit Completed Bit Address | LS2032 Bit 10 |
|---------------------------------|--------------------------------|---------------|
| Normal data transmission | ON | OFF |
| Data transmission error | - | ON |

10.1.3 Filing Data List

Filing Settings can be added, edited and deleted on the [Filing Data List] screen.

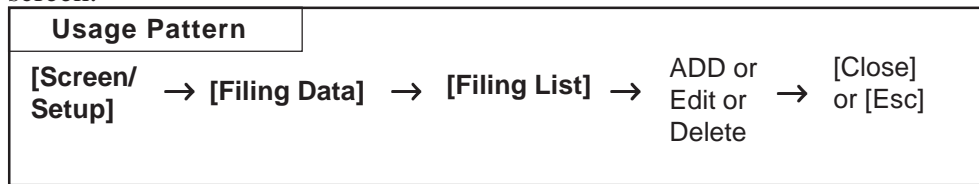

■ **Filing Data List**

Below is the overview of the screen on which you can make filing settings.

◆ **When using a single folder**

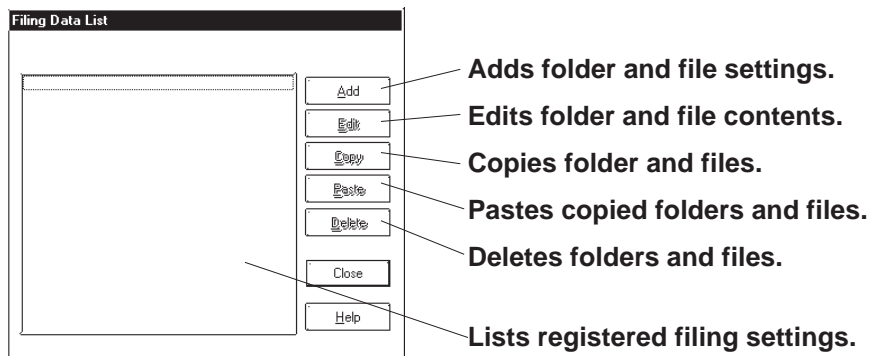

◆ **When using multiple folders**

“Internal Memory” indicates the screen data stored in the internal memory.
 “1-Filing Data” folder indicates the File Settings.

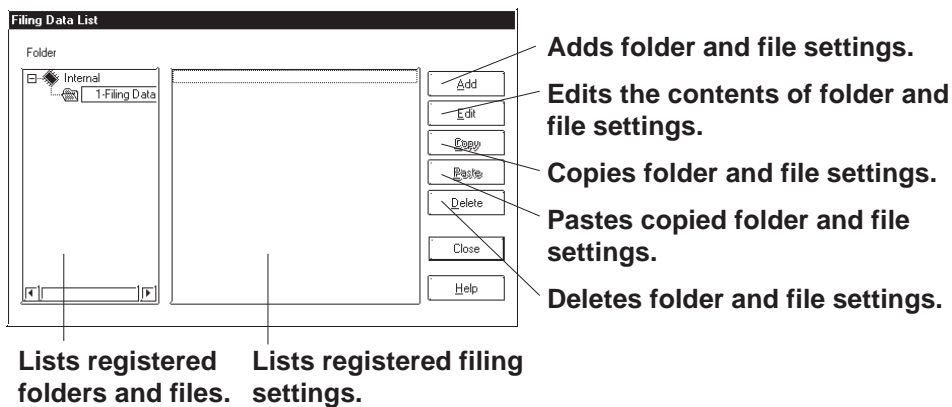

■ **Registering Filing Data**

Here, the procedure of adding Filing Data Setting is explained.

◆ Registering Folders

When multiple folders are used, select [Internal Memory] and click on **Add** to display the screen for creating a new folder.

Folder No. (= Filing data number)

A value between 1 and 64 can be set.

Folder Title

Enter a title. (Commas“,” are not allowed.)

◆ Registering Filing Data

When multiple folders are not used, the filing data setting screen is displayed. When multiple folders are used, you can display the filing data setting screen by selecting [1-filing Data] and click on the **Add** button.

| Block Name | Block0 | Block1 | Block2 |
|------------|--------|--------|--------|
| D00000 | 0 | 0 | 0 |
| D00001 | 0 | 0 | 0 |
| D00002 | 0 | 0 | 0 |
| D00003 | 0 | 0 | 0 |
| D00004 | 0 | 0 | 0 |
| D00005 | 0 | 0 | 0 |
| D00006 | 0 | 0 | 0 |
| D00007 | 0 | 0 | 0 |
| D00008 | 0 | 0 | 0 |

File No.

Filing data is controlled in individual file units. Here, designate the file numbers of filing data to be registered. Up to 2,048 files can be registered.

Data Storage Start Address

Enter the first Address where the transferred filing data is stored. Data storage areas will be saved in series, starting from the Start Address for the number of filing data items.

No. of Data Blocks

Designate the number of blocks to be registered in one file. A maximum of 1,650 blocks can be designated. (The maximum number will change depending on the number of data blocks.)

No. of Data Items

Designates the number of data items registered in one block. A maximum of 9,999 data items can be registered. (The maximum number will change depending on the number of data blocks)



When a variable (Logic Symbol) is used as a data storage start address, an integer array must be designated. For an integer array, an appropriate size required for consecutive addresses needs to be allocated.

Data Format

Select either 16 or 32 bit data.

Display Format

Select a filing data display format.

Code +/-

“- (minus)” display becomes effective when this check box is checked.

Import

Other file data (CSV format) can be imported and used as filing data.

Export

Filing data can be exported and saved in the CSV format.

<Output Example using CSV Format>

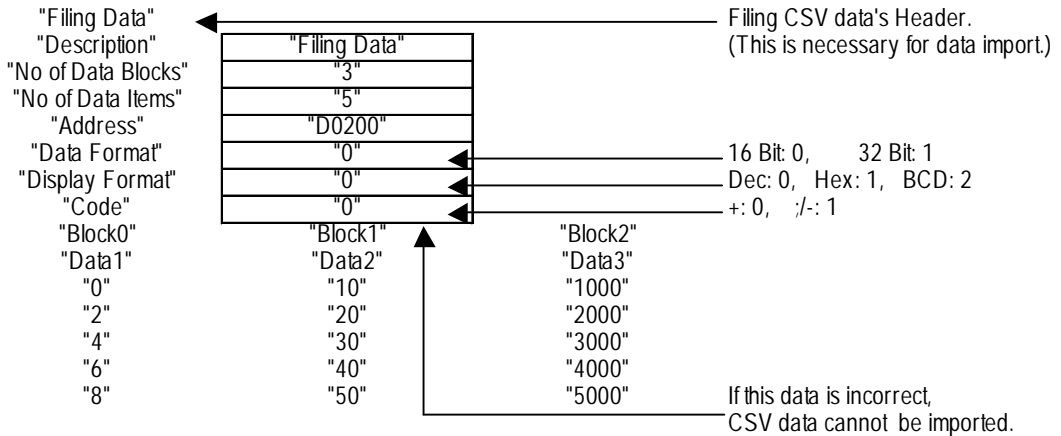

■ **Setting up Filing Data**

Entering File No., Description, No. of Data Blocks, No. of Data Items and Data Storage Start Address.

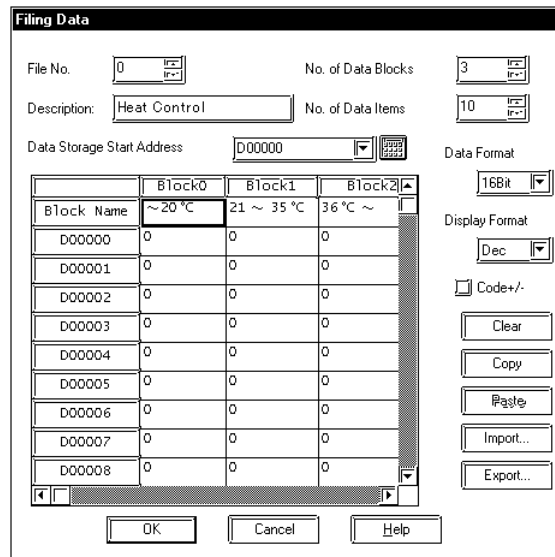

File No.: 1
Description: Heat Control
No. of Data Blocks: 3
No. of Data Items: 10
Data Storage Start Address: D00100

◆ Filing List Display

<When using multiple folders>

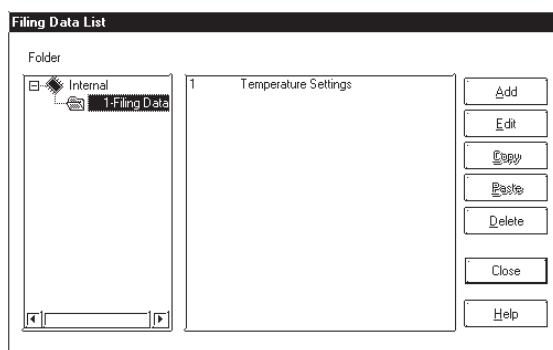

<When using a single folder>

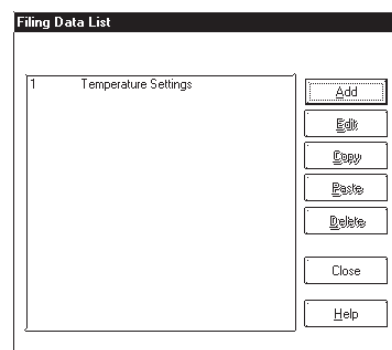

10.1.4 Automatic Filing Data Transmission

Here, data transmission via the external device's trigger (automatic data transmission) is explained.

Previously entered filing data is transmitted to the External Device as shown below.

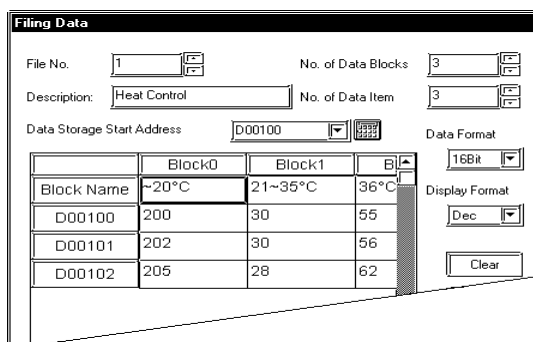

■ Data Transmission via External Device Trigger (Automatic Data Transmission)

Block 1's data is transmitted when the Control Word Address changes.

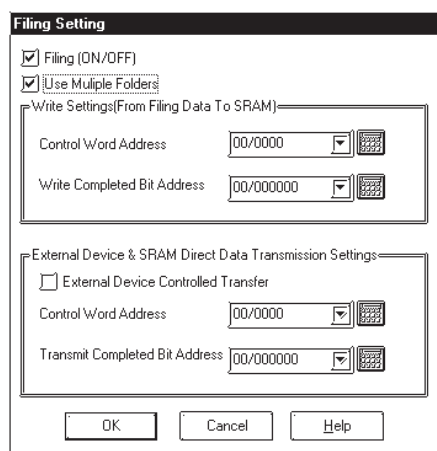

Write Settings (From Filing Data to SRAM)

Control Word Address: D00200
Write Completed Bit Address: M00001

External Device & SRAM Direct Data Transmission Settings

Control Word Address: D00201
Transmit Completed Bit Address: M00002



Note: When using multiple folders, the Control Word Addresses will be D00200 to D00201, which overlap with the following transfer setting (SRAM↔External Device) Control Word Address (D00201).

■ Filing Data Data Transfer

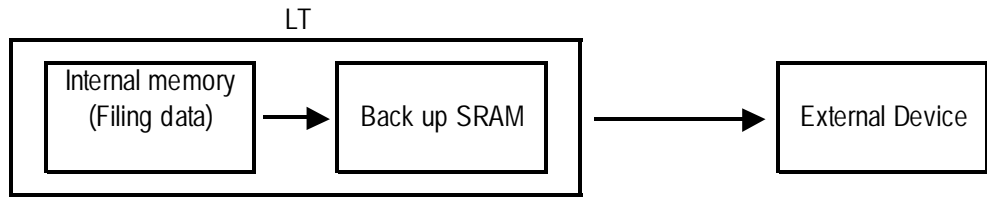

◆ Filing data → SRAM

When the “0” Bit of a data transmission’s Control Word Address (D00200) is turned ON, all the filing data is written to SRAM.

Trigger Bit Address
1 to D00200

Write Completed Bit Address
M0001

Data processing

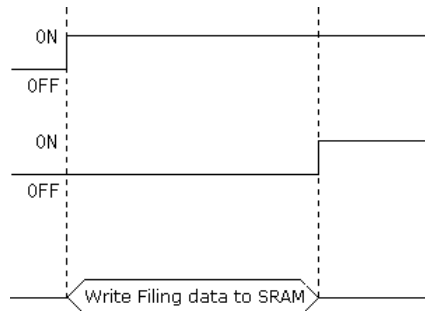

◆ SRAM → External Device

When the “0” Bit of the data transmission’s Control Word Address (D00201) is turned ON, the designated filing data is written to the External Device.

To designate filing data, prior to transferring filing data a file number is stored in D00202 and a block number is stored in D00203, directly following the Control Word Address.

Trigger Bit Address
1 to D00201

Write Completed Bit Address
M0002

Data processing

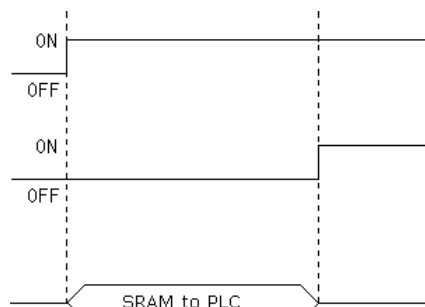

Written into PLC's D00100 to D00102

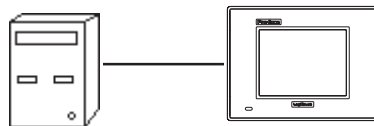

| | |
|--------|------|
| D00201 | 0001 |
| D00202 | 0001 |
| D00203 | 0001 |

Control Word Address

| File Number 1 | | |
|---------------|---------|---------|
| Block 1 | Block 2 | Block 3 |
| 200 | 30 | 55 |
| 202 | 30 | 56 |
| 205 | 28 | 62 |

| | |
|--------|-----|
| D00100 | 200 |
| D00101 | 202 |
| D00102 | 205 |

Transfer

10.1.5 Manual Filing Data Transmission Example 1

The following explains how to transfer data by selecting the desired screen setting (Manual Transmission 1).

The same filing data as in "10.1.4. Automatic Filing Data Transmission" is used.

■ Screen Example

In this example, data from File No. 1's Block No. 3 is sent by touching the LT screen.

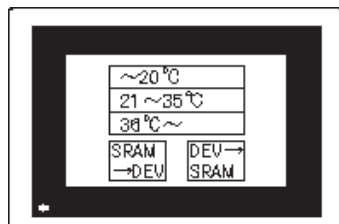

■ Filing Setting Example

When [External Device Controlled Transfer] is not checked, manual transfer is performed.

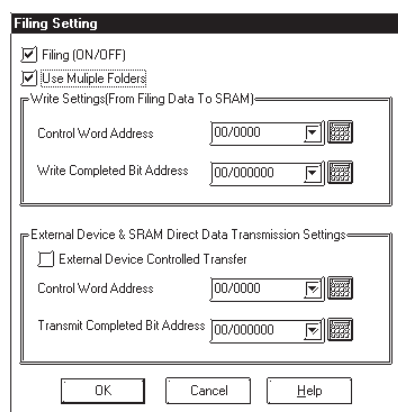

Write Setting (From Filing Data To SRAM)

Control Word Address: D00200

Write Completed Bit Address: M00001

External Device & SRAM Direct Data Transmission Setting

External Device Controlled Transfer:
Not selected

■ Filing Data Display Settings

When manual data transmission is performed, you must place the Filing Name Display.

▼ **Reference** ▲ *2.1.12 Filing Name Display*

◆ General Settings

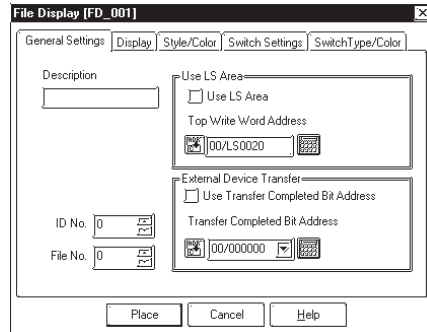

Description: Heat Control

Use LS Area

Use LS Area: Not selected

Since, in this example, data is transmitted from SRAM to the External Device, it is not transmitted via the LS Area. Keep the default setting.

Top Write Word Address: Not selected

Not designated. Since this example does not use the LS area, this Address does not need to be designated. When using the LS area, designate the Top Address of the LS area where data is stored.

External Device Transfer

Use Transfer Completed Bit Address: Not selected

The example does not turn the External Device Transfer Completed Bit Address ON when the data transfer is completed between the LS area and External Device, and SRAM and External Device. (No information is sent when data transfer is completed.)

When using the Transfer Completed Bit Address, after the Bit ON condition is detected, turn the corresponding Bit OFF on the External Device. Also, when the Transfer Completed Bit Address is used, the special relay (LS2032)'s bit 10 will turn ON when data transfer is not completed normally, between the External Device and LS area, or between the External Device and SRAM.

▼ **Reference** ▲ *External Device Connection Manual; Chapter 1*

External Device Transfer Completed Bit Address: Not designated

Since this example does not use the Transfer Completed Bit Address, this Address does not need to be designated. When using the Transfer Completed Bit Address, designate an Address that will be turned ON when data transfer is completed.

ID No.: 0

In this example, where only one Filing Data Display is placed, the ID No. does not need to be entered. Keep the default setting. When placing two or more Filing Data Displays on the currently displayed screen, be sure not to use the same ID No. for multiple Filing Data Displays.

File No.: 1

Enter the previously entered filing data number.

◆ **Display**

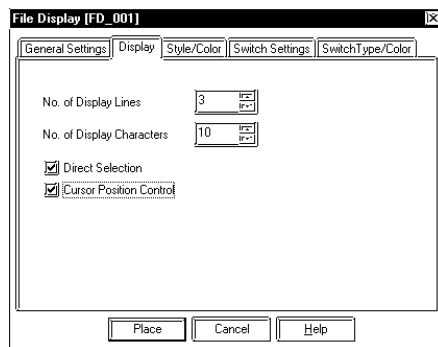

No. of Display Lines: 3

No. of Display Characters: 10

Direct Selection: Selected

Cursor Position Control: Selected

<**Cursor Position Control**>

- Even when the screens are changed on the LT monitor, the current File Name Display’s cursor position can be preserved.
- Cursor Position Control can be designated when setting up the File Name Display.
- When the LT’s main power is turned ON or the LT is reset, the cursor will appear on the first line.
- The cursor position will be stored for each ID No. (The storage area of an ID No. and its cursor position correspond to each other.) To retain the cursor position, be sure that the File Name Display ID Nos. do not overlap each other on any of the screens. For more detailed information about the File Name Display,

Reference *Operation Manual; 2.1.12 “File Name Display”*

◆ **Style/Color**

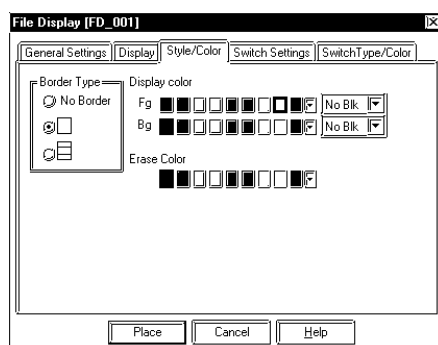

Border Type: Outer and inner borders
Display Color: Select desired colors.

Select the desired colors for Fg (foreground), Bg (background), and Blk (blink).

Erase Color: Select the desired color.

Select the display area color to use when a Filing Data Display is cleared. When using a monochrome LT, select “Black”.

◆ Switch Settings

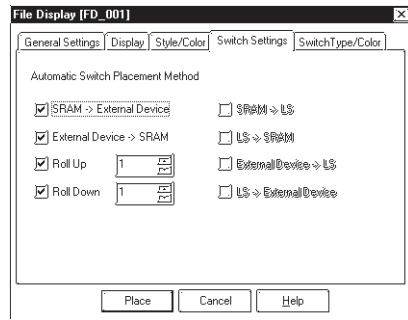

Send To External Device From SRAM: Selected
Send To SRAM From External Device: Selected
Roll Up: Not selected
Roll Down: Not selected
Send To LS From SRAM: Not selected
Send To SRAM From LS: Not selected
Send To LS From External Device: Not selected
Sending To External Device From LS: Not selected

◆ Switch Type/Color

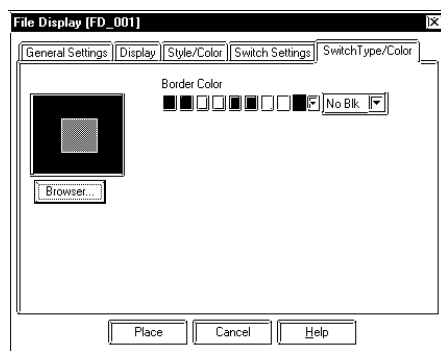

Border Color: Select the desired color.
 Select the desired color for the Filing Name Display's border.

■ Place

Click on the [Place] button to display the Filing Name Display. If desired, change the Part's size via its sizing handles.

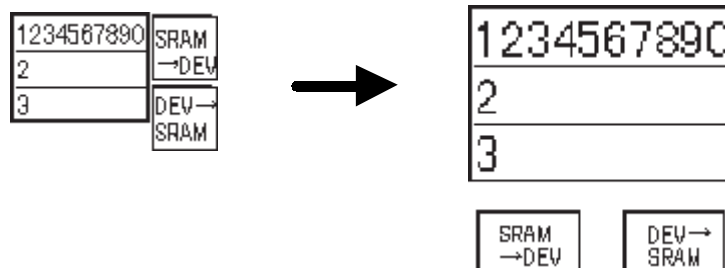

Note: To change the Filing Name Display's layout or attributes, first ungroup it.

■ Filing Data Transmission Flow

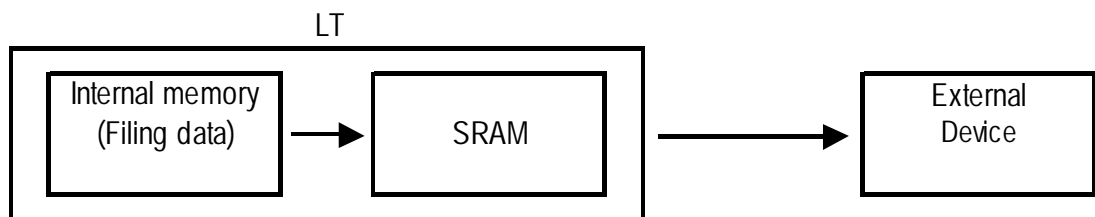

◆ **Filing Data to SRAM**

All the filing data is written into the SRAM when the Trigger Bit is turned ON.

Control Word Address
1 to D00200

Write Completed Bit Address
M0001

Data processing

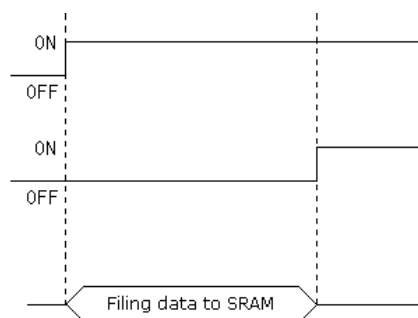

◆ **SRAM → External Device**

Filing data selected by the LT's touch key is written to the External Device.

◆ **Actual Process**

1) **Select an item. (Here, select Block 3 “36°C -”.)**

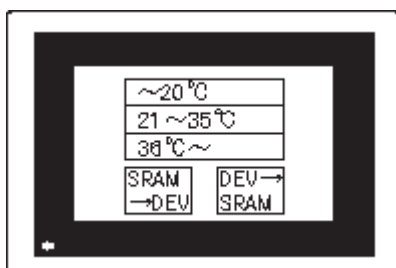

2) **Touch “SRAM → External Device” key.**

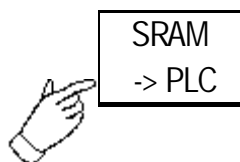

3) **Filing data is transmitted from SRAM to the External Device.**

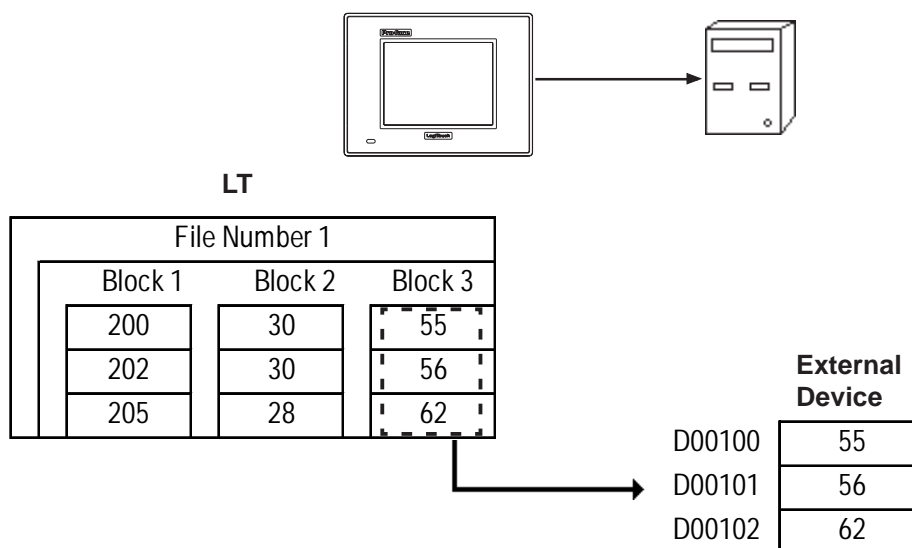

10.1.6 Manual Filing Data Transmission Example 2

Here, select an item using the File Name Display from a screen and fine-tune (minutely adjust) the data via the LS area, and then transfer the data (manual transfer: 2).

Screen Example

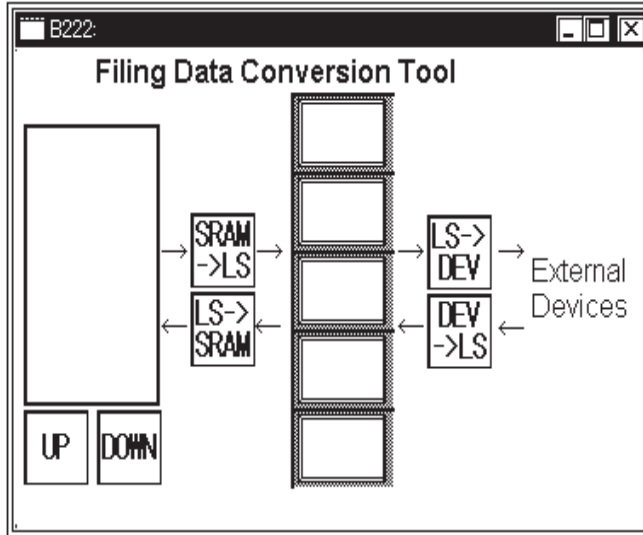

Filing Setting Example

When the check box of [External Device Controlled Transfer] is off, manual data transmission is performed.

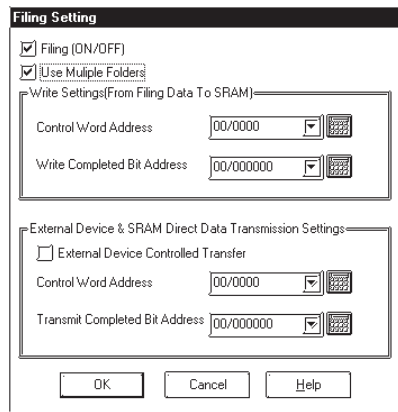

Write Setting (From Filing Data To SRAM)

Control Word Address: D00200
Write Completed Bit Address: M00001

External Device & SRAM Direct Data Transmission Setting

External Device Controlled Transfer:
Not selected

■ Filing Name Display Settings

When manual data transmission is performed, you must place the Filing Name Display.

Reference [2.1.12 Filing Name Display](#)

◆ General Settings

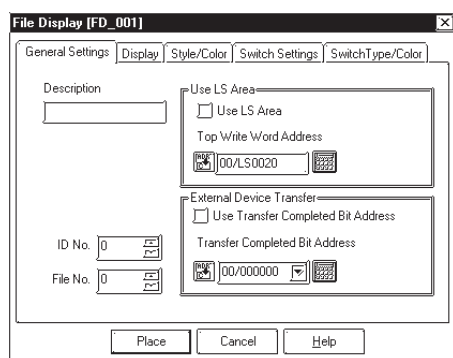

Description: Heat Control

Use LS Area

Use LS Area: Selected

Filing data is first transferred to the LT's LS area before being transferred to the External Device.

While filing data is being transferred from SRAM to LS, and LS to SRAM, the LT internal special relay (LS2032)'s bit 11 will be turned ON.

External Device Transfer

Use Transfer Completed Bit Address: Not Selected

Enables/disables the Transfer Completed Bit setting.

ID No.: 0

In this example, where only one Filing Name Display is placed, the ID No. does not need to be entered. Keep the default setting. When placing two or more Filing Name Displays on the currently displayed screen, be sure not to use the same ID No. for multiple Filing Name Displays.

File No.: 1

Enter the previously entered filing data number.

◆ Display

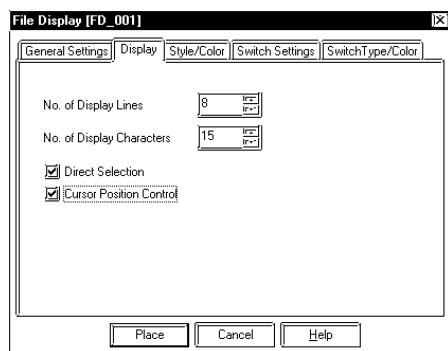

No. of Display Lines: 8

No. of Display Characters: 15

Direct Selection: Selected

Cursor Position Control: Selected

◆ **Cursor Position Control**

- Even when the screens are changed on the LT monitor, the current File Name Display’s cursor position can be retained.
- Cursor Position Control can be designated when setting up the File Name Display.
- When turning the LT’s main power switch ON or resetting the LT, the cursor will appear on the first line.
- The cursor position will be stored for each ID No. (The storage area of an ID No. and a cursor position are in correspondence with each other.) To retain the cursor position, be sure that the File Name Display ID Nos. do not overlap each other on any of the screens. For more detailed information about the File Name Display,

Reference *Operation Manual ; 2.1.12 “File Name Display”*

◆ **Switch Settings**

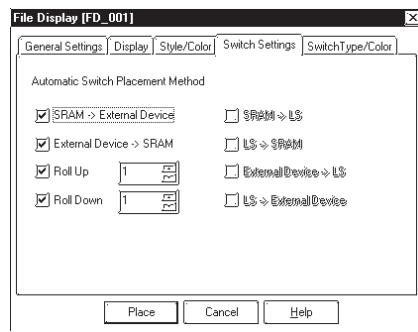

- Send To External Device From SRAM: Not Selected**
- Send To SRAM From External Device: Not Selected**
- Roll Up: Selected**
- Roll Down: Selected**
- Send To LS From SRAM: Selected**
- Send To SRAM From LS: Selected**
- Send To LS From External Device: Selected**
- Sending To External Device From LS: Selected**

■ Place

Click on the Place button to display the Filing Name Data Display. Change the size of placed Part, if desired. Settings Display must be placed to correspond with the storing address of the filing data.

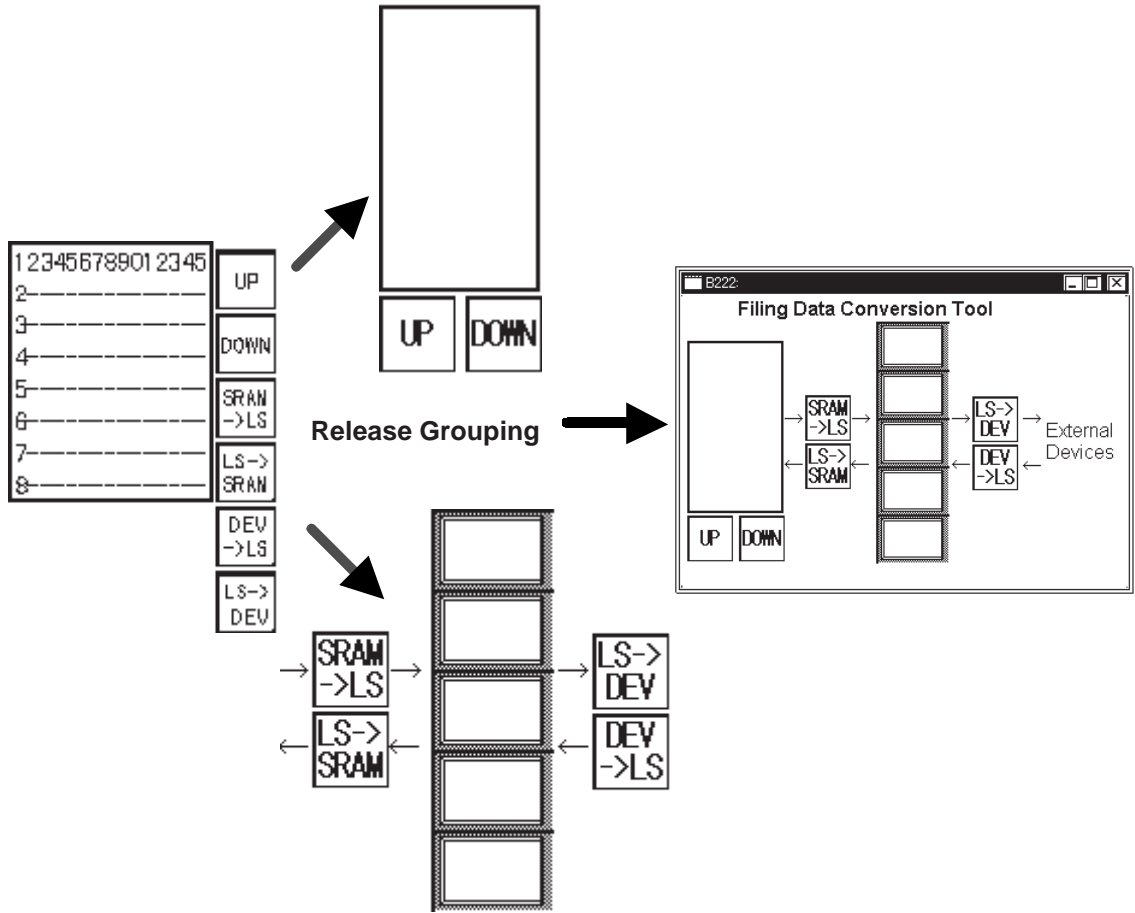

Note: To change the Filing Name Display's layout or attributes, first ungroup it.

1) Writing filing data to SRAM

All filing data is written to SRAM when the Trigger Bit is turned ON.

Trigger Bit Address
D00200001

Write Completed Bit Address
M0001

Data processing

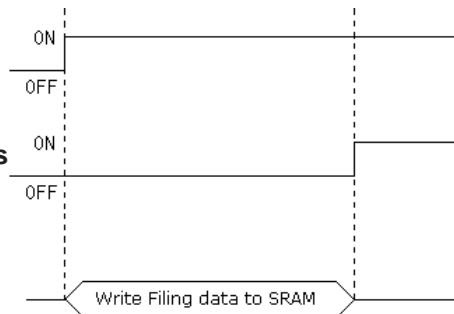

2) Selecting a file name

Select the desired setting by touching Block 2's LT screen data.

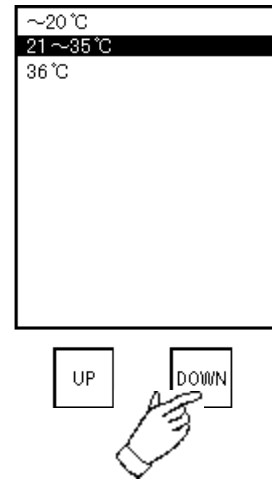

3) Backup SRAM → LS Area

Touching the “SRAM → LS” key will transmit data from SRAM to the LS Area.

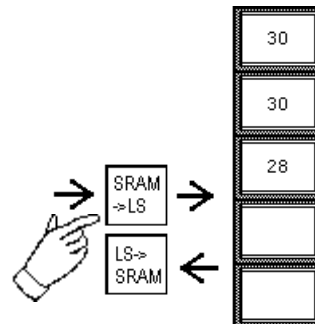

4) Data Editing

Touch the Keypad Display to display the Pop-up Keypad. Adjust the data using the Pop-up Keypad.

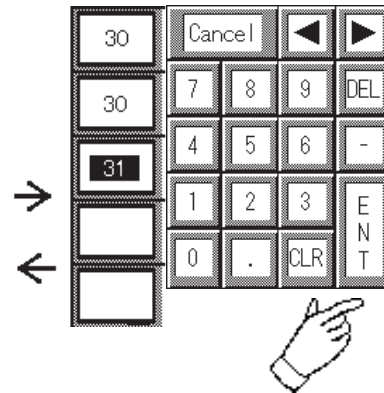

5) LS Area to External Device

The edited data is transmitted to the External Device by touching the LS to External Device key.

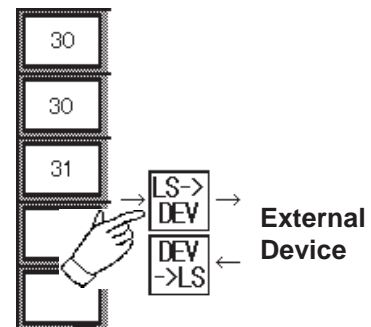

10.2 Logging Function

The External Device data is loaded to the LT's backup SRAM at bit-based or time-specified timings to display it in a tabular form on the screen or print it on the printer.

Logging data can be displayed via a Logging Display.

▼Reference▲ 2.1.13 “Logging Display”

Logging data can be displayed with its Total, Average, Max., and Min. values, which can be set via the Data Calculation Settings.

Logging data can be entered into a database for data analysis.

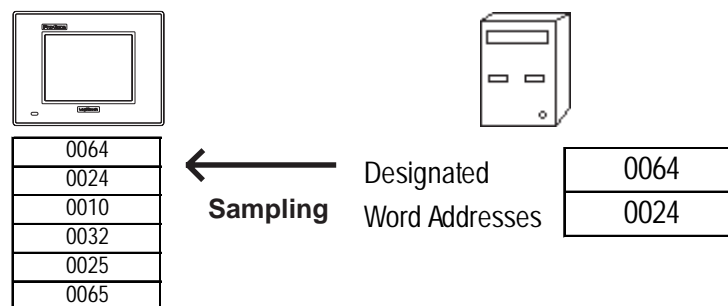

10.2.1 Logging Function

■ Data Logging Flow

This flow chart shows the logging data flow and each trigger condition.

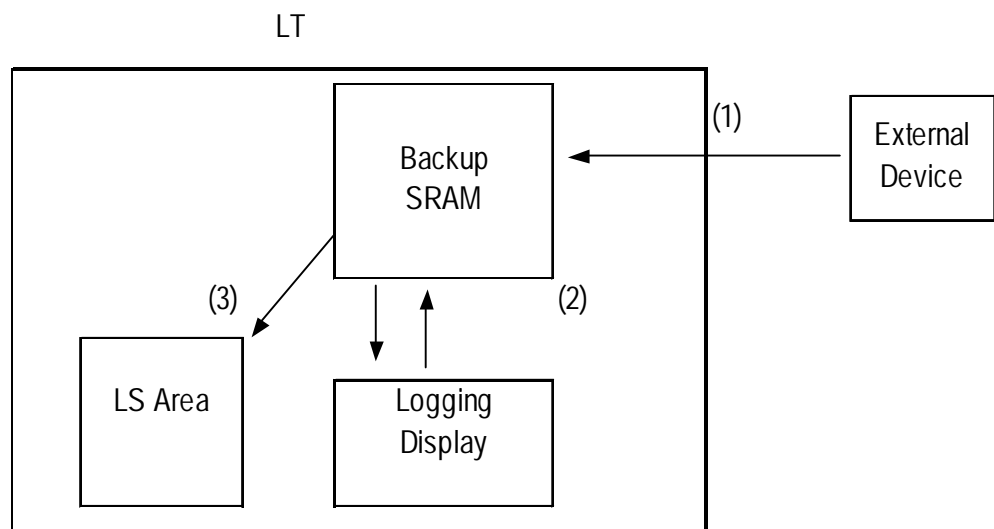

(1) Logging by the External Device Trigger Bit Address or at designated timing

▼Reference▲ 10.2.3 “Data Logging Settings/Trigger Settings”

(2) Data display and edit via the Logging Display

▼Reference▲ 10.2.4 “Display Settings”

(3) Data transmission to LS Area via the Control Word Address

▼Reference▲ 10.2.3 “Data Logging Settings”

■ Managing Groups of Logging Data

Logging data is grouped into files and blocks.

Up to 32 words can be logged in one time. These logged words are called “data”.

A group of data is called a “block” and a group of blocks are called a “file”. Be aware that the number of pieces of data in each block is considered to be the same.

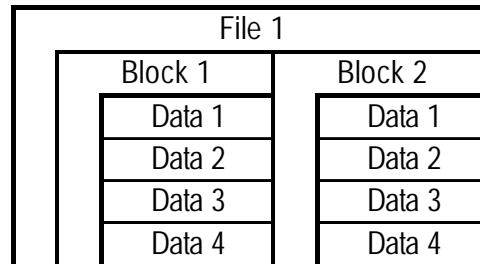

■ Backup SRAM's capacity

Backup SRAM's capacity is limited (Approximately 95KB) and all blocks and records set up must be within these limits.

The capacity of Backup SRAM to be used for logging setting is calculated by the following formulas. The formula varies depending on whether loop operation is performed or not.

▼ Reference ▲ 10.2.1 Logging Function ■ Loop Operation

◆ Without Loop Operation

Used backup SRAM capacity (byte)

$$= 128 + 20 + \{(12 + 2 \times \text{Number of logging data pieces}^{*1}) \times \text{Frequency of data logging}\} \times \text{Number of blocks}$$

◆ With Loop Operation

Used backup SRAM capacity (byte)

$$= 128 + 20 + \{(12 + 2 \times \text{Number of logging data pieces}^{*1}) \times \text{Frequency of data logging}\} \times \text{Number of blocks} + (12 + 2 \times \text{Number of logging data pieces})$$

For example, when loop operation is not selected, the number of block is 1, and the number of logging is 2048, the capacity available is approximately 32 KB, assuming that the logging data consists of 2 words. If the number of pieces of data is 32 (the maximum) the memory required becomes approximately 153 KB, which is too high.

*1 Regardless whether loop operation is designated or not, when the number of logging data items is an odd number, add 1 to the above calculation. For example, when the number of logging data items is 7, it is considered as 8 Words.

◆ Backup SRAM usage priority order

- 1) Data sampling
- 2) Trend graph
- 3) LS Area backup
- 4) Logging data
- 5) Filing data

Memory area is used starting from 1).

To check the amount of memory available,

▼ **Reference** ◀ *Operation Manual, 4.4.1 “Project Information”*

Data stored in backup SRAM is erased at the following times:



- **When initializing LT memory**
- **When transmitting screen data from your PC to the LT.**
- **When setting up the LT system and protocol**
- **When performing LT’s self-diagnosis “Internal FEPROM (screen area)”**

■ Loop Operation

Loop operation can be designated in logging mode. With loop operation selected, when data logging capacity becomes full, logging data will repeatedly be overwritten from the 1st (top) data area (loop operation). Also, the LT’s backup SRAM (storage area) becomes one large storage area that has a linked, buffer-like structure.

<Without Loop Operation>

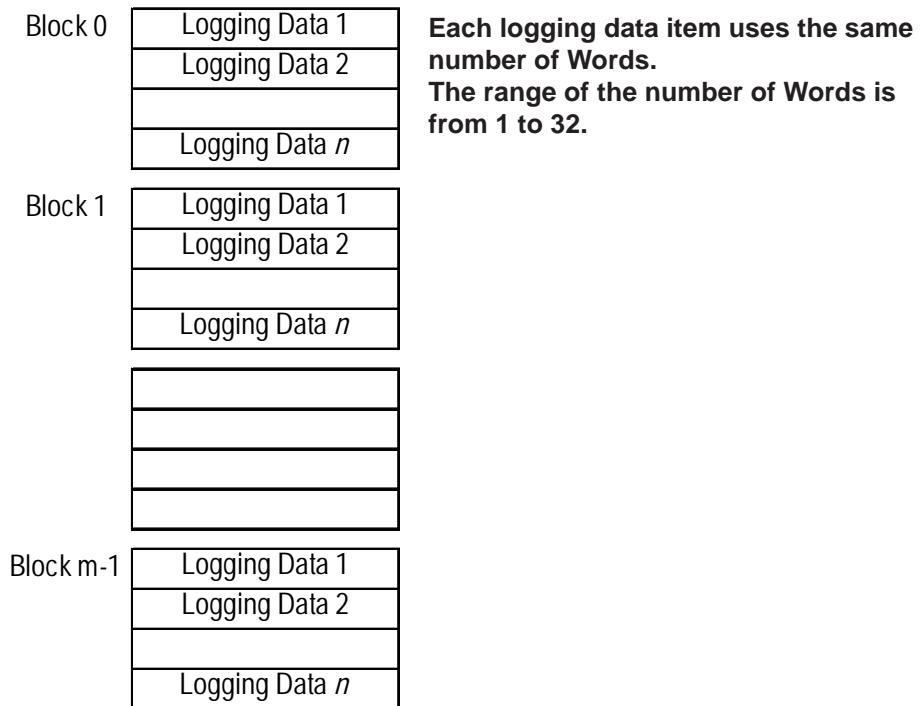

- **When data logging is performed for the designated number of blocks, the LT will turn the File Full Bit Address ON and data logging will stop.**
- **To resume data logging, turn the Data Clear Bit Address ON from the External Device. The LT then clears all logging data and will start data logging from the beginning.**

◆ With Loop operation

When data logging is performed to the end of a loop cycle, data logging repeats from the beginning, and overwrites the existing data.

Only one block is used, which has a linked, buffer-like structure. and is similar to the link buffer.

After data logging is completed (and control jumps from the end of the block to the beginning), the LT will turn the File Full Bit Address ON. Turning this Address ON simply indicates that data logging has been performed from the beginning to the end one time and that data logging will continue.

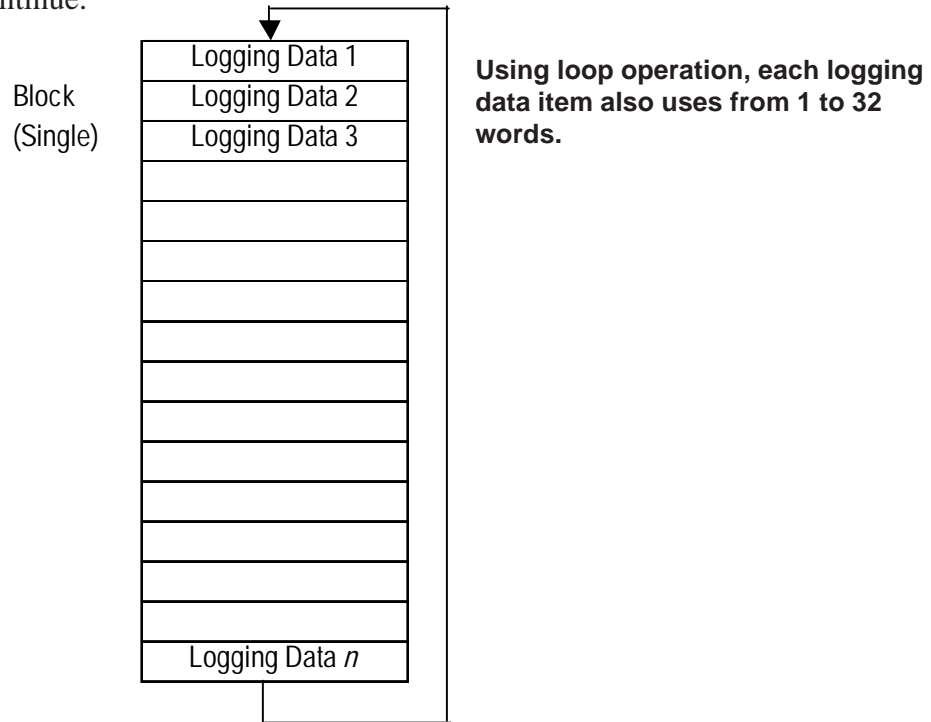

- **After the External Device detects the File Full Bit's turning ON, turn the Bit OFF.**
- **When the Data Clear Bit Address turns ON from the External Device, the LT clears logging data and repeats data logging from the beginning. When logging data is cleared, the LT turns the Data Clear Bit Address OFF.**

10.2.2 Logging Data Read Timing



- Note:**
- All the charts shown above are the basic image of LT's logging data read timing. They do not show the exact time intervals of logging data read.
 - If a communication error occurs during logging data read, "***" is displayed on the Logging Display, representing that there is no data.

■ When designating a Bit Address

Logging data is read only one time for each trigger.

When designating a Bit, logging data is read out if the External Device Trigger Bit has been turned ON when the main power is turned ON.

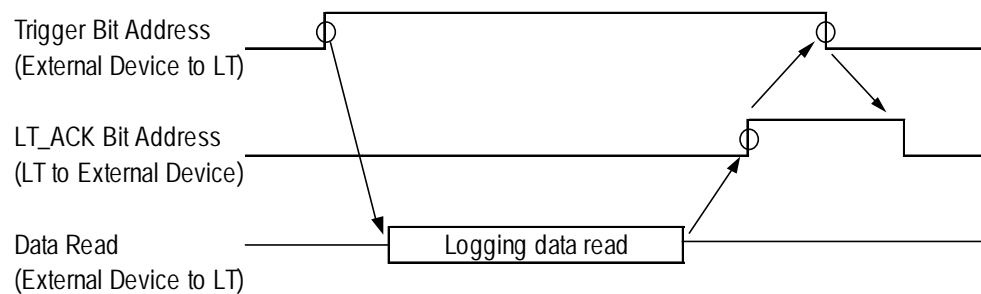

- 1) Data is set to the External Device Word Address.
- 2) The External Device Trigger Bit Address is turned ON.
- 3) The logging data is read out (one time).
- 4) The LT_ACK Bit Address is turned ON.
- 5) External Device detects the LT_ACK Bit Address is turned ON and the External Device Trigger Bit Address is turned OFF.
- 6) LT detects the External Device Trigger Bit Address is turned OFF and the LT_ACK Bit Address is turned OFF.
- 7) The External Device confirms that the LT_ACK Bit Address is turned OFF.

Prior to performing steps 1) and 2) with the External Device, be sure to confirm that the LT_ACK Bit Address has been turned OFF. Also, assuming that the main power may be turned OFF for some reason, be sure to take appropriate countermeasures such as turning the External Device Trigger Bit and LT_ACK Bit OFF when starting operation.

■ **When designating time**

Logging data is read only one time at the designated timing. When designating time without using loop operation, a Block's Finish Bit Address is turned ON when a block's data logging is completed, in order to start data read at the read start time. Logging data in the External Device Word Address is cleared by the external device.

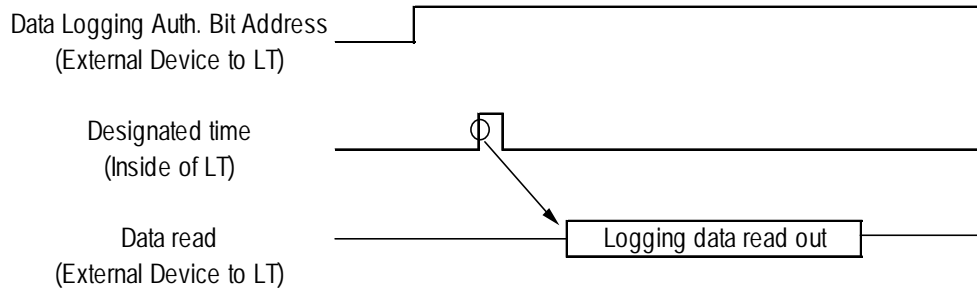

10.2.3 Data Logging Settings

Set up items in the [Trigger Setting], [Display], and [Write Settings] tabs. Select the Project Manager's [Screen/Edit] menu - [Logging Setting] command.

■ **Trigger Settings**

◆ **Trigger Settings (Bit Method)**

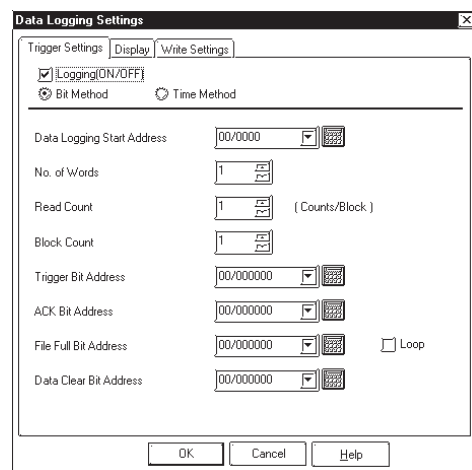

Logging (ON/OFF)

Check this check box when performing data logging.

Bit Method

Select this option when using a Trigger Bit to start data logging.

Data Logging Start Address

Designate the Start Address of the External Device device where data to be logged is stored.

No. of Words

Designate the desired number of words from the Start Address. Up to 32 words can be designated.



When a variable (Logic Symbol) is used as a logging start address, an integer array must be designated. For an integer array, an appropriate size required for consecutive addresses needs to be allocated.

Read Count

Designate the frequency of data logging. Data is logged at the frequency designated here and then handled as a block.

Block Count

Designate the number of data blocks. Data is logged for the number of blocks designated here and then handled as a file.

$$1 \leq \text{Times} \times \text{Blocks} \leq 2048$$

Trigger Bit Address

Designate a Bit Address to be used as External Device's trigger. (External Device to LT)

LT_ACK Bit Address

Designate the External Device Bit Address. When data logging is completed one time, LT turns ON the Bit Address designated here. (LT to External Device)

File Full Bit Address

Designate the External Device's Bit Address. When data logging is performed for the designated number of blocks, the Bit Address designated here is turned ON. (LT to External Device) After the External Device detects the Bit Address is turned ON, turn it OFF.

Data Clear Bit Address

Designate the External Device's Bit Address. When the Bit Address designated here is turned ON, data stored in the backup SRAM is deleted. After the backup SRAM data is deleted, LT turns OFF this Bit Address.

(External Device to LT, LT to External Device)

Loop

Selecting this feature means when data logging is completed, it will begin again from the top-most data address and overwrite the existing data.

◆ Trigger Settings (Time Method)

The screenshot shows the 'Data Logging Settings' dialog box with the 'Time Method' tab selected. The 'Logging(ON/OFF)' checkbox is checked. The 'Bit Method' radio button is unselected, and the 'Time Method' radio button is selected. The settings are as follows:

- Data Logging Start Address: 00/0000
- No. of Words: 1
- Start Time: 0 H 0 M 0 S
- Finish Time: 0 H 0 M 0 S
- Duration: 0 H 0 M 0 S
- Read Count: 1
- Block Count: 1
- Data Logging Auth. Bit Address: 00/000000
- Block's Finish Bit Address: 00/000000
- File Full Bit Address: 00/000000 (with an unchecked 'Loop' checkbox)
- Data Clear Bit Address: 00/000000

Buttons at the bottom: OK, Cancel, Help.

Time Method

Select this option when performing data logging by triggering logging start at the designated timing.

Data Logging Start Address

Designate the Start Address of the External Device device where data to be logged is stored.

No. of Words

Designate the desired number of words counted from the Start Address. Up to 32 words can be designated.

Start Time

Designate the first data logging start time.

Duration

Designate the time period that data logging is performed periodically. “S (second)” setting options are “00”, “15”, “30”, and “45”, with 15 second intervals. When designating data logging time, data logged from the start to end times is handled as 1 block.

Read Count

Designate the frequency of data logging between the Start time and End time. Based on the frequency set here, the End time is determined.

Block Count

Designate the number of data blocks. Data logged for the number of blocks designated here is handled as a file. When designating data logging time, data for a block is logged per day.

$$1 \leq \text{Times} \times \text{Blocks} \leq 2048$$

Data Logging Auth. Bit Address

Designate the External Device’s Bit Address. When the Bit Address designated here is turned ON and it becomes the designated logging time, data logging is performed. (External Device to LT)

Block’s Finish Bit Address

Designate the External Device’s Bit Address. When data logging is completed one time, the Bit Address designated here is turned ON. (LT to External Device) After the External Device detects that the Bit Address is turned ON, turn it OFF.

File Full Bit Address

Designate the External Device’s Bit Address. When data logging is completed for block, the Bit Address designated here is turned ON. (LT to External Device) After the External Device detects the Bit Address is turned ON, turn it OFF.

Data Clear Bit Address

Designate the External Device’s Bit Address. When the Bit Address designated here is turned ON, data stored in the backup SRAM is deleted. After the data is deleted, LT turns OFF the Bit Address. (External Device to LT, LT to External Device)

Loop

Selecting this feature means when data logging is completed, it will begin again from the top-most data address and overwrite the existing data.

■ **Trigger settings with Loop operation**

Trigger settings will differ depending on the type of Loop operation designated.

◆ **Bit Method**

| Item (Trigger Settings) | Without Loop Operation | With Loop Operation |
|----------------------------|-------------------------|---------------------|
| Data Logging Start Address | Designated by user | Designated by user |
| No. of Words | 1 to 32 Words | 1 to 32 Words |
| Read Count | 1 to 2048 ^{*1} | 1 to 2048 |
| Block Count | 1 to 2048 ^{*1} | 1 (fixed) |
| Trigger Bit Address | Designated by user | Designated by user |
| LT_ACK Bit Address | Designated by user | Designated by user |
| File Full Bit Address | Designated by user | Designated by user |
| Data Clear Bit Address | Designated by user | Designated by user |

*1. The maximum number of logging Words in all blocks is 2048.
 Number of blocks \times frequency \leq 2048

◆ **Time Method**

| Item (Trigger Settings) | Without Loop Operation | With Loop Operation |
|--------------------------------|--------------------------|--------------------------|
| Data Logging Start Address | Designated by user | Designated by user |
| No. of Words | 1 to 32 Words | 1 to 32 Words |
| Start Time | Hour/Min. | Hour/Min. |
| Finish Time | No Setting ^{*1} | No Setting ^{*1} |
| Duration | Hour/Min./Sec. | Hour/Min./Sec. |
| Read Count | 1 to 2048 ^{*2} | 1 to 2048 ^{*2} |
| Block Count | 1 to 2048 ^{*2} | 1 to 2048 ^{*2} |
| Data Logging Auth. Bit Address | Designated by user | Designated by user |
| Block's Finish Bit Address | Designated by user | No Setting |
| File Full Bit Address | Designated by user | Designated by user |
| Data Clear Bit Address | Designated by user | Designated by user |

*1. The end time is automatically calculated using the time period and frequency.

*2. The maximum number of logging Words in all blocks is 2048.

Number of blocks \times frequency \leq 2048

When using loop operation, the number of blocks needs to be designated to decide the Logging area size.



The External Device monitors bits at approximately 150 ms intervals. Therefore, a slight time delay may occur until the LT detects the Trigger, or the Data Clear Bit. Set these Bit change intervals to the length of communication cycle or to 150ms, whichever is longer.



- Each piece of data to be logged inside the record is only 16 Bits long. When the External Device device uses 32 Bit length addresses, only the lower 16 Bits of data are logged.
- The LT's internal clock controls time using the last two digits of the year display. Therefore, the logging data's year is controlled by these digits.
- When the Start and End times are the same, or when the time interval is "0", data logging is performed once for each block.
- Data stored in the backup SRAM is cleared via the Data Clear Bit Address, when the Clear Bit changes from OFF to ON.
- When the LT's power is turned ON, if the Data Clear Bit Address's Bit has been turned ON, the LT deletes the backup SRAM logging data and turns OFF the Clear Bit.
- With loop operation and time setup designated, when Data Logging Auth. Bit Address is turned OFF or when the LT's power is turned OFF, after the logging period elapses loop operation becomes the same status as non-loop operation.

(e.g.) Start time 09:00 End time 18:00 Time period 3 hrs.

If the 15:00 logging was skipped due to the LT's power being turned OFF:

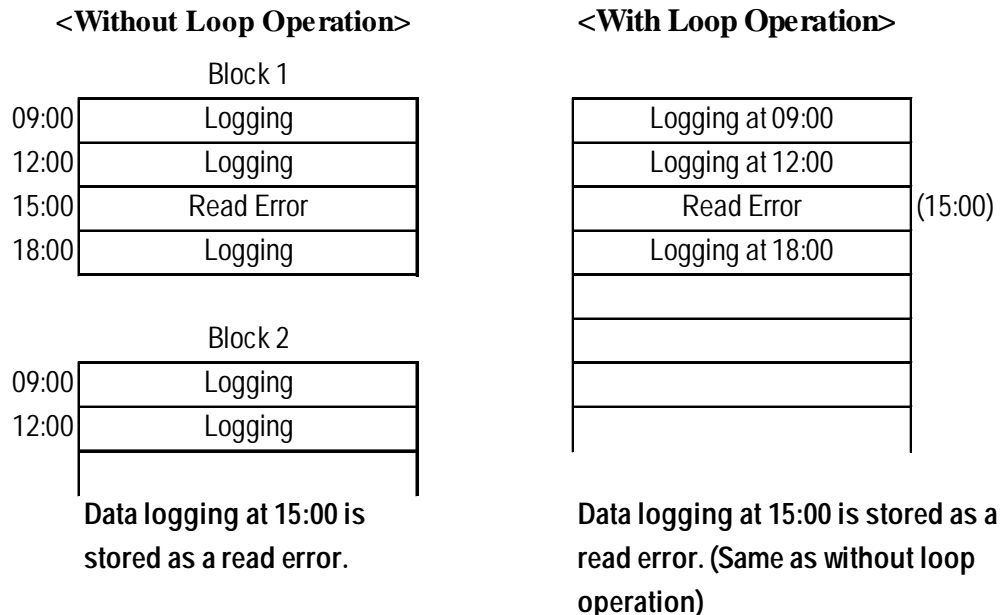

■ Display

Display (ON/OFF)

Click on this check box to display data using the Logging Display.

Row Settings

Display Block Name

Check this check box to display data together with its Block Name.

No. of Block Name Rows

Enter a value here to display block names in multiple rows. Up to 3 rows can be set up.

No. of Data Rows

Set up the number of rows in the data display area.

No. of Calc. Rows

Set up the number of rows in the calculation area. Up to 4 rows can be set up.

Column Settings

Display Block Name

Check this check box to display data together with its Block Name.

No. of Char./Item

Designate the maximum number of block name characters.

No. of Data Col.

Designate the number of data display columns in the data display area.

Data Char. Size

Designate the character size for each data in the data display area.

No. of Char. / Data

Designate the number of characters in the data display area.

Preview

The setting contents can be preview.

◆ **Maximum Number of Rows and Columns**

Up to 60 columns and up to 2100 rows of data can be entered. However, since the file capacity is approximately 58KB, depending on the No. of Block Name Rows and No. of Char./Name designated for the cells, these column and row limits will decrease.

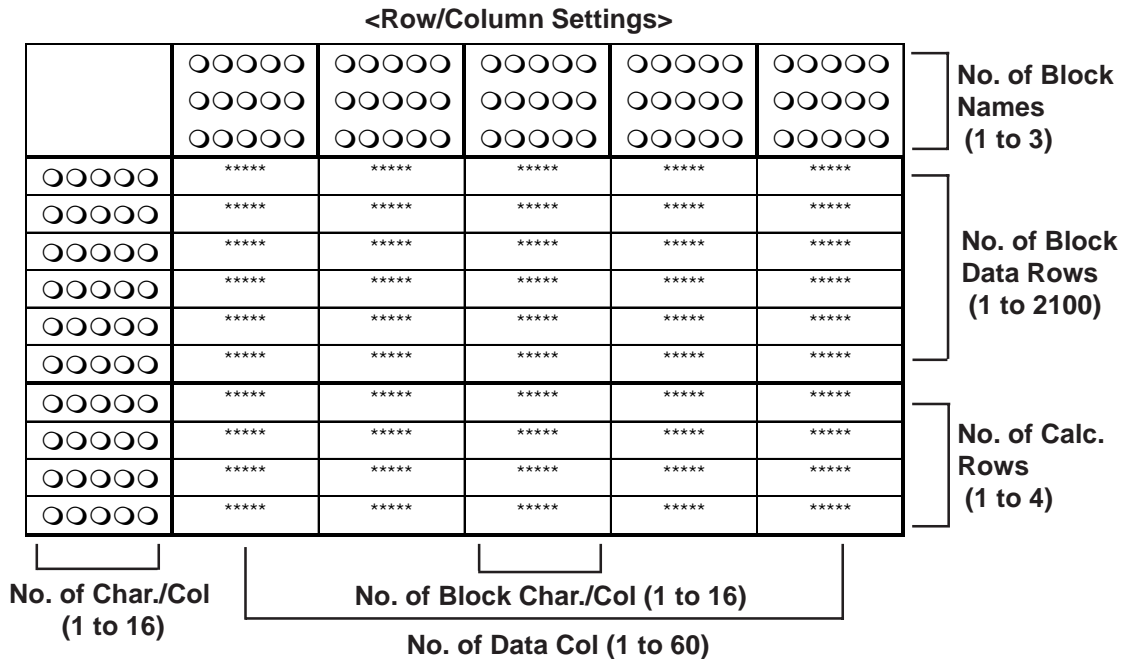

◆ **Row Setting When Using Loop Operation**

When the loop feature is used, regardless of the logging frequency, the data display will always be only one row.

The display row settings used during loop operation are as follows:

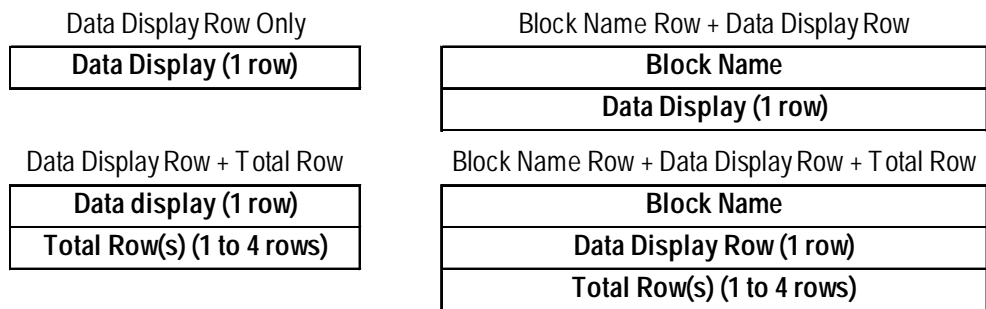

E.g.

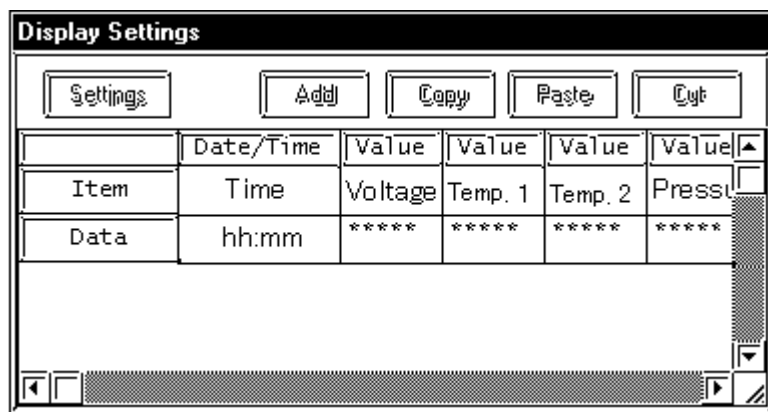

◆ **Row Setting Display When Using Loop Operation**

When using the loop feature, the Data Logging Display is as follows:

E.g. When frequency is set to 4

Logging Data (Backup SRAM data)

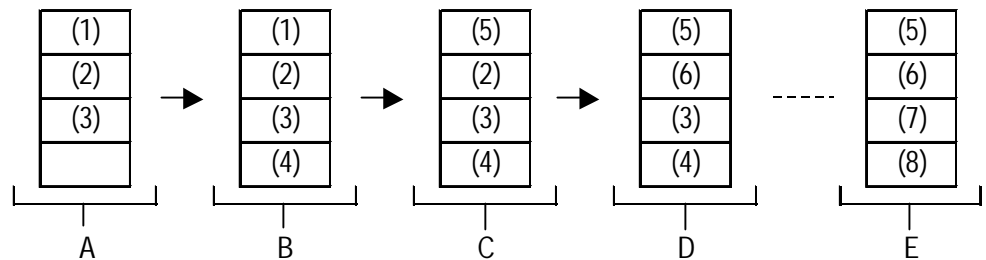

Data Logging Display (Changes over Time)

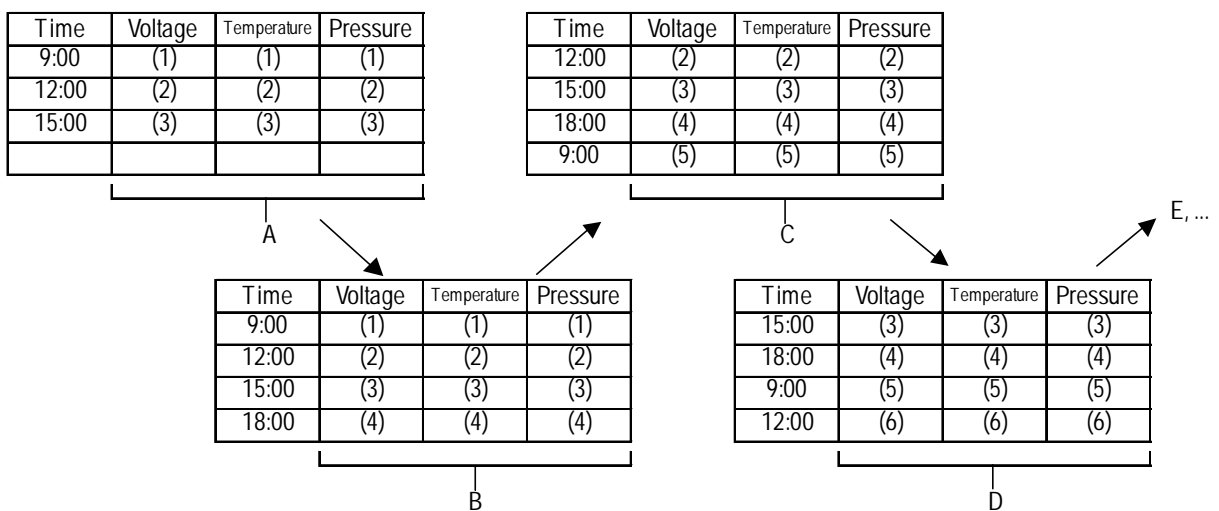

Here, the oldest (acquired earliest) logging data is displayed in the top-most cell. When a single cycle of data logging is completed from beginning to end, data display rows will then shift upwards one row, every time data is logged.

When using the loop feature, the Total (Total, Average, Max., Min.) rows will disappear. However, these Total values will be the totals of backup SRAM data at that one pointing in time. Therefore, the new data that overwrites the old data will not be included in the Total values.

■ Write to LS

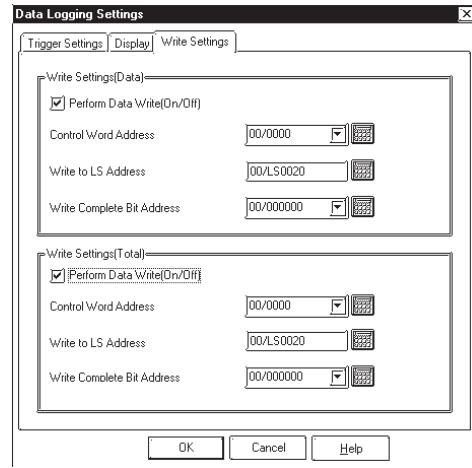

Write Settings (When Writing to LS Area)

Stores logging data in the LS area. Displays logging data items in combination with Keypad Display.

Perform Data Write (On/Off)

Although all logging data can be displayed at a single time via the display settings, using the LS Area allows each piece of logging data to be displayed separately, together with Keypad Display. Click on this check box to use this setting.

Control Word Address

Designate a Word Address that is the trigger or mode change for writing data to the LS Area. This Trigger Bit is turned ON or OFF by the External Device. When writing backup SRAM logging data to the LS area, logging data transfer is performed by designating a Block No. (when using loop operation, set to “0”) and turning the Trigger Bit OFF and then ON.

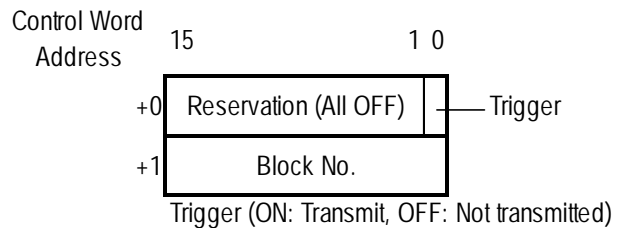

Write to LS Address

Designates the LS Area Address where data is written to.

Write Complete Bit Address

Designates the Bit Address that will be turned ON when data write to the LS Area is completed. After turning the Bit Address ON is detected, use the External Device to turn it OFF. When there is no designated Block No., the Perform Data Write Bit Address is not turned ON.

Write Settings (Total)

Writes each column's total value for each block to the LS area. The Total value is written to the LS area via the Control Word Address, according to the Logging Settings' Display Settings.

Perform Data Write (On/Off)

Designates whether or not the Total value is written to the LS area.

Control Word Address

When writing the Total value to the LS area, transfers the Total value data to the LS area by designating a Block No. and turning the Trigger Bit OFF and then ON.

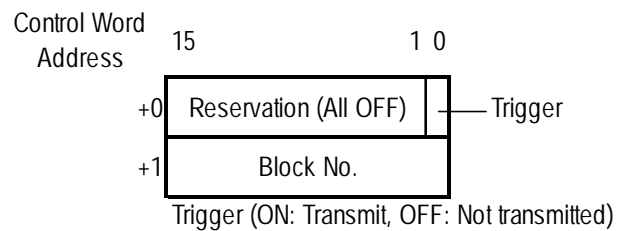

Write to LS Address

Designates the LS Area Address used when writing data.

Write Complete Bit Address

Designates a Bit Address to be turned ON when data write into the LS Area is completed. After the Bit Address ON condition is detected, turn it OFF via the External Device. When there is no designated Block No., the Perform Data Write Bit Address is not turned ON.

◆ **Data to be Written to LS Area**

Block and data structures to be transmitted to the LS Area are as follows:

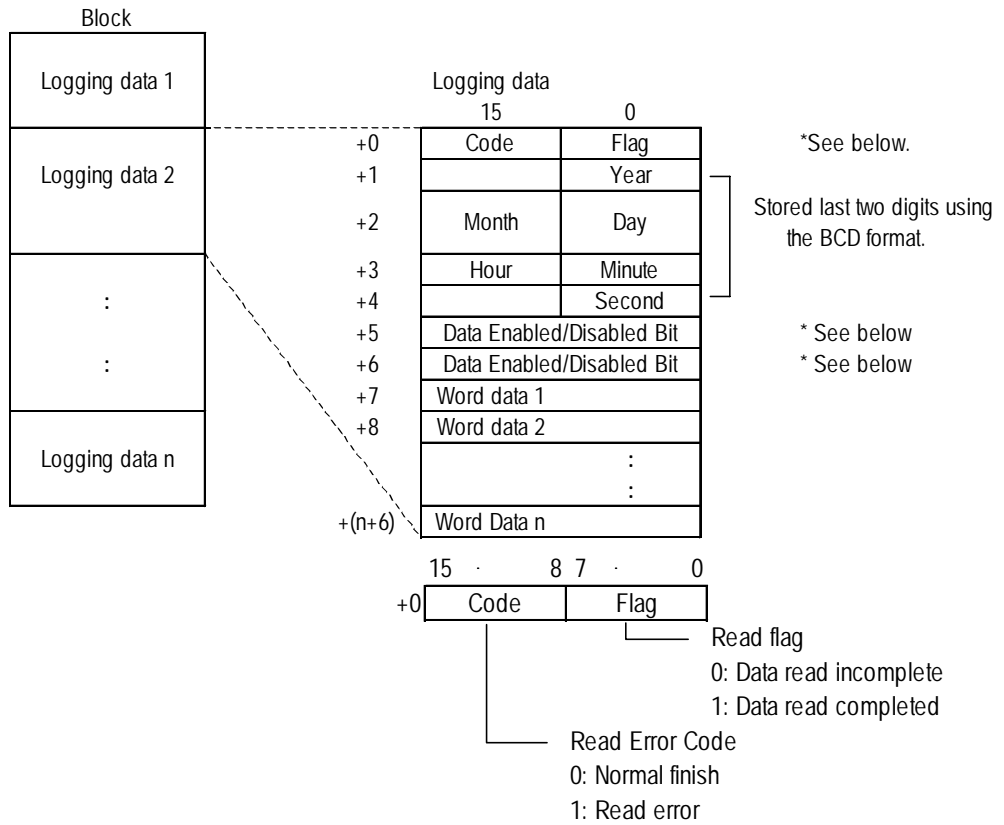

Word Data Enabled/Disabled Bit

| | | | | | | | | | | | | | | | | |
|----|----|----|----|----|----|----|----|----|----|----|----|----|----|----|----|----|
| | 15 | 14 | 13 | 12 | 11 | 10 | 9 | 8 | 7 | 6 | 5 | 4 | 3 | 2 | 1 | |
| +5 | 16 | 15 | 14 | 13 | 12 | 11 | 10 | 9 | 8 | 7 | 6 | 5 | 4 | 3 | 2 | 1 |
| +6 | 32 | 31 | 30 | 29 | 28 | 27 | 26 | 25 | 24 | 23 | 22 | 21 | 20 | 19 | 18 | 17 |

Each Bit in a Word represents a data number.
When a Bit is "0" the Bit is Disabled. When a Bit is "1" the Bit is Enabled.

When using loop operation, logging data is transferred starting with the oldest piece of data.

Logging Data Process (in Backup SRAM)

Here, (1) to (6) represent logging data.

| |
|-----|
| (1) |
| (2) |
| (3) |
| |

In this case, logging data is written to the LS area in the order of (1), (2), and (3).

| |
|-----|
| (5) |
| (6) |
| (3) |
| (4) |

When using the Loop feature, logging data is written in the order of (3), (4), (5), and (6).

If a data block's size exceeds the LS Area size, that data block cannot be transmitted.

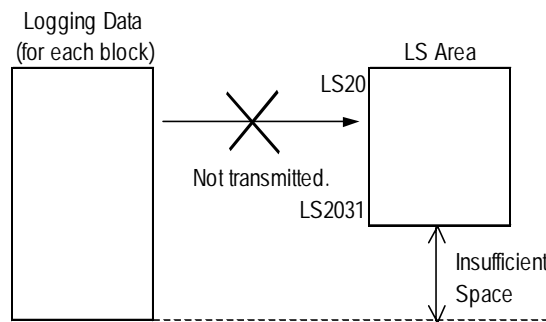

◆ **Display Setting Example for Writing to LS Area**

The following is an example of the display settings used when writing each logging data column's total value data to the LS area. (block units)

<Total Value Data and Average Value Data Display>

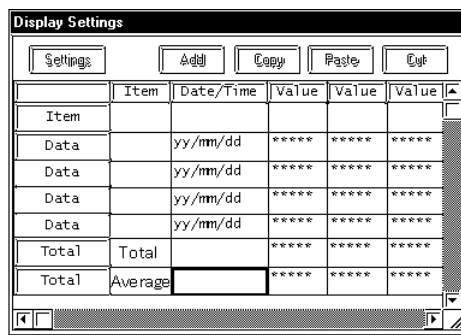

When using the above display settings, the Total value data will be written to the LS area as follows. The Total values (Total, Average, Max., and Min.) are all written as 32 bit data. Also, the Total values will be written from the left column. All values (except Data and Item) will be automatically shifted to the left in a column.

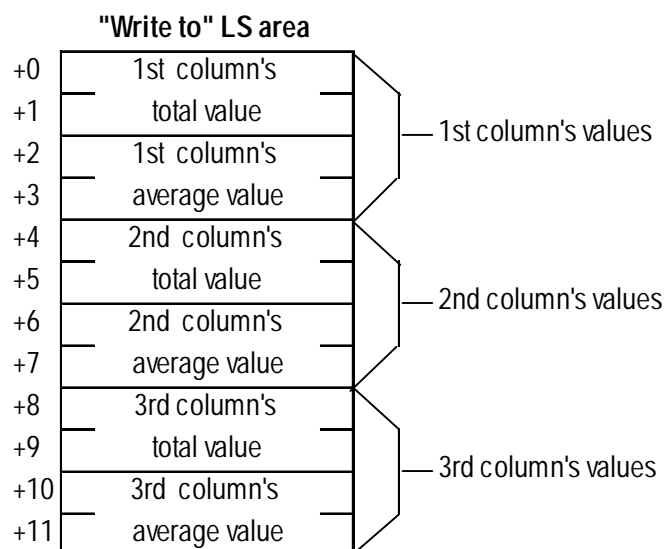

Note: If the size of the Total value data exceeds the LS Area size, that data cannot be transmitted.

10.2.4 Display Settings

■ Display Settings

In the [Display Settings] dialog box, the settings made in the [Display] tab can be viewed and edited.

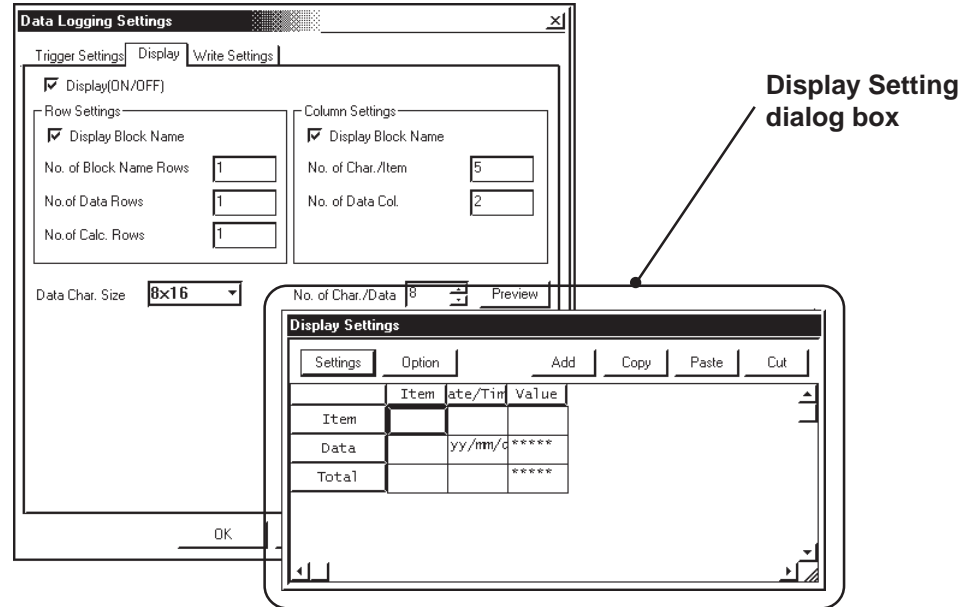

Note: When using loop operation, regardless of the logging frequency, the data display row will be designated as only a single row.

◆ Settings

Rows and columns can be selected to change their attributes.

◆ Add

Select a Data row or Value column and click on the [Add] button, to create a new row or column.

◆ Copy

Copies the currently selected Data row(s) or Value column(s)' data is copied to the Clipboard.

◆ Paste

Pastes data row or Value column data copied to the Clipboard with the [Copy] button in the desired position.

◆ Cut

Deletes the currently selected Data row(s) or Value column(s).

■ When copying row or column data with the same attribute multiple times:

1. Designate the No. of Block Data and No. of Char./Col.
2. Set the attributes for a row or column to create the original data for copying.
3. Select that row or column.
4. Click on the [Copy] button.
5. Select the destination row or column to paste the copied data to. When copying multiple times, select multiple rows or columns.
6. Click on the [Paste] button to paste the same attribute to all the selected rows/columns.

1) Item Name Settings (Display)

■ Enter Item Names

Enter the Item Names for each cell.

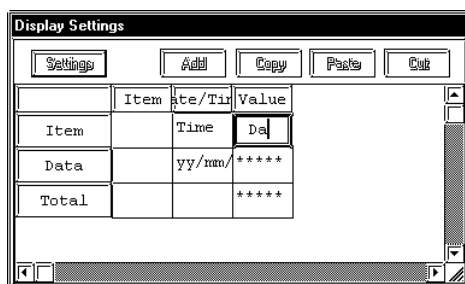

■ Attribute Settings

To change the Item Name attributes, select the Item Name title area and click on the [Settings] button.

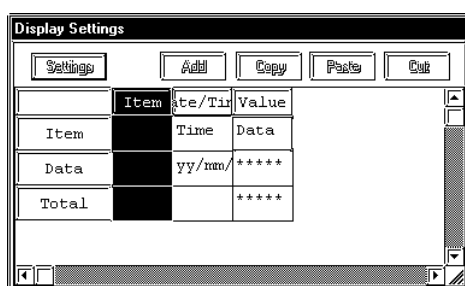

◆ General Info.

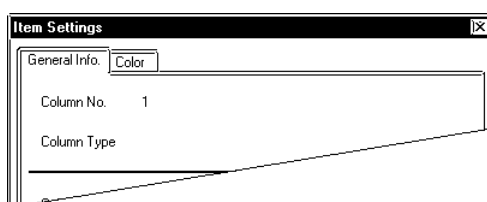

This tab page provides information about the current settings for the Item Name.

◆ **Color**

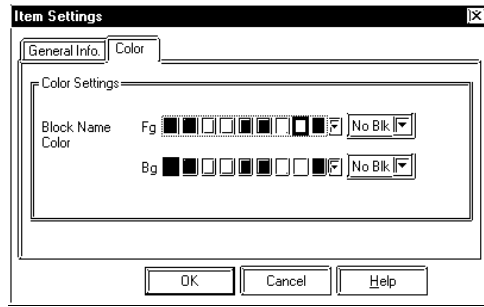

Block Name Color

Select the desired colors for Fg (foreground), Bg (background), and Blk (blink) display.

2) Column Settings (Display)

■ **Attribute Settings**

To enter column attribute data, click on a Date/Time or Value title (top bar) and then click on the [Settings] button.

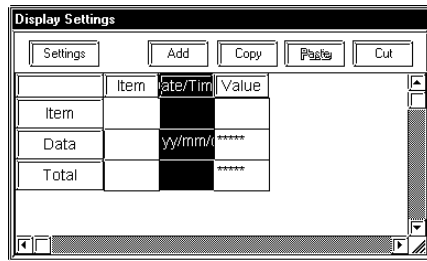

◆ **General Info. [Column Type : Date/Time]**

This tab page provides information about the current Column settings.

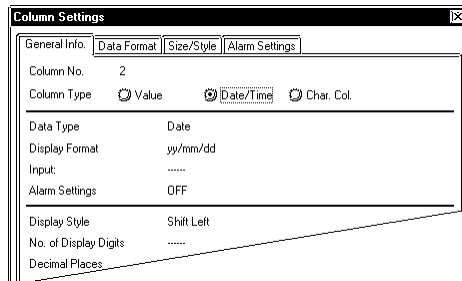

Column Type

Select the desired display item from Value, Date/Time, or Char.Col.

◆ **Data Format**

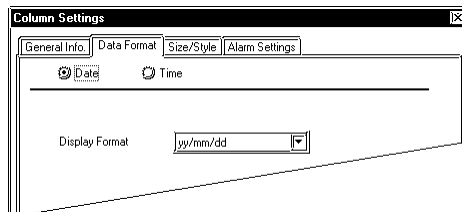

Date

Displays the date.

Time

Displays the time.

Display Format

Select the desired time/date display format.



Note: There are two types of settings in the Date/Time settings, i.e. date settings and time settings. Time is expressed only by the 24 hour system.

- For date:
mm/dd/yy
mm/dd
yy/mm/dd
dd/mm/yy
- For time:
hh:mm
hh:mm:ss

◆ **General Info. [Column Type : Value]**

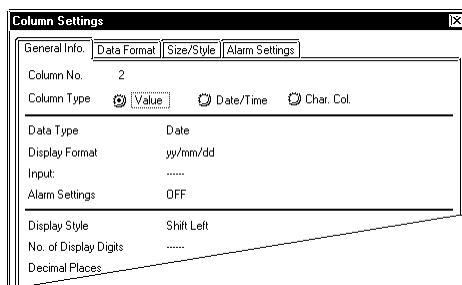

Value

Selecting this option displays actual logging data in the Display Settings area.

◆ **Data Format (Absolute)**

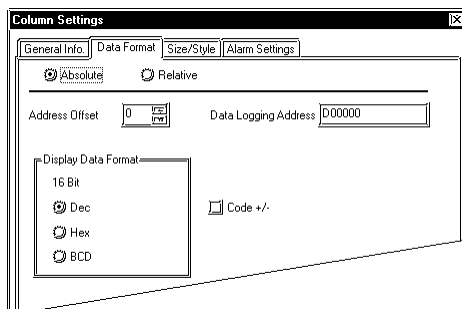

Absolute

Displays Logging Address area Address data.

Address Offset

The Logging Address is changed by the offset value entered here. For example, when the number of logging words is 4, the offset value becomes 0 to 3.

Display Data Format

Select the desired data format from Dec, Hex, and BCD.

Code +/-

Check this check box when displaying negative values. Only available when selecting the Dec data format.

◆ Data Format (Relative)

The screenshot shows the 'Column Settings' dialog box with the 'Data Format' tab selected. The 'Relative' radio button is chosen. The 'Address Offset' is set to 0, and the 'Data Logging Address' is D00000. The 'Bit Length (1-16)' is set to 16. Under 'Input Code', 'No Code' is selected. There are checkboxes for 'Code +/-' and 'Round Up', both of which are unchecked. The 'Input Range' section has 'Min Value' at 0 and 'Max Value' at 65535. The 'Display Range' section also has 'Min Value' at 0 and 'Max Value' at 65535. At the bottom are 'OK', 'Cancel', and 'Help' buttons.

Relative

Data stored in the Address entered in the Logging Address area is converted according to the Input Range area's values and the converted data values are displayed.

Address Offset

The Logging Address is changed by the offset value entered here. For example, when the number of logging words is 4, the offset value becomes 0 to 3.

Bit Length (1-16)

Enter the Enabled Bit length of data to be stored in the Logging Address.

Input Code

No Code

Displays positive values only.

+/-2's Complement

Uses 2's complement to express negative values.

Code +/-

Check this check box when displaying negative values. Only available when selecting the Dec data format.

Round Up

The decimal point numbers created during relative value range conversion will be rounded up or off. When this option is not selected, those numbers will be rounded off.

Input Range

Min. Value

Max. Value

Designates the range of values stored in the Logging Address. The possible ranges vary depending on the Input Code Format.

Display Range

Min. Value

Max. Value

Designates the range of values displayed in the N-tag. The possible ranges vary depending on the Display Format and Code +/- settings.

◆ Size/Style

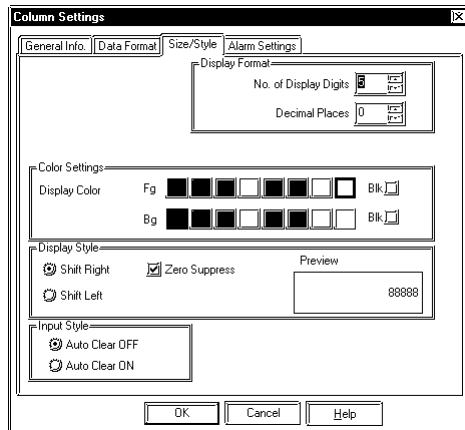
**Display Format****No. of Display Digits**

Designates the number of digits for the display within the range of characters designated in the Display tab, usually as 1 to 16 digits. The length designated here includes digits after the decimal point, but not the decimal point itself.

Decimal Places

Designates the number of digits displayed after the decimal point, usually as 0 to 14 digits. This setting is valid only for Dec and BCD formats. Enter “0” when not displaying decimal place numbers.

Color Settings

Select the desired colors for Fg (foreground), Bg (background), and Blk (blink). When the Alarm option is selected, the color attributes designated here are used for normal display.

Display Style**Shift Left****Shift Right**

Select the display style from the Shift Left and Shift Right. The data will appear, starting from the side designated here. Shift Left has been selected as the default setting.

Zero Suppress

Check this check box to omit the leading zeros of display data. (e.g) When the Display Length is 4 and the Zero Suppress is NOT selected, “25” appears as 0025.

Input Style**Auto Clear OFF**

In this mode, the previously entered values are not cleared and newly entered values are added to those values. To clear the previously entered values, press “CLR” of the touch keyboard.

Auto Clear ON

When the first character of a value is entered (excluding moving the cursor, entering ENT, DEL, and BS), the previously entered value is cleared.



Note: Date/Time and Value data, except for the text characters, are centered. Also, a 2 dot space is automatically inserted in the upper, lower, left and right sides.

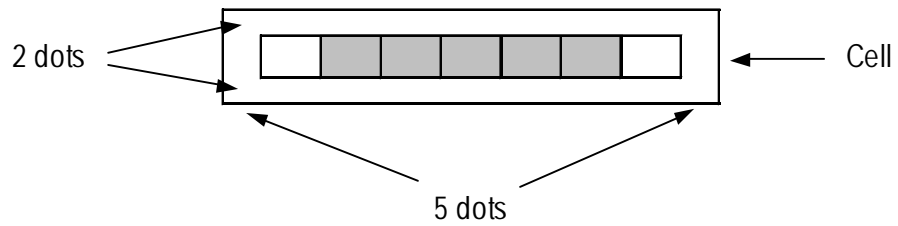

For example, when the number of characters are 7 and the number of numeric value's digits are 5 in a cell, space for one character is saved on both left and right sides and displayed data is centered.

◆ Alarm Settings

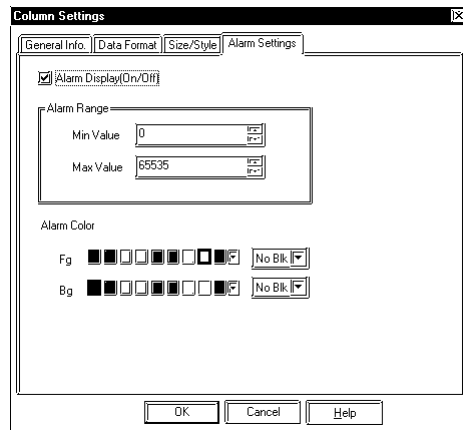

Alarm Display (On/Off)

Select this check box to display the Alarm display.

Alarm Range

Min. Value

Max. Value

When the Alarm Type is set to Direct, designate the Alarm Range. When selecting Relative value display, the Display Range designated in the Data Format tab is used as normal display's Min. and Max Values automatically. The possible Alarm ranges varies depending on the Data Format selected.

Alarm Color

If the data exceeds the Alarm Range, the Alarm display appears in the designated colors.

<Alarm Range List>

| Data Format | | Alarm Range | |
|-------------|-----|-------------|-----------------|
| | | Code+/- | |
| 16Bit | Dec | +/- | -32768 to 32767 |
| | | + | 0 to 65535 |
| | Hex | / | 0 to FFFF(h) |
| | BCD | / | 0 to 9999 |

◆ Size/Style

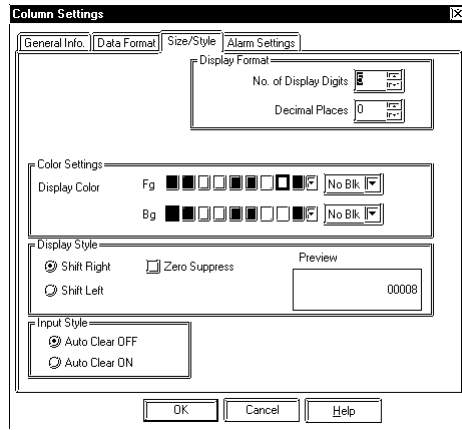

Color Settings

Select the desired colors for Fg (foreground), Bg (background), and Blk (blink).

◆ General Info. [Column Type : Char. Col]

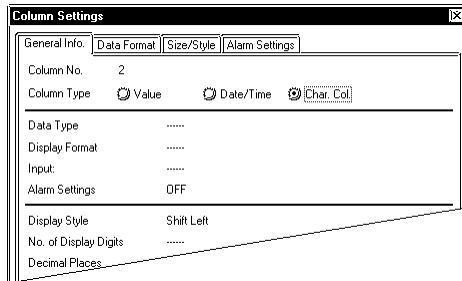

Char.Col

Displays text.

3) Row Settings (Display)

■ Attribute Settings

Select either Item Name or Data row, and click on the [Settings] button to edit each row's attributes.

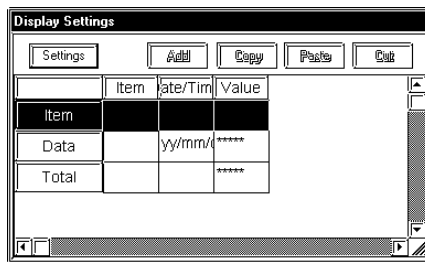

◆ General Info. [Selecting Item Name Row]

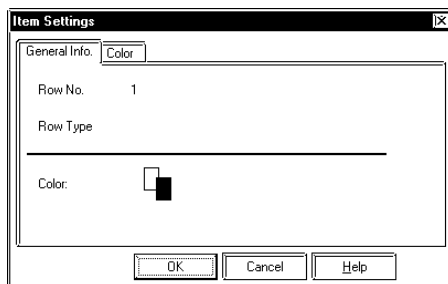

The General Info. page provides information about the current settings for Item Name Settings.

◆ **Color**

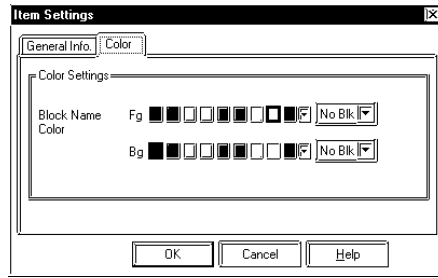

Color Settings

Select the desired colors for Fg (foreground), Bg (background), and Blk (blink).



Note: The row color settings have priority over the column color settings.

◆ **General Info. [Selecting Data Row]**

The General Info. page provides information about the current settings for Data settings.

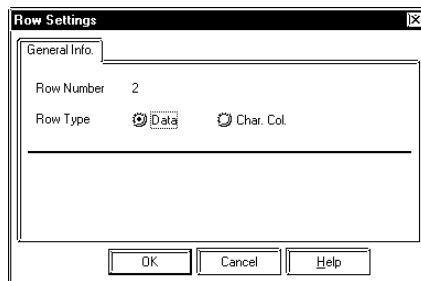

Row Type

Select the desired type of display from the Data and Char.Col. settings.

4) Totals (Display)

■ Attribute Settings

To set up the calculation attributes, select the Totals cell and click on the [Settings] button.

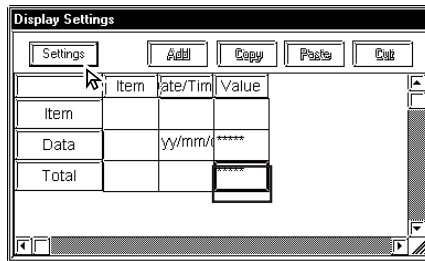

◆ General Info.

The General Info. page provides information about the current settings for Totals Settings.

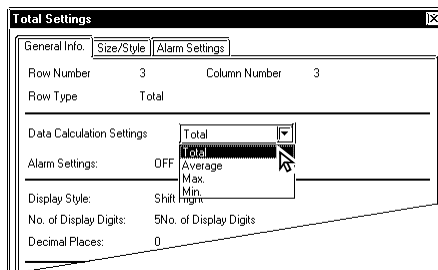

Data Calculation Settings

Select the desired calculation item from Total, Average, Maximum, and Minimum. The calculation attributes can be set up for the entire Data row or Value column. At this time, the applicable column's attribute is Date/Time or Char.Col., and the Data Calculation Settings cannot be designated. Data calculation is performed via the 32 Bit format.

◆ Size/Style

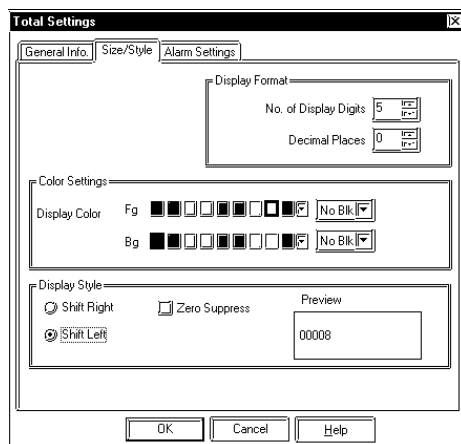

Display Format

No. of Display Digits

Enter the number of display digits. The numbers displayed after the decimal point is also included. (However, the decimal point is not included itself.) Enter a value in a range from 1 to 16.

Decimal Places

Enter the number of digits after the decimal point in a range from 0 to 14. This setting is Enabled only when the Data Format is designated as Dec or BCD. If the values after the decimal point are not displayed, enter "0".

Color Settings

Select the desired colors for Fg (foreground), Bg (background), and Blk (blink). When the Alarm option is selected, the color attributes designated here are used for normal display.

Display Style

Shift Left

Shift Right

Select either shift type. Data is displayed from the selected position. The default setting is Shift Left.

Zero Suppress

When 0 suppression check box is checked, all unnecessary 0s are not displayed. When this check is removed, 0s are added to the front of numbers to match the display length designated in the No. of Display Digits area. (e.g. When the No. of Display Digits is 4 and 0 suppression is OFF, value 25 appears as “0025”.)

■ Display Settings Maximum File Size

The display settings’ file size capacity is approximately 58KB. However, depending on the specific setting combination, the user’s file size may exceed this capacity. The following example is the standard display setting size.

- Enter the Block Name in the 1st column and then up to 8 single-byte characters in each column.
- Enter the Block Name in the 1st row and then up to 8 single-byte characters in each row.
- Four rows are available for totals. (Total, Average, Max., Min.)

| | | No. of value columns | | | | | | |
|--------------------------|------------------------|----------------------|----------|----------|----------|----------|-------|----------|
| | | Block Name | Date | Time | Value | Value | ----- | Value |
| No. of data display rows | Block Name | | ABCDEFGH | ABCDEFGH | ABCDEFGH | ABCDEFGH | | ABCDEFGH |
| | Data display | ABCDEFGH | | | | | | |
| | Data display | ABCDEFGH | | | | | | |
| | Data display | ABCDEFGH | | | | | | |
| | ⋮ | | | | | | | |
| | Data display | ABCDEFGH | | | | | | |
| | Total (Total) | ABCDEFGH | | | | | | |
| | Total (Average) | ABCDEFGH | | | | | | |
| | Total (Max.) | ABCDEFGH | | | | | | |
| Total (Min.) | ABCDEFGH | | | | | | | |

When using the pattern shown above, the maximum number of value columns and data display rows are as follows:

| No. of Value Columns | No. of Data Display Rows | Remarks |
|----------------------|--------------------------|--|
| 32 | 1007 | When the No. of value columns (number of logging words) is the maximum (32 columns). |
| 16 | 1116 | When the No. of value columns (number of logging words) is the maximum (16 columns). |
| 8 | 1170 | When the No. of value columns (number of logging words) is the maximum (8 columns). |
| 4 | 1197 | When the No. of value columns (number of logging words) is the maximum (4 columns). |



When designating the columns as the block name display and entering characters in each column, the file size will become extremely large. Depending on the number of characters entered and other items designated, approximately 1000 rows can be used for the pattern shown above.

Memo

APPENDICES

This section contains a list of error messages and corrective actions, as well as address conversion tables.

| | | |
|-------------------|-------|----------------------------------|
| Appendix 1 | | Error Messages |
| Appendix 2 | | Troubleshooting |
| Appendix 3 | | Address Conversion Tables |
| Appendix 4 | | Software Trouble Report |

A.1 Error Messages

■ Project Manager Errors

This section describes error messages that will be displayed during operation of the LT Editor and how to solve these problems. If malfunction still occurs after the measure is taken, describe the problem in the attached Software Trouble Report and send it to us by facsimile.

| | Error Message | Cause/Solution |
|---|--|--|
| C | Can't edit - Insufficient memory | The memory area for editing is insufficient. Quit other applications, then begin editing your file again. |
| | Cannot edit the files because the filing mode [Use Multiple Folders] setting is not selected! Click on [Use Multiple Folders]. | When the filing mode settings ' [Use Multiple Folders] was not selected, you attempted to open 2 or more kinds of filing data directly from the Project Manager having nesting screen display by double-clicking. Select [Use Multiple Folders]. |
| | Cannot start up Internet browser | The browser settings are not correct or the memory area for the browser is insufficient. Check the settings of the startup browser. If the browser settings are correct, quit all other applications and restart the browser. |
| | Cannot read system file | The program file data required for setup cannot be opened or read, or the file's data is not correct. The file may be corrupt, or a disk error may have occurred. After solving the problem, reinstall the file. |
| | Cannot read the file's system information | The project file is corrupt. Use LT Editor's rebuilding tool to repair the file. After repair is completed, read the file again. |
| | Current Color Depth Not Supported Convert to 256 colors or less | Only bit maps of 256 colors or less can be used by this software. |
| D | Destination screen number is too high. Reduce the number of destination or source screens | Set (Copy source end number - copy source start number) >= (8999 - copy destination start number). |
| E | Exceeds Data Backup Area Limit. Please adjust your settings to fit this area's size limitations | The backup settings, backup area used cannot exceed 2031. Set (Backup start address + the number of devices) to less than or equal to 2031. |
| | External Device File Type Error | The External Device table file format is not the same as the LT's, or the file is corrupt. Select an External Device from the master disk and reinstall the file. |
| G | Grouping Nesting Limit Reached. Unable to group more than these objects | You are attempting to nest grouped objects more than 10 times. Only 10 levels of nesting are allowed. |
| I | Internet Browser Not Selected Yet. Please select a Browser | An Internet browser has not been selected yet. After clicking on the error message's OK button, select a browser from the dialog box that appears. |
| | Invalid Address ! | Before entering the device address, check that the value is within the allowable range and that the device is supported by the External Device. |

| | Error Message | Cause/Solution |
|---|---|---|
| I | Invalid External Device table | The External Device table file format is not the same as the LT's, or the file is corrupt for some reason. Select an External Device from the master disk and reinstall the file. |
| | Incorrect External Device Table Format | The External Device table file format is not the same as the LT's, or the file is corrupt for some reason. Select an External Device from the master disk and reinstall the file. |
| N | Non-LTE File | A file has been selected that is not recognized by LT Editor for Windows 95. Be sure to select only Project (.lte) files. |
| O | Old External Device table and some functions may not work properly. Please use latest table | The External Device table file from an old version is being used. Select a new External Device from the master disk and reinstall it. |
| S | Screen number to copy from must be greater than screen number to copy to. | Enter a "copy to" screen number that is greater than the "copy from" screen number. |
| | Selected project is the same as current project. | You cannot copy data within the same project file. Be sure to specify a project file other than the current project file. |
| | System error | The program file data required for setup cannot be opened and read, or the file's data is not correct. The file may be corrupt, or a disk error may have occurred. After solving the problem, reinstall the file. |
| | System file is corrupt | The program file data required for setup cannot be opened and read, or the file's data is not correct. The file may be corrupt, or a disk error may have occurred. After solving the problem, reinstall the file. |
| | System open error | The program file data required for setup cannot be opened and read, or the file's data is not correct. The file may be corrupt, or a disk error may have occurred. After solving the problem, reinstall the file. |
| U | System write error | The program file data required for setup cannot be opened and read, or the file's data is not correct. The file may be corrupt, or a disk error may have occurred. After solving the problem, reinstall the file. |
| | Unable to convert file. Please check disk. | The destination disk does not have sufficient free space. Prepare a disk that has sufficient space and re-try. |
| | Unable to read current project information | The project file is corrupt. Use the LT Editor rebuilding tool to repair the file, and then read the file again. |
| | Unrecognizable Bitmap File may be corrupted | The selected bit map file is either corrupted or unusable by this software. |

■ Screen Editor Errors

| | Error Message | Cause/Solution |
|----------|---|---|
| C | Can't edit - Insufficient memory | The memory area is insufficient for editing. Quit all other applications and resume editing. |
| | Can't open more than 20 screens | The screen editor can have up to 20 screens open at one time. |
| | Cannot place screen on itself | You cannot call the screen being edited. |
| | Change request will exceed maximum number of Parts. Changes canceled | This change will exceed the Parts upper limit. |
| | Current Color Depth Not Supported. Convert to 256 colors or less | Only bit maps created with 256 colors or less can be used in this system. |
| D | Device address out of range | When the specified command is performed, the device address exceeds the upper limit. Specify an address within the allowable range. |
| E | Exceeded maximum screen size. Changes canceled | This change will exceed the screen size upper limit. ▼Reference▲ ■ "1.5 Screen Editor". |
| | Exceeds alarm limit | Only one alarm can be used on a single screen. |
| | Exceeds time display limit | Only one time display can be used on a single screen. |
| | Exceeds screen size limit | The screen size exceeds the upper limit, and you cannot create any more graphic data. The last data created will become invalid. Store the screen data, and then open a new screen and call the stored screen using [Load Screen] in the [Draw] menu. |
| | Exceeds Part Library limit. | If the number of Part Libraries used exceeds the limit, Part Library data cannot be transferred to the LT. Reduce the number of Part Libraries. ▼Reference▲ ■ 2.1 Parts, ■ Maximum Number of Automatically Created Part Libraries |
| F | Filing displays with the same ID No. cannot be placed on a screen if [Cursor Position Control] is selected. | Multiple filing displays with the same ID No. with [Cursor Position Control] selected cannot be placed on one screen. Either deselect [Cursor Position Control] or change each filing display' ID No. so that the ID Nos. do not overlap. |

■ **Screen Editor Errors (from previous page)**

| | Error Message | Cause/Solution |
|----------|--|--|
| G | Grouping Nesting Limit Reached. Unable to group more than these objects | You are attempting to nest grouped objects more than 10 times. Only 10 levels of nesting are allowed. |
| I | Invalid Screen (Number) | The effective screen number is within the range from 1 to 8999. Re-enter the screen number. |
| P | Parts are not valid objects. | A library item containing Parts cannot be used in a Picture Display. |
| S | Screen No. is out of range. Re-enter a different Screen No. | Screen No. used after conversion is out of the Screen No. range. Enter the correct number. |
| | File write error | This file cannot be written to the destination media. Please check the designated drive name and directory. |
| T | The sum total of all the data saved by the LT's data backup features now exceeds the backup memory unit's limit. Please reduce this amount. | The backup size exceeds the SRAM capacity. Reduce the number of sampling data, or set this item's backup setting to "None". |
| | The area available for data sampling has been exceeded. Please re-enter this item's settings. | The storage address used exceeds 2031. Set (Storage start address + the number of sampling data) to less than or equal to 2031. |
| | The amount entered for the data sampling feature is combined with the number of Trend graph channels created, and their combined total cannot exceed 20. | When 20 channels are preset, the Add button is clicked in the data sampling setting list display dialog box. Delete unnecessary settings so that the total of Trend Graph channel settings and the data sampling settings will be within 20. |
| | There are no screens created for this screen type. | The screen that you attempt to open cannot be created with the specified screen type. Open a new screen. |
| | The designated screen does not exist. | The screen that you attempted to open cannot be found in this project. Select a screen from different existing project. |
| | This object has a non-black background and may not display properly on the LT. Also, be sure that your loaded screen's center point is aligned with the object (loaded to) screen's center point. | If this screen is used as the screen for the background color, be sure to align its center point correctly with the destination screen. |
| U | Unrecognizable Bitmap File may be corrupted | The selected bit map file is either corrupted or unusable by this software. |

■ Library Item Placement / Save Errors

| | Error Message | Cause/Solution |
|----------|--|--|
| G | Grouping Nesting Limit Reached. Unable to group more than these objects | You are attempting to nest grouped objects more than 10 times. Only 10 levels of nesting are allowed. |
| N | Not a library file | The library file selected in the library browser cannot be used in this system. Select a file with a CPW extension. |
| O | Out of memory | Memory is not sufficient to execute the operation. Quit other applications, re-allocate memory, and then restart the operation. |
| S | System error | An error occurs when the library file is being stored. Reserve sufficient free disk space and restart the operation. |
| U | Unable to convert memory block into cell | The memory is not sufficient to execute the operation. Quit other applications, re-allocate memory, and then restart the operation. |
| | Unable to create cell list | The library file is corrupt for some reason. Use the provided rebuilding tool to repair the file and then restart the list creation. |

■ D-Script Errors

| | Error Message | Cause/Solution |
|----------|--|---|
| C | Constant value out of range: | The preset constant value exceeds the specified range. Enter a correct value.* |
| D | D-Script function name has not been entered. Please type the function 's name in the description field. | Do not click OK without entering the function name; you must first specify the function name. Enter the function name. |
| E | Expression too complex. See HELP screens for assistance. | Simplify the D-Script expression. |
| I | if ' expression requires a non-empty statement | An expression is required in { } in the if clause. If no expression is specified, the if clause is ignored.* |
| | Illegal Expression | The entered expression contains an error and will not be recognized.* |
| | Illegal syntax | The entered D-Script expression has a syntax error. |
| | Illegal address | The entered address setting contains an error. Enable the syntax help in the option setting menu and enter the address by clicking the icon, or enter it from the keypad. |
| N | Negative numbers not supported - select correct data type | A negative number cannot be used as a constant. Enter a positive number.* |
| T | This script expression is not legal (it will not download). Do you still want to register this data and quit the D-Script editor? | The preset D-Script expression has an error. Even if this script is registered, the operation will be not performed. |
| W | WARNING: Statement has no effect and has been removed | The entered instruction is ignored because it will not influence the expression. |

* These messages are displayed only when the syntax check in the option setting menu is selected.

■ Alarm Editor Errors

| | Error Message | Cause/Solution |
|----------|---|---|
| C | Can't Add Messages - Insufficient memory | Memory is not sufficient to add the messages. Quit other applications, re-allocate memory and try to add the messages again. |
| | Can't import more alarm message/summary. Alarm message/summary limit has been reached. | During message import, the number of alarm message/summary has exceeded the designated limit. Delete the messages currently set and adjust the setting range so that the messages to be imported can be stored. |
| D | Data in Blocks 2 and 3 cannot be uploaded to the LT. | Since the "Block" feature was turned OFF when this data was downloaded, please delete Blocks 2 and 3. |
| L | Low Memory - not all messages can be pasted! | Memory is not sufficient to paste all the messages. Quit other applications, re-allocate memory and paste the messages again. |
| | Low Memory - not all alarms were copied! Try copying a smaller group. | Memory is not sufficient to paste all the messages. Quit other applications, re-allocate memory and paste the messages again. |
| N | Not enough memory to perform undo! Do you want to continue? | Memory is not sufficient to undo the messages. The deleted message(s) cannot be undone (restored). |
| | Not all alarms were saved. Insufficient disk space | Disk capacity is not enough to store the data. Create more free disk space and store the data again. |
| | Not all alarms were read. Insufficient memory | Memory is not sufficient to read the alarm messages. Quit other applications, create more memory and read in the alarms again. |
| S | Some data is incorrect and all data cannot be imported. | The format of CSV data to be imported is incorrect. Data in and below the line with the incorrect data will not be imported. Check Alarm data's CSV format. |

■ Symbol Editor Errors

| | Error Message | Cause/Solution |
|----------|--|--|
| A | Addresses cannot be used as symbol names! | Enter a standard address in the address column. |
| D | Disk space is insufficient. | The disk in which the data is stored has no free space. Create more free space and try again. |
| T | This Symbol Name is already in use. Please choose another name. | A symbol of the same name has already been defined. Rename the symbol. |
| | This is not a symbol file. Please choose the correct format file. | The chosen file is not a file that can be used for symbol import. Please choose a file that is this format, or modify the chosen file so that it becomes this format. |
| | This is not a device comment file. Please choose the correct format file. | The chosen file is not a device comment import file. Please choose a file that is this format, or modify the chosen file so that it becomes this format. |
| | This symbol name is already registered as a Logic symbol. Please choose another name. | You attempted to change an existing symbol name. Be sure that your symbol name used is not one of those designated in the Word Symbol area's Logic Word or Real areas. |
| | The total number of Logic symbols is over 2048 and a Save cannot be performed. Please delete all unneeded symbols. | The maximum number of symbols has been exceeded. After deleting unneeded symbols, please retry saving the data. |
| S | Some data is incorrect and all data cannot be imported. | The format of CSV data to be imported is incorrect. Data in and below the line with the incorrect data will not be imported. Check Alarm data' CSV format. |
| | Symbol **** 's number of characters is over 20, and cannot be imported. | You attempted to import a symbol with a name over 20 characters long. Please reduce this name to less than 20 characters. |
| % | %s cannot be found, or cannot be performed. | The file(s) required to perform this action cannot be found. Please re-install the application software. |

■ Screen Transfer Errors

| | Error Message | Cause/Solution |
|----------|---|---|
| A | A different Extended Program is present in the LT. The LT's setup cannot be performed. | This extended program can only be sent to a LT containing the same program. Please change the LT type, or install the extended task's program in the LT. |
| | A different Extended Program is present in the LT. Do you wish to continue? | A different type of Extended Program is present in the LT. Press OK to overwrite this program, or Cancel to stop the transfer. Selecting OK will change the LT's internal Extended Program. |
| C | Cannot transmit data at 115.2Kbps - used a slower speed. Change Data Transfer Speed to 38400 when sending data. | This error occurs when the speed of 115.2Kbps cannot be used. Change the Data Transfer Speed setting to 38400 and re-try. |

■ Screen Transfer Errors (from previous page)

| | Error Message | Cause/Solution |
|----------|--|--|
| C | Command Parameter ERROR | Retry data transfer to the designated LT using "Auto Setup". If this message appears again, the PC has a command-related problem. Or, there may be an error in the cable or in the PC. Check both and retry data transfer. If the problem persists, the cable may be damaged. If necessary, contact your local LT distributor. |
| | Connected Device is not correct LT! | A device other than the LT or one that is not supported by LT Editor is connected. Check the model of the connected device. |
| | Core - ID Command failed | An error has occurred during data transfer from the PC. The cable may be disconnected or the LT is OFF. Retry data transfer. |
| D | Data Transfer Port initialization error. | Initialization of the communication port has failed. Check the transfer serial port settings and transfer cable connection. |
| | Do you want to download the simulation protocol? | When you want to transfer the simulation protocol, click OK. Otherwise, click cancel. |
| E | ERROR, Out of Memory | The LT 's internal memory is full. Delete any unnecessary screens. |
| | ERROR, Incomplete Transmission | Screen transfer to the LT has been aborted. Refer to the error message code. |
| | ERROR, No Configuration File | The file required for setup was not found in the specified folder. Re-install the system from the Master disk, or check the transfer path settings. (Transfer Settings area) |
| | ERROR, Cannot Transfer Data | A communication error has occurred and transfer has failed. Reset the LT and PC and retry data transfer. |
| | ERROR, Cannot open Screen | The system is trying to transfer the screen to the LT but cannot open the Project File. |
| H | Handshaking ERROR – LT not Responding | The LT power supply is turned OFF, the data cable is unplugged, or the LT may be in OFFLINE mode. Check all these points. When the LT main unit is in OFFLINE mode, reset it to transfer mode. Also, check the serial port. |
| I | Invalid address substituted for unknown aliases, or invalid address error | When using a symbol in the device address, use the symbol editor to enter the actual symbol addresses. |

■ **Screen Transfer Errors (from previous page)**

| | Error Message | Cause/Solution |
|---|--|--|
| N | Network Connection Failed | Connection to the specified party node is failed. Check the PC network settings and the network cable connection. If the problem still remains, contact the network manager. |
| | No Upload Information in LT Data File | Because the LT does not have the data required for sending the data to the PC, the PC cannot receive the screen. The screen originally may have been sent with the upload information set to "Not transfer". A screen that is not sent together with the upload information cannot be received. |
| P | PGO command failed PLD command failed | The power supply to the LT may have been turned OFF, or the cable has been un-plugged. Reset the LT and the PC and retry data transfer. |
| | Protocol file not found | The External Device protocol file to be sent to the LT is not found in the system's directory. Re-install the LT's system starting from the master disk. |
| S | Send SIO Error - Unable To Open a Com Port | The COM port cannot be used. In the transfer setting menu's serial port setting, specify the available serial port, and retry data transfer. |
| | Send File Error - Bad File Data | The data to be sent is not correct. The data created in the temporary file cannot be read correctly. Check that the disk has sufficient free space and it is not corrupt, and retry file transfer. |
| | Simulation data file cannot be found. | The CSV file is not stored in the directory as the execution file. The simulation information file may be deleted, or the file may have not been created. Set the simulation feature when transferring the screen and retry data transfer. |
| | Simulation data file read-in error. | The CSV file cannot be read into the system. The simulation information file may have been deleted, or the file may have not been created. Set the simulation feature when transferring the screen and retry data transfer. |
| T | The IP Address of the system screen being sent and that in the LT are not the same. To send all screens, press "Yes". ("No" to send only screen data) However, if " 2-Way Driver " has been designated as the destination, sending the LT's System Setting data will not change (overwrite) the IP address. | The IP address currently being sent is different from the address designated in the LT's system settings. To change the IP address, click on "Yes", to preserve the IP address, click on "No". You can either send the screen data or select "Cancel", and then change the current project data's IP address so that it matches that of the LT's. |

■ Screen Transfer Errors (from previous page)

| | Error Message | Cause/Solution |
|----------|---|---|
| T | The Extended Program cannot be found. | The Extended Program required for setting up the LT cannot be found. Please check the CFG file's directory. Also, you may need to change the LT's type. |
| | The Extended Program cannot be found in the LT. The LT's Setup cannot be performed. | Unable to locate the program's destination LT for setup. Check the LT type settings and the LT type selected. Change the LT type, if needed. |
| | The currently selected LT type does not support the Simulation feature. | The currently selected LT type does not support the Simulation feature. This feature cannot be used with the destination LT. Deselect this feature and re-send the data. |
| | This LT does not support Extended Programs. The LT 's setup cannot be performed. | The destination LT does not support Extended Features. Either change the LT Type, or send data that is designed for the designated LT type. |
| | Timeout Error | Communication timeout has occurred. Reset the LT and re-try data transfer. |
| W | Write Error | An error has occurred while reading the data to LT internal memory. Re-try data transfer. If the error occurs again, use the LT's self-diagnosis feature and identify the problem. If necessary, contact your local LT distributor. |

■ Project Compression and Execution Errors

| | Error Message | Cause/Solution |
|----------|---|---|
| D | Disk Error - File Error During Read | The file cannot be opened. The most probable cause is corruption of the file or disk failure. Solve the problem and try again to read the file. |
| | Disk Error - File Error During Write | The disk is write-protected. Take off the write protection. This error also occurs when the disk is defective. |
| U | Unable to open file '***'. Would you like to try to find it elsewhere? | A portion of the file cannot be found. To recover divided files and recreate the original project file, all the divided files are required. |
| | Unable to open file ' *** ' for reading, aborting... | The file cannot be opened. The file is corrupt or the disk has a problem. After correcting the problem, re-try opening the file. |

* The file named is inserted here ***.

■ Rebuild Tool Errors

| | Error Message | Cause/Solution |
|----------|--------------------------------|--|
| F | File version does not match | The specified file contains settings for a version which is not supported by this rebuilding tool. Re-specify a project file (LTE file). |
| R | Rebuilding the File has Failed | Recovery of the file has failed. This file is damaged and cannot be rebuilt. |
| S | LTE header is destroyed | The file header information is corrupt. This file cannot be rebuilt and cannot be used. |

■ DXF File Conversion Errors

The error messages generated during DXF file conversion are as follows:

(xynn) <message> (line = ????)

x : Conversion direction (1: DXF → LT / 2: LT → DXF)

y : Procedure (1: Read 2: Conversion 3: Write)

nn : Error code

(line = ????) : Line No. of the DXF file causing the error

■ DXF File Conversion Errors

| Error Code | Error Message | Cause/Solution |
|------------|--------------------------------------|--|
| 01 | Length Over in 1 record (line, ????) | The single record length of the DXF file exceeds 256 characters. Edit the error line so that the length is less than 256 characters. |
| 02 | DXF Format Error (line, ????) | Non-DXF data may be included. Correct the format of the data at the error line. |
| 03 | HEADER SECTION Not Found | The header section of the DXF file to be read is not found. Add the header section. |
| 04 | \$LIMMIN Not Found | The header section of the DXF file to be read does not have a \$LIMMIN setting. Set the option DXF size to " Use \$EXTMIN, \$EXTMAX " and re-execute the program, or add the \$LIMMIN setting. |
| 05 | \$LIMMAX Not Found | The header section of the DXF file to be read does not have a \$LIMMAX setting. Set the option DXF size to " Use \$EXTMIN, \$EXTMAX " and re-execute the program, or add the \$LIMMAX setting. |
| 06 | \$EXTMIN Not Found | The header section of the DXF file to be read does not have a \$EXTMIN setting. Set the option DXF size to " Use \$LIMMIN, \$LIMMAX " and re-execute the program, or add the \$EXTMIN setting. |
| 07 | \$EXTMAX Not Found | The header section of the DXF file to be read does not have a \$EXTMAX setting. Set the option DXF size to " Use \$LIMMIN, \$LIMMAX " and re-execute the program, or add the \$EXTMAX setting. |
| 08 | EOF Not Found | The EOF record is not specified at the end of the DXF file to be read. Add the EOF record. |
| 0A | ENDSEC Not Found | The ENDSEC record is not specified at the end of the DXF file to be read. Add the ENDSEC record. |
| 0B | ENDTAB Not Found (line, ????) | The ENDTAB record is not specified at the end of the TABLE section of the DXF file to be read. Add the ENDTAB record. |
| 0C | (W) SEQEND Not Found (line, ????) | SEQEND to be used as a pair with VERTEX following the POLYLINE entity is not specified. Add the SEQEND record to the error line. |
| 0D | Insufficient Data (line, ????) | The essential data for the element of each entity is insufficient. Add the required data to the error line. |

■ DXF File Conversion Errors(from previous page)

| Error Code | Error Message | Cause/Solution |
|-------------------|--|--|
| 0E | LTYPE Not Defined (line, ????) | The line type name specified when the entity line type is individually set is not defined in the TABLE section. Add the data of the preset line name to the TABLE section. |
| 0F | LAYER Not Defined (line, ????) | The layer name set in the entity is not defined in the TABLE section. Add the preset layer name to the TABLE section. |
| 10 | STYLE Not Defined (line, ????) | The character style name used in the entity is not defined in the TABLE section. Add the character style name to be used to the TABLE section. |
| 11 | BLOCKS Not Defined (line, ????) | The composite picture name which is referenced by the INSERT and DIMENSION entities is not defined in the BLOCK section. Add the data of the preset composite picture name to the BLOCK section. |
| 21 | Application Error | An unexpected data case is found in the intermediate file. (This does not occur normally.) The temporary file created during conversion may not have been written. Check the free disk space and disk condition and retry conversion. |
| 22 | BLOCKS Not Found | The specified composite picture is not found when converting the INSERT and DIMENSION entities. Add the preset composite picture data to the BLOCK section. |
| 23 | (W) BLOCKS - Over Nesting Limit | The reference layers of the composite picture are more than 10 layers. A compound graphic with more than 10 layers cannot be converted. Correct the graphic data so that the number of layers will be 10 or less. |
| 24 | (W) Conversion Data is Over 16 Kbytes | The output LT screen size (after conversion) exceeds 16 K bytes. The subsequent data cannot be converted. |
| 41 | Format Error | The format of the LT data is not correct. LT data which is not supported may be involved, or the screen data is corrupt. Use the Editor to save the screen again and retry conversion. |
| 42 | (W) Check Sum Error | The checksum of the LT screen read is not correct. The data may be corrupt. Use the Editor to save the screen again and retry conversion. |
| 43 | (W) Library Screen Not Found ???? | The screen being called is not found in the project. Create a destination screen or delete the data which calls the screen. |
| 44 | (W) Mark Screen Not Found ???? | The mark screen being called is not found in the project. Create the destination mark screen or delete the data which calls the mark. |

■ DXF File Conversion Errors(from previous page)

| Error Code | Error Message | Cause/Solution |
|-------------------|---|--|
| 45 | (W) Library Screen Type Error (0x????) | The type of the screen used in the screen call menu is not a base, mark, trend graph, keypad, or an image screen. LT data which is not supported may be involved, or the screen data may be corrupt. Use the Editor to save the screen again and retry conversion. |
| 46 | (W) Screens – Over Nesting Limit | The screen calling layers are greater than 10. Screens with more than 10 layers cannot be converted. Correct the data so that the number of layers will be 10 screens or less. |
| 81 | Disk Full | When writing the temporary file or output file, the disk has become full. Increase the amount of free disk space for the temporary file and output file. |
| 82 | Insufficient Memory | The process is interrupted because of insufficient memory area during operation. Close all other applications and retry the operation. |
| FF | User Abort | The user has interrupted the operation during conversion. |

■ File Management Errors

| | Error Message | Cause/Solution |
|----------|--------------------------------------|--|
| C | Cannot Write File ???? | The data cannot be written to the specified output file name. Check the amount of free disk, or if the disk is write-protected. |
| I | Input File Name Format Error | The specified input file name is different from the file name created by the editor. Specify the correct file name. |
| | Input File Not Found | The specified input file is not found. Check the file name and specify the existing file. |
| O | Output File Name Format Error | The specified output file name cannot be recognized by the editor. Specify the correct file name. |
| W | Work Directory Not Found ???? | The folder in which the temporary file is created is not found. Specify the existing folder using the environment variable TEMP. |

■ Simulation Errors

| | Error Message | Cause/Solution |
|----------|--|--|
| C | Cannot read data in project file. | The screen data cannot be read from the project file. Quit other functions and re-execute. |
| | Cannot write simulation information data. Unable to start simulation. | The system cannot write the data to the simulation information file. Check that the simulation file (TAGDATA.CSV) is not used in other applications and that the directory in which EXE exists is not write-protected. |
| N | Not enough memory. Please close other applications. | Retry this action after closing other active applications. |
| P | External Device Data File cannot be found. | The External Device table file does not exist in the specified directory. The External Device table file is deleted or it is not for the LT. Select the External Device file from the master disk and reinstall the file. |
| S | Simulation start failed. | The LT does not respond to the simulation start command. The LT may be in another mode, or data transfer may have failed. Check the communication port settings, cable connections, LT unit power supply, and then retry the simulation data transfer. |
| | Simulation data file cannot be found. | The simulation information file (TAGDATA.CSV) does not exist in the specified directory. Check (turn on) the Transfer menu [Settings] area's [Simulation] selection, then retry the Simulation. |

■ Filing Data Errors

| | Error Message | Cause/Solution |
|----------|---|--|
| C | Cannot import CSV file. Data is out of range or format is incorrect. | The number of blocks or data amounts is inappropriate in the CSV file to be imported. Enter the correct value(s). |
| D | Data is larger than designated data range. Please check the data settings. | Data from outside the Filing Data's range is present. Check the designated data range settings and change them if necessary. |
| E | Exceeds folder addition limit. | Up to 64 folders can be stored in the internal memory and up to 8999 folders can be stored in the CF card. Any folder cannot be added because the number of folders will exceed the limit. |
| I | Internal memory is not sufficient to save data. Please reduce the block or data settings. | The current settings will overflow the LT's memory. Please reduce either the block or data settings. |
| P | Please enter a Block name. | Nothing has been entered for the Filing Data's Block data. Please enter a name. |
| T | The currently selected data range exceeds the maximum amount allowed. Paste cannot be performed. | Please reduce either the amount of data copied or the number of blocks copied. |
| W | When using 32 bit data settings the maximum number of data items is 20. OK to delete items over 20? | When using 16 bit data, up to 40 items can be used; with 32 bits, maximum is 20. Be sure the data type fits your data needs. |

■ Logging Data Errors

| | Error Message | Cause/Solution |
|---|--|--|
| A | Address Entry limit reached. No more addresses can be entered. | Reduce the number of device addresses used. |
| C | Character size is too large. Please use a different size. | Designated character is larger than LT 's character matrix. Please select a smaller size. |
| D | Display file data size is over maximum. | Reduce the size of the designated display. |
| P | Paste failed. | The current paste settings (range, etc.) are not the same as the paste destination. Or, the paste action may delete a column or effect another data item's settings. |
| | Printer file data size is over. | Reduce the size of the area/amount of data to be printed. |
| T | Time settings cannot exceed 24 hours. Please adjust the settings. | Change the settings so that the time value is 24 hours or less. |
| | The no. of times x no. of blocks should be less than or equal to 2048. | Be sure the number of times and number of blocks produces a result that is 2048 or less. |

A.2

Troubleshooting

This section describes how to solve problems generated when using LT Editor.

Before you begin troubleshooting, please check the following items again. If you answer “Yes” to all the questions, start troubleshooting. If you answer “No” to any one of the questions, set the required item and then start troubleshooting.

If the error still occurs after troubleshooting, fill the details of the error in the provided trouble report sheet and follow the directions stated in Appendix 4.

| Item | Check |
|--|-------|
| Is your personal computer's OS Windows 95/98/Me/NT4.0 or 2000? | |
| Is the memory capacity greater than 16 Mbytes? | |
| Is your PC hard disk's amount of free space sufficient? | |

| Error | Cause/Solution |
|-----------------------------|--|
| LT Editor will not start up | Are all the environment settings correct? Reference X LT Editor CD Jacket |
| | Is your personal computer hard disk's free space amount sufficient? Double-click on the Windows icon. Double-click on the drive in which LT Editor has been installed. Use the [File] menu's [Property] feature to check the amount of free disk space. If the free disk space is insufficient, empty the trash box or delete unnecessary files from the hard disk. |
| | Is the PC's RAM memory capacity sufficient? Memory of 16 M byte or more is required. Click the Windows 95 [Start] button first, and then click on the [Settings], [Control Panel], and [System] selections. Click the virtual memory button in the system property dialog box and check that "Auto Setting (recommended)" is selected. If "Manual Setting" is selected, change the setting to "Auto Setting (recommended)". Restart the PC and then restart LT Editor. |
| | Some applications do not work well with LT Editor and such an application may interfere with the startup of LT Editor. Quit all running applications and delete them from the Startup menu ([Startup] in the Windows 95 [Program] menu. Restart the PC and then restart LT Editor. |
| | Do the trigger commands (Config.sys, Autoexec.bat, etc.) operate correctly? Restart the PC. Press [F8] when "Starting windows" appears. When the menu appears, select "Step-by-step Confirmation" to check that the commands all operate normally. If an error message appears, correct the error. For details, refer to the PC's operation manual. |

| Error | Cause/Solution |
|--|--|
| Cannot draw graphic data | <p><u>Is the LT Editor's screen open?</u> With LT Editor, you must select the project file and open a drawing screen before you can draw any objects. Create a new a screen or open an existing one.</p> |
| | <p><u>Does the disk have enough free space?</u> Prepare a disk which has enough free space.</p> |
| | <p><u>Is the symbol editor started?</u> The screen editor and the symbol editor cannot be started at the same time. Check that the symbol editor window has been closed.</p> |
| Cannot save the screen file's data | <p><u>Is the file write-protected?</u> Check whether the floppy disk is write-protected using the [Property] feature.</p> |
| | <p><u>Does the disk you are saving to have enough free space?</u> Prepare a disk which has enough free space.</p> |
| Cannot communicate between the PC and the LT | <p><u>Is the proper cable being used?</u> Be sure to use the DIGITAL transfer cable (option).</p> |
| | <p><u>Is the LT in the "Screen Data Transfer Mode" or "Run Mode"?</u> If not, communications between the PC and the LT will not be possible. Reference LogiTouch Series User Manual</p> |
| | <p><u>When receiving data from the LT, does your PC's hard disk have enough space?</u> Prepare the disk so that it has enough free space.</p> |
| | <p><u>Is the communication port setting correct?</u> Check that the transfer cable's serial port matches the port set in [Transfer].</p> |
| | <p><u>Does another application use the same communication port?</u> Check whether there is competition between the LT and a modem, or other applications which require the communication port.</p> |
| | The printer does not run/ hard copy is not printed |
| The desired External Device and LT type are not listed when creating a new project | <p><u>Did you select the required External Device and LT type when installing LT Editor?</u> (Custom Installation) When customizing the system installation, you can select the External Device and the LT types. You cannot install an External Device or a LT type if it has not been selected previously. Re-install the system with the desired External Device and LT type.</p> |
| Simulation cannot be performed | <p>Possible causes are that LS area data is being backed up to the LT, via the [LT System Settings], or that an LS area Special Relay is being used by D-Script start up bit. If any of these are true, the simulation cannot be performed. Deselect the [Option] menu - [Settings] - [LS Device Simulation].</p> |

A.3 Address Conversion Tables

Addresses can or cannot be converted depending on the address combination. The combinations which cannot be converted vary with the external device manufacturers. See the following address global conversion table to convert the addresses correctly.

■ How to Read the table

The symbols used in the table have the following meanings:

- : When the address conversion device type is set to [Word], the system converts both Word and bit devices. When the [Bit] setting is used, only bit device addresses are changed.
- ◆ : When the selected conversion mode is [Word], only Word addresses are converted. Selecting [Bit] will convert only bit addresses.
- ★ : When [Word] mode is selected, the system converts only word addresses.
- : When [Bit] mode is selected, the system converts only bit addresses.

(Blanks cannot be converted)

For the timers and counters, the bit indicates the contact or coil used, and the word indicates the current value (elapsed value) or setting value

■ Address Conversion Table List

Memory link SIO Type

| | | |
|--------------------------|-----------------------|-------------------------|
| | | After conversion |
| | | LS |
| Before conversion | LS System Area | ○ |

■ Mitsubishi Electric FREQROL Series

| | | After Conversion | | | |
|--------------------------|--|------------------|---|----------------------------------|----|
| | | - | P | All devices except for parameter | LS |
| Before Conversion | Parameter except for FR-S500, E500's Pr-37 | ○ | ○ | ○ | ○ |
| | P | ○ | ○ | ○ | ○ |
| | Parameter for FR-S500, E500's Pr-37 | ○ | ○ | ○ | ○ |
| | All devices except for parameter | ○ | ○ | ○ | ○ |
| | LS System Area | ○ | ○ | ○ | ○ |

■ Yokogawa Electric FACTORY ACE

| | | After Conversion | | | | | | | | | | | | | | | | | |
|-------------------|-------------------------|------------------|---|---|---|---|---|---|---|----|----|----|----|---|---|---|---|---|----|
| | | X | Y | I | E | M | L | T | C | TP | CP | TS | CS | D | B | R | Z | W | LS |
| Before Conversion | X Input Relay | ○ | ○ | ○ | ○ | ○ | ○ | ■ | ■ | ★ | ★ | ★ | ★ | ○ | ○ | ○ | ○ | ○ | ○ |
| | Y Output Relay | ○ | ○ | ○ | ○ | ○ | ○ | ■ | ■ | ★ | ★ | ★ | ★ | ○ | ○ | ○ | ○ | ○ | ○ |
| | I Internal Relay | ○ | ○ | ○ | ○ | ○ | ○ | ■ | ■ | ★ | ★ | ★ | ★ | ○ | ○ | ○ | ○ | ○ | ○ |
| | E Common Relay | ○ | ○ | ○ | ○ | ○ | ○ | ■ | ■ | ★ | ★ | ★ | ★ | ○ | ○ | ○ | ○ | ○ | ○ |
| | M Special Relay | ○ | ○ | ○ | ○ | ○ | ○ | ■ | ■ | ★ | ★ | ★ | ★ | ○ | ○ | ○ | ○ | ○ | ○ |
| | L Link Relay | ○ | ○ | ○ | ○ | ○ | ○ | ■ | ■ | ★ | ★ | ★ | ★ | ○ | ○ | ○ | ○ | ○ | ○ |
| | T Timer (contact) | ■ | ■ | ■ | ■ | ■ | ■ | ■ | ■ | | | | | ■ | ■ | ■ | ■ | ■ | ■ |
| | C Counter (contact) | ■ | ■ | ■ | ■ | ■ | ■ | ■ | ■ | | | | | ■ | ■ | ■ | ■ | ■ | ■ |
| | TP Timer (current) | ★ | ★ | ★ | ★ | ★ | ★ | | | ★ | ★ | ★ | ★ | ○ | ○ | ○ | ○ | ○ | ○ |
| | CP Counter (current) | ★ | ★ | ★ | ★ | ★ | ★ | | | ★ | ★ | ★ | ★ | ○ | ○ | ○ | ○ | ○ | ○ |
| | TS Timer (setup) | ★ | ★ | ★ | ★ | ★ | ★ | | | ★ | ★ | ★ | ★ | ○ | ○ | ○ | ○ | ○ | ○ |
| | CS Counter (setup) | ★ | ★ | ★ | ★ | ★ | ★ | | | ★ | ★ | ★ | ★ | ○ | ○ | ○ | ○ | ○ | ○ |
| | D Data Register | ○ | ○ | ○ | ○ | ○ | ○ | ■ | ■ | ★ | ★ | ★ | ★ | ○ | ○ | ○ | ○ | ○ | ○ |
| | B File Register | ○ | ○ | ○ | ○ | ○ | ○ | ■ | ■ | ★ | ★ | ★ | ★ | ○ | ○ | ○ | ○ | ○ | ○ |
| | R Joint Register | ○ | ○ | ○ | ○ | ○ | ○ | ■ | ■ | ★ | ★ | ★ | ★ | ○ | ○ | ○ | ○ | ○ | ○ |
| | Z Special Register | ○ | ○ | ○ | ○ | ○ | ○ | ■ | ■ | ★ | ★ | ★ | ★ | ○ | ○ | ○ | ○ | ○ | ○ |
| | W Link Register | ○ | ○ | ○ | ○ | ○ | ○ | ■ | ■ | ★ | ★ | ★ | ★ | ○ | ○ | ○ | ○ | ○ | ○ |
| LS System Area | ○ | ○ | ○ | ○ | ○ | ○ | ■ | ■ | ★ | ★ | ★ | ★ | ○ | ○ | ○ | ○ | ○ | ○ | |

R Joint Register is only for FA-M3.

■ Yamatake Yamatake SDC Series/DMC10

| | | After Conversion | |
|-------------------|----------------|------------------|----|
| | | Data | LS |
| Before Conversion | Data | ○ | ○ |
| | LS System Area | ○ | ○ |

■ Rika Kohgyou CB/SR-Mini Series

| | | After Conversion | |
|-------------------|--------------|------------------|----|
| | | 0000 to 02EE | LS |
| Before Conversion | 0000 to 02EE | ○ | ○ |
| | LS | ○ | ○ |

■ Omron THERMAC NEO Controller

| | After Conversion | | | | | |
|-------------------|------------------|----|----|----|---|----|
| | | C0 | C1 | C3 | A | LS |
| Before Conversion | C0 | ○ | ○ | ○ | ○ | ○ |
| | C1 | ○ | ○ | ○ | ○ | ○ |
| | C3 | ○ | ○ | ○ | ○ | ○ |
| | A | ○ | ○ | ○ | ○ | ○ |
| | LS | ○ | ○ | ○ | ○ | ○ |

■ Shinkoh Technos C/FC/FIR/GC/FCL/PC-900 Series

| | | After Conversion | | | |
|-------------------|----------------------|------------------|---|---|----|
| | | — | S | C | LS |
| Before Conversion | ----- | ○ | ○ | ○ | ○ |
| | Setting Value Memory | ○ | ○ | ○ | ○ |
| | Channel | ○ | ○ | ○ | ○ |
| | LS Area LS | ○ | ○ | ○ | ○ |

■ Fuji Electric FRENICS, FVR Series

| | | After Conversion | | | | | | | | | |
|-------------------|---------------------------|------------------|---|---|---|---|---|---|---|---|----|
| | | F | E | C | P | H | A | o | S | M | LS |
| Before Conversion | Fundamental Function F | ○ | ○ | ○ | ○ | ○ | ○ | ○ | ○ | ○ | ○ |
| | Terminal Function E | ○ | ○ | ○ | ○ | ○ | ○ | ○ | ○ | ○ | ○ |
| | Control Function C | ○ | ○ | ○ | ○ | ○ | ○ | ○ | ○ | ○ | ○ |
| | Motor 1 P | ○ | ○ | ○ | ○ | ○ | ○ | ○ | ○ | ○ | ○ |
| | High-level Function H | ○ | ○ | ○ | ○ | ○ | ○ | ○ | ○ | ○ | ○ |
| | Motor 2 A | ○ | ○ | ○ | ○ | ○ | ○ | ○ | ○ | ○ | ○ |
| | Option O | ○ | ○ | ○ | ○ | ○ | ○ | ○ | ○ | ○ | ○ |
| | Command Data S | ○ | ○ | ○ | ○ | ○ | ○ | ○ | ○ | ○ | ○ |
| | Monitor Data M | ○ | ○ | ○ | ○ | ○ | ○ | ○ | ○ | ○ | ○ |
| | System Area LS | ○ | ○ | ○ | ○ | ○ | ○ | ○ | ○ | ○ | ○ |

■ Fuji Electric Micro Controller X

| | | After Conversion | | | | | |
|-------------------|---------------|------------------|---|----|----|----|----|
| | | 0 | 1 | 30 | 40 | 31 | 41 |
| Before Conversion | 0 | ■ | ■ | ■ | ■ | ■ | ■ |
| | 1 | ■ | ○ | ○ | ○ | ○ | ○ |
| | 30 | ■ | ○ | ○ | ○ | ○ | ○ |
| | 40 | ■ | ○ | ○ | ○ | ○ | ○ |
| | 31 | ■ | ○ | ○ | ○ | ○ | ○ |
| | 41 | ■ | ○ | ○ | ○ | ○ | ○ |
| | LS Area LS | ■ | ○ | ○ | ○ | ○ | ○ |

■ Mitsubishi Electric MELSEC-F₂

| | | After Conversion | | | | | | | |
|-------------------|-------------------------------------|------------------|---|---|---|---------|---------|---|----|
| | | X | Y | N | S | T/TC/TS | C/CC/CS | D | LS |
| Before Conversion | X Input Relay | ■ | ■ | ■ | ■ | ■ | ■ | ■ | ■ |
| | Y Output Relay | ■ | ■ | ■ | ■ | ■ | ■ | ■ | ■ |
| | M Auxiliary Relay, Keep Relay | ■ | ■ | ■ | ■ | ■ | ■ | ■ | ■ |
| | S State | ■ | ■ | ■ | ■ | ■ | ■ | ■ | ■ |
| | T/TC/TS Timer | ■ | ■ | ■ | ■ | ○ | ○ | ■ | ■ |
| | C/CC/CS Counter | ■ | ■ | ■ | ■ | ○ | ○ | ■ | ■ |
| | D Data Register | ■ | ■ | ■ | ■ | ◆ | ◆ | ○ | ○ |
| | LS System Area | ■ | ■ | ■ | ■ | ◆ | ◆ | ○ | ○ |

■ Mitsubishi Electric MELSEC-FX

| | | After Conversion | | | | | | | |
|-------------------|---------------------|------------------|---|---|---|-------|-------|---|----|
| | | X | Y | M | S | TS/TN | CS/CN | D | LS |
| Before Conversion | X Input Relay | ○ | ○ | ○ | ○ | ◆ | ◆ | ○ | ○ |
| | Y Output Relay | ○ | ○ | ○ | ○ | ◆ | ◆ | ○ | ○ |
| | M Internal Relay | ○ | ○ | ○ | ○ | ◆ | ◆ | ○ | ○ |
| | S Step Relay | ○ | ○ | ○ | ○ | ◆ | ◆ | ○ | ○ |
| | TS/TN Timer | ◆ | ◆ | ◆ | ◆ | ○ | ○ | ◆ | ◆ |
| | CS/CN Counter | ◆ | ◆ | ◆ | ◆ | ○ | ○ | ◆ | ◆ |
| | D Data Register | ○ | ○ | ○ | ○ | ◆ | ◆ | ○ | ○ |
| | LS System Area | ○ | ○ | ○ | ○ | ◆ | ◆ | ○ | ○ |

■ Toho Electronics TTM Series

| | | After Conversion | | | | | | | | | | | | | | | | | |
|--------------------------|-------|------------------|-----|------|------|------|------|-------|-----|-----|-----|-----|-----|-----|-----|-----|-----|-----|----|
| | | 00_ | 10_ | 100_ | 110_ | 120_ | 300_ | 1020_ | SSV | END | STI | SOK | SWZ | SWT | SON | SOF | SRN | SEO | LS |
| Before Conversion | 00_ | ○ | ○ | ○ | ○ | ○ | ○ | ○ | ○ | ○ | ○ | ○ | ○ | ○ | ○ | ○ | ○ | ○ | ○ |
| | 10_ | ○ | ○ | ○ | ○ | ○ | ○ | ○ | ○ | ○ | ○ | ○ | ○ | ○ | ○ | ○ | ○ | ○ | ○ |
| | 100_ | ○ | ○ | ○ | ○ | ○ | ○ | ○ | ○ | ○ | ○ | ○ | ○ | ○ | ○ | ○ | ○ | ○ | ○ |
| | 110_ | ○ | ○ | ○ | ○ | ○ | ○ | ○ | ○ | ○ | ○ | ○ | ○ | ○ | ○ | ○ | ○ | ○ | ○ |
| | 120_ | ○ | ○ | ○ | ○ | ○ | ○ | ○ | ○ | ○ | ○ | ○ | ○ | ○ | ○ | ○ | ○ | ○ | ○ |
| | 300_ | ○ | ○ | ○ | ○ | ○ | ○ | ○ | ○ | ○ | ○ | ○ | ○ | ○ | ○ | ○ | ○ | ○ | ○ |
| | 1020_ | ○ | ○ | ○ | ○ | ○ | ○ | ○ | ○ | ○ | ○ | ○ | ○ | ○ | ○ | ○ | ○ | ○ | ○ |
| | SSV | ○ | ○ | ○ | ○ | ○ | ○ | ○ | ○ | ○ | ○ | ○ | ○ | ○ | ○ | ○ | ○ | ○ | ○ |
| | END | ○ | ○ | ○ | ○ | ○ | ○ | ○ | ○ | ○ | ○ | ○ | ○ | ○ | ○ | ○ | ○ | ○ | ○ |
| | STI | ○ | ○ | ○ | ○ | ○ | ○ | ○ | ○ | ○ | ○ | ○ | ○ | ○ | ○ | ○ | ○ | ○ | ○ |
| | SOK | ○ | ○ | ○ | ○ | ○ | ○ | ○ | ○ | ○ | ○ | ○ | ○ | ○ | ○ | ○ | ○ | ○ | ○ |
| | SWZ | ○ | ○ | ○ | ○ | ○ | ○ | ○ | ○ | ○ | ○ | ○ | ○ | ○ | ○ | ○ | ○ | ○ | ○ |
| | SWT | ○ | ○ | ○ | ○ | ○ | ○ | ○ | ○ | ○ | ○ | ○ | ○ | ○ | ○ | ○ | ○ | ○ | ○ |
| | SON | ○ | ○ | ○ | ○ | ○ | ○ | ○ | ○ | ○ | ○ | ○ | ○ | ○ | ○ | ○ | ○ | ○ | ○ |
| | SOF | ○ | ○ | ○ | ○ | ○ | ○ | ○ | ○ | ○ | ○ | ○ | ○ | ○ | ○ | ○ | ○ | ○ | ○ |
| | SRN | ○ | ○ | ○ | ○ | ○ | ○ | ○ | ○ | ○ | ○ | ○ | ○ | ○ | ○ | ○ | ○ | ○ | ○ |
| | SEO | ○ | ○ | ○ | ○ | ○ | ○ | ○ | ○ | ○ | ○ | ○ | ○ | ○ | ○ | ○ | ○ | ○ | ○ |
| LS | ○ | ○ | ○ | ○ | ○ | ○ | ○ | ○ | ○ | ○ | ○ | ○ | ○ | ○ | ○ | ○ | ○ | ○ | |

A.4 Software Trouble Report

■ When problems continue after following “Troubleshooting” advice

If following the steps outlined in the troubleshooting section does not solve your problem, please make a copy of the next page’s Software Trouble Report, fill in any relevant information, and fax it to your local Pro-face service center.

Please include any relevant details, including project data and/or screens so that the problem can be duplicated. We guarantee all this data will remain confidential.

Also, please take the time to use the “OSCHECK” tool installed with your LT Editor software, and include a printout of its result with your fax.

Using the “OSCHECK” Program

This program, after it completes its test, produces a text file (*.txt). Please be sure to print out this data and include it with your Software Trouble Report.

- 1) Click on the Windows main screen’s [Start] button and then on the [Run] selection.
- 2) Here, use the [Browse] feature to find the OSCHECK.EXE program, located in your PC’s “LT Editor” folder. Once you find it, click on [OK] to start the program.
- 3) Designate the status report’s Save folder and filename. Click again on [OK] and the text file will be created.



- ***When inquiring, be sure to write down your software’s serial No. Without your software’s serial No., your question(s) cannot be answered.***
- ***Understand that it may take some time for us to respond, since your question must be carefully checked and recreated.***

Pro-face FAX and Email Information:

• **Pro-face Europe:** FAX No. +31-(0)20-6464-358 Email: support@proface.com

• **Pro-Face Korea:** FAX No. +82-(0)2-3664-6839 Email: proface@proface.co.kr

• **Pro-Face Taiwan:** FAX No. +886-(0)2-8773-7892 Email: proface@proface.com.tw

• **Pro-face America (North and South):** FAX No. +1-630-351-1102

Email: support@profaceamerica.com

Digital (Japan) FAX and Email Information:

• Digital Electronics Corporation: FAX No. +81-6-6613-5982 Email: support@digital.co.jp

Also, if you require instruction about the correct usage of your LT Editor software, please use the above information to contact your local LT Editor distributor.

INDEX

A

Adding Alarm Data 5-9
 Address Conversion Table List 19
 Address Increment 2-137
 Address Map Display 2-226
 Address Range Conversion 2-148
 Address Registration 8-6
 Alarm [Style/Color] Attributes 2-58
 Alarm Color 2-9
 Alarm Export 5-13
 Alarm Import 5-14
 Alarm Message/Summary Screen 5-3
 Alarm Range 2-9
 Alarm Settings 2-9
 Alarm Summary [Description] Attributes 2-57
 Alarm Summary [Display Format] Attributes 2-58
 Alarm Type 2-9
 Aligning Object Positions 2-141
 Alignment (Justification) 2-11
 Automatic Filing Data Transmission 10-12
 Automatically create file name 2-154
 aving a Library File 2-173

B

Bit Switch [General Settings] Attributes 2-14
 Bit Switch [Shape/Color] Attributes 2-15
 Blink 2-8
 Browsing Help Topics 1-27

C

Calling up Device Comments 4-26
 Calling up Help from a Dialog Box 1-28
 Canceling a Command: Undo 3-21
 Canceling an Action 2-157
 CD-ROM 1
 CD-ROM Usage Precautions 8
 Change Order 2-220
 Changing Alarm Attributes 5-10
 Changing Attributes 2-147
 Changing Display Addresses 2-227
 Changing Screen Numbers and Titles 4-5
 Changing the Data Sampling Setting Order 2-224
 Changing the Library's Display 2-159
 Changing the Order of Overlapping Objects 2-146

Chapter Breakdown 6
 Character Size 2-11, 2-52, 2-111
 Closing a Logic Program 1-11
 Closing a Screen 1-16
 Colors 2-7
 Communication Port 7-5
 Communication Settings Menu 6-6
 Confirming Addresses 2-148
 Connecting to the Home Page 1-30
 Conversion between Instructions and Parts 2-131
 Convert DXF Size 2-231, 2-237
 Converting a Bitmap 3-26
 Converting a Screen into a Bitmap File 2-155
 Converting and Placing a Bitmap 2-151
 Converting Data (DXF to PRW) 2-230
 Converting DXF File Data 2-234
 Converting/Placing a Bit Map 3-24
 Converting/Placing a Bitmap: [Source] 3-24
 Copy from Description 2-10
 Copy to Off (On) state 2-10
 Copying a Library Item 2-171
 Copying a Part on the Parts List 2-222
 Copying a Specified Range : Duplication 3-15
 Copying an Object 2-129
 Copying Screens 4-3
 copyrights 1
 Cover Page Dialog Box 9-3
 Creating a Dot 2-96
 Creating a New Library File 2-160
 Creating a New Project 1-2, 1-5, 1-10
 Creating Labels 2-10
 Creating/Editing a Logic Program 1-10
 Cross Reference 2-225
 Cutting (Moving) an Object 2-128
 Cutting a Library Item (from a Library File) 2-170
 Cutting a Library Item (from a Library File) and P 2-170
 Cutting a Mark 3-12

D

D-Script Settings: Copy and Paste 2-182
 D-Script Tool Box 2-183
 Data Display Format 2-51
 Data Logging Display [Color] Attributes 2-69
 Data Logging Display [Data Type] Attributes 2-68

Index

Data Logging Display [General Settings] Attributes 2-67
Data Logging Display [Switch Settings] Attributes 2-70
Data Logging Display [Switch Shape/Color] 2-70
Data Logging Flow 10-27
Data Storage Example 2-209
Data Transmission via External Device 10-15
Date Display [General Settings] Attributes 2-83
Decimal Places 2-52
Definition of Functions 2-181
Deleting a Home Page Address 1-29
Deleting a Library Item 2-169
Deleting a Mark 3-16
Deleting D-Script Settings 2-181
Deleting Data Sampling Settings 2-211
Device Address 2-217
Device Comment Types 4-20
Display Area (50%, 100%, 200%) 1-25
Display in Load Screen Object 2-216
Display Settings 10-44
Dot Attributes 2-95
Dragging and Dropping 2-136
Drawing 9
Drawing a Circle 3-8
Drawing Functions 1-2
Drawing Tools 2-94, 3-2
Drawing with Dots 3-4
Duplicate Setting Dialog Box 2-137
Duplicating 2-139

E

Editing a Home Page Address 1-30
Editing a Library Item 2-168
Editing an Object 2-220
Editing D-Script Settings 2-175, 2-178, 2-180, 2-181, 2-182
Editing Items on the Part Reference List 2-221
Editing Library Items 2-159
Editing Tools 3-3
Editing via the Load Screen List 2-228
Entering a Comment 2-3
Entering Addresses 2-4
Entering from a keyboard 2-4
Entering from a pop-up keypad 2-5
Entering from a pull-down list 2-4
Entering from the Address Keypad 2-5
Entering Text 2-113
etting Screen Property - [Display] 2-215
Exporting a CSV File 2-223, 2-224

F

File Name Display [Display] Attributes 2-62
File Name Display [General Settings] Attributes 2-61
File Name Display [Style/Color] Attributes 2-62
File Name Display [Switch Settings] Attributes 2-63
File Name Display [Switch Type/Color] Attributes 2-64
File Types 1-7
Filing Data List 10-12
Filing Data Setup Procedure 10-8
Filing Data Transfer Flow 10-3
Filing Data Transmission Methods 10-6
Filing Name Display Settings 10-23
Filing Setting Example 10-17
Fill 2-216
Fill Point Color 2-218
Filling a Mark 3-9
formal trade names 2
Freehand Drawing 3-5
Function Buttons 1-19
Function Switch [General Settings] Attributes 2-20
Functions 2-15, 2-180
Functions and Settings 9

G

General GP Restrictions 9
General Information Symbols and Terms 3
Global Cross Reference 2-226
GP Settings 6-4
GP Type 1-5
GP-PRO/PBIII for Windows Part Type Summary 2-2
Grid/Snap Settings dialog box 2-213
Grouping Objects 2-144

H

How to Move an Object 2-126
How To Register a Home Page Address 1-31
How to Select a Single Object 2-121
How to Select Multiple Objects 2-122, 2-132, 2-134
How to Use This Manual 5

I

I/O Settings 6-4
ID Numbers 2-11
iling Setting Example 10-17

Importing Symbols and Device Comments 4-23
 Initial Screen Settings 6-5
 Interlock 2-15

J

Justification 2-112

K

Keyboard Compatibility List 4
 Keypad Display [Color/Shape] Attributes 2-52
 Keypad Display [Display Format] Attributes 2-51
 Keypad Display [General Settings] Attributes 2-51

L

Label 2-10
 Label] Attributes 2-15
 Library Browser 2-158
 Library Size 2-159
 Line space 2-11
 Line Type Conversion DXF to PRW) 2-232
 Line/Polyline Attributes 2-96
 Link Select 2-220
 List Display 2-226
 List Screens 7-16
 Listing Screens 4-2
 Load Screen and Search Screen Settings 4-17
 Loading a Mark Screen 2-118
 Loading a Screen 2-116
 Logging Data Read Timing 10-31
 Logic Program Restrictions 10
 LS Area Filing Data Structure 10-5
 LT Editor Part Type Summary 2-2
 LT System Settings 6-7
 LT Type 1-5

M

Managing Filing Data in Group 10-3
 Manual Filing Data Transmission Example 2 10-15, 10-Placing a Part in Position 2-13
 16, 10-22
 Manual Symbols and Terminology 3
 Mark Drawing Area Structure 3-4
 Maximum Number of Automatically Created Part Libra
 2-12
 Memory Information 7-17
 Menu Bar 1-18
 Message Display [General Settings] Attributes 2-77
 Message Display [Messages] Attributes 2-79
 Mirror X, Mirror Y 3-18

Mode Settings 6-5
 Modifying Library File Names 2-161
 Modifying Library File Names (Titles) 2-161
 Monitor Bit Address 2-14
 Moving Symmetrically 2-143

N

n Pasting Other Software Bitmap Data 2-152
 Nesting 2-116
 No. of Display Digits 2-51
 Number of Copies 2-131, 2-136, 2-137
 Numeric Display [Alarm Settings] Attributes 2-74
 Numeric Display [Display Format] Attributes 2-73
 Numeric Display [General Settings] Attributes 2-73
 Numeric Display [Shape/Color] Attributes 2-74

O

Opening a New Screen 1-12
 Opening a Previously Saved Screen 1-13
 Operation Bit Address 2-14
 Operators 2-183
 Options Dialog Box 9-3
 overseas products 1

P

Pasting a Logic Program Instruction to the Screen 2-132
 Pasting a Part placed to the screen to a Logic Pro 2-134
 Pasting an Object 2-130
 PDB File 2-6
 Picture Display [Description] Attributes 2-88
 Picture Display [Library Image] Attributes 2-89
 Place File Name Display 2-64
 Placing a Bit Switch 2-16
 Placing a Date Display 2-84
 Placing a Keypad Display 2-53
 Placing a Message Display 2-80
 Placing a Numeric Display 2-75
 Placing a Picture Display 2-91
 Placing a Time Display 2-87
 Placing an Alarm Summary Display Area 2-59
 Placing the Data Logging Display 2-71
 PLC Type 1-5
 Precautions 8-2
 PREFACE 1
 Preparation 1-3
 Print Preview Screen 9-6
 Printing - [Print] Tab 9-2

Index

Printing - [Project Information] Tab 9-4
Printing - [Screen] Tab 9-5
Product Usage Precautions 8
Programming Functions 1-2
Project Manager Areas and Functions 1-18
Project Manager Errors 2
Pull-Down Menu: 1-18

Q

Quitting LT Editor 1-17
Quitting the Library Browser 2-174
Quitting the Screen Editor 1-16, 1-17

R

Rebuilding 4-13
Redrawing a Screen 2-156
Reflecting a Device Comment on the Parts List 2-222
Reflecting Device Comments 5-11
Reflection of a Device Comment 2-3
Reflection of a Device Comment 2-3
Reflection of Device Comments 2-138
Registering a Home Page Address 1-29
Registering a Password 7-7
Registering D-Script Editor 2-177
Registering D-Script Settings 2-177
Registering Data Sampling Settings 2-208
Registering Symbols and Device Comments 4-22
Rotating an Object 2-142

S

Safety Symbols and Terms 3
Sampling 2-210
Saving a Library File Under Another Name 2-173
Saving a Logic Program 1-11
Saving a Project 1-8, 1-9, 1-11
Saving a Project File under a Different Name 1-9
Saving a Screen 1-15
Saving a Screen under a Different Name 1-15
Scaling An Object 2-127
Screen Data Display 2-220
Screen Data List 2-219
Screen Editor Item Names 1-20, 1-23
Screens that can be loaded to other screens 2-115
Searching for a Topic and then Display Help 1-27
Searching for a Topic by a Keyword 1-28
Searching for a Topic from the Contents Menu 1-27
Selecting a Display Type 8-5
Selecting a Part Shape 2-6

Selecting an Existing Project 1-7, 1-8, 1-9, 1-11
Selecting Colors 2-7
Selecting Line Types 2-94
Sending Logic Programs 7-14
Setting Bitmap File Name 2-154
Setting Screen Property 2-215
Setting Screen Property - [Color] 2-218
Setting Up Data Sampling 2-212
Setting up the Device Memory 8-5
Simulation Protocol 8-8
Software and GP Setting Controls 9, 10
Spacing 2-137
Specifying Items to Be Copied 4-7
SRAM Information 4-36
Starting GP-PRO/PB III for Windows 1-4
Starting LT Editor 1-4
State 2-11
States 2-8
Status Bar: 1-18
Structure of the Manual 5
Style 2-112
Style (Font) 2-11
Switching Library Files 2-160
Symbol Editor Types 4-20

T

Text Attributes 2-111
Text Color (ON/OFF) 2-11
Tiling Patterns 2-95
Time Display [General Settings] Attributes 2-86
Tips for using the Pop-up Keypad 2-54
Title Bar: 1-18
Tool/Icon Display 1-25
TRADEMARK RIGHTS 2
Trademark Rights 2
Transfer Settings 7-4
Transferring a Screen to the Clipboard 2-153
Transferring a Screen Using a Password 7-11
Transparent/Background Color 3-20
Trigger 2-178
Troubleshooting advice 25
Turn Counterclockwise 3-18
Types of Editing Functions 2-119

U

Used Hairline Cursor 2-217
Using a Pop-up Keypad to Input Values 2-55
Using GP-PRO/PBIII for Windows Manuals 1-26