

Oregon Scientific™ OUTBREAKER Sports Watch (RX109 series)

User Manual

TABLE OF CONTENTS

Introduction	2
Key features	3
OUTBREAKER watch	3
Chest belt (RS109 / RP109 only)	3
Bicycle equipment (RP109 only)	3
PC Kit (RP109 only)	4
LCD display symbols	4
How the OUTBREAKER works	6
How the altimeter, thermometer and barometer work ...	6
A multi-system facility	6
TOUR Mode	6
PC Software Kit (RP109 only)	6
Getting started	7
Turn on the watch (first-time use only)	7
Batteries	7
Switch between Modes	8
Switch between Mode options	8
Change setting values	8
Use the HI-GLO backlight	8
Key lock	8
Handling the product	8

CLOCK Mode	9
Set clock and measurement units	9
Set the alarm	9
Stopwatch	9
Timer	10
Temperature display	10
ALTI-BARO Mode	10
Access altimeter options	11
Set current altitude and resolution	11
Set sea-level pressure	12
View sea-level pressure	12
Set altitude alert	12
Recall altitude data	13
Switch between view options	13
Weather forecast	13
TOUR Mode	14
TOUR memory	14
Activate TOUR Mode	15
Record markers in TOUR Mode	15
Pause TOUR Mode	15
Deactivate TOUR Mode	15
Clear all TOUR memories	16
CARDIO (Heart Rate) Mode (RS109, RP109 only)	16
Wearing the chest belt	17
Training Zones	17
Set upper and lower heart rate limits for Training Zone 5	18
Activate the Training Zone alarm	19
Track heart rate during training	19

BIKE Mode (RP109 only)	20
Set up for BIKE Mode	20
Step 1: Attach the equipment to the bicycle	20
Step2: Enter wheel circumference	21
Access the BIKE Mode options	22
View speed and cadence information	22
PC Kit (RP109 only)	22
PC Mode	23
Set up for PC Mode	23
Use the software	23
PC Mode options	23
Download data	24
Effective use and range	24
Aquatic and outdoor activities	24
Safety and care	25
Safety precautions	25
Care instructions	25
Troubleshooting guide	26
Specifications	27
Warnings	29
Declaration of conformity	29
Additional Resources	30

INTRODUCTION

Thank you for selecting the Oregon Scientific OUTBREAKER Sports Watch as your fitness product of choice. Your new sports watch is designed to give you many years of reliable service and includes the following features:

- Clock, calendar, stopwatch and timer functions
- Barometer with local and sea pressure readings
- Weather forecast and temperature readings
- Altimeter readings up to 9,000 meters (30,000 feet)
- Heart rate monitor that gives pulse rate readings during exercise (RS109/RP 109 only)
- Bicycle accessory kit to take readings during cycling (RP109 only)
- PC docking station and software to download readings onto your computer (RP109 only)

The OUTBREAKER RX109 sports watch series comprises the most advanced and patented Baro-compensation technology, distinguishing between barometric and altitude pressure changes, and giving you more reliable readings (weather forecasts, etc.). It is a precision device designed to augment your daily or weekly exercise program as well as provide you with accurate and easy to use watch functions.

This manual contains important safety and care information, and provides step-by-step instructions for using this product. Read the manual thoroughly, and keep it in a safe place in case you need to later refer to it.

KEY FEATURES

OUTBREAKER WATCH



ITEM	NAME	DESCRIPTION
1	SELECT/+>	Press to increase value, change Mode display, or record a marker during TOUR Mode.
2	MODE	Press to switch between Modes.
3	ST/SP/-	Press to start/pause/stop the Stopwatch/Timer or decrease value.
4	LIGHT/KEY	Press to activate HIGLO- backlight, or press and hold to activate key lock.
5	FUNC/SET	Press to enter a sub-mode or press and hold to change a value..

CHEST BELT



ITEM	NAME
1	CHEST BELT
2	STRAP

BICYCLE EQUIPMENT (RP109 ONLY)

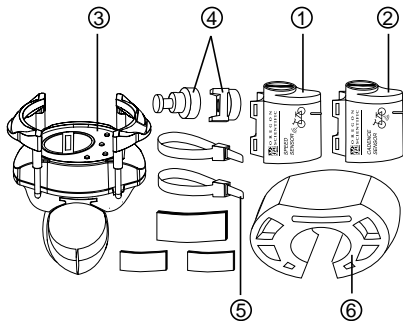

ITEM	NAME
1	SPEED SENSOR
2	CADENCE SENSOR
3	BIKE MOUNT
4	MAGNETS/ SCREWS/ NUTS/PADS
5	FIXING STRAPS
6	RUBBER GRIPS (RS109 only)

PC KIT (RP109 ONLY)

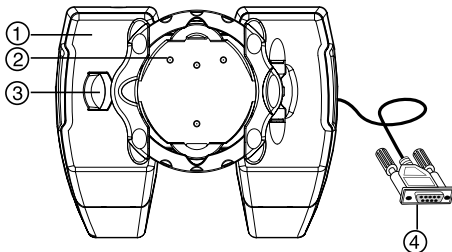





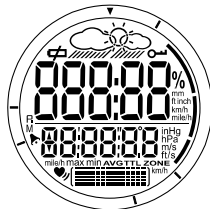





ITEM	NAME
1	DOCKING STATION
2	WATCH CONNECTION POINTS
3	MOUNTING CLIPS
4	BUILT-IN RS-232C COMPUTER CONNECTION CABLE
5	SOFTWARE CD-ROM

LCD DISPLAY SYMBOLS



SYMBOL	DESCRIPTION
00:00	The current time.
YR	Year setting.
MTH	Month setting.
DAY	Day setting.
MON (MON..SUN)	Current day of the week.
TRIP	TOUR Mode is running time/date cannot be set
HR	Hour setting.
MIN	Minute setting.
DM/MD	Order for date to be displayed.
TIME	Time zone setting screen.
SET	Displayed when in a setting mode.
UNIT	Set Celsius/Fahrenheit for temperature and h/p/Hg, inHg barometric pressure. Set m/ft for altitude.

Zone	The current time set in your second time zone.
AL	Shows alarm time, or event alarms (max/min altitude/heart rate etc)
 Max/Min Alt	Shows max/min altitude alarm is deactivated.
	Shows if alarm is on or off.
	Weather forecast for the next 12-24 hours. (Sunny/Slightly Cloudy/Cloudy/Rainy)
STW	Stopwatch can be started/stopped/reset.
TMR	Timer (countdown) can be started/stopped/reset
TEMP	Temperature is displayed (in lower second row).
ALTI	Altitude is displayed (in lower second row).
HR	Heart rate is displayed in lower matrix font.
MEM	Memory record (current trip only).
max	Shows maximum record
min	Shows minimum record
AVG	Shows average record
TTL	Show total record
RES	Change resolution of readings on altimeter
ICON	Choose current weather icon.
LOC	Local barometric pressure.
SEA	Sea pressure (barometric).
SPD	Shows vertical speed (historical or current).
	Graphical display of your bicycle speed.
Rxxx	Receiver (Bike Mount) low battery.

Sxxx	Speed sensor low battery.
Cxxx	Cadence sensor low battery.
ttl	Shows total time of activity.
	Shows altitude graphically.
	Heart rate (per minute) monitor activated.
	Heart rate alert in effect.
	Key lock activated.
Z1 (1-5)	Shows which training shown is currently selected.
	Shows heart beat graphically.
M1 (1..99)	Shows which record you are making, or storing (see TOUR Mode).
WØ (wheel icon)	Wheel circumference setting mode.
CAD	Pedal speed (revolutions/min).
T1 (1...99)	Shows sequence of memories in TOUR Mode.
88%	% of memory used in TOUR Mode.
END	TOUR is finished.
CLR	Ready to clear all tour memories.
donE	All tour memories have been cleared.
hpa	Pressure shown in Hecto-Pascal's.
inHg	Pressure shown in inches of mercury.
	Low battery level (replace batteries)

HOW THE OUTBREAKER WORKS

The OUTBREAKER sports watch comes equipped with a barometer (measuring altitude, barometric pressure, and weather conditions), a weather forecast display, a thermometer, a heart rate monitor (RS109/RP 109 only), and a bicycle computer to display information when cycling (RP109 only).

HOW THE ALTIMETER, THERMOMETER, AND BAROMETER WORK

The patented baro-compensation technology used in this watch allows it to distinguish between barometric pressure change and altitude pressure change. This means it can detect barometric pressure (localized weather conditions) as distinct from changes in altitude pressure, and gives more accurate readings than most average devices (which frequently rely on manual deactivation before initiating a new forecast).

A MULTI-SYSTEM FACILITY

The product is designed for use during many kinds of activity. It can display and store a range of information of interest to the casual and more serious sports or exercise enthusiast. The watch includes the following Modes: CLOCK, ALTIMETER, CARDIO (Heart Rate) (RS109/RP109 only), BIKE (RP109 only), and PC (docking station and CDROM are optional for the RA109 and RS109, and are not supplied). It is equipped with a multi-system facility that allows you to combine information according to your preference, such as altitude and time, altitude and heart rate, or bike speed and altitude, etc. You may also

use the stopwatch or timer (countdown) facility in combination with other functions, and both will continue to run in the background while you use other features of the watch.

The heart-rate monitor and altimeter features of the OUTBREAKER watch include customized settings. Maximum and minimum heart rate limits can be set for use during exercise, and the altimeter can be set to register ascending and descending limits. In both cases a short beep signifies either limit has been exceeded. The watch also has a clock, calendar, and pressure reading apparatus, all of which need to be set according to the current date and location.

TOUR MODE

The watch features a TOUR Mode in which you can record all data from a single trip, or workout, and then download this information onto your PC for storage and viewing. The watch can recall 99 different single tours, trips or workouts.

NOTE The docking station and CD-ROM are required (optional for the RA109 and RS109, but not supplied) to download information from TOUR Mode.

PC SOFTWARE KIT (RP109 ONLY)

A docking station is provided with the watch for connecting to a computer, along with a CD-ROM for installing the necessary software onto your computer. You can also use the software to change some of the watch settings.

NOTE The RZ910 PC Kit can be purchased separately for the RA109 and RS109.

GETTING STARTED

TURN ON THE WATCH (FIRST-TIME USE ONLY)





Press mode key for 2 seconds or more to activate the LCD Display

BATTERIES

All batteries are included and already installed. Refer to the Specifications page for battery types (→ 27).

NOTE To avoid the possibility of permanently damaging the watch, we strongly recommend that you take your watch to a local retailer or jeweler to have the watch battery replaced.

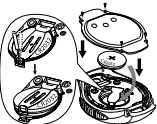
To load new batteries in the watch:

Diagram	Instructions
	1. Remove the watchband and screw pin.
	2. Remove the back cover with a small Phillips screwdriver.
	3. Install the battery by matching the correct polarity. Always use the correct battery type. Warning: Reversing the polarity may damage the product.
	4. Replace the cover, screws, screw pin, and watchband. (Be sure to replace the O ring properly).
	5. Check the replacement batteries are fitted properly by confirming there is a key tone (beep).

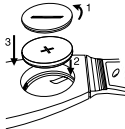

To load new batteries in the chest belt (RS109 and RP109 only) and bike mount:

NOTE The chest belt will stop sending signals if its battery is low. Bad transmission from the chest belt may also be the result of poor contact with the skin, surrounding interference, or placing the receiver watch too far away.

Diagram	Instructions
	1. Insert a coin into the groove. Turn counter-clockwise.
	2. Insert the battery. Match the correct polarity.
	3. Replace the battery compartment. Tighten into place.

To load new batteries in the bicycle sensors (RP109 Only):

NOTE The sensors will stop sending signals to the watch if their batteries are low.

Diagram	Instructions
	1. Insert a coin into the groove. Turn counter-clockwise.
	2. Remove the battery and insert a new one.
	3. Replace the compartment. Tighten into place.

NOTE Replace the batteries whenever the HIGLO backlight dims or stops working, or when you see the low battery icon.

The watch will show Cxxx, Rxxx or Sxxx whenever either the bike mount, cadence or speed sensor batteries are low.

NOTE Replace all the batteries at the same time – it is dangerous to mix old and new batteries.

NOTE Used batteries can be harmful to the environment, and should not be thrown out with household rubbish. Contact your local waste disposal authority for instructions on how to dispose of used batteries. Protect the environment by taking exhausted batteries to authorized disposal stations.

SWITCH BETWEEN MODES

Press the **MODE** button to switch between the Modes: CLOCK, ALTI-BARO, CARDIO (RS109/RP109 only), BIKE (**RP109 only**), and PC. A bar shows next to the appropriate Mode (on the outer ring of the LCD display) when it is selected.

SWITCH BETWEEN MODE OPTIONS

Press **SELECT/+** to switch between the options within a Mode.

CHANGE SETTING VALUES

Press and hold **FUNC/SET** for 2 seconds to enter setting mode. Then, press **ST/SP/-** or **SELECT/+** to change the value. Press **FUNC/SET** to switch between options, and to confirm the changes when you are done.

USE THE HI-GLO BACKLIGHT

Press **light/key** to turn on the HI-GLO backlight on for five seconds. Once the light is on, press any key to keep it on for a further five seconds.

In order to save power the light will not work when the battery is low. If this happens, change the battery as soon as possible.

KEY LOCK

The watch also has a key lock function to stop the buttons from being accidentally pressed during an activity. To activate it simply press and hold light/key until a small key icon appears in the right hand corner of the screen. The function keys are now useless. To reactivate them, press and hold **light/key** again until the key icon disappears.

NOTE The alarm will still go off while the Key Lock is activated. Pressing any key while in Key lock will stop the alarm.



HANDLING THE PRODUCT

The watch is designed to withstand a wide range of sports activities, and comes complete with a strong wristband. When riding (RP109 only), make sure the watch is firmly connected to the bike mount, and connect all bicycle equipment carefully and securely. See the BIKE Mode section (→ 20) for instructions.

CLOCK MODE

The time, date (including the day of the week) and time alarm can be set while the watch is in **CLOCK** Mode. Follow the instructions below to set or activate the time, date, zone time, metric or imperial standards, alarm time, stopwatch and timer.

SET CLOCK AND MEASUREMENT UNITS:

Diagram	Instructions
	1. Press MODE to display the CLOCK mode.
	2. Press and hold FUNC/SET for 2 seconds. "24h" will flash on the display.
	3. Press ST/SP/- to change from 24 hour to 12 hour time display. 4. Press FUNC/SET again. The hour will flash. Press SELECT/+ to move the value up, or ST/SP/- to move the value down. Tip: Continuously press and hold a button to fast-change the value.
	5. Repeat Steps 3 – 4 to change the rest of the settings, in this order: minutes, year, month/date or date/month display, month, day, time zone (+/- 23 hours), temperature display (°C / °F), measurement units (feet / meters), and barometric pressure units (inHg or hPa).

NOTE You cannot change these settings while in **TOUR** Mode. If you attempt to do so, **TRIP** will show on the display. Refer to the **TOUR** Mode section (→ 14).

SET THE ALARM

Diagram	Instructions
	1. Press MODE to display the CLOCK mode.
	2. Press SELECT/+ 3 times to move it into the alarm setting screen.
	3. Press ST/SP/- to activate or deactivate the alarm. A small bell icon will appear on the left side of the alarm time when it is activated.
	4. Press and hold FUNC/SET for 2 seconds, to set the alarm hour and minutes. Use the SELECT/+ or ST/SP/- buttons to change the value. (The alarm will be automatically activated once the alarm time is set).

STOPWATCH

The Stopwatch works in **CLOCK**, **ALTI-BARO**, **CARDIO**, and **BIKE** modes. From any of these modes, press **SELECT/+** to display the stopwatch. Then,



- Press **ST/SP/-** to start, pause, and stop the stopwatch.
- With the stopwatch stopped, press and hold **FUNC/SET** to reset.

NOTE You can switch to other modes while running the stopwatch in the background.

TIMER

The Timer works in CLOCK, ALTI-BARO, CARDIO, and BIKE modes. From any of these Modes, press **SELECT/+** to display the stopwatch. Press **FUNC/SET** to reset the Stopwatch, then:



- Press and hold **FUNC/SET** for 2 seconds. The display will change to TMR.
- Press **ST/SP/-** or **SELECT/+** to change a value.
- Press **FUNC/SET** to switch between values and accept changes.
- Press **ST/SP/-** to start or stop the timer.
- With the timer stopped, press and hold **FUNC/SET** to reset.

NOTE You can switch to other Modes while running the timer in the background.

NOTE To return to STW Mode, you must reset all the timer values to 0. The timer automatically switches to STW Mode when it reaches 0.

TEMPERATURE DISPLAY

The Temperature can be displayed in CLOCK, ALTI-BARO, CARDIO, and BIKE Modes. From any of these Modes, press **SELECT/+** to display the Temperature. The Temperature shows in either Celsius or Fahrenheit, depending on the measurement unit you select when setting the CLOCK (see CLOCK Mode).



NOTE Your wrist temperature may affect the reading, particularly during exercise. Take off the watch and leave it for 15 minutes to get the most accurate reading.

ALTI-BARO MODE

The OUTBREAKER sports watch includes a barometer that distinguishes between pressure caused by altitude changes and pressure caused by weather conditions. This technology reduces discrepancies in readings and makes the altimeter more accurate than most average devices.



The watch can store and recall the following values:

- Current altitude (updated every 2 seconds)
- Maximum / minimum altitudes attained during your a trip
- Total accumulated maximum / minimum altitudes attained during your trip

- Maximum / minimum altitude alert (sounds an alarm when exceeded)
- Maximum / ascending, maximum descending speeds
- Current vertical speed
- Rate of altitude change

The altitude is shown in two ways, as a numeric value indicating your current altitude, and as a bar chart indicating changes in altitude. Both values will change as you move about.

NOTE In ALTI-BARO Mode, the current altitude is always displayed in larger font, in every screen except the sea pressure-setting screen.

ACCESSING THE ALTIMETER OPTIONS

Press **MODE** to access the ALTI-BARO mode, then press **SELECT/+** to loop through the options.

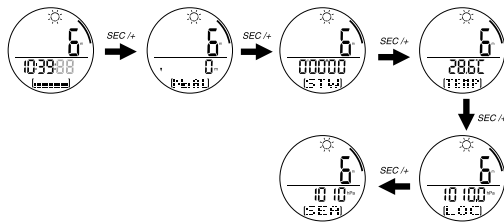

SET CURRENT ALTITUDE AND RESOLUTION

When you first use the watch, it is important to set the current altitude and local sea-level pressure so your ascending and descending altitude can be accurately measured. **You can find the current altitude by comparing your position to a topographical map, and then entering the value in the watch.**

NOTE It is necessary to reset the altitude after being in a pressurized chamber (such as an airplane).

For instructions on setting the sea-level pressure, refer to the next section.

Diagram	Instructions
	1. Press and hold FUNC/SET for 2 seconds while in ALTI mode.
	2. Use SELECT/+ or ST/SP/- to change the value. The value will change in unit increments based on the resolution you set (next step) and the measurement unit you selected when setting the CLOCK (→ 9).
	3. Press FUNC/SET to switch to the Resolution setting screen, then press ST/SP/- to change the value. The resolution is the increment at which the altitude will display: 3 / 10 ft, or 1 / 3 meters.
	4. Press FUNC/SET to exit the setting mode.

Tip: You can also set the current altitude and alarm limits with the help of the PC software (see PC section). **(RP109 only)**

NOTE The sea level pressure reading will change if the altitude is adjusted.

SET THE SEA-LEVEL PRESSURE

Sea level pressure can change relative to location. To achieve accurate altitude readings, set the sea-level pressure value before every trip. Check the newspaper, local news station, trail marker, or weather forecast for local readings, and always select the reading nearest to your present location.

Diagram	Instructions
	1. While in ALTI-BARO Mode, press SELECT/+ until the SEA (sea pressure) screen is shown.
	2. Press and hold FUNC/SET for two seconds, then use SELECT/+ or ST/SP/- to change the value. The value will change in increments of 1 hPa or .03 inHg, depending on the measurement unit you selected in CLOCK Mode (see CLOCK mode).
	3. Press FUNC/SET again when finished.

NOTE The altitude reading will change according to the sea level pressure adjustment.

VIEW THE SEA-LEVEL PRESSURE

To view a graphical image of the current sea level pressure reading, press **FUNC/SET** with the SEA screen shown in ALTI-BARO Mode. Press again to return to normal display.



SET ALTITUDE ALERT

The watch can be set to remember an altitude limit (either up or down, but not both simultaneously). If the alarm is activated, a series of beeps (at 5 second intervals) will sound, and the mode bar will blink, when you breach the limit. To end the alert, press any button.

To set the alert limits and activate or deactivate the alert:

Diagram	Instructions
	1. Press SELECT/+ until you reach the Alarm screen. (Display reads 'AL' or 'NoAL' at the bottom)
	2. Press and hold FUNC/SET for two seconds.
	3. You may set the arrow at the bottom of the screen to a <i>ascending</i> , or <i>descending</i> limit (but not both). To change direction, press SELECT/+ or ST/SP/- .
	4. Press FUNC/SET again, then press SELECT/+ or ST/SP/- to change the altitude limit. (The alarm will be automatically activated once the limits are set).
	5. Alternatively press ST/SP/- if you simply want to accept a preset altitude alert setting. (Activated [AL] or deactivated [NoAL]).

RECALLING ALTITUDE DATA

The OUTBREAKER allows you to track the following information as you exercise.

- Max / min altitude attained -- shows the highest or lowest point you have reached so far in relation to your watch's permanent altitude setting.
- Max / min altitude accumulated – represents the total distance you have ascended or descended; that is, every incline is added together or 'accumulated', and likewise every decline is added and 'accumulated', to give a total.
- Vertical speed -- how fast you are currently climbing
- Max ascending speed – fastest speed you have climbed
- Max descending speed – fastest speed you have descended

The following illustration shows these points:

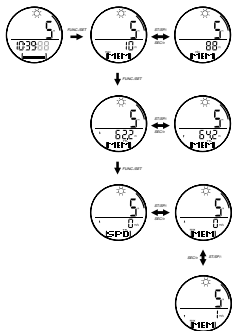

These display screens are shown in a loop, and the information in each screen is displayed for 30 seconds (excluding the ALT/SPD vertical speed screen, which is not on a timeout) at which point the watch returns to ALT Mode.

NOTE Clearing the memory allows you to start over again on a new trip, though all the information from your current trip will be lost.

SWITCH BETWEEN VIEW OPTIONS

While in ALT/TIME Mode, press **FUNC/SET** to switch between the view options: max / min altitude, total ascending / descending altitude, and speed. In the speed display, you can view current speed (ascending or descending), maximum ascending speed, and maximum descending speed.



Press **SELECT/+** or **ST/SP/-** to loop through the values for each option.

To clear a value from the memory, press and hold **FUNC/SET** for 2 seconds.

WEATHER FORECAST

The built-in barometer helps to forecast the weather for the next 12-24 hours. This reading is based on barometric pressure changes and has an effective range of 30 to 50 kilometers (18 – 31 miles). The patented baro-compensation technology in the OUTBREAKER watch allows it to differentiate between pressure changes due to altitude, and those due to weather changes. To avoid inaccurate forecasts, the watch will favor altitude readings when you are *actually* ascending or descending. This means the weather icon will disappear after significant vertical movements. To display an accurate forecast, simply remain at any fixed altitude for roughly 5 minutes.

You may wish to set the icon manually for these reasons:

- The speed in the change of icon forecast depends on the

speed of barometric change and in some cases may take longer (up to 24hrs) than desired.

- Setting the icon can speed up the adjustment for the weather forecast.
- It is necessary to set the icon after exposure to artificial environments, such as an airplane cabin, which may cause incorrect readings.

The forecast will be displayed at the top of the watch as one of these four icons:



The current barometric pressure reading (in hPa or inHg, depending on the measurement unit you set in CLOCK Mode) shows at the bottom of the display.

To set the weather icon manually, follow these instructions:

Diagram	Instructions
	1. While in the ALTI-BARO Mode, press SELECT/+ until LOC shows at the bottom of the display.
	2. Press and hold FUNC/SET for two seconds.
	3. Press SELECT/+ or ST/SP/- to change the icon.
	4. Press FUNC/SET to save your changes.

NOTE When functioning normally the watch automatically updates the forecast every 15 minutes.

TOUR MODE

There are two ways of using the memory on the OUTBREAKER. First, the watch computer will record information as you train, for display only. This means you can check the information during or after your exercise, but there will be no record once you clear the memory in preparation for your next training event.

To record and store this information (for up to 99 different trips, depending on the size of each record – see below) you must activate the TOUR Mode and view the records through the PC software.

NOTE The information from a TOUR can only be viewed through the PC software.

TOUR MEMORY

Tour mode allows you to record and store data displayed on the watch, which can then be downloaded onto your PC. Up to 99 TOURs can be recorded and stored to the PC software. Depending on the model you purchase, the information you choose to record (see below), and the time used by TOURs you have already stored on the watch, the available memory length may vary. The average memory storage capacities in real-time, (taking a data sample every 5 seconds), assuming default settings (see Specifications: Tour Mode) and no TOURs have been saved for each model are as follows:

Model	Total recording time available
RA109	598 min (10 hours)
RS109	508 min (8.5 hours)
RP109	659 min (11 hours)

The watch can record and store up to 99 different trips, providing there is enough remaining memory.

Default sampling time for readings in TOUR Mode is every 5 seconds. To increase the gap between samplings, and thus increase the memory capacity, you can adjust this setting through the PC software.

ACTIVATE TOUR MODE:

For best results, perform these steps immediately before you begin your trip.

1. Simultaneously press **FUNC/SET** and **MODE**. The TOUR END screen will display.
2. Press and hold **FUNC/SET** for two seconds. The TOUR number (T1, T2, etc.) will show at the bottom of the display. You are now recording information. The percentage (%) at the top indicates the total used memory.
3. To stop the TOUR, press and hold **FUNC/SET** for 2 seconds. END will show at the bottom of the display. The Tour data will be stopped.
4. To begin another TOUR, press and hold **FUNC/SET** for 2 seconds. The new TOUR number (T3, etc.) will show at the bottom of the display. You are recording information again.
5. Press **MODE** to return to the CLOCK display.

NOTE Used watch memory is given as a percentage. It is recommended that you download information to your PC and clear all TOUR memories when this figure approaches 100%. When the used memory hits 100% it will no longer record, and any future readings will not be recorded.

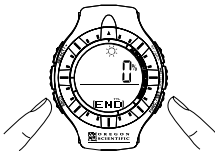

RECORD MARKERS IN TOUR MODE

The marker function is used to mark a particular position during a TOUR. To place a marker, press and hold **SELECT/+** when the TOUR Mode is in use.

NOTE The marker will only be shown in the PC data, once it has been downloaded from the watch.

PAUSE TOUR MODE:

1. If you are not already in TOUR Mode, simultaneously press **FUNC/SET** and **MODE**. The TOUR number will display. The percentage (%) at the top indicates the total used memory.
2. Press **FUNC/SET**. REST shows at the bottom of the display.
3. Press **ST/SP/-** to turn the rest on (paused) or off (recording).



DEACTIVATE TOUR MODE:

For best results, perform these steps immediately after you end your trip.

1. Simultaneously press **FUNC/SET** and **MODE**. The TOUR number will display. The percentage (%) at the top indicates the total used memory.

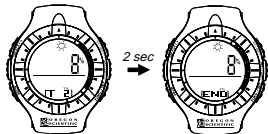

- Press and hold **FUNC/SET** for two seconds. This ENDS the TOUR recording session.
- Press **MODE** to return to the CLOCK display.

CLEAR ALL TOUR MEMORIES

For best results, perform these steps after you download TOUR information to the PC software.

Either:

- Download the information to you PC (the TOUR will be automatically cleared).

Or:

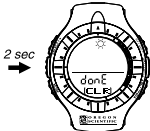
- Deactivate the TOUR Mode. With the END screen shown, press the **FUNC/SET** button. CLR shows at the bottom of the display.
 
- Press and hold **FUNC/SET** until donE shows at the bottom of the display.
 
- Press **FUNC/SET** again to display 0% and confirm all data has been cleared.
- Press **MODE** to return to the CLOCK display.

NOTE The maximum and minimum values for the various sub-modes (i.e., max heart rate, or max altitude, etc) will remain after all data has been cleared.

CARDIO (HEART RATE) MODE (RS109/RP109 ONLY)

The OUTBREAKER watch is equipped with a **CARDIO** Mode and heart rate chest belt, which together allow you to measure your heart rate (from 25-240 beats per minute) while exercising. You can track your heart rate while in the **ALTI-BARO**, **CARDIO**, or **BIKE** Modes, and with the following features: Stopwatch, Timer, Temperature, and Altimeter display.



There are five screens in the **CARDIO** Mode including the **HEART RATE/CLOCK/HR** chart (starting) screen. They are:

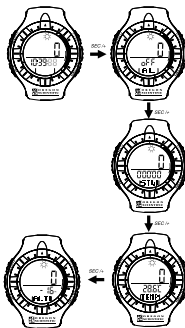

- **HEART RATE/CLOCK/HR** chart (starting) screen,
- **HEART RATE/HR** alarm on/off screen,
- **HEART RATE/STW** (stopwatch) screen,
- **HEART RATE/TEMP** (temperature) screen,
- **HEART RATE/ALTI** (altimeter) screen.

To move between them, simply press **SELECT/+**.

WEARING THE CHEST BELT

You must wear the chest belt to measure your heart rate.

NOTE This OUTBREAKER watch is specially designed to work with the chest belt with which it was sold. It is not recommended you use any other chest belt with this watch, as the transmission may not work.

Diagram	Instructions
	<ol style="list-style-type: none"> 1. Wet the conductive pads on the underside of the chest belt with few drops of water or a conductive gel to ensure a better, solid contact. 2. Put on the belt, wrapping it around the upper chest so the heart rate monitor is in the middle of the chest, tucked snugly under the pectoral muscles. 3. Adjust the belt for comfort and best contact with the skin.

Tips: The transmission from the belt is dependent on good contact with the skin and proximity to the receiver watch. Make sure the transmitting section of the belt is against the skin, not blocked by chest hair, and close enough to the receiver watch (approximately 30 inches) to send a clear signal. Sweat or gel can help to improve the signal, and remember it is not instantaneous. If no signal is received immediately, wait for a few seconds for the signal to get through.

NOTE An old battery may weaken the transmission and reception power. Replace the battery if the performance is progressively worse.

Once you have good contact with the chest belt, ♥ will begin to flash. This means the signal is being sent and your heart rate will soon appear in place of the large 0. Your heart rate will be displayed as the larger font in every screen of this Mode, and can also be displayed in a smaller font, below the line, while in BIKE Mode. If you remove the chest belt, or the watch is moved too far away from it, the signal will be broken.

NOTE The CARDIO Mode will stop functioning after no signal is received for 5 or more minutes.

NOTE When you are measuring your heart rate, keep the watch away from signal generating sources, such as TVs, PCs, and car engines, as these may impair the reading.

TRAINING ZONES

The OUTBREAKER watch is equipped with a special Training Zone feature that allows you to pre-select the optimal heart rate range (50-240 beats per minute) for your activity. For example, the amount of exertion required for a stroll in the park is different from the amount of exertion required for weight lifting to build muscle mass. With the Training Zone feature, you can set and then monitor the upper and lower heart rate limits (Training Zone) that best support your training activity and goals.



The calculation for determining your upper and lower heart rate limits is as follows.

Sex	Maximum Heart Range (MHR)	Lower limit	Upper limit
Men	220 - age = MHR	MHR x (lower training zone %)	MHR x (upper training zone %)
Women	230 - age = MHR		

Once you know your maximum heart range, you can set the 5 Training Zones (described below) with the PC software (refer to the online help). With the OUTBREAKER watch, you can directly set your upper and lower limits for Training Zone 5, and can set an alarm to sound whenever you exceed the limits for the selected Training Zone.

Warning: The heart rate limits for Training Zones 1 – 4 are based on the profile for a 20-year-old young man. If you do not meet this profile, we HIGHLY RECOMMEND that you either set the limits for Training Zones 1 – 4 using the PC software, or follow the steps below to set the limits for Training Zone 5.

The recommended Training Zones are as follows:

Zone	MHR range (min - max %)	Description
1	50 - 60%	Moderate Activity - This low-intensity zone is good for warm-ups, cool downs, and activities such as brisk walking. It is also good for beginners and those who want to strengthen their cardiovascular systems.
2	60 - 70%	Weight Management - Up to 85% of calories burned in this zone are from fat cells. Moderate exercises such as light jogging or swimming are good for this zone.
3	70 - 80%	Aerobic Zone - Increases strength and endurance. It works within the body's oxygen intake capability, burns more calories, and can be maintained for a long period of time.

4	80 - 90%	Anaerobic Zone - Generates speed and power. It works at or above the body's oxygen intake capability, builds muscle, and cannot be maintained for a long period of time.
5	90 - 100%	Red Line Zone - This high-intensity zone can only be maintained in short bursts or intervals, as it pushes your muscles and cardiovascular system beyond their capacity.

NOTE High-altitude activities may elevate your maximum heart rate.

NOTE You can override the zone preference by adjusting the value through the PC (all zones), or by manually adjusting Zone 5.

SET UPPER AND LOWER HEART RATE LIMITS FOR TRAINING ZONE 5

1. Press **MODE** to access the **CARDIO** (heart rate) Mode.
2. Press **SELECT/+** to switch to the **AL** (Alarm) setting.
3. Press and hold **FUNC/SET** for two seconds. The zone number will flash at the bottom of the screen. The upper limit is shown above the line in larger font, and the lower limit is below. (You may adjust the value for upper and lower rate limits in Zones 1-4 by using the PC software. Otherwise pressing **ST/SP/-** will simply activate or deactivate the preset alarm).
4. Press **SELECT/+** or **ST/SP/-** to switch to Zone 5.
5. Press **FUNC/SET** again to display the **SET** screen



- Press **SELECT/+** or **ST/SP/-** to change the upper heart rate limit.
- Repeat Steps 5 – 6 to set the lower heart rate limit.
- Press **FUNC/SET** when finished.

NOTE Heart rate range is between (upper 26-240 bpm) and (lower 25-239 bpm).

ACTIVATE THE TRAINING ZONE ALARM

Once activated, the Training Zone Alarm will sound whenever you exceed the upper or lower heart rate limits for the selected Training Zone.

- From the **CARDIO** Mode, press **SELECT/+** to switch to the **AL** (Alarm) screen.
- Press and hold **FUNC/SET** for two seconds.
- Press **SELECT/+** or **ST/SP/-** to select the desired Training Zone.
- Press **FUNC/SET**.
- Press **ST/SP/-** to turn the alarm off or on.

TRACK HEART RATE DURING TRAINING

To set up the **OUTBREAKER** watch so that it can track your heart rate activity during training, first do the following:

- Put on the chest belt (refer to the "Wearing the Chest belt" section).
- Press **MODE** to access the **CARDIO**



Mode and check to make sure the watch is receiving your heart rate signals.

- Select the Training Zone that is most appropriate for your activity (refer to previous section).
- Activate the Stopwatch or Timer in **CARDIO** Mode (refer to the Stopwatch / Timer section).
- Set up the **TOUR** Mode if you want to store a long-term record of your heart rate history that spans several training sessions or activities (refer to the **TOUR Mode** section).

Once you complete these steps, you are ready to begin exercising. After you finish, reset the Stopwatch or Timer to zero, then press **FUNC/SET** to have the following metrics displayed in 5-second intervals:

- Time and date in **M1** or **M2**....**M99** (all current data will be stored under **M1**, while previous data is stored under **M2** and so on until **M99**).
- Average heart rate during exercise and Total exercise time
- Upper Training Zone limit and time spent above limit
- Lower Training Zone limit and time spent below limit
- Total time spent exercising within the heart rate limits

NOTE If you have more than one set (**M1-M99**) of training records, press **SELECT/+** or **ST/SP/-** to loop through the records.

BIKE MODE (RP109 ONLY)

The OUTBREAKER sports watch comes complete with a bicycle computer (and accessories), which records and displays the following information:

- Speed: 0 – 255 km/hour or 0 – 158 mile/hour, depending on the measurement unit you select (refer to the **Clock Mode** section)
- Average speed (Max:255km/hr or 158 mile/hr)
- Maximum speed (Max:255km/hr or 158 mile/hr)
- Cadence: 0 – 255 rpm (pedal revolutions per minute)
- Distance traveled (Max:999.9 km or 620 miles)
- Total distance travelled (Max:99,999.9 km or 620,000 miles)
- Total time spent cycling

The BIKE Mode comprises pioneering technology that uses two wireless sensors instead of one. The high frequency of each sensor (868 MHz) eliminates possible interference between the cadence and signal sensors, ensuring you accurate performance measurements.

SET UP FOR BIKE MODE

To set up the BIKE Mode you must first do two things:

1. Attach the measuring equipment to your bicycle: speed sensor (front wheel), cadence sensor (pedal), two magnets (front wheel and pedal), and bike mount (handle bar). Refer to the next section for instructions.
2. Specify your wheel circumference. See below for instructions.

STEP 1: ATTACH THE EQUIPMENT TO THE BICYCLE

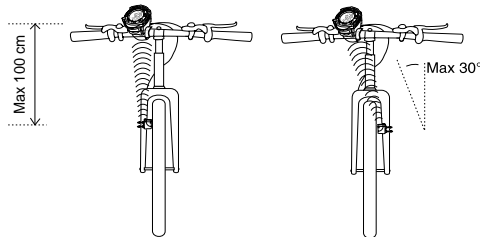
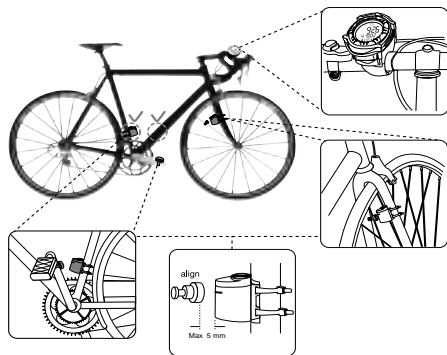

To attach the equipment:

1. Attach the bike mount to the right or left handlebar using rubber grip, nut and bolt provided. Tighten until the bike mount is fixed into place, using the rubber grip for a firmer contact.
2. Attach the cadence sensor to a stationary point just behind the pedal, using the rubber grip for a firmer contact. There should be maximum 100cm (39 inches) between the sensor and the bike mount, and less than 30 degrees vertical angle.
3. Attach the cadence magnet to a pedal so that it is directly aligned with the sensor with less than 5mm (0.2 inches) between.
4. Attach the speed sensor to either leg of the front forks, using the rubber grip for a firmer contact. There should be maximum 100cm (39 inches) between the sensor and the bike mount, and less than 30 degrees vertical angle.
5. Attach the speed magnet on a spoke of the front wheel so that it less than 5mm (0.2 inches) from the sensor.
6. Check and adjust as necessary, then snip the ends off the clips so that no excess remains.
7. Fit the watch into the bike mount.
8. Press **MODE** on the watch to switch to BIKE Mode.
9. Press **ST/SP/-** to activate signal reception. The display shows "--", then changes to 0 once a successful signal is received.
10. Ride the bike a short distance to make sure signals are being sent to the watch successfully.
11. You are now ready to begin your trip.

NOTE The watch can work with one or both sensors.

NOTE When the display shows a low battery icon  (see 'Battery' section) replace the battery for the corresponding unit.

STEP 2: ENTER WHEEL CIRCUMFERENCE

You must set the bike's wheel circumference on the watch so it can accurately calculate your speed and distance. If you do not know the bike's wheel circumference, you can check the manufacturer's specifications or measure it by marking the wheel where it touches the ground, and then rotating the wheel once fully along the ground. Measure the difference between the two marks.



NOTE Most wheels have their specifications written on them.

To specify this information on the watch:

1. Press **MODE** to switch to the BIKE Mode.
2. Press and hold **FUNC/SET** for 2 seconds.
3. Press **SELECT/+** or **ST/SP/-** to change the circumference (cm or inches, depending on the measurement unit you selected in CLOCK Mode).
4. Press **FUNC/SET** to save your changes.

NOTE You can also use the PC software for this operation (see PC section).

ACCESSING THE MODE OPTIONS

Press **MODE** to access the BIKE Mode, then press **SELECT/+** to loop through the options: Speed, Stopwatch/Timer, Temperature, Altitude, and Heart Rate.

For instructions on how to use the Stopwatch or Timer in BIKE Mode, refer to pp. 9 – 10.



VIEWING SPEED AND CADENCE INFORMATION

Press **MODE** to switch to the BIKE Mode. In the Speed display, you can view current speed (default view) and the following metrics from memory: total time spent cycling, total distance traveled, total TOUR distance traveled (TOUR Mode only, see TOUR section), average speed, maximum speed, and cadence (pedal revolutions per minute). Press **FUNC/SET** to loop through the values for each option.

To clear a value from a specific memory, press and hold **FUNC/SET** for 2 seconds.

PC KIT (RP109 ONLY)

The RP109 Oregon Scientific OUTBREAKER sports watch is equipped with a PC Kit that includes a PC Docking Station and CD-ROM for downloading information to a personal computer. Full instructions for using the software are provided in the online help and can be viewed once you have installed the CD-ROM.

NOTE The PC Kit for the RA109/RS109 series OUTBREAKER watch is sold separately. Contact the retailer or our website (www.oregonscientific.com) for more information about the RZ910 PC Kit.

The PC Kit enables you to store and recall most of the information that is collected by the OUTBREAKER watch. This allows you to free up the watch memory for recording more information, while preserving the training records that are most important to you. For example, with the PC Kit you can specify which information you want to record in TOUR Mode: By limiting what is recorded, you can keep longer records. This can be useful if you wish to monitor your performance during an extended period such as a two-day hike, where only heart rate and altitude are of concern, or a day of cycling, where only speed and distance are important to you. Full details of the watch's memory capacity are given in the TOUR MEMORY section.

You can also use the PC Hook-up Kit to set values on the watch through the PC. A full list of options is given at the end of this section.



NOTE The hardware/software requirements for the PC Kit are listed at the back of this manual.

PC MODE

SET UP FOR PC MODE

To use the features of the PC Mode, you will need the PC Kit (includes PC docking station, connector cable, and the installation software CD-ROM), and a PC or laptop computer.

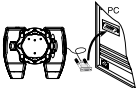
NOTE All three models (RA/RP/RS 109) support the PC Mode. However, the PC Kit for the RA109 and the RS109 is sold separately.

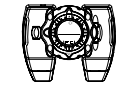
Diagram	Instructions
	1. Connect the PC Docking Station to your computer. For best results, turn the computer off before you connect.
	2. Install the software using the CD-ROM (first-time use only). The process is automatic, and requires you to respond to self-explanatory prompts. Once the software is installed, an Oregon Scientific icon will be placed on your desktop.
	3. Mount the watch on the docking station, making sure the contact points on the station and the watch are aligned. The watch should automatically switch to PC Mode. NOTE The cadence, speed and heart rate functions will be temporarily disabled when you use the watch in PC Mode.

USING THE SOFTWARE

Double-click on the Oregon Scientific icon. Once the software opens, click on **Help** for information about the function you require.



PC MODE OPTIONS

You can perform the following tasks by using the CD-ROM software supplied.

Access/recall information/ on the PC	Change watch settings on the PC
<ul style="list-style-type: none"> All information recorded in TOUR Mode, including temperature, altitude, heart rate, wheel speed, cadence, trip distance, etc, [Provided this data has been selected in "Data should be stored" in the "Configuration menu" (see software help menu)]. Back up/import and export data Define user data Display graphical chart and print table Give data overview with a specified duration 	<ul style="list-style-type: none"> Date and time (set to PC time, or a manual setting) Time, and event alarm (3 event alarms, 1 daily alarm, and select alarm duration) Current sea-level pressure Altitude limits Weather icon Upper and lower heart rate limits for Training Zones 1 – 5. Wheel circumference/diameter TOUR Mode data recording and download options Choose a serial port (Com 1 to Com 4) Sampling rate (1 second and up) Unit settings (Metric or Imperial)

NOTE To send all selected settings and preferences to the watch select “Transfer configuration” in the “communication” sub-menu (PC software).

DOWNLOAD DATA

Follow these procedures to download data

1. After installing the CD-ROM click the OUTBREAKER icon on your PC.
2. In the main menu, select “Communication”.
3. Connect the docking station to your PC.
4. Press “Mode” until you reach PC Mode.
5. Fit the OUTBREAKER watch in the docking station, making sure the pins are matched and secured.
6. Close the cover gently and select “Connect” in the “Communication” sub-menu.
7. You will see an arrow mark on the watch, and “download in progress” on your PC.
8. Select “Read Trip Data” in the “Communication” sub-menu, then follow the on screen instructions.
9. Select “Format” to process the data arrangement.
10. Download is now complete. Select desired graphical report.

EFFECTIVE USE AND RANGE

The watch and heart rate chest belt have a maximum transmission range of about 76 centimeters (30 inches). If the signal is weak take the following steps:



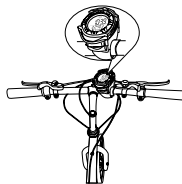

- Shorten the distance between the heart rate chest belt and watch
- Re-adjust the position of the heart rate chest belt
- Check the batteries. If they are low or exhausted, change the battery immediately

You can wear the receiver watch on your wrist or strap it to a bike or exercise machine as shown below:



AQUATIC AND OUTDOOR ACTIVITIES

The watch is water-resistant up to 50 meters. The chest belt and other accessories (bike mount/speed and cadence sensors) are splash-proof up to 10 meters, but should not be worn for underwater activities, as the heart rate transmission cannot work properly under water. Refer to the table below for guidelines.

	 RAIN SPLASHES, ETC	 SHOWERING (WARM / COOL WATER ONLY)	 LIGHT SWIMMING / SHALLOW WATER	 SHALLOW DIVING / SURFING / WATER SPORT	 SNORKELING / DEEP WATER DIVING
30m / 100ft	OK	OK	NO	NO	NO
50m / 165ft	OK	OK	OK	NO	NO
100m / 325ft	OK	OK	OK	OK	NO

When using the watch for outdoor sports activities, observe the following guidelines:

- Do not press the buttons underwater or with wet fingers.
- Rinse with water and mild soap after use.
- Do not use the watch in hot water.

Tips for keeping your watch fit: Keep your watch water resistant! Avoid chemicals (gasoline, chlorine, perfumes, alcohol, hair sprays, etc.). Rinse after use. Reduce exposure to heat. Have your watch serviced by an approved service center once yearly.

SAFETY AND CARE INSTRUCTIONS

SAFETY PRECAUTIONS

Please observe these safety precautions when using this product.

- Do not consult the watch while moving or engaging in active sports. Doing so may result in a collision that causes personal injury.
- Do not subject the product to excessive force, shock, dust or temperatures.
- Do not tamper with the product's internal components.
- Do not mix fresh and old batteries, or batteries of different specifications.
- Do not use this watch as a substitute for professional measuring devices used in skydiving, hang gliding, paragliding, gyrocopter piloting and flying small aircraft.
- Do not use this watch as a substitute for industrial precision instruments.
- Follow the water-resistance guidelines carefully before use in water (see Effective Use and Range section).
- Keep the product away from heat sources such as radiators, stoves, heaters, and other heat-generating products.

CARE INSTRUCTIONS

To ensure you receive the maximum benefit from using this product, please observe the following guidelines.

- **Cleaning** – Clean with a damp cloth. Do not use liquid cleaning agents, benzene, thinner, or aerosols.
- **Repair** – Do not attempt to repair the product or modify the circuitry by yourself. Contact the retailer or a qualified repairman if the product requires servicing. Only use replacement parts that are recommended by the manufacturer.
- Do not scratch hard objects against the LCD display as this may cause damage.

TROUBLESHOOTING GUIDE

This section includes a list of frequently asked questions for problems you may encounter with the OUTBREAKER sports watch. If your watch is not operating as you think it should, check here before arranging for servicing.

Problem	Symptom	Check this	Remedy
No power	Power will not turn on.	Batteries are exhausted.	Replace with new batteries.
		Batteries are inserted incorrectly.	Insert the batteries correctly (→7).
	Keys do not respond	Key lock in operation. (Key icon shown)	Press key/lock for 2 seconds (Key icon will disappear).
Date / time is wrong	Date display is wrong	Date not set	Set date correctly (→9) Cannot be changed when TOUR Mode is operating.

Problem	Symptom	Check this	Remedy
	Time display is wrong	Time zone set incorrectly	Reset time zone Cannot be changed when TOUR Mode is operating.
Altitude reading is strange	Reading is less than 0 (-20, etc.)	Current altitude is below ground, (watch sea level setting)	Reset watch, or accept reading
	Different height reading at same point after trip	Barometric changes	Minor pressure changes may produce minimal deviations in altitude readings
No altitude alarm	Alarm does not sound	Levels not set	Set levels (→ 12)
Temperature reading is strange	Too high	Watch is too close to body	Take off watch, wait 15 minutes, then try again
No weather reading	Weather icon disappears	Height displacement (Vertical movement)	Remain at fixed altitude for 5 minutes
Wrong unit reading (imperial/metric)	Incorrect unit setting	Unit settings	Set units (→ 9)
No alarm	Expected alarm does not sound	Levels not set	Set levels (→ see relevant MODE Section)
		Alarm not activated	Activate alarm (→ see relevant MODE section)
Pressure reading is strange	Too high or low	Is change due to wind, pressurized chamber, or pressurized environment (airplane)?	Reset after you have changed locations

Problem	Symptom	Check this	Remedy
Heart icon not working	Blank display	Time out due to 5 minutes of inactivity	Press MODE to return to CARDIO Mode
		Chest belt is too far from watch or poor skin contact	Move chest belt closer or adjust contact with skin
No heart rate alert	Expected alarm does not sound	Training Zone/Alert limits not set	Set limits (→ 18)
No heart rate memory	No heart rate data	Chest belt is too far from watch or poor skin contact	Move chest belt closer or adjust contact with skin
No bike reading/ Strange reading	No data	Sensor not ready	Check distance between sensor and magnet
	Rx/Cx/Sx shown	No battery	Replace batteries (→7)
	No display	Watch not activated	Press ST/SP/- Display shows "- -" then "0"
	No TOUR data stored	Disabled feature through PC	Re-select check box in PC software
Strange reading	Wrong wheel size set	Measure and set wheel diameter again	
Strange reading (continued)	Sensors fitted incorrectly	Check sensor fittings	
		Magnet not aligned	Realign magnet
Strange reading (continued)	Interference	Find source and move or switch off	
No sensor power	Rx/Sx/Cx displayed in BIKE mode	Battery low or empty	Replace battery
No memory	Empty memory, or used memory % unchanged	Tour mode not set	Set tour mode
		100% of memory used	Memory full

NOTE Data manually erased cannot be recalled or recovered.

SPECIFICATIONS

Calendar Clock

Hour format	12/24 hr
Date format	DD:MM:YY or MM:DD:YY
Auto calendar Alarms	2000-2099 1 daily (hr:min) 3 event (hr:min DD.MM.YY)
Chronometer/Timer	99:59:59 (hr:min:sec)

Heart Rate Monitor

Heart rate range	25...240 beats per minute (bpm)
Resolution	1 bpm
Accuracy	+/- 1 bpm
Training zones	5
HR alert range	26...240 bpm (upper) 25...239 bpm (lower)
Alert memory	3 heart rate alarms
TOUR memory	99 max (RS109/RP109 only)

Thermometer

Range	-10.0° C...60.0° C (14.0° F...140.0° F)
Resolution	0.1° C (0.2° F)
Accuracy	+/- 1° C (+/- 2° F)

Altimeter

Range	-400...9,000 meters (-1,312...30,000 feet)
Resolution	1 or 3 m (3 or 10 ft)
Accuracy	+/- 10 m (+/- 30 ft)
Vertical speed	0...125 m/sec (0...415 ft/sec) (ascending or descending)

Vertical speed resolution	1 m/sec (3 ft/sec)
Max altitude change	1 m/sec (3 ft/sec)
Total altitude change	+/- 60,000 m (+/- 180,000 ft)
Alerts	1 alarm

Barometer

Local pressure range	300...1100 hPa (8.86...32.46 inHg)
Sea level pressure range	900...1100 hPa (26.58...32.46 inHg)
Resolution	1 hPa (0.03 inHg)
Accuracy	+/- hPa (+/- 0.1 inHg)
Bar graph x-resolution	1 hour
Bar graph y-resolution	1 hPa (0.02953 inHg)

TOUR Mode

OUTBREAKER RA109	
Record time:	598 min
5 second samplings:	Altitude / Barometer / Temperature

OUTBREAKER RS109

Record time:	508 min
5 second samplings:	Heart Rate / Altitude / Barometer / Temperature

OUTBREAKER RP109

Record time:	659 min
5 second samplings:	Distance / Cadence / Speed / Heart Rate/ Altitude / Barometer /

Temperature

BIKE Computer

Wheel speed range	255 km/hr (158 mile/hr)
Wheel speed resolution	1 km/hr (1 mile/hr)
Cadence range	0...255 revolutions per minute (rpm)
Cadence resolution	1 rpm
Max trip distance	999.9 km (620 miles)
Max total trip distance	99,999.9 km (62,000 miles)
Wheel circumference	1,000...3,000 mm (39 in...118 in)
Circumference resolution	1 mm (0.04 in)
Bike sensor RF	868 MHz

Environment

Operation	-10° C...60° C (14° F...140° F)
Storage	-20° C...70° C (-4° F...158° F)
Relative Humidity	10%...95%

Water Resistance

Watch	not actuating keys to 50 m (165 ft)
Other accessories	splash proof

Power

Watch	1 x CR2032 3V lithium battery
Chest belt	1 x CR2032 3V lithium battery
Bike mount	2 x CR2032 3V lithium battery
Cadence sensor	2 x LR44 1.5 V alkaline battery
Speed sensor	2 x LR44 1.5 V alkaline battery

WARNINGS

To ensure you use your product correctly and safely, read these Warnings and the entire user manual before using the product. The warnings given here provide important safety information and should be observed at all times.

- Do not attempt to repair the product yourself. Contact the retailer or our customer service department if it requires servicing.
- Take precautions when handling all battery types. They can cause injuries, burns, or property damage as a result of contact with conducting materials, heat, corrosive materials or explosives. Remove the batteries before storing the product for long periods of time.
- The product is a precision instrument. Never attempt to take this device apart. There is a serious danger of powerful electric shocks.
- Do not, under any circumstances, touch the exposed electronic circuitry of the device as there is a danger of electric shock should it become exposed.
- Take special care when handling a damaged LCD display, as the liquid crystals can be harmful to your health.
- Do not use or store the device, including the remote sensor, in locations that may adversely affect the product such as, snow, desert, and magnetic fields.
- Do not use this device in aircrafts or hospitals. The use of radio frequency products can cause malfunctions in the control devices of other equipment.

- Do not subject the product to impact or shock.
- Check all major functions when the device is unused for a long period of time. This is to ensure its full operation. Maintain a regular internal testing and cleaning of your device.
- When disposing of this product, do so in accordance with your local waste disposal regulations.

DECLARATION OF CONFORMITY

This product contains the approved transmitter & receiver that comply with the essential requirements of Article 3 of the R&TTE 1995/5/EC Directives, if used as intended and the following standards have been applied:

Safety of Information technology equipment (Article 3.1.a of the R&TTE directive)

Applied Standards: IEC 60950

Electromagnetic compatibility (Article 3.1.b of the R&TTE directive)

Applied Standards EN 301 489-3: (2000)

Efficient use of the radio frequency spectrum (Article 3.2 of the R&TTE directive)

Applied Standards EN300 330-2: (2000)

Additional Information: The product herewith complies with the requirements of the Low-Voltage Directive 73/23/EEC and the

EMC Directive 89/336/EEC and carries the CE 0359 (!) marking accordingly.

Hereby, IDT Technology Limited declares that this low power radio equipment is in compliance with the essential requirements and other relevant provisions of R&TTE Directive 1999/5/EC.

VS-Villingen / Germany March 2003

Gerhard Preis

EC representative of manufacturer

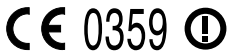

R&TTE Compliant Countries:
All EC countries, Switzerland **CH**
And Norway **N**

ADDITIONAL RESOURCES

Visit our website (www.oregonscientific.com) to learn more about your OUTBREAKER sports watch and other Oregon Scientific™ products such as digital cameras, hand-held organizers, alarm clocks, and weather stations. The website also includes contact information for our customer service department, in case you need to reach us.