

E-KB04 User Manual

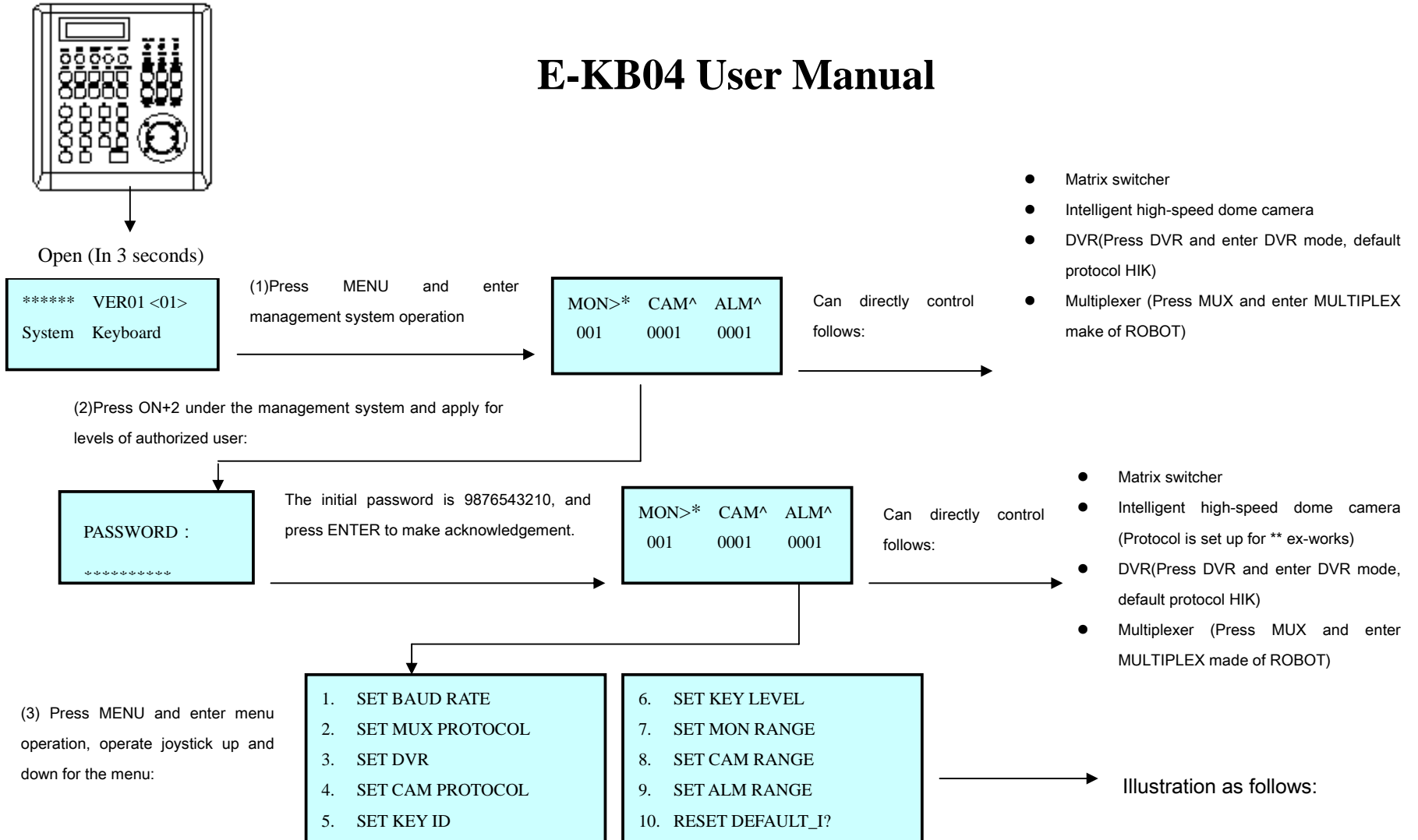

Simplified Description of Menu

1. SET BAUD RATE: Set up baud rate of communication, Baud rate of 9600BPS has been setup ex-works. After selection of band rate, press ENTER to make acknowledgement, or press CLR to exit the setting.

SET BAUD RATE
9600bps

2. SET MUX PROTOCOL: Select the relative protocol for the current multiplexer, so as to control the multiplexer. Protocols of ROBOT, ** have been set up ex-works. Default protocol is ROBOT. Any other protocol of MULTIPLEX is required, please contact the suppliers. Select the protocol by rotating the joystick. After selection of protocol, press ENTER to make acknowledgement or press CLR to exit the setting.

SET MUX PROTOCOL
ROBOT

3. SET DVR: Select the protocol for the current DVR, so as to control the DVR. Protocols of HIK, ** have been set up ex-works. Default protocol is HIK. Any other protocol of DVR is required, please contact the suppliers.

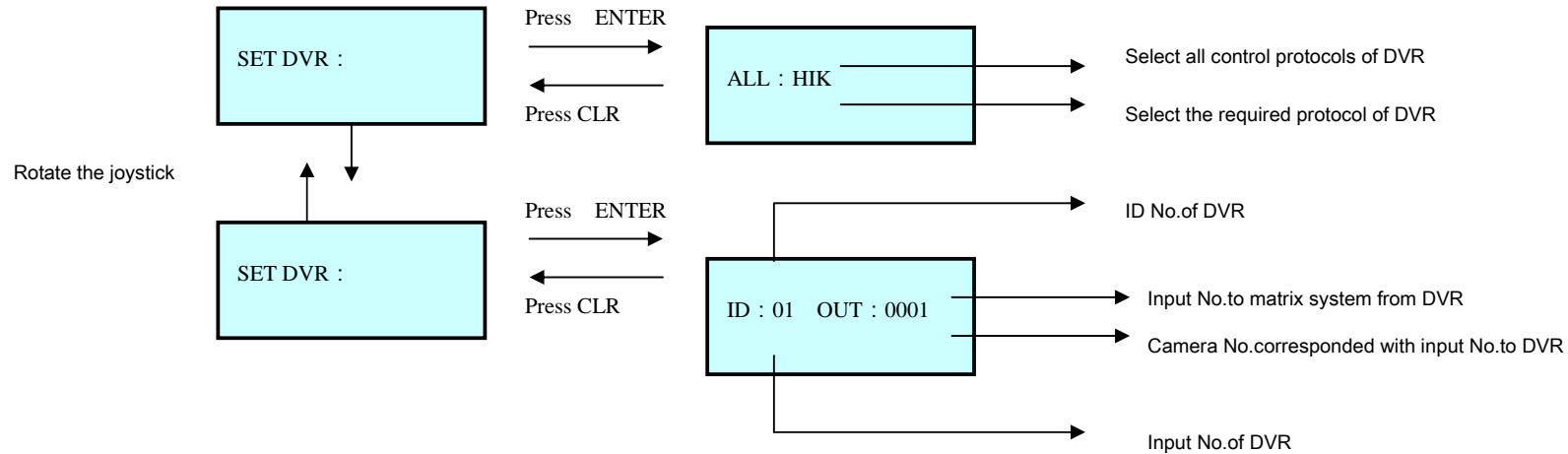

Note: Rotate the joystick to select the required protocol and input address No by digit-key. After selection of the protocol, press ENTER to make acknowledgement or press CLR to exit the setting.

4. SET CAM PROTOCOL: Select protocol for the cameras

Protocols of **, Pelco-D, Pelco-P, Panasonic, Samsung, DM have been set up ex-works. Default protocol is **. Any other protocol of camera is required, please contact the suppliers.

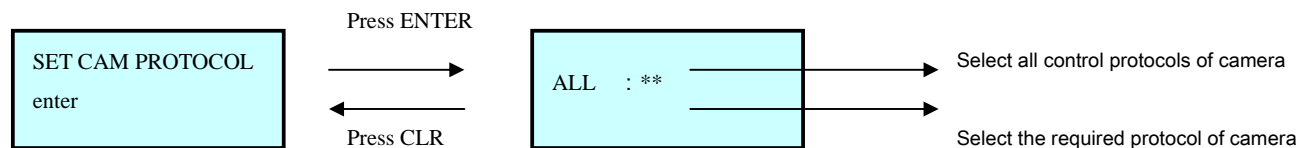

Rotate the joystick to select the required protocol and input address No by digit-key. After selection of the protocol, press ENTER to make acknowledgement or press CLR to exit the setting.

5. SET KEY ID: Set up the ID of the controller from 01 to 63.

Input to ID by digit-key. After setting, press ENTER to make acknowledgement or press CLR to exit the setting.

SET KEY ID
01<01—63>

6. SET KEY LEVEL: Set up the control levels of the controller from 00 to 15.

Input level No. by digit-key. Note the lower No is the higher level. After setting press ENTER to make acknowledgement or press CLR to exit the setting.

SET KEY LEVEL
01<00—15>

7. SET MON RANGE: Set up the range of monitors from 0000 to 0239.

Input monitor No. by digit-key. After setting, press ENTER to make acknowledgement or press CLR to exit the setting.

SET MON RANGE
0000 — 0239

8. SET CAM RANGE: Set up the range of the intelligent dome cameras from 0000 to 9999.
Input camera No. by digit-key. After setting, press ENTER to make acknowledgement or press CLR to exit the setting.

SET CAM RANGE

0000 — 9999

9. SET ALM RANGE: Set up the range of alarm positions from 0000 to 9999.
Input alarm No. by digit-key. After setting, press ENTER to make acknowledgement or press CLR to exit the setting.

SET ALM RANGE

0000 — 9999

10. RESET DEFAULT_I?: Select the default code. The default code is 0123456789 ex-works.
Input the default No. by digit-key. After setting, press ENTER to make acknowledgement or press CLR to exit the setting.

RESET DEFAULT_I?

Input the default No by digit-key from 0 to 9, press
ENTER.

RESET DEFAULT_I?

PLEASE WAIT...

NOTE:

**After setting and save, the controller is available. Only the band rate of communication needs restarting.
Others need not restart!!!**

Simplified Description of Setting and Operation for DVR on the Controller

1. Press DVR to switch DVR's operating surface or front-end camera control surface.

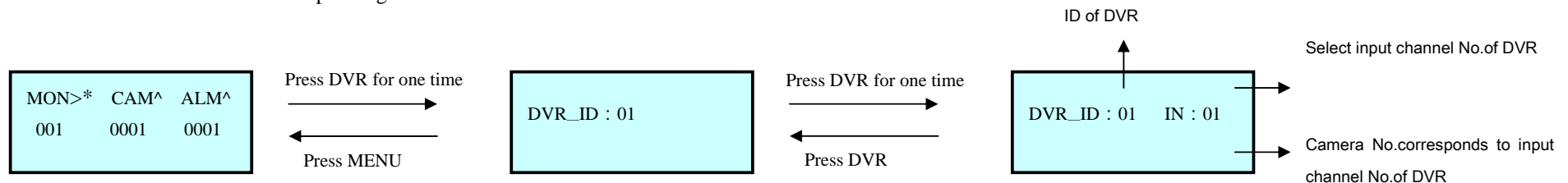

2. Under the state of DVR, press NEXT to select ID of the current DVR. One who has authority of management can setup input channel No.of DVR corresponding to camera No. (Setting is also available in main menu.)

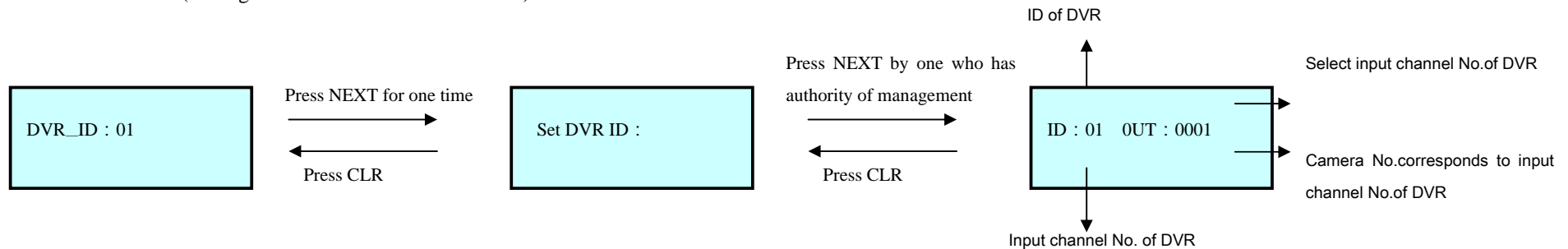

3. Under the state of DVR, press RUN to display the DVR's ID of control protocol and baud rate of communication.

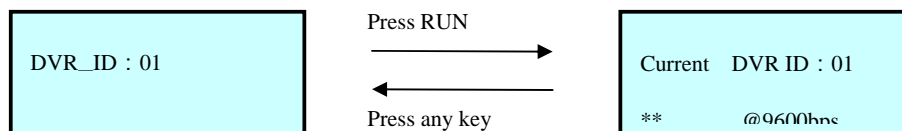

Simplified Description of Setting and Operation for Multiplexer on the Controller

1. Press MUX to switch Multiplexer's operating surface or front-end camera control surface.

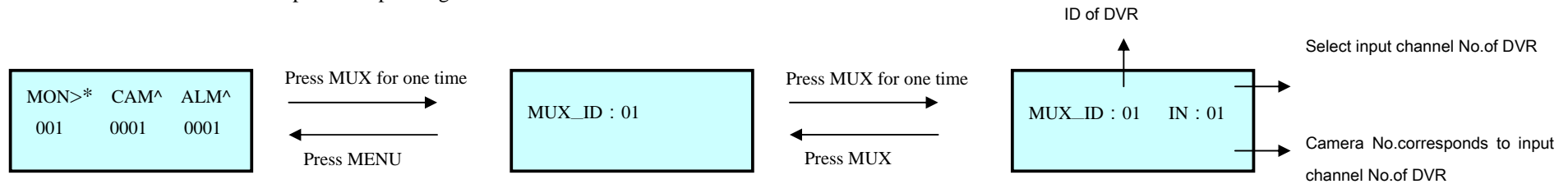

2. Under the state of Multiplexer, press NEXT to select ID of the current Multiplexer. One who has authority of management can setup input channel No.of Multiplexer corresponding to camera No.

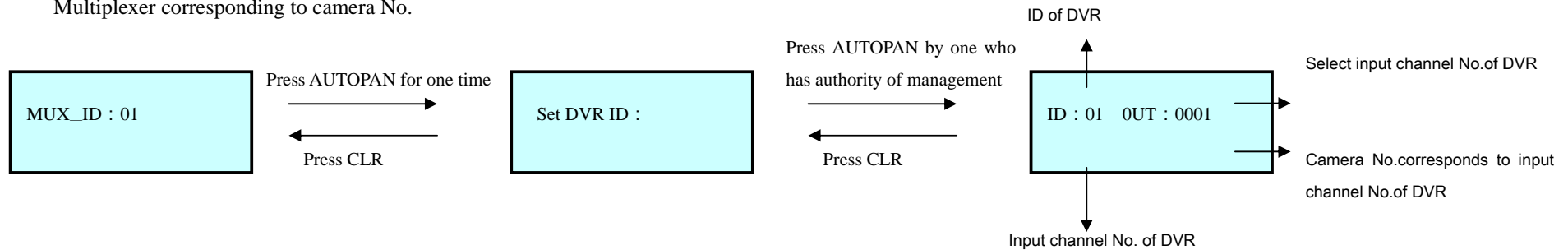

3. Under the state of Multiplexer, press AUX to display the Multiplexer's ID of protocol and baud rate of communication.

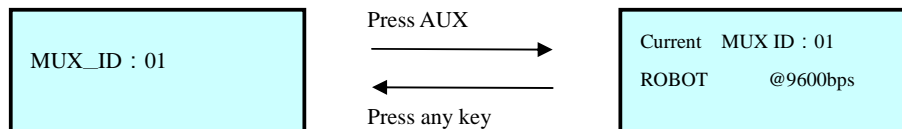

Simplified Description of Inquiry of Setting State and Relevant Hardware of the Controller

Under the state of non-setting, press SHOT+CAM to display the current camera's ID of protocol and band rate of communication. Press any key to exit.

```
Current Cam : 0001
**          @9600b
```

Description of indicator:

Red (POWER)	Power indicator	Green (SYS)	System state indicator
Yellow (DVR)	DVR indicator	Green (Rx)	Communication receiving indicator
Green (MUX)	Multiplexer indicator	Green (Tx)	Communication emission indicator

Under working state of the controller, the power indicator lights. When communication signal is received, green (Rx) indicator will be glittering. When communication signal is emitted, green (Tx) indicator will be glittering. If DVR, Multiplexer and system are working, the relevant indicators light.

The movement (up, down, left, right) of the joystick can control the relevant action of the cameras. Rotate the joystick to control the zoom of lens.

Camera protocol and band rate are arranged in pairs as follows:

```
Pelco-P  ———> 2400bps/4800bps/9600bps/19200bps
Pelco-D  ———> 2400bps/4800bps/9600bps/19200bp
**       ———> 9600bps
Panasonic ———> 9600bps
Samsung  ———> 9600bps
```

(Details see the relevant of camera manual)

Description of Operation Keys of the Controller for Matrix for User

No.	Keys of the controller	Usage
1)	MON+N+ENTER	Select monitor(N=0~239)
2)	CAM+N+ENTER	Select camera
3)*	ON+MON+N+ENTER	--N=0:Set up defence of current alarm
		--N=1:Date&Time Display_On
		--N=2:Address Info Display_On
4)*	OFF+MON+N+ENTER	--N=0:Dismantle defence of current alarm
		--N=1:Date&Time Display_Off
		--N=2:Address Info Display_Off
5)	GRP+N+ENTER	Access switching mode
		--N=1~128: Program_Mode
		--N=129: Sequence_Mode
		--N=130: BackWard_Mode
		--N=131~134:Group_Mode
6)*	CAM+N+ON	Insert camera in auto switching
7)*	CAM+N+OFF	Delete camera in auto switching
8)*	MON+N+RUN	Set up the dwell time of auto switching
9)	RUN	Run auto switching
10)	HOLD	Hold auto switching
11)	PREV	Manual previous switching
12)	NEXT	Manual next switching
13)*	ALM+N+ON	Set up defence of alarm
14)*	ALM+N+OFF	Dismantle defence of alarm
15)	ALM+N+ENTER	Query alarm status
16)*	AUX+N+ON	Open auxiliary relay
17)*	AUX+N+OFF	Close auxiliary relay
18)	AUX+MON+OFF	Lock current monitor
19)	AUX+MON+ON	Unlock current monitor
20)*	ON+N+ENTER	Close Relay No. n
21)*	OFF+N+ENTER	Open Relay No. n
22)	STAR(*)	Reply alarm info, etc
23)	SHOT+MON+N+ENTER	Access switching mode
24)*	MON+MENU	Enter Menu
25)*	MON+ENTER	Enter Sub Menu
NOTE:	1) One who has authority of management can set up “*”.	
	2) The above mentioned is only operation of the controller. Detail functions please refer to the manual. (Attached with Matrix)	

Description of Operation Keys of the Controller for Camera for User

No.	Keys of the controller	Usage
1) *	SET+N+ENTER	Set preset N
2)	SHOT+N+ENTER	Go To Preset N(N=0:Start Sequence Prepos)
3)*	SET+N+ON	Insert Prepos In Stack
4)*	SET+N+OFF	Delete Prepos From Stack
		--N=0: Delete all Prepos From Stack
5)*	SET+N+SET	Set Stack Dwell time
6)*	SET+ON	Set up AUTO_PANING Start LIMIT
7)*	SET+OFF	Set up AUTO_PANING End LIMIT
8)*	SET+N+SHOT	Set up speed of AUTO_PANING(N=1~9)
9)	AUTOPAN	Run AUTOPAN
10)	ON+CAM+ENTER	Unlock current camera
11)	OFF+CAM+ENTER	Lock current camera
12)*	ON+CAM+N+ENTER	Open CAM Auxiliary
13)*	OFF+CAM+N+ENTER	Close CAM Auxiliary
For 12)&13)		--N=0:Set up/Dismantle terminal alarm
		--N=1 ~ 8:Open/Close auxiliary Switch
		--N=9:Auto/Manual Focus
		--N=10:Auto/Manual Iris
14)*	CAM+MENU	Enter Camera Menu
15)	CLOSE+N (simultaneously)	CLOSE @ Speed N(N=1~9)
16)	OPEN+N (simultaneously)	OPEN @ Speed N(N=1~9)
17)	NEAR+N (simultaneously)	NEAR @ Speed N(N=1~9)
18)	FAR+N (simultaneously)	FAR @ Speed N(N=1~9)
19)	TELE+N (simultaneously)	TELE @ Speed N(N=1~9)
20)	WIDE+N (simultaneously)	WIDE @ Speed N(N=1~9)
21)	SET+N+CLOSE+ENTER	Set Close Speed N(1~9)
22)	SET+N+OPEN+ENTER	Set Open Speed N(1~9)
23)	SET+N+NEAR+ENTER	Set Near Speed N(1~9)
24)	SET+N+FAR+ENTER	Set Far Speed N(1~9)
25)	SET+N+TELE+ENTER	Set Tele Speed N(1~9)
26)	SET+N+WIDE+ENTER	Set Wide Speed N(1~9)
NOTE:	1) One who has authority of management can set up “*”.	
	2) The above mentioned is only operation of the controller. Detail functions please refer to the manual. (Attached with Camera)	

Description of Operating Keys for Pelco-p & Pelco-d

No.	Keys of the controller	Usage
1)	SET+N+ENTER	Set Preset
2)	CLR+N+ENTER	Clear Preset
3)	SHOT+N+ENTER	Go To Preset
		--N=1~32:PRESET
		--N=33: Flip (180° about)
		--N=34: Go To Zero Pan
		--N=92: Set Left Limit Stop
		--N=93: Set Right Limit Stop
		--N=94: Remote Reset
		--N=95: Enter Menu Mode
		--N=96: Stop Scan
		--N=97: Begin Random Scan
		--N=98: Begin Frame Scan
--N=99: Begin Auto-scan		
4)	N+ON	Set Auxiliary
5)	N+OFF	Clear Auxiliary
6)	SET+CLR+ENTER	Remote Reset
7)	SET+N+ON	Set Zone Start
8)	SET+N+OFF	Set Zone End
9)	CLR+OFF	Clear Screen
10)	AUX+ON	Zone Scan On
11)	AUX+OFF	Zone Scan Off
12)	SET+ON	Set Pattern Start
13)	SET+OFF	Set Pattern Stop
14)	CAM+RUN	Run Pattern
15)	SET+N+ZOOM	Set Zoom Speed (N=0~3)
16)	SET+N+FOCUS;	Set Focus Speed(N=0~3)
17)	SET+RUN	Start Sequence Prepos
18)	ON+N+SET	Insert Prepos In Stack
19)	CLEAR+N+SET	Delete Prepos From Stack
20)*	OFF+SET	Clear Seq. Stack
21)	SHOT+SET	Show Seq. Stack
22)	SET+N+SET;	Sequence dwell time(N=0~255)
23)*	ON+N+OFF	Home function
24)	SET+N+AUTOPAN	AUTO_PANING SPEED(N=0~255)
25)	ON+N+AUTOPAN	AUTO_PANING LIMIT(1LEFT/2RIGHT)
26)	AUTOPAN	AUTO_PANING START

27)	SET+AUTOPAN+N+ENTER	SET TILT SPEED(N=0~255)
28)	SET+SET+AUTOPAN+N+ENTER	SET PAN SPEED(N=0~255)
		(MUST SET PAN_SPEED FIRST THEN TILT_SPEED)
29)	CAM+ON	CAMERA ON
30)	CAM+OFF	CAMERA OFF
31)	ON+AUTOPAN	AUTO SCAN
32)	OFF+AUTOPAN	MANUAL SCAN
NOTE:	1. One who has authority of management can set up.	
	2. The protocol of non-original Pelco products is not as same as above protocol. Please refer to the dome camera manual.	

Description of Operating Keys for DVR of **

Keys of the controller	Usage	Display
CLOSE/DEL	Delete	DEL
ALM	Record	RECORD
ON	Play	PLAYBACK
SET	Set up	SETUP
SHOT	Back up	BACKUP
NEAR	Format	PIC_FORMAT
1	1	D1
2	2	D2
3	3	D3
4	4	D4
5	5	D5
6	6	D6
7	7	D7
8	8	D8
9	9	D9
0	0	D0
FAR	Switching	PIC_LOOP
MON	Chinese	CHINA
CAM	point	POINT
WIDE/PgUp	Previous page	PAGEUP
TELE/PgDn	Next page	PAGEDOWN
Joystick UP	Up	UP
Joystick DOWN	Down	DOWN
Joystick LEFT	Left	LEFT
Joystick RIGHT	Right	RIGHT
OPEN/BACK	Return	BACK
ENTER	Acknowledgment	ENTER
AUX	Frame progress	FRAME
OFF	Fast forward	FORWARD
GRP	Fast reword	BACKWARD
AUTOPAN	Pause	PAUSE
CLR	Alarm clear	ALARM_CLEAR
*	Information	INFO
HOLD	lock	LOCK
NOTE: The above mentioned is only operation of the controller. Detail functions please refer to the manual. (Attached with relevant device)		

Description of Operating Keys for DVR of HIK

Keys of the controller	Usage	Display
Joystick UP	Up	UP
Joystick DOWN	Down	DOWN
Joystick LEFT	Left	LEFT
Joystick RIGHT	Right	RIGHT
0+1	1	1
0+2	2	2
0+3	3	3
0+4	4	4
0+5	5	5
0+6	6	6
0+7	7	7
0+8	8	8
0+9	9	9
1+0	10	10
1+1	11	11
1+2	12	12
1+3	12	13
1+4	14	14
1+5	15	15
1+6	16	16
AUTOPAN	Editing	EDIT
PREV	Multiples display	VIEW
AUX	Display channels of camera inputs of DVR	A
ON	Play	PLAY
ALM	Record	REC
CAM	P/T control	PAN
SET	System menu	MENU
Joystick UP	Alter setting	UP
Joystick DOWN		DOWN
Joystick LEFT	Select items of setting	LEFT
Joystick RIGHT		RIGHT
ENTER	Acknowledgement	ENTER
CLEAR	Exit	ESC

NOTE: The above mentioned is only operation of the controller. Detail functions please refer to the manual. (Attached with relevant device)

Description of Operating Keys for Multiplexer of ROBOT

Keys of the controller	Usage	Display
UP	Up	UP
DOWN	Down	DOWN
LEFT	Decrease	DEC
RIGHT	Increase	INC
ENTER	Acknowledgement	ENTER
CLEAR	Exit	EXIT
SET	Menu	MENU
RUN	Picture in picture	PIP
MON	Call back	CALL
NEXT	Switching	SEQ
CLOSE	Play	PLAY
TELE	Zoom	ZOOM
HOLD	Frozen	FROZEN
OPEN	2*2	2*2
FAR	3*3	3*3
WIDE	4*4	4*4
1	1	1
2	2	2
3	3	3
4	4	4
5	5	5
6	6	6
7	7	7
8	8	8
9	9	9
10	10	10
11	11	11
12	12	12
13	13	13
14	14	14
15	15	15
16	16	16
*	Chooses digit	--/
<p>NOTE: 1) Under the mode of multiplexer, there are 16 frames of pictures. Press ‘*’ to select unit frame. Press ‘**’ to select Two-digits frames.</p> <p>2) The above mentioned is only operation of the controller. Detail functions please refer to the manual. (Attached with relevant device)</p>		

Description of Operating Keys for Intelligent Dome Camera of SAMSUNG

No.	Keys of the controller	Usage
1)	0+ENTER	K_0
2)	1+ENTER	K_1
3)	2+ENTER	K_2
4)	3+ENTER	K_3
5)	4+ENTER	K_4
6)	5+ENTER	K_5
7)	6+ENTER	K_6
8)	7+ENTER	K_7
9)	8+ENTER	K_8
10)	9+ENTER	K_9
11)	ON+GRP	SCAN_START
12)	OFF+GRP	SCAN_STOP
13)*	ON+SET	MENU_ON
14)*	OFF+SET	MENU_OFF
15)	ENTER	ENTER
16)	SHOT+N+ENTER	PRESET_MOVE(N=0~127)
17)	ON+AUTOPAN	AUTOPAN_START
18)	OFF+AUTOPAN	AUTOPAN_STOP
19)	ON+N+AUX	PATTERN_START(N=0~3)
20)	OFF+N+AUX	PATTERN_STOP(N=0~3)
21)	0+CLEAR+SET	RESET
22)	100+CLEAR+SET	FACTORY_RESET
23)	SET+N+ENTER	PRESET_SAVE(N=0~127)
24)	CLEAR+N+ENTER	PRESET_DELETE(N=0~127)
25)	1+FAR	ONE FAR
NOTE:	1) One who has authority of management can set up “*”.	
	2) The above mentioned is only operation of the controller. Detail functions please refer to the manual. (Attached with Camera)	

Description of Operating Keys for Intelligent Dome Camera of PANASONIC

NO	Keys of the controller	Usage	Function
1	SHOT+N+ENTER	PRESET 1 CALL	PRESET CALL
		PRESET 2 CALL	
		~	
		PRESET 63 CALL	
		PRESET 64 CALL	
2	ON+AUTOPAN	AUTO PAN ON	AUTO PAN
3	OFF+AUTOPAN	AUTO PAN OFF	
4*	1+AUTOPAN	AUTO PAN SPEED INC	
5*	2+AUTOPAN	AUTO PAN SPEED DEC	
6*	3+AUTOPAN	AUTO PAN START POINT SET	
7*	4+AUTOPAN	AUTO PAN END POINT SET	
8*	5+AUTOPAN	AUTO MODE OFF	
9*	6+AUTOPAN	AUTO SEQ ON	
10*	7+AUTOPAN	AUTO SORT ON	
11*	8+AUTOPAN	AUTO PAN SWEEP AREA INVERT	
12*	1+ON	ENDLESS ON	ENDLESS
13*	1+OFF	ENDLESS OFF	
14*	2+ON	DIGITAL FLIP ON	DIGITAL FLIP
15*	2+OFF	DIGITAL FLIP OFF	
16*	3+ON	PROPORTIONAL P/T ON	PROPO . P/T
17*	3+OFF	PROPORTIONAL P/T OFF	
18	4+ON	SUPER-DII ON	SUPER-DII
19	4+OFF	SUPER-DII OFF	
20*	5+ON	STOP AF ON (MENU ITEM)	AF
21*	5+OFF	STOP AF OFF (MENU ITEM)	
22*	5+SHOT	1 SHOT AF ON (START)	
23*	6+ON	HOME POSITION MOVE	HOME POSITION
24*	7+ON	BW ON (MENU ITEM)	BW
25*	7+OFF	BW OFF (MENU ITEM)	
26*	7+SET	BW AUTO (MENU ITEM)	
27*	8+ON	CAMERA ID ON	CAMERA ID
28*	8+OFF	CAMERA ID OFF	

29*	9+ON+SET	AREA TITLE NESW ON	AREA TITLE
30*	9+ON_SHOT	AREA TITLE USER ON	
31*	9+OFF	AREA TITLE OFF	
32*	10+ON	EL-ZOOM ON	EL-ZOOM
33*	10+OFF	EL-ZOOM OFF	
34*	11+ON	REFRESH	REFRESH
35*	SET+N+ENTER	PRESET1 SET	PRESET STORE
		PRESET2 SET	
		~	
		PRESET63 SET	
		PRESET64 SET	
36	12+ON	PATROL PLAY	PATROL
37	12+OFF	PATROL STOP	
38*	12+SET	PATROL LEARN	
39	OPEN	IRIS OPEN	IRIS
40	CLOSE	IRIS CLOSE	
41	IRIS+FREE	IRIS STOP	
42*	0+IRIS	IRIS RESET	
43	13+ON	SHUTTER ON	SHUTTER
44	13+OFF	SHUTTER OFF	
45	13+TELE	SHUTTER INC	
46	13+WIDE	SHUTTER DEC	
47	14+ON	AGC ON	
48	14+OFF	AGC OFF	
49*	15+ON	SENS UP FIX ON	SENS UP FIX
50*	15+OFF	SENS UP FIX OFF	
51*	15+TELE	SENS UP FIX INC	
52*	15+WIDE	SENS UP FIX DEC	
53*	16+ON	SENS UP AUTO ON	SENS UP AUTO
54*	16+OFF	SENS UP AUTO OFF	
55*	16+TELE	SENS UP AUTO INC	
56*	16+WIDE	SENS UP AUTO DEC	
57*	17+TELE	LL Phase INC	LL phase
58*	17+WIDE	LL Phase DEC	
59*	18+ON	180 deg pan turn	180 deg pan turn
60*	19+ON	CLEANING ON (MENU)	CLEANING
61*	19+OFF	CLEANING OFF (MENU)	
62*	0+AUX+ON	AUX ALL ON	RECEIVER FUNCTION COMMAN
63*	0+AUX+OFF	AUX ALL OFF	

64*	1+AUX+ON	AUX 1 ON	
65*	1+AUX+OFF	AUX 1 OFF	
66*	2+AUX+ON	AUX 2 ON	
67*	2+AUX+OFF	AUX 2 OFF	
68*	1+AUX+SHOT	AUX 1 MOMENTARY	
69*	1+AUX+SET	AUX 1 LATCH	
70*	2+AUX+SHOT	AUX 2 MOMENTARY	
71*	2+AUX+SET	AUX 2 LATCH	
72*	*+CAM+SET	SETUP MENU ON	MENU
73*	*+CAM+CLR	SETUP MENU OFF	
74*	0+SET	SETUP MENU [Cursor STOP]	
75*	JOYSTICK_UP	SETUP MENU [Cursor UP]	
76*	JOYSTICK_RIGHT	SETUP MENU [Cursor Right]	
77*	JOYSTICK_DOWN	SETUP MENU [Cursor Down]	
78*	JOYSTICK_LEFT	SETUP MENU [Cursor Left]	
79*	ENTER	SETUP MENU SET1	
80*	CLR	SETUP MENU SET2	
81*	1+CAM+SET	SETUP MENU SW (RESET)	
82*	0+CAM+SET	SETUP MENU SW (ALL RESET)	
83*	0+CAM+ON	Menu ON	
84*	0+CAM+OFF	Menu OFF	
NOTE:	1) One who has authority of management can set up “*”.		
	2) The above mentioned is only operation of the controller. Detail functions please refer to the manual. (Attached with Camera)		

Description of Operating Keys for Intelligent Dome Camera of Dyna Color

No.	Keys of the controller	Usage
1)	SET+N+ENTER	SET PRESET N(0~127)
2)	CLEAR+N+ENTER	CLEAR PRESET N(0~127)
3)	SHOT+N+ENTER	GO TO PRESET N(0~127)
4)	AUTOPAN+N+ON	RUN SEQUENCEN(0~7)
5)	N+AUTOPAN	RUN CRUISE(0:autopan,1:cruise)
6)	SHOT+N+SHOT	GOTO PRESET N WITH MAXSPEED(0-127)
7)	AUTOPAN+CLEAR	TOUR STOP:STOP PAN/TILT/ZOOM/IRIS
8)	SET+N+AUX	SET CRUISE MEMORIZE(0:START,1:STOP)
9)	SET+N+RUN	SET JOYSTICK CONTROL MODE (1:ON,0:OFF)
10)	SET+N+FAR+ENTER	SET FOCUS SPEED(0:SLOW,3:FAST)
11)	SET+N+WIDE+ENTER	SET ZOOM SPEED(0:SLOW,3:FAST)
12)	SET+N+CLOSE+ENTER	SET PAN SPEED(0~15)
27)	SET+N+OPEN+ENTER	SET TILT SPEED(0~15)
28)	ON+OPEN	AUTO IRIS
29)	ON+FAR	AUTO FOCUS KEY_ON
30)	OFF+FAR	AUTO FOCUS KEY_OFF
31)	SHOT+FAR	AUTO FOCUS_FROM_TABLE
32)	CAM+ON	CAM ID DISPLAY_ON
33)	CAM+OFF	CAM ID DISPLAY_OFF
34)	CAM+SET+ON	CAM TITLE DISPLAY_ON
35)	CAM+SET+OFF	CAM TITLE DISPLAY_OFF
36)	OFF+WIDE	DIGITAL ZOOM OFF
37)	ON+N+WIDE	DIGITAL ZOOM ON (2-8)
38)	AUTOPAN+N+SET	AUTO_FLIP ON/OFF(1:ON,0:OFF)
39)	SET+MON+CLEAR	REMOTE RESET
40)	SHOT+ENTER	GOTO HOME POSITION
41)*	SET+N+SHOT	SET PRESET N TO HOME POSITON(0~127)
42)	SET+N+SET	LINE_LOCK TIMING ADJUSTMENT(0:INCREASE,1:DECREASE)
43)	SHOT+N+ALM	GOTO ALARM POINT
44)	N+ON+ALM	SET ALM PRESET REMAIN_TimeN(1~255)

45)	N+OFF+ALM	SET ALM PRESET RELEASE_TimeN(1~255)
46)	N+ON+AUX	SET AUX N ON (N:0~7)
47)	N+OFF+AUX	SET AUX N OFF (N:0~7)
48)	SET+AUTOPAN+N+ON	SET START/END POINT FOR AUTOPAN (0/1:START/END)
49)	N+SET+AUTOAN	SET ROTATIONAL DIRECTION FOR AUTOPAN(0:RIGHT,1:left)
50)	SET+N+AUTOPAN	SET SPEED FOR AUTOPAN(SPEED N=0~3)
51)	ON+N+CAM	HOME FUNCTION ON,DELAY_ND(1~127)MINUTES
52)	OFF+N+CAM	HOME FUNCTION OFF,DELAY_ND(1~127)MINUTES
53)*	SET+CAM+N+ENTER	ENTER MENU N: N=1:1)Fill Preset into Sequence
		2)Set Sequence Dwell time
		3)Set Sequence Speed
		N=2:Set Alarm Point
		N=3:Set OSD Camera
NOTE:	1) One who has authority of management can set up “*”.	
	2) The above mentioned is only operation of the controller. Detail functions please refer to the manual. (Attached with Camera)	