DEFENDER™ **SECURITY**

82-13100 & 82-13105

User Manual



Please read before installing and using this product.

Damages caused by non-compliance with this operating manual will void the warranty! We will not assume any liability for damages to items or persons caused by improper handling or non-compliance with the safety notices! Any warranty claim will be null and void in such cases.

1. Do not drop, puncture or disassemble the camera or receiver; otherwise the warranty will be voided.
2. Avoid all contact with water, and dry hands before using.
3. Never tug on the power cords. Use the plug to unplug it from the wall outlet.
4. Do not expose the DVR to high temperature or leave it in direct sunlight. Doing so may damage the DVR or cause DVR temporary malfunction.
5. Use the devices with care. Avoid pressing hard on the DVR body.
6. For your own safety, avoid using the DVR or power off the DVR when there is a storm or lightning.
7. Remove the power adapter during long periods between usages.
8. Use only the accessories and power adapters supplied by the manufacturer.
9. To meet the regulations pertaining to parental responsibility, keep the devices out of the reach of infants.
10. Check power cables, do not get crushed or damaged by sharp edges whenever the devices are in operation.



FCC Compliance Statement: This device complies with Part 15 of the FCC Rules. Operation is subjected to the following two conditions: (1) this device may not cause harmful interference, and (2) this device must accept any interference received, including interference that may cause undesired operation.



Products with CE Marking comply with EMC Directive (2004/108/EC); Low Voltage Directive (73/23/EEC); R&TTE(1999/5/EC) issued by the Commission of the European Community. Compliance with these directives implies conformity to the following European Norms:
EMC: EN 301 489
LVD: EN 60065
Radio: EN 300 328

FCC/CE WARNING

This equipment has been tested and found to comply with limits for a Class B digital device, pursuant to Part 15 of the FCC rules and ETSI (EN) 300328. These limits are designed to provide reasonable protection against harmful interference in residential installations. This equipment generates, uses, and can radiate radio frequency energy and if not installed and used in accordance with the instructions, may cause harmful interference to radio communications. However, there is no guarantee that interference will not occur in a particular installation. If this equipment does cause interference to radio or television equipment reception, which can be determined by turning the equipment off and on, the user is encouraged to try to correct the interference by one or more of the following measures: -Reorient or relocate the receiving antenna. -Move the equipment away from the receiver. -Plug the equipment into an outlet on a circuit different from that to which the receiver is connected. -Consult the dealer or an experienced radio/television technician for additional suggestions. You are cautioned that any change or modifications to the equipment not expressly approved by the party responsible for compliance could void Your authority to operate such equipment.

Disposal

If the devices system no longer functions or can no longer be repaired, it must be disposed of according to the valid statutory regulations. Disposal of spent batteries / accumulators:



You are required by law (Battery Ordinance) to return all spent batteries and accumulators. Disposing of spent batteries/accumulators with common household waste is prohibited! Batteries/accumulators that contain hazardous substances are marked with the symbols on the side. These symbols indicate that it is prohibited to dispose of these batteries/ accumulators in the household waste. The abbreviations for the respective heavy metals are: Cd= cadmium, Hg= mercury, Pb= lead. You can return spent batteries and accumulators that can no longer be charged to the designated collection points in your community, outlets or wherever batteries or accumulators are sold. Following these instructions will allow you to fulfill the legal requirements and contribute to the protection of our environment!

CONTENTS

1 INTRODUCTION	5
1.1 Feature.....	5
1.2 Product feature	5
1.2.1 Parameter	5
2. ENVIRONMENT ADAPTABILITY.....	5
2.1 Notice:	5
3. Device operation manual.....	6
3.1 Remote key instruction	6
3.1.1 Remote control.....	6
3.1.2 Mouse Operation.....	7
3.1.3 Menu Configuration.....	9
3.2 System Operation	10
3.2.1 START-UP	10
3.2.2 SYSTEM LOGIN	10
3.2.3 GUI OPERATION.....	11
4. IE OPERATION	31
FEATURE	Error! Bookmark not defined.
4.2 Restriction condition.....	31
4.3 User login	31
4.4 OPERATION INTERFACE	32
4.4.1 LIVE.....	32
4.4.2 PTZ CONTROL.....	33
4.4.3 ZOOM.....	33
4.4.4 Focus.....	33
4.4.5 Iris.....	33
4.4.6 PTZ PRESET	33
4.4.7 PLAY	33
4.4.8 OTHER OPERATION	34

4.4.9 REPALY	34
4.4.10 SETUP	36
4.4.11 RECORD.....	36
4.4.12 ALARM SETTING	36
4.4.13 PTZ.....	37
4.4.14 NETWORK.....	37
4.4.15 System setting.....	38
4.4.16 HOST INFO.....	38
5. DVR Installation Guideline.....	Error! Bookmark not defined.
5.1 Product Overview.....	Error! Bookmark not defined.
5.1.1 Product Photo	Error! Bookmark not defined.
5.1.2 The Definition of Bottoms and Connectors on Front Panel.....	39
5.1.3 The definition of buttons and connectors on rear panel	40
5.1.4 Connectors for Alarm	41
5.1.5 Alarm Input and Output.....	41
5.1.6. System Network Diagram	42
5.2 HDD Installation	42
5.3 Wireless Setting	Error! Bookmark not defined.
6. Device Part	44
6.1 Check Device part.....	44
7. FAQ.....	45

1 INTRODUCTION

1.1 Feature

The model 82-13100 and 82-13105 four and eight channel DVRs are capable of simultaneously recording at 30fps per channel. These DVRs feature pentaplex operation (simultaneous local recording, playback, remote network surveillance, data backup, and monitoring), and facilitate easy parameter settings, space-saving motion detection recording, I/O alarm functionality, PTZ connections and settings, and a USB mouse.

1.2 Product feature

- ◆ Advanced RTOS
- ◆ H.264 compression
Software upgrade via USB
- ◆ USB mouse control
- ◆ PTZ and network function
- ◆ Multi-language versions are selectable
- ◆ Support mobile surveillance
- ◆ Support network center management system
- ◆ Applied in large surveillance area such as supermarket, gas station, factory etc.

ENVIRONMENT ADAPTABILITY

2.1 Notice:

To safely operate the DVR and prolong its life, please pay attention on following

1. When installing device, please comply all the electric product safety criterion ;
2. Power and ground:
 - ◆ Do not touch the power and DVR with a wet hand
 - ◆ Do not drop liquid on DVR
 - ◆ Do not put others on DVR
 - ◆ Please using soft dry cloth when clean DVR, do not using chemical solvent
 - ◆ When the power line connects with jack, even don't startup device. There is still have voltage
 - ◆ If you do not use device for long time, please take the power line away from jack.

3. Humidity requirement

Please install the device in good conditions, it's better to avoid from humidity, drip sites, etc.

3. Device operation

In device operation, the enter key on remote control has the same function with mouse left click.

3.1 Remote key instruction

3.1.1 Remote control



Handheld IR Controller Key Functions:

【0 - 9】 keys: During setup, number keys are used to input values. For viewing channels 1, 2, 3 and 4, use 1, 2, 3 and 4 on numeric keypad respectively.

【+】, **【-】** keys: During setup, plus and minus are used to select next or previous values.

▲ , **▼**: Up, Down directional keys: Move selection up and down in setup menu.

◀ , **▶**: Left, Right directional keys: Move cursors left or right in setup menu.

【QUAD】 : Switch 4 Channels ;

【FWD】: Fast forward the video while playback. press **【PLAY】**to return to normal speed ;

【REV】: Reverse the video while playback, press REW to switch, press **【PLAY】** to return to normal speed ;

【POWER ON】 : Reset the MDVR to Power on and Power off mode. (standby and start

up) ;

【LOGIN/LOCK】 : If the security is enabled in the setup, use LOGIN/LOCK key to enter the user setup. It is important to remember the password due to without restoration function. Log in (to enter into “User ID select” and “Password” input interface) and lock functions (To exit setup and operation)

【OSD】 : Press OSD for main menu ;

【PTZ】 : PTZ control , press this key to enter into PTZ control interface when at single live view ;

【EXIT】 : Exit to the preview or return to the last menu ;

【RECORD】 : Start manual record



【STOP】 : Stop manual record

【ASISTANT】 For future use

3.1.2 Mouse Operation

You can use mouse to make operation of the menu besides IR remote controller. (The operation is the same as PC Windows).Please inserts the mouse into USB Port.

Click right key	Enter into main menu: Click the right key on the live view.
Click left key	Click the left key to enter into the setting interface.
	Click the left key to zoom in the window on the live view and playback video. Double click the left key can exit to the live view and playback multi-window interface.

	<ol style="list-style-type: none"> 1. Volume adjustment, color adjustment, PTZ setting and VGA border operation. It is for setting the single channel for volume adjustment, PTZ control and color adjustment. If it is multi-window, please use the left key to select the single window. 2. The remark when click the left key for volume adjustment, color adjustment, VGA border is as follow: <ol style="list-style-type: none"> a. There are  and  for buttons the PTZ setting to adjust parameter, click it can adjust the setting for PTZ. b. There is a sticker to show the volume on the volume adjustment interface. Move the mouse to the corresponding position and click the left key. The right side of sticker will show the volume ,click “x” to exit. c. Color adjustment can refer to the volume adjustment interface operation.
	<p>When there are many options in the option frame, click left key to see down-pull menu.</p>
	<p>To click the left key on the playback interface can make >> means forward, << means raw, >> means Slow play, > means frame play,> means Play, X means exit.</p>
Click left key	<ol style="list-style-type: none"> 1. In the input frame, click the left key can activate the keyboard. The number, symbol, English can be input by clicking the mouse. 2. Pinyin also can be input by the soft keyboard when enter Chinese, the method is the same as remote control. You can use the left/right key to turn over the page when check on Pinyin/Chinese word. 3. When input number, click the right key, the number soft keyboard will bob up firstly, and then use the left key to select the corresponding numerical value. Also click the left key to exit the number keyboard.

<p>Mouse move</p>	<p>1. Press the left key to move the mouse can adjust the parameter on the volume, color, VGA border interface. And the corresponding parameter will be display at the same time.</p> <p>2. In the Motion Detection setting interface, you can use the left key to drag the frame to set the motion detection area.</p>
-----------------------	---

3.1.3 Menu Configuration

You can control the DVR by a lot of menu operation. This tree will show you the menu structure and it will be in details in the following chapters.

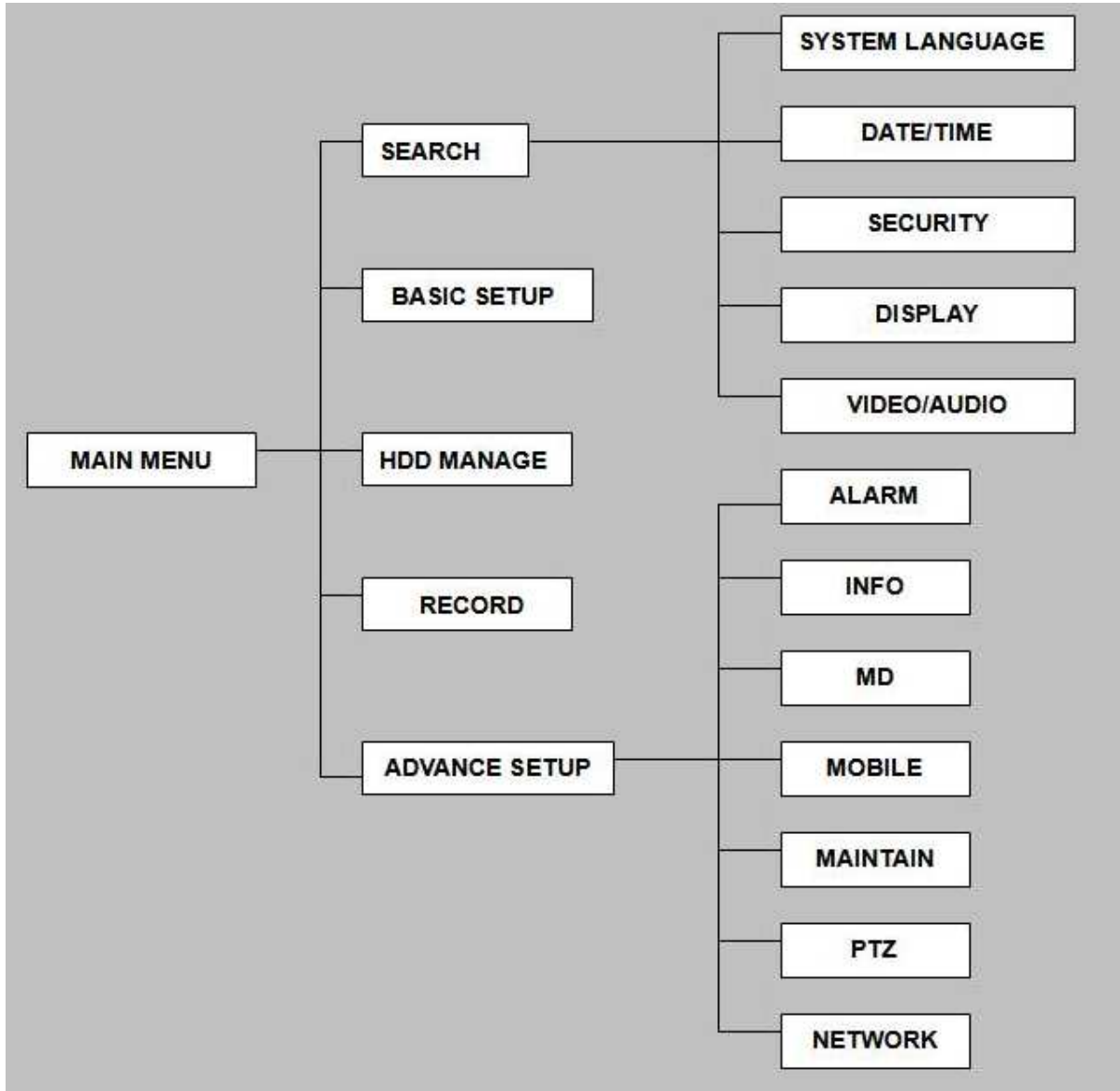

3.2 System Operation

3.2.1 START-UP

Connect the power adapter to DVR. When start up the DVR, 【POWER】 LED will be on and 4 images will be display on the screen. If it has setup ignition recording or time recording, the system will record automatically and the corresponding LED will be on, and the system work normally.

Remark:

1. If there is no HDD in device, or the device didn't read the HDD, or the HDD didn't be formatted it will display an 【H】 in the video preview interface.
2. You must format the HDD in the DVR before first using. The steps as follows: menu > HDD management > format. After formatting, the system will restart.

3.2.2 SYSTEM LOGIN

Remark: default device ID is: 00000, and there is no password. In order to keep safe, please modify the user password and change the device ID in the base setup. You can setup user and admin password, Admin has all authorities while user has limited authorities of viewing image, searching and play backing video. When you input a password, the system will automatically match and offer different password with different authorities.

When DVR started, click right key by mouse. If you open a password, it will enter into user login interface. The picture is as follows:



The image shows a screenshot of a 'USER LOGIN' interface. The title 'USER LOGIN' is at the top. Below it, there are two input fields: 'DEVICE ID: 000000 (000010)' and 'PSAAWORD: []'. At the bottom, there are two buttons: 'APPLY' and 'EXIT'.

Ddvice ID: You just need to enter the device ID as the right frame.

Password: enter the admin password or user password.

3.2.3 GUI OPERATION

The main menu include “SEARCH”, “RECORD”, “HDD”, “BASIC”, “ADVANCE”, and “Exit”.



Remark: You must press “APPLY” to make the setting for submenu valid. It will be no use when exit directly. There is a special feature of this DVR: when you move the mouse somewhere, the explanation information will be showed automatically.

1 RECORD SEARCH

Move the cursor to **【RECORD SEARCH】** (Icon highlighted when selected), press **【Enter】** to enter into the setting interface.

There are three methods of searching record.

Method 1: playback by date

Date input: You can adjust the checking date and time, press **【Enter】** or input the number directly to adjust the year, month, date. And then input time in the next box, click “play” and then you can see the recording video.

Method 2: playback by recording status:

Input the date, click **【search】** and you can see the recording status on this date.



Instruction:

1. **MONTH:** It will show all the recording status in this month. Green means normal recording, Red means alarm recording and the default color means no video. Click any date in this frame can search the recording status of that day. The searching result will be showed in the below date frame.
2. **DATE:** It will show all the recording status in this day, you can playback the record file in this period via click the corresponding period. Every grid stands for one hour.

Method 3: playback by file list:

Input the searching date, click “SERACH” and you can see the recording status. Click an exact day and then click “detail file” and then you can see the interface of “detail file”.

CHANNEL: There are CH1, CH2, CH3, CH4 and QUAD, totally 5 options. Press **[Enter]** and you can change the channel to be displayed.

TYPE: There are all, normal and alarm, totally 3 options. Press **[Enter]** and the content will be displayed in a list.



Instruction:

1. **[File Detail List]** , “Channel” number shows the recording file belong to number showed channel record. “Recording time” is the recording beginning time to end time.

“SIZE” is the size of this file (Unit: MByte) , “TYPE” is the type of recording file. There are two types: normal and alarm , ”Backup” in the lower right corner of menu can backup the selected files to USB storage ;

2. Moving the cursor to select the files, and press **【OK】** to enter into playback interface。 If more than one channel have recording files during selected time, will playback all at the same time ;
3. If let **【RECORD TIME】** available in **【BASIC SETUP】** ,it will show the date/time when playback record file ; If **【RECORD TIME】** available , it will not show the time ;
4. When playback , press **【SLOW】** to let the playback slow ; press **【FORWARD】** , **【REVERSE】** to speed、 reverse play ; press **【PAUSE/STEP】** to pause or playback frame by frame ; Press **【Exit】** to exit from playback and return to the Previous menu ;
5. When selected recording file playback finished, it will continue following files; if no followed record file, it will return to **【File Detail List】** automatically

2. BACKUP

Via USB Storage to backup, connect USB device via USB2.0 port before backup.

Select the recording file by direction keys , and press **【Enter】** , There will a “√” sign if select is ok, and then press **【BACKUP】** to begin backup as follow:

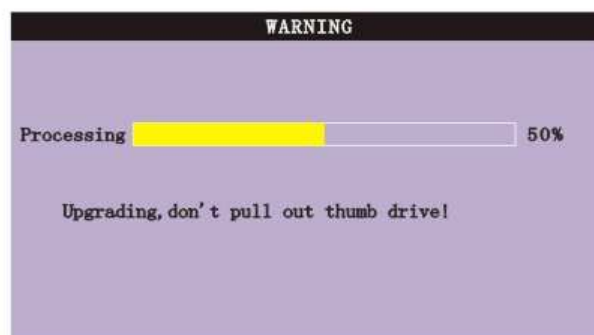

Instruction:

- 1 . When USB device space is less than recording file, the system will show “Space no enough”.
- 2 . Disconnect USB device directly when backup finished.

3 RECORD MODE

Move the cursor to **【RECORD】**(Icon highlighted when selected),and press **【Enter】** to enter into the setting interface(As follow showed). use direction keys and cursor to change the options.



CHANNEL: ON: Means the channel enable for recording.

RESOLUTION: There are HIGHEST, HIGH, NORMAL three options, HIGHEST means the resolution best , corresponding to D1、 HD1、 CIF resolution.

QUALITY : There are BEST, FINE and NORMAL three option, They are corresponding HIGHEST, HIGH and NORMAL data stream standard

AUDIO: ON: Means enable the audio recording for all channels, OFF: Means disable audio recording

REC.MODE

POWER UP: Means recording start when DVR to work.

TIME: Recording as the schedule. When chose Time recording, **【Recording period setting】** will show up in the right. Move cursor to there, and press **【Enter】** to the interface as below:

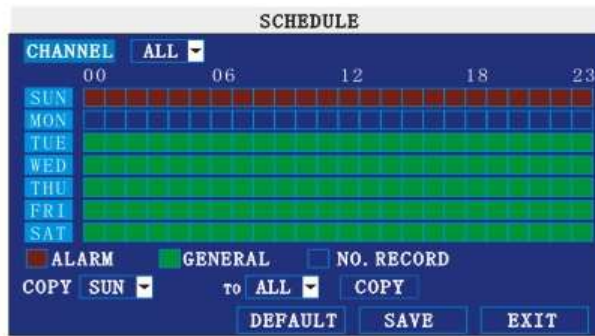

CHANNEL: You can select all channel or just one channel

DAILY: There are ALARM, NORMAL, NO REC three modes, if set for detail time, please set in **【Recording period setting】** and then press **【Enter】** . Impress color means no recording during this time. Different color means different recording mode: Red means alarm recording, green means normal recording, blue means no recording.

RECORD SIZE: Press **【Enter】** or **【+】 / 【-】** to choose the record size time.

There are 15min, 30min, 45min, 60min four options, that means it will pack as the mode you selected

4 Hard Disk Management.

Move the cursor to **【HDD】** (Icon highlighted when selected),press **【Enter】** to enter into the setting interface, and you can use direction keys and cursor to change the options.



HDD STATUS: There are three status available, normal, un-format, No HDD. If HDD can not run normally (including unformed and no HDD) , there is a **【H】** display on video preview interface.

OVERWRITE: ENABLE: means when HDD space is less than 4G, it will delete earliest recording file, deleting can stop until the space is no less than 10G; **DISABLE:** means when HDD space is less than 500M it will stop recording, and an prompt will display “please shutdown and replace HDD”

FORMAT: Move cursor to select device and press **【APPLY】** to format

FORMAT Flash Disk: Move cursor there to select device and press **【APPLY】** to format

Note: DVR system will restart after HDD formatted, but no restart for U Flash disk format.

5 BASIC SETUP

Move cursor to select “BASIC SETUP” (The big icon means select ok)and press **【ENTER】** to enter into the system language setup interface.



Basic setup includes language, date/time, password, display, and video/audio and exit six options.

6 SYSTEM LANGUAGE SETUP

Move cursor to select “system language” (The big icon means select ok)and press **【ENTER】** to enter into the system language setup interface.



There are Chinese and English options, press **【ENTER】** or **【+】 / 【-】** to chose.

Remark: System will restart after changing language success.

7 DATA/TIME SETUP

Move cursor to select “date/time” (The big icon means select ok) and press **【ENTER】** to enter into the date/time setup interface.



DATE: Press **【Enter】** or **【+】 / 【-】** or press number key to chose the date.

DATE FORMAT: Press ENTER to switch between the date patterns, there are YY-MM-DD and MM/DD/YY two options. When chose the date format, left date will be displayed with corresponding format.

TIME: Press **【Enter】** or **【+】 / 【-】** or press number key to choose the date.

TIME FORMAT: Press ENTER to switch between the date patterns, there are 12 HOURS and 24 HOURS two options. Left time will be displayed with corresponding format.

Remark: Have to move the cursor to the **【MODIFY TIME AND DATE】** and press

【APPLY】 to save it, otherwise it won't save the modify if you exit this interface.

8 SECURITY

Move the cursor to **【SECURITY】** (Icon highlighted when selected) , press **【Enter】** to enter into the setting interface.

SECURITY				
DEVICE ID	000010			
PASSWORD	ENABLE			
USER PASSWORD	*****	RE-ENIER	*****	
ADMIN PASSWORD	*****	RE-ENIER	*****	
		APPLY	EXIT	

DEVICE ID: Press **【+】** / **【-】** or number key to setup the ID

PASSWORD: **【Enter】** key to choose whether password enable or disable. "enable"

means user

need insert password when log in, "disable" means without password and user can enter into main menu directly.

USER PASSWORD: Press number key to setup.

ADMIN PASSWORD: Press or number key to setup.

9 DISPLAY SETUP

Move the cursor to **【BASIC SETUP】**(Icon highlighted when selected) , press **【Enter】** to enter into the setting interface.

DISPLAY SETUP				
	NAME	POSITION	COLOR	PREVIEW
CH1	CH1	TOPLEFT	SETUP	ON
CH2	CH2	TOPLEFT	SETUP	ON
CH3	CH3	TOPLEFT	SETUP	ON
CH4	CH4	TOPLEFT	SETUP	ON
PREVIEW TIME		ON	RECORD TIME	ON
		DEFAULT	APPLY	EXIT

NAME: press **【Enter】** to enter into the setting interface.

POSITION: press【Enter】 to switch name location, there are 5 options: bottom left, top left, bottom right, top right and OFF.

COLOR: press 【Enter】 to enter into setting interface, as following:



Press 【Enter】 or directly drag the cursor to set colors, including chromaticity, luminosity, contrast and saturation, press 【APPLY】 to save the parameters.

PREVIEW: ON: Means the channel is allowed to view the live mode

PREVIEW TIME: ON: Means displaying system date and time above video.

RECORD TIME : ON: Means clock will display in the playback of current file

10 VIDEO/AUDIO SETUP

Move the cursor to 【VIDEO/AUDIO SETUP】 (Icon highlighted when selected) , press 【Enter】 to enter into setting interface.

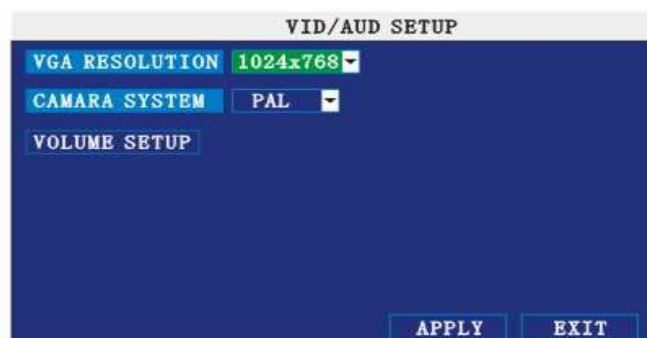

11 ADVANCE SETUP

Move the cursor to 【ADVANCE SETUP】 (Icon highlighted when selected) , press

【Enter】 to enter into setting interface. Picture is below:



Advanced Function include Alarm settings, system information, Motion detection, mobile phone monitoring, system maintenance, PTZ and network setting.

12 ALARM SETUP

Move the cursor to【ALARM SETUP】(Icon highlighted when selected) ,press【Enter】 to enter into setting interface. Picture is below:

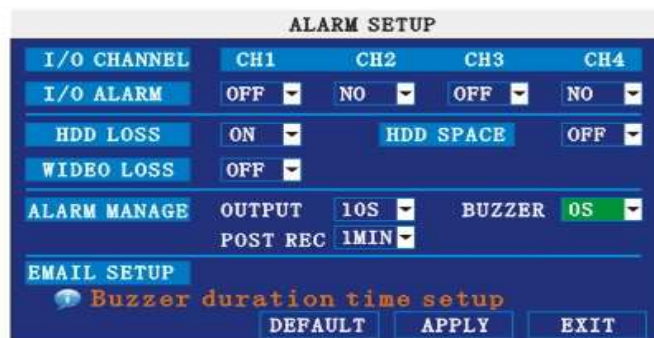

I/O ALARM: Each channel corresponds an I/O status, that is, when an alarm triggered, it will activate the corresponding channel to start alarm recording.

N.O: indicate alarm is always OFF; it will be ON when have alarm

N.C: indicate alarm is always ON; it will be OFF when have alarm

HDD LOSS: turn on means it will trigger an alarm if there is no HDD, and it will display an

【H】

On the bottom left of channel 1 in the live view

HDD SPACE: turn on: If the space is less than 500M, there is a remark in live view: No enough space, please change HDD after shutdown.

VIDEO LOSS: turn on: when one channel has no video input, it will display “video loss”in live view.

ALARM MANAGE: There are alarm output, buzzer and post REC.

OUTPUT: when an alarm triggered, the alarm output time will be:

0 second、 10 seconds,20 seconds,40 seconds or 60 seconds

BUZZER: buzzer calling time setup when alarm triggered: 0 second,10 seconds,20 seconds,40 seconds or 60 seconds

POST REC.: post recording time setup: 30 seconds,1 minute,2 minutes or 5 minutes

13 SYSTEM INFO

Move the cursor to **【SYSTEM INFO】** (frame is red when selected) , press **【Enter】** to enter into system info interface, on this interface mainly display system hardware features and firmware version, include: software version, MAC address、 serial number.

Picture is below:



14 MOTION DETECT

Move the cursor to **【MOTION DETECT】** (Icon highlighted when selected) , press **【Enter】** to enter into motion detect setting interface. Picture is below:



CHANNEL SWITCH: Each channel has corresponding channel switch, press **【Enter】** to turn on or turn off the motion detection for each channel..

SENSITIVITY: each channel has corresponding sensitivity setting, including four standards high, relative high, medium and low, press **【Enter】** key to switch

MD AREA: each channel has corresponding regional motion detecting setting, move the cursor to corresponding **【setting】** , press **【Enter】** to enter regional setting interface, red area means it have activated motion detection, transparent block means it have not activated motion detection. Picture is below:

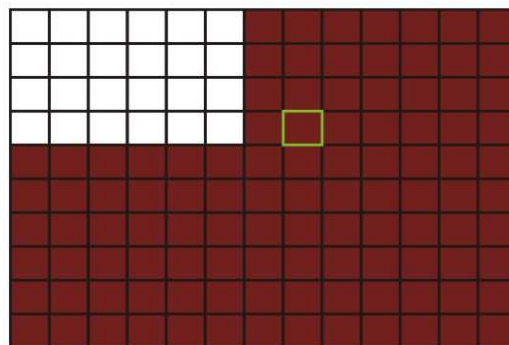

Move the direction key on remote control or make cursor move to the need designed area, green frame means the cursor has moved to this pane, press **【Enter】** to select or cancel motion detection of this small pane, when setup finished, press **【exit】** to back to MD setup interface, it will save automatically.

Remark:

IR Operation: press [Menu] key to select or cancel full screen.

Mouse operation: click left and drag the frame to setup the region for motion detection.

15 Mobile Surveillance

Move the cursor to **【MOBLE】** (Icon highlighted when selected) , press **【Enter】** to enter into setting interface. Picture is below:



NETWORK CHANNEL: select the channel for network transfer, and press [Enter] to switch different channels.

WIRELESS NETWORK: Select different mobile network from the options of 3G, 2.5G and 2.75G, and press [Enter] to switch different network.

NOTE: Detail setting up please refer to appurtenance.

16 SYSTEM PROJECT

Move the cursor to **【SYSTEM PROJECT】** (Frame turns red means selected), and press **【Enter】** to enter into system project setup interface. Picture is below:



AUTO RESET: When switch is on, you can setup the time for device to restart.

SYSTEM UPDATE: Copy the update file to the root directory of the flash disk, and insert it into USB groove, then press [Enter] to upgrade the firmware, and it will display the process of the system upgrading, picture is below:

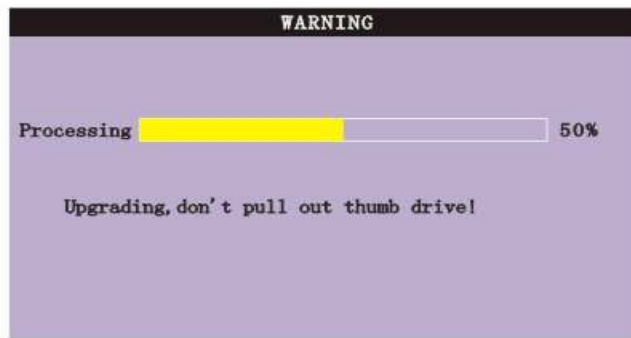

DEFAULT SETTINGS: Restore all the settings as the factory setting.

NOTE: make sure that the U drive and power is steady when it is upgrading.

17 PTZ SETUP

Move the cursor to **【PTZ SETUP】** (Icon highlighted when selected) , press **【Enter】** to enter into setting interface, you can setup the parameters for each channel separately. With direction key or move cursor to the option, and press [Enter] to switch different channels.

CHANNEL: The channel of PTZ connected.

PROTOCOL: select the protocol of different PTZ, there are two protocols to switch, and the default is Pelco-D

BAUD RATE: select the different baud rate for your PTZ, there are 1200, 2400, 4800, and 9600

DATA BIT: there are 5,6,7,8 options to select, default setting is 8.

STOP BIT: 1 and 2 are optional, the default setting is 1.

VERIFY: there are None/Odd/Even/Mark/Space to select, the default setting is none.

ADDRESS: Fill the code of respective PTZ with relative channel.



18 NETWORK SETUP

Move the cursor to [NETWORK SETUP] (icon highlighted when selected), and press

[Enter] to enter into setting interface .picture is below:



CONNECT NETWORK TYPE: There are PPPOE, DHCP & Static three options

◆ 1 Static

Select [Static] in the CONNECT NETWORK TYPE, and press [Enter] to enter into the interface as followings



MEDIA PORT: transfers video data between client and device.

WEB PORT: setup the port of IE browser via HTTP.

IP ADDRESS: setup the IP address, and press [Enter] **【+】** / **【-】** or input numbers to fill IP address.

NETMASK: press [Enter] **【+】** / **【-】** or input numbers to fill netmask.

GATEWAY: press [Enter] **【+】** / **【-】** or input numbers to fill default gateway.

◆ 2 DHCP

Select the DHCP, and enter into the interface as followings.

The screenshot shows a terminal window titled "NETWORK SETUP" with a dark blue background. The "TYPE" field is set to "DHCP" via a dropdown menu. Below it, "MEDIA PORT" is set to "09000" and "WEB PORT" is set to "00080". Further down, the "DNS" field contains "202.096.134.133". At the bottom, there are three buttons: "DDNS SETTINGS", "DEFAULT", "APPLY", and "EXIT".

MEDIA PORT: same as static setup

WEB PORT: same as static setup.

NOTE: restart system when select DHCP, and it will automatically connect with DHCP server. Will allot IP address when connect ok and the address will showed on the interface.

◆ 3 PPPoE

Select the PPPOE, and enter the interface as followings:

The screenshot shows a terminal window titled "NETWORK SETUP" with a dark blue background. The "TYPE" field is set to "PPPOE" via a dropdown menu. Below it, "MEDIA PORT" is set to "09000" and "WEB PORT" is set to "00080". There are two empty input fields for "PPPOC NAME" and "PASSWORD". Further down, the "DNS" field contains "202.096.134.133". At the bottom, there are three buttons: "DDNS SETTINGS", "DEFAULT", "APPLY", and "EXIT".

MEDIA PORT: Port for private protocol of DVR and PC, default : 9000. If this port of computer is applied by other server, please change to other free port.

WEB PORT: Http port. Default: 80. If admin change WEB port to: e.g. 8088, port No. should be added behind IP, http://192.168.15.145:8088 should input into IP of IE.

IP address: Fill in IP address according to the net of DVR;

Net mask: Fill in net mask according to the net of DVR.

Gateway: According to the net of DVR, set gateway. If no router of the net, please distribute IP address of same web segment; corresponding gateway should set .

19 Application of DDNS

You should register a host name, user name and password from DDNS manufacture, now we take dyndns for instance, to show you how to register.

Please type in the IE address as follow: <http://members.dyndns.org/> to register a new user

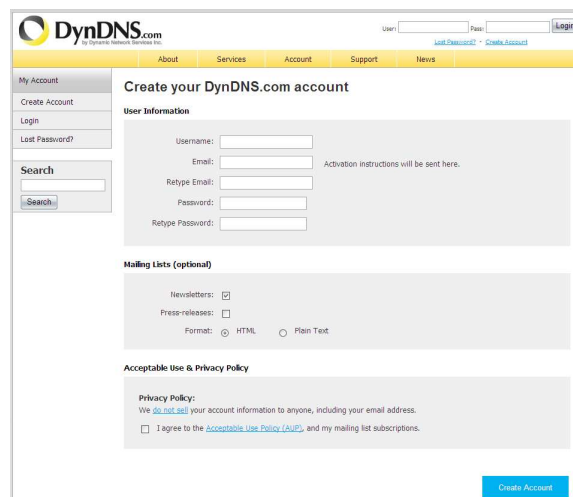
The image shows a screenshot of the DynDNS.com website's account creation page. The page has a yellow header with the DynDNS logo and navigation links: About, Services, Account, Support, and News. On the left, there is a sidebar with links for 'My Account', 'Create Account', 'Login', and 'Lost Password?'. Below the sidebar is a search box. The main content area is titled 'Create your DynDNS.com account' and contains a 'User Information' section with input fields for Username, Email, Retype Email, Password, and Retype Password. A note indicates that activation instructions will be sent to the email address. Below this is a 'Mailing Lists (optional)' section with checkboxes for 'Newletters' and 'Press-releases', and radio buttons for 'Format' (HTML and Plain Text). At the bottom, there is an 'Acceptable Use & Privacy Policy' section with a checkbox for agreement. A blue 'Create Account' button is located at the bottom right of the form.

- 1 . Fill out all the information then submit.
- 2 . Minutes later, you will get a mail from dyndns, which include the primary password for the user you just register.
- 3 . Then please login <http://members.dyndns.org/> with the new user and password, click “domain name management” to enter into the operating interface, then select “new” under the Dynamic DDNS.
- 4 . Create a domain name you need, then press to apply; now you have registered a host name success.

20 DVR group network

This chapter mainly narrates some networks' setting method for your reference:

1 . Applied ADSL , only one DVR need to connect with Internet

- 1 . Make sure the DVR has successfully connected to ADSL modem; the LED is flashing means success.
- 2 . Network type: PPPoE
- 3 . Input media port and web port. Please refer to“Setup instruction”network setup ;
- 4 . Type in the PPPoE user name and password ;
- 5 . Fill in DNS IP ,such as:202.96.128.166 or 10.95.0.3. Users can refer to local computer

DNS setup, (in DOS input ipconfig/all in DOS to query) ;

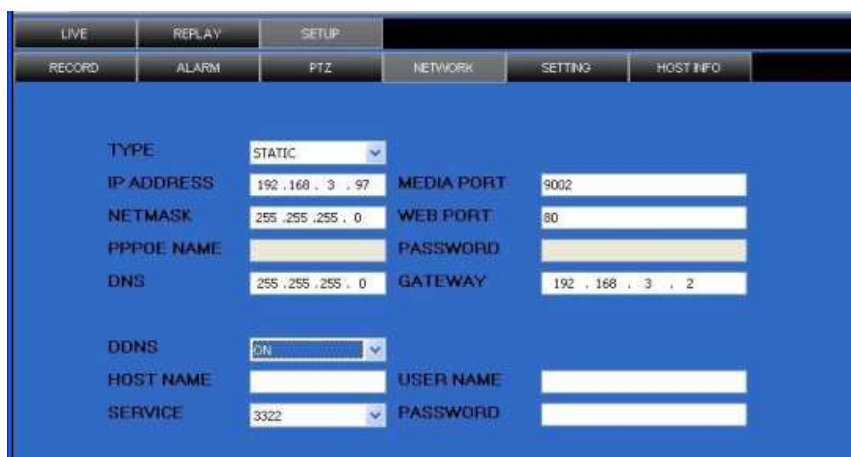

The screenshot shows a web-based configuration interface for a DVR. At the top, there are navigation tabs: LIVE, REPLAY, SETUP, RECORD, ALARM, PTZ, NETWORK, SETTING, and HOST INFO. The 'NETWORK' tab is selected. The main area is a blue form with the following fields:

TYPE	STATIC	MEDIA PORT	9002
IP ADDRESS	192 . 168 . 3 . 97	WEB PORT	80
NETMASK	255 . 255 . 255 . 0	PASSWORD	
PPPOE NAME		GATEWAY	192 . 168 . 3 . 2
DNS	255 . 255 . 255 . 0		
DDNS	ON	USER NAME	
HOST NAME		PASSWORD	
SERVICE	3322		

- 6 . Since the public IP will change after restart, please use DDNS function, and mapping the public IP to a fixed domain name.
- 7 . Save and restart device, it will connect to internet via PPPoE mode automatically, if success, it will got a dynamic public IP.
- 8 . ping xxx.xxx.xxx.xxx(The public IP of DVR) to check whether the network is ok, and ping xxx.xxx.xxx(the domain name of DVR)to check whether the DDNS settings is ok.
- 9 . Open IE browser, and type in the domain name of DDNS (if WEB port is not 80, you should add a port, please refer to IE setup)
10. Please download the IE control, then enter into login interface, the default setting has no password. Press enter and into the preview interface, and do what you want

according to your need.

2. Applied ADSL, many types of equipment should share and connect with internet

1. Need to confirm with internet manufacture, the ADSL you applied should permit multi share of the internet.
2. You should buy a router, currently many small routers of 4 port Hub is in the market; or your ADSL Modem has router function;
3. Refer to router user manual to ensure equipment connection correct;
4. Start PPPOE function of PPPOE, use router to have ADSL;
5. Suggest stopping router's DHCP function. DVR and the computer all adopt IP. Notice: DVR, computer and router's IP must in the same subnet, and the sub mask, gateway,

DVR internet setting:

The screenshot shows a network configuration interface for a DVR. The interface has a blue background and a menu bar at the top with options: LIVE, REPLAY, SETUP, RECORD, ALARM, PTZ, NETWORK, SETTING, and HOST INFO. The 'NETWORK' tab is selected. The configuration is as follows:

TYPE	STATIC	MEDIA PORT	9002
IP ADDRESS	192 . 168 . 3 . 97	WEB PORT	80
NETMASK	255 . 255 . 255 . 0	PASSWORD	
PPPOE NAME		GATEWAY	192 . 168 . 3 . 2
DNS	255 . 255 . 255 . 0		
DDNS	ON	USER NAME	
HOST NAME		PASSWORD	
SERVICE	3322		

Computer internet setting:

The screenshot shows two overlapping Windows dialog boxes. The left one is 'Local Area Connection Properties' for the 'AMD PCNET Family PCI Ethernet Adapter'. The 'Advanced' tab is selected, and 'Internet Protocol (TCP/IP)' is checked. The right one is 'Internet Protocol (TCP/IP) Properties' with the 'General' tab selected. The settings are as follows:

Obtain an IP address automatically	<input type="radio"/>
Use the following IP address:	<input checked="" type="radio"/>
IP address:	192 . 168 . 0 . 103
Subnet mask:	255 . 255 . 255 . 0
Default gateway:	192 . 168 . 0 . 1
Obtain DNS server address automatically	<input type="radio"/>
Use the following DNS server addresses:	<input checked="" type="radio"/>
Preferred DNS server:	202 . 96 . 128 . 168
Alternate DNS server:	202 . 96 . 134 . 133

6. Operate normal data via computer. This can check if above setting is correct;
7. Input IP address to check if it can visit DVR
8. Add DVR's port transfer function. Add DVR's media port and WEB port

-
9. Use internet remote PC. Check if DDNS is successful via ping xxx.xxx.xxx (DVR 's domain name)
 10. Input DDNS into IE address, if the WEB port is not 80, port number should add.
Please refer to IE operation chapter;
 11. After downloading IE active tool successfully, login the interface, default is no password, press OK to enter preview interface and have your following operation.

3 Manufacture has applied Internet line, DVR should connect with internet via IP and router.

1. Make sure DVR connect with the internet is correctly;
2. Use still configuration mode;
3. Please refer to internet setting chapter of "Installation guide", it can help to set port number, IP address, sub mask, gateway, etc;
4. Net admin add DVR port transfer or sending relation in router;
5. Use a computer of LAN, input IP of LAN and port number into IE address column to visit the DVR;
6. Use internet remote computer, input IP and port number of router to IE address column to visit DVR; you can start DDNS function. After finishing DDNS register and setting, users can visit via DDNS and port number. This can avoid remembering complex IP.

4. IE OPERATION

Through the IE browser of OS and install the software, you are able to do the network operation remotely, which is much more convenient. DVR support C/S, B/S, and visit in LAN and WAN, also support IP and domain name visiting.

It supports users revise server port. At the same time, it supports PPPOE, DHCP and four channel video / audio.

4.2 Restriction condition

To ensure PC's stable visiting of DVR, recommend Windows XP, Windows Vista operation system, recommend browser as IE 6.0, IE 7.0.

4.3 User login

Input the DVR local IP in IE browser, if the web port number is set as 80, directly input IP address into IE address column; If not 80, port number should add behind IP. E.g. when IP is 192.168.0.102, set port is 8088, <http://192.168.0.102:8088> should input. When the net is connected, IE will automatically download the file to PC as following,

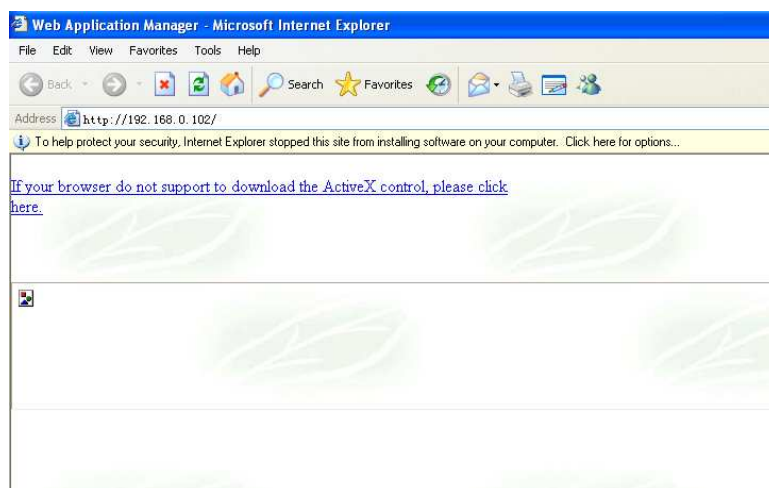

The process will last for 1~2 minutes.

Please click "If your browser does not support the ActiveX to download, please click here" when downloading not successful.

System will automatically enter GUI as follows:

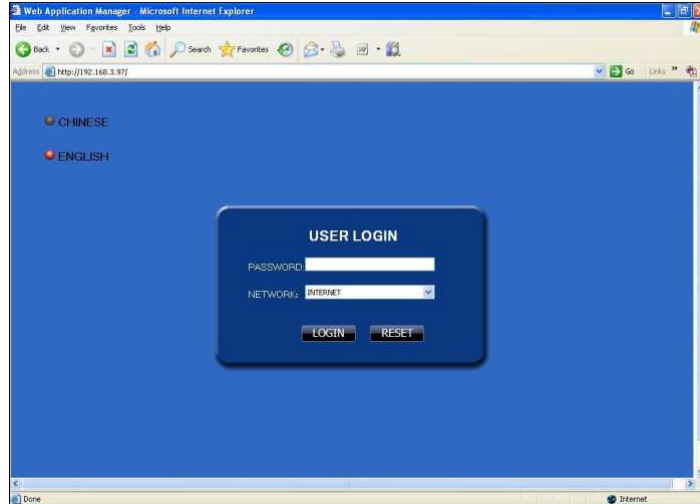

Chinese/English selectable.

PASSWORD: Administrator has all authorities, operator has limited authorities who they can only watch, playback, please change the unit No. and default password in time for system security.

NETWORK: LAN/WAN, according to the net type of your computer and DVR.

Click“Login” to enter IE interface. If input is wrong, click “Reset” to delete and rein put.

4.4 OPERATION INTERFACE

There are Live view, Playback and Setup options in the main interface, please press them to access it.

4.4.1 LIVE

Click  to enter into the interface as followings

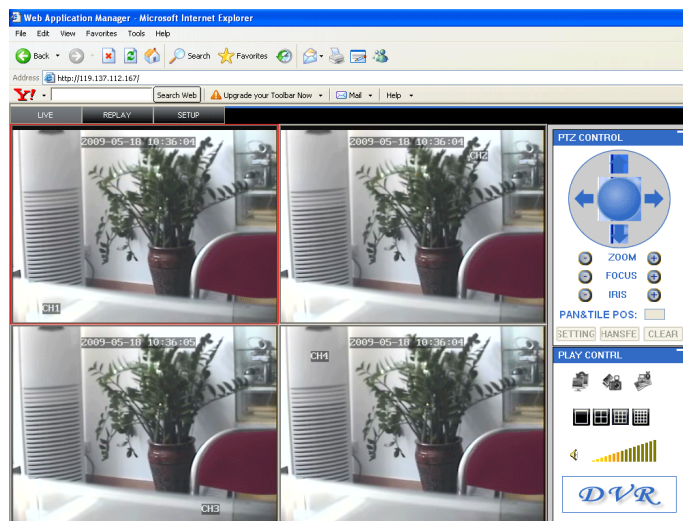

4.4.2 PTZ CONTROL

Change the focus, preset aperture to control the PTZ.

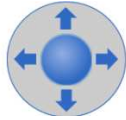

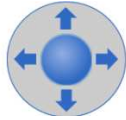
Click  to up/down/left/right control movement of the PTZ. When hold on the one direction key, the PTZ will keep circling as that direction after user press the stop key in the center of the wheel.

4.4.3 ZOOM

Click  **ZOOM**  to zoom in and out.

4.4.4 Focus



Click  **FOCUS**  to focus

4.4.5 Iris

Click  **IRIS**  to change the size of aperture

4.4.6 PTZ PRESET

PAN&TILE POS: Setup preset point.

You can control it via the below three buttons:   

4.4.7 PLAY

Move cursor to the icons, it will highlighted when selected



Open all video



Capture picture, save in local disk, system save default route is C:/DVR



Quickly start all channels' recording video, here the left up corner of each channel

have normal recording video symbol **【R】**, click icon to switch between signal

screen  /quad  /nine  /16 split .



Volume adjust button

4.4.8 OTHER OPERATION

1. Select one channel at preview screen (the selected channel's frame will be change to RED), double click left key, enter to the selected channel single screen display.
2. Click one Chanel via left key at preview screen, then click right key, will occur window shortcut Menu, see below picture

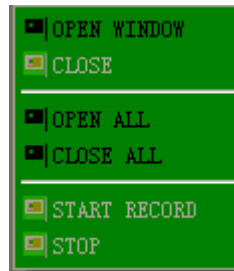



You can open, shut down and start this channel's record via shortcut menu.

3. Click right key at one live view screen, click" open all windows" or " close all windows", will quickly open/close all windows.

4.4.9 REPALY

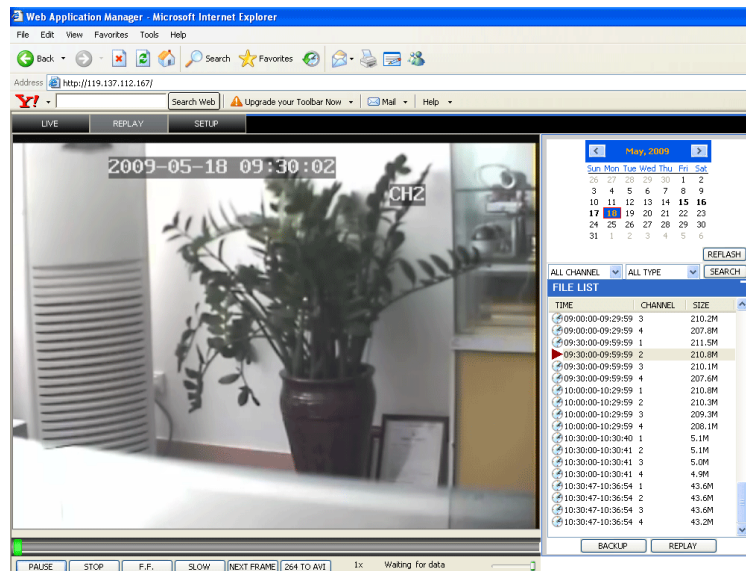
Click" REPLAY" to enter into playback interface.



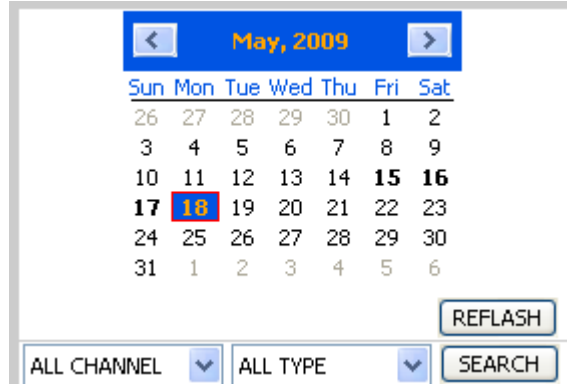

Click right up of calendar interface  and , to setup the month for searching, click" refurbish", at the calendar interface will display the recording information of current month

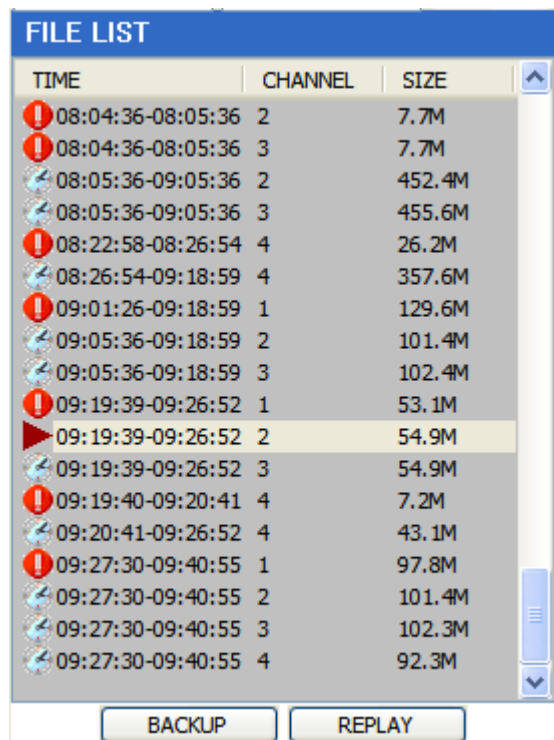

The highlighted date means that day have recording video, RED FRAME means the date is system date, click the date will search that days' recording file list. For example, the above picture display 2008, Dec. 3rd,4th,5th,6th,8th,9th,10th,11th,12th,17th,18th have recording video, and system date is 18th, Dec, 2008, currently search date is 17th, Dec.

At the below of calendar select channel and type, click SEARCH, the result will display, as follow.



Double click one item of listed recording video, the recording video will playback, meanwhile the file icon will change to , and will occur the below picture play buttons:

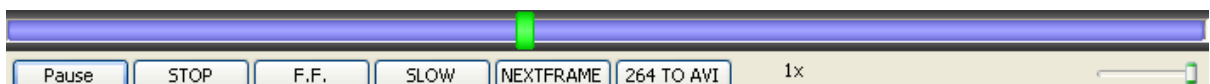

The above purple progress bar shows download progress, green progress bar shows

playback progress

- Switch between pause/play
- Stop play
- Fast play
- Slow play
- Pause at next frame
- Convert H.264 file to H.avi file, click this button access into file convert setting

interface, as follow.

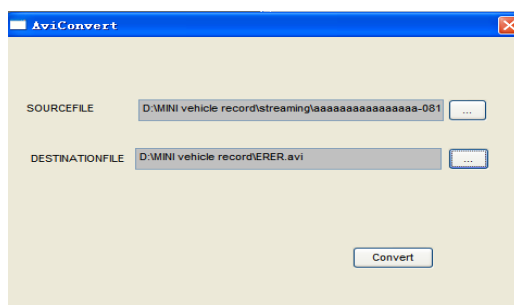

SOURCE FILE: Click to setup the H.264 file to convert

DESTINATION FILE: Click to setup the directory for saving avi file

After setting, click , file convert start, the convert progress bar (see below picture) will see the progress of convert.



4.4.10 SETUP

Click "SETUP" to enter into setup interface, this interface include record, alarm, PTZ, network, setting and system information six menus.

4.4.11 RECORD

Click "RECORD" to enter into setup interface; you can check the parameter settings as in GUI of DVR.

4.4.12 ALARM SETTING

Click "ALARM" to enter into setup interface; you can check the parameter settings as in GUI of DVR.

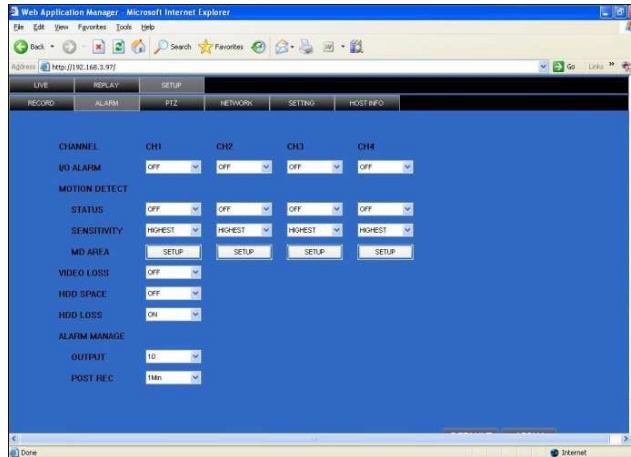

4.4.13 PTZ

Click “PTZ” to enter into setup interface; you can check the parameter settings as in GUI of DVR.

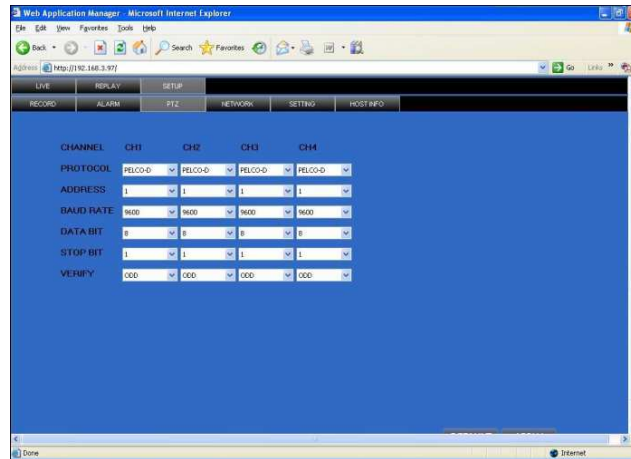

4.4.14 NETWORK

Click “NETWORK” to enter into setup interface; you can check the parameter settings as in GUI of DVR.

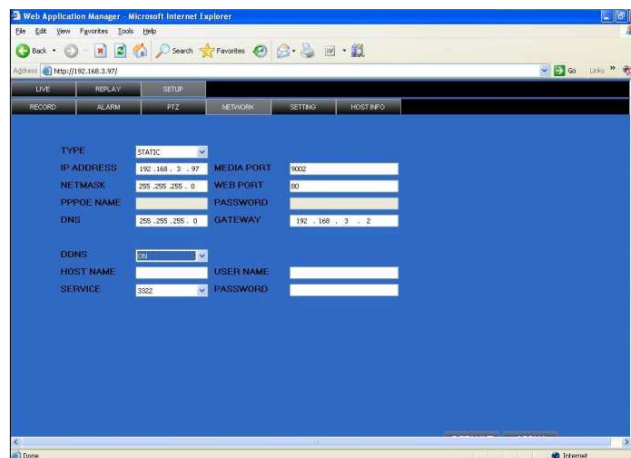

4.4.15 System setting

Click "SETUP" to enter the system setting interface as follows:

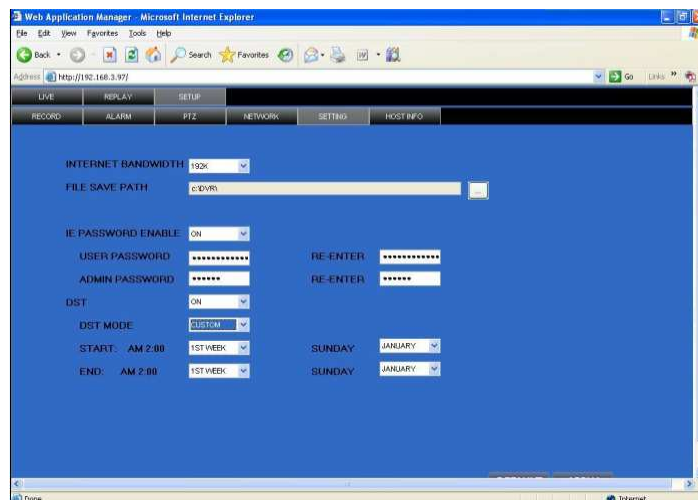

BANDWIDTH: Set the amount of bandwidth in kbps (128k、192k、256k、384k、512k、1024k) that you want to allocate for traffic that matches internet , this bandwidth depends on the place, normally around 256 or 384 kbps.

FILE SAVE PATH: capture picture and recording video save path.

IE login password and DST settings you can check as DVR setting.

4.4.16 HOST INFO

Click "HOST INFO" to enter into system information interface (see below picture), this interface shows HDD status, remain record time, firmware version, MAC Address, and all the information is fixed.

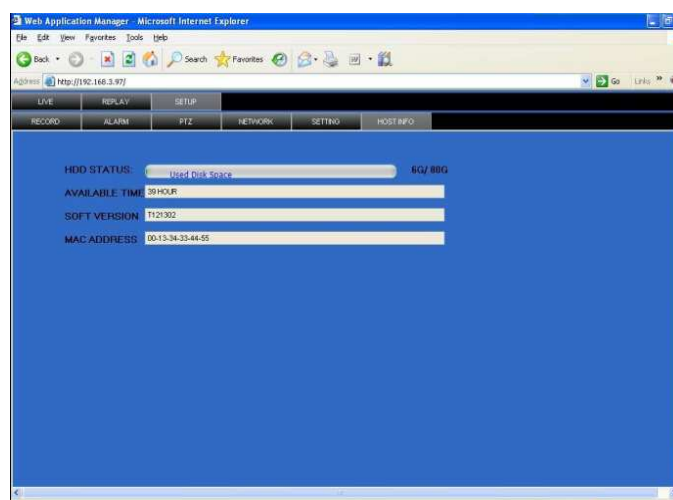

5.1.2 The Definition of Bottoms and Connectors on Front Panel

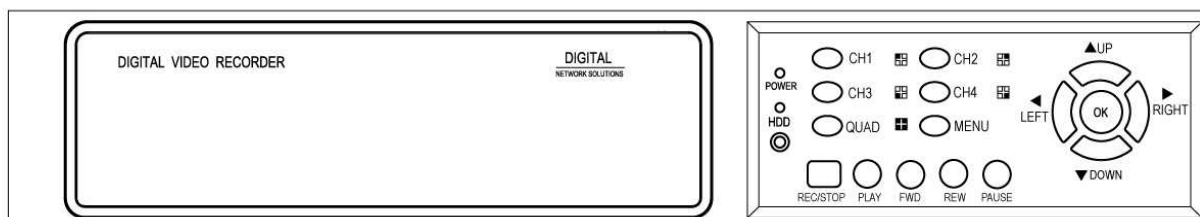

NO.	TYPE	NAME
Control button	Direction key	direction key include: up ▲ 、down ▼ 、left ◀ 、right ▶ four buttons, which can move cursor to setup and control PTZ.
	OK/PTZ (OK/PTZ)	Confirm operation, or into PTZ control panel under live view
	Stop key	■ Stop button
	Speed choice	▶▶ fast forward button、 ◀◀ fast reverse button
	Pause key	 pause key
	Single image	CH1、 CH2、 CH3、 CH4 single image choice
	playback	▶ PLAY recording playback button
	MENU/EXIT	Enter into main menu under live view, or exit sub menu
	HDD	HDD Status
	POW	power
IR receiver	IR	Remote control receiver

5.1.3 The definition of buttons and connectors on rear panel

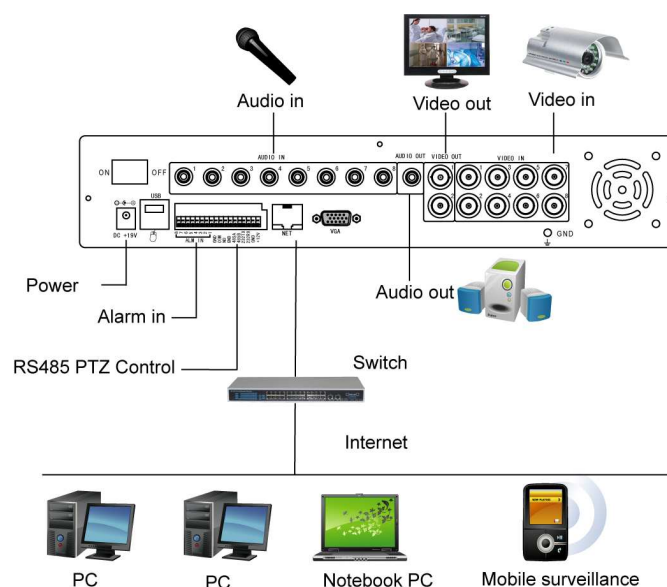

Item	Physical connector	Connector description
1	POWER input	DC 19V/4A
2	Power switch	host power switch
3	Video output	Two video output for connecting TV or monitor (BNC)
4	Video input	For connecting analog video signal input (BNC)
5	Audio Input	For connecting audio signal
6	Alarm Input	I/O alarm input, 4 for 4CH DVR and 8 for 8CH DVR
	Alarm Output	I/O output for alarm
	RS485	RS 485 for connecting PTZ
	RS232	For connecting PC
	+12V	Power supply for DC relay and the current is 100MA (make sure short circuit can not happen)
7	Network	For connecting Ethernet
8	VGA output	For connecting VGA monitor
9	USB2.0	Copy video record via USB2.0

10	USB MOUSE	Mouse operation equipment
11	audio output	For connection audio output
12	Fan	Please check the fan function for diary maintained and change new one if the fan has some problems

5.1.4 Connectors for Alarm

Peel off the color skin of the cable and then insert the cable into the slot on the rear panel DVR.

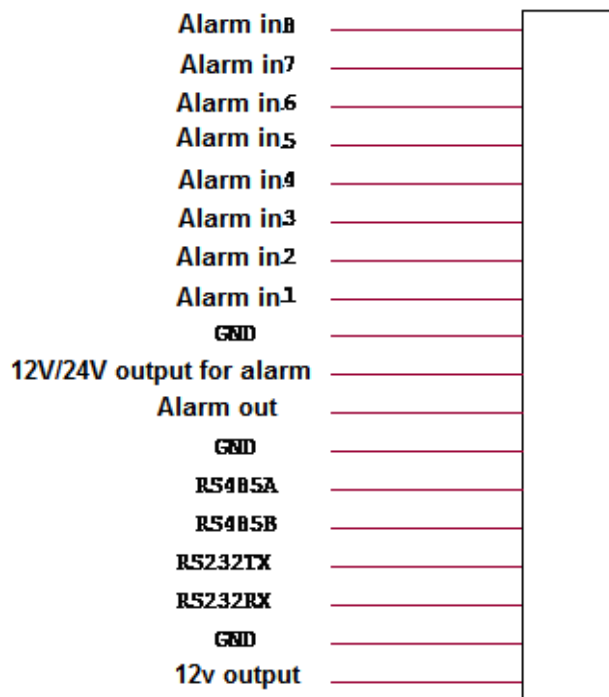

5.1.5 Alarm Input and Output

There are 8 sets alarm input connector and 1 set output for this DVR. Alarm input is for connection IR annunciation, fog sensor. The connection diagram of DC alarm in out as following:

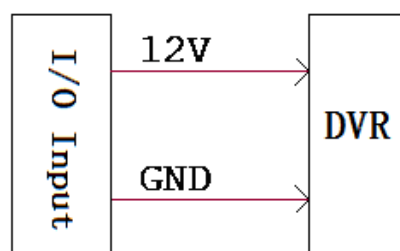

Connection diagram of AC alarm input as following:

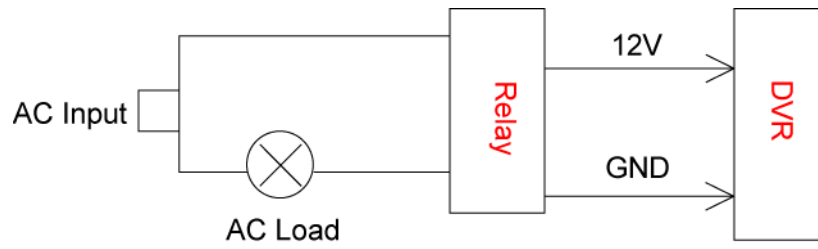

The connection diagram of alarm output as following:

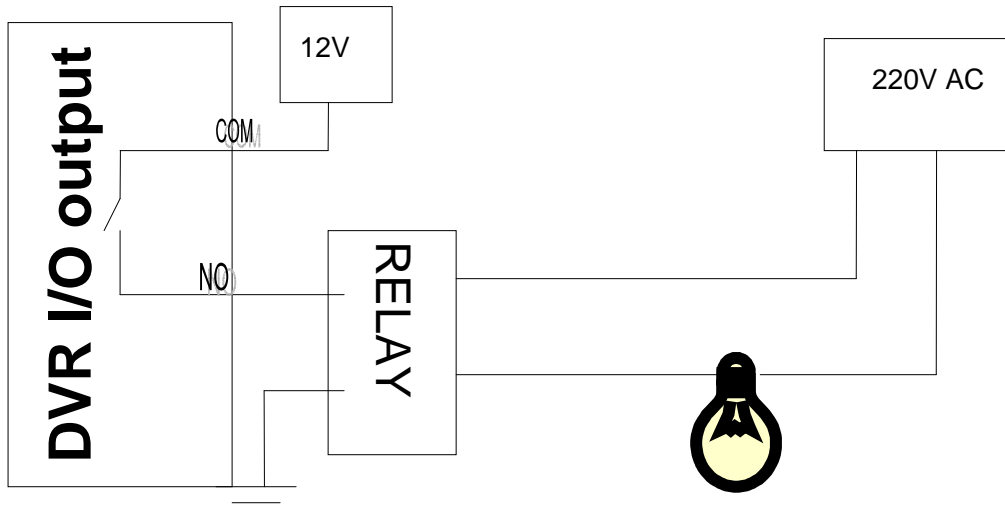

5.1.6. System Network Diagram

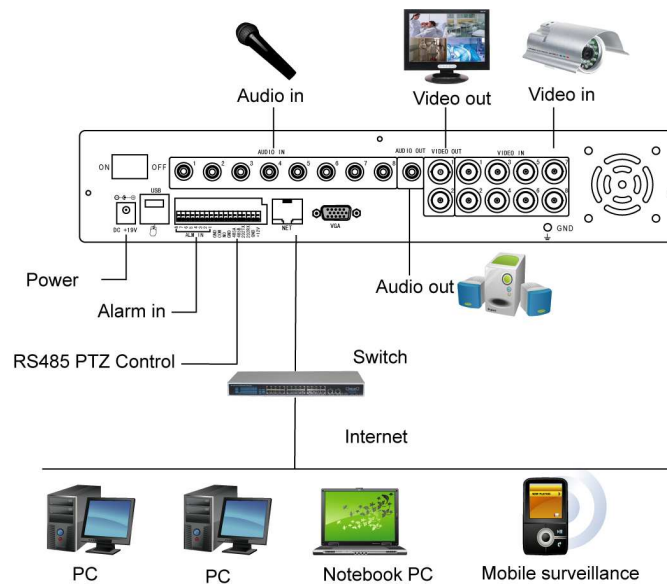

5.2 HDD Installation

Please installation the HDD as the following steps:

- 1) Uninstall the DVR and then you will see one HDD plate as following.

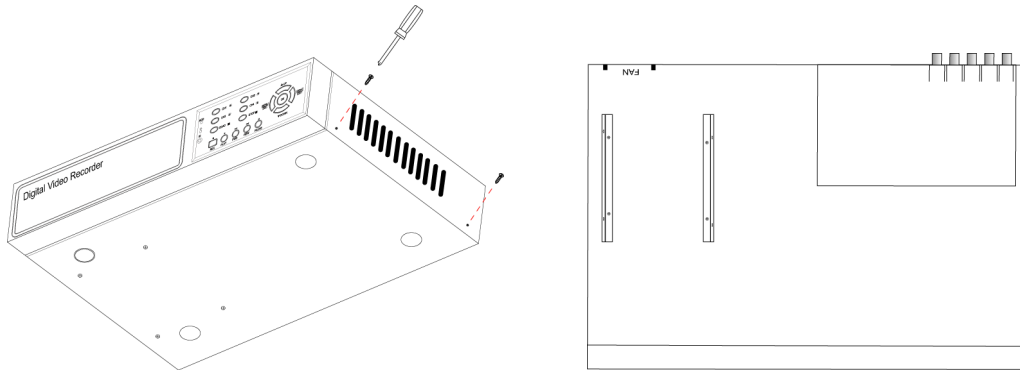

2) Connect HDD line as follows

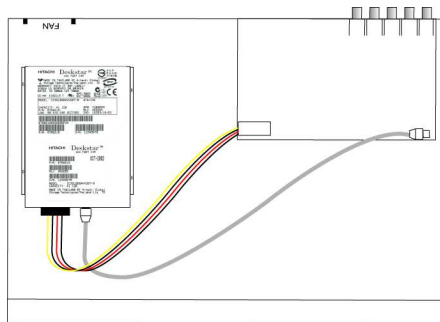

3) Install the HDD on HDD plate as the following photo indicate and then screws around.

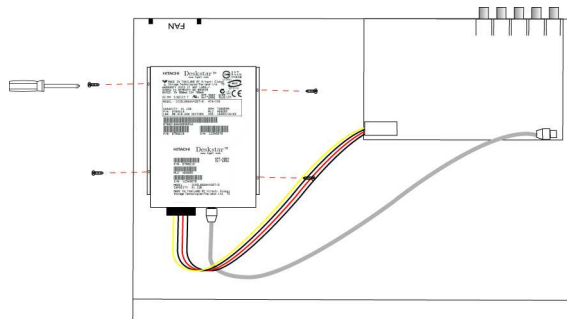

4) Fix the HDD plate on the DVR device and then cover the DVR and screw.

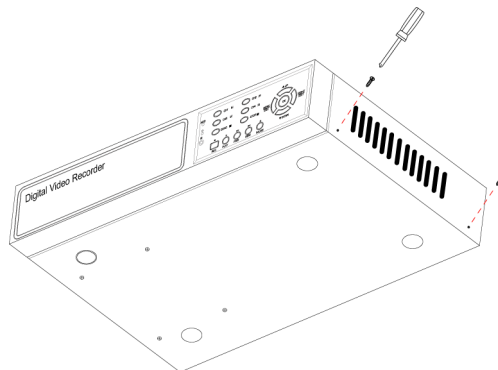

Notice: Newly installed HDD should format before recording.

6. Device Part

6.1 Check Device part



1. Digital Video Recorder 1 SET



2. Standard Part

 Power Cord	 Power Adaptor	 User Manual	 CD-ROM
 USB Mouse	 Remote Controller	 Cross Screwdriver	 Battery
 Guarantee	 certification	 Catalogue	 Screw

3. Optional Part

 Antennas	 Extended power cable	 Harddisk
---	---	--

7. FAQ

If your problem is not in below, call our hotline and we will resolve any issues or problems you may have.

1. Question: Why DVR can't work after starting it?

Answer:

- ✧ Check the adaptor input
- ✧ Check the on-off power line, does it well-connected?
- ✧ Check the on-off power
- ✧ Check the upgrade procedure whether it's wrong
- ✧ Check the main board of DVR whether it's ok

2. Question: Why DVR will automatic reboot or stop after starting DVR several minutes?

Answer:

- ✧ Instability or low input voltage
- ✧ Bad track hard drive or the line of hard drive is bad
- ✧ On-off power supply is not enough
- ✧ The front-end video signal instability
- ✧ High temperature, too much dust, too bad the DVR operating environment
- ✧ The main board is not well-connected with other board
- ✧ The hardware of DVR is fault

3. Question: Why there is no output of single channel, multi channel or all channel video?

Answer:

- ✧ Please check the adaptor of camera whether it is well-connected
- ✧ Please check the connect line for connecting video input and video output in the back board of DVR
- ✧ Please directly insert the video source into the display device, and check whether the video source and display device aspect of the problem.

-
- ✧ Check the brightness of the picture is 0, and bring it back to its original default setting
 - ✧ No video input signal or too weak
 - ✧ Display settings in the preview set to be closed
 - ✧ The hardware of DVR is fault

4. Question: Why the DVR can't record after startup and the interface shows "H"?

Answer:

- ✧ Check the DVR whether it use by DC 19V power adaptor
- ✧ Check the HDD whether it is formatted in DVR
- ✧ Check the HDD power line and the data line whether they are well-connected or badly
- ✧ The HDD has problem
- ✧ The SATA port has problem

5. Question: What is meaning by "R" "M" "I" "H" showed in interface?

Answer:

- ✧ "R" means the channel is recording
- ✧ "M" means the channel is being motion detection
- ✧ "I" means the channel is being alarm
- ✧ "H" means there is no HDD, the HDD is bad or the space of HDD is full

6. Question: Why DVR has the problem of real-time image, such as video image color, serious bright distortion?

Answer:

- ✧ BNC output, selectable PAL and NTSC is not correct, the image will be black and white
- ✧ DVR does not match with monitor
- ✧ The video transmission distance is too far
- ✧ The setting of dvr color , brightness and so on are wrong

7. Question: Why there is no voice when monitoring?

Answer:

- ✧ Check if it is using positive sound box or speaker, users can have short circuit to check.
- ✧ Is activation of the audio source connected to the video channel? You can click to full-screen to determine.
- ✧ The hardware of DVR is fault

8. Question: Why there is no voice when playing back?

Answer:

- ✧ Setting problem: open audio-video item
- ✧ Check the audio whether it is closed in playback interface

9. Question: Why the system time is not right?

Answer:

- ✧ Setting wrong, or users didn't click "Edit" to make it validity
- ✧ Battery not connected well
- ✧ The battery is invalid. Please change one.

10. Question: Why DVR can't control the PTZ?

Answer:

- ✧ The front-end PTZ is fault
- ✧ The PTZ decoder setting, connecting and installing is not correct
- ✧ The connect is not correct
- ✧ The PTZ setting of DVR is not correct
- ✧ The PTZ decoder does not match with the DVR agreement
- ✧ When connecting multi decoder, 120 Ω electric resistances should add at the end of PTZ decoder AB line, or else PTZ will not be stable.
- ✧ The distance is too far

11. Question: Why the "Stop recording" by the right mouse button does not work, how to stop recording?

Answer: :

- ✧ The "Stop recording" by the right mouse button is only suitable for Manual recording. It can't stop recording when it's in "start recording" or the video in

video plan.

- ✧ If you want to stop recording, please set the time is not recording.

12. Question: How much space of HDD for recording per hour?

Answer:

- ✧ Each channel takes about 14Mbyte for audio recording
- ✧ HDD space cost is related with “Best, Good, Middle” in “Record mode>Bit rate” and the video size of the period. If the video is still, HDD cost will be small; if the video is moving, HDD cost will be large. “Best” will take 320Mbyte of each channel per hour; “Good” 50~100Mbyte of each channel per hour when video is still or few moving, 100~200 M byte of each channel per hour when video has big moving or much moving; “Middle” 50~100Mbyte of each channel per hour when video is still or few moving, 100~150 M byte of each channel per hour when video has big moving or much moving.

13. Question: Why it can't do motion detection?

Answer: :

- ✧ The setting of the area of motion detection is not correct.
- ✧ Low sensitivity

14. Question: CD-writer/USB backup error

Answer:

- ✧ The data exceeds the capacity of backup device
- ✧ The backup device is incompatible
- ✧ The backup device is damaged

15. Question: Why I/O alarm does not work?

Answer:

- ✧ The alarm setting is not correct
- ✧ The alarm line connection is not correct
- ✧ The alarm input signal is not correct
- ✧ An alarm device connect two-loop access at the same time

16. Question: Why remote control can't work?

Answer: :

-
- ✧ The address of remote control is not correct
 - ✧ The distance of remote control is too far or the angle is too biased
 - ✧ Remote control batteries run out
 - ✧ Remote control is damaged or the front panel of dvr is damaged

17. Question: Why WEB can't log?

Answer:

- ✧ Please check the network whether it's connected. And check if the panel LINK or 100M LED display normally; use ping xxx.xxx.xxx.xxx (DVR IP) to check if the internet is well linked.
- ✧ Recommended Windows XP or Vista operating system, using IE6.0 browser or IE7.0 browser
- ✧ ActiveX control is been blocked. Please manual install ActiveX control.
- ✧ Please install DX8.1 and upgrade your video card driver

18. Question: There is no picture or not clear when you preview the recording or playback the recording by IE?

Answer:

- ✧ If you visit DVR by IE, please choose "Wan" in "web environment"
- ✧ Please try to "Close windows" by the right mouse button, and try to "Open windows"

19. Question: Why it displays " other members are setting....." While setting DVR by IE?

Answer:

- ✧ Please check the DVR configuration interface is in the state of open. Please exit DVR.