

Instructions to User

PC-68B Wrist Oximeter is a precision measuring device, please read the manual very carefully before using this device. Failure to follow these instructions may cause measuring abnormality or damage to the oximeter.

The Manual is published in English and Shenzhen Creative Industry Co., Ltd. has the ultimate right to explain the Manual. No part of this manual may be photocopied, reproduced or translated into another language without the prior written consent. Shenzhen Creative Industry Co., Ltd. reserves the right to improve and amend it at any time without prior notice.

Version of This Manual: Ver 1.1

Revised date: July 5, 2010

Copyright ©Shenzhen Creative Industry Co., Ltd.

All rights reserved.

3502-2290033

Notes:

- The contents contained in this manual are subject to change without prior notice.
- Information furnished by Creative is believed to be accurate and reliable. However, no responsibility is assumed by us for its use, or any infringements of patents or other rights of third parties that may result from its use.

Instructions for Safe Operations



- 💣 Check the device to make sure that there is no visible damage that may affect user's safety and measurement performance. When there is obvious damage, stop using the device.
- 💣 Necessary servicing must be performed by qualified service engineers **ONLY**. Users are not permitted to maintain it by themselves.
- 💣 The oximeter cannot be used together with the devices not specified in User Manual.

Cautions





- 💣 Explosive hazard—**DO NOT** use the oximeter in environment with inflammable gas such as some ignitable anesthetic agents.
- 💣 **DO NOT** use the oximeter while the testee is under

MRI or CT scanning.

Warnings

-  For individual patients, there should be a more prudent inspecting in the placing process. The device can not be clipped on the edema and tender tissue.
-  The light (the infrared light is invisible) emitted from the sensor is harmful to the eyes, so the user or even the service engineer should not stare at the light emitting components.
-  To dispose the device, the local law should be followed.

Attentions

-  Keep the oximeter away from dust, vibration, corrosive substances, explosive materials, high temperature and moisture.
-  The device should be kept out of the reach of children.
-  If the oximeter gets wet, please stop operating it. When it is carried from cold environment to warm and humid environment, please do not use it immediately.
-  **DO NOT** operate the button on front panel with

sharp materials.



High temperature or high pressure steam disinfection to the oximeter is not permitted. Refer to related chapter for instructions of cleaning and disinfection.

Declaration of Conformity:

The manufacturer hereby declares that this device complies with the following standards:

IEC 60601-1

ISO 9919

and follows the provisions of the council directive MDD93/42/EEC.

Table of Contents

1 OVERVIEW	1
1.1 Appearance	1
1.2 Name and Model	2
1.3 Conformation	3
1.4 Features	3
1.5 Intended Use	4
1.6 Key of Symbols	5
2 BATTERY INSTALLATION.....	6
3 OPERATION.....	7
3.1 Measuring Operation.....	7
3.2 Menu Operation	15
3.3 Upload Data	21
3.4 Low Battery Indication	22
4 ADDITIONAL ADVICE FOR OPERATION.....	22
5 TECHNICAL SPECIFICATIONS.....	23
6 ACCESSORIES.....	25
7 REPAIR AND MAINTENANCE	25
7.1 Maintenance	25
7.2 Cleaning and Disinfecting Instruction	26
8 TROUBLESHOOTING	27
9 APPENDIX	29
A Common Knowledge for SpO₂ Measurement	29
B Wristband Installation and Disassembly	32

1 Overview

1.1 Appearance



Figure 1 Front View

1. LCD screen

2. Set key: shift display modes, confirm the operation etc.

3. Scroll key: short press: move display cursor, modify parameter values etc.

Longtime press: choose display always on or not which will be effective during measuring.

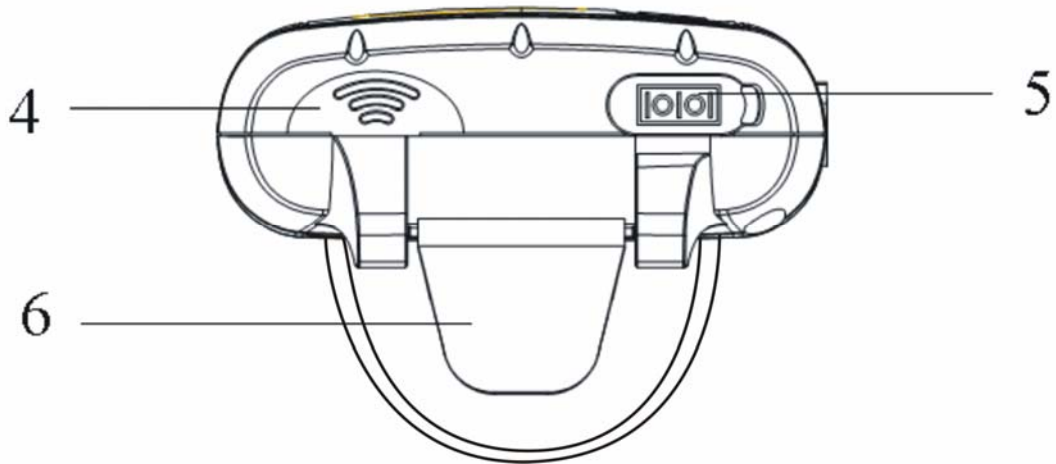

Figure 2 Frontal Side View

4. Buzzer

5. Data interface

6. Wristband Underlay

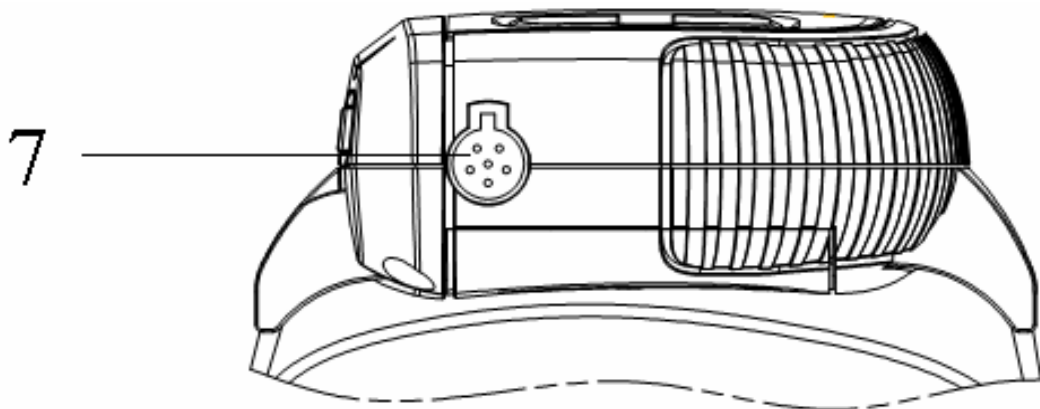

Figure 3 Right Side View

7. SpO₂ probe receptacle

1.2 Name and Model

Name: Wrist Oximeter

Model: PC-68B

1.3 Conformation

It comprises the main unit and SpO₂ probe.

1.4 Features

Wrist Oximeter can be used to monitor pulse oxygen saturation (SpO₂) and pulse rate accurately. Simply put your finger into sensor, SpO₂ value and pulse rate value will be displayed on screen and stored in the device.







- It is lightweight, small in size and easy to carry;
- Color dot-matrix LCD display;
- Perfusion index (PI) display is available;
- Automatic start to measure SpO₂ and Pulse Rate(PR);
- Real-time clock display and set;
- Audible & visual alarm function;
- Record interval can be selected, up to 480 hours data memory;
- Applicable for longtime continuous monitoring;
- PR trend curve and SpO₂ trend curve view;
- Data storage and transmission to PC for view and analysis;

- Smart battery power management with low battery indication;

1.5 Intended Use

The Wrist Oximeter is intended to use in hospital, other medical community and at home. It is available and convenient for you to monitor SpO₂ in long-term while sleeping or at other daily activity simultaneously.

1.6 Key of Symbols

Symbol	Description
	With Type BF applied part
	Warning — See User Manual
%SpO ₂	Pulse Oxygen Saturation
PI%	Perfusion Index
PR	Pulse Rate
	Pulse rate symbol
	Low battery voltage
	Symbol for display always on
	Memory full.
SN	Serial number
	Separate collection for this device.

2 Battery Installation

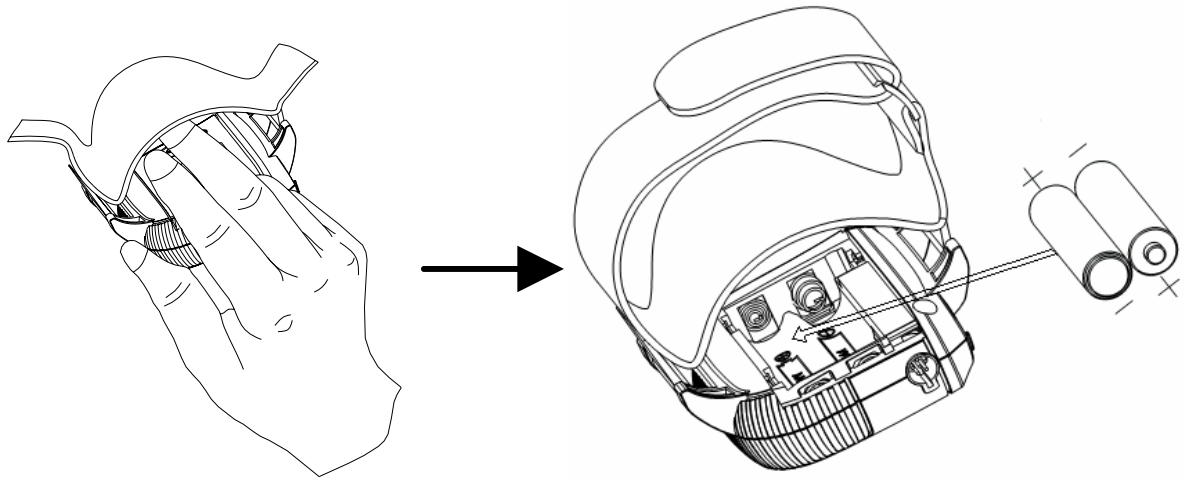

Figure 4 Battery Installation

1. Lift up the cloth covered on the battery cover. Then, use your index finger and middle finger to press against the battery cover. Meanwhile, slide it towards the side with SpO₂ probe (as shown in Figure 4).
2. Refer to Figure 4, insert two AAA size batteries into the battery compartment properly in the right direction.
3. Replace the cover.

Remark: After finishing battery installation, the oximeter will automatically power on and display software version number firstly.

⚠ Please take care when you insert the batteries, as the improper insertion may make the device not work.

3 Operation

3.1 Measuring Operation

1. Insert the external SpO₂ probe connector into SpO₂ probe receptacle properly.

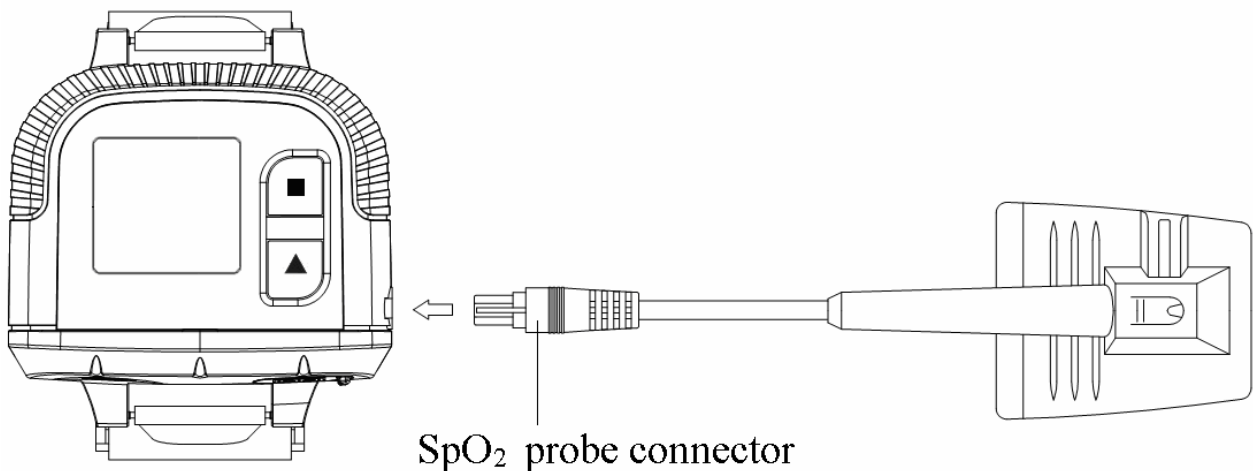

Figure 5 SpO₂ Probe Connection

2. Fix the oximeter on your left wrist (Figure 6);
3. Then, hold the probe with its opening towards your index finger. The probe should be oriented in such a way that the sensor side with a finger tip sign is positioned on the top (Figure 6).

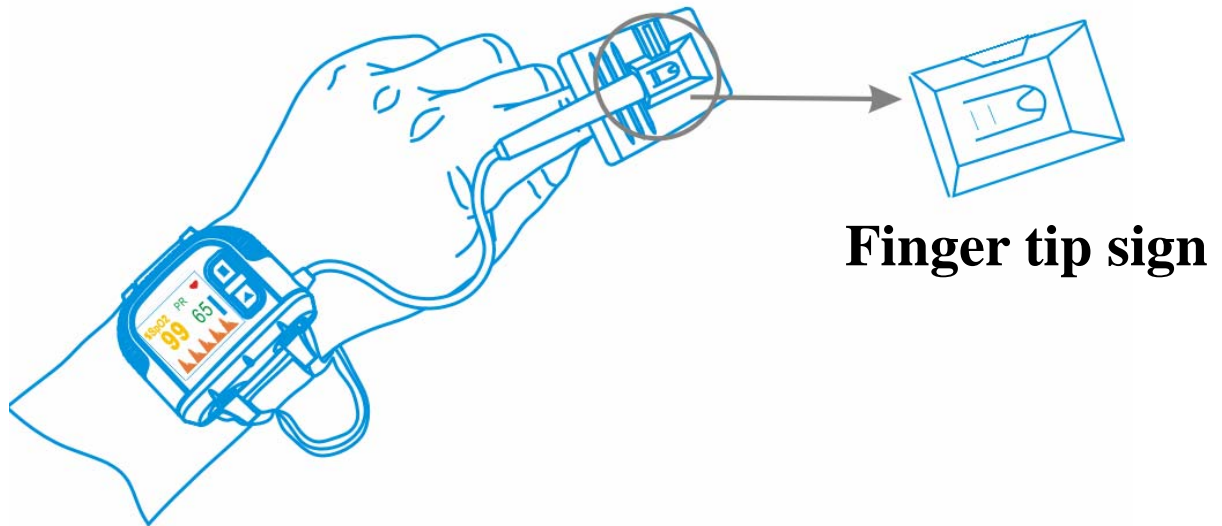

Figure 6 Placement Demonstration

4. Next, insert your index finger into the probe until the fingernail tip rests against the stop at the end of the probe (Figure 7). Adjust the finger to be placed evenly on the middle base of the sensor (make sure the finger is in the right position). If the index finger cannot be positioned correctly, or is not available, other finger can be used.

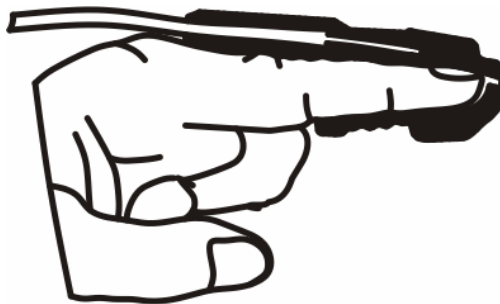
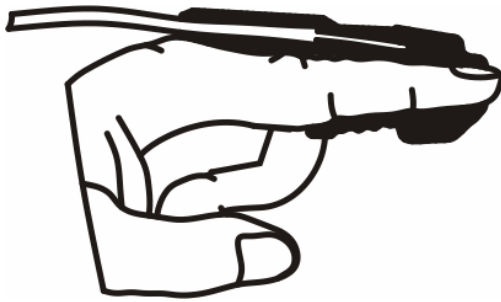

Figure 7

Wrong Placement of the Probe:



Finger out



Not deep enough

Figure 8

5. The oximeter will automatically start measurement in 2 seconds. Then the default screen will be displayed (Figure 9A). User can read the values and view the waveform from the display screen.

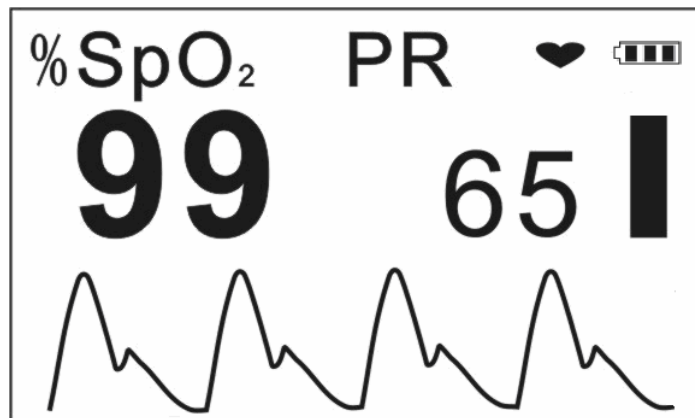



Figure 9A Default Screen

- ✧ “%SpO₂”: SpO₂ symbol; “99”: SpO₂ value;
- ✧ “PR”: Pulse rate icon; “65”: Pulse rate value;
- ✧ “♥”: Pulse beat symbol;
- ✧ “”: Battery indicator;
- ✧ “”: Pulse intensity bargraph.

- ✧ The waveform displayed in the lower area is SpO₂ plethysmogram.

Key Operations:

- Short time press “■” key to switch display modes circularly, display screen will be switched among the screens as shown in Figure 9A, Figure 9C and Figure 9D.
- Longtime press “▲” key: choose display always on or not which will be effective during measuring. If you choose display always on, the symbol for “display always on” will appear on the screen as shown in Figure 9B.

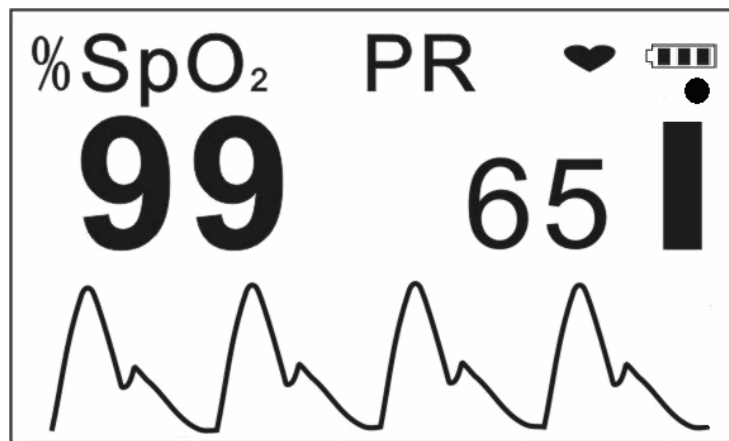

Figure 9B

- ✧ “●”: Symbol for display always on, it indicates that the LCD screen is always on during measuring. If the symbol is disappeared, it indicates that the LCD screen will be off after a period of display time during measuring for power saving.

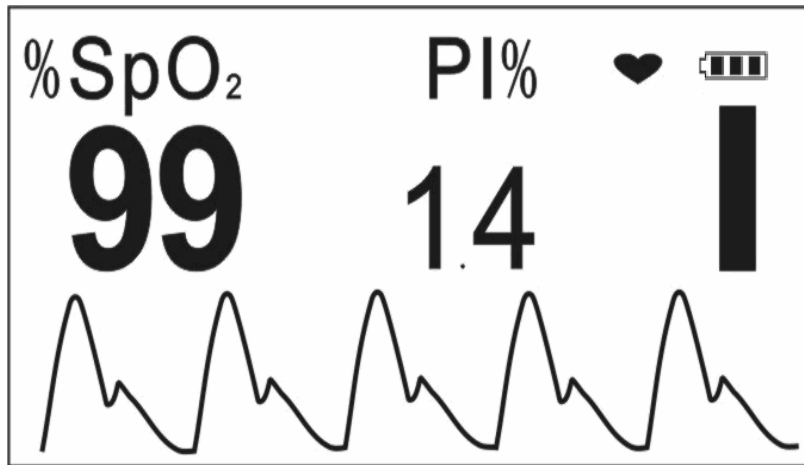

Figure 9C

✧ “PI%”: Perfusion index symbol;

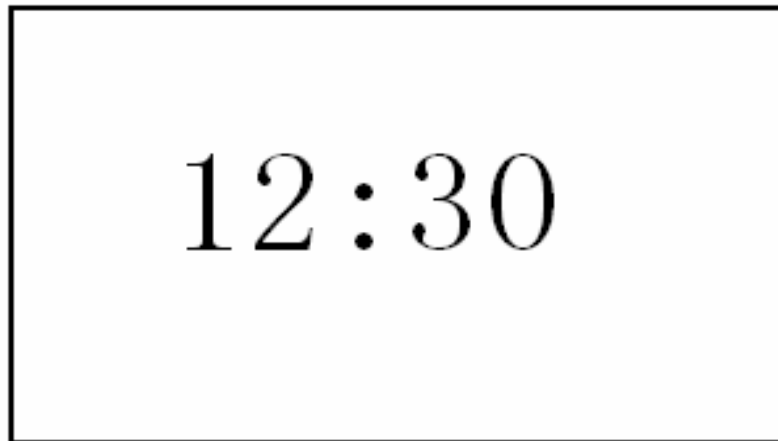

Figure 9D Real Time Clock

✧ “12:30”: the current time;

Key Operations:

- Longtime press “■” key, menu screen will be displayed, refer to section 3.2 for details;

6. Prompt information

- During monitoring, if you haven't inserted your finger into the probe, “Finger out ” will be prompted

on the screen.

- During monitoring, if the probe is not connected to the oximeter or the probe is off, “No Signal!” will be prompted on the screen, as shown in Figure 10.

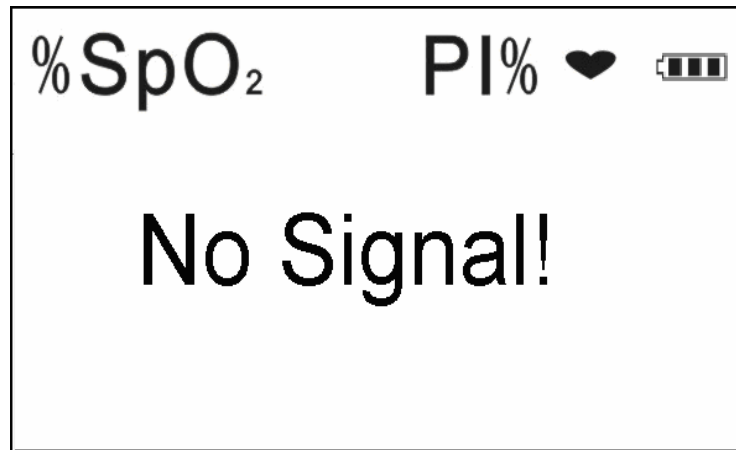



Figure 10 No Signal

- During measuring, if the memory is full or the total number of the records is 1024 pieces, the earliest records will be overwritten and the icon “” will appear on the screen for prompt, as shown in Figure 11.

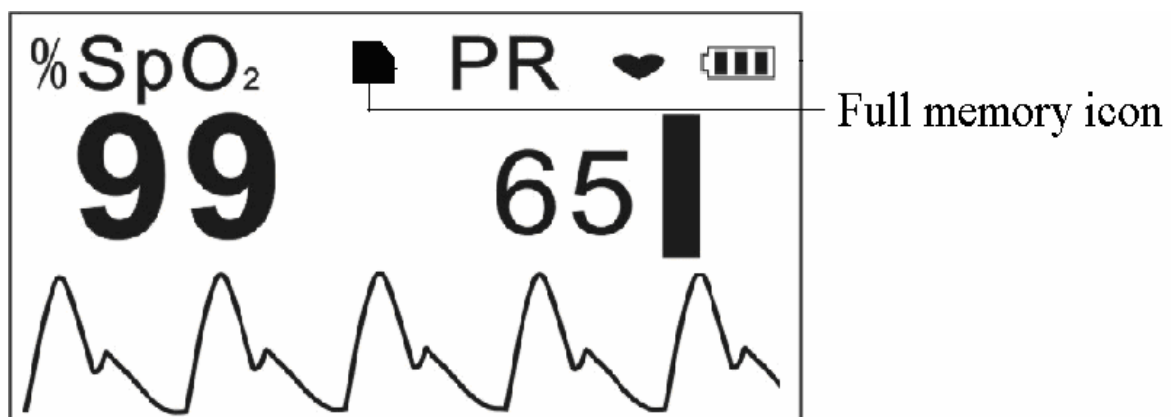

Figure 11 Memory Full

Note: It is suggested that the data shall be uploaded to computer for saving, or the earliest records will be overwritten.

Working Mode

- The measurement will start automatically when the finger is inserted into the soft rubber of the sensor, so the data recording (SpO₂ and PR values) starts simultaneously as well. The display is as shown in Figure 9A
- During measuring, if the display mode is not display always on (the symbol for “display always on” is not shown on screen) and no key button operation for 1 minute, the LCD display will be blank for power saving even when the measurement and data recording are still undergoing, but long time pressing any key will activate the display for viewing the current measuring information again.
- If there is no signal to be detected (e.g. finger off) for 20 seconds, the device will be at idle state (i.e. blank screen and standby for measurement).
- When the device is at idle state, long time pressing any key will activate the LCD display for measuring

default screen, or once the finger is inserted in the soft rubber of the sensor, the measurement will start and LCD display will be activated as well.

Note: During measuring, there is a green-dot flashing on the screen for indicating the measurement and data recording are undergoing when the display screen is blank, and if SpO₂ or/and PR values exceed the preset alarm limit, it will active the display and the value exceeded limit will flash.

3.2 Menu Operation

On display screen, longtime press “■” key menu screen will be displayed on the screen, as shown in Figure 12.

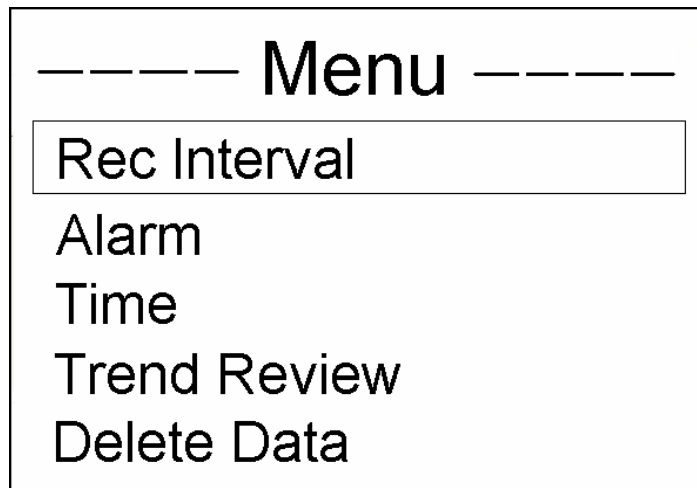

Figure 12 Menu Screen

- ✧ **Rec Interval:** set the interval to record SpO₂ and pulse rate data;
- ✧ **Alarm:** set SpO₂ low limit and pulse rate high/low limit;
- ✧ **Time:** set current time;
- ✧ **Trend Review:** view SpO₂ and pulse rate trend graph ;
- ✧ **Delete Data:** delete all the records.

Operation Instructions:

- **Short time press “▲” key:** shift cursor circularly;

- **Short time press “■” key:** confirm the selection and enter into the corresponding screen;
- **Longtime press “■” key:** back to the default screen;

3.2.1 Record Interval Settings

On menu screen, select “Rec Interval” and press “■” key to enter Record Interval Setting screen, as shown in Figure 13.

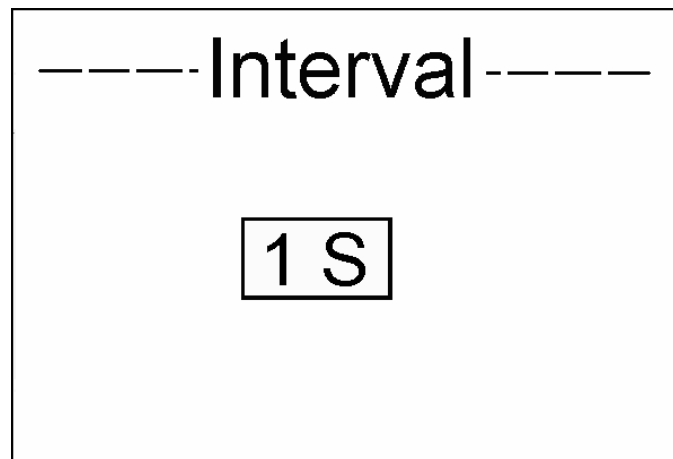

Figure 13 Record Interval Setting

Operation Instructions:

- **Short time press “■” key:** active the option;
- **Short time press “▲” key:** select record interval; three options: “1s”, “4s” and “8s”;
- **Short time press “■” key:** confirm the selection;
- **Longtime press “■” key:** back to the menu screen;

Note: The length of data record is limited to 30 seconds at least, and the maximal length for one record is also limited to 60 hours (for 1 second interval) , 240 hours (for 4 second interval) or 480 hours (for 8 second interval).

3.2.2 Alarm Limit Settings

On menu screen, select “Alarm Limit” and press “■” key to enter Alarm Limit Settings screen, as shown in Figure 14.

Alarm	
SpO ₂ Lo	85
PR Hi	120
PR Lo	50
Alarm	On

Figure 14 Alarm Limit Settings

- ✧ **SpO₂ Lo:** set SpO₂ low alarm limit;
- ✧ **PR Lo:** set pulse rate low alarm limit;
- ✧ **PR Hi:** set pulse rate high alarm limit;
- ✧ **Alarm:** enable/disable the audible & visual alarm function.

If SpO₂ value or/and PR value exceeds its/their alarm

limits during measuring, the oximeter will beep and the numerical value exceeded alarm limit will flash. Pressing “■” key can suspend the current beep sound.

Operation Instructions:

- **Short time press “▲” key:** shift cursor circularly;
- **Short time press “■” key:** active the option;
- **Short time press “▲” key:** increase numerical value one time;
- **Longtime press “▲” key:** increase numerical values continuously;
- **Short time press “■” key:** confirm the selection;
- **Longtime press “■” key:** back to the menu screen;

3.2.3 Time Settings

On menu screen, select “Time” and press “■” key to enter Time Settings screen, as shown in Figure 15.

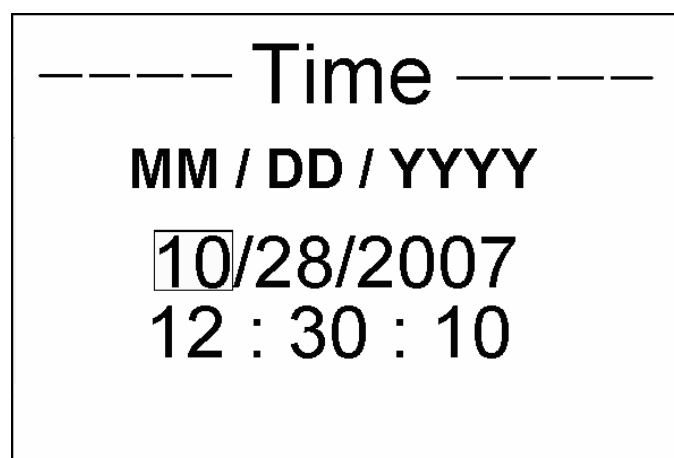

Figure 15 Time Settings

✧ **Date format:** MM/DD/YYYY;

✧ **Time format:** hh:mm:ss;

Operation Instructions:

- **Short time press “▲” key:** shift cursor circularly;
- **Short time press “■” key:** active the option;
- **Short time press “▲” key:** increase numerical value one time;
- **Longtime press “▲” key:** increase numerical value continuously;
- **Short time press “■” key:** confirm the modification;
- **Longtime press “■” key:** back to the menu screen;

3.2.4 Trend Review

On menu screen, select “Trend Review” and press “■” key to enter Trend Review screen, as shown in Figure 16.

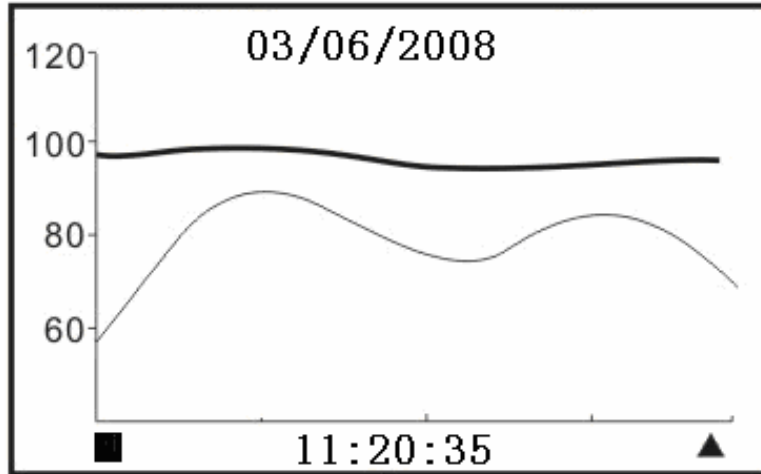

Figure 16 Trend Review Screen

- ✧ “03/06/2008”: date of the measurement
- ✧ “11:20:35”: initial time of trend graph displayed on this screen;
- ✧ “■ ▲”: Page scroll (left/ right) symbol;
- ✧ **Curves in the middle area:**
 - Green curve:** indicate pulse rate trend curve;
 - Orange curve:** indicate SpO₂ trend curve;

Operation Instructions:

- **Short time press “▲” key:** Page scroll right;
- **Short time press “■” key:** Page scroll left;
- **Longtime press “■” key:** back to the menu screen;

Note: when the display screen is menu screen or its submenu screen, the measurement will be interrupted.

3.2.5 Delete Data

On menu screen, select “Delete Data” and press “■” key to enter into Deletion Confirmation screen. Then, select “Yes” with “▲” key(short time press), after short time pressing “■” key, all the records will be deleted.

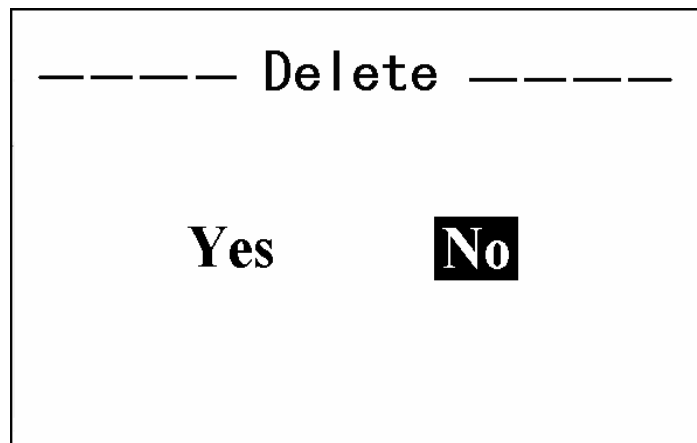
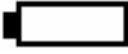

Figure 17 Delete Records

3.3 Upload Data

Before uploading the data to PC, please quit from the menu screen if you are doing the setup or trend view operation. When start uploading, connect the data cable between the device and PC, do the following operation by the instruction in “Oximeter Data Manager User Manual”, then the data uploading will be activated.

3.4 Low Battery Indication

If “” occurs on the screen, it indicates battery power is not enough, please change batteries. If you keep on using, after a while, when the batteries are exhausted, “Low Battery!” indication will be displayed and the oximeter will be off in 5 seconds.

4 Additional Advice for Operation

- The finger should be put properly and correctly.
- Avoid shaking finger as possible as you can during measuring;
- Do not put wet finger directly into sensor.
- Avoid placing the device on the same limb which is wrapped with a cuff for blood pressure measurement or during venous infusion.
- Do not let anything block the emitting light from device.
- Electrosurgical device interference may affect the measuring accuracy.
- Using enamel or other makeup on the nail may affect the measuring accuracy.

5 Technical Specifications

A. Display mode: Color OLED Display

B. Power supply requirement:

1.5V (AAA size) alkaline battery × 2

Supply voltage: 2.7V~3.3V

Continues working time (display is off): 70hours

C. Operating current: ≤40mA

D. SpO₂ Parameter Specifications

Measuring range: 35%~99%

Accuracy: 70%~75% ±3digits,

75%~99% ±2digits

E. Pulse Rate Parameter Specifications

Measuring range: 25bpm~250bpm

Accuracy: ±2bpm or ±2% (whichever is greater)

F. Perfusion Index Display

Range: 0%~20%

G. Performance under low perfusion condition

The accuracy of SpO₂ and PR measurement still meet the precision described above when the modulation

amplitude is as low as 0.6%.

H. Resistance to interference of surrounding light:

The difference between the SpO₂ value measured in the condition of indoor natural light and that of darkroom is less than $\pm 1\%$.

I. Resistance to 50Hz /60Hz interference:

SpO₂ and PR are precise which have been tested by BIO-TEK pulse oximeter simulator.

J. Dimensions: W 59mm×D 49mm×H 22mm

Net Weight: about 60g (not including batteries)

K. Classification

The type of protection against electric shock:
Internally powered equipment.

The degree of protection against electric shock:
Type BF applied part.

The degree of protection against harmful ingress of liquids: Ordinary equipment without protection against ingress of water.

Electro-Magnetic Compatibility: Group I, Class B

6 Accessories

- A data cable (optional)
- Oximeter Data Manager software (optional)
- A Wristband
- A SpO₂ Probe
- Two batteries (AAA)
- A User Manual
- Quality Certificate

Note: The accessories are subject to change. See the Packing List for detailed items and quantity.

7 Repair and Maintenance

7.1 Maintenance

The life of this device is 5 years. In order to ensure its long service life, please pay attention to the maintenance.

- Please change the batteries when the low-voltage indicator lightens.
- Please clean the surface of the device before using. Use cloth with alcohol to wipe the device first, and

then let it dry in air or wipe it dry.

- Please take out the batteries if the oximeter will not be used for a long time.
- The best storage environment of the device is -20°C to 55°C ambient temperature and less than 95% relative humidity.

⚠ High-pressure sterilization cannot be used on the device.

⚠ Do not immerse the device in liquid.

7.2 Cleaning and Disinfecting Instruction

- Surface-clean sensor with a soft gauze by wetting with a solution such as 75% isopropyl alcohol, if low-level disinfection is required, use a 1:10 bleach solution. Then surface-clean with a damp cloth and dry with a piece of cloth.
- Clean the wristband with soapy water. Please detach the wristband from the oximeter firstly.(Refer to Appendix for detailed disassembly method)

8 Troubleshooting

Trouble	Possible Reason	Solution
The SpO₂ and Pulse Rate display instable	<ol style="list-style-type: none"> 1. The finger is not placed far enough inside. 	<ol style="list-style-type: none"> 1. Place the finger correctly inside and try again.
Can not turn on the device	<ol style="list-style-type: none"> 1. The batteries are drained or almost drained. 2. The batteries are not inserted properly. 3. The device is malfunctioning. 	<ol style="list-style-type: none"> 1. Change batteries. 2. Reinstall batteries. 3. Please contact the local service center.
Fragmental trend curve of SpO₂ and PR	<ol style="list-style-type: none"> 1. Your finger is out of proper location in the probe. 2. Blood flow in the finger blocked. 3. Extreme movement 	<ol style="list-style-type: none"> 1. Adjust your finger location properly. 2. Make sure there is no object may occlude the blood flow. 3. Extreme movement may cause invalid measuring result.

Trouble	Possible Reason	Solution
Always display “No Signal”	<ol style="list-style-type: none">1. The probe is not connected to the oximeter properly.2. The finger is not placed well.3. The probe connector or the probe sensor is broken.	<ol style="list-style-type: none">1. Connect the probe to the oximeter properly and try again.;2. Place the finger properly and try again.3. Please contact the local service center.

9 Appendix

A Common Knowledge for SpO₂ Measurement

1 Meaning of SpO₂

SpO₂ is the saturation percentage of oxygen in the blood, so called O₂ concentration in the blood; it is defined by the percentage of oxyhemoglobin (HbO₂) in the total hemoglobin of the arterial blood. SpO₂ is an important physiological parameter to reflect the respiration function; it is calculated by the following method:

$$\text{SpO}_2 = \text{HbO}_2 / (\text{HbO}_2 + \text{Hb}) \times 100\%$$

HbO₂ are the oxyhemoglobins (oxygenized hemoglobin), Hb are those hemoglobins which release oxygen.

2 Principle of Measurement

Based on Lamber-Beer law, the light absorbance of a given substance is directly proportional with its density or concentration. When the light with certain wavelength emits on human tissue, the measured intensity of light after absorption, reflecting and attenuation in tissue can reflect the structure character of the tissue by which the light

passes. Due to that HbO₂ and Hb have different absorption character in the spectrum range from red to infrared light (600nm~1000nm wavelength), by using these characteristics, SpO₂ can be determined.

Clinical application of pulse oximeters: SpO₂ is an important physiological parameter to reflect the respiration and ventilation function, so SpO₂ monitoring used in clinical becomes more popularly, such as monitoring the patient with serious respiratory disease, the patient under anesthesia during operation, premature and neonate. The status of SpO₂ can be determined in time by measurement and find the hypoxemia patient earlier, thereby preventing or reducing accidental death caused by hypoxia effectively.

3 Factors affecting SpO₂ measuring accuracy (interference reason)

- ✧ Intravascular dyes such as indocyanine green or methylene blue
- ✧ Exposure to excessive illumination, such as surgical lamps, bilirubin lamps, fluorescent lights, infrared heating lamps, or direct sunlight.
- ✧ Vascular dyes or external used color-up product such as nail enamel or color skin care

- ✧ Excessive patient movement
- ✧ Placement of a sensor on an extremity with a blood pressure cuff, arterial catheter, or intravascular line
- ✧ Exposure to the chamber with High pressure oxygen
- ✧ There is an arterial occlusion proximal to the sensor
- ✧ Blood vessel contraction caused by peripheral vessel hyperkinesias or body temperature decreasing

4 Factors causing low SpO₂ Measuring value (pathology reason)

- ✧ Hypoxemia disease, functional lack of HbO₂
- ✧ Pigmentation or abnormal oxyhemoglobin level
- ✧ Abnormal oxyhemoglobin variation
- ✧ Methemoglobin disease
- ✧ Sulfhemoglobinemia or arterial occlusion exists near sensor
- ✧ Obvious venous pulsations
- ✧ Peripheral arterial pulsation becomes weak
- ✧ Peripheral blood supply is not enough

B Wristband Installation and Disassembly

Step 1: Fix the wristband on your left wrist(Fig.A).

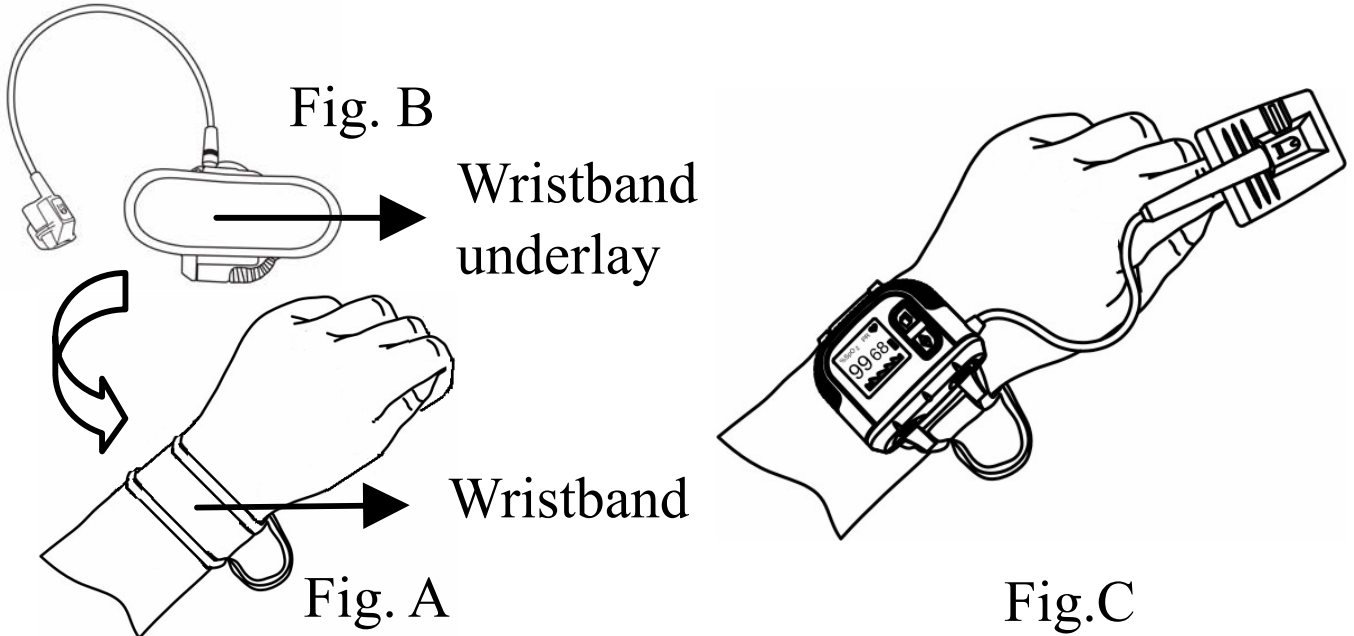

Step 2: Put the oximeter on the appropriate site of the wristband. Then press the oximeter to make the wristband underlay(Fig.B) stick to the wristband firmly. Next, follow the Fig.C to fix the oximeter well.

Step 3: The process of wristband disassembly is similar to the installation method, but with reverse procedure.



Note: Please detach the wristband from the oximeter before cleaning the wristband.
