



Indoor Zoom Dome Series Hardware Manual

B61, B62, B64, B65, B67

2015/01/08



ACTi
Connecting Vision

Table of Contents

Precautions 4

Safety Instructions	6
---------------------------	---

Introduction 7

The List of Models	7
Package Contents.....	8
Physical Description	9
Mounting Options	11
Other Mounting Accessories	13

Before Installation..... 14

Prepare the Power Adapter (Optional)	14
Prepare the DI/DO Connector (Optional)	16
Preparing Audio In / Out Devices (Optional)	19

Installing the Camera on a Surface 20

Step 1: Drill the Holes.....	20
Step 2: Open the Dome Cover	21
Step 3: Install the Camera to the Surface	22
Step 4: Connect the Cable(s).....	23
Step 5: Access the Camera Live View.....	23
Step 6: Adjust the Viewing Angle	24
Step 7: Close the Dome Cover.....	25

Other Accessories 27

Replacing the Dome Cover	27
Using a Memory Card.....	29
How to Insert the Memory Card	29
How to Remove the Memory Card.....	29

Accessing the Camera 30

Configure the IP Addresses.....	30
Access the Camera.....	34

Precautions

Read these instructions

You should read all the safety and operating instructions before using this product.

Heed all warnings

You must adhere to all the warnings on the product and in the instruction manual. Failure to follow the safety instruction given may directly endanger people, cause damage to the system or to other equipment.

Servicing

Do not attempt to service this video device yourself as opening or removing covers may expose you to dangerous voltage or other hazards. Refer all servicing to qualified service personnel.

Trademarks

All names used in this manual are probably registered trademarks of respective companies.

Liability

Every reasonable care has been taken during the writing of this manual. Please inform your local office if you find any inaccuracies or omissions. We cannot be held responsible for any typographical or technical errors and reserve the right to make changes to the product and manuals without prior notice.

Federal Communications Commission Statement



This equipment has been tested and found to comply with the limits for a class B digital device, pursuant to Part 15 of the FCC Rules. These limits are designed to provide reasonable protection against harmful interference in a residential installation. This equipment generates, uses, and can radiate radio frequency energy and, if not installed and used in accordance with the instructions, may cause harmful interference to radio communications. However, there is no guarantee that interference will not occur in a particular installation. If this equipment does cause harmful interference to radio or television reception, which can be determined by turning the equipment off and on, the user is encouraged to try to correct the interference by one or more of the following measures:

- Reorient or relocate the receiving antenna.
- Increase the separation between the equipment and receiver.
- Connect the equipment into an outlet on a circuit different from that to which the receiver is connected.
- Consult the dealer or an experienced radio/TV technician for help.

Warning: Changes or modifications to the equipment that are not expressly approved by the responsible party for compliance could void the user's authority to operate the equipment.

European Community Compliance Statement



This product has been tested and found to comply with the limits for Class B Information Technology Equipment according to European Standard EN 55022 and EN 55024. In a domestic environment, this product may cause radio interference in which cause the user may be required to take adequate measures.

Safety Instructions

Cleaning

Disconnect this video product from the power supply before cleaning.

Attachments

Do not use attachments not recommended by the video product manufacturer as they may cause hazards.

Do not use accessories not recommended by the manufacturer

Only install this device in a dry place protected from weather

Servicing

Do not attempt to service this video product yourself. Refer all servicing to qualified service personnel.

Damage Requiring service

Disconnect this video product from the power supply immediately and refer servicing to qualified service personnel under the following conditions.

- 1) When the power-supply cord or plug is damaged
- 2) If liquid has been spilled, or objects have fallen into the video product.
- 3) If the inner parts of video product have been directly exposed to rain or water.
- 4) If the video product does not operate normally by following the operating Instructions in this manual. Adjust only those controls that are covered by the instruction manual, as an improper adjustment of other controls may result in damage, and will often require extensive work by a qualified technician to restore the video product to its normal operation.





Safety Check

Upon completion of any service or repairs to this video product, ask the service technician to perform safety checks to determine if the video product is in proper operating condition.

Introduction

The List of Models

This hardware manual contains the following models:

B61		5MP Indoor Zoom Dome with D/N, Adaptive IR, Basic WDR, 3x Zoom lens
B62		5MP Indoor Zoom Dome with D/N, Adaptive IR, Basic WDR, 2.4x Zoom lens
B64		1.3MP Indoor Zoom Dome with D/N, Adaptive IR, Basic WDR, SLLS, 3x Zoom lens
B65		2MP Indoor Zoom Dome with D/N, Adaptive IR, Basic WDR, SLLS, 3x Zoom lens
B67		3MP Indoor Zoom Dome with D/N, Adaptive IR, Superior WDR, 3x Zoom lens

From the installation perspective these models are very similar; therefore you can use one manual for all of them.

Package Contents

<p>Camera</p>	<p>Mounting Screw Kit</p>	<p>Hexagon Screwdriver</p>
		
<p>Drill Template</p>	<p>Quick Installation Guide</p>	<p>Warranty Card</p>
		
<p>Terminal Block (for Power)</p>	<p>Terminal Block (for DI/DO)</p>	<p>Terminal Block (for Audio In/Out)</p>
		

Physical Description



1) Ethernet Port

Connects to a network using an Ethernet cable.

2) Memory Card Slot

Insert a memory card into this slot for local recording purposes. See [Using a Memory Card](#) on page 29 for more information.

NOTE: Supports microSDHC and microSDXC cards.

3) Digital Input / Output (DI/DO)

This connector connects to digital input or output devices, such as an alarm trigger, panic button, etc. Digital Input (DI) and Digital Output (DO) devices are used in applications like motion detection, event triggering, alarm notifications, etc. See [Prepare the DI/DO Connector \(Optional\)](#) on page 16 for information on how to connect DI/DO devices to your camera.

4) Audio Input / Output

This connector connects to audio input and output devices, such as microphones and speakers, using the bundled terminal block. See [Preparing Audio In / Out Devices \(Optional\)](#) on page 19 for more information.

5) DC 12V Power Input

In case the camera is connected to a non-PoE (Power over Ethernet) switch, use this connector to connect the camera to an external power adapter (not included). See [Prepare the Power Adapter \(Optional\)](#) on page 14 for more information.

6) Reset Button

The purpose of reset button is to restore the factory default settings of the camera, including the administrator's password.

The reset button can be used for following purposes:









1. The administrator's password has been forgotten and therefore the camera cannot be accessed.
2. In case of IP address, mask, or allow/deny filter related issues, resulting with inability to modify these settings.
3. In case of connectivity issues or abnormal video quality.













How to do the reset properly?

Press and hold the reset button for 5 seconds.

Mounting Options

There are several mounting options that you can use to install the camera. Select the most suitable solution for your installation environment.

Mount Types	Accessories
Surface Mount	Suitable when mounting the camera directly on walls or ceilings without extra accessories. See Installing the Camera on a Surface on page 20 for mounting instructions.
Flush Mount	Suitable when mounting the camera discretely above dropped ceilings wherein only the dome cover will be visible underneath the ceiling.
	PMAX-1012 
Gang Box Converter	Suitable for locations which require the use of gang boxes. The Gang Box Converter is attached a “two-gang” box and the camera is installed on the Gang Box Converter. All cables are hidden inside the gang box.
	PMAX-0804 
Pendant Mount	Suitable when mounting the camera on hard and high ceilings.
	PMAX-0101 PMAX-0103 (Straight Tube with Bracket)   
	PMAX-0101 PMAX-0102 (Straight Tube)   

Mount Types	Accessories
Straight Wall Mount	Suitable when mounting the camera on straight walls.
	PMAX-0313 
Vertical Pole Mount	Suitable when mounting the camera on vertical poles.
	PMAX-0313 PMAX-0503   
Horizontal Pole Mount	Suitable when mounting the camera on horizontal poles.
	PMAX-0101 PMAX-0102 PMAX-0503     
Corner Mount	Suitable when mounting the camera on a corner wall.
	PMAX-0313 PMAX-0402   

Other Mounting Accessories

Accessories

PMAX-0104 (Extension Tube)



NOTE:

- For more information about the mounting solutions and accessories, please check the *Mounting Accessory Selector* in our website (<http://www.acti.com/mountingselector>).
- The above mounting accessories are not included in the package. Contact your sales agents to purchase.

Before Installation

This section describes the procedures in preparing the external devices that you can connect to the camera. The camera supports DC12V power input, Digital Input and Output (DI/DO) and Audio Input and Output devices using the bundled terminal blocks. The use of these devices, however, is optional.

Prepare the Power Adapter (Optional)

In case of using a non-PoE switch or your PoE switch has limited power supply, you can purchase a power adapter and directly connect the camera to a power outlet. The power adapter must be connected to the supplied terminal block before use.

To do this, follow the procedures below:

1. Loosen the screws of the **12V** and **GND** pins of the power terminal block.



2. Take note that a standard power adapter cable has two (2) different wires:

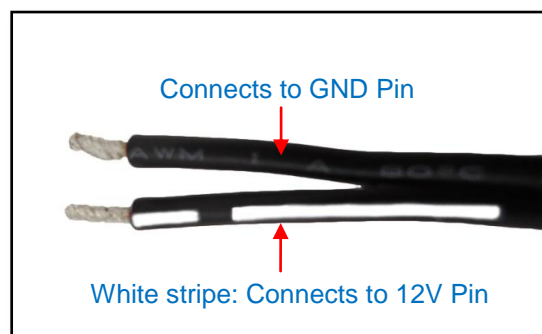

3. Connect the wire with the white stripe to the **12V** pin and the other to the **GND** pin.

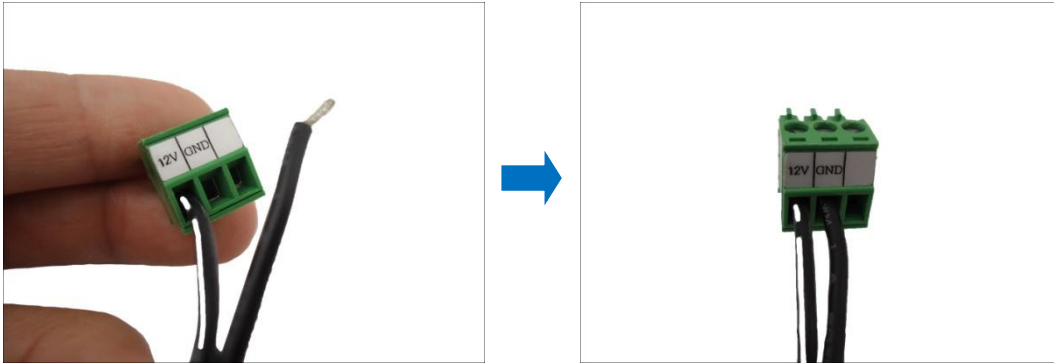

4. Tighten the screws of the **12V** pin and the **GND** pins to secure the wire connection.



5. Set the prepared power adapter for connection later. Below is an example of a power adapter with an attached terminal block.



NOTE: The power adapter is not bundled in the package.

Prepare the DI/DO Connector (Optional)

Depending on your surveillance needs, you may connect digital input or output devices to your camera to trigger events or notifications.

Digital Input (DI) devices can be used to notify the camera about an activity in the camera site. DI can be triggers of events. For example, you can connect a “panic button” to the camera; as such when the panic button is pressed, the alarm signal will be sent through the camera. Other common DI device applications are emergency button, smoke detector, passive infrared sensor, etc.

Digital Output (DO) devices are external devices that are activated by the camera upon an event inside the camera. For example, you can connect an “alarm horn” to the camera; as such when an event occurs inside the camera (e.g. detected intruder), the alarm horn will sound. Other common DO device applications are motion-triggered lights, electric fence, magnetic door locks, etc.

You can connect up to two DI and two DO devices to your camera.

Press and hold the orange tab as you insert the wire through the pin slot, then release the orange tab to secure the wire.

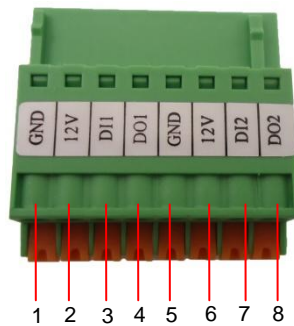

To connect input devices (DI), map the pins to one of the pin combinations below:

Device	Pin		Mapping Instructions
Digital Input 1 (DI1)	1	GND	Connect the wires of the first input device to GND (Pin 1) and DI1 (Pin 3).
	3	DI1	
Digital Input 2 (DI2)	5	GND	Connect the wires of the second input device to GND (Pin 5) and DI2 (Pin 7).
	7	DI2	

To connect output devices (DO), map the pins to one of the pin combinations below:

Device	Pin	Mapping Instructions
Digital Output 1 (DO1)	2	Connect the wires of the first output device to 12V (Pin 2) and DO1 (Pin 4).
	4	
Digital Output 2 (DO2)	6	Connect the wires of the second output device to 12V (Pin 6) and DO2 (Pin 8).
	8	

The table below shows the DI/DO connection specifications:

Device			
DI	Connection design		TTL - compatible logic levels
	Voltage	To trigger (low)	Logic level 0: 0V ~ 0.4V
		Normal (high)	Logic level 1: 3.1V ~ 30V
Current		10mA ~ 100mA	
DO	Connection design		Transistor (Open Collector)
	Voltage & Current		< 24V DC, < 50mA

Typical Connection

Based on these specifications, if the DI device has a voltage of 0V ~ 30V or the DO device has a voltage of < 24V (<50mA), then the camera can supply internal power to these devices and there is no need to connect the DI/DO device to an external power source.

In this case, wire connection to Pins 1 to 4. Use the **GND** and **DI1** pins to connect a DI device and use the **12V** and **DO1** pins to connect a DO device. See wiring scheme below:

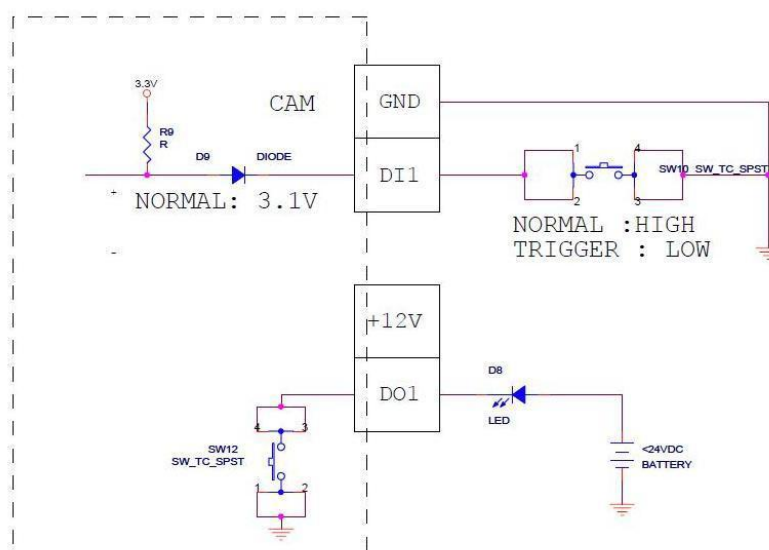

Consequently, to connect a second DI or DO device, wire the connection to Pins 5 to 8.

High Voltage DO Device Connection

Even though the camera provides 12V power, this may not be enough for some high voltage DO devices, such as a ceiling light or a motor that opens or closes a gate. In this case, there is a need to connect an external relay. See wiring scheme below:

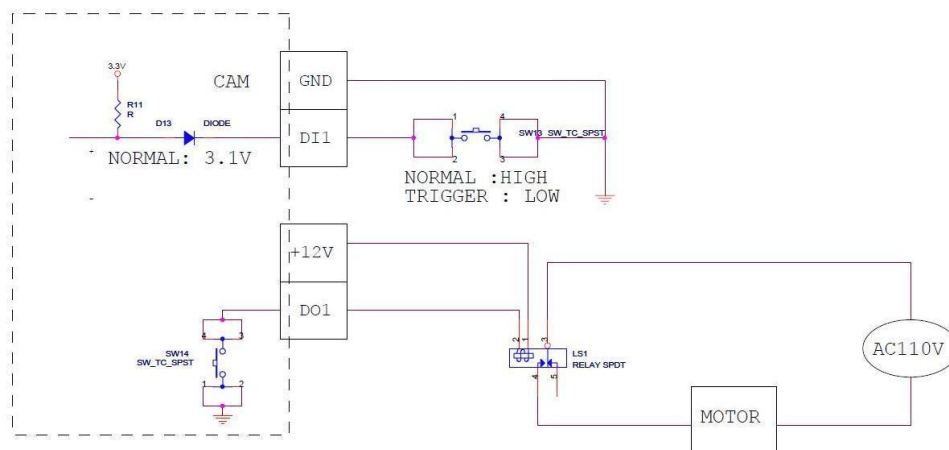

Note that when choosing an appropriate relay, please refer to its specifications and make sure they match the above design. The triggering circuit voltage has to be around 12V DC and the switch-controlled circuit voltage has to match the external power supply (e.g. 110V AC or 220V AC).

The illustration below is a graphic example of connecting a relay to a high voltage DO device.

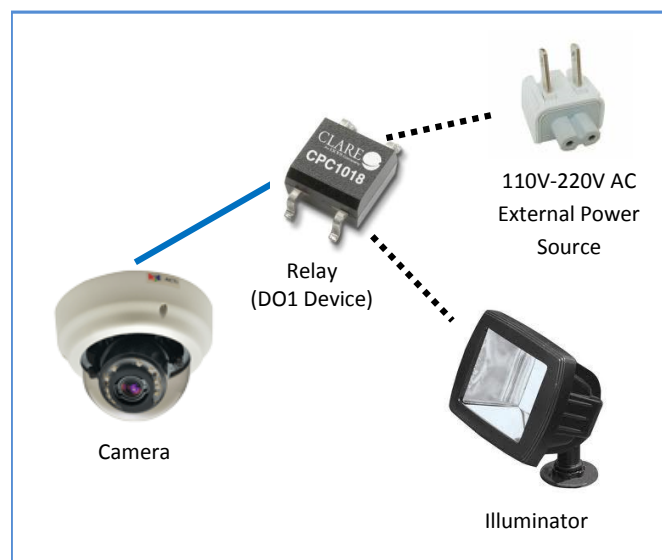

NOTE: For more information on DI/DO connections, please refer to the Knowledge Base article [All about Digital Input and Digital Output](http://www.acti.com/kb/detail.asp?KB_ID=KB20091230001) downloadable from the link below (http://www.acti.com/kb/detail.asp?KB_ID=KB20091230001).

Preparing Audio In / Out Devices (Optional)

Depending on your surveillance needs, you may connect audio input or output device, such as an active microphone or speaker, to your camera. In this case, you need to connect the audio input/output device to the supplied audio terminal block.



To connect audio input / output devices, map the pins to one of the pin combinations below:

Device	Pin		Mapping Instructions
Audio Output	1	GND	Connect the wires of the audio output device to GND (Pin 1) and AUDIO.OUT (Pin 2).
	2	AUDIO.OUT	
Audio Input	3	GND	Connect the wires of the audio input device to GND (Pin 3) and AUDIO.IN (Pin 4).
	4	AUDIO.IN	

Press and hold the orange tab as you insert the wire through the pin slot, then release the orange tab to secure the wire.

NOTE: For more information about AUDIO in connections, please refer to the Knowledge Base article [How to Use Audio-in of ACTi Cameras](http://www.acti.com/support/KnowledgeBase/outside/detail.asp?KB_ID=KB20100114003), downloadable from the link below (http://www.acti.com/support/KnowledgeBase/outside/detail.asp?KB_ID=KB20100114003).

Installing the Camera on a Surface

This section describes the procedures in installing the camera on a flat surface such as a hard or dropped ceiling and straight or tilted walls. Before installation, make sure the wall or the ceiling can bear more than the weight of the camera.

Step 1: Drill the Holes

Before drilling the holes on the ceiling or wall, note the direction of the connectors side of the camera, which is also the opposite side of the camera logo. This influences the camera placement and where you should drill the hole where the cables will pass through or how the cables will go along the ceiling or wall.

1. Attach the supplied drill template sticker on the surface according to the preferred orientation.
2. Determine how the cables will be routed: ***pass through the surface*** or ***along the surface***.
 - ***If the cables will pass through the surface***, drill the cable hole and the three (3) screw holes on the surface.

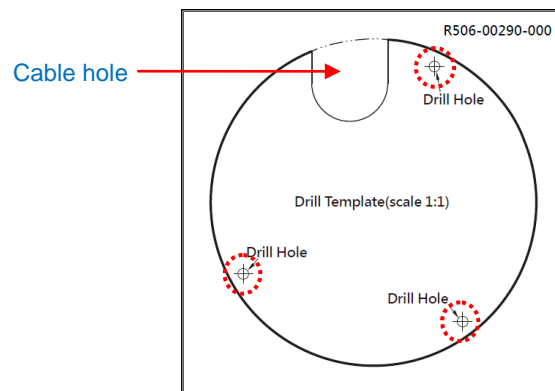

- ***If the cables will be routed along the surface***, just drill the three (3) screw holes on the surface.
3. Detach the drill template sticker from the surface and insert the plastic plugs into the screw holes.

Step 2: Open the Dome Cover

NOTE: To avoid scratches or leaving fingerprints on the dome cover, it is recommended to retain the plastic covering the dome cover until the camera is completely installed.

1. With the bundled hex screwdriver, loosen the three (3) screws securing the dome cover.



2. Lift to remove the dome cover.



3. ***If the cables will be routed along the ceiling or wall,*** remove the cable tab from the dome cover.



4. ***If the cables will pass through the ceiling or wall,*** route and pull the cables through the hole on the surface.

Step 3: Install the Camera to the Surface

1. If necessary, insert a memory card, with the metallic contacts facing down, into the card slot of the camera.



2. Align the camera screw holes and the cable hole (if necessary) to the holes on the surface and attach the three (3) supplied screws to secure the camera.



⚠ CAUTION: *When using electric screwdrivers*, be careful not to touch the camera components while attaching the screws. Since electric screwdrivers vary in sizes, speed, and force, they may bruise and damage the camera components.

DISCLAIMER: ACTi will not be responsible for camera damage caused by improper installations or the misuse of equipment for installation.

Step 4: Connect the Cable(s)

1. Connect the network cable to the Ethernet port of the camera.
 If necessary, connect other cable connectors (optional), like audio input/output, DC 12V power, and DI/DO to the corresponding connectors on the camera.



2. Connect the other end of the network cable to a switch or injector. Then, connect the switch or injector to a network or PC and a power source. See Power-over-Ethernet (PoE) connection example below.

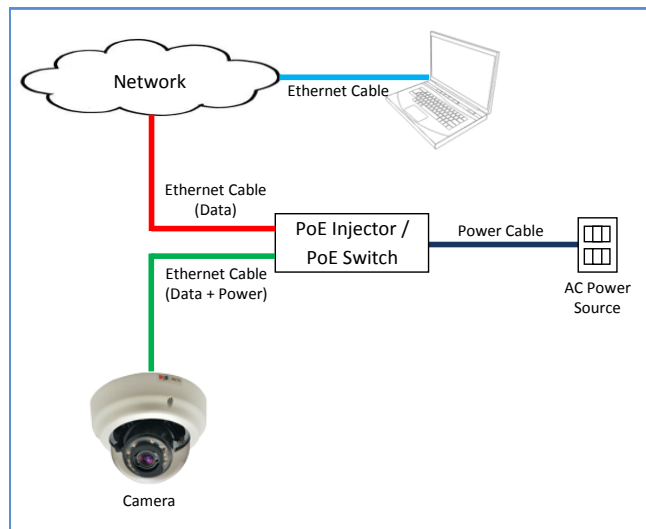

In case of using a non-PoE switch, power up the camera using a power adapter (not supplied). As needed, power up the other connected devices.

Step 5: Access the Camera Live View

See [Accessing the Camera](#) on page 30 for more information on how to access the Live View of the camera.

Step 6: Adjust the Viewing Angle

Camera Parts Overview



Adjustment Procedures

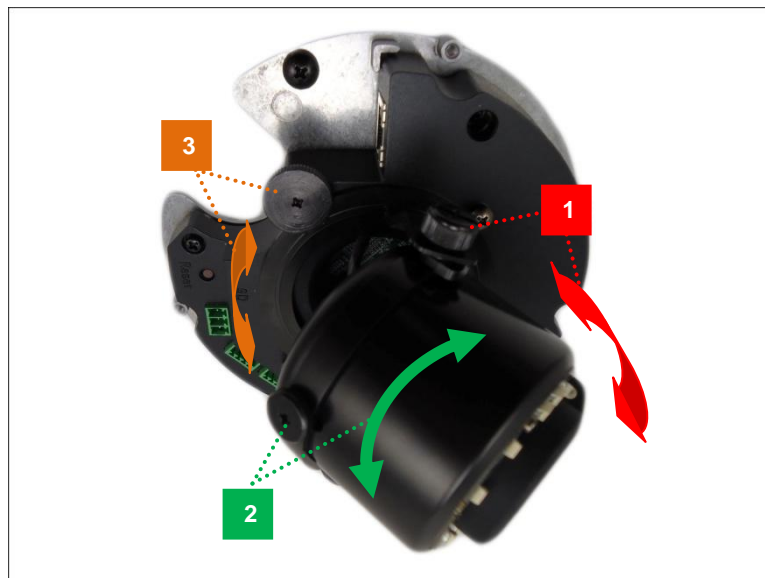

1. Loosen the tilt adjustment screws, adjust the tilt, and then tighten back the screws to fix the tilt position.
2. Loosen the rotation adjustment screw, rotate the viewing orientation, and then tighten back the screw to fix the orientation.
3. Loosen the pan adjustment screw, move the pan direction, and then tighten back the screw to fix the pan position.

Step 7: Close the Dome Cover

1. Align the screws with the screw holes of the camera. **Note that if the cables are routed along the ceiling or wall, route the cable to pass through the cable hole on the dome cover.**



2. Tighten the three (3) screws to attach the dome cover to the camera body.



3. Remove the plastic covering the dome cover.



Final installation should look similar to the illustration below.



Other Accessories

Replacing the Dome Cover

For more discrete surveillance needs, the bundled dome cover can be replaced with a smoke, vandal proof cover available for purchase. To replace the dome cover, do the following:

1. Loosen the three (3) screws to open the dome cover.



2. Remove the three (3) screws to detach the bracket.



3. Remove the bracket and dome cover from the cover housing.



4. Insert the replacement dome cover into the cover housing.



5. Align and attach the three (3) screws to secure the bracket to the cover housing.

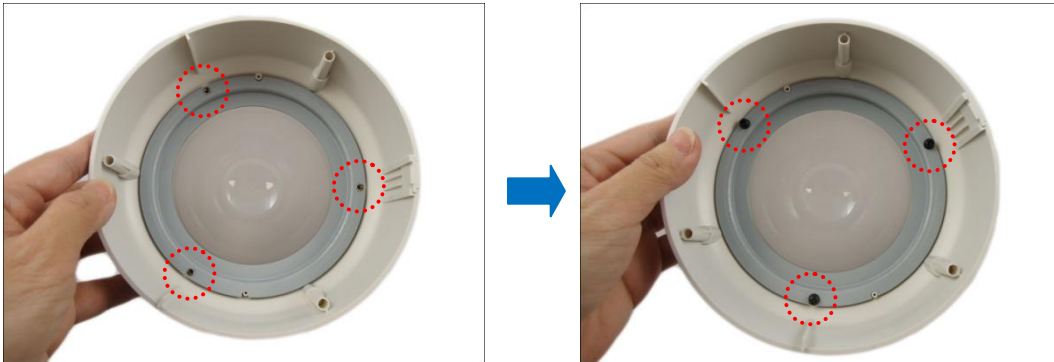

6. Attach the dome cover to the camera by tightening the three (3) screws. Final installation should look similar to the illustration below.

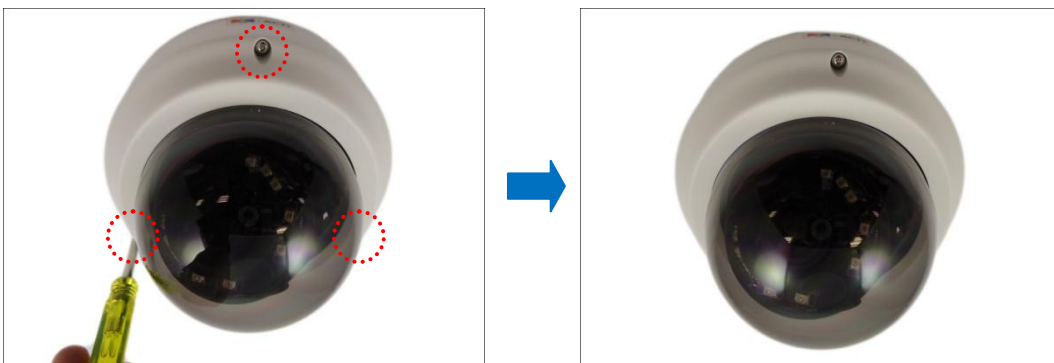

Using a Memory Card

The camera supports local video recording or saving of snapshots to a memory card.

NOTE: Supports microSDHC and microSDXC cards.

How to Insert the Memory Card

Insert a memory card into the card slot with the metallic contacts facing down the camera. Push the card until it clicks into place.



How to Remove the Memory Card

In case there is a need to remove the card, make sure to access the camera Web Configurator to safely “unmount” the card first (see the camera Firmware manual for more information). Once unmounted from the firmware, push the card to eject it from the slot.

Accessing the Camera

Configure the IP Addresses

In order to be able to communicate with the camera from your PC, both the camera and the PC have to be within the same network segment. In most cases, it means that they both should have very similar IP addresses, where only the last number of the IP address is different from each other. There are 2 different approaches to IP Address management in Local Area Networks – by DHCP Server or Manually.

Using DHCP server to assign IP addresses:

If you have connected the computer and the camera into the network that has a DHCP server running, then you do not need to configure the IP addresses at all – both the camera and the PC would request a unique IP address from DHCP server automatically. In such case, the camera will immediately be ready for the access from the PC. The user, however, might not know the IP address of the camera yet. It is necessary to know the IP address of the camera in order to be able to access it by using a Web browser.

The quickest way to discover the cameras in the network is to use the simplest network search, built in the Windows system – just by pressing the “Network” icon, all the cameras of the local area network will be discovered by Windows thanks to the UPnP function support of our cameras.

In the example below, we successfully found the camera model that had just connected to the network.

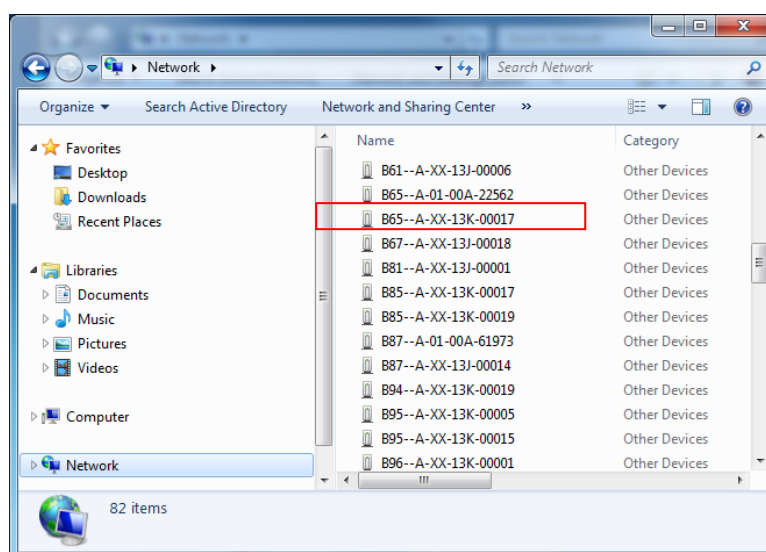

Double-click on the camera model name, the default browser of the PC is automatically launched and the IP address of the target camera is already filled in the address bar of the browser.

If you work with our cameras regularly, then **there is even a better way to discover the cameras in the network** – by using **IP Utility**. The IP Utility is a light software tool that can not only discover the cameras, but also list lots of valuable information, such as IP and MAC addresses, serial numbers, firmware versions, etc, and allows quick configuration of multiple devices at the same time.

The IP Utility can be downloaded for free from http://www.acti.com/IP_Utility

With just one click, you can launch the IP Utility and there will be an instant report as follows:

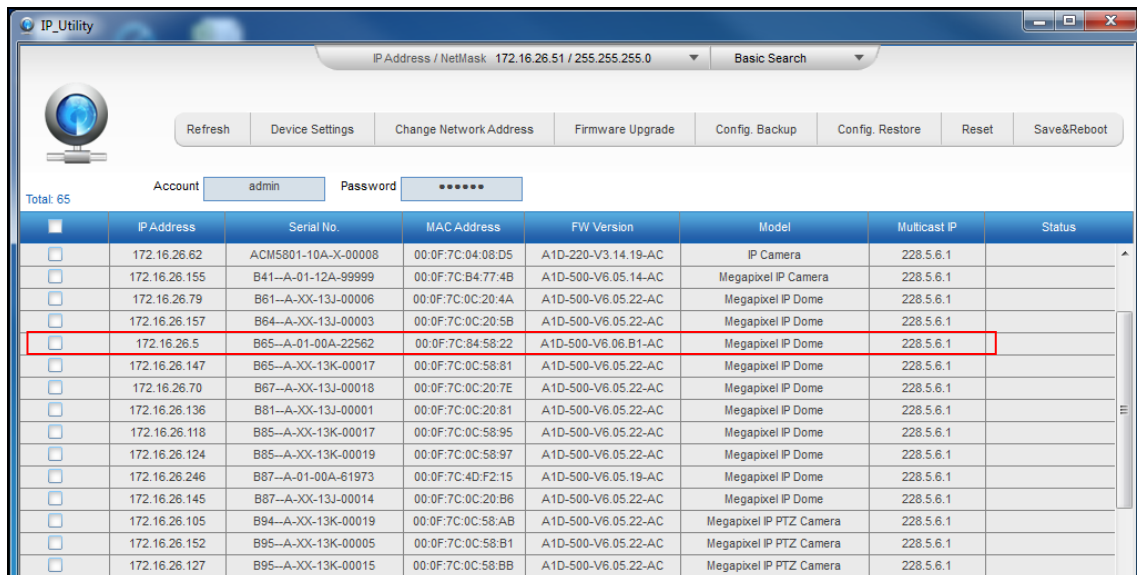

The screenshot shows the IP Utility application window. At the top, it displays the current IP address and netmask (172.16.26.51 / 255.255.255.0) and a search dropdown set to 'Basic Search'. Below this are several action buttons: Refresh, Device Settings, Change Network Address, Firmware Upgrade, Config. Backup, Config. Restore, Reset, and Save&Reboot. There are also input fields for 'Account' (admin) and 'Password' (masked with dots). A 'Total: 65' indicator is present above the table. The table itself has columns for IP Address, Serial No., MAC Address, FW Version, Model, Multicast IP, and Status. One row is highlighted with a red border, showing an IP of 172.16.26.5, Serial No. B65-A-01-00A-22562, MAC 00:0F:7C:84:58:22, FW Version A1D-500-V6.06.B1-AC, and Model Megapixel IP Dome.

IP Address	Serial No.	MAC Address	FW Version	Model	Multicast IP	Status
172.16.26.62	ACM5801-10A-X-00008	00:0F:7C:04:08:D5	A1D-220-V3.14.19-AC	IP Camera	228.5.6.1	
172.16.26.155	B41-A-01-12A-99999	00:0F:7C:B4:77:4B	A1D-500-V6.05.14-AC	Megapixel IP Camera	228.5.6.1	
172.16.26.79	B61-A-XX-13J-00006	00:0F:7C:0C:20:4A	A1D-500-V6.05.22-AC	Megapixel IP Dome	228.5.6.1	
172.16.26.157	B64-A-XX-13J-00003	00:0F:7C:0C:20:5B	A1D-500-V6.05.22-AC	Megapixel IP Dome	228.5.6.1	
172.16.26.5	B65-A-01-00A-22562	00:0F:7C:84:58:22	A1D-500-V6.06.B1-AC	Megapixel IP Dome	228.5.6.1	
172.16.26.147	B65-A-XX-13K-00017	00:0F:7C:0C:58:81	A1D-500-V6.05.22-AC	Megapixel IP Dome	228.5.6.1	
172.16.26.70	B67-A-XX-13J-00018	00:0F:7C:0C:20:7E	A1D-500-V6.05.22-AC	Megapixel IP Dome	228.5.6.1	
172.16.26.136	B81-A-XX-13J-00001	00:0F:7C:0C:20:81	A1D-500-V6.05.22-AC	Megapixel IP Dome	228.5.6.1	
172.16.26.118	B85-A-XX-13K-00017	00:0F:7C:0C:58:95	A1D-500-V6.05.22-AC	Megapixel IP Dome	228.5.6.1	
172.16.26.124	B85-A-XX-13K-00019	00:0F:7C:0C:58:97	A1D-500-V6.05.22-AC	Megapixel IP Dome	228.5.6.1	
172.16.26.246	B87-A-01-00A-61973	00:0F:7C:4D:F2:15	A1D-500-V6.05.19-AC	Megapixel IP Dome	228.5.6.1	
172.16.26.145	B87-A-XX-13J-00014	00:0F:7C:0C:20:B6	A1D-500-V6.05.22-AC	Megapixel IP Dome	228.5.6.1	
172.16.26.105	B94-A-XX-13K-00019	00:0F:7C:0C:58:AB	A1D-500-V6.05.22-AC	Megapixel IP PTZ Camera	228.5.6.1	
172.16.26.152	B95-A-XX-13K-00005	00:0F:7C:0C:58:B1	A1D-500-V6.05.22-AC	Megapixel IP PTZ Camera	228.5.6.1	
172.16.26.127	B95-A-XX-13K-00015	00:0F:7C:0C:58:BB	A1D-500-V6.05.22-AC	Megapixel IP PTZ Camera	228.5.6.1	

You can quickly notice the camera model in the list. Click on the IP address to automatically launch the default browser of the PC with the IP address of the target camera filled in the address bar of the browser already.

Use the default IP address of a camera:

If there is no DHCP server in the given network, the user may have to assign the IP addresses to both PC and camera manually to make sure they are in the same network segment.

When the camera is plugged into network and it does not detect any DHCP services, it will automatically assign itself a default IP:

192.168.0.100

Whereas the default port number would be **80**. In order to access that camera, the IP address of the PC has to be configured to match the network segment of the camera.

Manually adjust the IP address of the PC:

In the following example, based on Windows 7, we will configure the IP address to **192.168.0.99** and set Subnet Mask to **255.255.255.0** by using the steps below:

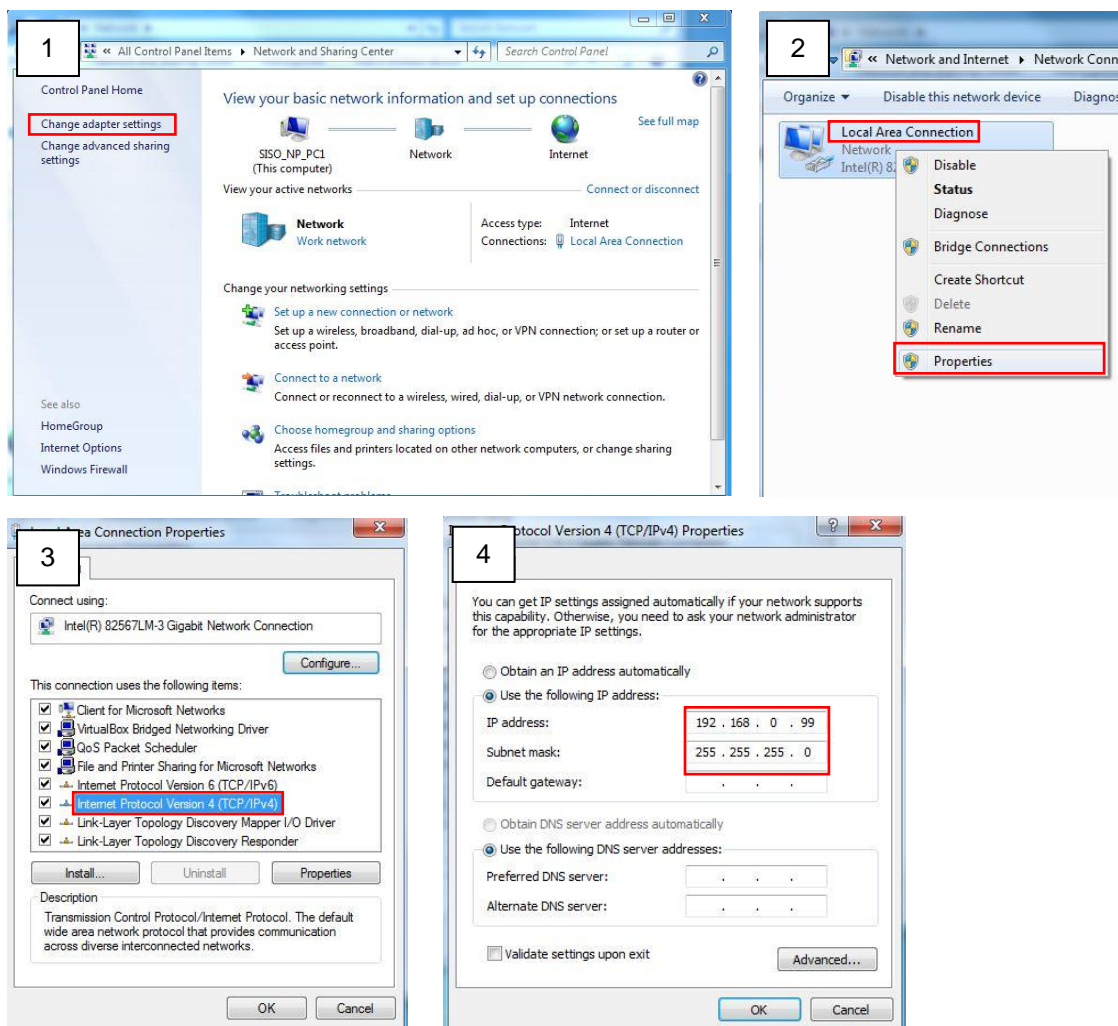

Manually adjust the IP addresses of multiple cameras:

If there are more than 1 camera to be used in the same local area network and there is no DHCP server to assign unique IP addresses to each of them, all of the cameras would then have the initial IP address of **192.168.0.100**, which is not a proper situation for network devices – all the IP addresses have to be different from each other. The easiest way to assign cameras the IP addresses is by using **IP Utility**:

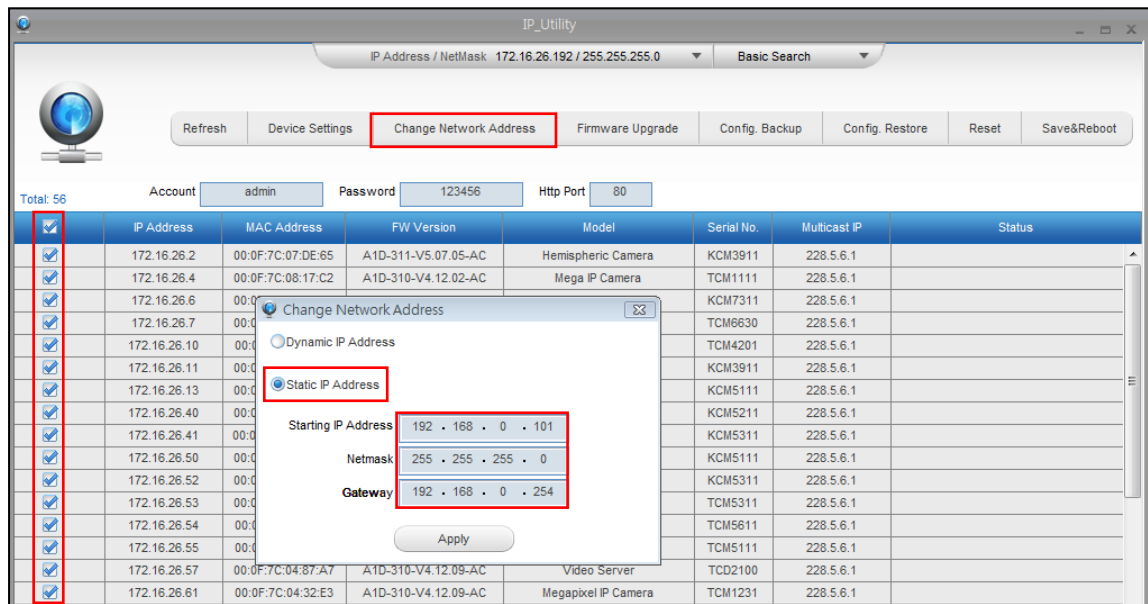

With the procedure shown above, all the cameras will have unique IP addresses, starting from 192.168.0.101. In case there are 20 cameras selected, the last one of the cameras would have the IP 192.168.0.120.

Later, by pressing the “Refresh” button of the IP Utility, you will be able to see the list of cameras with their new IP addresses.

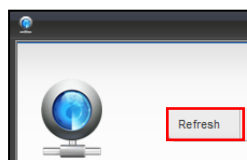

Please note that it is also possible to change the IP addresses manually by using the Web browser. In such case, please plug in only one camera at a time, and change its IP address by using the Web browser before plugging in the next one. This way, the Web browser will not be confused about two devices having the same IP address at the same time.

Access the Camera

Now that the camera and the PC are both having their unique IP addresses and are under the same network segment, it is possible to use the Web browser of the PC to access the camera.

You can use **any of the browsers** to access the camera, however, the full functionality is provided only for **Microsoft Internet Explorer**.

The browser functionality comparison:

Functionality	Internet Explorer	Other browsers
Live Video	Yes	Yes*
Live Video Area Resizable	Yes	No
PTZ Control	Yes	Yes
Capture the snapshot	Yes	Yes
Video overlay based configuration (Motion Detection regions, Privacy Mask regions)	Yes	No
All the other configurations	Yes	Yes

* When using non-Internet Explorer browsers, free third-party software plug-ins must be installed to the PC first to be able to get the live video feed from the camera:

Browser	Required Plug-In
Safari	QuickTime (http://www.apple.com/quicktime/download/)
Other non-Internet Explorer browsers	Basic VLC Media Player (http://www.videolan.org)

Disclaimer Notice: The camera manufacturer does not guarantee the compatibility of its cameras with VLC player or QuickTime – since these are third party softwares. The third party has the right to modify their utility any time which might affect the compatibility. In such cases, please use Internet Explorer browser instead.

When using Internet Explorer browser, the ActiveX control for video stream management will be downloaded from the camera directly – the user just has to accept the use of such control when prompted so. No other third party utilities are required to be installed in such case.

The examples in this manual are based on Internet Explorer browser in order to cover all functions of the camera.

Assuming that the camera's IP address is **192.168.0.100**, you can access it by opening the Web browser and typing the following address into Web browser's address bar:

http://192.168.0.100

Upon successful connection to the camera, the user interface called **Web Configurator** would appear together with the login page. The HTTP port number was not added behind the IP address since the default HTTP port of the camera is 80, which can be omitted from the address for convenience.

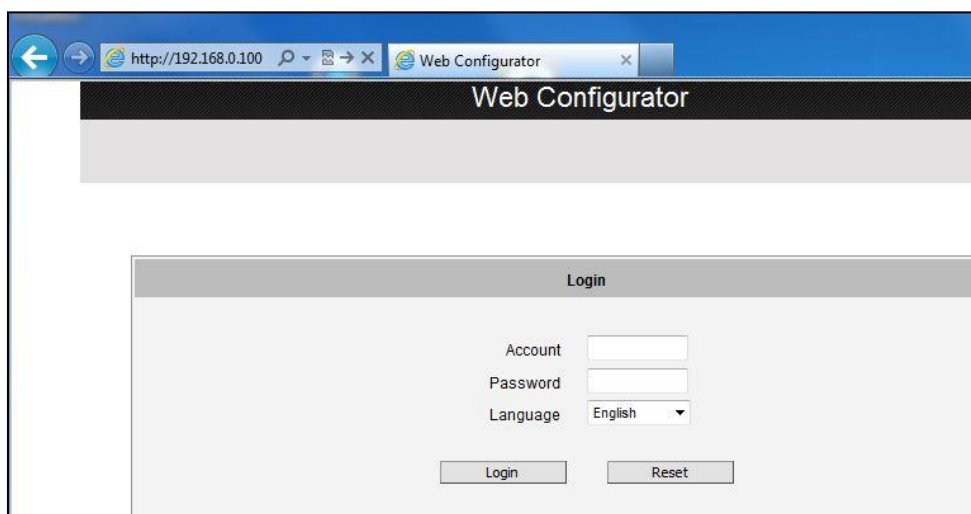

Before logging in, you need to know the factory default Account and Password of the camera.

Account: **Admin**

Password: **123456**

For further operations, please refer to the **Firmware User Manual**.



Copyright © 2014, ACTi Corporation All Rights Reserved

7F, No. 1, Alley 20, Lane 407, Sec. 2, Ti-Ding Blvd., Neihu District, Taipei, Taiwan 114, R.O.C.

TEL : +886-2-2656-2588 FAX : +886-2-2656-2599

Email: sales@acti.com