

PRIDE SPORTRIDER



SR-XL3

OWNER'S MANUAL

Manufactured by Wu's Tech Co. Ltd.

3 Fl. No. 112 Sec. 2, Chung-Shan N. Rd., Taipei, Taiwan, R.O.C.

Imported by Pride Mobility Products Australia Pty. Ltd.

20-24 Apollo Drive, Hallam, Victoria, Australia 3803



TABLE OF CONTENTS

1.	PREFACE AND INTRODUCTION.....	4
2.	SAFETY NOTICE.....	5
	2.1 Before Driving	
	2.2 While Driving	
	2.3 Labeling	
	2.4 EMI	
3.	PARTS INTRODUCTION.....	12
	Parts Description	
4.	OPERATION.....	13
	4.1 Control Parts Description	
	4.2 Instrument Meter	
	4.3 How To Operate Your Scooter	
5.	BATTERY CHARGING AND CARE.....	20
	5.1 Charging The Battery	
	5.2 Charger	
	5.3 Battery	
6.	INSPECTION AND MAINTENANCE.....	23
	6.1 Inspection	
	6.2 Regular Checking Record	
	6.3 Battery, Fuse And Tyre	
	6.4 Storage	
	6.5 Moving About	
7.	TROUBLE SHOOTING AND SPECIFICATION.....	26
8.	WARRANTY.....	28
	8.1 VIN (Vehicle Identification Number)	

1. PREFACE AND INTRODUCTION

Please carefully read this user's manual before using the vehicle. Improper use of the vehicle could result in harm, injury or traffic accidents. Therefore for maximum pleasure while using the vehicle please read this owner's manual.

- ◆ This owner's manual includes operation instructions for every aspect of the vehicle, assembly instructions, as well as instructions for how to deal with possible accidents.
- ◆ The symbols used in this manual are explained below:
Read especially the notes marked with these symbols:

 Warning	Improper usage could result in serious injury or death.
 Attention	Improper usage could lead to injury and/or damage to your scooter.
 Suggestion	Follow these instructions to keep your vehicle in a good operating order.

- ◆ This manual includes a copy of repair and maintenance record chart and warranty information. Please keep it in a safe place or in the scooter.
- ◆ If someone else uses the scooter, please make sure that you provide them with the instruction manual for his or her consideration.
- ◆ As designs change some illustrations and pictures in the manual may not correspond to the vehicle that you purchased. We reserve the right to make design modifications.

Our scooters have been designed and manufactured to provide a comfortable and secure yet affordable solution for some mobility requirements.

 Suggestion
To maximize your batteries efficiency and service life, please fully recharge your new battery before its first time use.

2. SAFETY NOTICE

2.1 BEFORE DRIVING

The user needs to be familiar with the usage and operation of this vehicle before driving. Therefore, please always keep the following safety notices in mind.

■ **The same traffic rules apply to the use of this vehicle as apply to pedestrians**

For your safety, please therefore follow the rules that apply to pedestrians.

- ◆ Please do not drive your scooter after consuming alcohol or when you are tired.
- ◆ Please be careful when driving your scooter in low light. It has not been designed for use at night.
- ◆ Never remove any of scooter safety parts like Anti-tip, Devices, Fenders, or Emergency Brake lever.

■ **Practice operating your vehicle**

Before using the scooter in busy or potentially dangerous areas, familiarize yourself with the operation of your scooter. Please practice in a wide and open area like a park. In order to avoid accidents with your scooter while driving, please bear in mind driving motions, such as accelerating, stopping, turning, reversing, up-and-down ramps.

- ◆ Drive slowly (place speed selector in low speed position) until you get used to the scooter.
- ◆ Watch carefully for pedestrians and drive your scooter accordingly. In crowded areas always drive with the speed selector at low speed.
- ◆ Drive only where permitted according to all applicable local laws and ordinances.
- ◆ Be sure someone accompanies you for safety when driving on the roads for the first time.
- ◆ Only use higher speed setting when you are confident that you can easily operate and control your scooter.

■ **The scooter is designed and built to carry ONE person only the single seat model or TWO persons on the double seat model.**

- ◆ Never operate it with an additional person on board, not even a child.

■ **Do not use this vehicle to carry or haul goods**

- ◆ As the maximum weight can be carried please refer to “MAX USER WEIGHT” in “9. SPECIFICATION”
- ◆ Maximum loading weight for basket is 30kg (66lb).

2. SAFETY NOTICE

2.2 WHILE DRIVING

■ **Please carry out daily inspections.** Refer to the section entitled “DAILY CHECKING”

■ **Do not move your body out of the vehicle while moving**

- ◆ Pay attention that your clothes do not tangle in the wheels.
- ◆ Such action may cause you to lose balance and risk injury from falling.

■ **Do not use your vehicle under the circumstances below.**

- ◆ On roads with heavy traffic or roads that are muddy, gravelly, bumpy, narrow, snowed over, icy, or canal towpaths not guarded by any fence or hedge. Keep away from places where you might get the wheels stuck.
- ◆ Do not drive when it is snowing, misty, or windy.
- ◆ Do not drive your vehicle in an “S” pattern or make erratic turnings.
- ◆ Never use the scooter for climbing up or riding down stairs.

■ **About Mobile Phones and other electrical equipment**

- ◆ Do not use a mobile phone or other wireless communication devices while driving.
- ◆ Always switch off the scooter and remove the ignition key before using a mobile phone.
- ◆ Do not charge the mobile phone or any other electrical devices from your scooter’s battery.

■ **Automatic Power Shut Down**

In order to avoid accidental battery run down, your scooter is equipped with an automatic power shut down facility. If the scooter is switched on, after remaining undisturbed for a period of thirty minutes it will automatically turn off. Should this occur, simply switch your scooter off and back on and it will be ready to use once again.

■ **Ramps, inclines and drops**

- ◆ Do not drive onto steep ramps greater than the specified gradient. Refer to the section entitled “CLIMBING ANGLE” in “9. SPECIFICATION”
- ◆ Always use a low speed setting when ascending or descending a gradient.
- ◆ Do not drive on roads with large drops or potholes. Refer to the section entitled “MAX. GROUND CLEARANCE” in “9. SPECIFICATION”.
- ◆ Do not cross water gutters where the width is too big and where is a risk of getting the wheels struck.
- ◆ Please slow down when driving on roads with inclines.
- ◆ Do not make sudden turns when driving on gravel roads or ramps.
- ◆ Always lean forward when climbing a steep gradient.

2. SAFETY NOTICE

■ Starting and Driving

1. Make sure the seat is installed properly.
2. Make sure the tiller has been secured properly.
3. Fold down the armrests so you can rest your arms on them.
4. Turn the power switch to “ON”. If necessary, turn on the headlights.
5. Check battery indicator to see whether there is enough power for your journey. If you have any doubt about the remaining power, please recharge the batteries before departure.
6. Set the speed dial to a position you feel safe and comfortable with.
7. Check the forward/reverse speed lever works correctly.
8. Make sure the electromagnetic brake works correctly.

⚠ WARNING!

- ◆ Do not set in the freewheel mode when driving on a gradient.
- ◆ Do not change the speed selector position while driving.
- ◆ Do not turn the main key switch to “OFF” position while in motion; this may cause abrupt and excessive deceleration which in turn may cause injury to the user and damage to the scooter.
- ◆ Always re-engage the anti-freewheel device before use. Fail to do so may result in injury.
- ◆ To protect your safety, the power will automatically cut off and electromagnetic brake system will activate while you are driving down a steep gradient. This will limit the speed to a safe level. Turn the power on again to re-start your scooter.
- ◆ **Maximum User Weight Limit**
Refer to section entitled “MAX. USER WEIGHT” in “9. SPECIFICATION “. Overloading past the weight limit may lead to damage of your scooter or cause it to malfunction and will endanger your safety. The warranty does not cover this type of damage.

📢 Attention

1. Do not set to the highest speeds while driving indoors.
2. Do not place magnetic devices near the area of the operation handle as this could affect the safe operation of your scooter.
3. Do be careful while driving in heavy traffic or crowded areas.
4. While reversing the vehicle, beware of people or objects behind you.
5. Do not release the manual release lever of electromagnetic brake when the scooter is on a slope.
6. If for any reason the scooter does not stop when you release the operating lever, immediately use the hard brake to stop the scooter and turn the main key switch to “OFF”.

2. SAFETY NOTICE

■ Stopping

1. Release the speed control lever completely. The vehicle will naturally brake and stop.
2. Turn the power switch to (OFF). Then pull out the key.

2.3 LABELING

Please carefully read all labels on the scooter before driving it. For your future reference, do not remove them.



2. SAFETY NOTICE

1. WARNING LABEL.....

WARNING:

Radio wave sources may affect Scooter or Power chair control
Radio wave sources, such as radio stations, TV stations, amateur radio (HAM) transmitters, two-way radios, and cellular phones, can affect powered motorized scooters or power chair. Following the warning listed below should reduce the chance of unintended brake release or powered scooter or power chair movement which could result in serious injury.

1. Do not turn ON hand-held personal communication devices, such as citizens band (CB) radios and cellular phones, while the powered scooter or power chair is turned ON.
2. Be aware of near by transmitters, such as radio or TV stations, and try to avoid coming close to them.
3. If unintended movement or brake release occurs, turn the powered scooter or Power chair OFF as soon as it is safe.
4. Be aware that adding accessories or components, or modifying the powered scooter or power chair, may make it more susceptible to interference from radio wave sources. (Note: There is no easy way to evaluate their effect on the over all immunity of the powered scooter or power chair.)
Report all incidents of unintended movement or brake release to the powered scooter or power chair manufacturer, and note whether there is a radio wave source nearby.
- 5.

2. CE LABEL



3. WARNING EMI LABEL.....



4. WARNING LIFT UP SHROUD LABEL.....



5. WARNING EMERGENCY FREEWHEEL DEVICE LABEL.....



6. MAIN CIRCUIT BREAKER INDICATOR LABEL.....



2. SAFETY NOTICE

2.4 EMI

This portion of the content will provide the user with basic information that describes the problems with EMI, known sources of EMI, protective measures either to lessen the possibility or exposure or to minimize the degree of exposure, and suggested action should unexpected or erratic movement occur.

Caution: It is very important that you read this information regarding the possible effects of electromagnetic interference on your electric scooter.

■ ELECTROMAGNETIC INTERFERENCE (EMI) FROM RADIO WAVE SOURCES

Powered vehicle may be susceptible to electromagnetic interference (EMI), which is interfering electromagnetic energy (EM) emitted from sources such as radio stations, TV stations, amateur radio (HAM) transmitters, two-way radios, and cellular phones. The interference (from radio wave sources) can cause the powered vehicle to release its brakes, move by itself, or move in unintended directions. It can also permanently damage the powered vehicle's control system. The intensity of the interfering EM energy can be measured in volts per meter (V/m). Each powered vehicle can resist EMI up to a certain intensity. This is called its "immunity level". The higher the immunity level, the greater the protection. At this time, current technology is capable of achieving at least a 20 V/m immunity level, which would provide useful protection from the more common sources of radiated EMI. This powered vehicle model as shipped, with no further modification, has an immunity level of 20 V/m without any accessories.

There are a number of sources of relatively intense electromagnetic fields in the everyday environment. Some of these sources are obvious and easy to avoid. Others are not apparent and exposure is unavoidable. However, we believe that by following the warning listed below, your risk to EMI will be minimized.

The sources of radiated EMI can be broadly classified into three types:

1. Hand-held portable transceivers (transmitter-receivers with the antenna mounted directly on the transmitting unit. Examples include: citizens band (CB) radios, "walkie talkie", security, fire, and police transceivers, cellular telephones and other personal communication devices.
2. Medium-range mobile transceivers, such as those used in police cars, fire trucks, ambulances and taxis. These usually have the antenna mounted on the outside of the vehicle.
3. Long-range transmitters and transceivers, such as commercial broadcast transmitter (radio and TV broadcast antenna towers) and amateur (HAM) radios.

2. SAFETY NOTICE

Note: Other types of hand-held devices, such as cordless phones, laptop computers, AM/FM radios, TV sets, CD player, and cassette players, and small appliances, such as electric shavers and hair dryers, so far as we know, are not likely to cause EMI problems to your powered vehicle.

■ **POWERED VEHICLE ELECTROMAGNETIC INTERFERENCE (EMI)**

Because EM energy rapidly becomes more intense as one moves closer to the transmitting antenna (source), the EM fields from hand-held radio wave sources (transceivers) are of special concern. It is possible to unintentionally bring high levels of EM energy very close to the powered vehicle's control system while using these devices. This can affect powered vehicle movement and braking. Therefore, the warnings listed below are recommended to prevent possible interference with the control system of the powered vehicle.

■ **WARNINGS**

Electromagnetic interference (EMI) from sources such as radio and TV stations, amateur radio (HAM) transmitters, two-way radios, and cellular phones can affect powered vehicles and motorized scooter. Following the warnings listed below should reduce the chance of unintended brake release or powered vehicle movement which could result in serious injury.

1. Do not operate hand-held (transceivers-receivers), such as citizens band (CB) radios, or turn ON personal communication devices, such as cellular phones, while the powered vehicle is turned ON.
2. Be aware of nearby transmitters, such as radio or TV stations, and try to avoid coming close to them.
3. If unintended movement or brake release occurs, turn the powered vehicle OFF as soon as it is safe.
4. Be aware that adding accessories or components, or modifying the powered vehicle, may make it more susceptible to EMI (Note: There is no easy way to evaluate their effect on the overall immunity of the powered vehicle).
5. Report all incidents of unintended movement or brake release to the powered vehicle manufacturer, and note whether there is a source of EMI nearby.

■ **IMPORTANT INFORMATION**

1. 20 Volts per meter (V/m) is a generally achievable and useful immunity level against EMI (the higher the level, the greater the protection).
2. This product has an immunity level of 20 V/m without any accessories and connected to it.

3. PARTS INTRODUCTION

PARTS DESCRIPTION

- | | | |
|---------------------|----------------------|-------------------------|
| 1. Hand Brake Lever | 2. Speed Lever | 3. Front Indicator Lamp |
| 4. Head Lamp | 5. Front Fender | 6. Seatback |
| 7. Armrest Seat | 8. Seat Remove Lever | 9. Seatback Angle Lever |
| 10. Side Fenders | 11. Floorboard | 12. Rear Indicator Lamp |
| 13. Rear Lamp | 14. Freewheel Lever | 15. Rear Reflector |



4. OPERATION

4.1 CONTROL PARTS DESCRIPTION

1. Turn Signal Switch
2. Head Light Button
3. Horn Button
4. Forward / Reverse Selector
5. Indoor / Outdoor Switch
6. Hazard Button
7. Power Switch

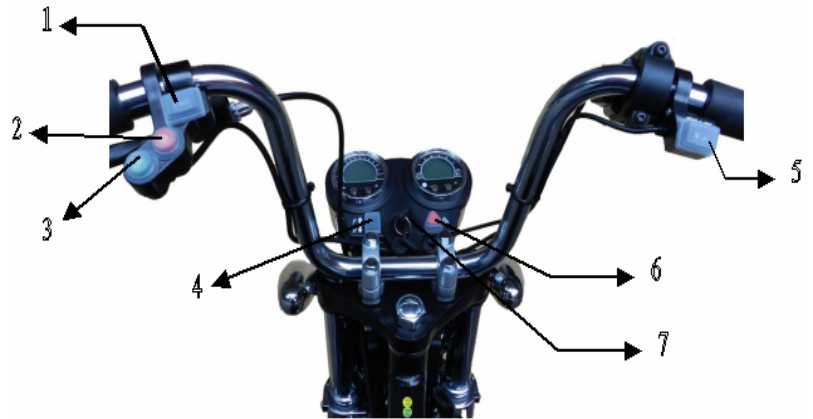

4.2 INSTRUMENT METER

■ THE SPEED INSTRUMENT METER DESCRIPTION

1. Bar Speed Scale
2. Bar Speed
3. Speed & Max. Speed Display
4. Other Functions Display
5. LED Indicator Symbols
6. MODE Button
7. RESET Button

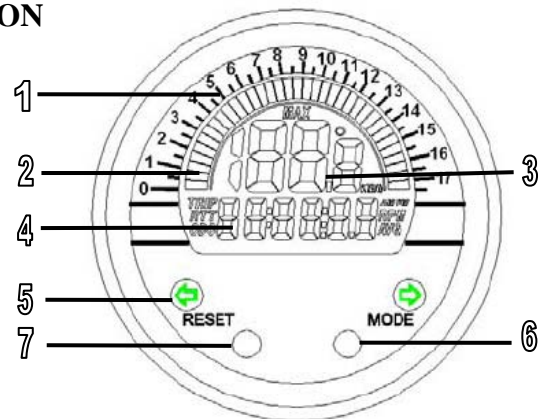

■ THE SPEED INSTRUMENT METER OPERATION

MODE BUTTON

1. Press the MODE button to move in loop sequence from one function screen to another.
2. The LCD screen will convert to the screen of speed meter and trip meter automatically during the riding, if the button operation suspended for 10 seconds.

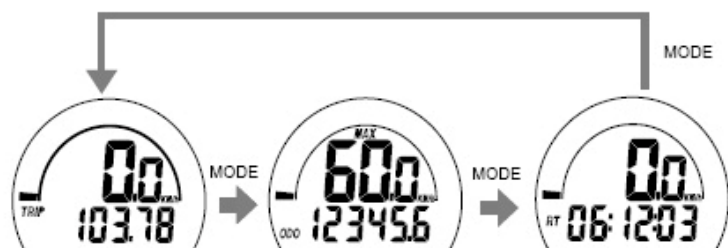

4. OPERATION

RESET BUTTON

1. Hold down the RESET button for 2 seconds at the function's screen desire to be reset. The computer will reset the TRIP, RT or MAX data from stored values to ZERO.
2. It cannot reset ODO data.



FUNCTIONS

1. BAR SPD: Bar Graphic Speed Meter

It displays bar graphic speed up to 80.0 KM/H or 50 Mile/H.

2. SPD: Speed Meter

It displays digital speed meter up to 80.0 KM/H or 50 Mile/H.

3. MAX: Maximum Speed Meter

Displays the highest speed achieved form the last Rest operation.

4. TRIP: Trip Meter

The trip function accumulates total distance data from the last reset for as long as the SCOOTER is being ridden.

5. ODO: Odometer

The ODO accumulates total distance data as long as the SCOOTER is being ridden.

The ODO data is always stored to memory when the power is turn off.

6. RT: Riding Time

The RT totals the riding time form the last RESET operation.

FUNCTIONS	Symbol	SPECIFICATIONS	INCREMENTS	ACCURACY
Bar Speed Meter		0-80KM/h (50.0M/h)	3.3 KM/h	
Speed Meter		2.3-80.0KM/h (50.0M/h)	0.1 KM/H or M/H	+/-1% or +/- 0.1(KPH/MPH)
Maximum Speed Meter	MAX	MAX 2.3-125.0KM/h (78.1M/h)	0.1 KM/H or M/H	+/-1% or +/- 0.1(KPH/MPH)
Trip Meter TRIP	TRIP	0.00-9999.99 Km (6249.99 Miles)	0.01 Km or Miles	+ 0.1%
Odometer ODO	ODO	0.0 - 99999.9 Km (0.0- 62499.9 Miles)	0.01 Km or Miles	+ 0.1%
Riding Time RT	RT	0.00'00"- 99:59'59"	1 Second	+ 50PPM

4. OPERATION

THE VOLTAGE METER PANEL DESCRIPTION

1. Bar Voltage Scale
2. Bar Voltage
3. Voltage & Max. Voltage Display
4. Time & Other function Display
5. Fault Indicator
6. Head Beam Indicator
7. MODE Button
8. RESET Button

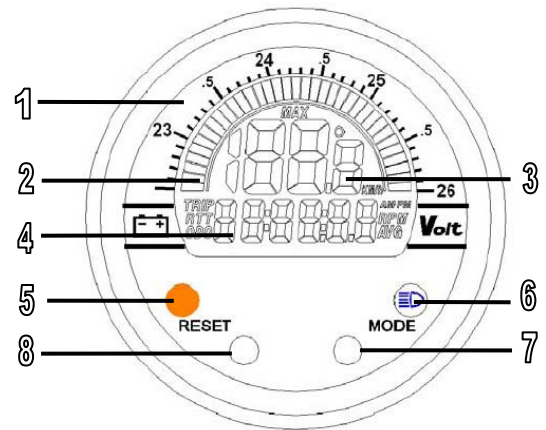

THE VOLTAGE METER PANEL OPERATION

TIME-SETTING

Push and hold both MODE & RESET buttons for 2 seconds to go into the time-setting screen.

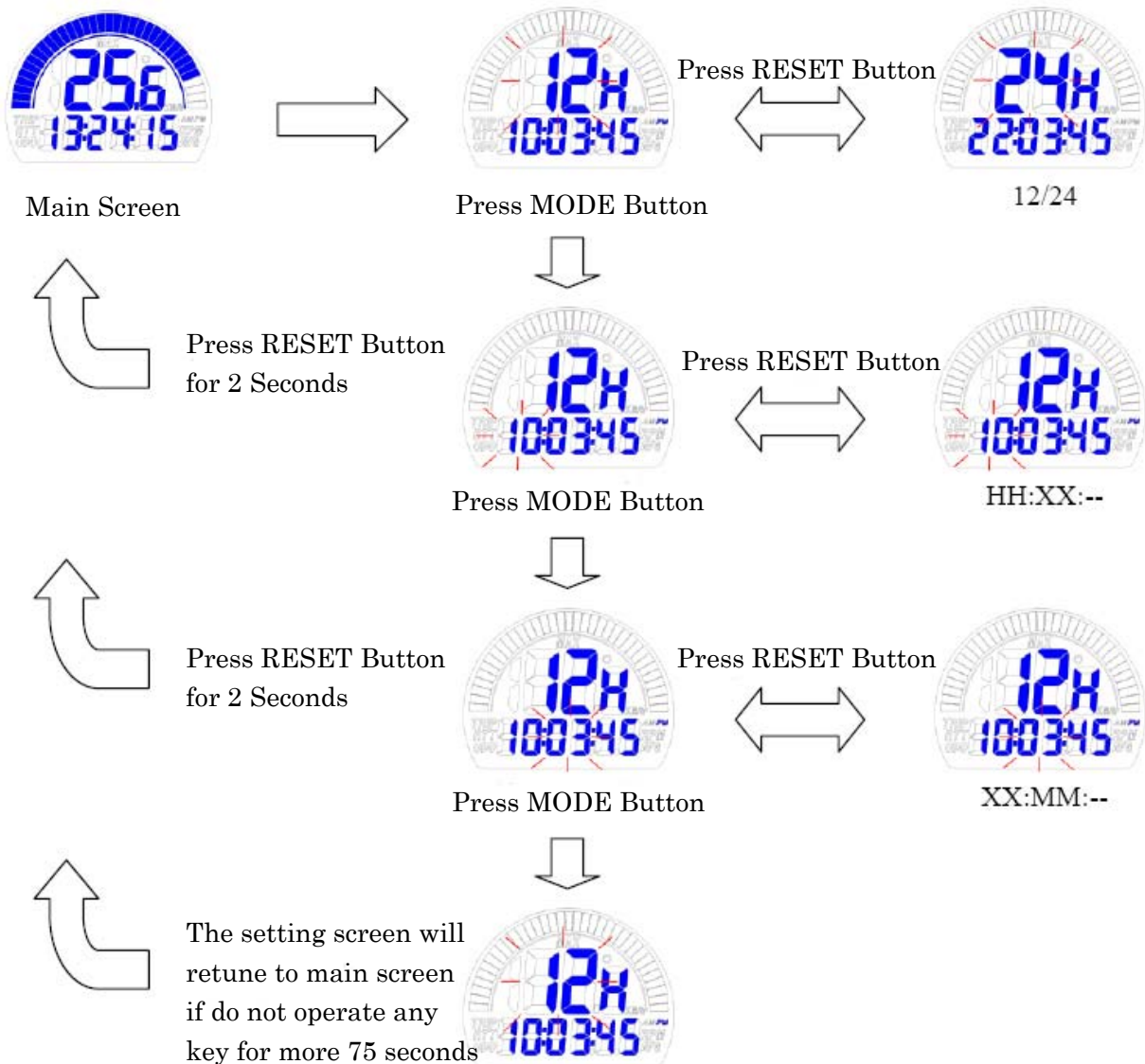

4. OPERATION

FUNCTIONS

1. Bar Graphic Voltage Meter

It displays bar voltage meter up to 35 bars (22.5~26V).

2. Digital Voltage Meter

It displays digital voltage meter up to 20~30V.

3. Time Clock

Displays Time.

4.3 HOW TO OPERATE YOUR SCOOTER

■ Key Switch

- ◆ The scooter has a main key switch.
- ◆ The main key switch has two position

(ON) : Power is supplied to the scooter. The electromagnetic brake releases automatically when the operating lever is squeezed.

(OFF) : The scooter cannot be driven and the Electromagnetic brake is locked.

■ Operating Lever and Manual Hand Brake

- ◆ To start driving, squeeze the operating lever, gently until you reach the desired speed.
- ◆ The speed is directly proportional to the deflection of this lever.
- ◆ To stop – release the operating lever. The scooter will stop gradually.
- ◆ Additionally, emergency braking is possible using the manual hard brake. Squeeze hand brake and use the button to lock it (use it for parking).
- ◆ Squeeze hand brake again to release the button.

■ Parking

- ◆ After stopping, tune the main key to OFF and remove the key. The lights will turn OFF. The electromagnetic brake is engaged (locked).
- ◆ The hand brake lever can be locked by pushing button while squeezing hand brake lever. To release the hand brake – squeeze lever gently.



4. OPERATION

■ Forward / Reverse Selector

- ◆ Select the desired direction (as marked).
- ◆ In reverse mode, a warning buzzer sounds automatically.
- ◆ Release the speed control lever freely while either going forward or reverse, and the electromagnetic brake in the motor will be activated and the vehicle will stop.

■ Signaling

- ◆ Before turning, shift the “Turn Signal Switch”, on the handlebar to the desired direction – left for left, right for right.
- ◆ The light will flash and buzzer will make a beeping sound when turning the switch to the left or right.

■ Horn Button

Press the horn button to sound the horn. Release the button to stop the horn.

■ Light Button

Push the light button to switch the front and rear lights on. Push the button again to turn the lights off.

■ Hazard warning

The hazard button operates all flashing lights on the scooter. Pushing the button once turns the lights ON. A second push turns them OFF.

Suggestion

1. You should recharge the batteries after each time the vehicle is used to ensure maximum range. The batteries should be charged up at least once a week even if the scooter is not used.
2. After charging or replacing a new battery, drive the vehicle for 2-3 minutes to make sure the battery capacity is sufficient.
3. In wintertime, the battery may respond more slowly and the battery range may be reduced.
4. When driving on a gradient, the battery indicator light might move up and down. This is a normal phenomenon so please do not worry.
5. The battery range will be reduced when driving frequently on a slope or rough terrain, as this leads to greater consumption of power.
6. The electromagnetic brake is automatically locked whenever the operating lever is released and after the scooter stops completely

4. OPERATION

■ Braking

Electro-magnetic brake: Release the speed control lever completely, and the electromagnetic brake will be activated automatically, and the scooter will stop.

⚠ Warning

When on a gradient NEVER switch the vehicle to the freewheel mode. The electromagnetic brakes will not be applied. This may result in injury.

■ Seat

- ◆ The seat can be turned to 45 degrees or 90 degrees.
- ◆ Push the seat adjustment lever forward and swivel seat.
- ◆ Release the lever, and then continue swiveling the seat until it locks in position.

☞ Attention

- ◆ Return the seat to the forward position before driving.

■ How to adjust the armrest width

Loosen the knobs at the back of the seat frame firstly, then adjust the armrest width by sliding the armrest. Once satisfied with the width, tighten the knob.

■ How to re-position the seat

The distance between seat and tiller can be adjusted by reposition the seat forward or backward. Loosen the four bolts under the seat which is on the seat platform firstly, and then tighten the bolts securely after move the seat to satisfied position.

How to set to freewheel mode

- ◆ Engaged mode : Lift the lever down completely, the scooter can be driven by motor power.
- ◆ Freewheel Mode : Push the lever up completely, the scooter can be moved manually.

LEVER



4. OPERATION

⚠ Warning

Never operate the freewheel lever while seated on the scooter or on an incline!

OPERATION OF THE FREEWHEEL LEVER

*Always pull UP FIRMLY for freewheel mode

* Always pull DOWN FIRMLY for drive mode

⚠ Warning

1. Please hold the tiller before loosening the tiller adjustment knob. Otherwise a fall from the scooter could occur causing bodily injury and/or damage to scooter.
2. Never attempt to adjust the tiller while the scooter is motion.

■ Main Circuit Breaker (Reset Button)

When the voltage in your scooter's batteries becomes low or the scooter is heavily strained because of excessive loads or steep inclines, the main circuit breaker may trip to protect the motor and electronics from damage. The location of the circuit breaker is shown by the arrow on the photograph (below).

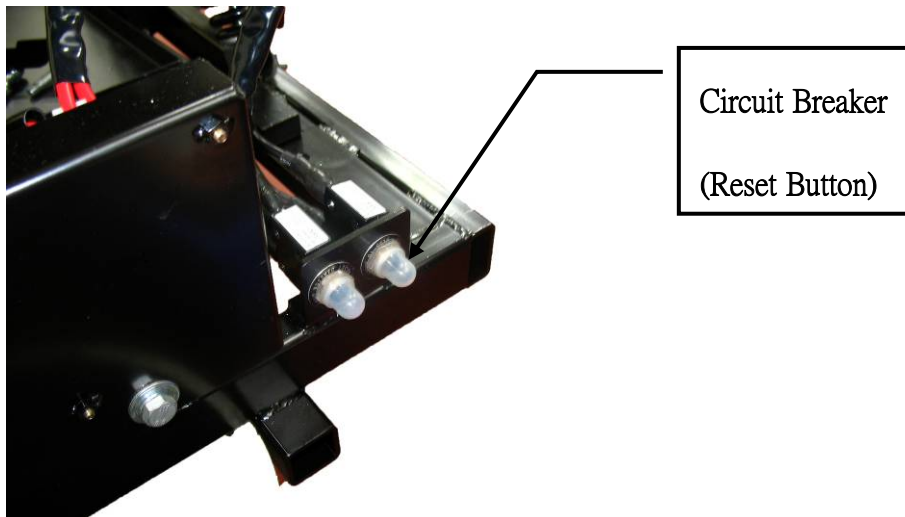

5. BATTERY CHARGING AND CARE

5.1 CHARGING THE BATTERY

Follow the procedure below step by step:

1. Turn the power switch to (OFF)
2. Connect the charger's power cord into the power outlet.
3. Open the charging socket cap on the scooter's tiller. Then connect the charger's round plug to the charging socket.
4. Turn on the switch on the charger.
5. Both the charger's red and orange LEDs will be lit when beginning charging. The charging duration is about 6 hours. To ensure optimum performance a 10-hour charge is recommended. But we do not recommend a charging more than 24 consecutive hours.
6. Both the charger's LEDs will be lit during the charging process. The orange LED will turn green when charging is complete.
7. Turn off the charger; disconnect the power cord and the round plug from charger socket on the scooter.



Suggestion

1. Do not disconnect the charger cord if charging is not completed. The battery life will be seriously shortened or decayed if the battery is repeatedly used without being fully charged. Therefore be sure to charge the battery fully every time.
2. Always complete the charging until the orange LED light turns green. NEVER stop charging before it is complete.
3. When fully charged, the battery charger will still trickle charge the battery to ensure optimum range.
4. If you do not use your scooter for a long time, it should be charged at least every week to keep the battery in a fully usable condition.
5. Charging time will be affected by the ambient temperature. Charging time will be longer in the winter.
6. After charging, do not leave the charger socket plugged in to the scooter, as this will cause a power drain on the scooter and temporarily reduce its range.
7. The batteries carry a six-month manufacturer's warranty. This warranty only covers issues relating to manufacturing faults, and not faults relating to failure to recharge the batteries as instructed above.

5. BATTERY CHARGING AND CARE

Attention: Please follow the rules below to avoid accidents while charging.

1. Please use our charger only, and recharge the battery to its full capacity every time. You may damage the battery and scooter if you use a charger which is not to the correct specification.
2. Never disassemble or modify the charger.
3. Please charge in a well-ventilated space where it is not directly exposed to the sunlight. Do not charge in surroundings where it is humid or under rainfall and morning dews.
4. Do not cover with a waterproof cloth or other objects while charging.
5. Do not charge in temperatures less than -10°C or higher than $+50^{\circ}\text{C}$ as the charger may not work well and the batteries may become damaged.

Warning

1. Keep away from flammable objects while charging as it may lead to fire or explosion of battery.
2. Do not smoke while charging as the battery may release hydrogen gas. Always charge your battery in a well-ventilated space.
3. Never connect or disconnect the plug or cord with wet hands while charging. Do not connect or disconnect the plug or cord when they are wet, it may lead to electric shock.

NOTE: The immovable function will be activated while your scooter is in charging status, which will make your scooter not run.

5.2 CHARGER

Both the chargers red and orange LEDs will be switched ON during charging. The orange LED will turn green when charging completed.

Warning

- ◆ The fan inside the charger will be activated accordingly when you turn on the charger. If the fan does not work when connected to the charger or the green light is not showing, DO NOT use this charger. It may lead to overheating of the charger and cause a fire as a result.
- ◆ There is a red LED present on the charger to illustrate operation. If this LED does not illuminate the charger is defective, please contact your dealer.

5. BATTERY CHARGING AND CARE

5.3 BATTERY

- ◆ Do not expose the battery to temperatures below 10° C or above 50° C when charging or storing the vehicle. Under the above temperature range can cause the battery either to freeze or over heat. This will damage the batteries and shorten their life.
- ◆ These batteries are maintenance free and there is no need to refill with water.
- ◆ You are required to recharge the batteries on a regular basis. Even if the scooter is stood idle, you should charge the batteries at least once a week.

⚠ Warning

Do not open the battery sealed cap at any time.

■ Cleaning the battery

If the batteries are contaminated by water, battery acid, dust or other substances, they will discharge quickly. The batteries supplied with the scooter are sealed and as such are maintenance free with no risk of battery leakage. Please follow the steps below to clean the battery.

1. Turn the scooter power switch to “OFF”.
2. Remove the seat and dust cover.
3. Remove the shroud and unplug the terminal of the taillight and signal lights.
4. Use a clean cloth to wipe off the soiled area.
5. Take out the battery.
6. Clean the battery with a clean cloth. If the terminal is covered by white powder, please wipe it clean using warm water.

■ Changing the battery

Follow the procedure below step by step to replace the batteries:

1. Swing the seat lean on the tiller.
2. Remove the seat.
3. Lifting the seat up off its pivot release shroud 4 securcrews.
4. Discount the cables from the four battery terminals.
5. Undo the hook-and-loop strap and remove the batteries.
6. Place new batteries on scooter.

⚠ Warning

1. Before lifting up the rear shroud, please make sure to adjust the handlebar to the front most position .After lifting the rear shroud; please ensure that the prop lever is in lock position before proceeding on any operation.
2. When retrieving the rear shroud to the original position, please make sure to hold the lift bar with one hand and lift down the shroud slowly. It is dangerous and prohibited to put head or hands under the shroud in any circumstance.

6. INSPECTION AND MAINTENANCE

Suggestions

If necessary, ask for help from your dealer for advice about maintaining and replacing the battery.

Suggestions

1. Make sure the terminals are installed properly and put the cover back on.
2. Do not use the battery to charge telecom equipment or other items.
3. Battery efficiency will vary with outside conditions; the driving distances will be shorter in the winter. If the vehicle is not used for a long time, please charge the battery at least every week.
4. Replace both batteries together.

6.1 INSPECTION

Check following items before driving. If our find anything abnormal, contact your dealer for further inspection or advice before using the battery.

Item	Inspection Content
Handlebar	<ul style="list-style-type: none">◆ Is there any looseness?◆ Can it turn left and right smoothly?
Speed Lever	<ul style="list-style-type: none">◆ Does the scooter move when the lever pressed down?◆ Does the scooter stop when the lever is released completely?
Motor	<ul style="list-style-type: none">◆ Are there an abnormal noise coming from the motor?◆ Do the electromagnetic brakes work properly?
Freewheel Mode	<ul style="list-style-type: none">◆ Does the freewheel mode lever work properly?
Battery Indicator	<ul style="list-style-type: none">◆ Is the light on when the power is switched on?◆ Is the remaining power enough for your trip?
Horn	<ul style="list-style-type: none">◆ Does the horn work?
Seat	<ul style="list-style-type: none">◆ Can the seat swivel smoothly?
Reflector	<ul style="list-style-type: none">◆ Is the reflector present and correct?
Tyres	<ul style="list-style-type: none">◆ Are there any cracks or other damage to the tyres?◆ Check the tyre tread depth.
Other	<ul style="list-style-type: none">◆ Are there any abnormal noises?◆ Is there oil leakage from transmission box?

Attention

Go to your dealer for inspection and maintenance if you find anything wrong.

6. INSPECTION AND MAINTENANCE

6.2 REGULAR CHECKING RECORD

To make sure your scooter is correctly serviced, take it to your dealer for regular maintenance checks. This should be at intervals of six months after the first inspection after one month. Your dealer may charge a fee for this service.

YEAR	1	2	3	4	YEAR	1	2	3	4
Service Dates					Service Dates				
Controller					Upholstery				
On/off switch					Seat				
Control Lever					Back				
Braking					Armrests				
Recharge point					Electrics				
Batteries					Connections condition				
Levels					Lights				
Connections					Test run				
Discharge test					Forwards				
Wheels and Tyres					Reverse				
Wear					Emergency stop				
Pressure					Left turn				
Bearings					Right turn				
Wheel nuts					Slope test				
Motors					Over obstacles				
Wiring					List Items repaired				
Noise									
Connections									
Brake									
Brushes									
Chassis									
Condition									
Steering									

6.3 BATTERY, FUSE AND TYRE

■ Battery

Refer to the section entitled “6 BATTERY” in “6. BATTERY CHARGING AND CARE”.

■ Fuse

If the battery charger is turned on and no LED is lit, check the fuse.

Suggestion

Ask for help from your scooter dealer to inspect or replace the fuse, since the tiller shroud has to be removed first before you can replace the fuse.

■ Tyres

The condition of the types depends on how you drive and use your scooter.

- ◆ Inspecting Type Tread
- ◆ Please check the tread depth regularly. Replace the tyres when the tread depth is less than 0.5 mm.

6. INSPECTION AND MAINTENANCE

Attention

1. When tread depth is below 0.5mm it can easily lead to vehicle slippage, making braking distances longer. Therefore replace the tyres as early as possible when they do not have insufficient tread depth.
2. The tyre pressure shall be kept at about 26 PSI (approx. 1.8KG/cm) for the best ride and handling.

Attention

When conducting maintenance of your vehicle, please turn the power switch to OFF and remove the charger cords.

Suggestions

- ◆ Do not splash water directly to wash your scooter as this could lead to malfunction of the system electrics.
- ◆ Do not use petrol, solvents or vaporizing solution as these may deform or damage the shrouds.
- ◆ Do not use wax.

6.4 STORAGE

Make sure the vehicle is stored under the following circumstances:

- Make sure the seat is set in the “Forward” position
- Make sure the Power switch is turned to OFF

Suggestion

Please store the scooter in a location where it is away from the direct sunlight, rain, or dew. When storing for a long time, please charge the battery to full power and then disconnect the battery terminal. For details inquire to your scooter dealer.

6.5 MOVING ABOUT

- ◆ Turn the power switch “OFF” before moving.
- ◆ Lift the scooter by the chassis, and not by the bumpers. Lifting the scooters by the bumper could cause damage or injury.
- ◆ For your safety, always ask for help if required. You will need 2 or 3 persons when moving or lifting the vehicle.

7. TROUBLE SHOOTING AND SPECIFICATION

■ TROUBLE SHOOTING

You can inspect the following before taking you scooter to the dealer.

<i>Symptom</i>	<i>Remedy</i>
The scooter will not switch on	<ul style="list-style-type: none">• Try recharging the battery• Check the fuse and circuit breaker in the scooter
The scooter switches on, but the scooter will not move.	<ul style="list-style-type: none">• Ensure there is enough power in the batteries. If not, recharge the batteries.• Ensure the freewheel lever is engaged in the 'DRIVE' position.
The scooter appears slow	<ul style="list-style-type: none">• Check the battery power level and recharge• Check the speed dial is not set to slow.
The seat turns when in operation	<ul style="list-style-type: none">• Slowly rotate the seat until it drops in to place and is secure
The handlebar appears loose	<ul style="list-style-type: none">• Tighten the height adjustment handle to secure the handlebar
Involuntarily horn sounds	<ul style="list-style-type: none">• Ensure that the wigwag paddle is released.• Switch the scooter off and on.• Recharge the batteries.• If problem persists contact your Pride' dealer.

If you cannot solve the problem by yourself, contact your dealer for help.

7. TROUBLE SHOOTING AND SPECIFICATION

SPECIFICATION	
Model Reference	SR-XL3
Dimension (L x W x H mm) (L x W x H inch)	1650mm×780mm×1120mm 65" ×30.7" ×44"
Weight with battery	188kg / 417.7lbs
Battery weight	34.23Kg each
Battery	12V70Ah x 2
Controller	DYNAMIC RHINO 160A
Motor	4P 1300W 4300rpm
Charger	DC 24V 8A Off-Board
Front Tyre	2.75-14 x 1
Rear Tyre	2.75-14 x 2
Driving System	Direct drive the rear wheels
Brake System	Electromagnetic brakes & Hand break
Control Method	By speed control lever
Max. Speed	9.4mph /15Kph
Turning radius	1573mm / 62 inch
Climbing angle	10°
Cruising range	31.25 mile / 50 km
Max. user weight	400 lbs/182 kg

Remark: The manufacturer reserves the right to modify the specification if necessary. The final specification is subject to the individual scooter you purchase from your dealer.

Note:

Maximum driving distance is based on an ambient temperature of 20°C, a 100kg driver and a brand new fully charged battery by a constant driving speed at 6 km/h with 70% battery power discharged.

Recommended incline:

The scooter has undergone extensive incline testing. Angles and weights shown here for this scooter indicate the safe working angles for the user and equipment. Any scooter used outside these parameters may be unsafe.

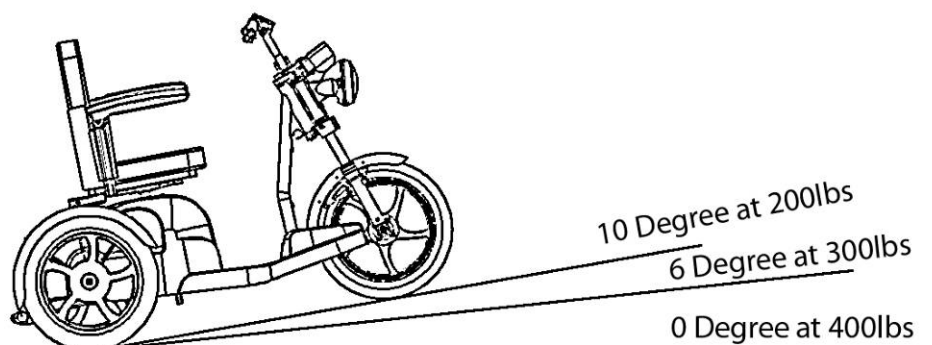

8. WARRANTY

ONE-YEAR LIMITED WARRANTY

Your Pride Scooter is fully guaranteed for twelve (12) months from the date of purchase against faults arising due to defects in manufacture or materials. This warranty does not detract from, but is in addition to your legal rights.

“Our goods come with guarantees that cannot be excluded under the Australian Consumer Law. You are entitled to a replacement or refund for a major failure and for compensation for any foreseeable loss or damage. You are also entitled to have the goods repaired if the goods fail to be of acceptable quality and the failure does not amount to a major failure.”

Warranty Conditions:

1. Any work or replacement part installation must be carried out by an authorized Pride dealer / service agent.
2. To apply the warranty should your scooter require attention please contact the designated service agent listed below.
3. Any repaired or replaced parts will be covered by this warranty for the balance of the warranty period on the scooter.
4. Consumable items supplied will not generally be covered during the normal warranty period unless such items require repair or replacement clearly as a direct result of a manufacturing or material defect.

Such items include (among others): upholstery, tyres and batteries.

*Batteries are covered by a twelve (12) month warranty.

5. Under normal circumstances, no responsibility will be accepted where the scooter has failed as a direct result of:
 - a) The scooter part not having been maintained in accordance with the manufacturer's recommendations.
 - b) Failure to use the manufacturer's specified parts
 - c) The scooter or part having been damaged due to neglect, accident or improper use
 - d) The scooter or part having been altered from the manufacturer's specifications or repairs having been attempted before the service agent is notified

Please note your local service agent's contact details in the box below. In the event of your scooter requiring attention, contact them and give all relevant details so they can act quickly.

The manufacturer reserves the right to alter without notices any weights, measurements or other technical data shown in this manual. All figures, measurements and capacities shown in this manual are approximate and do not constitute specifications.

Pride Authorised Service Agent

Name
Address
Tel
Postcode

8. WARRANTY

8.1 VIN (VEHICLE INDIFICATION NUMBER)

To ensure the correct after sales service and warranty service support, please write down the vehicle identification number that is stuck on the back right-hand side of the frame.



.....

Model	SR-XL3		
Chassis NO.			
Motor serial #		Key #	

Warranty Application Form

Name			
Gender	<input type="checkbox"/> Male	<input type="checkbox"/> Female	
Tel no.			
Address			
Model	SR-XL3		
Vehicle Data	Scooter Chassis No.:		
	Motor Serial No:		Key #
Date of Purchase	Year	Month	Day
Purchaser Signature			



Pride Mobility Products Australia Pty. Ltd.

20-24 Apollo Drive, Hallam,
Victoria, AUSTRALIA 3803

Tel: 03 8770 9600

Fax: 03 9703 2720

Web: www.pridemobility.com.au

Email: prideaustralia@pride-mobility.com.au