

---

# *SMARTEYE P-Linc*

## **User Manual**

VERSION L1.5

**Revision 4**



related documents:

***SMARTEYE*** Electronics Assembly User Manual

***SMARTEYE*** Twin User Manual

The material in this manual is for informational purposes and is subject to change without notice. *SMARTEYE* Corporation assumes no responsibility for any errors which may appear in this manual.

© *SMARTEYE* Corporation

***SMARTEYE*** is a registered trademark of *SMARTEYE* Corporation.

Printed in U.S.A.

***SMARTEYE*** contact information:

***SMARTEYE*** Corporation  
2637 Bond Street  
Rochester Hills, MI 48309  
Phone: (248) 853-4495 Fax: (248)853-8539  
[www.smarteyecorporation.com](http://www.smarteyecorporation.com)  
Email: [support@smarteyecorporation.com](mailto:support@smarteyecorporation.com)

## Table of Contents

<b>1.0 INTRODUCTION .....</b>	<b>1</b>
<b>2.0 P-LINC DESCRIPTION .....</b>	<b>1</b>
<b>3.0 P-LINC INSTALLATION .....</b>	<b>1</b>
<b>4.0 AC POWER/WIRING .....</b>	<b>1</b>
<b>5.0 POWER SUPPLY .....</b>	<b>2</b>
<b>6.0 CONTROL SERIAL PORT RS485 WIRING .....</b>	<b>2</b>
<b>7.0 AUXILIARY SERIAL PORT RS423 WIRING.....</b>	<b>2</b>
<b>8.0 PARALLEL WIRING.....</b>	<b>2</b>
8.1 DATA BITS (D0 - D15) .....	3
8.2 READER BITS (RDR0 - RDR5).....	3
8.3 READY BITS (RDY0, RDY1) .....	3
8.4 PARITY BIT (PARITY) .....	3
8.5 LABEL/ERROR BIT (L/E).....	3
8.6 DATA ACKNOWLEDGE (ACK).....	4
<b>9.0 P-LINC CPU CIRCUIT CARD.....</b>	<b>4</b>
9.1 CONFIGURATION LEGEND.....	4
9.2 P-LINC SOFTWARE CONFIGURATION PARAMETERS (SW2).....	5
9.3 MEMORY CONFIGURATION (JB2) .....	6
9.4 CONTROL AND AUXILIARY SERIAL PORTS TERMINATION (SW1 AND JB1) .....	6
9.4.1 CONTROL PORT MULTIDROP LINE TERMINATION NOTES (SW1).....	7
9.4.2 SHIELD TERMINATIONS AND AUXILIARY PORT SIMPLE TERMINATION (JB1) .....	7
<b>10.0 SEA-8 AND TWIN ADDRESSING.....</b>	<b>8</b>
10.1 READER NUMBER DESCRIPTION .....	8
<b>11.0 POWER-UP .....</b>	<b>8</b>
<b>12.0 PARALLEL COMMUNICATION PROTOCOL .....</b>	<b>8</b>
12.1 TRANSACTION STEPS .....	8
12.2 DESIGN CONSIDERATIONS .....	9
<b>13.0 SPEED OF RESPONSE .....</b>	<b>10</b>
<b>14.0 AUXILIARY PORT OPERATION .....</b>	<b>10</b>
14.1 PARALLEL PORT MONITOR MODE (SW2.5 ON) .....	10
14.2 CONTROL PORT RECEIVE MONITOR (SW2.6 ON) .....	11
14.3 CONTROL PORT TRANSMIT MONITOR (SW2.7 ON).....	12
<b>15.0 ERROR MESSAGES .....</b>	<b>13</b>
<b>16.0 APPENDIX ‘A’ (DRAWINGS).....</b>	<b>A-1</b>

## 1.0 Introduction

The Smarteye P-Linc connects up to 8 Smarteye Electronic Assemblies: (SEA-8s and/or Twins) on a serial RS485 multidrop communication line. Smarteye reader data is received on the serial communication line and converted to parallel digital 24VDC outputs. The digital outputs of the P-Linc are directly wired to digital input modules of a PLC. Two bits of the output data, the data ready bits, signal the preparation of new data on the output lines. A control device recognizes new data, receives it, and then provides two output bits which match the data ready bits. These outputs are received by the P-Linc on its two 24VDC input lines and interpreted as data acknowledge bits.

The P-Linc parallel port has 28 bits: 26 outputs and 2 inputs. The 26 outputs consist of: 16 data bits, 6 reader bits, 2 data ready bits, a parity bit and a label or error bit. The two input bits are used for data acknowledge. The 16 data bits and 6 reader bits can be configured as either binary or BCD.

## 2.0 P-Linc Description

The Smarteye P-Linc contains: P-Linc CPU circuit card, power supply, on/off switch, fuse, mounting base, and interconnecting cables. The unit is completely assembled and ready for use.

## 3.0 P-Linc Installation

The Smarteye P-Linc is designed to function in the environment found in most industrial facilities. The P-Linc will operate properly in the same environment as a programmable controller. It is rated for operation at temperatures from **0 to 50° C**.

Electromagnetic interference on signal lines will not be a problem if the recommended cables are used for equipment interconnections. The recommended cables will provide adequate shielding.

Mounting dimensions for the P-Linc can be found on drawing #SP2004/01-420 in Appendix 'A' of this document.

## 4.0 AC Power/Wiring

The Smarteye P-Linc requires 0.4 amps at 120VAC (48VA). The input voltage may vary from 85-132VAC. An optional power supply allows input voltages of 105-265VAC. Frequency range is 50-60Hz in all cases. The P-Linc has three terminals for AC power connections, located on the exterior bottom right of the chassis. These terminals provide connections for L1, N, and ground. A glass-type 1 AMP fuse is used to protect the hot side of the line. A two-pole power switch opens both sides of the AC line circuit in the OFF position.

The Smarteye P-Linc has been designed to be as immune to AC power line fluctuations as is practical. However, like most electronic equipment, it can be susceptible to 'brownouts' and severe voltage 'spikes'. The P-Linc should be powered with an AC line which is fed from the secondary of a transformer whose primary is electrically as close to the main power source of the facility as possible. The AC line can supply other, similar electronic equipment such as programmable controllers, but should not power any heavy industrial equipment that causes excessive line fluctuations such as motors, motor starters, welders, etc.

All applicable codes and ordinances should be observed for wiring AC power and ground, particularly the National Electrical Code published by the National Fire Protection Association of Boston, Massachusetts.

## **5.0 Power Supply**

A single 24 VDC power supply is included in the Smarteye P-Linc chassis. This supply provides power for the CPU circuit card. The power supply has a screw for adjusting its output voltage. Using a voltmeter, the output voltage may be adjusted to approximately 24 VDC.

The power supply includes automatic current limiting circuitry with automatic recovery, which limits short circuit output current to a safe value. This provides protection against damage due to accidental shorting. An AC line filter is incorporated into the power supply to reduce noise from line-to-line and line-to-ground.

## **6.0 Control Serial Port RS485 Wiring**

The serial communication line between the P-Linc and SEA-8's and or Twins is a multidrop network which conforms electrically to RS485. The recommended cable is Belden 9730 or equivalent. Total cable length from the P-Linc to the last Twin or SEA-8 on the multidrop line cannot exceed 4000 feet. The proper connections are shown on drawing #SP2004/01-412 in Appendix 'A'.

## **7.0 Auxiliary Serial Port RS423 Wiring**

The auxiliary port connections require a 9-pin male 'D'-type connector. Belden 8723 or equivalent (2 shielded pairs, 22 gauge) is recommended for the RS423 connection. Detailed wiring drawing #SP2004/01-311 can be found in Appendix 'A'.

## **8.0 Parallel Wiring**

The P-Linc circuit card provides 3 plug-in screw terminals for the parallel port connections. The parallel port outputs must connect to a 24VDC input module and the two inputs must connect to a 24VDC output module. Discrete 18 gauge wire such as Belden 8501 or equivalent is recommended for these connections. Parallel wiring details can be found on drawing #SP2004/01-411 in Appendix 'A'.

## Notes:

1. Data presented by a P-Linc on its parallel output lines is binary; i.e., each output represents a bit in a binary field (off = 0, on =1).
2. The least significant bit of the data field is D0 and the most significant is D15. The least significant bit of the reader field is RDR0 and the most significant is RDR5.
3. Connecting all P-Linc parallel outputs to an input module may not necessary. Example: binary mode with 10 bit labels, D0 - D9 must be wired, D10 - D15 will always be 0 and wiring is therefore optional.
4. The P-Linc is configured for true-high operation; i.e., a binary 1=24VDC and a binary 0=GND.

### 8.1 Data Bits (D0 - D15)

The data bits (D0 - D15) define the value of the label or error number. This field may be binary or BCD dependent on the position of SW2.1.

### 8.2 Reader Bits (RDR0 - RDR5)

The reader bits (RDR0 - RDR5) define the value of the reader number. This field may be binary or BCD dependent on the position of SW2.1.

### 8.3 Ready Bits (RDY0, RDY1)

A change of state in the two ready bits signals the control device that the P-Linc has new data on its output lines. If the ready bits are 01 or 10, then the control device should receive the new data and perform appropriate control action. If the ready bits are 00 or 11, then the control device should ignore the data (take no control action). A full description of this protocol appears in section 12.0 - 'Parallel Communication Protocol'.

### 8.4 Parity Bit (PARITY)

The parity bit enables the control device to determine the validity of data received from the P-Linc. Thus, if an input/output point should fail on either the control device or the P-Linc, or if a connection between the two should be lost, then the control device can detect the fault and issue an alarm and/or stop the controlled operation until repairs are made.

The value of the parity bit is always set so that an **odd** sum results when the number of bits turned on in the data field (D0-D15), the reader field (RDR0-RDR5), and the Label/Error bit (L/E), are added with the parity bit itself.

### 8.5 Label/Error Bit (L/E)

The label or error (L/E) bit defines the data bits (D0 - D15) as an error number or a label number. **If this bit is a 1, the data is a label number. If the bit is a 0, the data is an error number.**

## 8.6 Data Acknowledge (ACK)

The two data acknowledge bits are the only parallel **inputs** received by the P-Line. A control device must set the data acknowledge bits to the **same** value as the two data ready bits, signaling recognition of the most recent transition of data ready. See section 12.0 -'Parallel Communication Protocol'.

## 9.0 P-Line CPU Circuit Card

The Smarteye P-Line CPU circuit card includes the following features:

- 26 bit parallel output port (24VDC true high)
- 2 bit parallel input port (24VDC true high)
- Interface to a serial RS485 multidrop network line (control port)
- Interface to a serial RS423 monitor line (auxiliary port)
- LED's for serial XMT and REC (control port) and for the parallel port ACK and RDY
- Switches to set software operating parameters and control port termination
- Jumper blocks to modify shield terminations and memory size

The diagrams on the following pages describe the function of the various jumper blocks and switches. Prior to shipment, the switches and jumpers are factory configured as shown in Appendix A drawing #SP2004/01-200.

### 9.1 Configuration Legend

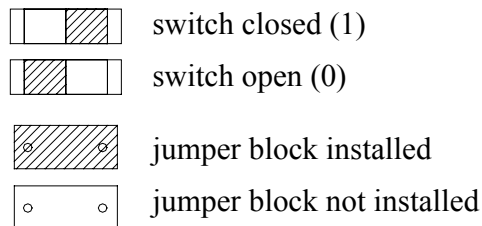

9.2 P-Linc Software Configuration Parameters (SW2)

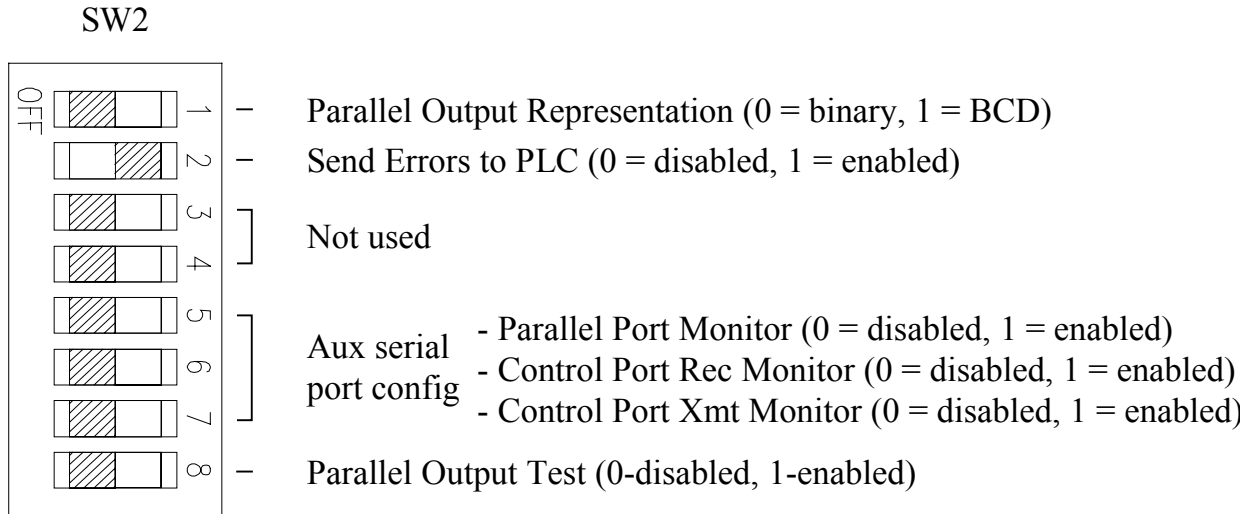

Note: SW2-1 and SW2-2 are read once at power up

- SW2.1      The data bits (D0 - D15) and the reader bits (RDR0 - RDR5) can be configured as binary or BCD with this switch. The switch diagram above is set for binary outputs. In binary mode the label number range is 1 - 65535 and the reader number range is 0 - 63. In BCD mode the label number range is 1 - 9999 and the reader number range is 0 - 39.
- SW2.2      Errors from an SEA reader or P-Linc generated errors are sent to the programmable controller via the parallel port if this switch is on. When an error occurs, the L/E bit will be 0 and the data bits form the error number. If this switch is off, then no errors are sent to the programmable controller. The L/E bit will be 1 except at power-up. The switch diagram above is set to enable errors.
- SW2.5-2.7    The auxiliary serial port (9 pin 'D' connector) can be used to monitor the control port or the parallel port. If SW2.5 is enabled, then the data which is sent out the parallel port is displayed on a user's terminal in real time. Non-idle messages received by the control port are also displayed. If SW2.6 is enabled, then the serial data which is received by the control port is displayed in real time. If SW2.7 is enabled, then the serial data which is transmitted by the control port is displayed in real time. Only one monitor can be enabled at a time. See section 14.0 for details on Auxiliary serial port operation.
- SW2.8      This switch is used for troubleshooting the parallel port. All 26 parallel output bits are turned on if this switch is on. The outputs will remain on until the switch is turned off and a new label or error message is sent out the parallel port.



### 9.3 Memory Configuration (JB2)

The memory configuration is set at the factory and should not be altered; it is shown here for reference only.

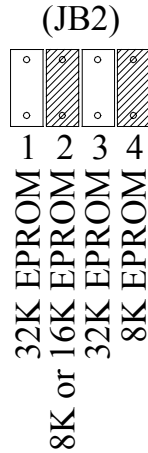

### 9.4 Control and Auxiliary Serial Ports Termination (SW1 and JB1)

SW1 and JB1 are provided to allow proper termination of the serial communication lines. Normally, the switches and jumpers are configured as shown below. A description of each switch and jumper follows the diagrams.

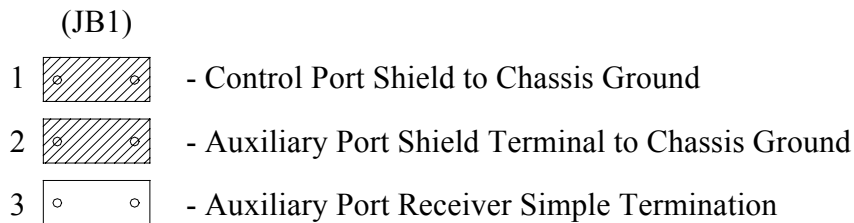
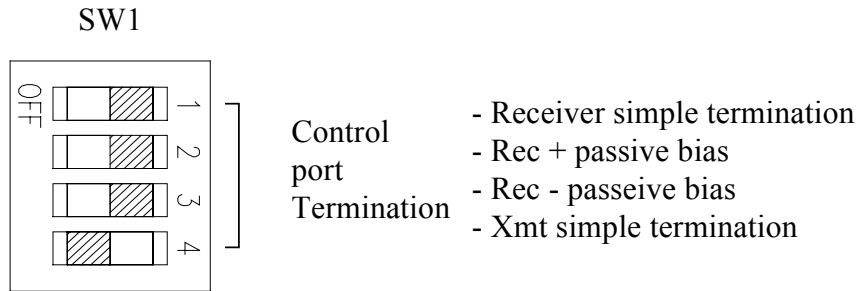

SW1.1 Places a 220 ohm resistor across the input of the control port RS485 receiver for simple termination.

SW1.2 Ties the non-inverting (REC+) terminal of the control port RS485 receiver to 5 volts through a 470 ohm resistor for passive biasing.

- SW1.3 Ties the inverting (REC-) terminal of the control port RS485 receiver to ground through a 470 ohm resistor for passive biasing.
- SW1.4 Places a 220 ohm resistor across the output of the control port RS485 driver for simple termination.
- JB1-1 Connects the control port shield terminal to chassis ground at the P-Linc
- JB1-2 Connects the auxiliary port shield pin to chassis ground at the P-Linc
- JB1-3 Places a 470 ohm resistor across the receiver of the auxiliary port for simple termination.

#### 9.4.1 Control Port Multidrop Line Termination Notes (SW1)

A maximum of 8 SEA units (Twins and/or SEA-8s) may be connected to the P-Linc's RS485 multidrop line (control port). In this multidrop configuration, the transmitters of all SEA units are connected in parallel to the P-Linc's receiver. Similarly, the SEA units' receivers are connected in parallel to the P-Linc's transmitter.

The following restrictions must be observed in this multidrop configuration:

1. To eliminate the possibility of two SEA units attempting to transmit at the same time, the P-Linc repeatedly polls SEA units for data messages. The communication mode of the SEA units must be poll mode and each unit must have a unique address.
2. The transmitter of each SEA unit must tri-state when it is not transmitting.
3. The parallel combination of impedances of the SEA units' receivers must be high enough so that the line is not overloaded.

Because the SEA units' transmitters are tri-stated, there are times when all the transmitters are in a high impedance state; i.e., the state of the line is determined by conditions at the P-Linc's receiver. To insure that the state of the line is predictable in this circumstance, the P-Linc's receiver should include a passive biasing network. A passive biasing network consists of three resistances: one between +5VDC and the non-inverting input, one across the inputs, and the third connected from the inverting input to DC ground. This passive bias network is accomplished by turning on SW1.1, SW1.2, and SW1.3 (see diagram above).

The P-Linc's transmitter does not tri-state, therefore a passive bias network on the SEA units is not necessary. Simple receiver termination of the last SEA unit on the multidrop line is recommended to reduce ringing and overshoot. Note: Since all multidropped SEA units receivers are in parallel, only **one** receiver may be terminated with a simple termination resistor. Otherwise, the line load will exceed tolerance levels.

#### 9.4.2 Shield Terminations and Auxiliary Port Simple Termination (JB1)

The jumper JB1-1 is provided to allow drain wire termination of the control port. The control port serial communication cable's drain wire is typically connected to chassis ground at the P-Linc because the P-Linc side normally has a better ground. Never connect a drain wire at both ends of a communication line.

The jumper JB1-2 is provided to allow drain wire termination of the auxiliary port.

The jumper JB1-3 is provided to allow simple termination of the auxiliary port's receiver. This jumper should be installed if the auxiliary port communication line is greater than 50 feet.

## 10.0 SEA-8 and Twin Addressing

The Smarteye P-Linc connects up to 8 SEA-8s and/or Twins on a single multidrop line. The P-Linc is able to distinguish one SEA-8 or Twin from another by its starting address. **Valid starting addresses for SEA-8s and/or Twins are: 00, 10, 20, 30, 40, 50, 60, and 70 (octal). The P-Linc will ignore any other starting addresses.** SEA-8 and Twin addressing details can be found in their respective user manuals.

**If the P-Linc is configured for BCD mode, the valid starting addresses are limited to: 00, 10, 20, 30, and 40 octal.** The P-Linc will generate an error (E52 - reader number too big) for addresses 50 - 70 octal.

### 10.1 Reader Number Description

The starting address and SEA unit type (SEA-8 or Twin) determine the range of reader numbers for an SEA-8 or Twin. An SEA-8 with a starting address of 60 will have reader numbers: 60 - 67. A Twin with a starting address of 10 will have reader numbers 10 and 11. Reader numbers 12 thru 17 are not available. A Twin occupies the space for 8 reader numbers but only uses the first two.

## 11.0 Power-Up

When power is applied an LED on the power supply will illuminate. The P-Linc reads its setup switches and initializes its internal data. The control port transmit LED will begin to flash and the receive LED will flash if the control port is wired properly to one or more SEA units. One of the parallel port RDY bit LEDs will illuminate when valid data is on the parallel port.

## 12.0 Parallel Communication Protocol

The communication protocol between a P-Linc and a control device (e.g., programmable controller) is relatively simple. Nevertheless, it is important that a logic designer for the control device be thoroughly familiar with the protocol.

### 12.1 Transaction Steps

All data messages originate at an SEA unit. A set of messages in both directions is required for an SEA unit to deliver the data to the P-Linc and receive assurance of its delivery. The complete set of messages between an SEA Unit and the P-Linc, as well as the P-Linc and the PLC, is a data message transaction. The key steps of a data message transaction include the following:

1. The P-Linc selects the next SEA unit to poll from its on line list and sends a box poll command to that SEA unit.
2. The SEA unit responds with a data message.

3. The P-Linc sends a brief message back to the SEA unit, acknowledging receipt of the data message.
4. The P-Linc extracts data from the serial data message and establishes it on the parallel port.
5. Once the data has settled on the data lines the P-Linc will establish a new state for the data ready bits and write this new state to RDY0 and RDY1 of the parallel output lines.
6. Meanwhile, the PLC which has been monitoring the data ready outputs of the P-Linc, recognizes the change in the data ready bits.  
If the data ready bits are 01 or 10, then the PLC receives the remainder of the data from the parallel outputs and takes appropriate action.  
Whatever the new pattern of data ready bits, the control device sets data acknowledge bits to match.
7. When the P-Linc receives ACK0 and ACK1 equal to RDY0 and RDY1, then the transaction is complete.

## 12.2 Design Considerations

A P-Linc, regardless of the speed of its output buffers, cannot guarantee that all new output data will transition at the same instant. In other words, there is a short transient interval during which output data 'settles'. A PLC samples data presented by a P-Linc at scattered instances in time, including an instant during which the output lines of a P-Linc are settling.

The steps of a data message transaction are designed to prevent a control device from receiving data that is sampled during a settling period. In order to prevent this, the transaction steps allow output data to settle before the data ready bits change. Thus, a control device should only receive data when it recognizes a change in the data ready bits.

There are four possible patterns of the two data ready bits: 00, 01, 10, and 11. Only 01 and 10 are associated with usable data. Thus, a control device should receive data only when the data ready bits change and have a value of 01 or 10. This prevents a receipt of data during a settling period of the data ready bits, when 00 and 11 are possible values.

There is only one instance in which data ready is deliberately set (non-transient) to a value other than 01 or 10. At powerup, when there is no data yet established for the parallel port the initial value of data ready is 00. The associated parallel data may be ignored by the control device, as with any other instance of 00 for data ready.

A control device should reflect all values of data ready in its data acknowledge outputs, even values of 00 and 11. A P-Linc will not begin a new data message transaction until data ready of the previous transaction is matched by data acknowledge.

## 13.0 Speed of Response

The time delay from the completion of the label read process (the last bit of the label passes the Smarteye Reader) to the receipt of the reader number and label number in PLC memory is defined as speed of response (SOR). **The SOR can be as little as 40 mS but is directly dependent on the PLC scan time. The P-Linc will not send new data out the parallel port until the PLC matches the RDY bits from the previous message.** The SOR is also affected (to a lesser extent) by the number of reads which occur within a very short time window. Smarteye in-house testing concluded that the SOR for 64 simultaneous reads with a 10 mS PLC scan time was 2.5 seconds.

## 14.0 Auxiliary Port Operation

The auxiliary serial port is designed to aid the user during startup or troubleshooting. Messages are transmitted with the following communication parameters: **9600 baud, one start bit, eight data bits, no parity, and one stop bit.** Any messages received by the auxiliary port are ignored. The three modes of this serial port are described below. Only one mode can be selected (via SW2.5 or SW2.6 or SW2.7) at a time.

### 14.1 Parallel Port Monitor Mode (SW2.5 on)

Parallel port data is sent from the Auxiliary port in real time when this mode is enabled. Non-idle input messages from the control port are also sent. This allows the user to verify that the P-Linc is properly transmitting the messages it is receiving. The messages are displayed in a man-readable format (reader is displayed in octal format and label/error number is displayed in decimal format) as shown below.

```
98:15:39.44i <02>L00504 T02S5Zdp
98:15:39.53o <02>L00504
98:15:40.29i <41>E10 T02S5Zcf
98:15:40.35o <41>E10
```

The parallel output message format is:

```
hh:mm:ss.sso <id>Lnnnnn      (Label Message)
hh:mm:ss.sso <id>Enn        (Error Message)
```

The serial input message format is:

```
hh:mm:ss.ssi <id>Lnnnnn TnnSnZzz (Label Message)
hh:mm:ss.ssi <id>Enn TnnSnZzz   (Error Message)
```

Where:

hh:mm:ss.ss	=	timestamp - hours, minutes, seconds since P-Linc power-up
i	=	input message from serial line
o	=	output message from parallel lines
<id>	=	reader ID number (octal)
Lnnnnn	=	Label field (decimal)
Enn	=	Error field (decimal)
Tnn	=	time field - age of message
Sn	=	sequence number - 0 to 9
Zzz	=	checksum

For a complete explanation of the time, sequence, and checksum fields, refer to the Smarteye Electronic Assembly or Smarteye Twin User's Manual.

## 14.2 Control Port Receive Monitor (SW2.6 on)

Data which is being received from Twins or SEA-8s is sent from the Auxiliary port in real time when this mode is enabled. Much of this data will be "on-line idle" messages in response to the P-Linc's box poll. An example of this mode's output is shown below. Check the Smarteye Twin and/or Smarteye Electronic Assembly User's Manual for details on the serial communication protocol.

```

<10>Zfi
<20>Zea
<30>Zei
98:15:39.44 <02>L00504 T02S5Zdp
<20>Zea
<30>Zei
98:15:40.29 <41>E10 T02S5Zcf

```

Typical message formats are:

<id>Zzz		(On-line idle Message)
hh:mm:ss.ss	<id>Lnnnnn TnnSnZzz	(Label Message)
hh:mm:ss.ss	<id>Enn TnnSnZzz	(Error Message)

Where:

<id>	=	reader ID number (octal)
------	---	--------------------------

Zzz	=	checksum
hh:mm:ss.ss	=	timestamp - hours, minutes, seconds since P-Linc power-up
		Note: Timestamps appear only on non-idle messages.
Lnnnnn	=	Label field (decimal)
Enn	=	Error field (decimal)
Tnn	=	time field - age of message
Sn	=	sequence number - 0 to 9
Zzz	=	checksum

For a complete explanation of the time, sequence, and checksum fields, refer to the Smarteye Electronic Assembly or Smarteye Twin User's Manual.

### 14.3 Control Port Transmit Monitor (SW2.7 on)

Data which is being transmitted from the P-Linc is sent from the Auxiliary port in real time when this mode is enabled. Much of this data will be "boxpoll" messages from the P-Linc. An example of this mode's output is shown below. Check the Smarteye Twin and/or Smarteye Electronic Assembly User's Manual for details on the serial communication protocol.

```
BZak
(BZck
0BZdc
8BZdk
```

A typical message format is:

```
<id>BZzz
```

Where:

<id>	=	reader ID number (binary)
A	=	ack the previous device transmission
B	=	box poll
Zzz	=	checksum

For a complete explanation of the commands, checksum fields, etc. refer to the Smarteye Electronic Assembly or Smarteye Twin User's Manual.

## 15.0 Error Messages

The error messages defined below are generated by the P-Linc. Check the SEA-8 and/or Twin user manuals for a description of errors which they generate. All error codes regardless of their source will appear on the parallel output port as they occur if SW2.2 is on. **The errors E52 - E56 are set with a reader address of 0 since the reader number is either too big or the received serial message has a data error.**

<u>Error Code</u>	<u>Description</u>
50	BCD label number is too big to send to the PLC. This error occurs when the P-Linc is in BCD mode and a serial label message is received which is greater than 9999.
52	BCD reader number is too big to send to the PLC. This error occurs when the P-Linc is in BCD mode and a serial message is received with a reader number greater than 39. <b>Note: In Parallel Port Monitor Mode, this message will be preceded by an output message of the correct reader number. This message is not transmitted on the parallel outputs, but is shown on the auxiliary port for the user's information. E52 is transmitted on the parallel port.</b>
53	Parity error in character of SEA unit message received.
54	Checksum error in SEA unit message received.
55	SEA unit message received without <cr> terminator.
56	Unrecognizable received message



## **16.0 Appendix 'A' (Drawings)**

Circuit Card Layout - SP2004/01-200

Auxiliary Communication Port Cable Detail - SP2004/01-311

Field Wiring Details - SP2004/01-411

Control Port RS-485 Wiring - SP2004/01-412

Installation Details - SP2004/01-420

REV	DESCRIPTION	DATE	APPR. BY
0	INITIAL RELEASE	10/3/94	MDB

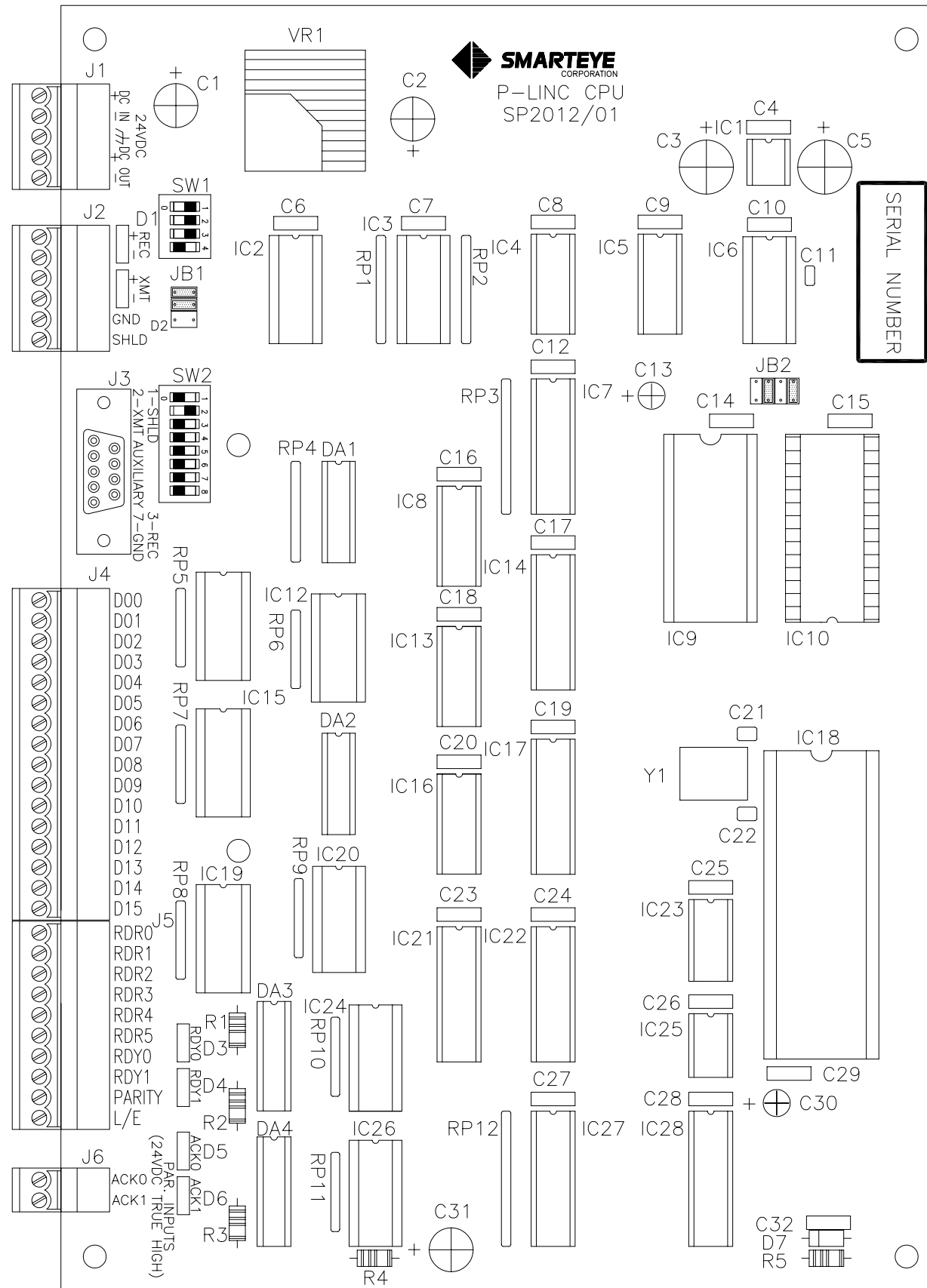

**SWITCH SETTING  
LEGEND**

- (ON) 1
- (OFF) 0

**JUMPER LEGEND**

- INSTALLED
- NOT INSTALLED



2637 BOND STREET ROCHESTER HILLS, MICHIGAN 48309  
PHONE (248) 853-4495 FAX (248) 853-8539

DRAWN BY: JMA	TITLE:
CHECKED BY: MDB	SMARTEYE P-LINC
ENGINEER: KLC	- CIRCUIT BOARD LAYOUT
DATE: 9/15/94	
SHEET 1 OF 1	
SCALE: NTS	DRAWING NO. SP2004/01-200
SIZE: D	

REV	DESCRIPTION	DATE	APPR. BY
0	INITIAL RELEASE	9/30/94	MDB

P-LINC AUXILIARY PORT

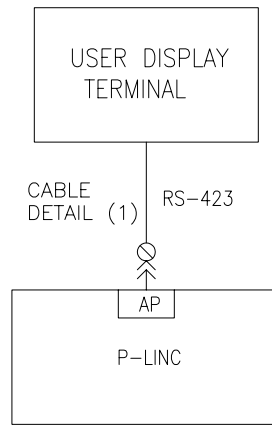

LEGEND

- < - MALE 9-PIN "D" CONNECTOR
- NC - NO CONNECTION
- AP - AUXILIARY PORT (P-LINC)

NOTE: MAXIMUM LENGTH OF RS-423 IS 400' AT 9600 BAUD.

CABLE DETAILS

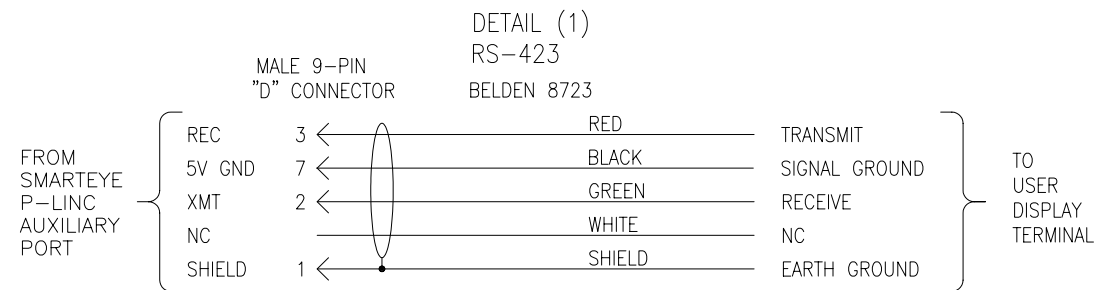

2637 BOND STREET ROCHESTER HILLS, MICHIGAN 48309  
 PHONE (248) 853-4495 FAX (248) 853-8539

DRAWN BY: RSA	TITLE:
CHECKED BY: KLC	SMARTEYE P-LINC
ENGINEER: KLC	AUXILIARY COMMUNICATION PORT
DATE: 9/15/94	CABLE DETAIL
SHEET 1 OF 1	
SCALE: 1" = 1"	DRAWING NO. SP2004/01-311
SIZE: D	

REV	DESCRIPTION	DATE	APPR. BY
0	INITIAL RELEASE	10/3/94	MDB



P-LINC



250VAC  
1 AMP

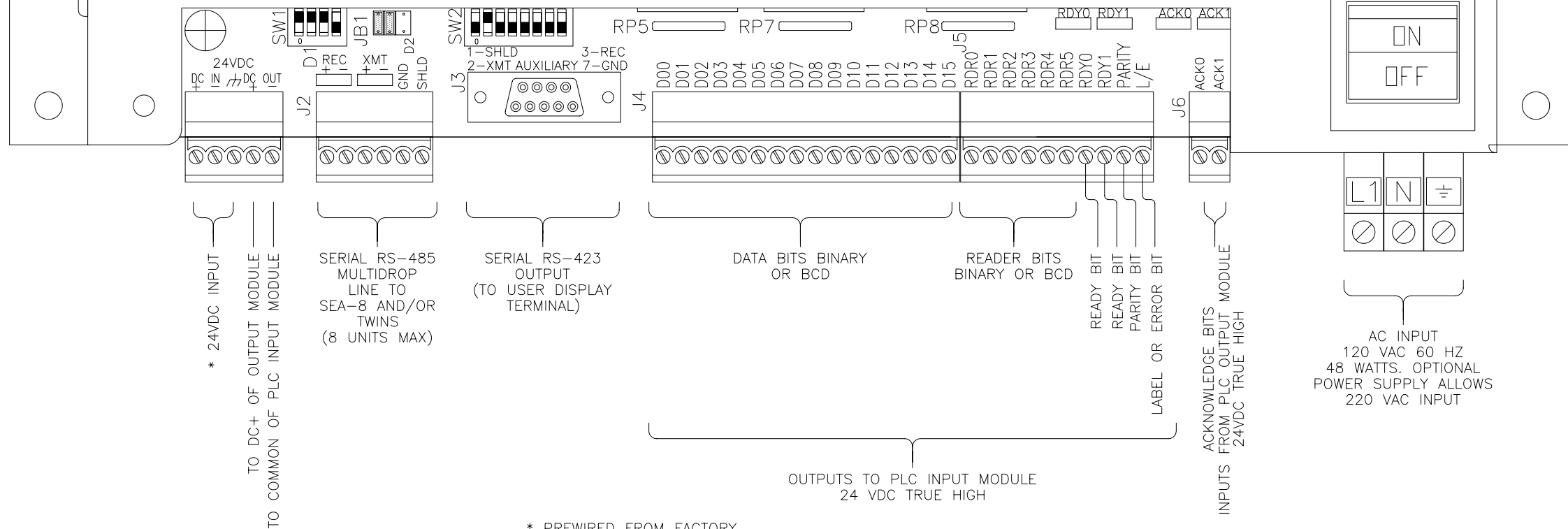

\* PREWIRED FROM FACTORY



2637 BOND STREET ROCHESTER HILLS, MICHIGAN 48309  
PHONE (248) 853-4495 FAX (248) 853-8539

DRAWN BY: RSA	TITLE:
CHECKED BY: MDB	SMARTEYE P-LINC
ENGINEER: KLC	FIELD WIRING DETAILS
DATE: 9/15/94	
SHEET 1 OF 1	
SCALE: NTS	DRAWING NO. SP2004/01-411
SIZE: D	

**CONFIGURATION #1**

(RS-485 POINT TO POINT)

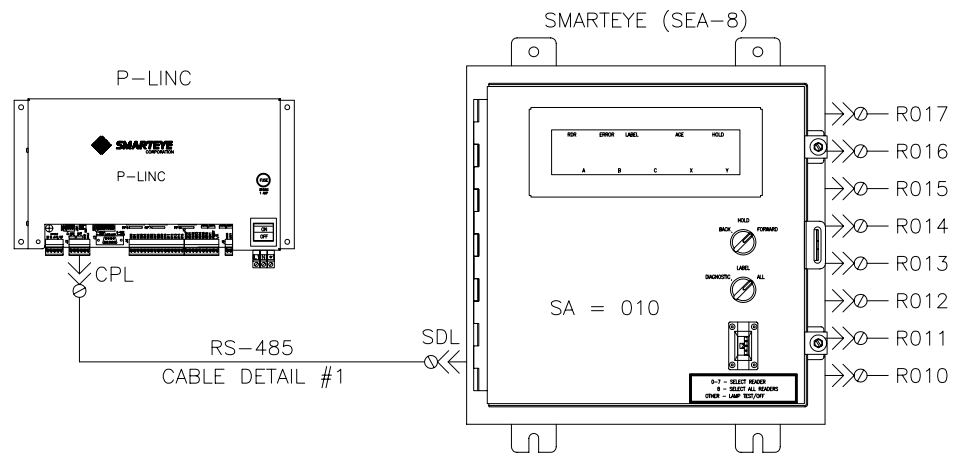

**CONFIGURATION #2**

(RS-485 POINT TO POINT)

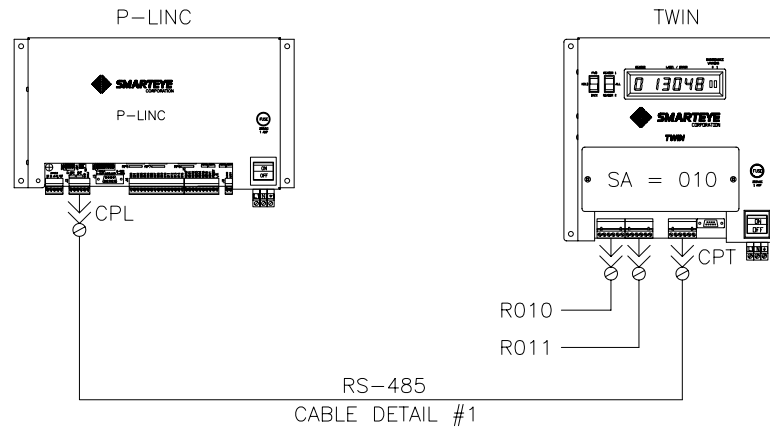

**CONFIGURATION #3**

(RS-485 MULTIDROP)

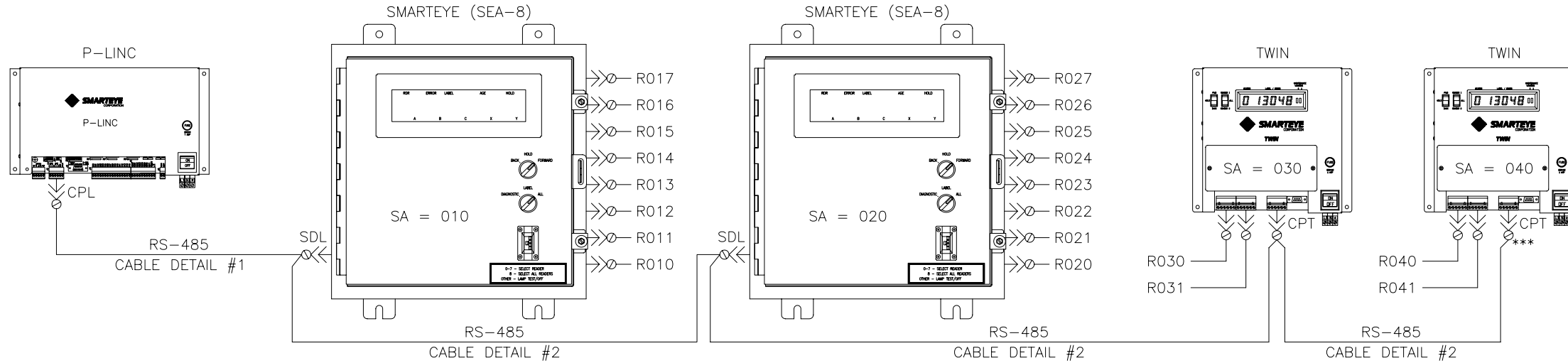

**CABLE DETAILS**

**DETAIL (1)**

RS-485  
BELDEN 9730

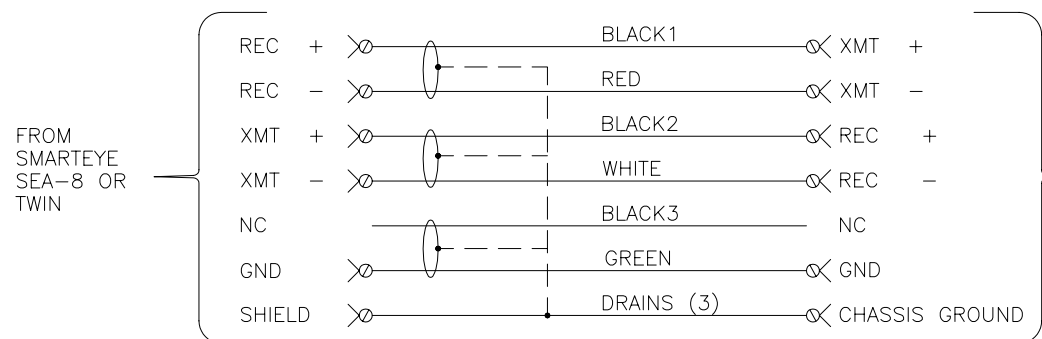

**DETAIL (2)**

RS-485  
BELDEN 9730

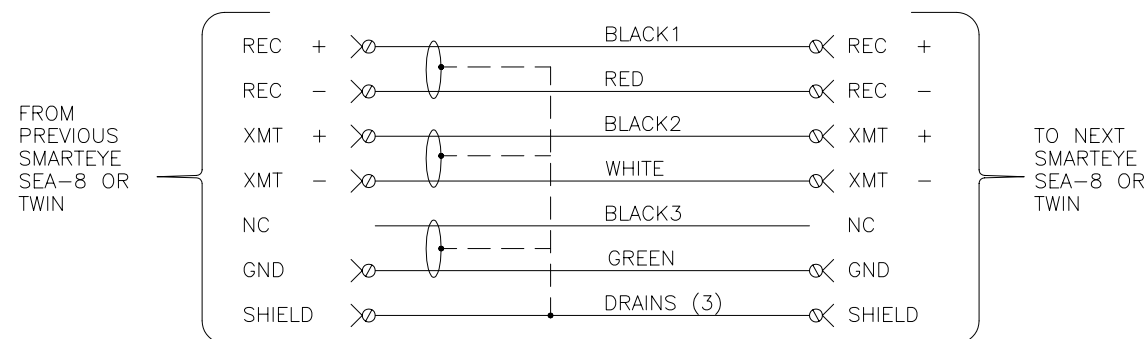

REV	DESCRIPTION	DATE	APPR. BY
0	INITIAL RELEASE	10/5/94	MDB

**LEGEND**

- ⊗ = PLUG-IN SCREW TERMINATION
- \*\*\* = INDICATES SIMPLE LINE TERMINATION INSTALLED
- NC = NO CONNECTION
- SDL = SERIAL DATA LINE
- SA = STARTING ADDRESS OF TWIN OR SEA-8
- CPT = CONTROL PORT (TWIN)
- CPL = CONTROL PORT (P-LINC)

**NOTES:**

1. THE LAST TWIN OR SEA-8 ON THE MULTIDROP LINE MUST HAVE SIMPLE LINE TERMINATION
2. MAXIMUM LENGTH OF RS-485 IS 4000'
3. IN THE MULTIDROP CONFIGURATION EACH TWIN OR SEA-8 MUST HAVE A UNIQUE STARTING ADDRESS
4. VALID ADDRESSES ARE:  
00, 10, 20, 30, 40, 50, 60, 70 OCTAL
5. SEE THE TWIN OR SEA-8 USER MANUALS FOR ADDRESSING DETAILS



2637 BOND STREET ROCHESTER HILLS, MICHIGAN 48309  
PHONE (248) 853-4495 FAX (248) 853-8539

DRAWN BY: RSA	TITLE:
CHECKED BY: MDB	SMART EYE P-LINC
ENGINEER: KLC	CONTROL PORT RS-485 WIRING
DATE: 9/15/94	SHEET 1 OF 1
SCALE: NTS	DRAWING NO. SP2004/01-412
SIZE: D	

REV	DESCRIPTION	DATE	APPR. BY
0	INITIAL RELEASE	10/3/94	MDB

# SMARTEYE P-LINC

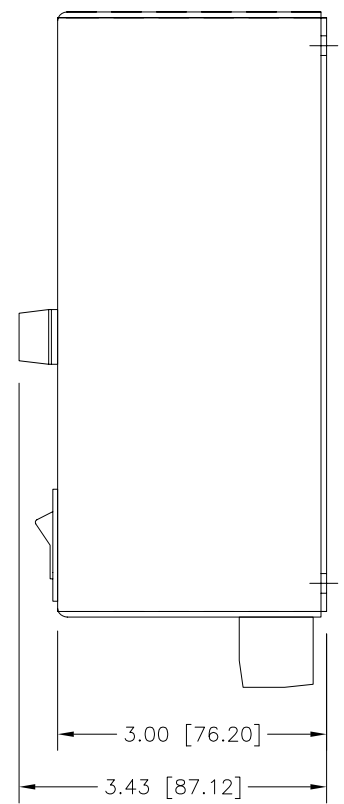
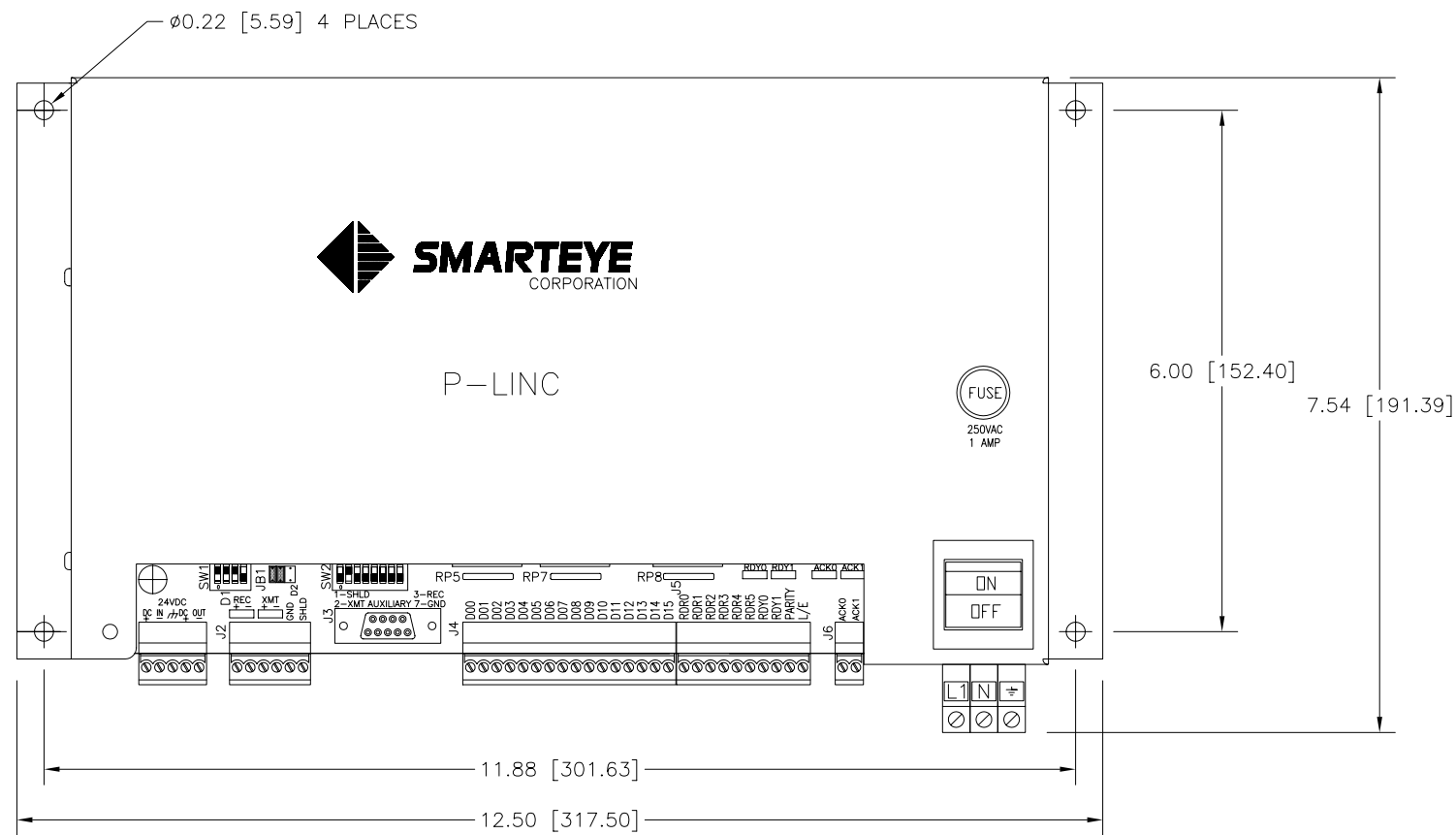

**SMARTEYE CORPORATION**  
 2637 BOND STREET ROCHESTER HILLS, MICHIGAN 48309  
 PHONE (248) 853-4495 FAX (248) 853-8539

DRAWN BY: RSA	TITLE:
CHECKED BY: MDB	SMARTEYE P-LINC
ENGINEER: KLC	INSTALLATION DETAILS
DATE: 9/15/94	
SHEET 1 OF 1	
SCALE: NTS	DRAWING NO. SP2004/01-420
SIZE: D	