

# Teledata

TED-TX10 and TED-RX10



ALGE-TIMING

Manual

## Declaration of Conformity

We hereby declare that the following product complies with the below stated standards. All components used by us are CE certified by their producer and are not modified by ALGE-TIMING GmbH.

We, **ALGE-TIMING GmbH**  
**Rotkreuzstrasse 39**  
**A-6890 Lustenau**

declare in sole responsibility that the radio receiver

### Teledata TED-RX10

complies with the following standards/normative documents and in case of intended use complies with the basic requirements of R&TTE 1999/5/EC:

Telecommunication (TC)terminal device  
**Short Range Device**

Applied harmonized standards...

EN 60950-1: 2006  
EMC: EN300220-1 1.3.1 2000-09  
EN 300220-3 1.1.1 2000-09  
EN 301489-1 V1.8.1 2008  
EN 301489-3 V1.4.1 2002  
EN55022:2006+A1:2007  
EN55024:1998+A1:2001+A2:2003  
EN61000 3-2:2006  
EN61000 3-3:1995+A1:2001+A2:2005

#### **Additional information:**

The product complies with the low voltage directive 73/23/EEC and EMC directive 2004/108EG and carries the CE sign.

Lustenau, 12.01.2010

**ALGE-TIMING GmbH**



Albert Vetter  
(CEO)

## Declaration of Conformity

We hereby declare that the following product complies with the below stated standards. All components used by us are CE certified by their producer and are not modified by ALGE-TIMING GmbH.

We, **ALGE-TIMING GmbH**  
**Rotkreuzstrasse 39**  
**A-6890 Lustenau**

declare in sole responsibility that the radio transmitter

### Teledata TED-TX10

complies with the following standards/normative documents and in case of intended use complies with the basic requirements of R&TTE 1999/5/EC:

Telecommunication (TC)terminal device  
**Short Range Device**

Radio equipment  
**Device class 1**

Applied harmonized standards...

EN 60950-1: 2006  
EMC: EN300220-1 1.3.1 2000-09  
EN 300220-3 1.1.1 2000-09  
EN 301489-1 V1.8.1 2008  
EN 301489-3 V1.4.1 2002  
EN55022:2006+A1:2007  
EN55024:1998+A1:2001+A2:2003  
EN61000 3-2:2006  
EN61000 3-3:1995+A1:2001+A2:2005

**Additional information:**

The product complies with the low voltage directive 73/23/EEC and EMC directive 2004/108EG and carries the CE sign.

Lustenau, am 12.01.2010

**ALGE-TIMING GmbH**



Albert Vetter  
(CEO)

## Important Information

### General

Before using your **ALGE-TIMING** device read the complete manual carefully. It is part of the device and contains important information about installation, safety and its intended use. This manual cannot cover all conceivable applications. For further information or in case of problems that are mentioned not at all or not sufficiently detailed, please contact your **ALGE-TIMING** representative. You can find contact details on our homepage [www.alge-timing.com](http://www.alge-timing.com)

### Safety

Apart from the information of this manual all general safety and accident prevention regulations of the legislator must be taken into account.

The device must only be used by trained persons. The setting-up and installation must only be executed according to the manufacturer's data.

### Intended Use

The device must only be used for its intended applications. Technical modifications and any misuse are prohibited because of the risks involved! **ALGE-TIMING** is not liable for damages that are caused by improper use or incorrect operation.

### Power supply

The stated voltage on the type plate must correspond to voltage of the power source. Check all connections and plugs before usage. Damaged connection wires must be replaced immediately by an authorized electrician. The device must only be connected to an electric supply that has been installed by an electrician according to IEC 60364-1. Never touch the mains plug with wet hands! Never touch live parts!

### Cleaning

Please clean the outside of the device only with a smooth cloth. Detergents can cause damage. Never submerge in water, never open or clean with wet cloth. The cleaning must not be carried out by hose or high-pressure (risk of short circuits or other damage).

### Liability Limitations

All technical information, data and information for installation and operation correspond to the latest status at time of printing and are made in all conscience considering our past experience and knowledge. Information, pictures and description do not entitle to base any claims. The manufacturer is not liable for damage due to failure to observe the manual, improper use, incorrect repairs, technical modifications, use of unauthorized spare parts. Translations are made in all conscience. We assume no liability for translation mistakes, even if the translation is carried out by us or on our behalf.

### Disposal

If a label is placed on the device showing a crossed out dustbin on wheels (see drawing), the European directive 2002/96/EG applies for this device.

Please get informed about the applicable regulations for separate collection of electrical and electronical waste in your country and do not dispose of the old devices as household waste. Correct disposal of old equipment protects the environment and humans against negative consequences!



### Operating ranges and interferences

The **ALGE** Teledata TED-TX10 and TED-RX10 operate in 433 MHz frequency band. This is also used by other radion services. The operating range as well as the operation may be disturbed by devices working at the same or neighboring frequencies.

### Copyright by **ALGE-TIMING** GmbH

All rights reserved. Any duplication, either in full or in part, requires the prior written consent of the copyright holder.

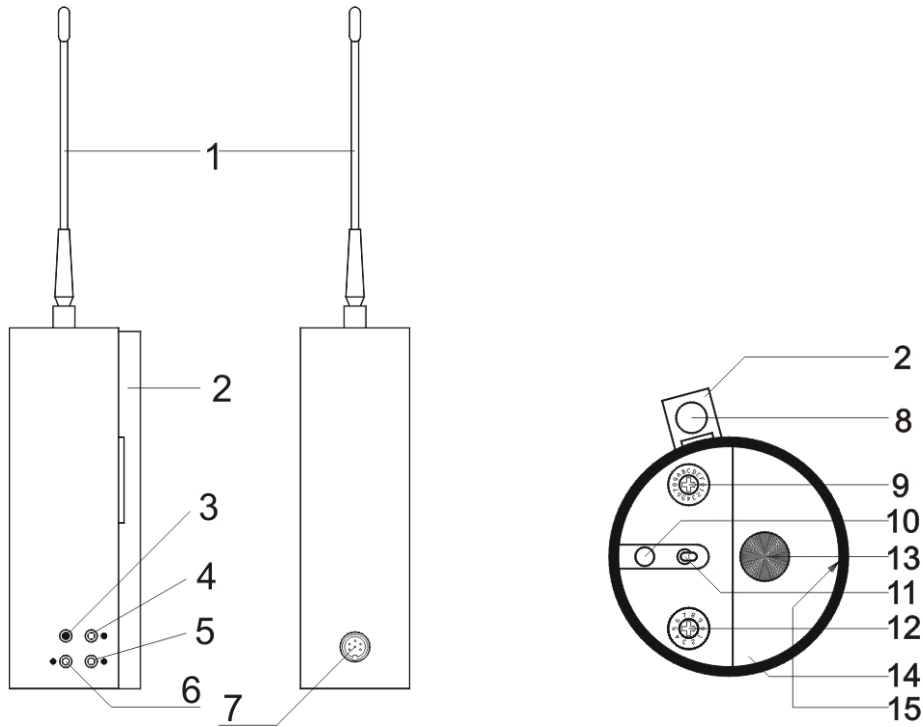

- Transmitter
- 1 Antenna
  - 2 Green holder with Velcro fastener
  - 3 Light emitting diode (LED)
  - 4 Banana socket yellow: data input
  - 5 Banana socket green: signal input
  - 6 Banana socket black: common mass
  - 7 DIN socket: data and signal input and external supply
  - 8 3/8" thread for tripod fastening
  - 9 Code switch (16 positions)
  - 10 Device button
  - 11 Device switch
  - 12 Code switch (10 positions)
  - 13 Fastening screw for battery cover
  - 14 Battery cover
  - 15 Type plate with device number

- Receiver
- 1 Antenna
  - 2 Red holder with Velcro fastener
  - 3 Light emitting diode (LED)
  - 4 Banana socket yellow: data output
  - 5 Banana socket green: signal output
  - 6 Banana socket black: common mass
  - 7 DIN socket: data and signal output and external supply
  - 8 3/8" thread for tripod fastening
  - 9 Code switch (16 positions)
  - 10 Device button
  - 11 Device switch
  - 12 Code switch (10 positions)
  - 13 Fastening screw for battery cover
  - 14 Battery cover
  - 15 Type plate with device number

## Table of Contents

<b>1</b>	<b>General .....</b>	<b>7</b>
<b>2</b>	<b>Power supply .....</b>	<b>7</b>
2.1	Batteries .....	8
2.2	Battery replacement .....	8
2.3	Operation with alkaline batteries .....	8
2.3.1	Battery warning.....	8
2.3.2	Operating period.....	9
2.4	Operation with NiCd rechargeable batteries .....	9
2.4.1	Rechargeable battery warning.....	9
2.4.2	Operating period.....	9
2.5	External supply.....	9
2.5.1	Direct Supply .....	10
2.5.2	Supply by timing device .....	10
<b>3</b>	<b>Startup.....</b>	<b>10</b>
3.1	Operation range and interference: .....	10
3.2	Installation .....	11
3.3	Switching on.....	12
3.4	Selecting the operations modes .....	13
3.5	Addressing .....	13
3.6	Field intensity test for location search .....	14
3.7	Interference test – audio monitoring of the receiver for interference signals.....	14
<b>4</b>	<b>Impulse transmission .....</b>	<b>14</b>
4.1	Impulse transmission from a startgate .....	16
4.2	Impulse transmission from a photocell .....	16
4.3	Impulse transmission from a photocell with adapter 129-06 .....	16
4.4	Impulse transmission with more than two timing channels .....	17
4.5	Impulse transmission several timing channels with Timy and cable 207-10 .....	19
<b>5</b>	<b>Data transmission .....</b>	<b>19</b>
5.1	Data transmission 1 second.....	20
5.1.1	Data transmission from Timer S4 to Timer S4.....	20
5.1.2	Data transmission from ALGE timing device to Printer P4A .....	21
5.2	Display transmission 1 second.....	22
5.2.1	Data transmission to ALGE display board.....	22
5.2.2	Data transmission from Timy to ALGE soccer scoreboard .....	22
5.2.3	Data transmission from ALGE timing device to PC .....	23
5.3	Data transmission direct.....	24
<b>6</b>	<b>Technical data .....</b>	<b>25</b>

## 1 General

The TED-TX10 does not have to be authorized in EC and EFTA countries. Nevertheless, we recommend to check the legal conditions of the country to avoid problems with local and/or new laws. For countries outside Europe, please check in the corresponding country if the device may be used.

<b>Purpose:</b>	Wireless transmission of timing impulses or data
<b>Transmitting frequency:</b>	in 433 MHz band
<b>TED-TX10:</b>	Teledata transmitter with output power of 10mW, approx. 1.5 km operation range, I/4 antenna
<b>TED-RX10:</b>	Teledata receiver for TED-TX10 with I/4 antenna
<b>Minimal equipment:</b>	1 x TED-TX 10 and 1 x TED-RX10
<b>Extended equipment:</b>	additional TED-TX10 for impulse transmission and additional TED-RX10 for data transmission. <b>RX-C10</b> for impulse transmission in case of more than two timing channels (except Timy)
<b>Recognition feature for TED-TX:</b>	Type plate (15) and green holder (2)
<b>Recognition feature for TED-RX:</b>	Type plate (15) and red holder (2)
<b>Impulse transmission:</b>	The impulse transmission works directly from an <b>ALGE</b> impulse transmitter to an <b>ALGE</b> timing device.
<b>Data transmission ALGE "1 Sec.":</b>	Each dataset is transmitted 10 times for safety reasons. One dataset per second is transmitted.
<b>Data transmission display board:</b>	Each dataset is transmitted once. Every second one dataset can be transmitted.
<b>Data transmission 2400 baud:</b>	Each dataset is transmitted once with 2400 baud. At the beginning of each dataset there has to be an identifier for the beginning of the data transmission and at the end for the end of the data transmission.
<b>Data transmission 4800 baud:</b>	Each dataset is transmitted once with 4800 baud. At the beginning of each dataset there has to be an identifier for the beginning of the data transmission and at the end for the end of the data transmission.
<b>Data transmission direct:</b>	All data is transmitted without check.
<b>System test:</b>	Field intensity and interference test
<b>Power supply:</b>	With 6 batteries or with 6 NiCd rechargeable batteries or with external supply
<b>National radio authorization:</b>	The authorization regulations are different in each country. Please check if the acquired device complies with the legal conditions of the country in which it is used.

## 2 Power supply

Two kinds of power supply are possible:

- Internal power supply with either six batteries (type AA) or rechargeable batteries (type AA).
- External power supply with **ALGE** power supply unit, via the timing device or a 12V battery

## 2.1 Batteries

In case the device is not in use for a long period, we recommend to remove the batteries from the battery compartment.

Batteries can be perilous when swallowed. Keep out of reach of children. Do not throw into open fire. Please dispose of the batteries ecologically sensitive.

## 2.2 Battery replacement

The battery compartment can be reach from underneath the TED.

The knurled screw has to be unscrewed counter-clockwise.

Take away the cover.

Remove the batteries (place device upright so that the batteries can slide out).

Insert new (or charged) batteries (mind the polarity, see battery compartment).

Close cover and tighten knurled screw. The screw has to be tightened as far as it will go.

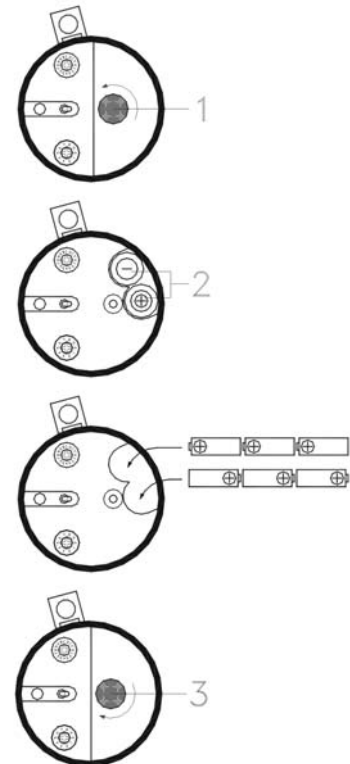

## 2.3 Operation with alkaline batteries

Every TED requires 6 alkaline batteries (type AA). The battery condition is indicated by the LED during normal operation.

Color of LED (3)	Battery capacity
green	35 - 100 %
limit between green and orange	approx. 35 %
orange	20 - 35 %
limit between orange and red	approx. 20 %
red	less than 20 %
off	empty

The TED automatically switches off if the battery voltage drops below 5 Volt.

**Attention:** During field intensity test the LED has a different function (see 3.6)

### 2.3.1 Battery warning

If the battery capacity at the TED-TX is less than 20 % (LED red), it transmits this information the TED-RX with the next impulse or dataset. The RX switches on the internal speaker for an alternating high and low tone.

If the battery capacity at the TED-RX ist less than 20 % the speaker is immediately activated with an alternating high and low tone.



### 2.3.2 Operating period

The below stated measurements apply to alkaline batteries at room temperature (25 ° C). Mind that the capacity of the batteries is extremely reduced at low temperatures (at -20° C only about 20 % capacity).

TED-TX10	without photocell	1 impulse per minute	approx. 300 hours
TED-TX10	with photocell	1 impulse per minute	approx. 66 hours
TED-TX10	---	1 dataset per minute	approx. 270 hours
TED-TX10	---	permanent operation seconds mode	approx. 54 hours
TED-RX10	---	equal for all operation modes	approx. 54 hours

## 2.4 Operation with NiCd rechargeable batteries

Each TED requires 6 NiCd rechargeable batteries (type Energizer). The batteries cannot be charged inside the device. For charging a separate charging unit is required. The battery condition (battery capacity) is indicated by the LED (3) during normal operation.

Color of LED (3)	Battery capacity
green	15 – 100 %
limit between green and orange	approx. 15 %
orange	5 – 15 %
limit between orange and red	approx. 5 %
red	less than 5 %
off	empty

The TED automatically switches off if the battery voltage drops below 5 Volt.

**Attention:** During field intensity test the LED has a different function (see 3.6)

### 2.4.1 Rechargeable battery warning

See 2.3.1

### 2.4.2 Operation period

The below stated measurements apply to batteries of the type Panasonic 700mAh at room temperature (25° C). Mind that the capacity of the battery is reduced at low temperatures (at - 20° C only about 80 % capacity).

TED-TX10	without photocell	1 impulse per minute	approx. 100 hours
TED-TX10	with photocell	1 impulse per minute	approx. 22 hours
TED-TX10	---	1 dataset per minute	approx. 90 hours
TED-TX10	---	permanent operation seconds mode	approx. 18 hours
TED-RX10	---	equal for all operation modes	approx. 18 hours

## 2.5 External supply

The TED can be supplied from a power supply unit.

Supply voltage:

TED-TX10 +6,5 - 28 VDC

TED-RX10 +6,5 - 28 VDC

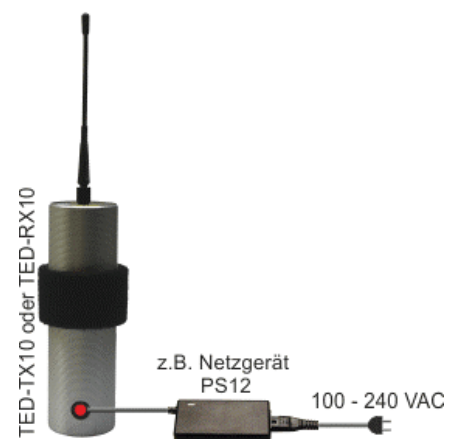

### 2.5.1 Direct Supply

The TED can be supplied by the **ALGE** power supply units.

### 2.5.2 Supply by timing device

In the operation mode impulse transmission the TED-RX can be powered by the power supply unit of the timing device. Cable 004-05 is required for connection between TED-RX and timing device.

**ATTENTION:** This only works if the timing device is connected with an external supply.

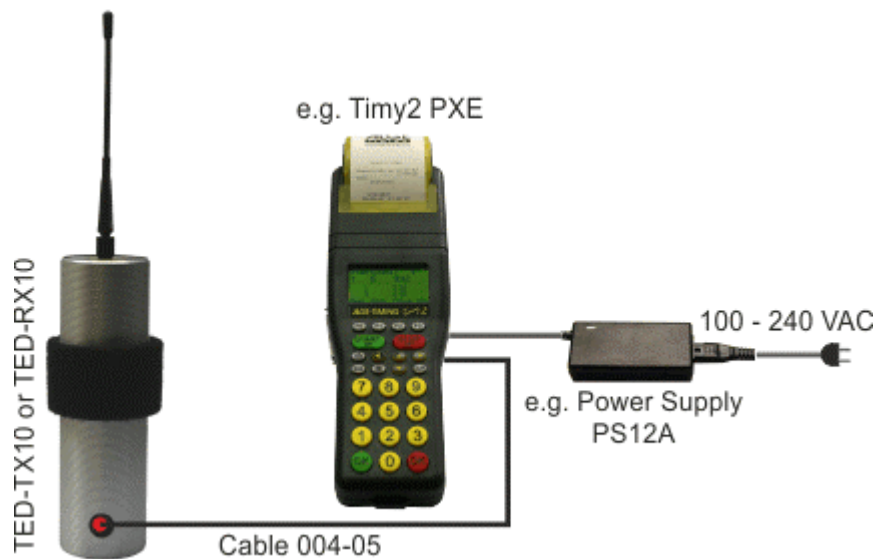

## 3 Startup

The operation range of the radio connection is extremely dependent on the location of the transmitter and receiver. Often just a minimal change of location of the TED-TX or TED-RX results a considerable improvement of the receiving field intensity (high field intensity = high safety).

### 3.1 Operation range and interference:

The TED-TX10 and RX10 work in a 433 MHz frequency band. This is also used by other radio services. Devices working at the same or neighboring frequencies may limit the range or the operation.

Attention: Never place several radio receivers next to each other. They might influence each other negatively. A minimum distance of 0.2 m has to be kept. We recommend 0.5 m or more.

Further causes for reduced operation ranges can be:

- High frequency interference of all sorts
- Buildings or construction of any kind and vegetation
- Conducting metal parts in the proximity of the TED and/or within or near the transmission path (e. g. metal insulation windows, armored concrete ceilings, radiators).
- Interference of the radiation characteristics of the antennas by the distance of transmitter or receiver to conducting surfaces or objects (also to human body or ground).
- Broadband interference in urban areas, that reduce the signal-to-noise ratio, the signal is not recognized inside this noise
- Radiation of electronic devices that are not or only inadequately shielded (e. g. open computers).

### 3.2 Installation

There are several possibilities to install or fit the TED.



**Bad:**  
The TED should never be placed directly on the floor. To much operation range is lost.

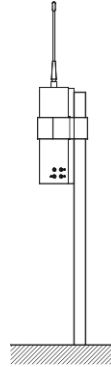

**Good:**  
Fastening with Velcro fastener. In critical situations always mount overhead.

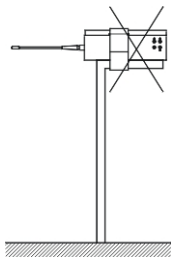

**Bad:**  
The antenna always has to point upward.

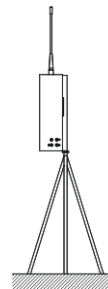

**Good:**  
Fastening on tripod (3/8")

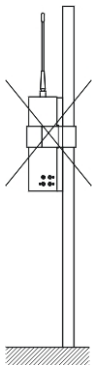

**Bad:**  
No parts allowed in the proximity of the antenna.

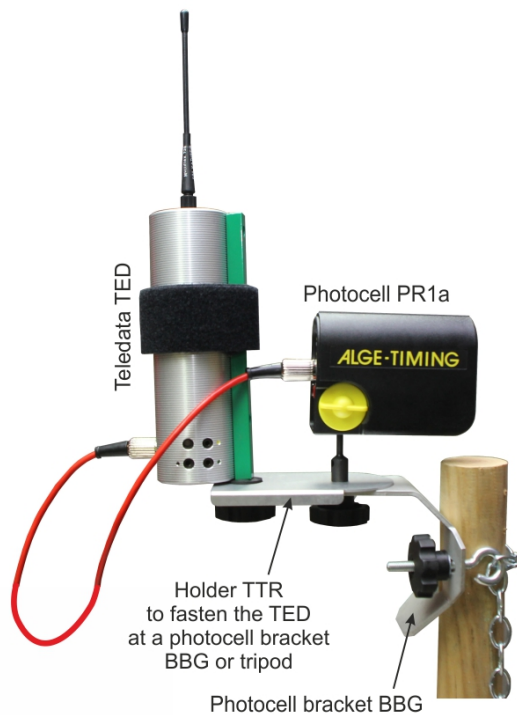

### 3.3 Switching on

#### Normal operation

- Switch on device switch (11)
- TED works in operation mode „impulse transmission“
- LED blinks

#### Test Mode

- Press device button (10)
- Device switch (11) at „ON“, LED must blink
- Release device button
- Test mode switches automatically off after one minute, immediate switch off with device button (10)

#### Data transmission **ALGE 1 sec.**

- Switch on TED, LED must blink
- If the first dataset arrives in correct format the data transmission is activated 1 second.

#### Data transmission **ALGE 0.1 sec.**

- Turn code switch (12) of the TED-TX and RX to position 1
- Switch on TED, LED must blink

#### Data transmission **2400 baud**

- Turn code switch of TED-TX and RX to position 3
- Switch on TED, LED must blink
- Every dataset is transmitted once with 2400 baud
- At the beginning of every dataset there has to be an identifier for the start of data transmission and at the end for the end of the data transmission.

#### Data transmission **4800 baud**

- Turn code switch of TED-TX and RX to position 4
- Switch on TED, LED must blink
- Every dataset is transmitted once with 4800 baud
- At the beginning of every dataset there has to be an identifier for the start of data transmission and at the end for the end of the data transmission.

#### Data transmission **direct**

- Turn code switch of TED-TX and RX to position 6
- LED of TED-RX must glow
- LED of TED-TX blinks. **One dataset has to be transmitted so that the TED switches to direct mode** (LED switches from blinking to glowing).
- Every dataset is transmitted

### 3.4 Selecting the operations modes

Switch	Signal Mode	Data Mode
Code switch (12)	Position 0 to 9 for selecting timing channel	Position 0: data transmission ALGE 1 second
		Position 1: data for display board ALGE 1 sec.
		Position 2: no function
		Position 3: data transmission 2400 baud
		Position 4: data transmission 4800 baud
		Position 5: no function
		Position 6: data transmission direct
		Positions 7 to 9: no function
Code switch (9)	for addressing	for addressing
Device button (10)	Field intensity test on/off	repeat latest dataset

The field intensity test can also be started by three times shorting the green and black banana socket.

### 3.5 Addressing

The code switch (9) for addressing has 16 positions and can be accessed from underneath. In one system all TED-TX and RX have to be addressed identically.

Address as desired with the included screw driver. The arrow of the switch shows the switch position. Default setting is 0.



In case multiple TEDs are used in the same area, different addresses have to be used. **It offers protection against false impulses or data but not against blocking by another device.**

Code switch (9)	Address
Switch position = 0	Address = 0
Switch position = 1	Address = 1
Switch position = 2	Address = 2
Switch position = 3	Address = 3
Switch position = 4	Address = 4
Switch position = 5	Address = 5
Switch position = 6	Address = 6
Switch position = 7	Address = 7
Switch position = 8	Address = 8
Switch position = 9	Address = 9
Switch position = A	Address = A
Switch position = B	Address = B
Switch position = C	Address = C
Switch position = D	Address = D
Switch position = E	Address = E
Switch position = F	Address = F

For preventing a blocking by another TED, a different radio frequency has to be used.

#### Example impulse transmission of a start signal:

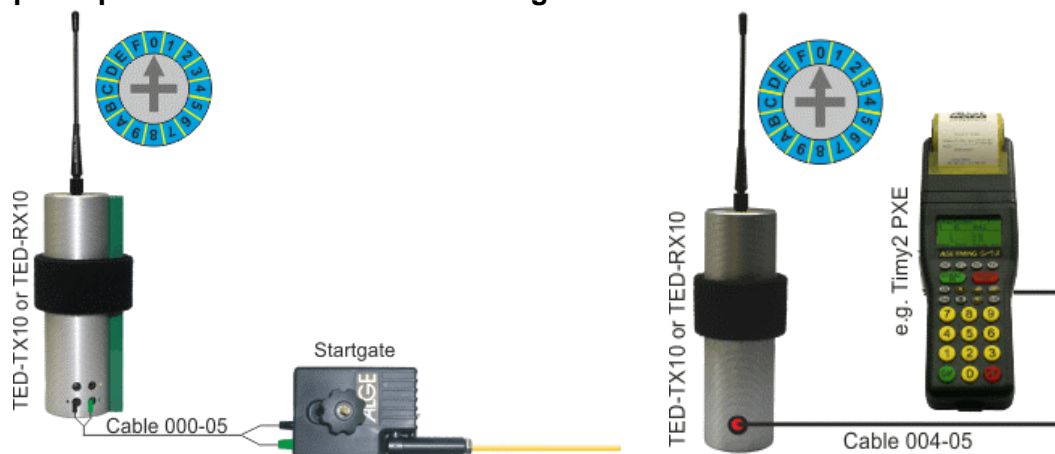

TED –TX and RX must be switched to the same address

### 3.6 Field intensity test for location search

The field intensity test can only be executed in the operation mode „impulse transmission“. For problem-free work with the TED, an optimal location has to be found.

Activate field intensity:

- Switch on TED-TX
- Press device button (10)
- Fasten TED in the height (page 11)
- Switch on TED-RX
- The speaker of the TED-RX makes a tone and the LED blinks.
- The higher the tone the higher (better) the field intensity.
  - o LED blinks green > signal is good
  - o LED blinks orange > signal is weak
  - o LED blinks red > signal missing or too weak
- If you hear voices over the speaker, this frequency is momentarily used by voice radio. This might lead to data or impulse losses.
- The field intensity test is automatically ended by the TED-TX after one minute.

For finding the optimal location the receiver has to be moved. The best location is reached when the tone sounds the highest and the LED blinks green.

***The field intensity can only be evaluated at the TED-RX!***

The TED-TX and RX must have a distance of about 5 – 10 m for an undisturbed operation.

### 3.7 Interference test – audio monitoring of the receiver for interference signals

If the device button of the TED-RX is pressed for about half a second, the speaker is activated and can be used to monitor possible interference signals.

Simultaneously the LED shows the field intensity of the received signal also those of a possible interference.

**ATTENTION:** The power consumption of the TED-RX is doubled during this test. To switch off the speaker press device button (10).

## 4 Impulse transmission

The impulse transmission works directly from an **ALGE** impulse transmitter to an **ALGE** timing device by radio. Every impulse transmitted by the TED has a constant delay of 0.100 seconds. Maximum fault: 0.001 seconds

If only the start impulse is transmitted by the TED, the running time has to be increased by one tenths of a second. If only the finish impulse is transmitted, the running time has to be decreased by one tenths of a second. If both impulses are transmitted the running time is correct.

The TED-TX is blocked for 0.163 seconds from the start of the impulse and/or occurring impulses within this time are delayed for until this time is up. The TED-RX is blocked for 0.1 seconds from the start of the impulse and ignores all impulses within this period.

**Bounce protection**

The TED-TX is provided with a bounce protection. The bounce protection prevents double impulses of a bouncing switch contact. Debouncing time is 50 ms.

- A Bouncing at the beginning of the impulse
- B Bouncing at the end of the impulse
- C Impulse duration plus bouncing duration
- D Bouncing duration 50 ms
- E Bounce protection is interrupted as the 50 ms are not up

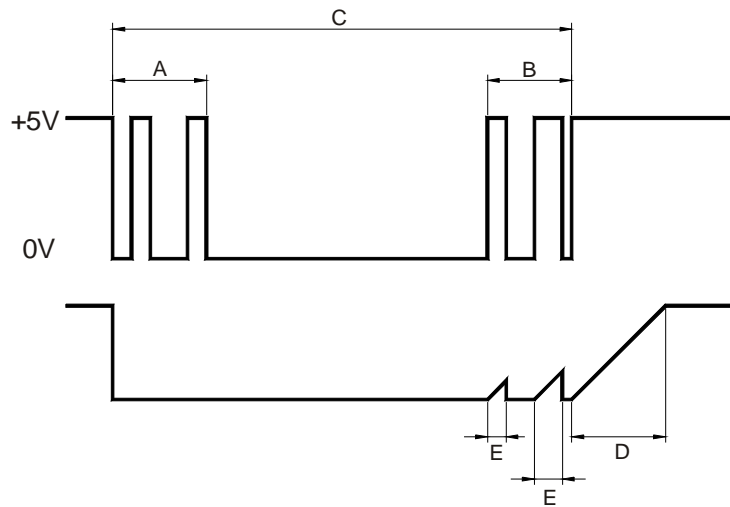

**Test of impulse transmission**

If a timing impulse is transmitted, the LED blinks longer once at TED-TX and RX.

**Safety of impulse transmission**

Always consider that the radio connection may be interfered by external factors. In case of interference no impulse is transmitted. With radio impulse transmission it is never possible to reach the same safety as with cable impulse transmission.

**The following ALGE devices can be used as impulse transmitter**

- all startgates
- photocells RLS1n, RLS1c, PR1a, RLS3, etc.
- SM8, STB1, Tapeswitch, push-button 023-xx
- Touch pads TP
- ASC

**The following ALGE devices can be used as impulse receiver**

- TDC4000
- TDC8000
- TDC8001
- Timy
- Comet
- Timer S4
- Timer S3
- Videotimer VT2 / VT2D
- Fotofinish OPTI (only start impulse)

With the standard TED only two timing channels can be transmitted. When using cable 004-xx, this generally is start channel C0 and finish channel C1.

With an additional RX-C10, up to 10 different channels can be received on TDC8000/8001 and Timer S4.

**4.1 Impulse transmission from a startgate**

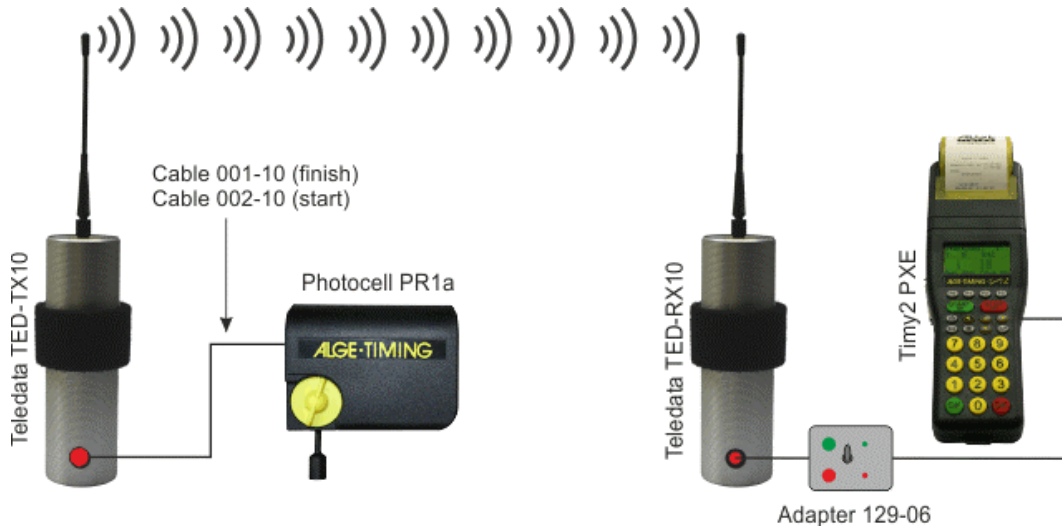

**4.2 Impulse transmission from a photocell**

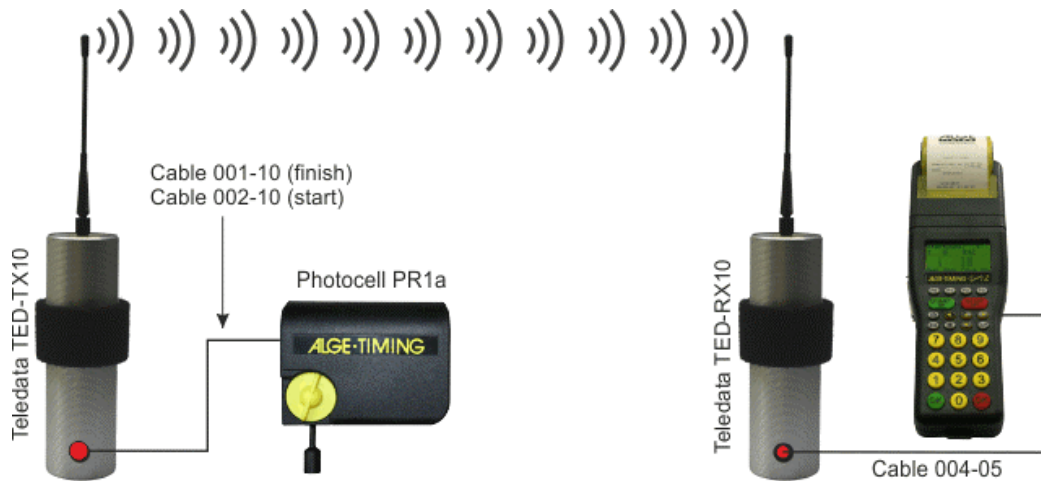

**4.3 Impulse transmission from a photocell with adapter 129-06**

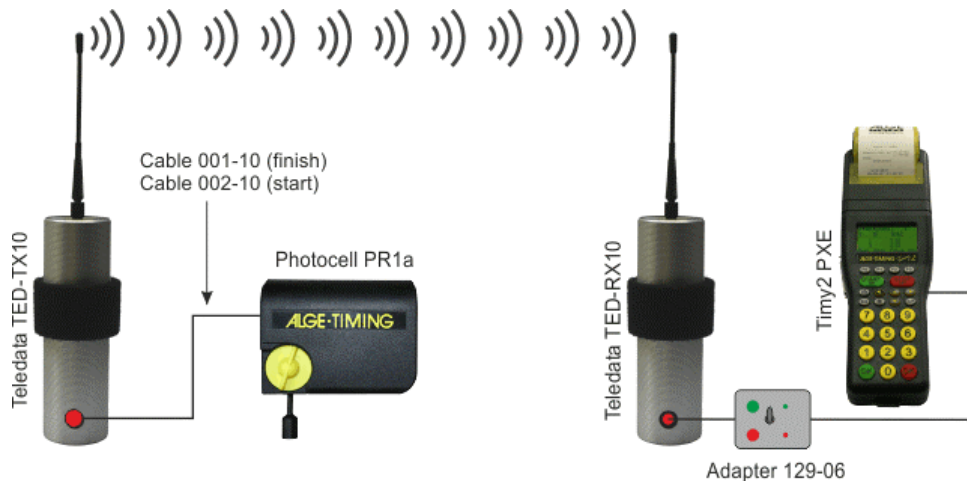

With the adapter 129-06 it can be set if it is a start or stop impulse. This is of advantage if only one photocell is used for a circuit.



#### 4.4 Impulse transmission with more than two timing channels

For this, the adapter RX-C10 is required. In connection with TDC8000/8001 and Timer S4 it is possible to transmit up to 10 timing channels. However, several TED-TX have to be used for it. Per each TED-TX two timing channels can be transmitted.

The timing channels are set with code switch (12) at the TED-TX. The code switch (12) at the TED-RX has no function in this mode.

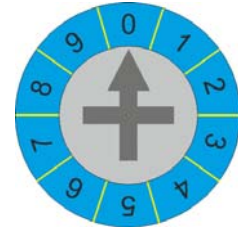

**ATTENTION** Blocking time (see 4, Impulse transmission)

Turn the arrow with the included screw driver to the correct position.

TED-TX Code-Schalter (12)	TED-TX timing channel banana socket green (5) and black (6)	TED-TX DIN-socket timing channel on pin 1	TED-TX DIN-Stecker timing channel on pin 2
switch position = 0	0	0	1
switch position = 1	1	1	2
switch position = 2	2	2	3
switch position = 3	3	3	4
switch position = 4	4	4	5
switch position = 5	5	5	6
switch position = 6	6	6	7
switch position = 7	7	7	8
switch position = 8	8	8	9
switch position = 9	0	0	2

#### Timing with 10 timing channels at a skiing test track

Settings of code switch (12) at TED-TX

Channel	Function	Impulse transmitter	Switch position code switch	cable type	connection socket
C0	start	startgate	0	000-10	banana socket
C2	intermediate time	photocell	1	001-10	DIN socket
C3	intermediate time	photocell	2	001-10	DIN socket
C4	intermediate time	photocell	3	001-10	DIN socket
C5	intermediate time	photocell	4	001-10	DIN socket
C6	intermediate time	photocell	5	001-10	DIN socket
C7	intermediate time	photocell	6	001-10	DIN socket
C8	intermediate time	photocell	7	001-10	DIN socket
C9	intermediate time	photocell	8	001-10	DIN socket
C1	finish	photocell	0	001-10	DIN socket

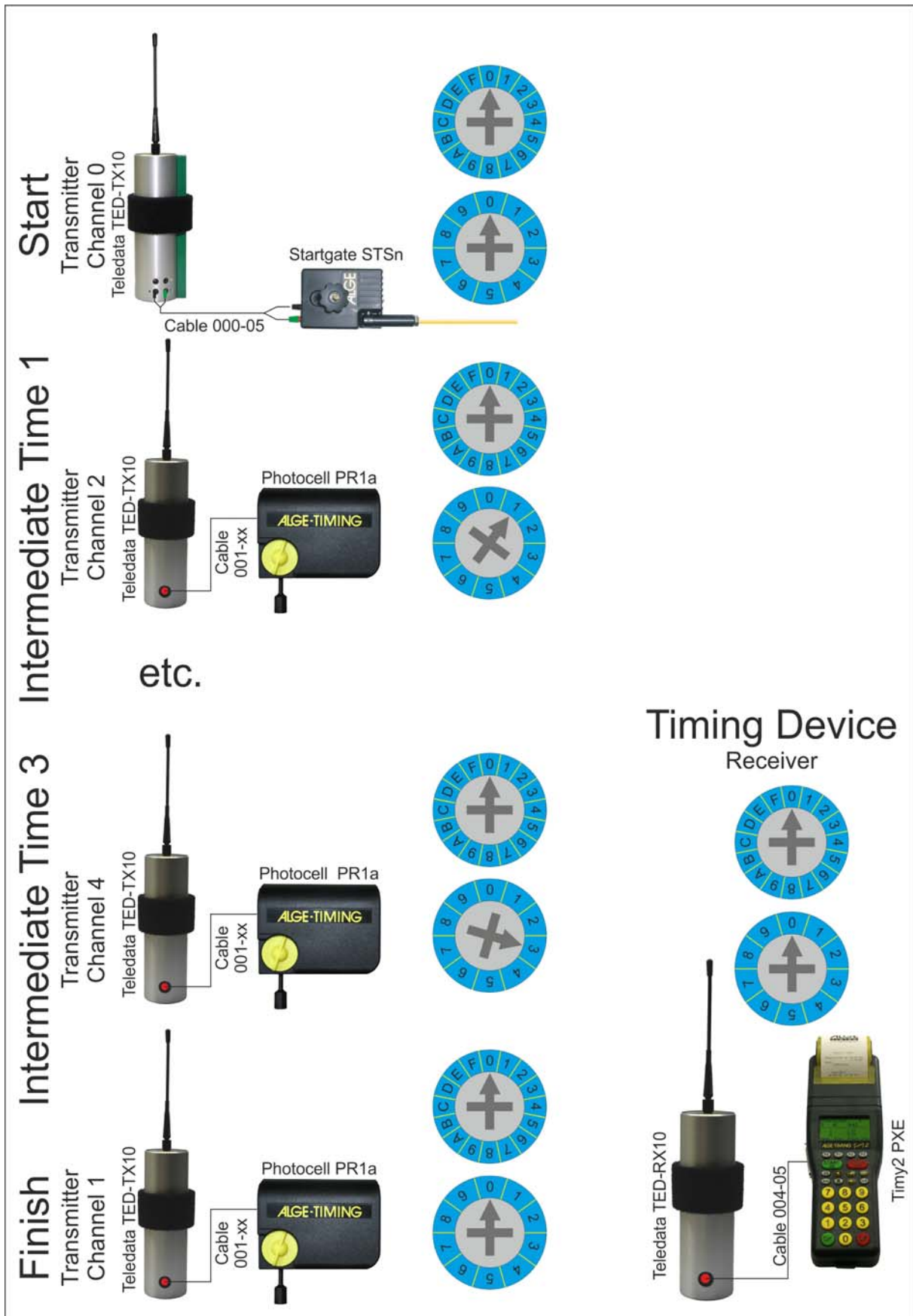

## 4.5 Impulse transmission several timing channels with Timy and cable 207-10

The cable 207-10 works only in connection with the Timy. Only start cables (000-xx or 002-xx) may be used. When using a stop cable no impulse is transmitted and an error message is printed.

The function of code switch (12) is as below stated. This has no relevance for program training REF. It is important that the channels of the TEDs differ.

Code switch	Channel	Function
0	C0	start
1	C1	finish
2	C2	intermediate time
3	C3	intermediate time
4	C4	intermediate time
5	C5	intermediate time
6	C6	intermediate time
7	C7	intermediate time
8	C8	intermediate time
9	C9	intermediate time

## 5 Data transmission

For data transmission the **Duty Cycle** must be considered. According to the regulations of the Regulatory Authority for Radio of the European Union, the radio transmitter must only be in operation 10 %. This also has to be considered when applying this device.

For operating the Teledata TED (device class 1) the transmission period of 6 minutes per hour must not be exceeded (10 % duty cycle). This means it is not allowed to send data constantly. In case the device is used for data transmission of the timing times, the transmitter is only active for 1/10 seconds for transmitting each time and stays below the duty cycle.

### Field of application:

Data transmission from an **ALGE** timing device to an **ALGE** display board  
 Data transmission from Timer S4 to Timer S4 (program 0)  
 Data transmission from an **ALGE** timing device to printer P5  
 Data transmission from an **ALGE** timing device to Timy parallel display  
 Data transmission from Timy to soccer score board  
 Data transmission from an **ALGE** timing device to a PC  
 Data transmission from PC to PC

### The following operating modes are available:

Data transmission <b>ALGE</b> 1 second:	<b>ALGE</b> protocol, 1 dataset per second
Scoreboard transmission <b>ALGE</b> 1 second:	<b>ALGE</b> protocol, 1 dataset per second
Data transmission 2400 baud:	Data transmission with control character and 2400 baud
Data transmission 4800 baud:	Data transmission with control character and 4800 baud
Data transmission direct:	Data transmission without protocol and from 2400 to 4800 baud

**Data repetition:**

In case the data does not reach the receiver, the data can be repeated at the transmitter. The latest dataset is always stored at the TED-TX.

Press device button (10) at TED-TX

or

Press push-button connected to green and black banana socket of TED-TX

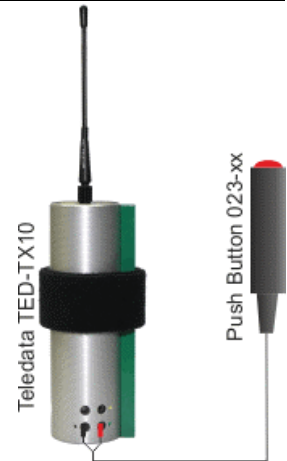

**5.1 Data transmission 1 second**

**Setting:** Code switch (12) of TED-TX and RX at position 0

When the TED-TX recognizes sensible data (ALGE protocol), it changes to operating mode "Data transmission 1 second". In this mode, each dataset is transmitted ten times with a check sum. As soon as the TED-RX receives the dataset at least once with the correct check sum, the dataset is output.



This mode is used when it is important that all data reaches the receiver safely. This only works if data are not sent constantly. In case the data are sent continuously (e.g. for a display board), they could be partly swallowed.

**5.1.1 Data transmission from Timer S4 to Timer S4**

The Timer S4 can supply TED-TX and RX via a serial interface.

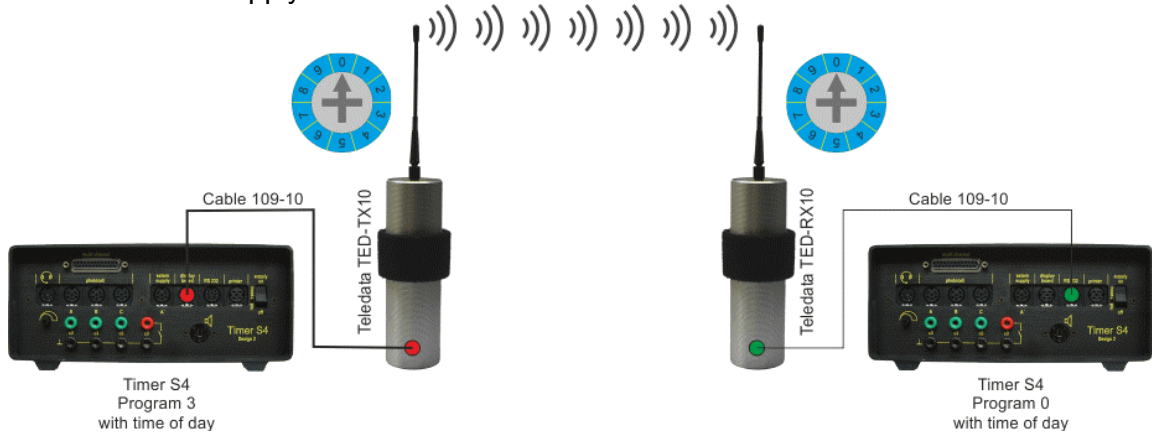

Timer S4 with TED without supply of the TEDs

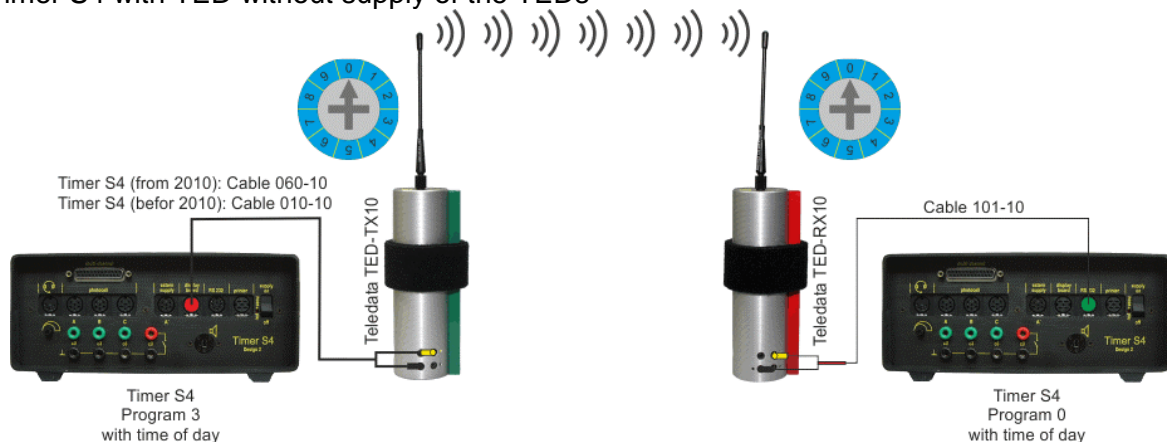

Data transmission of start time from a synchronized Timer S4 to another Timer S4:

- Set program 3 on Timer S4 at start and enter daytime
- Press yellow and red button at the same time
- The display of Timer S4 shows „HP 0:00.00“
- Enter hours with red button
- Enter minutes with yellow button
- Set program 0 on Timer S4 at finish and enter daytime
- Press yellow and red button at the same time
- Press again red and yellow button at the same time
- The display of Timer S4 shows „SY 0:00.00“
- Enter hours with red button
- Enter minutes with yellow button
- Start both Timer S4 simultaneously (synchronized start).
- The display of finish timer shows the daytime
- Press yellow and red button at the same time to delete daytime
- Program 0 works now as described in Timer S4 manual
- The start Timer has to be taken to the start

**Data repetition**

If the start time does not reach the finish Timer, the data can be sent again (see page 20)

**5.1.2 Data transmission from ALGE timing device to Printer P4A**



If the output RS232 of the timing device is used, the TED-TX requires the cable 060-10.



## 5.2 Display transmission 1 second

**Setting:** Code switch (12) of TED-TX and RX on position 1

Only for data with **ALGE** protocol. One data transmission per second is effected from TED-TX to RX. Each dataset is only sent once. Every dataset has a check sum. If this is correct, the incoming data is output. In this mode, the time can be transmitted with running seconds.

This mode is used when it is important that the data is available immediately or when many datasets are transmitted within a short period of time. The transmission safety is not as high as with "Data transmission 1 second".

### 5.2.1 Data transmission to **ALGE** display board



### 5.2.2 Data transmission from Timy to **ALGE** soccer scoreboard

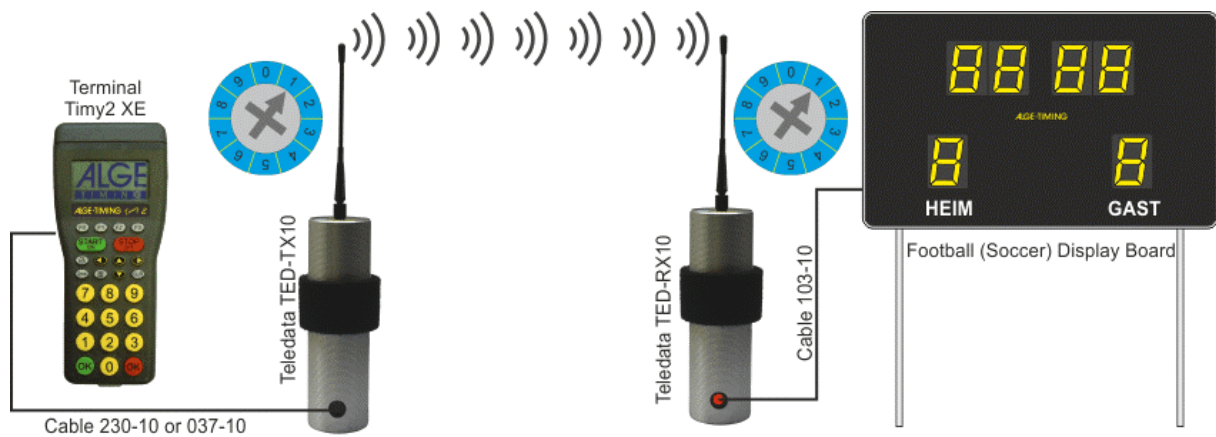

In order to supply the TED-TX by the Timy, cable 108-10 is required. It is recommended to supply the Timy by an **ALGE** power supply unit.

5.2.3 Data transmission from **ALGE** timing device to PC

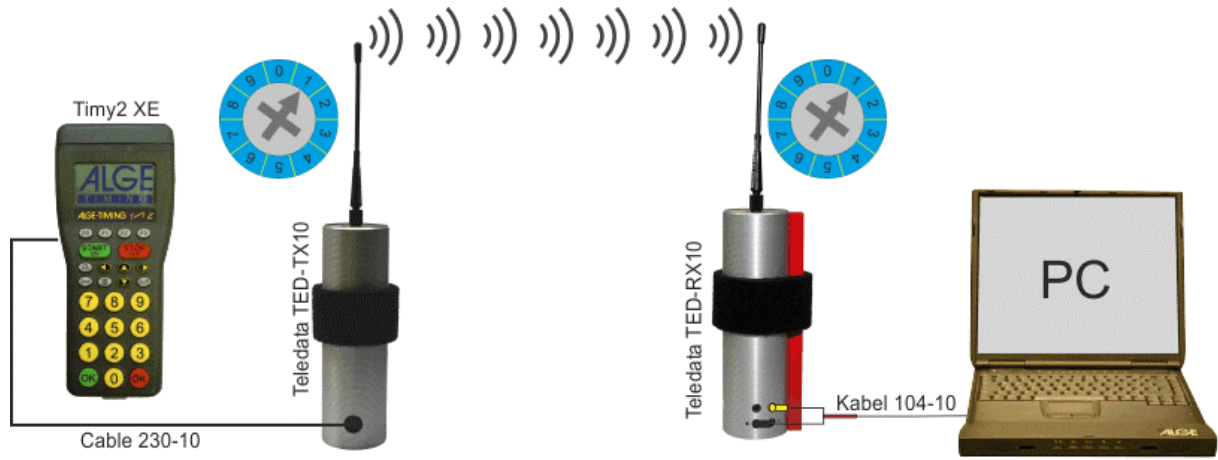

### 5.3 Data transmission direct

**Setting:** Code switch (12) of TED-TX and RX on position 6  
**Adapter 119—5 must be connected to TED-TX.**  
**One dataset must be transmitted so that the TED switches to direct mode** (LED switches from blinking to permanent glow).

Every dataset is transmitted with a baud rate of 2400 to 4800 baud. No control character is needed. The transmitter is always switched on, i. e. a power supply unit is recommended.

Data is not checked by receiver but passed on as received. The check should be executed at the software of the receiving device (PC).

**Advantage:** Every dataset is transmitted. No control characters are required. Any data protocol is transmitted.

**Disadvantage:** The transmitter TED-TX has a high power consumption as always operating. As the data is transmitted without protocol, the receiver cannot check the data

**Area of application:** Wireless data transmission with any data protocol from one device to another (PC)

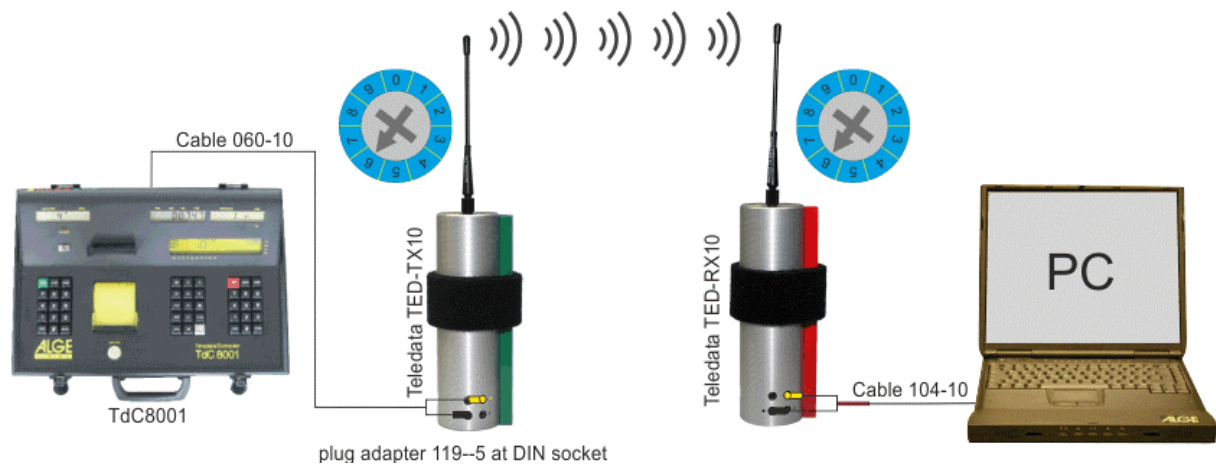

or

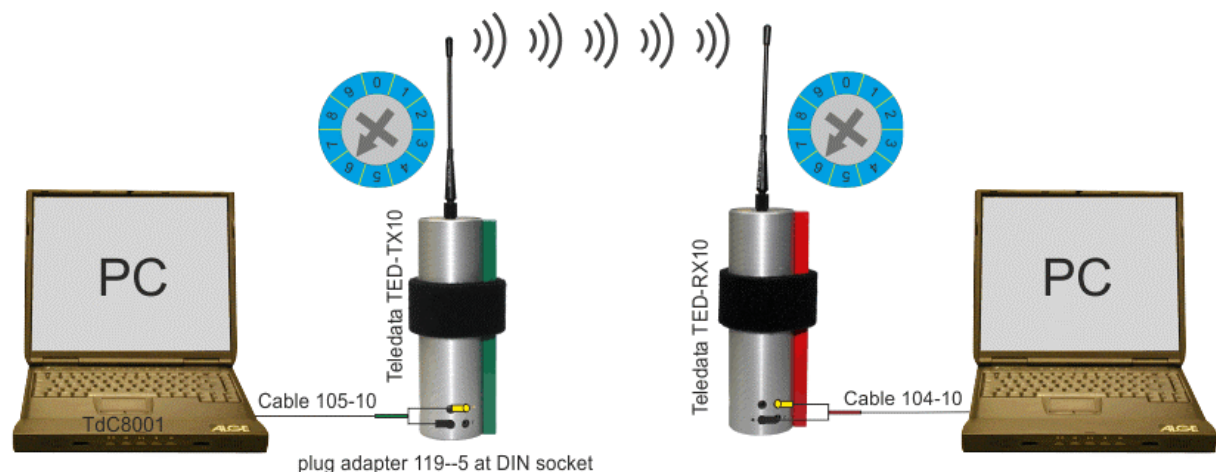



## 6 Technical data

<b>Operating frequency:</b>	Standard 10mW	433 MHz band, fix frequency set by producer
<b>Emitting power:</b>	TED-TX10:	10mW
<b>Operating range:</b>	TED-TX10:	approx. 1.5 km
<b>Antenna:</b>	fix screwed, 0dB	
<b>Signal input TED-TX:</b>	active low, min. 10 ms, bounce time ca. 50 ms	
<b>Signal output TED-RX:</b>	active low, 100 ms	
<b>Supply:</b>	external	TED-TX10 and TED-RX10: +6.5 to 28 VDC
	internal	6 x alkaline batteries 1.5 V type AA or 6 x NiCd rechargeable batteries 1.2 V type AA
<b>Power input:</b>	TED-TX10	Transmitting mode: approx. 35 mA Standby mode: approx. 3 mA
	TED-RX10	Standard mode: approx. 35 mA Test mode: approx. 70 mA
<b>Operating duration:</b>	see pages 9 and 9	

RS232 interface (for TED-TX10 and TED-RX10):

**Input/Output format:** 1 startbit, 8 AXCI bit, no parity bit, 1 stopbit  
**Transmission speed:** 2400 or 4800 baud

Connector pin assignment:

**TED-TX DIN socket:**

- 1 Impulse input (start)
- 2 Impulse input (stop)
- 3 GND
- 4 Input V-ext.
- 5 Output +5V stabilized  
Input +5V
- 6 Data input

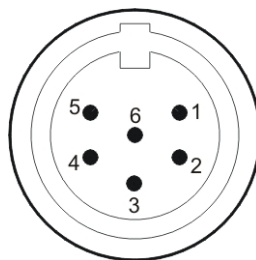

**TED-RX DIN socket:**

- 1 Impulse output (start)
- 2 Impulse output (stop)
- 3 GND
- 4 Input V-ext.
- 5 Input +5V
- 6 Data output

Banana socket:

with yellow marking data, identical to PIN 6 of DIN socket  
with green marking impulse, identical to PIN 1 of DIN socket  
with black marking GND, identical to PIN 3 of DIN socket

**Antenna:** at TED-TX10 and TED-RX10 1/4 antenna, approx. 165 mm

**Operating temperature:** -20 to +50°C

**Weight:** without batteries approx. 600 g  
with batteries approx. 750 g

Dimensions:

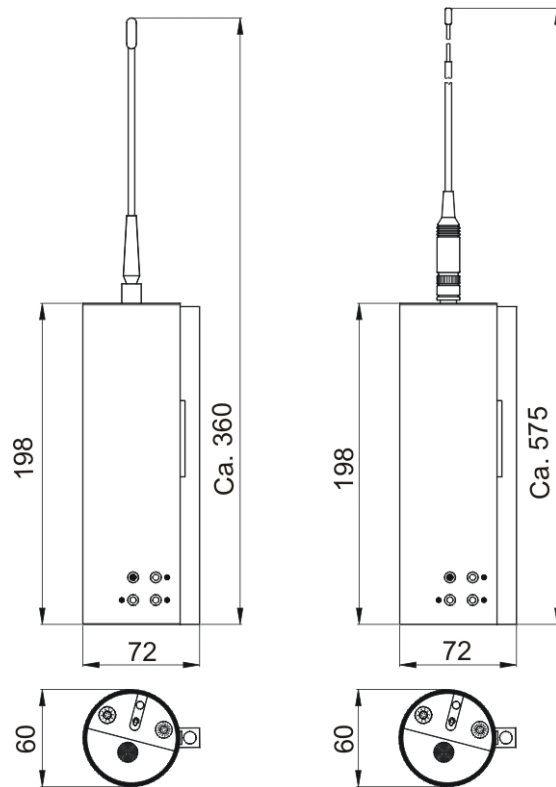



Subject to changes

Copyright by

**ALGE-TIMING** GmbH  
Rotkreuzstr. 39  
6890 Lustenau / Austria  
[www.alge-timing.com](http://www.alge-timing.com)