





# TruVision IP Cam Open- Standards User Manual

<b>Copyright</b>	© 2012 UTC Fire & Security. All rights reserved.
<b>Trademarks and patents</b>	Interlogix, TruVision names and logos are trademarks of UTC Fire & Security. Other trade names used in this document may be trademarks or registered trademarks of the manufacturers or vendors of the respective products.
<b>Manufacturer</b>	UTC Fire & Security Americas Corporation, Inc. 2955 Red Hill Avenue, Costa Mesa, CA 92626-5923, USA Authorized EU manufacturing representative: UTC Fire & Security B.V. Kelvinstraat 7, 6003 DH Weert, The Netherlands
<b>Certification</b>	  N4131
<b>FCC compliance</b>	Class A: This equipment has been tested and found to comply with the limits for a Class A digital device, pursuant to part 15 of the FCC Rules. These limits are designed to provide reasonable protection against harmful interference when the equipment is operated in a commercial environment. This equipment generates, uses, and can radiate radio frequency energy and, if not installed and used in accordance with the instruction manual, may cause harmful interference to radio communications. Operation of this equipment in a residential area is likely to cause harmful interference in which case the user will be required to correct the interference at his own expense.
<b>ACMA compliance</b>	<b>Notice!</b> This is a Class A product. In a domestic environment this product may cause radio interference in which case the user may be required to take adequate measures.
<b>Canada</b>	This Class A digital apparatus complies with Canadian ICES-003. Cet appareil numérique de la classe A est conforme à la norme NMB-0330 du Canada.
<b>European Union directives</b>	12004/108/EC (EMC directive): Hereby, UTC Fire & Security declares that this device is in compliance with the essential requirements and other relevant provisions of Directive 2004/108/EC.
	2002/96/EC (WEEE directive): Products marked with this symbol cannot be disposed of as unsorted municipal waste in the European Union. For proper recycling, return this product to your local supplier upon the purchase of equivalent new equipment, or dispose of it at designated collection points. For more information see: <a href="http://www.recyclethis.info">www.recyclethis.info</a> .
<b>Contact information</b>	For contact information, see <a href="http://www.interlogix.com">www.interlogix.com</a> or <a href="http://www.utcssecurityproducts.eu">www.utcssecurityproducts.eu</a> .
<b>Customer support</b>	<a href="http://www.interlogix.com/customer-support">www.interlogix.com/customer-support</a>

# Content

<b>Chapter 1</b>	<b>Introduction</b>	<b>1</b>
	Product overview	1
	Features	1
<b>Chapter 2</b>	<b>Installation</b>	<b>3</b>
	Installation environment	3
	Package contents	4
	Cable requirements	4
	Camera description	5
	Connections	6
	Accessing the SDHC card	7
	Setting up the camera	7
	Mounting the camera on a ceiling	8
	Using the camera with TVR 60/ TVN 20/ TVN 40/ LNVR and other systems	9
	Using the camera with TruVision Navigator	9
<b>Chapter 3</b>	<b>Network and streaming configuration</b>	<b>11</b>
	Checking your Web browser security level	11
	Accessing the camera over the internet	13
	Overview of the camera Web browser	14
	Configuring the camera's network settings	16
	Information about the camera	19
	Network parameters	19
	Serial port settings	21
<b>Chapter 4</b>	<b>Camera configuration</b>	<b>23</b>
	Camera parameters	23
	Defining how information is displayed on screen	24
	Defining the system time	25
	Alarm parameters	26
	Events scheduling	27
	Defining recording parameters	28
	Motion detection alarms	31
	Adding extra on-screen text	34
	Configuring the video image	34
<b>Chapter 5</b>	<b>Camera management</b>	<b>37</b>
	User management	37
	Formatting the SDHC card	39
	Restoring default settings	40
	Upgrading the firmware	40
	Rebooting the camera	41

<b>Chapter 6</b>	<b>Camera operation</b>	<b>43</b>
	Logging on and off	43
	Live mode	43
	Playing back recorded video	44
	Searching event logs	46
	Archiving recorded files	48
	Using presets	49
<b>Appendix A</b>	<b>Specifications</b>	<b>51</b>
<b>Appendix B</b>	<b>Pin definitions</b>	<b>53</b>
	<b>Index</b>	<b>55</b>

# Chapter 1

# Introduction

## Product overview

This is the user manual for TruVision IP Cam Open-Standards camera models:

- TVC-N220-1-N(-P) (VGA)
- TVC-N240-1-N(-P) (4CIF WDR)
- TVC-M1220-1-N(-P) (1.3 megapixel)
- TVC-M2220-1-N(-P) (2.0 megapixel)
- TVC-M3220-1-N(-P) (3.0 megapixel)
- TVC-M5220-1-N(-P) (5.0 megapixel)

## Features

This section describes the camera features.

- Supports TCP/IP, HTTP, DNS, RTP/RTCP and PPPoE protocols
- Programming and setup through a browser interface
- Live viewing over the network
- 50/60 Hz selectable flicker control
- Mono, bi-directional audio
- Digital pan/tilt/zoom (PTZ)
- Supports remote upgrades and maintenance
- H.264 video compression with dual capability
- Supports full HD, HD, 4CIF, 2CIF, CIF and QCIF
- SDHC card for local storage



•



# Chapter 2

## Installation

This chapter provides information on how to install the cameras.

### Installation environment

When installing your product, consider these factors:

- **Electrical:** Install electrical wiring carefully. It should be done by qualified service personnel. Always use a proper PoE switch or a 12 VDC UL listed Class 2 or CE certified power supply to power the camera. Do not overload the power cord or adapter.
- **Ventilation:** Ensure that the location planned for the installation of the camera is well ventilated.
- **Temperature:** Do not operate the camera beyond the specified temperature, humidity or power source ratings. The operating temperature of the camera is between -10 to +60°C (14°F to 140°F). Humidity is below 90%.
- **Moisture:** Do not expose the camera to rain or moisture, or try to operate it in wet areas. Turn the power off immediately if the camera is wet and ask a qualified service person for servicing. Moisture can damage the camera and also create the danger of electric shock.
- **Servicing:** Do not attempt to service this camera yourself. Any attempt to dismantle or remove the covers from this product will invalidate the warranty and may also result in serious injury. Refer all servicing to qualified service personnel.
- **Cleaning:** Do not touch the sensor modules with fingers. If cleaning is necessary, use a clean cloth with a some ethanol and wipe the camera gently. If the camera will not be used for an extended period of time, put on the lens cap to protect the sensors from dirt.

## Package contents

Check the package and contents for visible damage. If any components are damaged or missing, do not attempt to use the unit; contact the supplier immediately. If the unit is returned, it must be shipped back in its original packaging.

Package contents:

- Camera
- Hex wrench
- C-mount adapter
- Multilingual quick start guide
- CD with user manual in several languages

---

**CAUTION:** Use direct plug-in UL listed power supplies marked Class 2/CE certified or LPS (limited power source) of the required output rating as listed on the unit.

---

## Cable requirements

For proper operation, adhere to the following cable and power requirements for the cameras. Category 5 cabling or better is recommended. All network cabling must be installed according to applicable codes and regulations.

Table 1 below lists the requirements for the cables that connect to the camera.

**Table 1: Recommended cable requirements**

Cable type	Requirements
Data	For RS-485: 22 gauge (0.64 mm) shielded, two-conductor, twisted-pair (STP) cable
Video	75 ohm RS-59 coaxial cable with BNC ends
Power	12 VDC cable



# Camera description

**Figure 1: Camera dimensions**

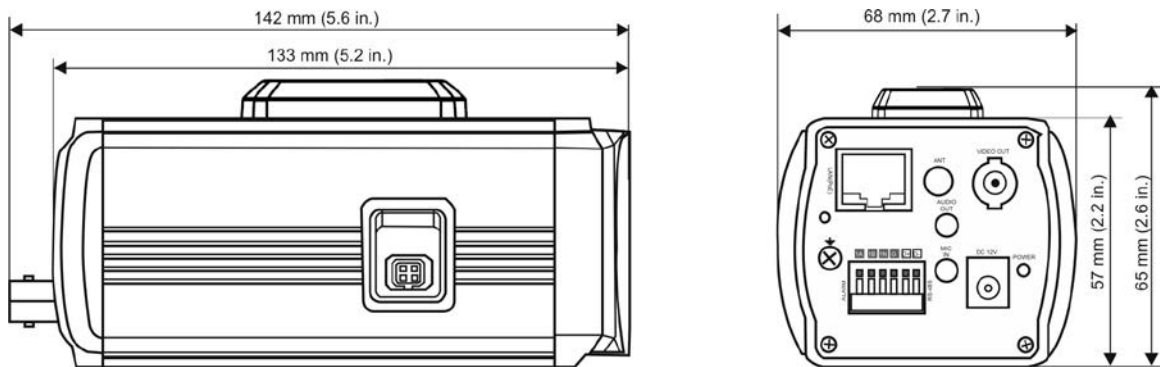

**Figure 2: Side elevation of the camera**

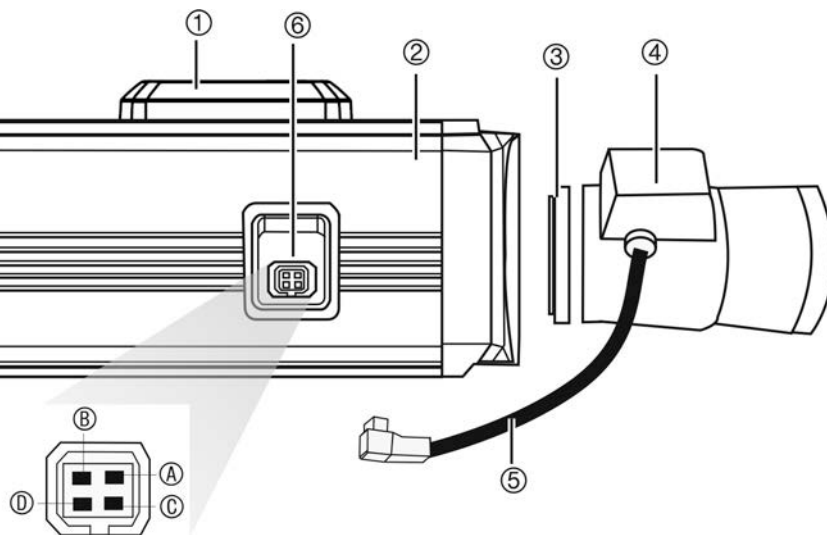

1. Bracket mounting holes.  
Can be repositioned to the other side of the camera.
2. Camera.
3. C-mount adaptor (for C-mount lenses only).
4. Lens (auto iris lens shown. A manual iris has no cable.)Not included.
5. Auto iris lens cable. Not included.

6. Auto iris lens connector.

Video-type auto iris lens connection:  
A. Power; B. NC (no connection); C. GND;  
D. Video

DC-type auto iris lens connection:  
A. Damping coil (-); B. Damping coil (+);  
C. Driving coil (+); D. Driving coil (-)

# Connections

A qualified service person, complying with all applicable codes, should perform all required hardware installation.

**Note:** Do not attempt to extend the power/data cable connection using RJ45 couplers and Cat5 cable. Only use the data cable connection provided.

**Note:** Use 12 VDC or PoE.

**Figure 3: Wiring the camera**

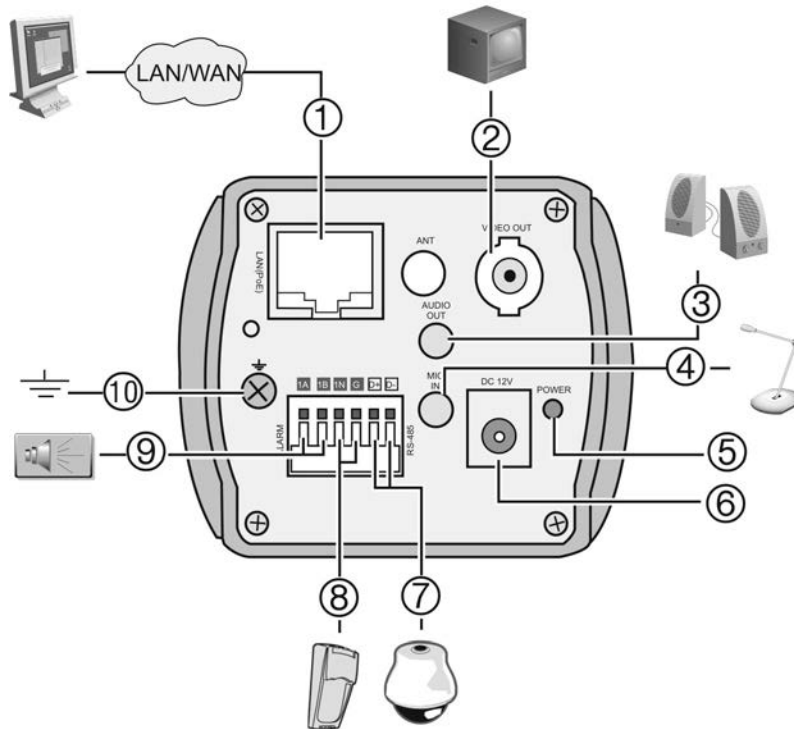

1. Ethernet RJ45 PoE port  
Connect to network devices.
2. Video output  
Connect to a CCTV monitor.
3. Audio output  
Connect to an audio output.  
Line level, 600  $\Omega$ .
4. Audio input  
Connect to an audio input.  
2.0 to 2.4 Vp-p, 1 k $\Omega$ .
5. Power LED  
Illuminated when power is connected.
6. Power supply  
Connect +12 VDC power supply.
7. RS-485 D+, D-  
Connect to an RS-485 device such as a PTZ dome camera.
8. Alarm outputs  
Connect 1A/1B and 2A/2B to alarm output devices.
9. Alarm inputs  
Connect IN1/GND and IN2/GND to alarm input devices.
10. Ground  
Connect to ground.

**Note:** The alarm output can be used to turn on and off an external alarm device. Connect a 12 VDC/30 mA external power supply to the alarm output. See Figure 4 below.

Figure 4: External alarm output

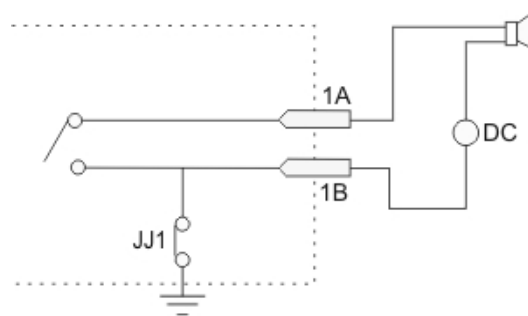

## Accessing the SDHC card

Insert an SDHC card up to 32GB for local storage as a backup in case the network fails, for example (see Figure 5 below). The card is not supplied with the camera.

Video and log files stored on the SDHC card can only be accessed via the Web browser. You cannot access the card using TruVision Navigator, TVR 60 or TVR 20.

Figure 5: SDHC card slot location in the cameras

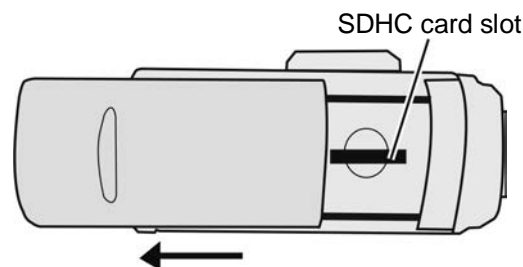

## Setting up the camera

**Note:** If the light source where the camera is installed experiences rapid, wide-variations in lighting, the camera may not operate as intended.

### To quickly put the camera into operation:

1. Connect the lens to the camera.
2. Prepare the mounting surface.
3. Mount the camera to the ceiling using the appropriate fasteners. See "Mounting the camera on a ceiling" on page 8.

4. Connect the cables to the camera. See “Connections” on page 6.
5. Set up the camera’s network and streaming parameters so that the camera can be controlled over the network. See Chapter 3 Network and streaming configuration” on page 11.
6. Program the camera to suit its location. See “Chapter 4 Camera configuration” on page 23.

## Mounting the camera on a ceiling

Mount the camera on a ceiling. It is not recommended for mounting on a wall.

When installing the camera, please use the optional mounting bracket, which is sold separately.

### To mount the camera on a ceiling:

1. Using the mounting bracket as a template, place it level against the mounting surface and mark the position of the mounting holes.
2. Following all local codes, drill and prepare the mounting holes.
3. Securely fasten the mount to the mounting surface with the appropriate fasteners.

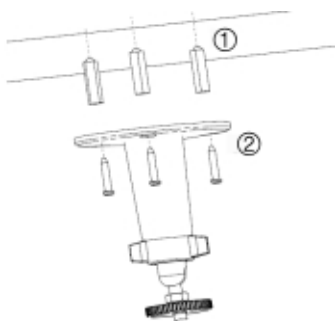

4. If needed, seal all mounting holes so that no moisture can leak into the mounting surface.
5. Screw the camera into the mounting bracket. Ensure that the camera is firmly attached to the bracket.



6. Connect a 75 ohm coaxial video cable to the video cable, and connect a 12 VDC power supply to the power cable or use a PoE switch.
7. Adjust the camera position and angle as required.

8. Connect a lens to the camera. For optimal performance, use an autoiris lens.



## Using the camera with TVR 60/ TVN 20/ TVN 40/ LNVR and other systems

Please refer to the head-end user manuals for instructions on connecting and operating the camera with these systems.

## Using the camera with TruVision Navigator

A camera must be connected to a TVR 60/ TVN 20/ TVN 40 in order to be operated by TruVision Navigator. Please refer to the TruVision Navigator user manual for instructions on operating the camera with the TruVision Navigator.



# Chapter 3

## Network and streaming configuration

This chapter explains how to configure the camera network settings.

The cameras can be configured and controlled using an internet browser such as Microsoft Internet Explorer (IE). The procedures described use Microsoft Internet Explorer (IE) web browser. The steps are similar with other browsers.

You must have administrator rights on your PC in order to configure the cameras over the internet.

### Checking your Web browser security level

When using the Web browser interface, you can install ActiveX controls to connect and view video using Internet Explorer. However, you cannot download data, such as video and images due to the increased security measure. Consequently you should check the security level of your PC so that you are able to interact with the cameras over the Web and, if necessary, modify the Active X settings.

### Configuring IE ActiveX controls

You should confirm the ActiveX settings of your Web browser.

#### To change the Web browser's security level:

1. In Internet Explorer click **Internet Options** on the **Tools** menu.
2. On the Security tab, click the zone to which you want to assign a Web site under "Select a Web content zone to specify its security settings".
3. Click **Custom Level**.

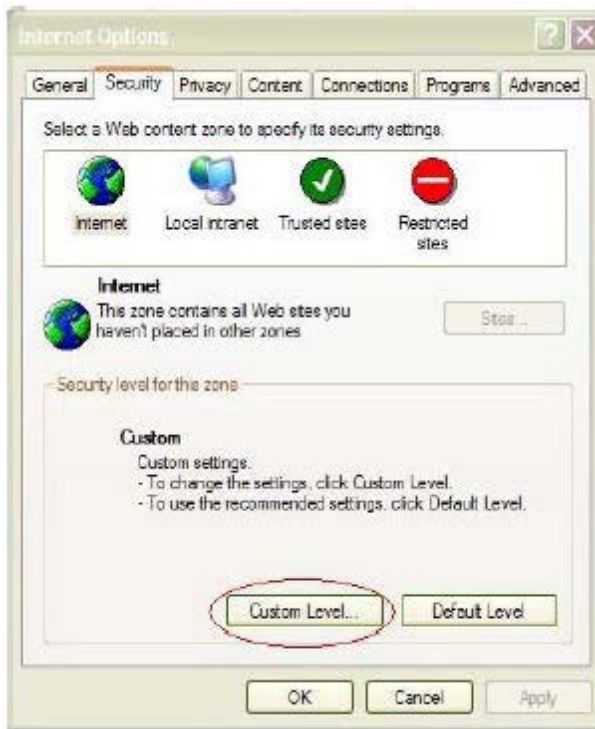

4. Change the ActiveX controls and plug-ins options to **Enable** and click **OK**.

- or -

Under **Reset Custom Settings**, click the security level for the whole zone in the **Reset To** box, and select **Low**. Click **Reset**. Then click **OK** to the Internet Options Security tab screen.



5. Click **Apply** in the Internet Options Security tab screen.



## Windows Vista and 7 users

Internet Explorer for Windows Vista and Windows 7 operating systems have increased security measures to protect your PC from any malicious software being installed.

To have complete functionality of the Web browser interface with Windows Vista and Windows 7, do the following:

- Run the Browser interface and the DVR player application as an administrator in your workstation
- Add the camera's IP address to your browser's list of trusted sites

### To add the camera's IP address to Internet Explorer's list of trusted sites:

1. Open Internet Explorer.
2. Click **Tools**, and then **Internet Options**.
3. Click the **Security** tab, and then select the Trusted sites icon.
4. Click the **Sites** button.
5. Clear the "Require server verification (https:) for all sites in this zone box.
6. Enter the IP address in the "Add this website to the zone" field.
7. Click **Add**, and then click **Close**.
8. Click **OK** in the Internet Options dialog screen.
9. Connect to the camera for full browser functionality.

## Accessing the camera over the internet

Use the Web browser to access and configure the camera over the internet.

It is recommended that you change the administrator password once the set up is complete. Only authorized users should be able to modify camera settings. See "User management" on page 37 for further information.

### To access the camera online:

1. In the Web browser enter the camera's IP address (default is 192.168.1.70). Use the tool, *IP Finder*, enclosed on the CD to find the IP address of the camera.

The Login dialog box appears.

**Note:** Ensure that the Active X controls are enabled.

2. Enter your user name and password.

User name: admin

Password: 1234

Click **OK**. The Web browser screen appears in live mode.

**Note:** You can stop and start live view by clicking the Start/stop live view button  on the bottom of the screen.



## Overview of the camera Web browser

The camera Web browser lets you view, record, and play back recorded videos as well as manage the camera from any PC with Internet access. The browser's easy-to-use controls give you quick access to all camera functions. See Figure 6 on page 15.



Only one camera is accessible from a single Web browser window. If there is more than one camera connected over the network, open a separate Web browser window for each individual camera.

**Note:** Any changes made to the camera's configuration only apply to this camera. The configuration of other devices that may be connected to the camera, such as cameras or DVRs, is not changed.

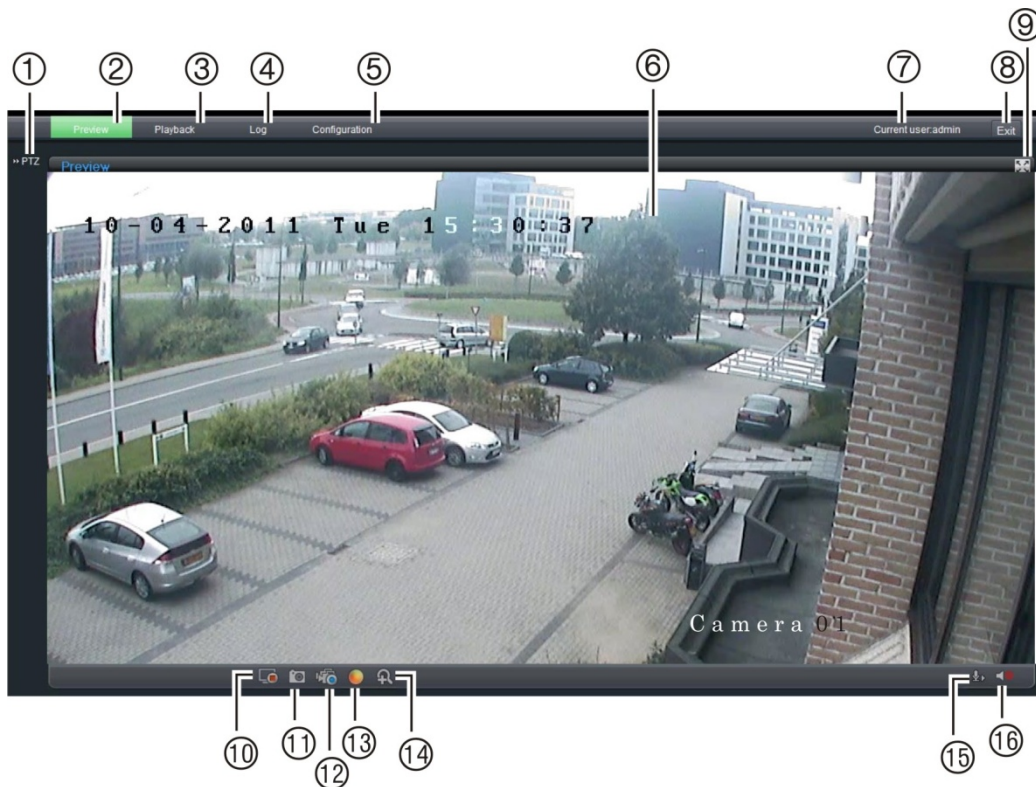
Figure 6: Web browser interface

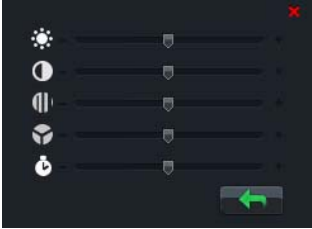

Item	Name	Description
1.	PTZ controls	For future use.
2.	Live view	Click to view live video.
3.	Playback	Click to play back video.
4.	Log	Click to search for event logs. There are four main information types: All, Alarm, Notification and Operation  <b>Note:</b> The Playback and Log functions can only be used when an SDHC card is inserted in the camera.
5.	Configuration	Click to display the configuration screen for setting up the camera. See Figure 7 on page 17.
6.	Viewer	Click to view live or playback video. Time, date and camera name are displayed here.
7.	Current user	Displays current user logged on.
8.	Exit	Click to log out from the system. This can be done at anytime.
9.	Full screen	Click to view as full screen. The top toolbar is not visible in full-screen mode.
10.	Start/stop live view	Click to start/stop live view.
11.	Capture	Click to take a snapshot of the video. The snapshot will be saved to the default folder in JPEG format. See "Local configuration" on page 17 for more information.
12.	Start/stop recording	Click to record live video.

Item	Name	Description
13.	Video image settings	<p>Click the required icon in the pop-up window and then slide the bar to adjust video image settings such as brightness, contrast, saturation, hue and exposure time (exposure time is equivalent to shutter speed). Changes appear immediately and are also applied to the settings in the menu “Camera image settings” (see page 34).</p>  <p>Click  to return to default settings.</p>
14.	e-PTZ	<p>Click to enable/disable e-PTZ.</p> <p>When enabled, scroll on the mouse wheel to zoom in and out of an image on-screen.</p>
15.	Audio setting	<p>Click to start/stop bi-directional audio.</p> <p><b>Note:</b> You need to have a microphone attached to your PC to be able to send out audio.</p>
16.	Audio on/off	Click to turn the audio function on or off.

## Configuring the camera’s network settings

Once the camera hardware has been installed, configure the camera’s network settings through the Web browser.

The camera Web browser lets you configure the camera remotely using your PC. The camera is configured using on-screen display (OSD) menus. In the Web browser screen click the **Configuration** button on the toolbar to display the configuration screen. The Local configuration screen appears. See Figure 7 on page 17.

The camera is shipped with on-screen display (OSD) menus in English only.

Figure 7: Example of a configuration screen (Local configuration shown)



There are two main folders in the configuration panel:

- Local configuration
- Remote configuration

## Local configuration

Use the Local menu to manage the network type, display mode and local storage paths. In the Configuration panel, click “Local configuration” to display the Local settings screen. See Figure 7 and Table 2 for descriptions of the different menu parameters.

Table 2: Overview of the Local configuration screen

Parameters	Description
Protocol type	Specifies the network protocol used. Options include: TCP and UDP.
Stream type	Specifies the streaming method used. Options include: Main stream and sub stream. Main is default.
Display mode	Specifies the width/height ratio of the image. Options include: Full screen, 4:3, 16:9 or adjustable.
Package file size	Specifies the maximum file size. Options include: 128 MB, 256 MB and 512 MB
Transmission performance	Specifies the transmission speed. Options include: Shortest delay mode, good real time, normal real time and fluency, and good fluency.
Save record file as	Specifies the directory for recorded files. The default directory is C:\Program Data\Web\RecordFiles.

Parameters	Description
Save captured picture as	Specifies the directory for saving snapshot files. The default directory is C:\Program Data\Web\BMPCaptureFiles.
Save playback captured picture as	Specifies the directory for saving playback files. The default directory is C:\Program Data\Web\PlaybackFiles.
Save download file as	Specifies the directory for downloaded files. The default directory is C:\Program Data\Web\DownloadFiles.

## Remote configuration

Use the “Remote configuration” panel to remotely configure the server, network, cameras, alarms, users, transactions and other parameters such as upgrading the firmware. See Figure 8 and Table 3 for descriptions of the configuration folders available.

**Figure 8: Remote configuration panel (Basic information menu selected)**



**Table 3: Overview of the Remote configuration panel**

Configuration folders	Description
Basic information	Defines the camera name and RS-485 bus ID. This screen also displays the MAC address, device type, device SN and the current firmware version. See “Information about the camera” on page 19.
Channel parameters	Defines the OSD properties of camera information, recording parameters and schedules, motion detection parameters, image quality, alarm responses, and overlay text. See “Chapter 4 Camera configuration” on page 23.
Network parameters	Defines the network parameters required to access the camera over the internet. See “Network parameters” on page 19.
Serial settings	Defines the RS-485 and RS-232 communication settings. See “Serial port settings” on page 21.

Configuration folders	Description
Alarm parameters	Defines how the camera handles alarms such as input type, notification of alarms, and response schedules and duration. See “Alarm parameters” on page 26.
Deployment time	Defines the schedules during which events are registered. See “Events scheduling” on page 27.
User management	Defines who can use the camera, their passwords and access privileges. See “User management” on page 37.
HDD management	Defines how to format the SDHC card used in the camera. See “Formatting the SDHC card” on page 40”.
Remote upgrade	Defines how to upgrade the camera’s firmware. See “Upgrading the firmware” on page 40.
Default	Restores default settings. See “Restoring default settings” on page 40.
Reboot device	Reboots the camera. See “Rebooting the camera” on page 41.

## Information about the camera

Use the “Basic information” menu to define the camera name and RS-485 bus ID. The default device name is “IP Camera” and device ID is 88. The camera can have up to 12 alphanumeric characters in its name.

Several parameters are also prepopulated and cannot be changed manually such as the camera, encoder, panel and hardware versions.

## Network parameters

Accessing the camera through a network requires that you define certain network settings. Use the “Network Parameters” folder to define the network settings. See Figure 9 on page 20 for further information.

**Note:** When a network parameter is modified, the camera will prompt you to save and reboot.

Figure 9: Network subfolder screen (to be updated - no NFS)

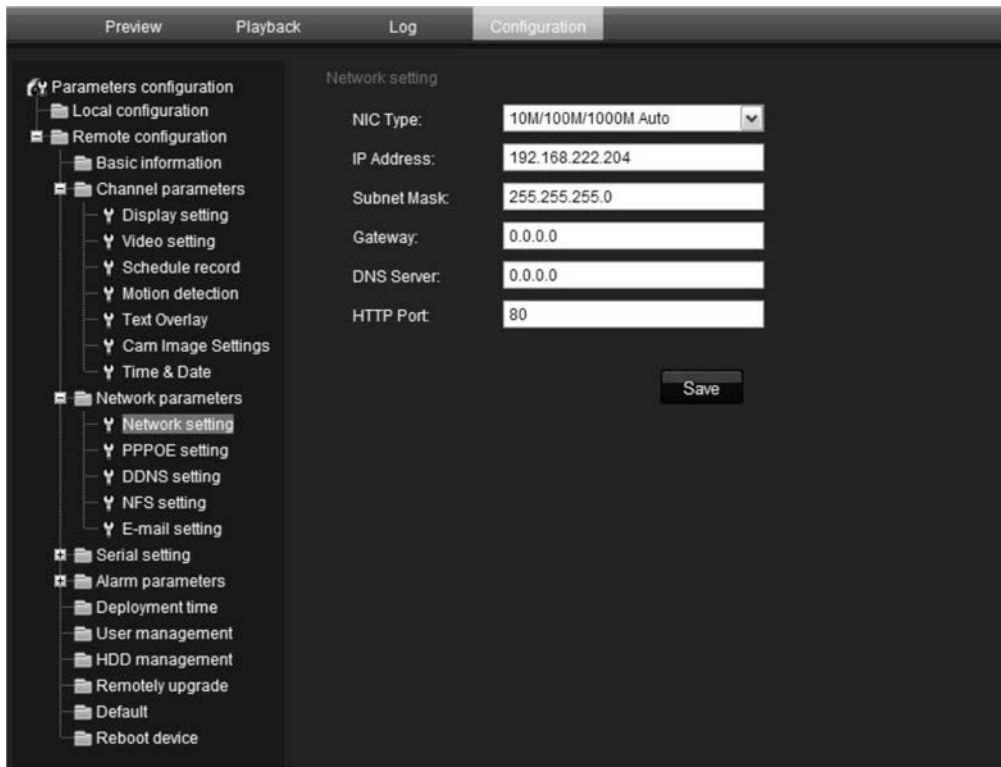

Table 4: Network parameters

Parameters	Description
Network	<p><b>NIC type:</b> Specifies the NIC type. Default is 10M/100M Auto. Other options include: 10M half-dup, 10M full-dup, 100M half-dup and 100M full-dup and 10M/100M auto. Default is 10M/100M.</p> <p><b>IP address:</b> Specifies the IP address of the camera.</p> <p><b>Subnet mask:</b> Specifies the subnet mask. Default value is 255.255.255.0.</p> <p><b>Gateway:</b> Specifies the gateway IP address. Default value is 0.0.0.0.</p> <p><b>DNS server:</b> Specifies the DNS server for your network. Default value is 0.0.0.0.</p> <p><b>HTTP port:</b> Specifies the port used for the Internet Explorer (IE) browser. Default value is 80.</p>
PPPoE	Use this option to retrieve a dynamic IP address.
DDNS	Specifies either DynDNS or IP server.
NFS	For future use.
E-mail	Specifies the e-mail address to which messages are sent when an alarm occurs. It is not possible to send an attachment with the e-mail.



### To define the network parameters:

1. In the “Network Parameters” folder click the **Network setting** subfolder to open its screen.

From the NIC Type drop-down list, select the required value. Enter the values for the IP address, subnet mask, gateway, DNS server and HTTP port. Click **Save** to save changes.

2. Click the **PPPoE setting** subfolder to open its screen and check **Enable PPPoE**. Enter the user name and password. Click **Save** to save changes.
3. Click the **DDNS setting** subfolder to open its screen and check **Enable DDNS**. Enter either IP server or DynDNS as protocol.

If DynDNS is selected, enter the user name and password registered to the DynDNS web site. The domain name is that of the DynDNS web site. Click **Save** to save changes and return to the “Network settings” menu.

4. Click the **E-mail setting** subfolder to open its screen and enter the SMTP server, SMTP port, user name and password and the e-mail sender and receiver addresses. Click **Save** to save changes.

## Serial port settings

Use the “Serial setting” folder to define the RS-232 and RS-485 communication settings.

If a PTZ camera is connected to this camera, the RS-485 settings must be the same as the PTZ protocol used.

Figure 10: RS-485 setting menu

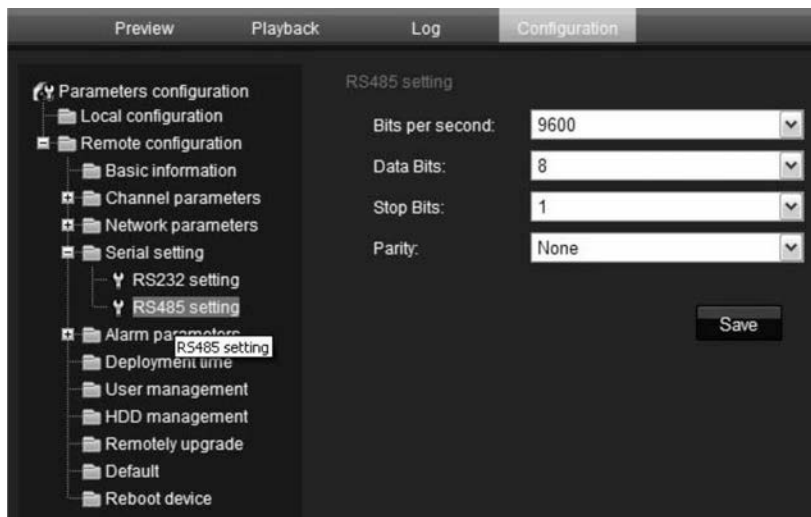

**Note:** When a parameter is modified in either of these menus, the camera will prompt you to save and reboot.

Table 5: RS-232 and RS-485 settings

Item	Description
Bits per second	Default baud rate value for the RS-232 port is 9600. Default baud rate value for the RS-485 port is 9600.
Data bits	Default value is 8.
Stop bits	Default value is 1.
Parity	Default value is "None".

# Chapter 4

## Camera configuration

This chapter explains how to configure the camera through a Web browser.

You must have administrator rights on your PC in order to configure the camera over the internet.

### Camera parameters

This section describes how to configure the camera settings from the Channel Parameters screen. There are eight subfolders, which are described below:

- **Display settings:** Defines how the date and time are displayed on screen. By default the name appears in the lower right corner of the screen and the date/time on the top. See “Defining how information is displayed on screen” on page 24 for information on defining the camera name.
- **Video settings:** Defines how the camera records an event. The stream mode, stream type, resolution, image quality, bit rate, frame rate, and video compression can all be modified. See “Defining the system time” on page 25 for more information.
- **Schedule record:** Defines the recording schedule of the camera. See “Defining a recording schedule” on page 29.
- **Motion detection:** Defines the on-screen area to trigger a response and the method of response. See “Motion detection alarm” on page 31.
- **Text overlay:** Defines up to four lines of extra text on-screen. They can be positioned anywhere. See “Adding extra on-screen text” on page 34.
- **Camera image settings:** Defines image quality parameters as well as camera behavior such as shutter speed, iris mode, day/night mode, IR mode, image flip, power mode and white balance.
- **Time & date:** Defines the synchronization of the time and date with the NTP server.

All changes made apply only to the camera being configured. Parameters cannot be copied to another camera.

**Note:** When schedule parameters are modified, the camera will prompt you to reboot after the changes are saved.

Figure 11: Channel parameters folder (Display setting menu shown)

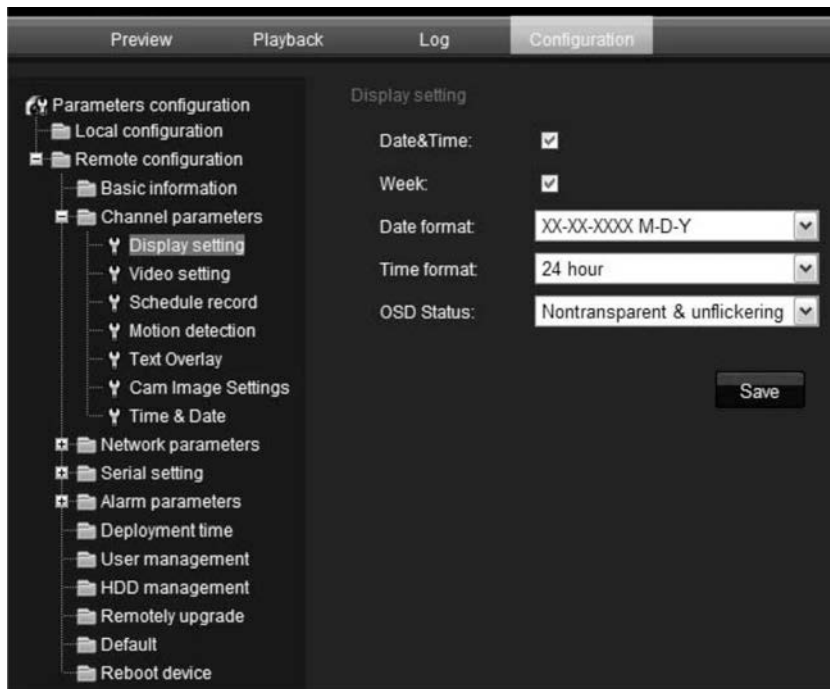

## Defining how information is displayed on screen

In addition to the camera name, the camera also displays the system date and time on screen. You can also define how the text appears on screen.

### To position the date/time on screen:

1. In the Channel Parameters folder click the **Display Setting** subfolder to open its screen.
2. Check the **Date&Time** box to display the date/time on screen.
3. Check the **Week** box to include the day of the week in the on-screen display.
4. Select the date format from the **Date format** list box. Formats include:
  - YYYY-MM-DD
  - MM-DD-YYYY (Default)
  - DD-MM-YYYY

5. Select the time format from the **Time format** list box. Formats include: 24-hour and 12-hour.
6. Select a display mode for the camera from the **OSD Status** list box. Display modes include:
  - **Transparent & Non-Flashing.** The screen image appears through the text. This is default.
  - **Transparent & Flashing.** The screen image appears through the text. The text flashes on and off.
  - **Non-Transparent & Unflickering.** The screen image is behind the text.
  - **Non-Transparent & Flashing.** The screen image is behind the text. The text flashes on and off.
7. Click **Save** to save changes.

## Defining the system time

NTP (Network Time Protocol) is a protocol for synchronizing the clocks of network devices, such as IP cameras and computers. Connecting network devices to a dedicated NTP time server ensures that they are all synchronized.

### To define the system time and date:

1. In the “Channel Parameters” folder click the **Time & Date** subfolder to open its screen.

2. Check one of the options for setting the time and date:
  - Synchronize with an NTP server: Check the enable box and enter the server NTP address.
  - Or -
  - Set manually: Enter the current date and time values.
3. Select your time zone.
4. Click **Save** to save changes.

# Alarm parameters

Use this menu to select how external alarm inputs and alarm outputs should be handled.

Figure 12: Alarm input screen

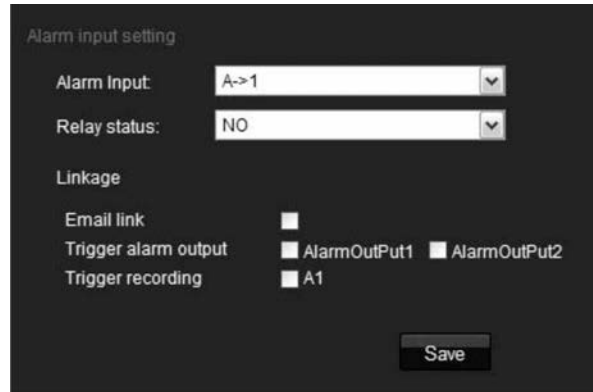

### To set up an external alarm input:

1. In the “Alarm Parameters” folder click the **Alarm Input** subfolder to open its screen.
2. Select one of the two external alarm inputs from the **Alarm input** drop-down list, A1 or A2.
3. Select the input type in the **Relay status** box.

Alarm input type refers to the sensor type. You can select Normal Open (NO) or Normal Close (NC). NO is default.

**Note:** In order for a camera to record an alarm, the recording schedule and alarm type must be enabled. See “Defining a recording schedule” on page 29 for further information.

4. Select how you want to be notified of an external alarm.

Check one or more of the following response methods:

<b>Email link</b>	Sends an e-mail to a specified address when there is a motion detection alarm. No attachment can be sent with the e-mail.  See “Network parameters” on page 19 for information on setting up the e-mail link.
<b>Trigger alarm output</b>	Triggers the camera’s alarm output. Up to two alarm outputs can be selected.
<b>Trigger recording</b>	Triggers the recording to start in the camera. <b>Note:</b> Only available for cameras with an SDHC card..

5. Click **Save** to save changes.

**Note:** The camera will prompt you to reboot in order for the schedule changes to take effect.

### To set up an alarm relay output:

1. In the “Alarm Parameters” folder open the **Alarm Output** screen.



2. Select one of the alarm outputs from the **Alarm output** drop-down list, A1 or A2.
3. Select the alarm output delay time.

The alarm output delay is the length of time during which the relay is operational after the alarm occurs. Select a **Delay** option: 5, 10, and 30 seconds, 1, 2, 5, and 10 minutes, and Manual stop. If “Manual stop” is selected the alarm output will stop only when the alarm input stops.

4. Click **Save** to save changes.

**Note:** The camera will prompt you to reboot in order for the schedule changes to take effect.

## Events scheduling

Use the deployment time menu to schedule when events can be registered. It specifies when the alarm inputs and outputs as well as motion detection are operational. Outside of these scheduled periods the system cannot register any events. You can configure up to four event periods a day.

For the event schedule to be operational, you must also define the motion detection parameters (see page 31) as well as the alarm input and output parameters (see page 26.) The recording schedule for motion detection must fall within the time period of the event schedule.

**Figure 13: Deployment time menu**

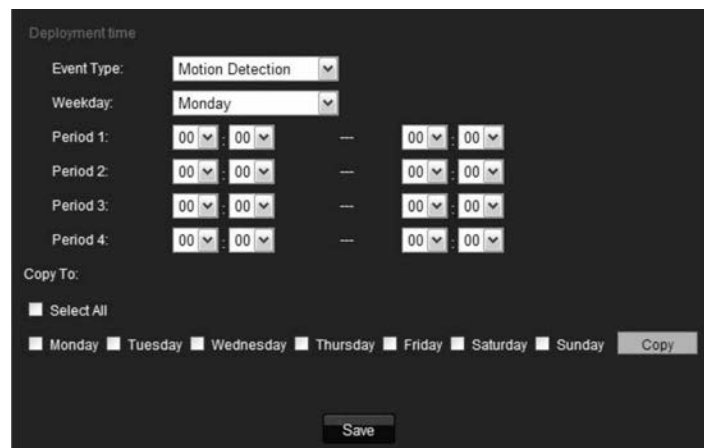

**To define an event schedule:**

1. Click the “Deployment” folder to open its screen.
2. Under “Event type” select the option to be scheduled from the dropdown list. There are five options: Motion detection, input port 1, input port 2, output port 2 and output port 2.
3. Select the day of the week and the time period for the event schedule. The time periods must not overlap.
4. Select another day of the week to set up its event schedule.

- Or -

Copy the event schedule to other days of the week by checking the days required and click **Copy**.

5. Click **Save** to save changes.

## Defining recording parameters

You can adjust the video recording parameters to obtain the picture quality and file size best suited to your needs. Figure 14 below lists the recording options you can configure for the camera.

**Figure 14: Video setting menu**

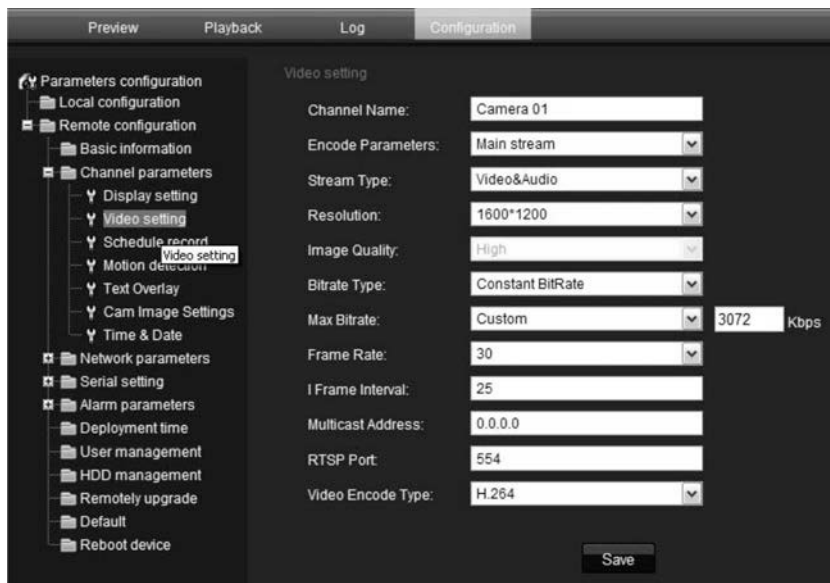

Parameter	Description
Channel name	Name of the camera
Encoding parameters	Specifies the dual streaming method used. Options include: Main stream and sub stream. Default is Main.



Parameter	Description
Stream type	Specifies the stream type you wish to record. Select Video to record video stream only. Select Video&Audio to record both video and audio streams. Default value is Video&Audio.
Resolution	Specifies the recording resolution. A higher image resolution provides a higher image quality but also requires a higher bit rate. The resolution options listed depend on the type of camera and on whether main or sub stream is being used. If you make changes to this option, you must reboot the camera to implement the changes. The options are: Main stream: 352*240, 352 *288, 640*480, 704*480, 704*576, 800*600, 1280*720, 1280*960, 1600*1200, 1600*912, 1920 *1080, 2048*1536 and 2560*1920 Sub stream: 176*144, 320*240 and 352*240 <b>Note:</b> Resolutions can vary depending on the camera model.
Image quality	Specifies the quality level of the image. Value is prepopulated High. It cannot be changed.
Bit rate type	Specifies whether variable or fixed bit rate is used. Variable produces higher quality results suitable for video downloads and streaming. Default is Variable.
Max bit rate	Specifies the maximum allowed bit rate. A high image resolution requires that a high bit rate must also be selected. Options include: 32 bps, 48, 64, 80, 96, 128, 160, 192, 224, 256, 320, 384, 448, 512, 640, 768, 896, 1024, 1536, 1792, 2048, Custom (enter a value manually) Default is 2048.
Frame rate	Specifies the frame rate for the selected resolution. The frame rate is the number of video frames that are shown or sent per second. Default value is 25 (PAL)/ 30 (NTSC).
I frame interval	A video compression method. It is strongly recommended not to change the default value displayed: 25.
Multicast address	Specifies a D-class IP address between 224.0.0.0 to 239.255.255.255. You do not need to specify this option if you are not using the multicast function. Some routers prohibit the use of multicast function in case of a network storm. The default value is 0.0.0.0.
RTSP port	Specifies the RSTP port. The default value is 554.
Video encoder type	Specifies the video encoder used. Options include: H2.64 and MPEG4

## Defining a recording schedule

You can define a recording schedule for the camera in the “Schedule record” screen. The recording is saved on to the SDHC card in the camera. Although all recordings are saved on a DVR, the camera’s SDHC card provides a backup in case of network failure, for example.

The selected recording schedule applies to all alarm types.

You will be prompted to reboot the camera after making any schedule modifications.

### Post-event recording times

The post-event record time is used if you have the motion detection and/or external alarms enabled. When an external or motion alarm is cleared, the camera will continue recording based on the value specified in this option. Options include: 5 (default), 10, 30 seconds, 1, 2, 5, and 10 minutes.

#### To define a recording schedule:

1. In the “Channel parameters” folder click the **Schedule record** subfolder to open its screen.
2. Click the **Enable Recording** box to enable recording.  
**Note:** To disable recording, deselect the option.
3. Select the post record time from the drop-down list.
4. Select whether the recording will be for the whole week (All day recording) or for specific days of the week (Section recording).



5. If you selected “All day recording”, select one of the record types to record from the drop-down list box:
  - Schedule recording. This is continuous recording.
  - Motion detection
  - Alarm record
  - Motion or alarm
  - Motion and alarm

- Or -

If you selected “Section recording”, in the left column click the day of the week required and then set the start and end times for each section (time period) during which you want the camera to begin and end recording. Up to four time periods can be selected.

From the drop-down list box select one of the record types to record for each time period.

**Note:** The four time periods cannot overlap.

6. Set the recording periods for the other days of the week, if required.

Use the **Copy to** option to copy the recording periods to another day of the week.

7. Click **Save** to save changes.

#### Notes

- The camera will prompt you to reboot in order for the schedule to take effect.
- If you set the record type to “Motion detection” or other related alarm types, you must also define the motion detection alarm in order to trigger motion recording. See “Motion detection alarms” below for more information.

## Motion detection alarms

You can define motion detection alarms. A motion detection alarm refers to an alarm triggered when the camera detects motion. However, the motion alarm is only triggered if it occurs during a programmed time schedule.

Select the level of sensitivity to motion as well as the target size so that only objects that could be of interest can trigger a motion recording. For example, the motion recording is triggered by the movement of a person but not that of a cat.

You can define the area on screen where the motion is detected, the level of sensitivity to motion, the schedule when the camera is sensitive to detecting motion as well as which methods are used to alert you to a motion detection alarm.

Use the “Motion detection” screen in the “Channel parameters” folder to change the motion detection settings.

The recording schedule of the motion detection must fall within the time period of the event schedule in order to operate correctly. See “Events scheduling” on page 26 for more information.

Figure 15: Motion detection menu

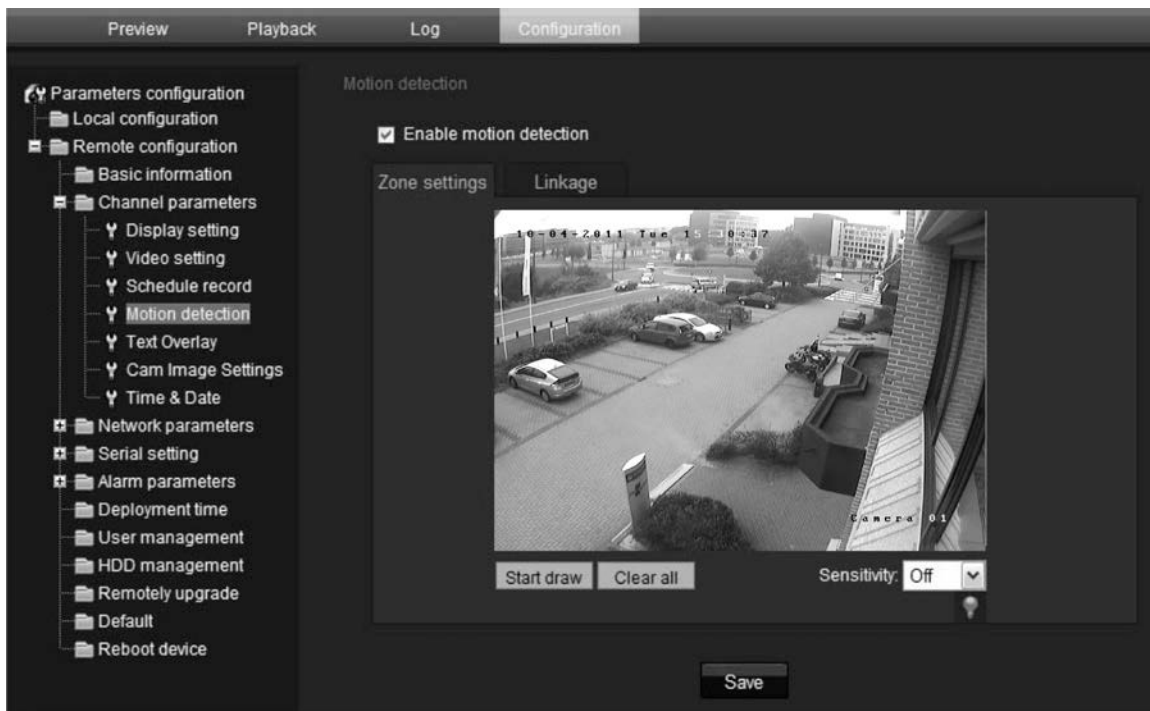

### Defining a motion detection alarm requires the following tasks:

1. **Events schedule:** Define the schedule during which the system inputs and outputs are operational to detect alarms. See “Events scheduling” on page 26.
2. **Recording schedule:** Define the schedule during which motion detection can be recorded. See “Defining a recording schedule” (see page 29).
3. **Settings areas:** Define the on-screen area that can trigger a motion detection alarm and the detection sensitivity level. See below.
4. **Linkage:** Specify the method of response to the alarm. See below.

### To define the motion detection areas and response method:

**Note:** The deployment and motion detection recording schedules must also be defined for motion to be detected and recorded. See “Events scheduling” on page 26 and “Defining a recording schedule” on page 29.

1. In the Channel Parameters folder click the **Motion detection** subfolder to open its screen.
2. Check the **Enable Motion Detection** box.

**Note:** Deselect the “Enable Motion Detection” option to disable the motion detection alarm.

3. Define the motion detection area or areas.

Click the **Zone settings** tab to display the motion detection screen.

Place your mouse pointer at a point on the screen from where you want to start marking the motion detection area and it to mark the area sensitive to motion. Several areas can be defined.



**Note:** You cannot adjust an area already drawn. Click **Clear All** to delete all areas marked and restart drawing.

4. Select the motion detection sensitivity level from the drop-down list.  
All areas will have the same sensitivity level.
5. Click the Linkage tab. The Linkage screen appears.

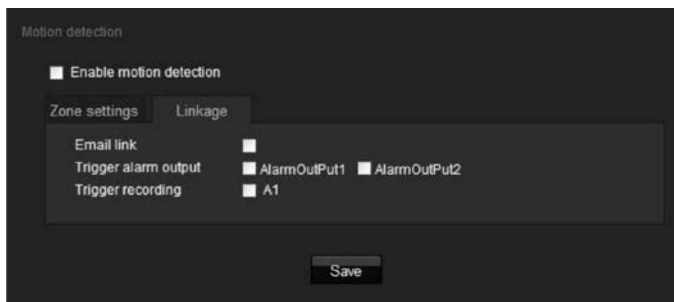

6. Check a response method for the system when a motion detection alarm is triggered. You can check one or more of the following response methods:

<b>Email link</b>	Sends an e-mail to a specified address when there is a motion detection alarm. See “Network parameters” on page 19 for further information.
<b>Trigger alarm output</b>	Triggers the camera’s alarm output. Up to two alarm outputs can be selected.
<b>Trigger recording</b>	Triggers the recording to start in the camera (A1).

7. Click **Save** to save changes.

## Adding extra on-screen text

You can add up to four lines of text on screen. This option can be used, for example, to display emergency contact details. Each text line can be positioned anywhere on screen.

### To add on-screen text:

1. In the Channel Parameters folder click the **Text Overlay** subfolder to open its screen.
2. Check the **OSD text** box for the first line of text.
3. Enter the text in the **Text information** column. Up to 22 alphanumeric characters can be used.
4. Enter the X and Y position co-ordinates of the text line on screen. The position values can be between 1 and 512.
5. Repeat steps 2 and 4 for each extra line of text, selecting the next string number.
6. Click **Save** to save changes.

## Configuring the video image

You may need to adjust the camera image depending on the camera model or location background in order to get the best image quality. You can adjust the brightness, contrast, saturation and sharpness of the video image. See Figure 17 below.

Brightness, contrast, saturation, hue and shutter speed can also be modified in live mode using the pop-up video image menu. See item 13 in Figure 16 on page 35 for more information.

Use this menu to also adjust camera behavior parameters such as shutter speed, iris mode, day/night mode, IR mode, image flip, power mode and white balance.

Figure 16: Camera image settings menu (4CIF camera screen shown)

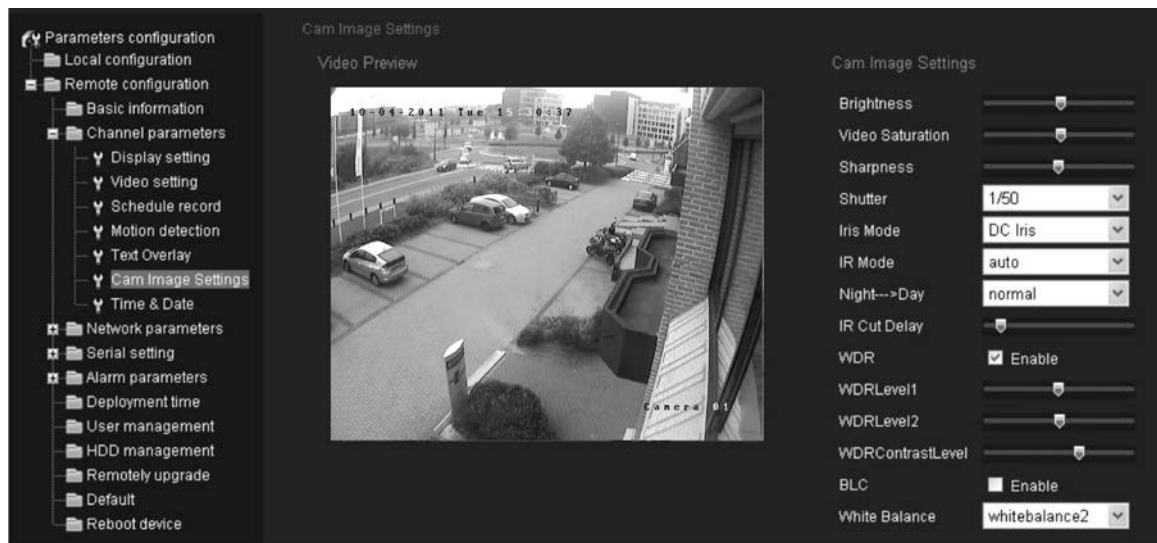

Parameter	Description
Brightness Video saturation Sharpness	Modifies the different elements of picture quality by adjusting the position of the values for each of parameter.
Shutter	The shutter speed controls the length of time that the aperture is open to let light into the camera through the lens. Select a higher value to see movement and a lower value to see clearer images. The settings available depend on the lens type used.
Iris mode	There are two settings, Manual and DC Iris. The type of lens determines which setting is used.
IR mode	Defines whether the camera is in day or night mode. The day (color) option could be used, for example, if the camera is located indoors where light levels are always good. Options: <b>Day:</b> Camera is always in day mode. <b>Night:</b> Camera is always in night mode. <b>Auto:</b> The camera automatically detects which mode to use. Default is Auto.
Day/Night	Adjusts the sensitivity of the camera to color or black and white. Options: Low, Normal or High. Default is Normal.
IR cut delay	Adjusts the delay time to change between day and night mode.
WDR level 1 WDR level 2	<i>4CIF camera models only.</i> When enabled, this feature (wide dynamic range) allows you to see details of objects in shadows or details of objects in bright areas of frames that have high contrast between light and dark areas. Use these two scroll bars to adjust the WDR level.

Parameter	Description
WDR contrast level	<p><i>4CIF camera models only.</i></p> <p>Adjusts the WDR contrast level.</p>
BLC	<p><i>All camera models except the 2 megapixel camera.</i></p> <p>The backlight compensation (BLC) function improves image quality when the background illumination is high. It prevents the object in the center from appearing too dark.</p> <p>Enable/disable the BLC feature.</p>
Image flip	<p><i>Not available on 4CIF camera models.</i></p> <p>Use this function to flip the original image into a mirror image. This could be used, for example, when the camera needs to be installed upside down. The image can be flipped horizontally (up/down), vertically (right/left) or centered. Default is None.</p> <p><b>Note:</b> The on-screen text does not flip.</p>
White balance	<p>White balance (WB) tells the camera what the color white looks like. Based on this information, the camera will then continue to display all colors correctly even when the color temperature of the scene changes such as from daylight to fluorescent lighting, for example. Select one of the options:</p> <p><b>Auto:</b> White balance is determined automatically.</p> <p><b>White balance 1:</b> White balance for indoor environments.</p> <p><b>White balance 2:</b> White balance for outdoor environments. This option is only available on 4CIF camera models.</p>



# Chapter 5

## Camera management

This chapter describes how to use the camera once it is installed and configured. The camera is accessed through a Web browser.

### User management

This section describes how to manage users from the “User Management” screen. You can:

- Add or delete users
- Modify passwords

Only the administrator can manage users. The administrator can create up to 15 additional individual users. When new users are added to the list, the administrator can define individual passwords or each user can use a default password. See Figure 17 below.

Figure 17: User management screen

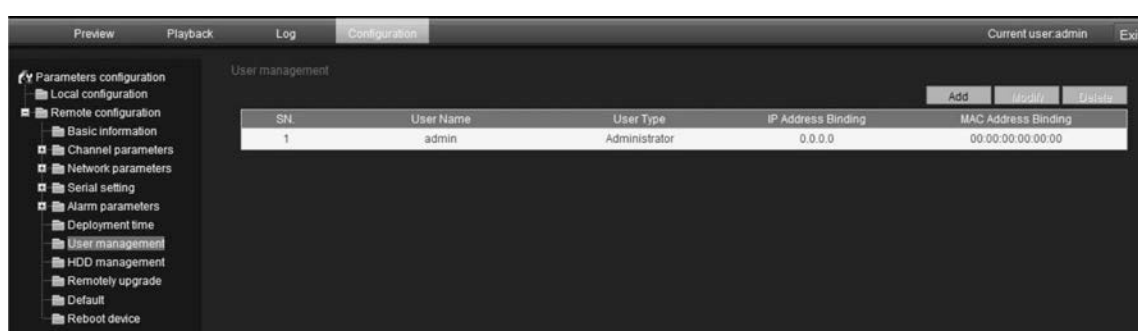

Passwords limit access to the camera and the same password can be used by several users. When creating a new user, you must give the user a password. There is no default password provided for all users. Users can modify their password. However, only the administrator can create a password for a user. Admin passwords can have up to four digits, ranging from 1 to 4.

**Note:** Keep the admin password in a safe place. If you should forget it, contact technical support.

You can control who can connect to a camera by the user IP and physical (MAC) addresses entered for a user. Setting up a user with a MAC address from the user's computer prohibits access to the camera from other computers. All users can connect to a camera when IP and MAC addresses are set to zero.

The user access rights must be set up for each camera individually.

### Types of users

A user's access privileges to the system are automatically defined by their user type. There are three types of user:

- **Admin:** This is the system administrator. The administrator can configure all settings. Only the administrator can create and delete user accounts. Admin cannot be deleted.
- **Operator:** This user can only change the configuration of his/her own account. An operator cannot create or delete other users.
- **Viewer:** This user can use live mode, record and playback as well as take snapshots. However, they cannot change any configuration settings nor search the logs for events.

## Adding and deleting users

The administrator can create up to 15 users. Only the system administrator can create or delete users.

### To add a user:

1. Click the **User management** folder to open its screen.
2. Select the **Add** button. The user management screen appears.

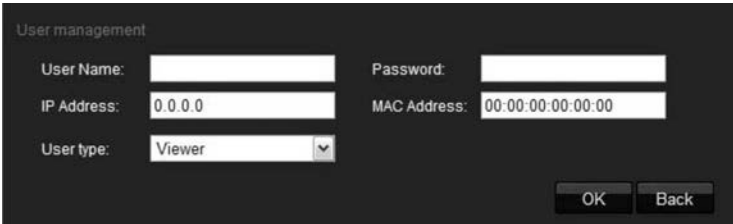

The screenshot shows a 'User management' dialog box with the following fields and controls:

- User Name:** An empty text input field.
- Password:** An empty text input field.
- IP Address:** A text input field containing '0.0.0.0'.
- MAC Address:** A text input field containing '00-00-00-00-00-00'.
- User type:** A dropdown menu currently set to 'Viewer'.
- Buttons:** 'OK' and 'Back' buttons at the bottom right.

3. Enter a user name. The name can have up to 16 alphanumeric characters.
4. Assign the user a password. Passwords can have up to 16 alphanumeric characters.
5. Enter the IP address and physical address (MAC address) of the user's computer.
6. Select the type of user from the drop-down list. The options are Viewer and Operator.
7. Click **OK** to save the changes and return to the main "User management" screen.

**To delete a user:**

1. Click the **User management** folder to open its screen.
2. Select the **Delete** button. The user management screen appears.
3. Click the desired user in the list. Select **Delete**.  
Confirm that you want to delete the user.
4. Click **OK** to save the changes.

**Modifying user information**

You can easily change the information about a user such as their name, password or computer ID.

**To modify user information:**

1. Click the **User management** folder to open its screen.
2. Select the user.
3. Click the **Modify** button. The user management screen appears.
4. Change the information required.

**Note:** The user “Admin” can only be changed by entering the admin password.

5. Click **OK** to save the changes.

**Formatting the SDHC card**

Use the HDD Configuration screen to display the capacity and free space available on the SDHC card in the camera as well as the working status of the HDD. You can also format the card.

Before formatting the HDD (the SDHC card), stop all recording. Once formatting is completed, reboot the camera as otherwise the device will not function properly.

When the card becomes full, it overwrites the oldest recordings.

### To format the SDHC card:

1. Click the **HDD Management** folder to open its screen.

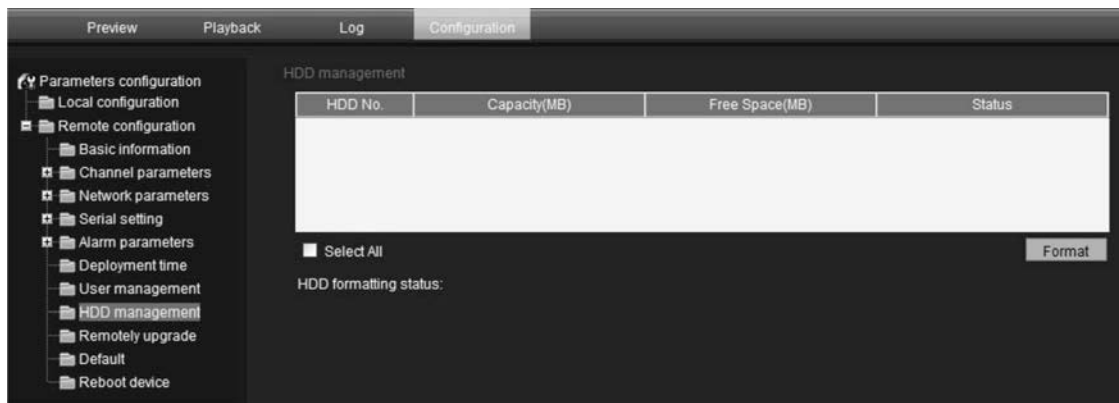

2. Click **Select All** in the HDD Number column to select the SDHC card. Only one HDD option is listed.
3. Click **Format**. A screen appears showing the formatting status.

## Restoring default settings

Use the Default menu to restore default settings to the camera. There are two options available:

- **Full mode:** All parameters are restored to factory default settings.
- **Basic mode:** All parameters are restored to factory default settings except for the network settings IP address, subnet mask gate and port.

You can also do a hard reset by pressing the INITIAL SET button on the base of the camera (see Figure 3 on page 6).

### To restore default settings:

1. Click the **Default** folder to open its screen.
2. Click either **Full mode** or **Basic mode**. You will receive a prompt asking you to reboot the camera.

## Upgrading the firmware

The camera firmware is stored in the flash memory. Use the upgrade function to write the firmware file (*digicap.DAV*) into the flash memory.

You need to upgrade firmware when it has become outdated. When you upgrade the firmware, all existing settings are unchanged. Only the new features are added with their default settings.

**To upgrade the firmware through the Web browser:**

1. Download on to your computer the latest firmware from our web site at:  
[www.utcssecurityproductspages.eu/videoupgrades/](http://www.utcssecurityproductspages.eu/videoupgrades/)
2. In the “Remote configuration” folder select the subfolder “Remotely upgrade” to open the “Remotely upgrade” screen.
3. Click the **Browse** button to locate the latest *digicap.DAV* file on your computer.
4. Click **Update**. You will receive a prompt asking you to reboot the camera.

## Rebooting the camera

The camera can be easily rebooted remotely.

Click the folder **Reboot device** to open its screen. Click **OK** to the question “Restart the device?” The camera reboots.



# Chapter 6

## Camera operation

This chapter describes how to use the camera once it is installed and configured.

### Logging on and off

You can easily login and out of the camera browser screen by clicking the Login button on the menu toolbar. You will be asked each time to enter your user name and password when logging in.

**Figure 18: Login dialog box**



Only one camera is accessible from a Web browser screen. If there is more than one camera connected to the network, open a separate Web browser screen for each individual camera.

### Live mode

Once logged in, open the camera's Web browser screen and click "Live" on the menu toolbar to view live mode. See "Figure 6: Web browser interface" on page 15 for the description of the interface.

You can stop and start live view by clicking the Start/stop live view button  on the bottom of the screen.

## Adjusting the image quality

Click the image quality button in the live mode screen to get a pop-up window that lets you adjust video image settings such as brightness, contrast, saturation, hue and exposure time (see Figure 6 on page 15). Changes appear immediately and are also applied to the settings in the menu “Camera image settings” (see page 34).

## Manual recording

You can manually record live video and store the images on your computer’s desk top. In the live mode screen, click the Record button at the bottom of the screen. To stop recording, click the button again.

A folder with the recording automatically opens on your computer desktop when recording stops.

**Note:** You must have manual recording rights to manually record images. See “Modifying user information” on page 39 for more information.

## Taking a snapshot

You can take a snapshot of a scene when in live mode. Simply click the snapshot button located at the bottom of the screen to save an image. The image is in jpeg format. Snapshots are saved on the hard drive.

## Playing back recorded video

You can easily search and play back recorded video from the cameras.

**Note:** There must be an SDHC card inserted in the camera to be able to use the playback functions.



To search recorded video stored on the camera’s SDHC card for playback, click **Playback** on the menu toolbar. The Playback screen displays. See Figure 19 on page 45.



Figure 19: Playback screen



Item	Name	Description
1.	Playback button	Click to open the Playback screen.
2.	Full screen	Click to view as full screen.
3.	Current status	Displays recording type currently being played.
4.	Search calendar	Click the day required to search. You cannot search by particular criteria such as alarm type or time. However, the type of recording is displayed in the recording type bar (see item 9). The color codes of the recording types are shown in item 11.
5.	Locate time	Click to enter a specific time period to search.
6.	Start search	Start search. Results are listed in the file list box underneath and are arranged by start time.
7.	Download	Click to download the selected file to your computer desktop.
8.	Control playback	Click to control how the selected file is played back: play, stop, reverse and fast forward playback.
9.	Timeline bar	The timeline bar displays the 24-hour period of the day being played back. It moves left (oldest) to right (newest). The bar is color-coded to display the type of recording. Click a location on the timeline to move the cursor to where you want playback to start. The timeline can also be scrolled to earlier or later periods for play back.
10.	Time moment	Vertical bar shows where you are in the playback recording. The current time and date are also displayed.

Item	Name	Description
11.	Recording type	The color code displays the recording type. Recording types are schedule recording, alarm recording and manual recording. The recording type name is also displayed in the current status window.
12.	Archive functions	Click these buttons for the following archive actions:  Capture a snapshot image of the playback video.  Save the selected file onto your desktop.
13.	Audio	 Adjust the audio level.

### To play back a recorded file

**Note:** You must have playback rights to playback recorded images. See “Modifying user information” on page 39 for more information.

1. Search for the desired video files using the Playback screen. Recordings can be searched by date and time. They are listed in the file list box and are arranged by start time.
2. Double-click a video file in the file list box to start playback. Only the selected file is played.

While playing back a video, the timeline bar displays the type and time of the recording. The timeline can be manually scrolled using the mouse.

## Searching event logs

There must be an SD card inserted in the camera to be able to record logs.

The number of event logs that can be stored on a SD card depends on the capacity of the card. When this capacity is reached, the system starts deleting older logs. To view logs stored on the camera’s SD card, click **Log** on the menu toolbar. The Log screen appears. See Figure 20 on page 47.

**Note:** You must have view log access rights to search and view logs. See “User management” on page 37 for more information.

Figure 20: Log screen

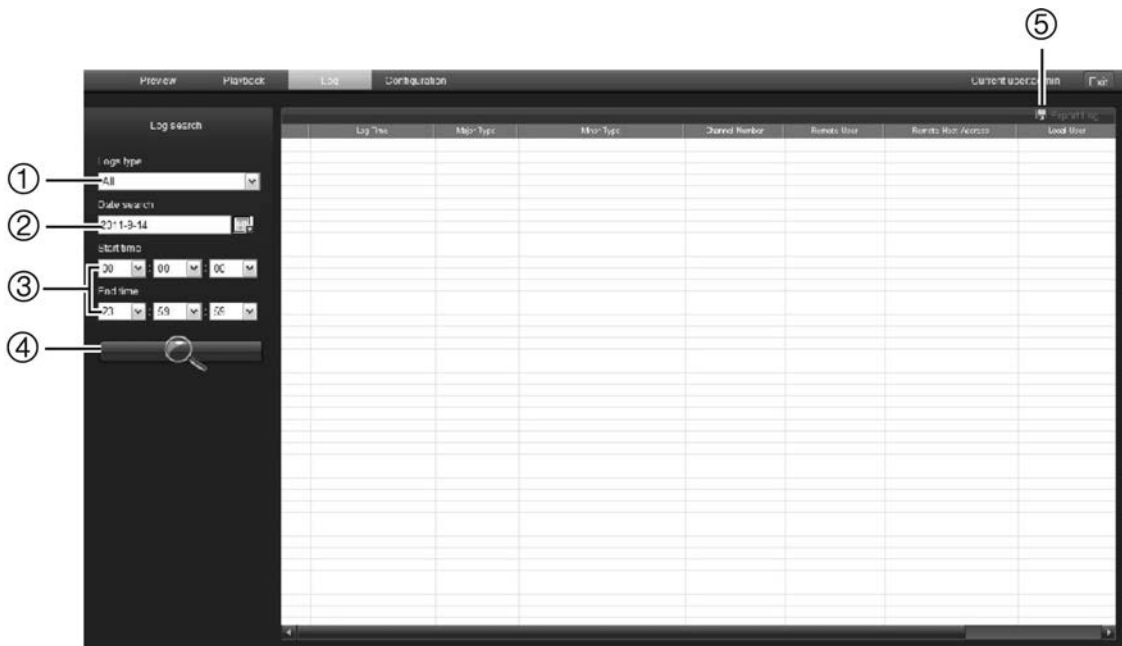

1. Log type
2. Date search
3. Start and end search times
4. Start search
5. Export log. Save selected logs to your computer desktop.

You can search for recorded logs by the following criteria:

**Log type:** There are three types of logs: Alarm, Notification and Operation. See Table 6 below for their descriptions.

**Date:** Logs can be searched by date.

**Time:** Logs can be searched by start and end recording times.

Table 6: Types of logs

Log type	Description of events included
Alarm	External Alarm In, External Alarm Out, Motion Detect Start, Motion Detect Stop, View Tamper Start, and View Tamper Stop
Notification	Video Signal Loss, Illegal Access, Hard Disk Error, Hard Disk Full, IP Conflict, and DCD Lost
Operation	Power On, Shut Down, Abnormal Shut, Panel Login, Panel Logout, Panel Config, Panel File Play, Panel Time Play, Local Start Record, Local Stop Record, Panel PTZ, Panel Preview, Panel Set Time, Local Upgrade, Net Login, Net Logout, Net Start Record, Net Stop Record, Net Start Transparent Channel, Net Stop Transparent Channel, Net Get Parameter, Net Config, Net get Status, Net Alert On, Net Alert Off, Net Reboot, BiComStart (Start Voice Talk), BiComStop (Stop Voice Talk), Net Upgrade, Net File Play, Net Time Play, Net PTZ

**To search logs by type:**

1. Click **Log** in the menu toolbar to display the Log screen.
2. In the Log Type drop-down list select the desired option.
3. Click **Search** to start your search. The results appear in the screen.

**To search logs by date and time:**

1. Click **Log** in the menu toolbar to display the Log screen.
2. Select a date to be searched. Only one day can be searched at a time.
3. Enter a start and end time.
4. Click **Search** to start your search. The results appear in the screen.

## Archiving recorded files

Export recorded files onto your computer desktop for archiving. You can also archive specific incidents in a file.

Use the standard file player software to play back the videos on your PC.

Video that is manually recorded during live mode is saved directly to your computer desktop (see page 44).

**Note:** You must have playback privileges to play back recorded files. Avoid moving the external recording device when backing up information onto it.

**To archive a recorded video file:**

1. Search for the required recorded file.

For more information on searching for recorded files, see “Playing back recorded video” on page 44 and “Searching event logs” on page 46.

2. Select the file that you want to archive.

3. **In playback mode:**

Click **Download** to start archiving the file to your computer desktop.

- Or -

While playing back a video, click the save button  to start archiving the file to your computer desktop. Click again to stop archiving.

**In log results:**

Click the **Export log** to start archiving the file to your computer desktop

**To archive a recorded video segment during playback:**

1. While playing back a recorded file click the snapshot button  to start recording and click it again to stop recording. A video segment is created.

2. Repeat step 1 to create additional segments. You can generate up to 30 additional segments. The video segments are saved onto your computer desktop.

## Using presets

This function is for future use.



# Appendix A

## Specifications

<b>Electrical</b>	
Voltage input	12 VDC, PoE (IEEE 802.3af)
Power consumption	4.5 W max. TVC-N220-1-N(-P), TVC-M2220-1-N(-P) 5 W max. TVC-M5220-1-N(-P) 5.5 W max. TVC-N240-1-N(-P), TVC-M3220-1-N(-P) 7.5 W max. TVC-M1220-1-N(-P)
I/O connection	Terminal plug, RJ45 flying lead
<b>Network</b>	
Protocols	TCP/IP, HTTP, DHCP, DNS, DDNS, RTP/RTCP, PPPoE, SMTP, NTP
Ethernet/IP	CoS 802.1 p/Q, QoS, IPv4
PoE IEEE	802.3af
<b>Miscellaneous</b>	
Dimensions (L x W x H)	142 x 68 x 65 mm (5.6 x 2.7 x 2.6 in.)
Weight	0.5 kg (1.1 lbs)
Operating temperature	-10°C to +60°C (14 to 140°F)
Storage temperature	-20 to +70 °C (-4 to +158 °F)
Environmental rating	Indoor
<b>PC requirements</b>	
Intel-based PC	1 GHz or faster
Memory	1 GB RAM
Operating system	Windows® XP, Vista or Windows 7
CGI	Direct X 9.0 or later
Browser	Microsoft Internet Explorer 6.0 or later





# Appendix B

## Pin definitions

There are eight wires on a standard UTP/STP cable and each wire is color-coded. The following shows the pin allocation and color of straight and crossover cable connection:

**Figure 21: Straight-through cable**



**Figure 22: Cross-over cable**

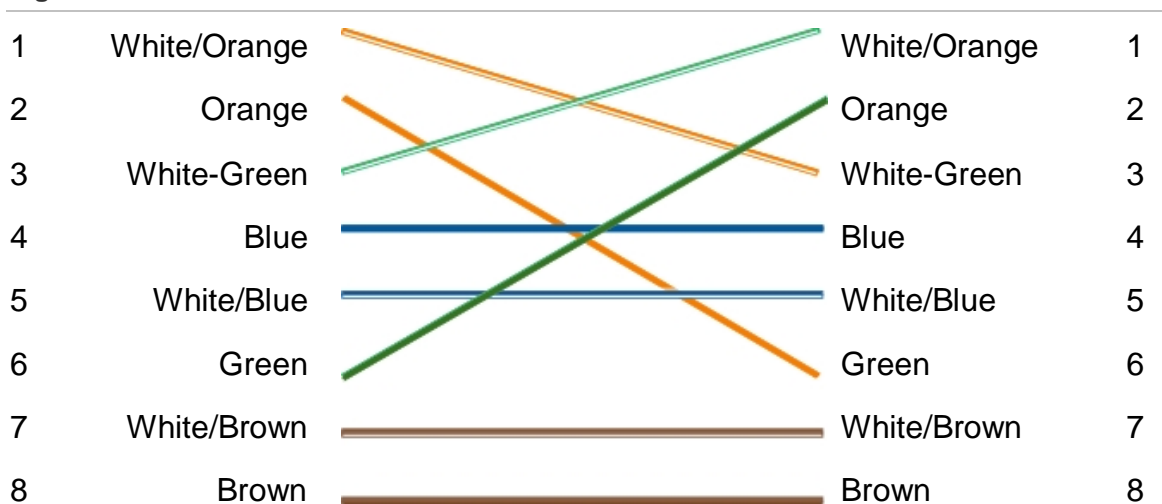

Please make sure your connected cables have the same pin assignment and color as above before deploying the cables in your network.

# Index

## A

- Alarm configuration, 26
  - response method, 26
- Alarm inputs configuration, 26
- Alarm outputs configuration, 26
- Alarm settings
  - alarm relay output, 27
- Alarm types
  - motion detection, 31
- Archived files
  - playing back, 48
- Archiving files
  - recorded files, 48
  - set up default directories, 17
  - snapshots of recorded files, 48

## B

- Brightness setup, 16, 35

## C

- Cabling requirements, 4
- Camera configuration, 23
- Camera description, 5
- Camera dimensions, 5
- Camera image
  - configuring, 34
  - day/night, 35
  - image flip, 36
  - WDR, 35
  - white balance, 36
- Camera name
  - changing, 19
  - display, 24
- Camera recording schedule
  - configuring, 30
- Ceiling mounting, 8
- Channel configuration, 23
- Contrast setup, 16, 35

## D

- Date format set up, 24
- Day/night setup, 35
- Default settings

- restore, 40

- Device information
  - display, 19
- Display information on-screen
  - set up, 24

## E

- E-mail setup
  - alarm response method, 26
  - configuring, 21
- Events schedule
  - defining, 27
- Exposure time setup, 16

## F

- Firmware upgrade, 40
- Frame rate
  - configuring, 29

## H

- Hard drive
  - capacity, 39
  - card full, 39
  - formatting, 39
- Hue setup, 16

## I

- Image flip setup, 36
- Installing the cameras, 7
- IP address
  - configuring, 21

## L

- Language, 16
- Live mode
  - starting, 43
- Logging on and off, 43
- Logs
  - information type, 47
  - search logs, 46
  - viewing logs, 46

**M**

- Motion detection
  - configuring, 31
  - marking the detection areas, 32

**N**

- Network parameters, 19
- Network protocol
  - setup, 17
- Network settings
  - configuring, 16, 20
  - overview of local camera parameters, 17
- NTP synchronization, 25

**P**

- Passwords
  - modifying, 39
- Playback
  - play back recorded files, 46
  - screen, 44
  - searching recorded video, 44
- Post-event recording times
  - description, 30

**Q**

- Quick set up of the cameras, 7

**R**

- Reboot camera, 41
- Recording
  - defining events schedule, 27
  - defining recoding schedule, 29
  - manual recording, 44
  - playback, 44
  - snapshots from recorded files, 48
  - snapshots in live mode, 44
- Recording parameters, 28
- Recording parameters setup, 28

**S**

- Saturation setup, 16, 35
- SDHC card
  - capacity, 39
  - card full, 39
  - formatting, 39
  - free space available, 39

- location in camera, 7
- Serial ports
  - configuring, 21
- Sharpness setup, 35
- Shutter speed setup, 35
- Snapshots
  - archiving snapshots from recorded files, 48
  - saving during live mode, 44
- Streaming
  - main/sub setup, 17
- System time
  - set up, 25

**T**

- Text
  - adding extra lines of text on screen, 34
- Text display on-screen
  - appearance, 24
- Time format set up, 24
- TruVision Navigator, 9
- TVR 60, 9

**U**

- User settings, 37
- Users
  - adding new users, 38
  - deleting a user, 39
  - managing, 37
  - modifying computer ID, 39
  - modifying password, 39

**V**

- Video quality, 34

**W**

- WDR setup, 35
- Web browser
  - accessing camera, 13
  - overview of the interface, 14
- Web browser security level
  - add camera to Windows Vista and Windows 7 trusted sites, 13
  - checking, 11
  - configuring ActiveX controls, 11
- White balance setup, 36
- Wiring the dome camera, 6



