



Outdoor Mini Dome & Outdoor Mini Fisheye Dome Hardware Manual

E924, E926, E928

E924M, E926M, E928M

Ver. 2015/02/02



ACTi
Connecting Vision

Table of Contents

Precautions **4**

Safety Instructions	6
----------------------------------	----------

Introduction **7**

List of Models.....	7
Package Contents.....	8
Physical Description	9
E924 / E926 / E928.....	9
E924M / E926M / E928M.....	10
Mounting Options	11

Installation Procedures **12**

Step 1: Prepare for Installation.....	12
Step 2: Open the Dome Cover	13
Step 3: Route the Cables	14
Step 4: Install the Camera.....	15
Step 5: Waterproof the Cable Connection	16
M12 Ethernet Cable (for E9xxM models only).....	16
RJ-45 Ethernet Cable (for E9xx models only)	17
Step 6: Connect to Network.....	20
Step 7: Access the Camera Live View.....	20
Step 8: Close the Dome Cover.....	21

Other Adjustments and Accessories **22**

How to Install / Remove the Memory Card	22
How to Insert the Memory Card	22
How to Remove the Memory Card.....	22
How to Adjust the Viewing Angle and Orientation.....	23
How to Connect Audio In Device.....	25
How to Use the IR LED Cover	26

How to Replace the Dome Cover..... 27

Accessing the Camera **31**

Configure the IP Addresses 31

- Using DHCP Server to Assign IP Addresses..... 31
- Using the Default Camera IP Address..... 33

Access the Camera..... 35

Precautions

Read these instructions

You should read all the safety and operating instructions before using this product.

Heed all warnings

You must adhere to all the warnings on the product and in the instruction manual. Failure to follow the safety instruction given may directly endanger people, cause damage to the system or to other equipment.

Servicing

Do not attempt to service this video device yourself as opening or removing covers may expose you to dangerous voltage or other hazards. Refer all servicing to qualified service personnel.

Trademarks

All names used in this manual are probably registered trademarks of respective companies.

Liability

Every reasonable care has been taken during the writing of this manual. Please inform your local office if you find any inaccuracies or omissions. We cannot be held responsible for any typographical or technical errors and reserve the right to make changes to the product and manuals without prior notice.

Federal Communications Commission Statement



This equipment has been tested and found to comply with the limits for a class B digital device, pursuant to Part 15 of the FCC Rules. These limits are designed to provide reasonable protection against harmful interference in a residential installation. This equipment generates, uses, and can radiate radio frequency energy and, if not installed and used in accordance with the instructions, may cause harmful interference to radio communications. However, there is no guarantee that interference will not occur in a particular installation. If this equipment does cause harmful interference to radio or television reception, which can be determined by turning the equipment off and on, the user is encouraged to try to correct the interference by one or more of the following measures:

- Reorient or relocate the receiving antenna.
- Increase the separation between the equipment and receiver.
- Connect the equipment into an outlet on a circuit different from that to which the receiver is connected.
- Consult the dealer or an experienced radio/TV technician for help.

Warning: Changes or modifications to the equipment that are not expressly approved by the responsible party for compliance could void the user's authority to operate the equipment.

European Community Compliance Statement



This product has been tested and found to comply with the limits for Class B Information Technology Equipment according to European Standard EN 55022 and EN 55024. In a domestic environment, this product may cause radio interference in which cause the user may be required to take adequate measures.

Safety Instructions

Cleaning

Disconnect this video product from the power supply before cleaning.

Attachments

Do not use attachments not recommended by the video product manufacturer as they may cause hazards.

Water and Moisture

Do not use this video product near water, for example, near a bathtub, washbowl, kitchen sink, or laundry tub, in a wet basement, or near a swimming pool and the like.

Don't use accessories not recommended by the manufacturer

Only install this device in a dry place protected from weather

Servicing

Do not attempt to service this video product yourself as opening or removing covers may expose you to dangerous voltage or other hazards. Refer all servicing to qualified service personnel.

Damage Requiring service

Disconnect this video product from the power supply immediately and refer servicing to qualified service personnel under the following conditions.

- 1) When the power-supply cord or plug is damaged
- 2) If liquid has been spilled, or objects have fallen into the video product.
- 3) If the video product has been directly exposed to rain or water.
- 4) If the video product does not operate normally by following the operating Instructions in this manual. Adjust only those controls that are covered by the instruction manual, as an improper adjustment of other controls may result in damage, and will often require extensive work by a qualified technician to restore the video product to its normal operation.







Safety Check

Upon completion of any service or repairs to this video product, ask the service technician to perform safety checks to determine if the video product is in proper operating condition.

Introduction

List of Models

This hardware manual contains the following models:

E924		5MP Outdoor Mini Dome with D/N, Adaptive IR, Basic WDR, Fixed lens
E924M		5MP Outdoor Mini Dome with D/N, Adaptive IR, Basic WDR, M12 connector, Fixed lens
E926		10MP Outdoor Mini Dome with D/N, Adaptive IR, Basic WDR, Fixed lens
E926M		10MP Outdoor Mini Dome with D/N, Adaptive IR, Basic WDR, M12 connector, Fixed lens
E928		3MP Outdoor Mini Dome with D/N, Adaptive IR, Superior WDR, Fixed lens
E928M		3MP Outdoor Mini Dome with D/N, Adaptive IR, Superior WDR, M12 connector, Fixed lens

From the installation perspective, the above models are very similar; therefore one manual is used for all of them.

Package Contents

Check if the camera package comes with the following items:

<p>Camera</p>	<p>Hexagon Screwdriver</p>
	
<p>Screw Kit</p>	<p>Drill Template</p>
	
<p>IR LED Cover</p>	<p>Cable Gland (Not available in E9xxM models)</p>
	
<p>Quick Installation Guide</p>	<p>Warranty Card</p>
	

IMPORTANT: When the camera is taken out from the box, the lens cover is covered by a thin film. DO NOT remove this film. It is used to protect the lens cover from scratches or fingerprint marks which may happen during installation. Remove this film only after the camera is securely installed and all connections are complete.

Physical Description

E924 / E926 / E928



Item		Description
1	Memory Card Slot	Insert a memory card (not included) into the slot for local recording purposes. See How to Install / Remove the Memory Card on page 22 for more information. NOTE: Supports only microSDHC and microSDXC cards.
2	Power LED	Lights up when the camera is powered up and goes off after the boot up process is complete
3	Reset Button	Restores the factory default settings of the camera. To reset the camera, while the power is on, press and hold the Reset Button for at least 5 seconds or until the Power LED lights up.
4	Audio Input	Connects to audio input devices, such as a microphone with built-in amplifier, etc. See How to Connect Audio In Device on page 25 for more information. NOTE: The microphone must have a built-in amplifier. Connecting an ordinary microphone will dwarf sounds and will result in inaudible recording.
5	Ethernet Port (RJ-45)	Connects to a network using an Ethernet cable with RJ-45 connector.

E924M / E926M / E928M



Item	Description
1	<p>Memory Card Slot</p> <p>Insert a memory card (not included) into the slot for local recording purposes. See How to Install / Remove the Memory Card on page 22 for more information.</p> <p>NOTE: Supports only microSDHC and microSDXC cards.</p>
2	<p>Power LED</p> <p>Lights up when the camera is powered up and goes off after the boot up process is complete</p>
3	<p>Reset Button</p> <p>Restores the factory default settings of the camera. To reset the camera, while the power is on, press and hold the Reset Button for at least 5 seconds or until the Power LED lights up.</p>
4	<p>Audio Input</p> <p>Connects to audio input devices, such as a microphone with built-in amplifier, etc. See How to Connect Audio In Device on page 25 for more information.</p> <p>NOTE: The microphone must have a built-in amplifier. Connecting an ordinary microphone will dwarf sounds and will result in inaudible recording.</p>
5	<p>Ethernet Port (M12)</p> <p>Connects to a network using an Ethernet cable with M12 connector. The camera uses the female M12 connector with D-coding and PoE type A.</p>

Mounting Options

Select the most suitable solution for your installation environment. The camera can be mounted by either of the following methods:

Mount Types	Accessories
Surface Mount	Suitable when mounting the camera directly on walls or ceilings without additional mounting accessories. See <i>Installation Procedures</i> on page 12 for more information.
Gangbox	Suitable when mounting the camera on a 4" Round or 4" Octagon Gangbox. The use of gangbox is lawfully required in some areas in the United States. A Gangbox Converter (purchased separately) is required for this type of installation.
Wall Mount	Suitable when mounting the camera on the wall with the camera facing down as if installed on the ceiling. The Wall Mount (optional mounting accessory) is required for this type of installation.
Pendant Mount	Suitable when installing the camera on high ceilings where a straight tube is used to lower the camera. The Pendant Mount with Mount Kit (optional accessory set) is required for this type of installation.

NOTE:

- For more information about the mounting solutions and accessories, please check the *Mounting Accessory Selector* in our website (<http://www.acti.com/mountingselector>).
- The above mounting accessories are not included in the package. Contact your sales agents to purchase.

Installation Procedures

This section describes procedures in mounting the camera on a flat surface.

NOTE: The camera images on this documentation are for reference only and may be different from the actual camera.

Step 1: Prepare for Installation

1. Before installing the camera, prepare the additional accessories required for installation.

E9xx Models	E9xxM Models
<ul style="list-style-type: none"> • Exterior-grade Ethernet Cable with RJ-45 connector (not included; can be purchased from local stores)  <ul style="list-style-type: none"> • Bundled Cable Gland 	<ul style="list-style-type: none"> • Exterior-grade Ethernet Cable with Waterproof M12 Male Connector, D-coding and PoE type A (not included; can be purchased from local stores) 

2. Depending on the material of the surface where the camera will be installed, it may be necessary to drill the three (3) screw holes and use the supplied screw tox. In this case, attach the bundled drill template on the surface and drill the screw holes.

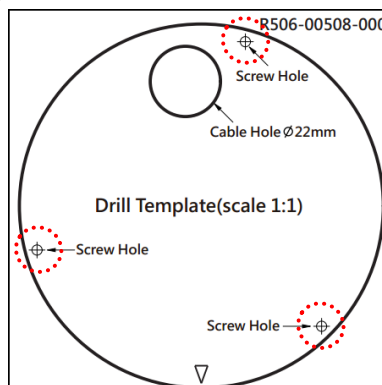

Step 2: Open the Dome Cover

1. Loosen the three (3) screws using the bundled hex screwdriver.

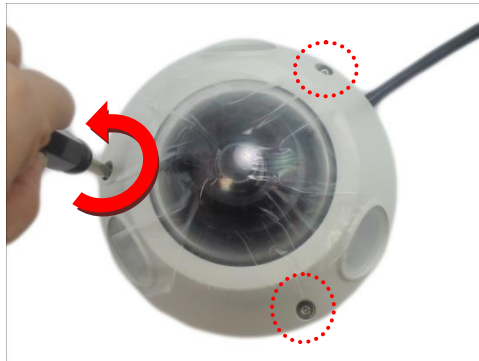

2. Lift to remove the dome cover.



NOTE:

- The dome cover is attached to the camera body by a string, do not abruptly lift the dome cover!
- A desiccant bag is attached underneath the dome cover. DO NOT remove the desiccant bag to keep the camera interior parts dry. An extra bag is bundled with the camera that can be used for replacement, as needed, over time.

Step 3: Route the Cables

Determine whether the cable will pass through a hole on the surface or be routed along the surface:

If the cable will pass through a hole on the surface:

1. Drill the hole for the cable on the surface.

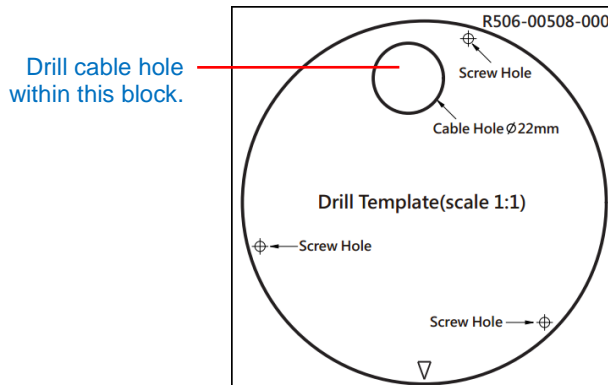

2. Route the cable from the network side through the hole and connect it to the Ethernet port of the camera.

NOTE: If the camera will be installed outdoors or in places wherein environmental factors change drastically, make sure to waterproof the cable connection; see [Step 5: Waterproof the Cable Connection](#) on page 16 for instructions.

3. Push the cable through the hole on the surface.

If the cable will be routed along the surface

1. Pull the rubber tab off from the base of the camera.

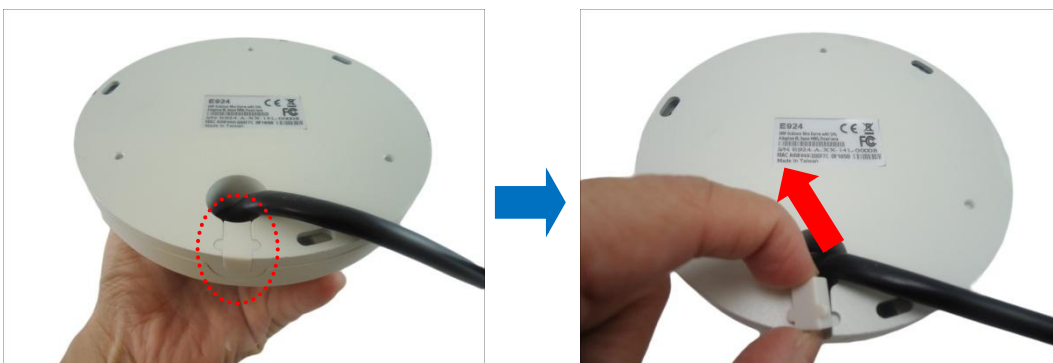

2. Route the camera cable through this gap.

Step 4: Install the Camera

1. If necessary, insert a memory card into the memory card slot of the camera. See [How to Insert the Memory Card](#) on page 22 for more information.



2. Install the camera to the surface using the three (3) bundled screws.



NOTE: Please make sure the screw is flat on the plate.

Step 5: Waterproof the Cable Connection

Depending on the camera model, the Ethernet cable or the “pigtail” of the camera may either have the RJ-45 or M12 connector.

M12 Ethernet Cable (for E9xxM models only)

Typical **M12 Ethernet cable** has waterproof connection. Simply connect and screw the cable connectors to make the connection waterproof.

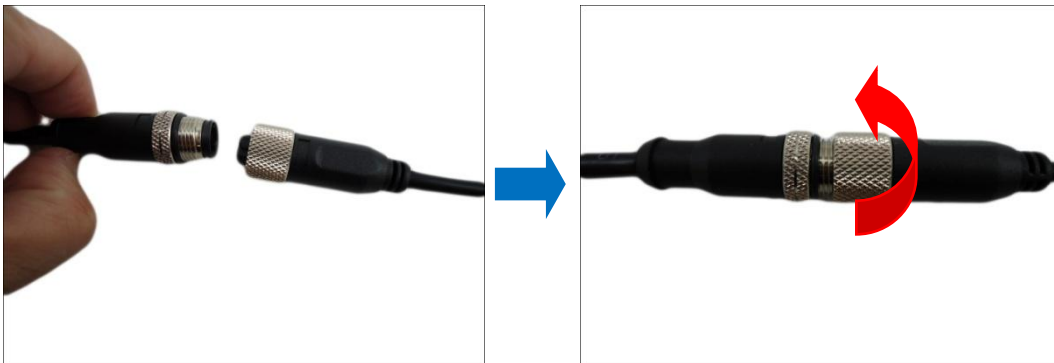

Make sure the connectors are secured tightly.

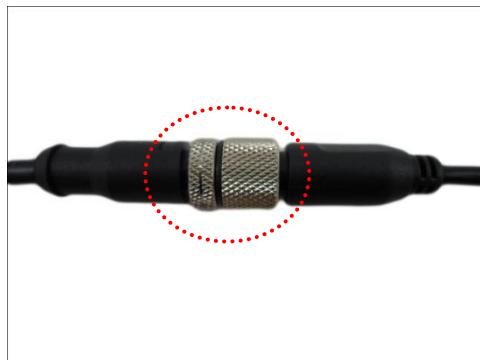

RJ-45 Ethernet Cable (for E9xx models only)

When using the **RJ-45 Ethernet cable**, follow the procedures below to waterproof the cable connection:

1. Detach the cable gland as shown below.



2. On the network side cable, insert the clamping nut through the Ethernet cable.



3. Insert the sealing rubber and claw through the Ethernet cable.

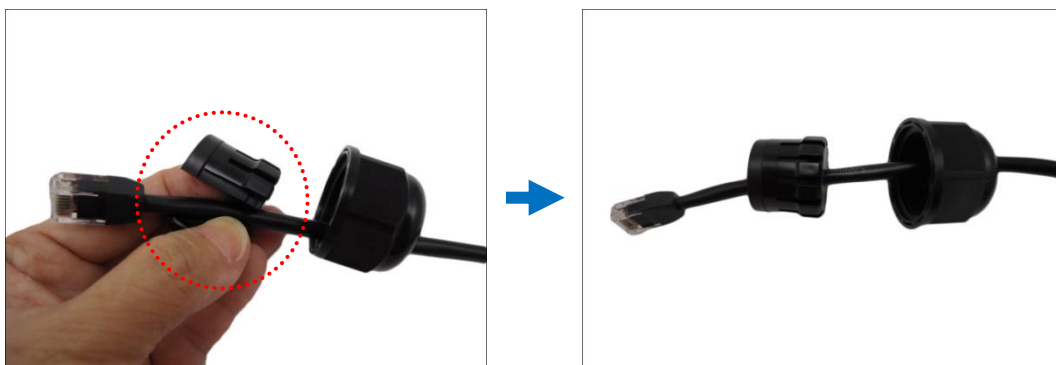

4. Make sure the bundled rubber ring is completely aligned on the gap on the gland body.



5. Attach the gland body to the Ethernet port of the camera.

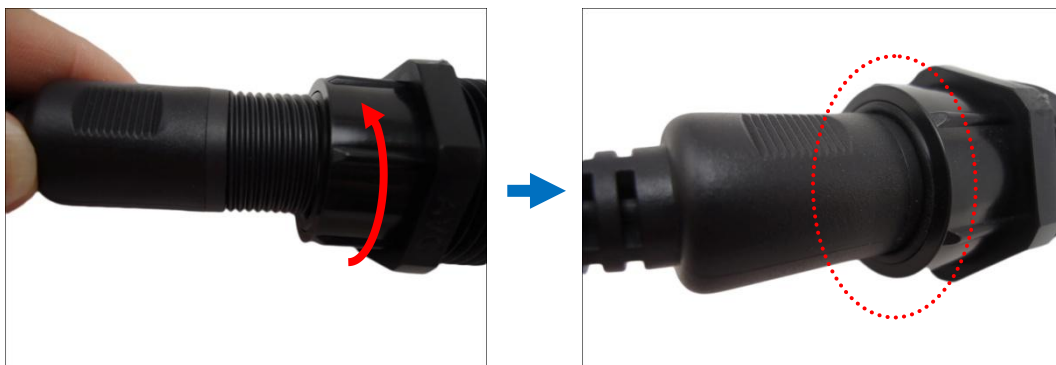

IMPORTANT!

Make sure the rubber ring is completely aligned and flat on the gland body to avoid possible water leakage.

6. Connect the RJ-45 connector of the network cable to the Ethernet port of the camera.



7. Insert the sealing rubber and claw into the cable gland body.

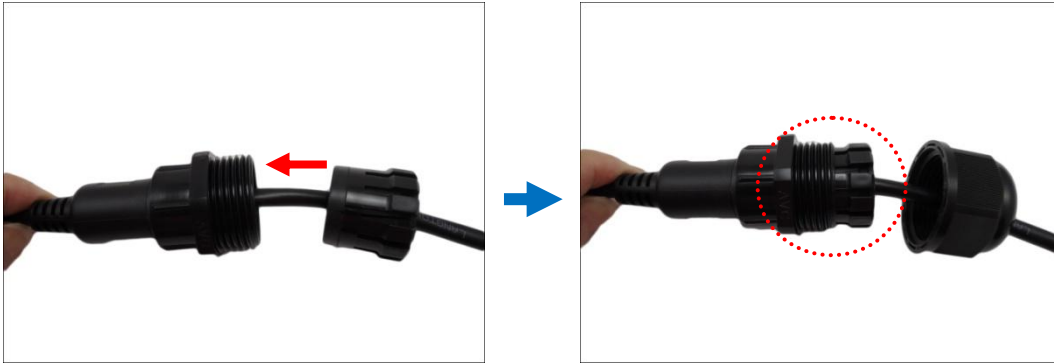

8. Attach the clamping nut to the cable gland body. Make sure the clamping nut is tightly secured and the rubber is squeezed in to avoid water leakage.

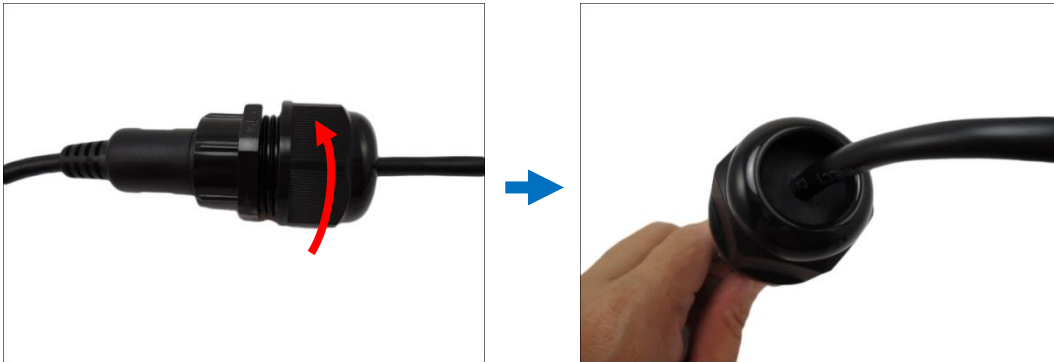

DISCLAIMER: ACTi will not be responsible for camera damage caused by water entering the cable connections.

Step 6: Connect to Network

Connect the other end of the network cable to a switch or injector. Then, connect the switch or injector to a network or PC and a power source. See Power-over-Ethernet (PoE) example connection diagram below.

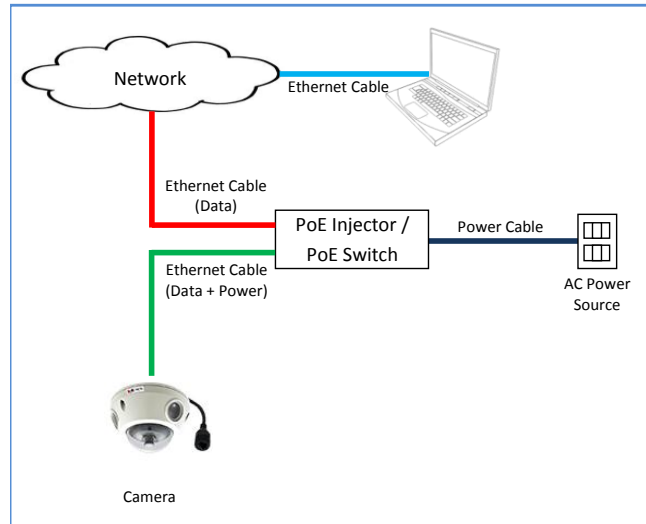

Step 7: Access the Camera Live View

See [Accessing the Camera](#) on page 31 for more information on how to access the Live View of the camera.

Step 8: Close the Dome Cover

1. Align the cable hole side of the dome cover to the direction of the network cable.
2. Tighten the three (3) screws using the supplied hex screwdriver to attach the dome cover.



3. Remove the thin film.



Final installation should look similar to the illustration below.



Other Adjustments and Accessories

How to Install / Remove the Memory Card

How to Insert the Memory Card

1. Loosen the three (3) screws to remove the dome cover.

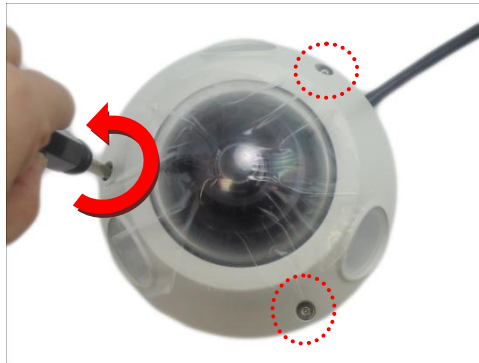

2. Insert the memory card into the card slot with the metal contacts facing the bottom side of the camera.



3. Push the card completely until it clicks into place.
4. Attach the dome cover to the camera and tighten the three (3) screws.

Once inserted, make sure to access the camera Web Configurator and “mount” the card to prepare the card for local recording. Refer to the camera Firmware User’s Manual for more information.

How to Remove the Memory Card

In case there is a need to remove the card, make sure to access the camera Web Configurator to safely “unmount” the card first (see the camera Firmware User’s Manual for more information).

Once unmounted from the firmware, push the card to eject it from the slot.

How to Adjust the Viewing Angle and Orientation

This section describes the procedures in adjusting the viewing angle and pan direction of the camera.

Camera Parts Overview



1. Open the dome cover.
2. Loosen the three (3) pan adjustment screws.

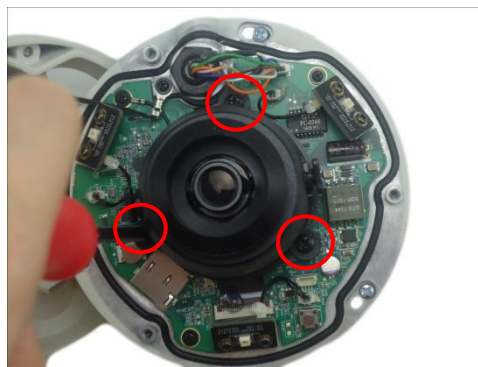

3. Move the pan direction. The arrow indicates the top side orientation.

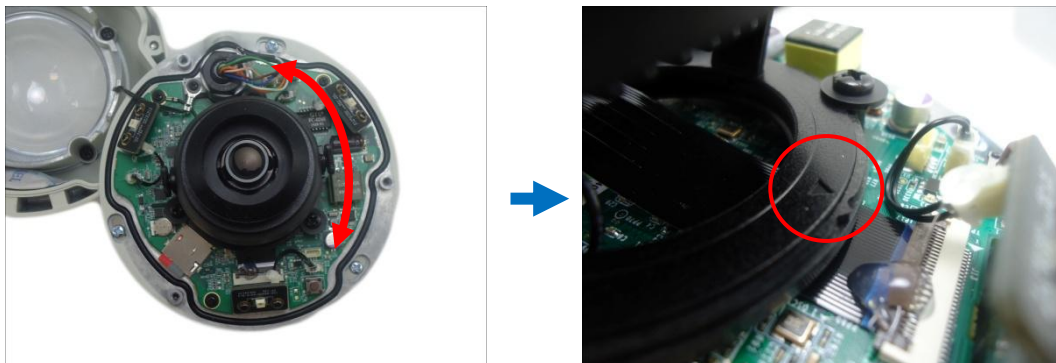

4. Once done, tighten the three (3) screws to fix the lens position.

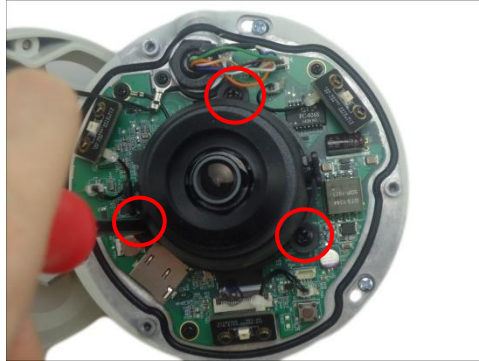

5. Loosen the two (2) tilt adjustment screws.
6. Adjust the tilt and tighten back the screws to fix the tilt position.



7. Close the dome cover.



How to Connect Audio In Device

The camera comes with an audio jack where an audio input device, such as a microphone with a built-in amplifier, can be connected. The audio-in jack is covered by a rubber protection.



WARNING: Do not remove this rubber protection if the audio-in jack will not be used to avoid water or dust from entering the jack.

To connect an audio input device, do the following:

1. Pull to remove the rubber protection.
2. Connect the audio input device.



NOTE: The microphone must have a built-in amplifier. Connecting an ordinary microphone will dwarf sounds and will result in inaudible recording.

3. If the camera is installed outdoors, be sure to wrap the audio connectors with **Waterproof Tape** (can be purchased in hardware stores).

DISCLAIMER: ACTi will not be responsible for camera damage due by water leakage caused by improper waterproofing of cables.

How to Use the IR LED Cover

The IR LEDs provide sufficient light when the camera is in night mode and in a totally dark environment. However, in case the camera is installed close to a wall, a part of the IR LED may be obstructed by the wall and cause reflection. In this case, you may attach the IR LED cover that comes bundled with the camera.

To do this, follow the steps below:

1. Peel off the IR LED cover sticker.



2. Attach the cover to the IR LED window that you want to cover up.



3. Repeat the above procedures to cover another IR LED window, if necessary.

A sample with one IR LED covered is shown below.



How to Replace the Dome Cover

For more discrete surveillance needs, the pre-installed dome cover can be replaced with a smoked, vandal proof dome cover. The smoked dome cover is an optional accessory; contact your sales agent to purchase.

To replace the dome cover, follow the procedures below:

1. Open the dome cover.
2. Detach the screw securing the cover to the camera module.



3. Remove the four (4) screws securing the dome cover bracket.



4. Remove the bracket and then the transparent dome cover.

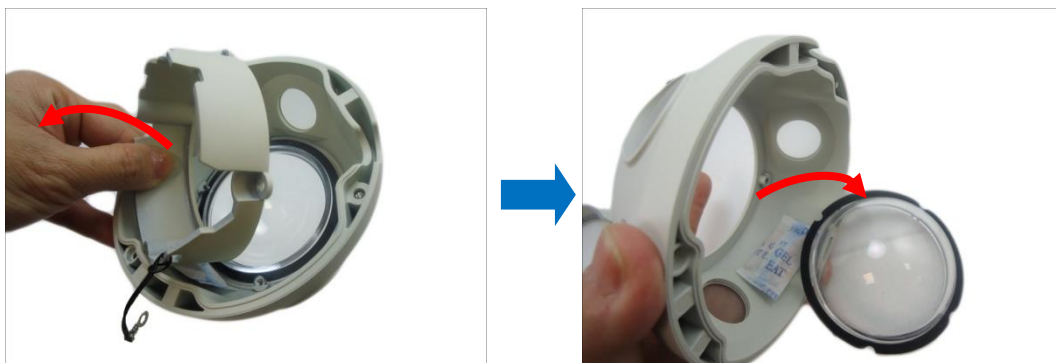

- 5. Remove the black rubber from the transparent dome cover. Below is an example of the detached parts.



- 6. Align and place the rubber on the dome cover housing with the arrow pointing towards the camera logo. Note that the side of the rubber with 3 lines should face the housing while the side with 2 lines should face the camera module.

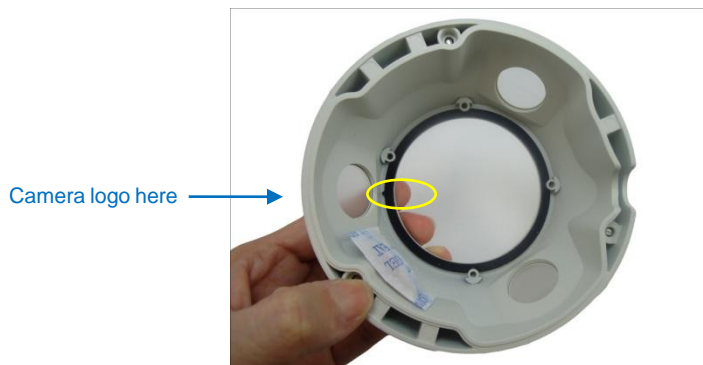

7. Align and place the replacement dome cover with the arrow pointing towards the camera logo.



8. Align and place the dome cover bracket on the housing with the arrow pointing towards the camera logo. Tightly attach the four (4) screws to secure the dome cover bracket to the housing.

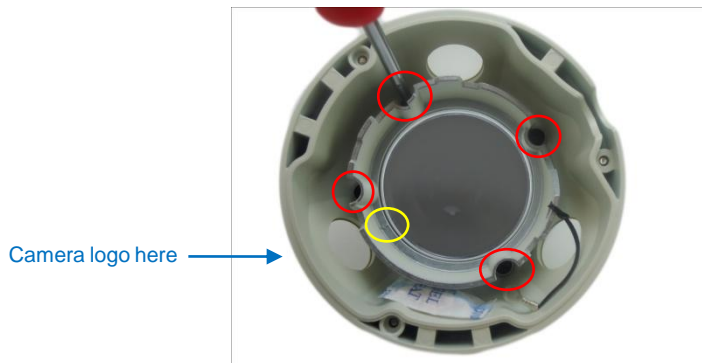

9. Attach the screw to secure the dome cover housing to the camera module.

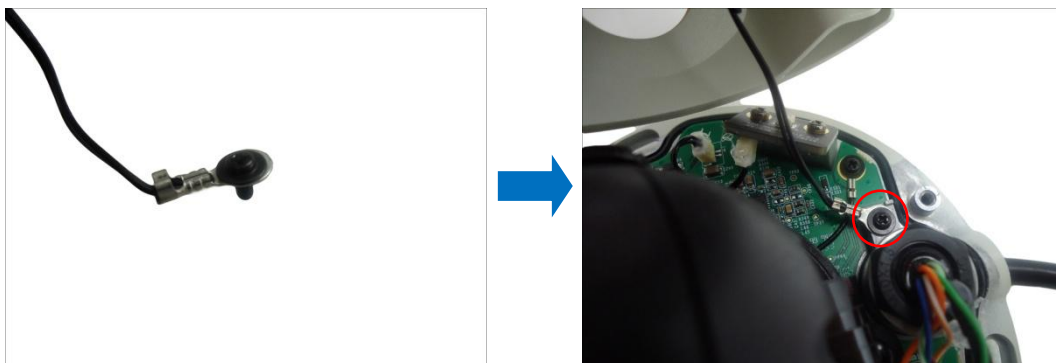

10. Close the dome cover.



Accessing the Camera

Configure the IP Addresses

In order to be able to communicate with the camera from your PC, both the camera and the PC have to be within the same network segment. In most cases, it means that they both should have very similar IP addresses, where only the last number of the IP address is different from each other. There are 2 different approaches to IP Address management in Local Area Networks – by DHCP Server or Manually.

Using DHCP Server to Assign IP Addresses

If you have connected the computer and the camera into the network that has a DHCP server running, then you do not need to configure the IP addresses at all – both the camera and the PC would request a unique IP address from DHCP server automatically. In such case, the camera will immediately be ready for the access from the PC. The user, however, might not know the IP address of the camera yet. It is necessary to know the IP address of the camera in order to be able to access it by using a Web browser.

The quickest way to discover the cameras in the network is to use the simplest network search, built in the Windows system – just by pressing the “Network” icon, all the cameras of the local area network will be discovered by Windows thanks to the UPnP function support of our cameras.

In the example below, we successfully found the camera that we had just connected to the network.

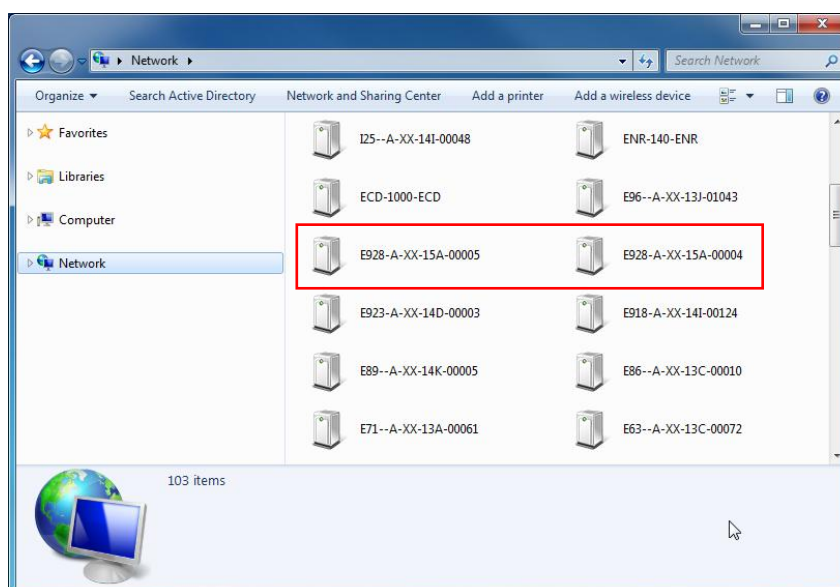

By double-clicking with the left mouse on the camera model, it is possible to automatically launch the default browser of the PC with the IP address of the target camera filled in the address bar of the browser already.

If you work with our cameras regularly, then **there is even a better way to discover the cameras in the network** – by using **IP Utility**. The IP Utility is a light software tool that can not only discover the cameras, but also list lots of valuable information, such as IP and MAC addresses, serial numbers, firmware versions, etc, and allows quick configuration of multiple devices at the same time.

The IP Utility can be downloaded for free from http://www.acti.com/IP_Utility

With just one click, you can launch the IP Utility and there will be an instant report as follows:

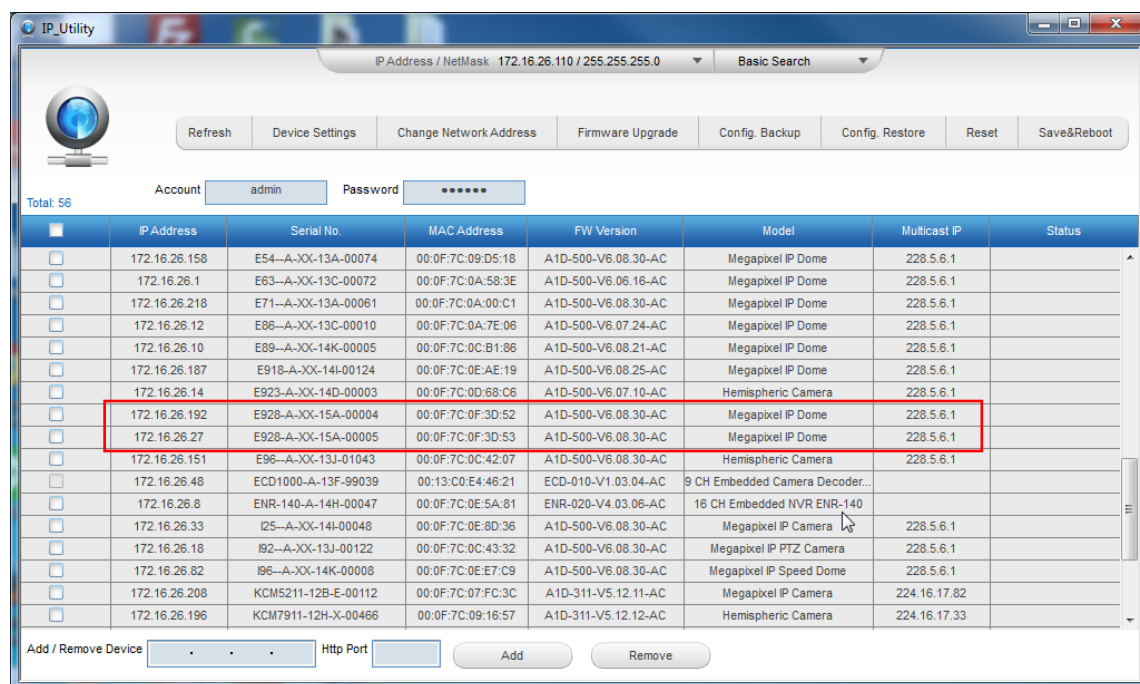

You can quickly see the camera model in the list. Click on the IP address to automatically launch the default browser of the PC with the IP address of the target camera filled in the address bar of the browser already.

Using the Default Camera IP Address

If there is no DHCP server in the given network, the user may have to assign the IP addresses to both PC and camera manually to make sure they are in the same network segment.

When the camera is plugged into network and it does not detect any DHCP services, it will automatically assign itself a default IP:

192.168.0.100

Whereas the default port number would be **80**. In order to access that camera, the IP address of the PC has to be configured to match the network segment of the camera.

Manually adjust the IP address of the PC:

In the following example, based on Windows 7, we will configure the IP address to **192.168.0.99** and set Subnet Mask to **255.255.255.0** by using the steps below:

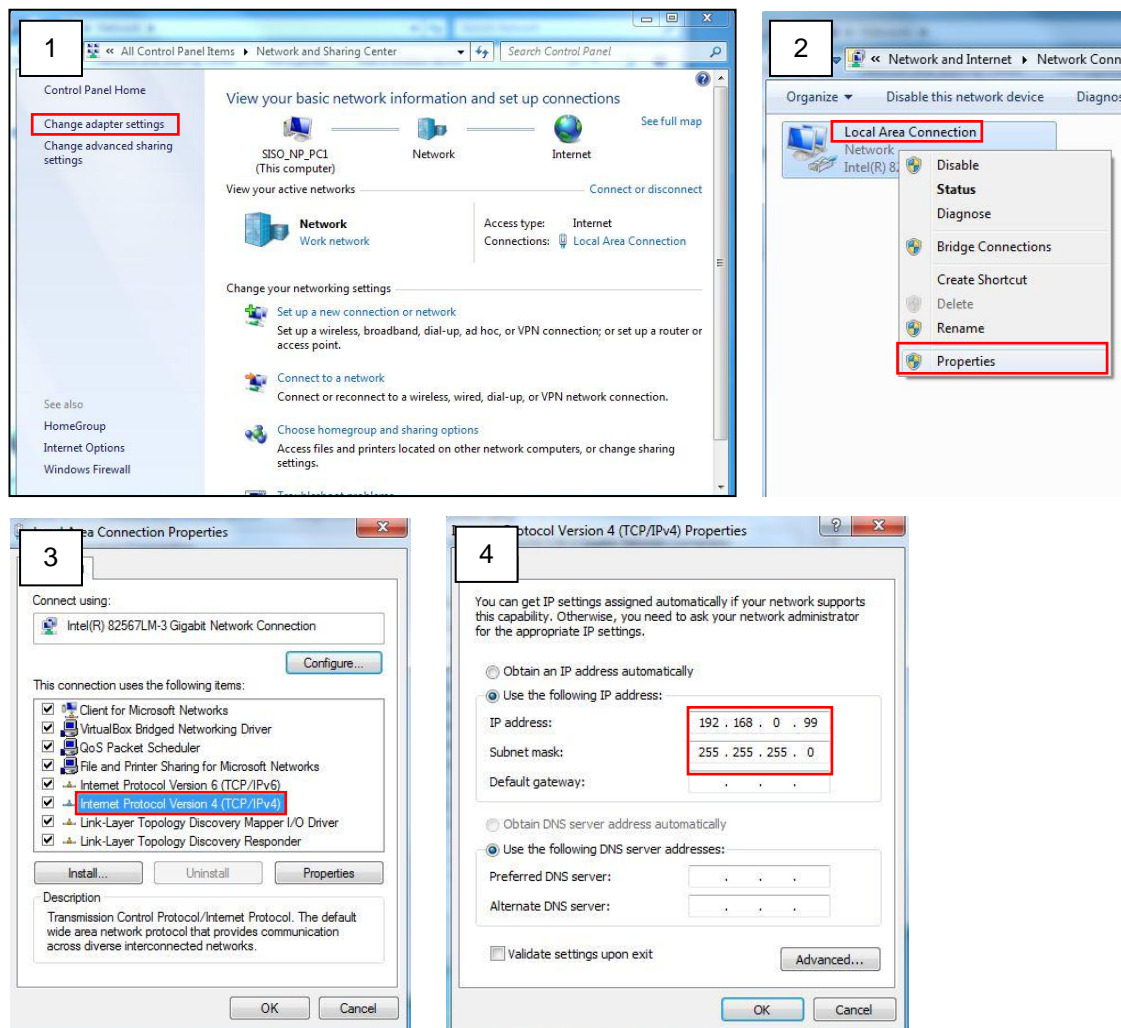

Manually adjust the IP addresses of multiple cameras:

If there are more than 1 camera to be used in the same local area network and there is no DHCP server to assign unique IP addresses to each of them, all of the cameras would then have the initial IP address of **192.168.0.100**, which is not a proper situation for network devices – all the IP addresses have to be different from each other. The easiest way to assign cameras the IP addresses is by using **IP Utility**:

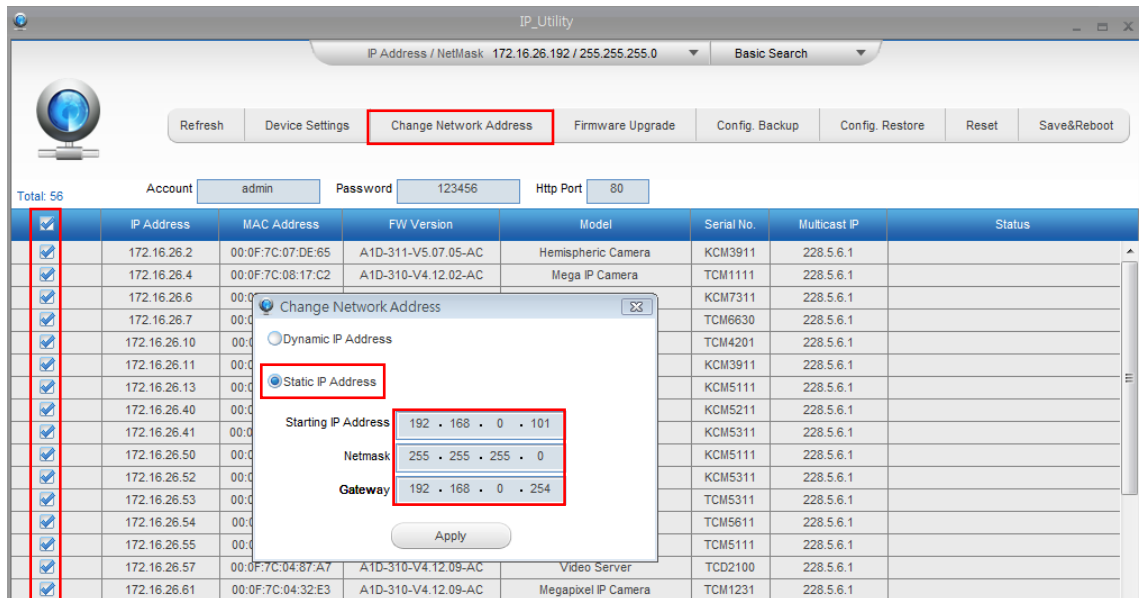

With the procedure shown above, all the cameras will have unique IP addresses, starting from 192.168.0.101. In case there are 20 cameras selected, the last one of the cameras would have the IP 192.168.0.120.

Later, by pressing the “Refresh” button of the IP Utility, you will be able to see the list of cameras with their new IP addresses.

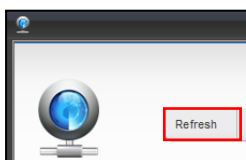

Please note that it is also possible to change the IP addresses manually by using the Web browser. In such case, please plug in only one camera at a time, and change its IP address by using the Web browser before plugging in the next one. This way, the Web browser will not be confused about two devices having the same IP address at the same time.

Access the Camera

Now that the camera and the PC are both having their unique IP addresses and are under the same network segment, it is possible to use the Web browser of the PC to access the camera.

You can use **any of the browsers** to access the camera, however, the full functionality is provided only for **Microsoft Internet Explorer**.

The browser functionality comparison:

Functionality	Internet Explorer	Other browsers
Live Video	Yes	Yes*
Live Video Area Resizable	Yes	No
PTZ Control	Yes	Yes
Capture the snapshot	Yes	Yes
Video overlay based configuration (Motion Detection regions, Privacy Mask regions)	Yes	No
All the other configurations	Yes	Yes

* When using non-Internet Explorer browsers, free third-party software plug-ins must be installed to the PC first to be able to get the live video feed from the camera:

Browser	Required Plug-In
Safari	QuickTime (http://www.apple.com/quicktime/download/)
Other non-Internet Explorer browsers	Basic VLC Media Player (http://www.videolan.org)

***Disclaimer Notice:** The camera manufacturer does not guarantee the compatibility of its cameras with VLC player or QuickTime – since these are third party softwares. The third party has the right to modify their utility any time which might affect the compatibility. In such cases, please use Internet Explorer browser instead.*

When using Internet Explorer browser, the ActiveX control for video stream management will be downloaded from the camera directly – the user just has to accept the use of such control when prompted so. No other third party utilities are required to be installed in such case.

The following examples in this manual are based on Internet Explorer browser in order to cover all functions of the camera.

Assuming that the camera's IP address is **192.168.0.100**, you can access it by opening the Web browser and typing the following address into Web browser's address bar:

http://192.168.0.100

Upon successful connection to the camera, the user interface called **Web Configurator** would appear together with the login page. The HTTP port number was not added behind the IP address since the default HTTP port of the camera is 80, which can be omitted from the address for convenience.

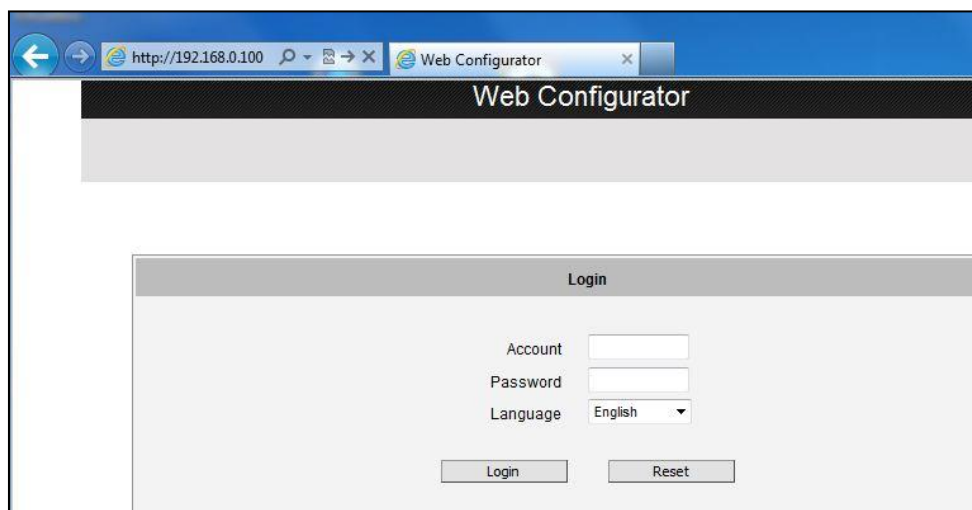

Before logging in, you need to know the factory default Account and Password of the camera.

Account: **Admin**

Password: **123456**



Copyright © 2015, ACTi Corporation All Rights Reserved

7F, No. 1, Alley 20, Lane 407, Sec. 2, Ti-Ding Blvd., Neihu District, Taipei, Taiwan 114, R.O.C.

TEL : +886-2-2656-2588 FAX : +886-2-2656-2599

Email: sales@acti.com