

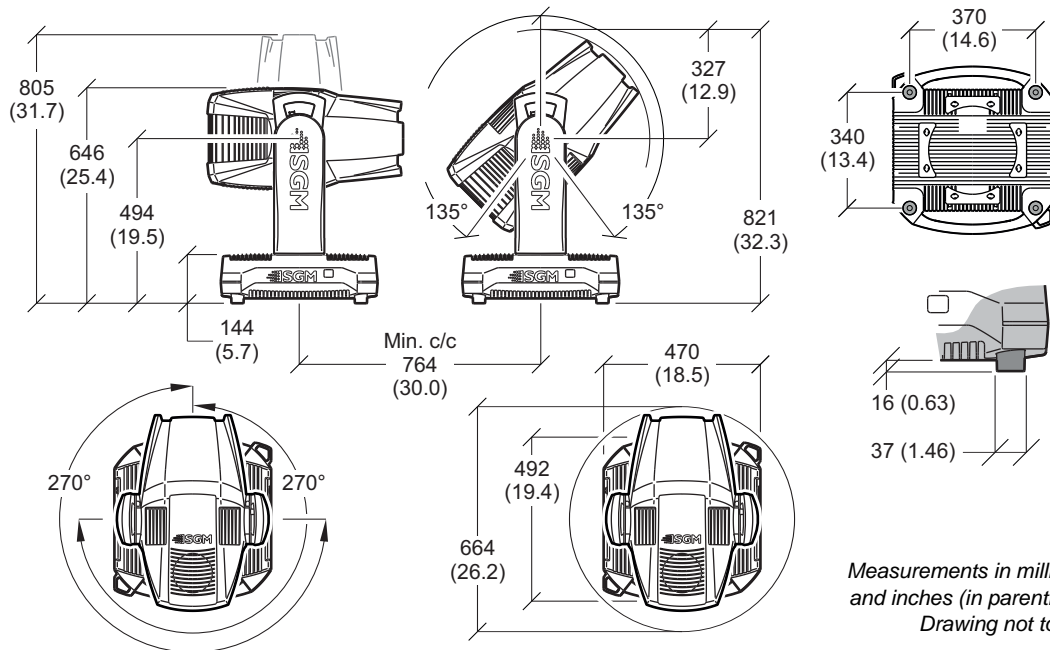

**G-SPOT
MOVING HEAD**



Dimensions



G-SPOT USER MANUAL

© 2014 SGM®. Information subject to change without notice. SGM and all affiliated companies disclaim liability for any injury, damage, direct or indirect loss, consequential or economic loss or any other loss occasioned by the use of, inability to use or reliance on the information contained in this manual.

The SGM logo, the SGM name and all other trademarks in this document pertaining to services or products by SGM or its affiliates and subsidiaries are trademarks owned or licensed by SGM or its affiliates or subsidiaries.

The original edition of this document is in English. All other language editions are translations of the original edition.

This edition applies to firmware version 1.00 or later.

REV. 4

Contents

Dimensions	2
Safety information	6
Overview	8
Unpacking	9
<i>Transportation</i>	9
Installation / Rigging	10
Connecting AC power	12
Control panel operations	13
<i>Using the control panel</i>	13
<i>DMX start address</i>	13
Control panel menus	14
Gobo replacement	20
<i>Identification of gobo wheel</i>	20
<i>Replacing rotating gobos</i>	21
<i>How to replace a gobo in a gobo holder</i>	22

Maintenance	23
<i>Upgrading the firmware</i>	23
<i>Cleaning</i>	23
DMX protocols	24
Effects	40
<i>Two independent rotating gobo wheels</i>	40
<i>Effect wheels</i>	40
<i>High-precision pan and tilt</i>	40
<i>Ultra high-speed strobe effect</i>	40
<i>Prism</i>	40
<i>Frost</i>	40
Devices and accessories	41
<i>Included items</i>	41
<i>Ordering information</i>	41
User's notes	43

Safety information



WARNING! Read the safety precautions in this section before unpacking, installing, powering or operating this product.

The G-SPOT is intended for professional use only. It is not suitable for household use.

Impropre a l'usage domestique.

Review the following safety precautions carefully before installing or operating the device.

This product must be installed in accordance with the applicable installation code by a person familiar with the construction and operation of the product and the hazards involved.

Preventing electric shock



WARNING! Risk of electric shock.

- Always power off/unplug the device before removing covers or dismantling product.
- Ensure that the mains power is off when wiring the device to the AC mains supply.
- Ensure that the device is electrically connected to earth (ground).
- Do not apply power if the device is in any way damaged.
- Do not immerse the device in water or liquid.

Avoid personal injury



WARNING! Take measures to prevent burns and fire.

- Install in a location that prevents accidental contact with the device.
- Install device at least 0.3 m (11 in.) away from any flammable materials.
- Do not cover fans, and keep fans clean.
- Allow the device to cool after operation.

CAUTION: Exterior surface temperature after 5 min. operation = 55° C (131° F). Steady state = 65° C (149° F)

Preventing burns and fire



WARNING! Take measures to prevent personal injury.

- Do not look directly at the light source from close range.
- Take precautions to prevent injury when working at height.
- Ensure that the device is always securely fastened with suitable hardware.
- For elevated installations, secure the device with suitable safety cables, and always comply with relevant load dimensioning, safety standards and requirements.

Overview

The SGM G-Spot model is a maintenance free, multi-environmental device with an IP-rating of 65. It has a powerful LED light source, and a virtually unlimited color palette, two independent rotating gobo wheels and can easily be controlled by wired and wireless DMX. The device also offers RFID and NFC, low power consumption and an expected lifetime of the multiple LED's of 50,000 hours.*

- A : Pan lock
- B : Tilt lock
- C : Yoke handle
- D : Base handle
- E : Head fan grill (one of two shown)
- F : Display panel
- G : Safety wire attachment point
- H : Fuse
- I : DMX in
- J : DMX out
- K : Power in
- L : Power cord

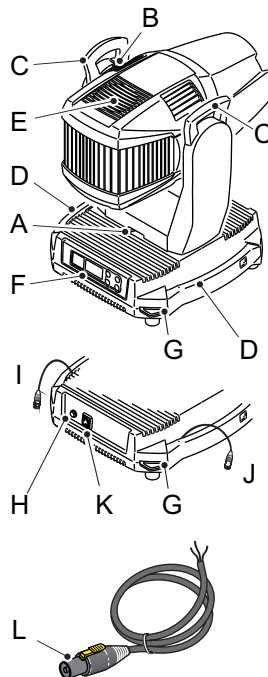

* At 70% of luminous output under the manufacturer's test conditions.

Unpacking

Unpack the device and inspect it to ensure that it has not been damaged in transport.

The G-Spot is supplied with:

- User manual.
- One Neutrik TRUE1 power input connector, 2 m (78 in.)
- Two Omega brackets with 1/4-turn fasteners.

The device is designed for use in wet locations and is IP65-rated. When selecting a location for the device, ensure that:

- it is situated away from public thoroughfares and protected from contact with people.
- it has adequate ventilation.

Transportation

Always use the supplied packaging for transportation and storage.

Release the pan/tilt locks when transporting the device. Leaving the pan/tilt locks applied may cause damage to the device.

Installation / Rigging



WARNING! Always secure elevated devices with a safety cable.

The G-Spot may be installed in any orientation.

Always use two Omega brackets to rig the device. Lock each bracket with both 1/4-turn fasteners. The fasteners are locked only when turned fully clockwise.

Always fasten safety cables between the load-bearing support structure and the attachment points on the device. The safety cables must be able to bear at least 10 times the weight of the device.

CAUTION:

- Always use two safety wires.
- Min. safety wire gauge = 5 mm.
- Max. safety wire length (free fall) = 30 cm (11 in.)
- Make sure the slack of the safety wire is at a minimum.
- Never use the carrying handles for secondary attachment.

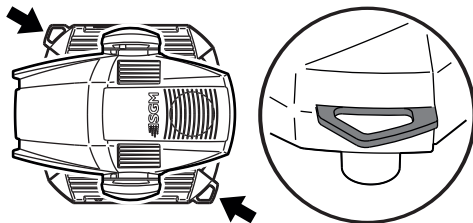
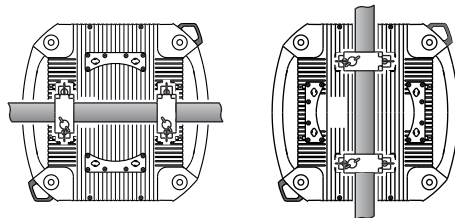

Start the rigging process by blocking the work area below, and make sure the work is performed from a stable platform.

- 1 Check that the clamps are undamaged and can bear at least 10 times the weight of the device. Check that the structure can bear at least 10 times the weight for all installed devices, clamps, cables etc.
- 2 Bolt each clamp securely to an Omega bracket with an M12 / 1/2" bolt (min. grade 8.8) and lock nut.
- 3 Align an Omega bracket with two 1/4-turns in the base. Insert the fasteners into the base and turn both levers a full 1/4-turn clockwise to lock. Install the second Omega bracket.
- 4 Working from a stable platform, hang the device on a truss, or other structure. Note the position of the base. The front of the base is to the right, when looking at the display panel, and when the device is sitting on the base. Tighten the clamps.
- 5 Install two safety wires that each can bear at least 10 times the weight of the unit. The attachment points are designed to fit a carabiner.
- 6 Check that the pan/tilt locks are released (A and B). Verify that there are no combustible materials or surfaces to be illuminated within 0.3 m (11 in.) of the device.
- 7 Check that there is no possibility of head or yoke colliding with other devices.

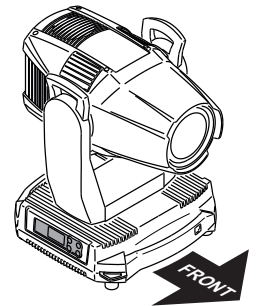
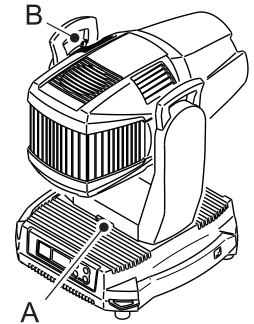



Connecting AC power

The G-Spot can operate on any 200-240V, 50/60 Hz mains power supply

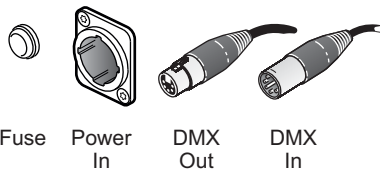
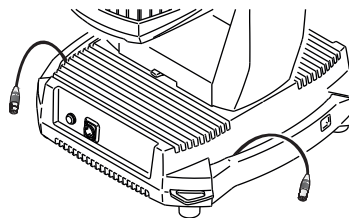
Connect the device to power using a cable with a Neutrik powerCON TRUE1 connector (supplied with the device). Connect both DMX in and DMX out cables in order to maintain the device IP65.



The device must be grounded/earthed and be able to be isolated from AC power. The AC power supply must incorporate a fuse or circuit breaker for fault protection.

<i>Wire</i>	<i>Color</i>	<i>Symbol</i>	<i>Conductor</i>
	Brown	L	live
	Blue	N	neutral
	green/yellow	⏏ or ⏚	ground (earth)

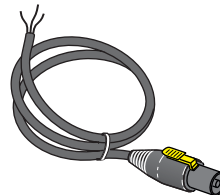

Control panel operations

You can configure individual device settings, read out data and view error messages in the graphic display.

When the device is powered on, it boots and resets, then displays the DMX start address and any status messages.

Using the control panel

- Click the arrow buttons to scroll up and down menus.
- Click the OK button to enter a menu or make a selection.
- Press the ESC button to step backwards through the menus.

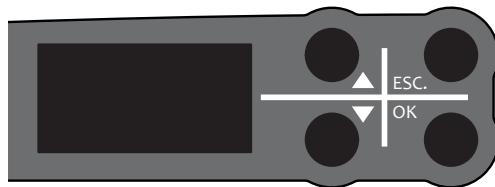

DMX start address

The DMX start address is the first channel used to receive instructions from the controller. For independent control, each device must be assigned its own start address. If you give two devices the same address, they will behave identically. Address sharing can be useful for diagnostic purposes and symmetrical control.

Select DMX address using the arrow buttons.

Control panel menus

Level 1	Level 2	Level 3	Level 4	Info
DMX MODE	STANDARD			
	EXTENDED			
INFO	GENERAL INFO	PRODUCT: SN: RDM LABEL RDM ID		
	SOFTWARE VERSION	MAIN: SMPS: PAN: TILT: GOBO: ZOOM:		
	TIMERS	RED GREEN BLUE RUNNING HOURS	D: H: D: H: D: H: D: H:	

Level 1	Level 2	Level 3	Level 4	Info
INFO (continued)	DMX VIEW	001 - ↓ 507 -		
	TEMPERATURES	LED SMPS PAN: GOBO: BASE: HUMIDITY	R: G: B: TILT: FOCUS: HEAD: B: H:	
	FANS	LED FAN 1: LED FAN 2: HEAD: BASE:	rpm rpm rpm rpm	
	LOG	FIRMWARE: BUILD: BUILD: UPTIME:	 D: H: M: S:	

Level 1	Level 2	Level 3	Level 4	Info
INFO (continued)	DEBUG	0 - ↓ 54 -		
	ERRORS	SMPS PAN TILT GOBO ZOOM		
SETTINGS	WIRELESS DMX	LOG OFF		
		STATUS	SIGNAL STRENGTH: % CRMX PAIRD: RDM ACTIVE: DMX ACTIVE: CRMX RATE: Hz	
		ENABLE/DISABLE		
		CRMX → DMX		

Level 1	Level 2	Level 3	Level 4	Info	
SETTINGS (continued)	DIMMING CURVE	LINEAR ()			
		GAMMA CORRECTED (x)			
	INVERT PAN ()				
	INVERT TILT ()				
	SWAP PAN TILT ()				
	FLIP DISPLAY ()				
	DISPLAY OFF ()				
	FAN MODE	LINEAR (X)			
		GAMMA CORRECTED ()			
		MAX POWER ()			
		ALWAYS 100% ()			
	CALIBRATION	PAN HOME		CALIBRATION → xxxxx PAN POS xxxxx - Rev. x.xx	
				CALIBRATION → xxxxx PAN POS xxxxx - Rev. x.xx	
TILT HOME			CALIBRATION → xxxxx PAN POS xxxxx - Rev. x.xx		
GOBO 1 SELECT			CALIBRATION → xxxxx		
GOBO 2 SELECT			CALIBRATION → xxxxx		
EFFECT WHEEL 1		CALIBRATION → xxxxx			

Level 1	Level 2	Level 3	Level 4	Info
SETTINGS (continued)	CALIBRATION (continued)	EFFECT WHEEL 2	CALIBRATION → xxxxx	
		FROST	CALIBRATION → xxxxx	
		PRISM	CALIBRATION → xxxxx	
		IRIS	CALIBRATION → xxxxx	
		ZOOM	CALIBRATION → xxxxx	
		FOCUS	CALIBRATION → xxxxx	
	FACTORY DEFAULT	FACTORY DEFAULT SET		
TEST	OFF			
	LED TEST	TESTING RED 2		
		TESTING RED 1		
		TESTING BLUE 2		
		TESTING BLUE 1		
		TESTING YELLOW		
	TESTING GREEN			
DISPLAY TEST				

Level 1	Level 2	Level 3	Level 4	Info
RESET	PAN TILT			
	GOBO MODULE			
	ZOOM FOCUS MODULE			
	ALL			

Gobo replacement

Identification of gobo wheel

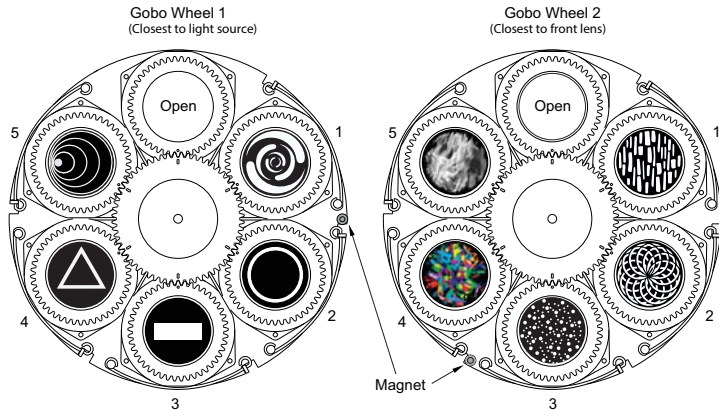

Gobo Wheel 1:		
No.	Description	Part No.
Open	Open gobo	37000001
1	Spin cycle	37005002
2	Ring	37005007
3	Bar	37005008
4	Triangle	37005009
5	Concentric	37005004

Gobo Wheel 2:		
No.	Description	Part No.
Open	Open gobo	37000001
1	Breakup bricks	37005006
2	Spiral leaf	37005010
3	Dots	37005003
4	Kaleidoscope gems	37002001
5	Fire up close	37005001

Replacing rotating gobos

To replace one or more gobos:

- Disconnect the device from power and allow to cool.
- Position the head and apply the tilt lock.
- Before removing one of the rear head covers, identify where gobo wheel covers 1 and 2 are positioned. When the head of the device is facing upwards, cover gobo wheel 2 is located at the side of the head corresponding to the pan lock (A). See figure below.
- Remove the relevant rear head cover.
- Remove the gobo wheel cover for access to the gobo wheel.
- Turn the relevant gobo wheel until the gobo you want to replace is accessible.
- Unhook the end of the spring and turn it upwards. Pull the gobo holder out of the gobo wheel.

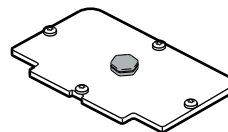
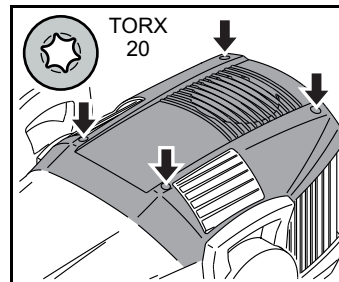

Cover Gobo Wheel 1

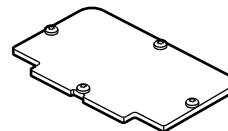

Cover Gobo Wheel 2

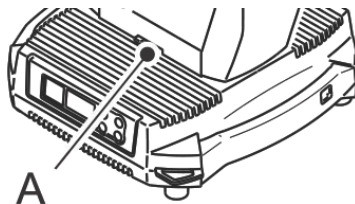

How to replace a gobo in a gobo holder

- Place gobo with silver side towards the light source.
- Align index markers on the gobo and the gobo holder as shown below.
- Insert the gobo holder and align it with the index marker on the gobo wheel as shown below. If necessary, continue replacing gobos one by one as described above. If no further service is necessary, reinstall the gobo wheel cover. To maintain the device's IP65 rating, it is important to fasten the gobo covers to 1 Nm.

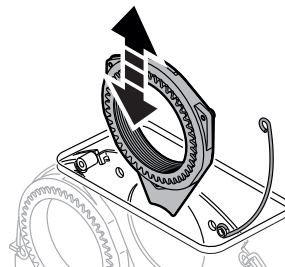
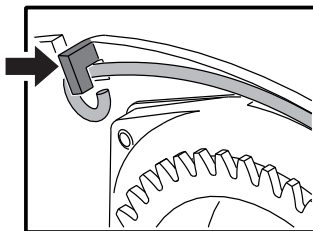
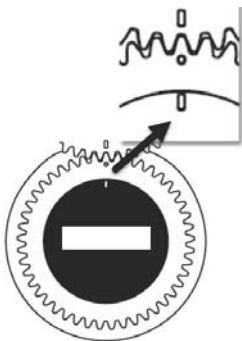
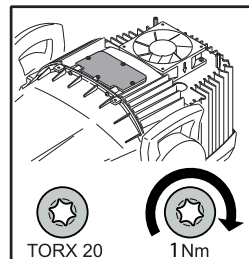

Maintenance

When cleaning the device, do not use any product that contains abrasives or solvents that can damage plastic or painted surfaces. Use a clean cloth with water and a standard household cleaner.

To maintain adequate cooling, fans must be cleaned periodically.

Upgrading the firmware

The firmware installed on the device can be identified using the “Info→Software version” menu. We recommend that you keep your device’s firmware up-to-date. Visit <http://www.sgmlight.com> to download the latest firmware.

To perform firmware updates, you need a Windows-based personal computer and a SGM USB 5-Pin-XLR upload cable (available from your SGM distributor).

Cleaning

To maintain optimal performance, regular cleaning is essential. Cleaning schedules will vary greatly depending on the operating environment, and the installation should therefore be checked at frequent intervals within the first few weeks of operation to see whether cleaning is necessary. This procedure will allow you to assess cleaning requirements in your particular situation. If in doubt, consult your SGM dealer for a suitable maintenance schedule.

DMX protocols

24 Channel Mode (Standard)									
Channel	Name	DMX Value		DMX Percentage		Description	Info	Default DMX value	Fader type
1	Shutter	0	7	0,0%	2,7%	Closed		10 (3,9%)	Snap
		8	15	3,1%	5,9%	Open			
		16	151	6,3%	59,2%	Strobe	Slow > Fast		
		152	175	59,6%	68,6%	Pulse - Open	Slow > Fast		
		176	199	69,0%	78,0%	Pulse - Close	Slow > Fast		
		200	244	78,4%	95,7%	Strobe - Random	Slow > Fast		
		245	255	96,1%	100,0%	Open			
2	Intensity	0	255	0,0%	100,0%	No light > Maximum light		0 (0%)	Fade
3	Red	0	255	0,0%	100,0%	No RED > Maximum RED		0 (0%)	Fade
4	Green	0	255	0,0%	100,0%	No GREEN > Maximum GREEN		0 (0%)	Fade
5	Blue	0	255	0,0%	100,0%	No BLUE > Maximum BLUE		0 (0%)	Fade

24 Channel Mode (Standard)									
6	CTC	0	4	0,0%	1,6%	No CTC		0 (0%)	Fade
		5	5	2,0%	2,0%	≈ 2000° K			
		15	15	5,9%	5,9%	≈ 2200° K (High pressure sodium lamp)			
		40	40	15,7%	15,7%	≈ 2700° K (Incandescent lamp)			
		54	54	21,2%	21,2%	≈ 3000° K (Halogen / Tungsten lamp)			
		65	65	25,5%	25,5%	≈ 3200° K (Warm metal halide lamp)			
		105	105	41,2%	41,2%	≈ 4000° K (Clear metal halide lamp)			
		115	115	45,1%	45,1%	≈ 4200° K (Cool white fluorescent lamp)			
		177	177	69,4%	69,4%	≈ 5500° K (Daylight metal halide lamp)			
		216	216	84,7%	84,7%	≈ 6300° K			
		238	238	93,3%	93,3%	≈ 8000° K			
		255	255	100,0%	100,0%	≈ 10,000° K			

24 Channel Mode (Standard)									
7 8	Pan	0	65535	0,0%	100,0%	-270° to 270°	-270° = Front lens @ mains power input (Tilt=0)	32767 (50%)	Fade
9 10	Tilt	0	65535	0,0%	100,0%	-120° to 120°	-120° = Front lens @ base front (Pan=32767)	32767 (50%)	Fade
11	Gobo Wheel 1 (Closest to light source)	0	20	0,0%	7,8%	Open		0 (0%)	Snap
		21	41	8,2%	16,1%	Gobo 1 - Position 1			
		42	62	16,5%	24,3%	Gobo 1 - Position 2			
		63	83	24,7%	32,5%	Gobo 1 - Position 3			
		84	104	32,9%	40,8%	Gobo 1 - Position 4			
		105	127	41,2%	49,8%	Gobo 1 - Position 5			
		128	191	50,2%	74,9%	Gobo Wheel Continuous rotation CW	Fast > Slow		
		192	192	75,3%	75,3%	No rotation			
		193	255	75,7%	100,0%	Gobo Wheel Continuous rotation CCW	Slow > Fast		

24 Channel Mode (Standard)									
12 13	Gobo Wheel 1 Indexing Rotation Shake	0	32767	0,0%	50,0%	Gobo Index		0 (0%)	Fade
		32768	32799	50,0%	50,0%	No Effect			
		32800	46418	50,0%	70,8%	Gobo Continuous rotation CW	Fast > Slow		
		46419	46919	70,8%	71,6%	No rotation			
		46920	60538	71,6%	92,4%	Gobo Continuous rotation CCW	Slow > Fast		
		60539	65535	92,4%	100,0%	Gobo shake	Slow > Fast		
14	Gobo Wheel 2 (Closest to light source)	0	20	0,0%	7,8%	Open		0 (0%)	Snap
		21	41	8,2%	16,1%	Gobo 1 - Position 1			
		42	62	16,5%	24,3%	Gobo 1 - Position 2			
		63	83	24,7%	32,5%	Gobo 1 - Position 3			
		84	104	32,9%	40,8%	Gobo 1 - Position 4			
		105	127	41,2%	49,8%	Gobo 1 - Position 5			
		128	191	50,2%	74,9%	Gobo Wheel Continuous rotation CW	Fast > Slow		
		192	192	75,3%	75,3%	No rotation			
		193	255	75,7%	100,0%	Gobo Wheel Continuous rotation CCW	Slow > Fast		

24 Channel Mode (Standard)									
15 16	Gobo Wheel 2 Indexing Rotation Shake	0	32767	0,0%	50,0%	Gobo Index		0 (0%)	Fade
		32768	32799	50,0%	50,0%	No Effect			
		32800	46418	50,0%	70,8%	Gobo Continuous rotation CW	Fast > Slow		
		46419	46919	70,8%	71,6%	No rotation			
		46920	60538	71,6%	92,4%	Gobo Continuous rotation CCW	Slow > Fast		
		60539	65535	92,4%	100,0%	Gobo shake	Slow > Fast		
17	Iris	0	200	0,0%	78,4%	Open > Close		0 (0%)	Fade
		201	205	78,8%	80,4%	Effect - "Open fast / Close slow"			
		206	210	80,8	82,4%	Effect - "Open slow / Close fast"			
		211	215	82,7%	84,3%	Effect - "Open / Close"			
		216	255	84,7%	100,0%	Effect - "Random Close / Open"	Slow > Fast		

24 Channel Mode (Standard)									
18	Effect Wheel	0	4	0,0%	1,6%	Open		0 (0%)	Fade
		5	127	2,0%	49,8%	Indexed			
		128	153	50,2%	60,0%	Continuous rotation CW	Fast > Slow		
		154	179	60,4%	70,2%	Continuous rotation CCW	Slow > Fast		
		180	255	70,6%	100,0%	Reserved (Calibration position)			
19	Prism	0	4	0,0%	1,6%	Open		0 (0%)	Fade
		5	129	2,0%	50,6%	Continuous rotation CW	Fast > Slow		
		130	130	51,0%	51,0%	No rotation			
		131	255	51,4%	100,0%	Continuous rotation CCW	Slow > Fast		
20	Frost	0	5	0,0%	2,0%	Open		0 (0%)	Fade
		6	255	2,4%	100,0%	No frost > Maximum Frost			
21	Zoom	0	255	0,0%	100,0%	Wide > Narrow		0 (0%)	Fade
22	Focus	0	255	0,0%	100,0%	Far > Near		0 (0%)	Fade

24 Channel Mode (Standard)

23	Effect Channel	0	4	0,0%	1,6%	No Effect	0 (0%)	Snap
		5	15	2,0%	5,9%	Reserved (No effect)		
		16	26	6,3%	10,2%	Reserved (No effect)		
		27	32	10,6%	12,5%	Shutter Black = RED		
		33	38	12,9%	14,9%	Shutter Black = GREEN		
		39	44	15,3%	17,3%	Shutter Black = BLUE		
		45	50	17,6%	19,6%	Shutter Black = WHITE		
		51	56	20,0%	22,0%	Shutter Black = Magenta		
		57	62	22,4%	24,3%	Shutter Black = Yellow		
		63	68	24,7%	26,7%	Shutter Black = Cyan		
		69	255	27,1%	100,0%	Reserved (No effect)		

24 Channel Mode (Standard)								
24	Control Channel	0	4	0,0%	1,6%	No Function		Snap
		5	9	2,0%	3,5%	Full Reset	Hold 3 seconds	
		10	14	3,9%	5,5%	Pan Reset	Hold 3 seconds	
		15	19	5,9%	7,5%	Tilt Reset	Hold 3 seconds	
		20	24	7,8%	9,4%	Gobo Reset	Hold 3 seconds	
		25	29	9,8%	11,4%	Zoom Reset	Hold 3 seconds	
		30	34	11,8%	13,3%	Sleep Mode	See note ¹	
		35	39	13,7%	15,3%	Display Off	Hold 3 seconds	
		40	44	15,7%	17,3%	Display On	Hold 3 seconds	
		45	255	17,6%	100,0%	Reserved (No function)		

1. All other channels must be zero and this has to be held for 30 sec. (fixture will wake up on a full reset).

30 Channel Mode (Extended)

Channel	Name	DMX Value	DMX Percentage	Description	Info	Default DMX value
1	Shutter	0 7	0,0% 2,7%	Closed		10 (3,9%)
		8 15	3,1% 5,9%	Open		
		16 151	6,3% 59,2%	Strobe	Slow > Fast	
		152 175	59,6% 68,6%	Pulse - Open	Slow > Fast	
		176 199	69,0% 78,0%	Pulse - Close	Slow > Fast	
		200 244	78,4% 95,7%	Strobe - Random	Slow > Fast	
		245 255	96,1% 100,0%	Open		
2 3	Intensity	0 255	0,0% 100,0%	No light > Maximum light		0 (0%)
4 5	Red	0 255	0,0% 100,0%	No RED > Maximum RED		0 (0%)
6 7	Green	0 255	0,0% 100,0%	No GREEN > Maximum GREEN		0 (0%)
8 9	Blue	0 255	0,0% 100,0%	No BLUE > Maximum BLUE		0 (0%)

30 Channel Mode (Extended)							
10	CTC	0	4	0,0%	1,6%	No CTC	0 (0%)
		5	5	2,0%	2,0%	≈ 2000° K	
		15	15	5,9%	5,9%	≈ 2200° K (High pressure sodium lamp)	
		40	40	15,7%	15,7%	≈ 2700° K (Incandescent lamp)	
		54	54	21,2%	21,2%	≈ 3000° K (Halogen / Tungsten lamp)	
		65	65	25,5%	25,5%	≈ 3200° K (Warm metal halide lamp)	
		105	105	41,2%	41,2%	≈ 4000° K (Clear metal halide lamp)	
		115	115	45,1%	45,1%	≈ 4200° K (Cool white fluorescent lamp)	
		177	177	69,4%	69,4%	≈ 5500° K (Daylight metal halide lamp)	
		216	216	84,7%	84,7%	≈ 6300° K	
		238	238	93,3%	93,3%	≈ 8000° K	
		255	255	100,0%	100,0%	≈ 10,000° K	

30 Channel Mode (Extended)								
11 12	Pan	0	65535	0,0%	100,0%	-270° to 270°	-270° = Front lens @ mains power input (Tilt=0)	32767 (50%)
13 14	Tilt	0	65535	0,0%	100,0%	-120° to 120°	-120° = Front lens @ base front (Pan=32767)	32767 (50%)
15	Gobo Wheel 1 (Closest to light source)	0	20	0,0%	7,8%	Open		0 (0%)
		21	41	8,2%	16,1%	Gobo 1 - Position 1		
		42	62	16,5%	24,3%	Gobo 1 - Position 2		
		63	83	24,7%	32,5%	Gobo 1 - Position 3		
		84	104	32,9%	40,8%	Gobo 1 - Position 4		
		105	127	41,2%	49,8%	Gobo 1 - Position 5		
		128	191	50,2%	74,9%	Gobo Wheel Continuous rotation CW	Fast > Slow	
		192	192	75,3%	75,3%	No rotation		
		193	255	75,7%	100,0%	Gobo Wheel Continuous rotation CCW	Slow > Fast	

30 Channel Mode (Extended)								
16 17	Gobo Wheel 1 Indexing Rotation Shake	0	32767	0,0%	50,0%	Gobo Index		0 (0%)
		32768	32799	50,0%	50,0%	No Effect		
		32800	46418	50,0%	70,8%	Gobo Continuous rotation CW	Fast > Slow	
		46419	46919	70,8%	71,6%	No rotation		
		46920	60538	71,6%	92,4%	Gobo Continuous rotation CCW	Slow > Fast	
		60539	65535	92,4%	100,0%	Gobo shake	Slow > Fast	
18	Gobo Wheel 2 (Closest to light source)	0	20	0,0%	7,8%	Open		0 (0%)
		21	41	8,2%	16,1%	Gobo 1 - Position 1		
		42	62	16,5%	24,3%	Gobo 1 - Position 2		
		63	83	24,7%	32,5%	Gobo 1 - Position 3		
		84	104	32,9%	40,8%	Gobo 1 - Position 4		
		105	127	41,2%	49,8%	Gobo 1 - Position 5		
		128	191	50,2%	74,9%	Gobo Wheel Continuous rotation CW	Fast > Slow	
		192	192	75,3%	75,3%	No rotation		
		193	255	75,7%	100,0%	Gobo Wheel Continuous rotation CCW	Slow > Fast	

30 Channel Mode (Extended)								
19 20	Gobo Wheel 2 Indexing Rotation Shake	0	32767	0,0%	50,0%	Gobo Index		0 (0%)
		32768	32799	50,0%	50,0%	No Effect		
		32800	46418	50,0%	70,8%	Gobo Continuous rotation CW	Fast > Slow	
		46419	46919	70,8%	71,6%	No rotation		
		46920	60538	71,6%	92,4%	Gobo Continuous rotation CCW	Slow > Fast	
		60539	65535	92,4%	100,0%	Gobo shake	Slow > Fast	
21	Iris	0	200	0,0%	78,4%	Open > Close		0 (0%)
		201	205	78,8%	80,4%	Effect - "Open fast / Close slow"		
		206	210	80,8	82,4%	Effect - "Open slow / Close fast"		
		211	215	82,7%	84,3%	Effect - "Open / Close"		
		216	255	84,7%	100,0%	Effect - "Random Close / Open"	Slow > Fast	

30 Channel Mode (Extended)								
22	Effect Wheel	0	4	0,0%	1,6%	Open	0 (0%)	
		5	127	2,0%	49,8%	Indexed		
		128	153	50,2%	60,0%	Continuous rotation CW		Fast > Slow
		154	179	60,4%	70,2%	Continuous rotation CCW		Slow > Fast
		180	255	70,6%	100,0%	Reserved (Calibration position)		
23	Prism	0	4	0,0%	1,6%	Open	0 (0%)	
		5	129	2,0%	50,6%	Continuous rotation CW		Fast > Slow
		130	130	51,0%	51,0%	No rotation		
		131	255	51,4%	100,0%	Continuous rotation CCW		Slow > Fast
24	Frost	0	5	0,0%	2,0%	Open	0 (0%)	
		6	255	2,4%	100,0%	No frost > Maximum Frost		
25	Zoom	0	255	0,0%	100,0%	Wide > Narrow	0 (0%)	
26								
27	Focus	0	255	0,0%	100,0%	Far > Near	0 (0%)	
28								

30 Channel Mode (Extended)

29	Effect Channel	0	4	0,0%	1,6%	No Effect		0 (0%)
		5	15	2,0%	5,9%	Reserved (No effect)		
		16	26	6,3%	10,2%	Reserved (No effect)		
		27	32	10,6%	12,5%	Shutter Black = RED		
		33	38	12,9%	14,9%	Shutter Black = GREEN		
		39	44	15,3%	17,3%	Shutter Black = BLUE		
		45	50	17,6%	19,6%	Shutter Black = WHITE		
		51	56	20,0%	22,0%	Shutter Black = Magenta		
		57	62	22,4%	24,3%	Shutter Black = Yellow		
		63	68	24,7%	26,7%	Shutter Black = Cyan		
		69	255	27,1%	100,0%	Reserved (No effect)		

30 Channel Mode (Extended)							
30	Control Channel	0	4	0,0%	1,6%	No Function	
		5	9	2,0%	3,5%	Full Reset	Hold 3 seconds
		10	14	3,9%	5,5%	Pan Reset	Hold 3 seconds
		15	19	5,9%	7,5%	Tilt Reset	Hold 3 seconds
		20	24	7,8%	9,4%	Gobo Reset	Hold 3 seconds
		25	29	9,8%	11,4%	Zoom Reset	Hold 3 seconds
		30	34	11,8%	13,3%	Sleep Mode	See note ¹
		35	39	13,7%	15,3%	Display Off	Hold 3 seconds
		40	44	15,7%	17,3%	Display On	Hold 3 seconds
		45	255	17,6%	100,0%	Reserved (No function)	

1. All other channels must be zero and this has to be held for 30 sec. (device will wake up on a full reset).

Effects

Two independent rotating gobo wheels

The two independent rotating gobo wheels has five slots plus one open position on each to control the shape of emitted light. Each gobo is indexable with bi-directional rotation. The standard gobo set includes both breakup patterns, geometric gobos and full colored gobos.

Effect wheels

The G-Spot has two effect wheels for generating optical effect. The two effect wheels operate as an extension to one another for achieving continuous animation effect.

High-precision pan and tilt

The G-Spot has a 16-bit pan and tilt control, with a 540° pan and 240° tilt movement with feedback.

Ultra high-speed strobe effect

The ultra high-speed strobe effect (1-50 Hz) introduces instant color control and the possibility to strobe between two or more colors at any speed. Random strobe and pulse effects can be generated with variable speed.

Prism

4-facet rotating prism.

Frost

The soft high-quality frost filter is variable from 0% to 100%.

Devices and accessories

Included items

Two Omega brackets with 1/4-turn fasteners
2 m power cable with Neutrik TRUE1 power connector
User manual

Ordering information

G-Spot Moving Head in cardboard box.....	Order no: 80021002
G-Spot Moving Head in flight case (1 device).....	Order no: 80021004
SGM USB uploader cable.....	Order no: 83062011
2 m power cable with Neutrik TRUE1 power connector	Order no: 07860040
Flight case (1 device).....	Order no: 82051001

APPROVALS AND CERTIFICATIONS

Conforms to 2004/108/EC: EMC Directive
Conforms to 2006/95/EC: Low Voltage Directive
Conforms to 2011/65/EU: RoHS2 Directive



The information in this document is subject to change without notice

User's notes



SGM A/S · Sommervej 23 · 8210 Aarhus V · Denmark
Tel +45 70 20 74 00 · info@sgmlight.com · www.sgmlight.com