

OPERATING INSTRUCTIONS AND OWNER'S MANUAL

MR. HEATER

READ INSTRUCTIONS CAREFULLY: Read and follow all instructions. Place instructions in a safe place for future reference. Do not allow anyone who has not read these instructions to assemble, light, adjust or operate the heater.

HEATSTAR

MODEL
MH35LP

MODEL
HS35LP



GAS-FIRED INFRA-RED PORTABLE CONSTRUCTION HEATER

DO NOT LEAVE HEATER UNATTENDED OR IN OPERATION WHILE SLEEPING

CYLINDER NOT INCLUDED



GENERAL HAZARD WARNING:

FAILURE TO COMPLY WITH THE PRECAUTIONS AND INSTRUCTIONS PROVIDED WITH THIS HEATER CAN RESULT IN DEATH, SERIOUS BODILY INJURY AND PROPERTY LOSS OR DAMAGE FROM HAZARDS OF FIRE, EXPLOSION, BURN, ASPHYXIATION, CARBON MONOXIDE POISONING, AND/OR ELECTRICAL SHOCK.

ONLY PERSONS WHO CAN UNDERSTAND AND FOLLOW THE INSTRUCTIONS SHOULD USE OR SERVICE THIS HEATER.

IF YOU NEED ASSISTANCE OR HEATER INFORMATION SUCH AS INSTRUCTION MANUALS, LABELS, ETC., CONTACT THE MANUFACTURER.



WARNING:

FIRE, BURN, INHALATION AND EXPLOSION HAZARD. KEEP SOLID COMBUSTIBLES SUCH AS BUILDING MATERIALS, PAPER OR CARDBOARD A SAFE DISTANCE AWAY FROM THE HEATER AS RECOMMENDED BY THE INSTRUCTIONS. NEVER USE THE HEATER IN SPACES WHICH DO OR MAY CONTAIN VOLATILE OR AIRBORNE COMBUSTIBLES OR PRODUCTS SUCH AS GASOLINE, SOLVENTS, PAINT THINNER, DUST PARTICLES OR UNKNOWN CHEMICALS.



WARNING: NOT FOR HOME OR RECREATIONAL VEHICLE USE

SPECIFICATIONS

MODEL NO. 35LP
 35LP
 GAS TYPE LP-Gas
 MAX. INLET
 PRESSURE 27.5" W.C.
 MIN. INLET
 PRESSURE 27.5" W.C.
 MANIFOLD
 PRESSURE 25.5" W.C.

Do not exceed the gas supply pressures shown on rating plate for Model 35LP. The maximum inlet gas supply pressure and the minimum inlet gas supply pressure (for purposes of input adjustment) for LP-Gas are shown as follows:



WARNING
 DO NOT EXCEED 27.5" W.C. (1 psi) INLET PRESSURE TO HEATER.

VENTILATION



WARNING
 THIS APPLIANCE IS UNVENTED AND MUST BE USED ONLY IN A WELL VENTILATED AREA.

The flow of combustion and ventilation air must not be obstructed. DO NOT use in a tightly enclosed area. Any combustion process requires and consumes oxygen, and may produce carbon monoxide. This heater must be operated with adequate ventilation. Two openings directly to the outdoors must be provided, one low and one high, preferably on opposite sides of the area to be heated. Each of these openings must provide at least three square inches of combustion air-intake area and exhaust outlet area for every 1000 BTUs per hour of heater input rate in order to complete the combustion/ventilation process. Provide additional ventilation for any additional fuel-burning appliances and/or additional occupants.

CLEARANCE (Minimum clearances to combustible materials)

MODEL NO.	BTU/HR RATING TYPE GAS		NORMAL OPERATING POSTION	CLEARANCES TO COMBUSTIBLES			
	NATURAL	LP & NG		TOP	SIDES	BACK	FRONT
35LP		35,000*	VERTICAL	40"	40"	0"	54"

*Tank size and tank temperature can directly affect BTU output

CONTENTS

Installation Instructions 3
 Location 3
 Piping 3
 Operating Instructions 4
 Lighting and Shut Down 4
 Maintenance Instructions 5
 Replacement Parts List 6
 Service and Parts Ordering Information 8



FOR YOUR SAFETY
 Do not use this heater in a space where gasoline or other liquids having flammable vapors are stored or used.

The heater is designed and approved for use as a construction heater under ANSI Z83.7 / CGA 2.14 - 2000

We cannot anticipate every use which may be made of our heaters. CHECK WITH YOUR LOCAL FIRE SAFETY AUTHORITY IF YOU HAVE QUESTIONS ABOUT APPLICATIONS.

Other standards govern the use of fuel gases and heat producing products in specific applications. Your local authority can advise you about these.

This appliance is intended to be used primarily for the heating of buildings under construction, alteration or repair.

THE STATE OF CALIFORNIA REQUIRES THE FOLLOWING WARNING:



WARNING
 Combustion by-products produced when using this product contain carbon monoxide, a chemical known to the State of California to cause cancer and birth defects (or other reproductive harm).

GENERAL INFORMATION

- A. Your Enerco Technical Products portable gas-fired infra-red heater comes fully assembled and is tested at the factory for proper gas and input as stated on the nameplate.
- B. Each heater is equipped with a 100% safety shutoff, push button valve which will automatically stop the flow of gas in the event the heater fails to operate for any reason. A tip over switch and an excess flow check are also standard on the model 35LP.
- C. Before proceeding with this installation, be sure to inspect for damages. The freight company must be notified of any damages and request that an inspection be made. Enerco Technical Products will send replacements for damaged parts only after receiving a signed inspection report to prove the liability of the freight company.

FOR SAFE OPERATION

- A. **READ THESE INSTRUCTIONS CAREFULLY. Read and adhere to these instructions. DO NOT allow anyone who has not read these instructions to assemble, light, adjust or operate this heater.**
- B. **LP-Gas IS HIGHLY FLAMMABLE.** In the event of a leak, LP-Gas will accumulate and the possibility of a fire is present. LP-Gas is scented and its strong odor is readily detectable. Never strike a match, bring any flame or create an electric spark in an enclosure when you smell LP-Gas. Ventilate the area thoroughly, move the heater outside, and correct the source of the leak before attempting to light any appliance.
- C. Always operate the heater with the LP-Gas cylinder in an upright position on a level non-combustible surface. **NEVER PLACE THE CYLINDER ON ITS SIDE WHEN OPERATING THE HEATER.**
- D. **DO NOT attempt to operate the heater with any gas other than that indicated on the heater nameplate.**

INSTALLATION INSTRUCTIONS

GENERAL

For the U.S. and/or Canada, the installation of this appliance must comply with local and/or Provincial codes or, in the absence of these codes,

- With the (U.S.) National Fuel Gas Code, ANSI Z223.1 – Latest Edition, AND with the (U.S.) Standard for the Storage and Handling of Liquefied Petroleum Gases, ANSI/NFPA 58, OR
- With the current (Canadian) CAN/CGA B149.1 AND B149.2 INSTALLATION CODES.

This heater (including hose and regulator assembly) must be inspected before each use and at least annually by a qualified service person. If the hose for Model 35LP shows evidence of excessive abrasion or wear, or if the hose is cut, it must be replaced prior to the heater being put into operation. The replacement hose assembly shall be that specified by the manufacturer. See the parts list.

The minimum ambient temperature rating for this heater is 20 degrees F.

This heater incorporates a “Tip Over” switch which automatically shuts off the burner in the event of tipping. Ensure that this switch is in the vertical position and is secured with the screws provided (see Fig. 4). **DO NOT operate this heater with the LP-gas supply cylinder in any other than the upright position.**

LOCATION

Although this heater incorporates a “tip over” switch, the heater and LP-Gas supply cylinder must be located on a hard, flat, level surface to minimize the risk of accidental tipping. The LP Gas supply cylinder should be adequately restrained to prevent accidental tipping. **DO NOT OPERATE this heater with the supply cylinder in any other than the upright position.**

This appliance must be installed only in locations where the potential for physical damage to the appliance (i.e., due to physical contact) is reduced to a minimum.

The installer must inform the owner/operator of this appliance that precautions must be taken to protect the appliance from physical damage.

This appliance produces radiant heat. Therefore, it must be located at least six feet away from any LP-Gas container and must not be directed toward any LP-Gas container within 20 feet.

The heater must be installed in a location such that it will not be exposed directly to water spray, rain, and/or dripping water.

Use of this heater in a draft/windy area may decrease its efficiency. If possible, operate the unit in a draft free area or turn the face of the heater away from the draft.

PIPING:

For Model 35LP (for use with LP-Gas)

This model may be connected to a self-contained LP-Gas supply system using the hose and regulator assembly supplied with the appliance, OR, it may be connected to a permanently installed LP-Gas supply system.

If connected to a self-contained LP-Gas supply system, the hose assembly must be inspected prior to each use of the heater. If it is evident that there is excessive abrasion or wear, or the hose is cut, it must be replaced prior to the heater being put into operation.

If connected to a self-contained LP-Gas supply system, the cylinder must have no less than a minimum capacity of 20 pounds and no more than a maximum capacity of 100 pounds of LP-Gas. DO NOT connect this appliance to a cylinder having less than a nominal 20 pound capacity of LP-Gas. DO NOT connect this appliance to more than one (1) 100 pound cylinder.



NEVER USE A FORK LIFT TRUCK TYPE CYLINDER.

The connection of Model 35LP to an LP-Gas cylinder must be made in a well ventilated area using the regulator and hose assembly supplied with the appliance. DO NOT attempt to adjust this regulator. It has been preset at the factory to provide safe and proper operation of the appliance. Use a 7/8" open end wrench to connect the POL fitting (supplied with the LP regulator) to the LP-Gas cylinder. Turn the POL nut in a counter-clockwise direction (left hand thread) until tight. DO NOT use pipe compound on POL threads.

The heater must be located at least six feet away from any LP-Gas cylinder and must not be directed toward any LP-Gas cylinder within 20 feet. If more than one heater is used, they and the supply cylinders must be separated by at least 20 feet.

The gas supply must be turned off at the LP-Gas supply cylinder when the heater is not in use.

When the heater is to be stored indoors, the connection between the LP-Gas supply cylinder and the heater must be disconnected and the cylinder removed from the heater and stored in accordance with Chapter 5 of the Standard for the Storage and Handling of Liquefied Petroleum Gases, ANSI/NF-PA 58 (U.S.), OR CAN/CGA B149.2 (Canada).

If connected to a permanently installed LP Gas supply system, the system requires the use of a two-stage gas regulator assembly which is normally provided by your LP-Gas dealer as part of the LP-Gas supply system. Consult with your local LP-Gas dealer for details concerning proper equipment and installation.

Piping must be clean and free from scale or burr.

Before attempting to ignite the appliance, all gas fittings and connections must be thoroughly checked for gas leaks. Apply a small amount of a mild soap and water solution to all fittings and connections and observe for escaping bubbles. If any leaks are detected, shut off the gas supply to the appliance immediately. Wait a minimum of five minutes, repair the leak(s) and retest for leakage. Dry all fittings and connections after leak testing.

WARNING

NEVER USE A FLAME FOR GAS LEAK TESTING.

OPERATING INSTRUCTIONS



WARNING: IF YOU DO NOT FOLLOW THESE INSTRUCTION EXACTLY, A FIRE OREXPLOSION MAY RESULT CAUSING PROPERTY DAMAGE, PERSONAL INJURY, OR LOSS OF LIFE.



CAUTION
THIS APPLIANCE IS HOT DURING NORMAL OPERATION. AVOID PHYSICAL CONTACT.



CAUTION

DO NOT PLACE CLOTHING OR OTHER COMBUSTIBLE MATERIALS ON THIS APPLIANCE.

DO NOT operate this heater if any part has been under water. Call a qualified service technician to inspect the appliance and to replace any part of the control system or gas control valve which has been under water.

This appliance must be installed and operated only in locations where the potential for physical damage to the appliance is reduced to a minimum. The owner/operator of this appliance must ensure that precautions are taken to protect the appliance from physical damage.

LIGHTING AND SHUT-DOWN

Lighting the Heater:

1. Before attempting to light the heater, smell all around the heater area for gas. Be sure to smell next to the floor because LP-Gas is heavier than air and will settle on the floor. Turn on the gas supply to the appliance and check all fittings and connections for gas leaks using a mild soap and water solution. NEVER use a match to check for gas leaks. Should a gas leak occur, shut off the gas supply to the appliance immediately. Wait a minimum of five minutes before repairing the leak.
2. Use only the fuel intended for this appliance. Check the appliance rating plate for the correct fuel information.
3. Turn off the main gas supply to the appliance. Wait five minutes.
4. Turn on the main gas supply.
- 5a. Depress and turn Control Knob counterclockwise to "Pilot" position and hold for 1-2 minutes. This may take longer to purge air from the supply hose depending on the length of the hose being used.

Depress red spark ignition button to light pilot flame (repeat until pilot lights) and continue to hold Control Knob at "Pilot" position for 30-60 seconds to enable Pilot Light Safety System.

Fully turn Control Knob to "Hi" position to light burner. **or...**
- 5b. With a lighted match held to the burner face, depress and hold the reset button. After the burner ignites, hold the reset button depressed for about one minute or until the burner stays lit when the reset button is released. **DO NOT light the gas at the burner orifice. DO NOT face heater when attempting to light. Always stand to the side of the unit when lighting.**

NOTE: In cases where long runs of gas supply lines have been installed ahead of the appliance, it may be necessary to bleed trapped air out of the supply lines before lighting the burner. New installations generally require bleeding of supply lines. Wait a minimum of five minutes after bleeding the supply lines before attempting to light the heater.

6. **IMPORTANT: DO NOT attempt to adjust the main burner input using the main gas supply valve,** for this may cause the thermocouple to shut down the burner.

Shut-down instructions:

To turn the heater OFF:

1. Close the LP-Gas supply cylinder valve.
2. Observe the burner until flame is extinguished.
3. Listen for closure of the safety valve.
4. **IMPORTANT: DO NOT re-open the LP-Gas supply cylinder valve before the safety valve closes.**

MAINTENANCE INSTRUCTIONS

This heater (including hose and regulator assembly) must be inspected before each use. If the hose for Model 35LP shows evidence of excessive abrasion or wear, or if the hose is cut, it must be replaced prior to the heater being put into operation. The replacement hose assembly shall be that specified by the manufacturer. See the parts list.

The appliance area must be kept free and clear of combustible materials, gasoline and other flammable vapors and liquids at all times.

The flow of combustion and ventilation air must not be obstructed.

Cleaning the heater:

Periodically, the heater must be cleaned of all dirt and dust particles.



DANGER

DO NOT ATTEMPT TO CLEAN THE HEATER WHILE IT IS OPERATING OR WHILE IT IS STILL HOT.

- Turn the heater off and wait until it has completely cooled (at least 20 minutes) before cleaning.
- Clean the outside of the heater using a damp cloth. DO NOT clean the heater by spraying water on it. Wipe the outside of the heater off with a dry cloth after cleaning.
- Clean the inside of the heater using compressed air. Blow air back and forth along the entire burner face until all dust has been dislodged from the surface of the reverberator and grid screen. Blow through venturi from the control end of the heater.
- Clean the orifice of each burner with a #55 drill bit (for LP-Gas).
- Clean the thermocouple lead.

DO NOT operate this heater if any part has been under water. Call a qualified service person to inspect the appliance and to replace any part of the control system or gas control valve which has been under water.

This heater must be inspected at least annually by a qualified service person.

TROUBLESHOOTING INFORMATION: (Model 35LP)

If burner lights, but goes out when button is released.

CHECK

- Loose wires on tipover switch. (see Fig. 4)
- Loose lead wire and repair wires if necessary.
- Loose thermocouple and tighten if necessary. Make sure T/C is located correctly between the reverberator and grid.
- Defective thermocouple. Replace if necessary.
- Defective control. Replace if necessary.
- Defective tip over switch. Replace if necessary.

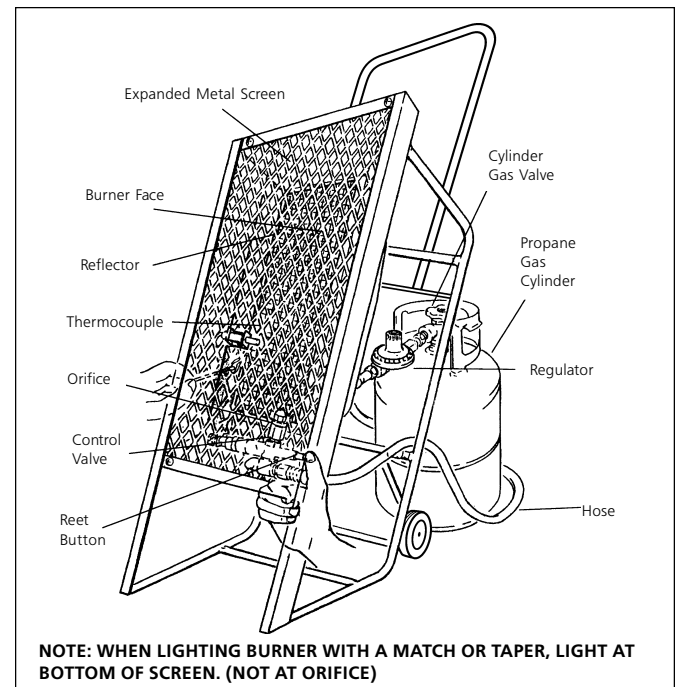

Figure 3

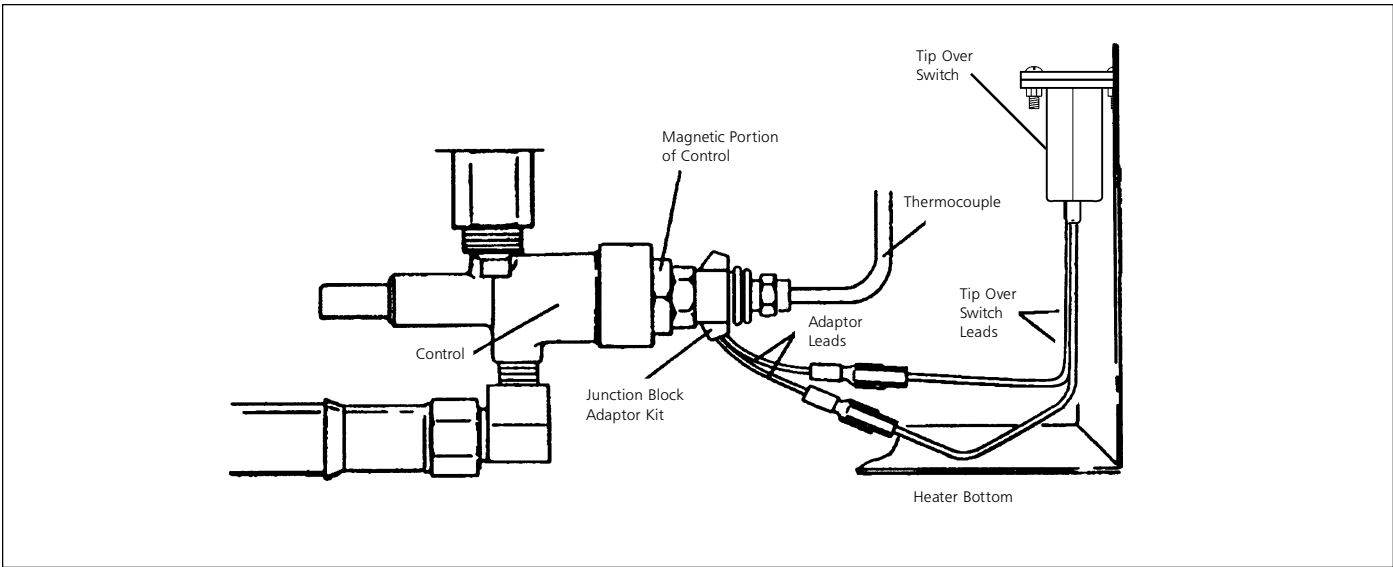

Figure 4

Tip-Over Switch Arrangement

NOTE: The purpose of the tip-over Switch is to stop the flow of gas when heater is accidentally knocked over. When and if the heater is knocked over, simply stand heater up.

REPLACEMENT PARTS LIST

REF. #	ITEM#	DESCRIPTION
1	00333	CONT M-N SS PORT 3/8MPXI/4MP
2	02455	BURNR/LTFR PORTABLES/D1096
3	05455	ORIFICE/BURNER #55 DRILL
4	09352	THERMOCOUPLE ASSY/18"
5	09357	TIP-OVER SWITCH 6" LEAD(PORT)
6	09371	JUNCTION BLK ADPTR KIT/TIPSW
7	11663	REC.L/P 21" WC OUT
8	CR705	IGNITOR, MODEL#35
9	CR735	PIEZO, MODEL#35
10	CR710	WHEEL, MODEL#35
11	CR720	AXLE, MODEL#35
12	CR715	AXLE BRACKETS, MODEL#35
13	CR725	HANDLE
14	CR730	WHEEL LOC
15	70722	MAIN FRAME LOWER ASSEMBLY

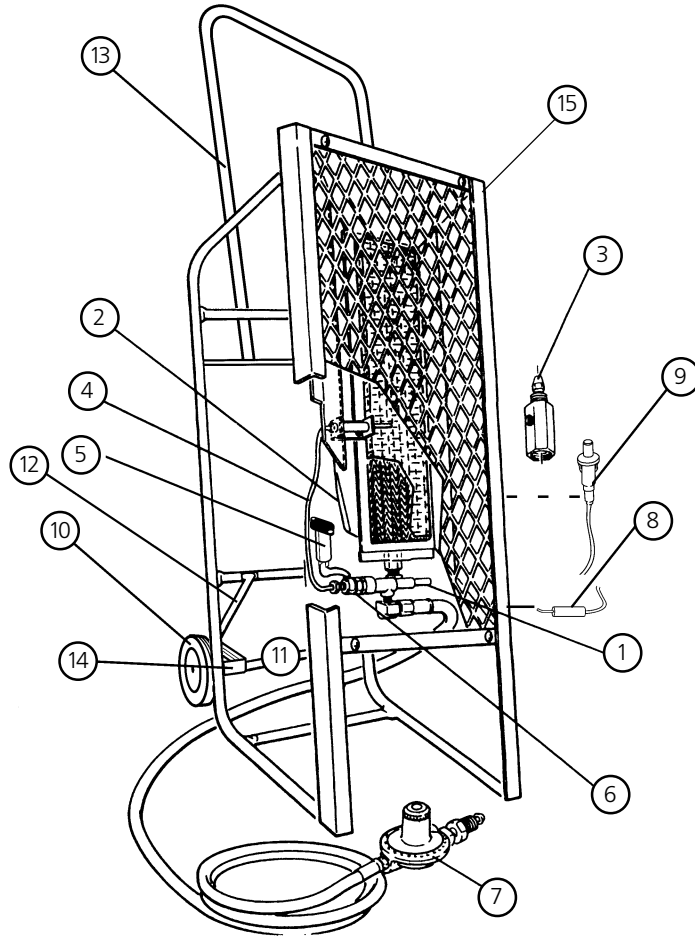

IF SERVICE IS REQUIRED

PLEASE DO NOT RETURN THIS APPLIANCE TO YOUR STORE

For information regarding service, please call our Toll-Free Number: 1-800-251-0001.

Our office hours are 8:30 AM to 5:00 PM, Eastern Time Zone, Monday through Friday

Please include the model number, date of purchase and description of problem in all communication.

OPERATING INSTRUCTIONS AND OWNER'S MANUAL

MR. HEATER

MODEL
MH35LP

READ INSTRUCTIONS CAREFULLY: Read and follow all instructions. Place instructions in a safe place for future reference. Do not allow anyone who has not read these instructions to assemble, light, adjust or operate the heater.

HEATSTAR

MODEL
HS35LP

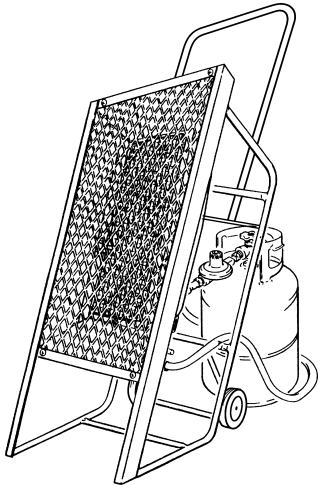

WARNING:

USE ONLY MANUFACTURER'S REPLACEMENT PARTS. USE OF ANY OTHER PARTS COULD CAUSE INJURY OR DEATH. REPLACEMENT PARTS ARE ONLY AVAILABLE DIRECT FROM THE FACTORY AND MUST BE INSTALLED BY A QUALIFIED SERVICE AGENCY.

PARTS ORDERING INFORMATION:

PURCHASING: Accessories may be purchased at any Mr. Heater /HeatStar local dealer or direct from the factory

FOR INFORMATION REGARDING SERVICE

Please call Toll-Free 800-251-0001

www.enerco-mrheater.com

Our office hours are 8:30 AM – 5:00 PM, EST, Monday through Friday.

Please include the model number, date of purchase, and description of problem in all communication.

WARRANTY

MR. HEATER warrants that Infra Red Heaters manufactured and sold will be free from defects in material and workmanship.

Parts assemblies, controls, etc. furnished by Enerco Group, Inc. will carry a one (1) year warranty on the applicable warranties of the suppliers.

The sole responsibility of Enerco Group, Inc. under this warranty shall be to replace or repair any part for which a written claim is made to Enerco Technical Products within the time limit of this warranty which is returned upon request to Enerco Group, Inc. – F.O.B. Cleveland, Ohio – or F.O.B. any Enerco Technical Products authorized service facility and which is proved to be defective upon inspection by Enerco Technical Products .

This warranty shall not apply to any part or product which has been subjected to misuse or neglect, damaged by accident, or rendered defective by reason of improper installation. THIS WARRANTY IS IN LIEU OF ANY AND ALL OTHER WARRANTIES, EXPRESSED OR IMPLIED, and of any other responsibility of Enerco Technical Products for parts or products sold by Enerco Technical Products , including consequential or special damages.

Enerco Group, Inc. reserves the right to make changes at any time, without notice or obligation, in colors, specifications, accessories, materials and models.



ANSI Z83.7/CGA 2.14-2000

ENERCO GROUP, INC., 4560 W. 160TH ST., CLEVELAND, OHIO 44135 • 216-881-5500

Enerco and Mr. Heater are registered trademarks of Enerco Group, Inc.

© 2004, Enerco Group, Inc. All rights reserved