

eldes

ESIM251
ESIM252

GSM CONTROL SYSTEM

SAFETY INSTRUCTIONS

Please read and follow these safety guidelines to safeguard yourself and others:

- GSM control system ESIM251/ESIM252 (later referred to as "the system" or "the device") contains a built-in radio transceiver operating in GSM 850/900/1800/1900 MHz bands.
- DO NOT use the system where it can cause potential danger and interfere with other devices - such as medical devices.
- DO NOT use the system in hazardous environment.
- DO NOT expose the system to high humidity, chemical environment or mechanical impact.
- DO NOT attempt to repair the system yourself - any repairs must be carried out by fully qualified personnel only.



Disconnect the mains power before installing. Never install or carry out maintenance during stormy weather. The electric socket that powers the system must be easily accessible.



Please use the 10-24V 50Hz ~200mA AC or 10-24V --- 200mA DC power supply unit that meets the EN 60950-1 standard. Any additional device you connect to the system, such as a computer, must also be powered by an EN 60950-1 approved supply. When connecting the power supply to the system, switching the polarity terminal places does not have any affect.

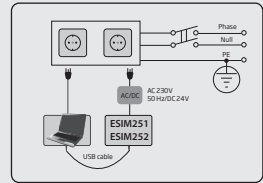

External power supply can be connected to AC mains only inside installation room with automatic 2-pole circuit breaker capable of disconnecting circuit in the event of short circuit or over-current condition. Open circuit breaker must have a gap between connections of more than 3mm and the disconnection current 5A.



To switch the system off, unplug the external electric power supply from or any other linked device that the system is powered from



A blown fuse cannot be replaced by the user. The replacement fuse has to be of the kind indicated by the manufacturer (fuse F1 model - MINISMDC050F 0.5A).



A blown fuse cannot be replaced by the user. The replacement fuse has to be of the kind indicated by the manufacturer (fuse F1 model - MINISMDC050F 0.5A).



The WEEE (Waste Electrical and Electronic Equipment) symbol on this product (see left) means it must not be disposed of in household waste. To prevent possible harm to human health and/or the environment, you must dispose of this product in an approved and environmentally safe recycling facility. For further information contact your system supplier, or your local waste authority.

CONTENTS

1. GENERAL INFORMATION	5
2. TECHNICAL SPECIFICATIONS	5
2.1. Electrical and Mechanical Characteristics	5
2.2. Main Unit, LED Indicator and Connector Functionality	6
2.3. Wiring Diagram	7
3. INSTALLATION	8
4. GENERAL OPERATIONAL DESCRIPTION	9
5. CONFIGURATION METHODS	9
5.1. SMS Text Messages	9
5.2. LDES Configuration Tool	9
6. SYSTEM LANGUAGE	12
7. SMS PASSWORD	12
8. USER PHONE NUMBERS	13
8.1. System Control from any Phone Number	14
9. DATE AND TIME	15
10. INPUTS	15
10.1. Pulse Counter	16
10.2. Disabling and Enabling Inputs	16
11. ALARM/RESTORE NOTIFICATIONS	18
11.1. Enabling and Disabling Alarm/Restore Notification Delivery to All Listed Users	21
12. AUDIO FILES	22
13. OUTPUT (-S)	22
13.1. Output Name (-s)	22
13.2. Output Control by Free of Charge Phone Call	23
13.3. Control by SMS Text Message	28
13.4. Automatic Output Control	31
14. SYSTEM INFORMATION. INFO SMS	37
14.1. Periodic Info SMS	37
15. SYSTEM NOTIFICATIONS	38
15.1. SMSC (Short Message Service Center) Phone Number	38
16. EVENT LOG	39
17. REMOTE LISTENING	40
18. GPRS NETWORK SETTINGS	40
19. MONITORING STATION	41
19.1. Data Messages - Events	41
19.2. Communication	41
20. PROJECT EXAMPLES AND CONFIGURATION	45
20.1. Using in Enterprises	45
20.2. Using in a Private House	49
20.3. Using with Heating System and Flood Detector	51
20.4. Using for Breakdown Reports	53
21. TECHNICAL SUPPORT	56
21.1. Troubleshooting	56
21.2. Restoring Default Parameters	56
21.3. Updating the Firmware via USB Cable	56
21.4. Updating the Firmware via GPRS Connection Remotely	57
22. RELATED PRODUCTS	58

Limited Liability

The buyer agrees that the system will reduce the risk of fire, theft, burglary or other danger but that it does not guarantee against the occurrence of such events. "ELDES UAB" will not take any responsibility for the loss of personal effects, property or revenue whilst using the system. The liability of "ELDES UAB" is limited to the value of the system purchased. "ELDES UAB" is not affiliated with any mobile/wireless/cellular provider and is therefore not responsible for the quality of such services.

Manufacturer Warranty

The system carries a 24-month manufacturer warranty from "ELDES UAB". The warranty begins the day the system is purchased by the user and the receipt must be retained as proof of purchase date. The warranty remains valid only if the system is used as intended, following all guidelines outlined in this manual and in accordance with the operating conditions specified. The warranty is void if the system has been exposed to mechanical impact, chemicals, high humidity, fluids, corrosive and hazardous environments or force majeure factors.

Dear Customer,

Thank you for choosing to purchase the GSM control system ESIM251/ESIM252. Your thoughtful decision will ensure reliable solution for many years as all ELDES products are manufactured to meet the highest standards.

We are confident that you will be completely satisfied with your product. However, in the unlikely event that you do experience a problem, please contact the dealer from whom you made your purchase.

UAB ELDES
www.eldes.it

CONTENTS OF PACK

Item	Quantity
1. ESIM251/ESIM252	1
2. User manual.....	1
3. GSM/GPRS antenna.....	1
4. Plastic standoffs	4

Not included:

- SIM card - we recommend you get a contract SIM, not Pay As You Go.
- miniUSB cable - can be obtained from your local distributor.
- Microphone - can be obtained from your local distributor.

Copyright © "ELDES UAB", 2014. All rights reserved

It is strictly forbidden to copy and distribute information in this document or pass to a third party without an advanced written authorization from "ELDES UAB". "ELDES UAB" reserves the right to update or modify this document and/or related products without a warning. Hereby, "ELDES UAB" declares that the GSM control system ESIM251/ESIM252 is in compliance with the essential requirements and other relevant provisions of Directive 1999/5/EC. The declaration of conformity may be consulted at www.eldes.it.



1. GENERAL INFORMATION

ESIM251/ESIM252 is a micro-controller based device intended to receive alarm/restore events by SMS text message or phone call and control an electrical appliance via the GSM network.

Examples of using the system:

- Access control.
- Gate control of private houses.
- Notification of system events, such as arming/disarming, alarm/restore from non-GSM alarm system.
- Non-GSM alarm system arming/disarming by SMS text message.
- Any electrical appliance control: lighting, watering, heating etc.
- Remote reboot of the “frozen” systems, such as computer network or a server.

Main features:

- 5 inputs with customizable alarm/restore texts.
- Up to 5 user phone numbers for system configuration by SMS text messages, acceptance of input alarm/restore SMS text messages and phone calls, output control by SMS text message and free of charge phone call.
- Relay output (ESIM251 - 1 output; ESIM252 - 2 outputs) for electrical appliance control or non-GSM alarm system arming/disarming (key-switch).
- Manual output control by free of charge phone call.
- Automatic output control in accordance with the scheduled time.
- Up to 10 audio messages for input alarm/restore notification.
- Event log of 500 events.
- Periodic self-test notification by SMS text message to user phone number.

2. TECHNICAL SPECIFICATIONS

2.1. Electrical and Mechanical Characteristics

Supply voltage	10-24V 50Hz ~ 200mA max / 10-24V --- 200mA max
Current used in idle state	Up to 50mA
GSM modem frequency	850/900/1800/1900 MHz
Number of outputs	1 (ESIM251); 2 (ESIM252)
Output type	Relay; NO (normally-open)
Maximum commuting output values	24V 50Hz ~ 0,5A / 24V --- 1A
Number of “low” level (negative) inputs	4
Number of “high” level (positive) inputs	1
“Low” level (negative) input value range	0... 16V --- -0.8... -0.4mA
“High” level (positive) input value range	5... 50V --- 0.17 1.7mA
“Low” level (negative) and “high” level (positive) input connection type	NO (normally-open) / NC (normally-closed)
Dimensions	82x63x17 mm
Operating temperature range	-20...+55 °C (-30...+55 °C with limitations)
Humidity	0-90% RH @ 0... +40 °C (non-condensing)

2.2. Main Unit, LED Indicator and Connector Functionality

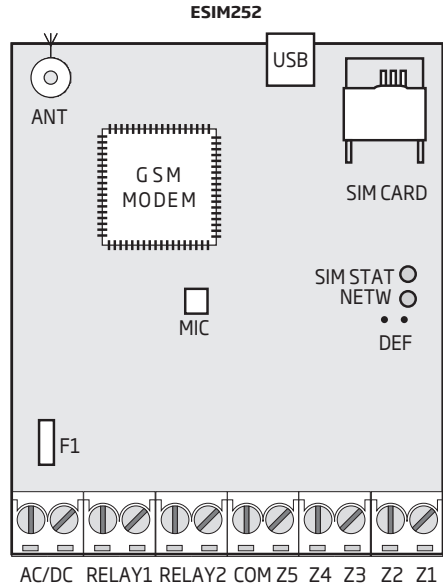
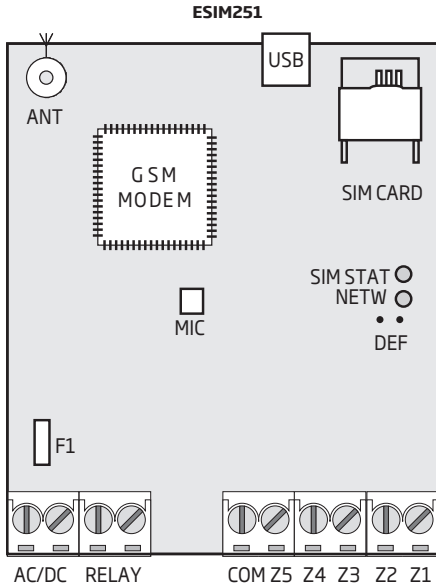

1

Main Unit Functionality

ANT	GSM/GPRS antenna SMA type connector
USB	Mini USB port
SIM CARD	SIM card slot / holder
GSM MODEM	GSM network 850/900/1800/1900 MHz modem
MIC	Microphone connector
SIM STAT	Red light-emitting diode indicating SIM card status
NETW	Green light-emitting diode indicating GSM signal strength
DEF	Pins for restoring default settings
F1	0.5A fuse

Connector Functionality

AC/DC	Power supply terminals
RELAY	ESIM251 output C1 terminal
RELAY1	ESIM252 output C1 terminal
RELAY2	ESIM252 output C2 terminal
COM	Common terminal
Z5	"Low" level (negative) input terminal
Z4	"Low" level (negative) input terminal
Z3	"Low" level (negative) input terminal
Z2	"High" level (positive) input terminal
Z1	"Low" level (negative) input terminal

LED Indicator Functionality

SIM STAT indication	SIM card status
OFF	No mains power / micro-controller fault
Steady ON	SIM card is attempting to connect to the GSM network / SIM card is not present / PIN code enabled
Flashing	GSM connection failed

NETW indication	GSM signal strength
OFF	No GSM signal
Flashing every 1 sec.	Poor
Flashing several times per sec.	Medium
Steady ON	Excellent

2.3. Wiring Diagram

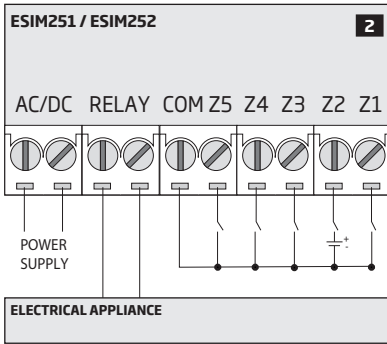

3. INSTALLATION

- The system should be installed indoors, in stationary environment ONLY.
 - For the connection of input/output terminals, use 0.50 mm² 1 thread unshielded cable of up to 100 meters length.
1. Wire up the system in accordance with the wiring diagrams (see **2.3 Wiring Diagrams** for more details).
 2. Connect the GSM/GPRS antenna. Based on the type of the GSM/GPRS antenna supplied with ESIM251/ESIM252 unit, follow the recommendations for the antenna installation:

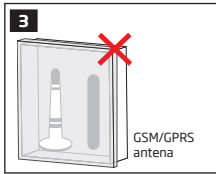

Never install in the following locations:

- inside the metal cabinet
- close to the metal surface and/ or power lines

3. Disable the PIN code request of the SIM card by inserting it into a mobile phone and following the proper menu steps.
4. Once the PIN code is disabled, insert the SIM card into the SIM card slot / holder of ESIM251/ESIM252 system.

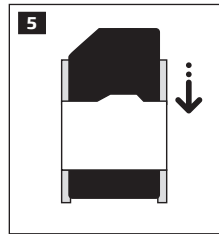
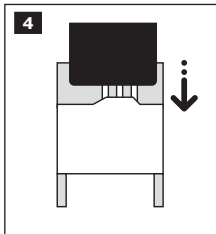

5. Power up the system and wait until indicator SIM STAT lights up indicating SIM card status.
6. Once the indicator SIM STAT lights OFF, the illuminated indicator NETW lights up indicating that the system has successfully connected to the GSM network. To find the strongest GSM signal, position the GSM/GPRS antenna and follow the indications provided by NETW indicator (see **2.2. Main Unit, LED Indicator & Connector Functionality** for more details).
7. Change the system language if necessary (see **6. SYSTEM LANGUAGE** for more details).
8. Change the default SMS password (see **7. SMS PASSWORD** for more details).
9. Set the phone number for User 1 (see **8. USER PHONE NUMBERS** for more details).
10. Set system date and time (see **9. DATE AND TIME** for more details).
11. Once the system is fully configured, it is ready for use. However, if you fail to receive a reply by SMS text message from the system, please check the SMSC (Short Message Service Center) phone number. For more details regarding the SMS center phone number, please refer to **15.1. SMSC (Short Message Service Center) Phone Number**.

ATTENTION: The system is NOT compatible with pure 3G SIM cards. Only 2G/GSM SIM cards and 3G SIM cards with 2G/GSM profile enabled are supported. For more details, please contact your GSM operator.

ATTENTION: We also recommend you to disable **call forwarding, voice mail/text message reports on missed/busy calls ("call catcher")** and similar services that might cause incorrect system operation. Please contact your GSM operator for more details on these services and how to disable them.

NOTE: For maximum system reliability we recommend you do NOT use a Pay As You Go SIM card. Otherwise, in the event of insufficient credit balance on the SIM card, the system would fail to make a phone call or send SMS text messages.

NOTE: We advise you to choose the same GSM SIM provider for your system as for your mobile phone. This will ensure the fastest, most reliable SMS text message delivery service and phone call connection.

NOTE: The system is NOT compatible with pure 3G SIM cards. Only 2G/GSM SIM cards and 3G SIM cards with 2G/GSM profile enabled are supported. For more details, please contact your GSM operator.

4. GENERAL OPERATIONAL DESCRIPTION

GSM control system ESIM251/ESIM252 uses the GSM network for event transmission by SMS text message. When one of the 5 available listed numbers dials the system, it answers the call and the user can listen to a pre-recorded audio message and hear what is going on in the premises once the audio message is over. The remote listening function operates only when a microphone is connected. When the "conversation" is over, the user The system will ignore SMS requests and phone calls coming from non-listed phone numbers.

The system has 5 digital inputs (normally closed or normally open) for alarm system's PGM output or detection device connection, such as magnetic door contact. By connecting the input to the non-GSM alarm system's PGM output, the user will be able to receive an SMS text message or phone call regarding system alarm/restore, arming/disarming and other events depending on the alarm system configuration. In addition to being informed by SMS text message or phone call regarding alarm and restore events of the inputs, the users can control one electrical appliance by connecting it to the relay output (-s). For example, users can turn ON or OFF the heating, lighting, lift the gates, blinds etc. The output can also be used for arming/disarming by connecting it to one of the alarm system zones configured as a key-switch.

5. CONFIGURATION METHODS

5.1. SMS Text Messages



In this user manual the underscore character "_" represents one space character. Every underscore character must be replaced by a single space character. There must be no spaces or other unnecessary characters at the beginning and at the end of the SMS text message.

SMS

In order to configure and control the system by SMS text message, send the text command to the ESIM251/ESIM252 system phone number from one of the listed user phone numbers. The structure of SMS text message consists of 4-digit SMS password (the default SMS password is 0000 – four zeros), the parameter and value. For some parameters the value does not apply e. g. STATUS. The variables are indicated in lower-case letters, while a valid parameter value range is indicated in brackets.

5.2. ELDES Configuration Tool

Software *ELDES Configuration Tool* is intended for ESIM251/ESIM252 GSM control system configuration locally via USB port or remotely via GPRS network connection. This software simplifies system configuration process by allowing to use a personal computer in the process. Before starting to use *ELDES Configuration Tool* software, please read the user guide provided in the software's HELP section.

ELDES Configuration Tool is freeware and can be downloaded from at: www.eldes.lt

NOTE: *ELDES Configuration Tool* software is secured with SMS password. The default SMS password is **0000** (see **7. SMS PASSWORD**).

5.2.1. Remote System Configuration via Configuration Server

ATTENTION: The system will NOT send any data to the monitoring station while remote configuration is in progress. However, during the remote configuration session the data messages will be queued up and transmitted to the monitoring station after the remote configuration session is over.

Before configuring ESIM251/ESIM252 remotely via GPRS network connection, please ensure that:

- SIM card is inserted into the SIM CARD slot (see **2.2. Main Unit, LED & Connector Functionality**).
- Mobile internet service (GPRS) is enabled on the SIM card.
- ESIM251/ESIM252 is powered up.
- Default SMS password is changed to a new 4-digit password (see **7. SMS PASSWORD**).
- User 1 phone number is set up (see **8. USER PHONE NUMBERS**).
- APN, user name and password are set up (see **18. GPRS NETWORK SETTINGS**).



ESIM251/
ESIM252

Ethernet/
Internet



Configuration
Server

Internet



ELDES Configuration
Tool

- a) In order to activate a remote connection between ESIM251/ESIM252 system and ELDES configuration server, please send the following SMS text message from listed user phone number. Upon the successful SMS text message delivery, the system establishes a connection session for 20 minutes.

Initiate connection with ELDES configuration server

SMS

SMS text message content:

sssss_STCONFIG

Value: ssss - 4-digit SMS password.

Example: 1111_STCONFIG

- b) Once the SMS text message containing device IMEI number and confirming a successful connection establishment is received, please run *ELDES Configuration Tool* software.
- c) Click **Remote Connection Management...**
- d) In the next window, select **Connect to Remote Server (recommended)** and click **Next** button.
- e) In **Device IMEI** entry, enter the IMEI number previously received by SMS text message.
- f) Click **Continue** button.
- g) By default, upon the successfully established connection, the system will prompt for an SMS password..
- h) By entering a valid SMS password, the system grants access to full configuration remotely.
- i) **Remote Configuration Management** window displays all performed configuration actions and connectivity information.

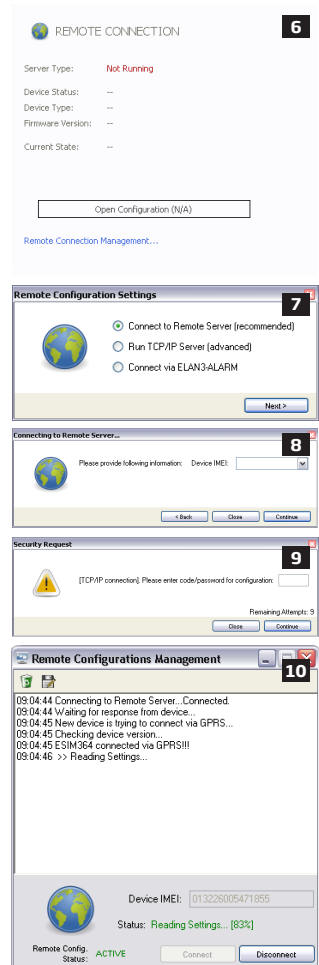

5.2.2. Remote System Configuration via Direct Connection

ATTENTION: The system will NOT send any data to the monitoring station while remote configuration is in progress. However, during the remote configuration session the data messages will be queued up and transmitted to the monitoring station after the remote configuration session is over.

Before configuring ESIM251/ESIM252 remotely via GPRS network connection, please ensure that:

- SIM card is inserted into the SIM CARD slot (see **2.2. Main Unit, LED & Connector Functionality**).
- Mobile internet service (GPRS) is enabled on the SIM card.
- ESIM251/ESIM252 is powered up.
- Default SMS password is changed to a new 4-digit password (see **7. SMS PASSWORD**).
- User 1 phone number is set up (see **8. USER PHONE NUMBERS**).
- APN, user name and password are set up (see **18. GPRS NETWORK SETTINGS**).
- Machine running *ELDES Configuration Tool* software provides access via public IP address.
- TCP port 5000 is forwarded for the IP address of the machine running *ELDES Configuration Tool* software.



ESIM251/
ESIM252

GPRS network/
Internet



ELDES Configuration
Tool

- Run *ELDES Configuration Tool* software.
- Click **Remote Connection Management...**
- In the next window, select Run **TCP/IP Server (advanced)** and click **Next** button.
- Set a TCP port for listening for incoming connections or leave the default TCP port 5000.
- Click **Continue** button.
- In order to activate a remote connection between ESIM251/ESIM252 system and *ELDES Configuration Tool* software running as remote configuration server, please send the following SMS text message from listed user phone number. Upon the successful SMS text message delivery, the system establishes a connection session for 20 minutes.

Initiate
connection
with ELDES
Configuration Tool

SMS

SMS text message content:

`ssss_STCONFIG: add.add.add.add:pprr` or
`ssss_STCONFIG:host-name:pprr`

Value: *ssss* - 4-digit SMS password; *add.add.add.add* - public IP address of the machine running ELDES Configuration Tool software; *pprr* - TCP port number, range - [1... 65535]; *host-name* - public host-name of the machine running *ELDES Configuration Tool* software.

Example: `1111_STCONFIG:62.80.115.102:4522`

- By default, upon the successfully established connection, the system will prompt for an SMS password.
- By entering a valid SMS password, the system grants access to full configuration remotely.
- Remote Configuration Management** window displays all performed configuration actions and connectivity information.

REMOTE CONNECTION **11**

Server Type: **Not Running**
Device Status: --
Device Type: --
Firmware Version: --
Current State: --

Open Configuration (N/A)

Remote Connection Management...

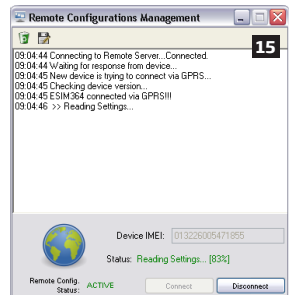
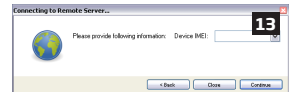
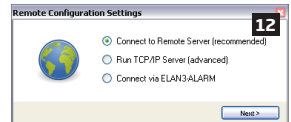

5.2.3. Ending the Configuration Process

After the system configuration is complete, use one of the following methods to end the configuration process:

- Click **Disconnect** or **Stop** button and close *ELDES Configuration Tool* software;
- The session will automatically expire in 20 minutes. Before the last 5 minutes, the software will offer the user to extend the session for another 20 minutes.
- Alternatively, the connection with the server can be terminated at any time by sending an SMS text message.

Terminate the
connection

SMS text message content:

`ssss_ENDCONFIG`

Value: *ssss* - 4-digit SMS password.

Example: `1111_ENDCONFIG`

Once the session is expired or terminated, the system will reply with an SMS text message confirming the end of the session.

6. SYSTEM LANGUAGE

The system comes equipped with a multiple languages for communication with the user by SMS text messages. The default system language depends on the firmware, which is based on the customer's location.

List of currently available system languages:

- English
- Czech*
- Icelandic*
- Lithuanian
- Latvian*
- Russian*
- Slovak
- Spanish*

Set system language

SMS

SMS text message content:

LN

Value: *LN* - language index; range - [*EN* - English, *CZ* - Czech*, *IS* - Icelandic*, *LT* - Lithuanian, *LV* - Latvian*, *RU* - Russian*, *SK* - Slovak, *SP* - Spanish*].

Example: *LT*

Config Tool

This operation may be carried out from the PC using the *ELDES Configuration Tool* software.

* Language unavailable on ESIM252.

NOTE: To change the language once the system has already been configured, you need to reset the device to the default configuration. For more details on how to do this, please refer to **21.2. Restoring Default Parameters**.

7. SMS PASSWORD

For security reasons, the system uses the following type of password:

SMS password - 4-digit password used for system configuration and control from user phone number by SMS text messages and logging in to *ELDES Configuration Tool* software. By default, SMS password is **0000**, which **MUST** be changed!

Set SMS password

SMS

SMS text message content:

wwwww_PSW_ssss

Value: *wwwww* - 4-digit default SMS password; *ssss* - 4-digit new SMS password; range - [0001... 9999].

Example: *0000_PSW_1111*

Config Tool

This operation may be carried out from the PC using the *ELDES Configuration Tool* software.

NOTE: The system rejects the SMS text messages containing wrong SMS password even from a listed user phone number.

8. USER PHONE NUMBERS

The system supports up to 5 user phone numbers identified as User 1 through 5. When the phone number is set, the user will be able to configure and control the system by SMS text messages as well as by free of charge phone call and receive the input alarm/restore SMS text messages and/or phone calls from the system (see **11. ALARM/RESTORE NOTIFICATIONS**).

By default, the system ignores any incoming calls and SMS text messages from a non-listed phone number as well as it rejects the SMS text messages containing wrong SMS password even from a listed user phone number. For more details on how to enable output control from a non-listed phone number, please refer to **8.1. System Control from any Phone Number**.

To set User 1 phone number is mandatory, while the other 4 are optional. The supported phone number format is the following:

- **International (w/o plus)** - The phone numbers must be entered starting with an international country code in the following format: [international code][area code][local number], example for UK: 441709xxxxxxx.

Set user phone number

SMS

SMS text message content:

`ssss_NRu:ttteeellnnuumm`

Value: ssss - 4-digit SMS password; *u* - user phone number slot, range - [1... 5]; *ttteeellnnuumm* - up to 15 digits administrator phone number.

Example: 1111_NR1:441709xxxxxxx

Config Tool

This operation may be carried out from the PC using the *ELDES Configuration Tool* software.

View user phone number

SMS

SMS text message content:

`ssss_HELPNR`

Value: ssss - 4-digit SMS password.

Example: 1111_HELPNR

Config Tool

This operation may be carried out from the PC using the *ELDES Configuration Tool* software.

Delete user phone number

SMS

SMS text message content:

`ssss_NRu:DEL`

Value: ssss - 4-digit SMS password; *u* - user phone number slot, range - [1... 5].

Example: 1111_NR2:DEL

Config Tool

This operation may be carried out from the PC using the *ELDES Configuration Tool* software.

ATTENTION: The system rejects the SMS text messages containing wrong SMS password even from a listed user phone number.

ATTENTION: Once User 1 phone number is set, the system will restrict only to modify it

ATTENTION: Multiple user phone numbers can be set by a single SMS text message, **Example:** 1111_NR1:441709xxxxxx1_NR5:441709xxxxxx2_NR2:441709xxxxxx3_NR3: 441709xxxxxx4

NOTE: Multiple user phone numbers can be deleted by a single SMS text message, **Example:** 1111_NR2:DEL_NR4:DEL_NR3:DEL

8.1. System Control from any Phone Number

By default, the system ignores any incoming calls and SMS text messages from a non-listed phone number as well as it rejects the SMS text messages containing wrong SMS password even from a listed user phone number. To permit/deny incoming phone calls and SMS text messages that contain a valid SMS password from any phone number, please refer to the following configuration methods.

Enable system control from any phone number

SMS

SMS text message content:

`ssss_STR:ON`

Value: ssss - 4-digit SMS password.

Example: `1111_STR:ON`

Config Tool

This operation may be carried out from the PC using the *ELDES Configuration Tool* software.

Disable system control from any phone number

SMS

SMS text message content:

`ssss_STR:OFF`

Value: ssss - 4-digit SMS password.

Example: `1111_STR:OFF`

Config Tool

This operation may be carried out from the PC using the *ELDES Configuration Tool* software.

9. DATE AND TIME

The system comes equipped with internal real-time clock (RTC) that keeps track of the current date and time. Once the system is up and running, the user must set the correct date and time, otherwise the system will not operate properly. By default, after shutting down and starting up the system, the date and time must be set again.

Set date and time

SMS

SMS text message content:

`ssss_yyyy.mt.dd_hr:mn`

Value: `ssss` - 4-digit SMS password; `yyyy` - year; `mt` - month, range - [01...12]; `dd` - day, range - [01...31]; `hr` - hours, range - [00...23]; `mn` - minutes, range - [00...59].

Example: `1111_2014.03.16_14:33`

Config Tool

This operation may be carried out from the PC using the *ELDES Configuration Tool* software.

NOTE: When the system is connected to the monitoring station via GPRS network connection (see **19. MONITORING STATION**), the date and time will be automatically synchronized with the monitoring station or Smart Security server upon the system startup.

10. INPUTS

The system comes equipped with 5 inputs identified as Z1 through Z5. Normally, the inputs are used for PGM output connection of non-GSM alarm system, motion detectors, door contacts and other passive or active digital level sensors. Once a detection device is triggered, the system will send a notification to the user phone number. For more details, please refer to **11. ALARM/RESTORE NOTIFICATIONS**.

Each input's sensitivity level can be customized by a delay time (by default - 600 milliseconds). If an input is left triggered until the delay time expires, the input is considered violated.

Set input delay

SMS

SMS text message content:

`ssss_SMSEXTRA:Zn:DVin-delay`

Value: `ssss` - 4-digit SMS password; `n` - input number, range - [1...5]; `in-delay` - input delay, range - [100...10000] milliseconds.

Example: `1111_SMSEXTRA:Z3:D800`

Config Tool

This operation may be carried out from the PC using the *ELDES Configuration Tool* software.

By default, all system inputs are set as NO (normally-open). To change the input connection type to NC (normally closed)/NO (normally open), please refer to the following configuration methods.

Set input as NC (normally closed)

SMS

SMS text message content:

`ssss_SMSEXTRA:Zn:L11`

Value: `sssss` - 4-digit SMS password; `n` - input number, range - [1...5].

Example: `1111_SMSEXTRA:Z4:L11`

Config Tool

This operation may be carried out from the PC using the *ELDES Configuration Tool* software.

Set input as NO (normally open)

SMS

SMS text message content:

`ssss_SMSEXTRA:Zn:L10`

Value: `sssss` - 4-digit SMS password; `n` - input number, range - [1...5].

Example: `1111_SMSEXTRA:Z2:L10`

Config Tool

This operation may be carried out from the PC using the *ELDES Configuration Tool* software.

The system allows to view the current input state by the following configuration method.

View input state

SMS

SMS text message content:

`ssss_INFO`

Value: ssss - 4-digit SMS password.

Example: 1111_INFO

Config Tool

This operation may be carried out from the PC using the *ELDES Configuration Tool* software.

10.1. Pulse Counter

The system comes equipped with input pulse counter feature. The feature determines the number of input violation events, known as pulses, that result in input alarm SMS text message delivery and/or phone call to the listed user phone number once the number of the set up pulses is achieved. The time-frame between the pulses is unlimited.

By default, the pulse counter feature is disabled and the number of pulses is not set. To enable/disable it and set the number of pulses, please refer to the following configuration methods:

Enable pulse counter

SMS

SMS text message content:

`ssss_SMSEXTRA:Zn:IE1`

Value: ssss - 4-digit SMS password; *n* - input number, range - [1... 5].

Example: 1111_SMSEXTRA:Z2:IE1

Config Tool

This operation may be carried out from the PC using the *ELDES Configuration Tool* software.

Set number of pulses

SMS

SMS text message content:

`ssss_SMSEXTRA:Zn:ICnum-pulse`

Value: ssss - 4-digit SMS password; *n* - input number, range - [1... 5]; *num-pulse* - number of pulses, range - [0... 4294967295].

Example: 1111_SMSEXTRA:Z5:IC562

Config Tool

This operation may be carried out from the PC using the *ELDES Configuration Tool* software.

Disable pulse counter

SMS

SMS text message content:

`ssss_SMSEXTRA:Zn:IE0`

Value: ssss - 4-digit SMS password; *n* - input number, range - [1... 5].

Example: 1111_SMSEXTRA:Z1:IE0

Config Tool

This operation may be carried out from the PC using the *ELDES Configuration Tool* software.

NOTE: Once the pulse counter feature is in use, the input restore notifications regarding a certain input will no longer be delivered to the listed user phone number, even if enabled.

10.2. Disabling and Enabling Inputs

By default, all inputs are enabled. Once disabled, input alarm/resetore event will no longer be followed by an SMS text message and/or phone call. To disable/enable an individual input, please refer to the following configuration methods.

Disable input

SMS

SMS text message content:

`ssss_Zn:OFF`

Value: ssss - 4-digit SMS password; *n* - input number, range - [1... 5].

Example: 1111_Z1:OFF

Config Tool

This operation may be carried out from the PC using the *ELDES Configuration Tool* software.

Enable input

SMS

SMS text message content:

`ssss_Zn:ON`

Value: ssss - 4-digit SMS password; n - input number, range - [1... 5].

Example: `1111_Z5:ON`

Config
Tool

This operation may be carried out from the PC using the *ELDES Configuration Tool* software.

View input status

SMS

SMS text message content:

`ssss_STATUS`

Value: ssss - 4-digit SMS password.

Example: `1111_STATUS`

Config
Tool

This operation may be carried out from the PC using the *ELDES Configuration Tool* software.

NOTE: Multiple inputs can be managed by a single SMS text message, **Example:** `1111_Z1:OFF;Z3:ON;Z5:OFF;`

11. ALARM/RESTORE NOTIFICATIONS

In the event of input alarm or restore, the system can notify the listed user phone number by the following methods that can be used individually or simultaneously:

- SMS text message.
- Phone call.

SMS

By default, in the event of input alarm, the system will follow this pattern:

- The system attempts to send an SMS text message containing input alarm text to the first listed user phone number only.
- If the user phone number is unavailable and the system fails to receive the SMS delivery report within 45 seconds, it will attempt to send the SMS text message to the next listed user phone number. The system may fail to deliver the SMS text message to the listed user phone number due to the following reasons:
 - user's mobile phone has been switched off.
 - user's mobile phone has been out of GSM signal coverage.
- The system will continue sending the SMS text message to the next listed user phone numbers in the priority order until one is available (to change this algorithm, please refer to **11.1. Enabling and Disabling Alarm/Restore Notification Delivery to All Listed Users**).
- The system sends the SMS text message only once and will not return to the first user phone number if the last one was unavailable, therefore if the system ends up with all unsuccessful attempts, it will delete the queued up event from the memory and it will no longer attempt to send it by SMS text message.

By default, input restore notification by SMS text message is disabled. Once enabled, the system will follow the SMS text message delivery pattern identically as for input alarm event.

To manage input alarm and restore SMS text messages, please refer to the following configuration methods

Disable input alarm notification by SMS

SMS

SMS text message content:

`ssss_SMSEXTRA:Zn:SCu`

Value: ssss - 4-digit SMS password; n - input number, range - [1... 5]; u - user phone number slot, range - [1... 5].

Example: 1111_SMSEXTRA:Z4:SC4

Config Tool

This operation may be carried out from the PC using the *ELDES Configuration Tool* software.

Enable input alarm notification by SMS

SMS

SMS text message content:

`ssss_SMSEXTRA:Zn:SSu`

Value: ssss - 4-digit SMS password; n - input number, range - [1... 5]; u - user phone number slot, range - [1... 5].

Example: 1111_SMSEXTRA:Z3:SS1

Config Tool

This operation may be carried out from the PC using the *ELDES Configuration Tool* software.

Set input alarm text

SMS

SMS text message content:

`ssss_Zn/in-alarm-text`

Value: ssss - 4-digit SMS password; n - input number, range - [1... 5]; in-alarm-text - up to 24 characters input alarm text.

Example: 1111_Z2:Alarm Input2

Config Tool

This operation may be carried out from the PC using the *ELDES Configuration Tool* software.

Enable input restore notification by SMS

SMS

SMS text message content:

`ssss_SMSEXTRA:Zn:SEU`

Value: ssss - 4-digit SMS password; n - input number, range - [1... 5]; u - user phone number slot, range - [1... 5].

Example: 1111_SMSEXTRA:Z1:SE5

Config Tool

This operation may be carried out from the PC using the *ELDES Configuration Tool* software.

Disable input restore notification by SMS

SMS

SMS text message content:

`ssss_SMSEXTRA:Zn:SDU`

Value: ssss - 4-digit SMS password; n - input number, range - [1... 5]; u - user phone number slot, range - [1... 5].

Example: 1111_SMSEXTRA:Z2:SD1

Config Tool

This operation may be carried out from the PC using the *ELDES Configuration Tool* software.

Set input restore text

SMS

SMS text message content:

`ssss_ZRn:in-restore-text`

Value: ssss - 4-digit SMS password; n - input number, range - [1... 5]; in-restore-text - up to 24 characters input alarm text.

Example: 1111_ZR3:Restore Input3

Config Tool

This operation may be carried out from the PC using the *ELDES Configuration Tool* software.

ATTENTION: Colon and semicolon characters are NOT allowed in the input alarm/restore notification texts.

NOTE: Multiple alarm/restore texts can be managed by a single SMS text message. **Example:** 1111_Z2:Alarm In2;ZR4:Restore In4;

NOTE: Multiple users can be managed by a single SMS text message; **Example:** 1111_SMSEXTRA:Z2:SE135



The system comes equipped with ringing the listed user phone number (by default - disabled) in the event of input alarm/restore. By default, in the event of input alarm, the system will follow this pattern:

- The system attempts to ring the first listed user phone number.
- When the call is answered, the system will play the audio file that can be listened to on the user's mobile phone. This feature will be available only if an audio file is recorded and assigned to the input alarm event (see **12. AUDIO FILES**).
- When the audio record has played, the user will be able to listen on the mobile phone to what is happening in the area, surrounding the alarm system. This feature will be available only if a microphone is connected to the system (see **17. REMOTE LISTENING**).
- The system will dial the next listed user phone number if the previous user was unavailable due to the following reasons:
 - mobile phone has been switched off.
 - mobile phone has been out of GSM signal coverage.
 - has provided "busy" signal.
 - user did not answer the call after several rings, predetermined by the GSM operator.
- The system will continue dialing the next listed user phone numbers in the priority order until one is available.
- The system will dial the first user phone number again if the last one was unavailable thus carrying out the cycle 3 times in total. The system will not dial the next listed user phone number if the previous one was available, but rejected the phone call (to change this algorithm, please refer to **11.1. Enabling and Disabling Alarm/Restore Notification Delivery to All Listed Users**).

By default, input restore notification by phone call is disabled. Once enabled, the system will follow the phone call delivery pattern identically as for input alarm event.

To manage input alarm and restore phone calls, please refer to the following configuration methods

Disable input alarm notification by call

SMS

SMS text message content:

`§sss_SMSEXTRA:Zn:CCu`

Value: §sss - 4-digit SMS password; *n* - input number, range - [1... 5]; *u* - user phone number slot, range - [1... 5].

Example: 1111_SMSEXTRA:Z2:CC4

Config Tool

This operation may be carried out from the PC using the *ELDES Configuration Tool* software.

Enable input alarm notification by call

SMS

SMS text message content:

`§sss_SMSEXTRA:Zn:CSu`

Value: §sss - 4-digit SMS password; *n* - input number, range - [1... 5]; *u* - user phone number slot, range - [1... 5].

Example: 1111_SMSEXTRA:Z2:CS1

Config Tool

This operation may be carried out from the PC using the *ELDES Configuration Tool* software.

Enable input restore notification by call

SMS

SMS text message content:

`§sss_SMSEXTRA:Zn:CEu`

Value: §sss - 4-digit SMS password; *n* - input number, range - [1... 5]; *u* - user phone number slot, range - [1... 5].

Example: 1111_SMSEXTRA:Z5:CE1

Config Tool

This operation may be carried out from the PC using the *ELDES Configuration Tool* software.

Disable input restore notification by call

SMS

SMS text message content:

`§sss_SMSEXTRA:Zn:CDu`

Value: §sss - 4-digit SMS password; *n* - input number, range - [1... 5]; *u* - user phone number slot, range - [1... 5].

Example: 1111_SMSEXTRA:Z1:CD3

Config Tool

This operation may be carried out from the PC using the *ELDES Configuration Tool* software.

By default, the system dials the first available user in case of alarm. If the user did not answer the call or was unavailable, the system will attempt to dial the next listed user phone number. However, if the phone call was answered or rejected by the user, the system will not dial the next listed user phone number. To change the alarm/restore phone call algorithm, user can enable/disable the following parameter for alarm/restore events:

NOTE: Multiple users can be managed by a single SMS text message; **Example:** 1111_SMSEXTRA:Z3:CD25

- **Confirmation required when calling in case of alarm/restore** - This parameter determines whether the answered call requires a DTMF signal confirmation by pressing the [#] key on the mobile phone keypad or not. Once enabled, the system will dial every listed user phone number that is enabled to receive an alarm/restore event from the system by phone call regardless of the fact that user was unavailable, did not answer the call, rejected the call or answered the call, but did not confirm it by pressing the [#] key.

Enable/disable confirmation request for calls in case of alarm/restore

Config Tool

This operation may be carried out from the PC using the *ELDES Configuration Tool* software.

NOTE: Confirmation required when calling in case of alarm/restore feature is supported by product s/n: 0010742 and up.

11.1. Enabling and Disabling Alarm/Restore Notification Delivery to All Listed Users

SMS

By default, the system sends SMS text message to the first available user in case of alarm. If the system did not receive the SMS delivery report within 45 seconds, it will attempt to send the SMS text message to the next listed user phone number.

To change the SMS text message delivery algorithm, user can enable/disable the following parameters for alarm events:

- **Send alarm/restore SMS to all users simultaneously** - This parameter determines whether to ignore the SMS delivery report or not. Once enabled, the system will attempt to send the SMS text message to every listed user phone number that is enabled to receive an alarm/restore event from the system by SMS text message. In addition, this parameter overrides the SMS delivery report parameter regardless of the SMS delivery report parameter's status (enabled/disabled).
- **SMS ACK (delivery report)** - This parameter determines whether to request for SMS delivery report or not. Once disabled, the system will not verify the status of the SMS text message delivery and will attempt to deliver the SMS text message only to the first listed user phone number regardless if the next listed user phone number (-s) is enabled to receive a certain event by SMS text message or not.

Enable alarm/restore SMS text message delivery to all listed users simultaneously

SMS

SMS text message content:

`ssss_SMSALL:ON`

Value: ssss - 4-digit SMS password.

Example: `1111_SMSALL:ON`

Config Tool

This operation may be carried out from the PC using the *ELDES Configuration Tool* software.

Disable alarm/restore SMS text message delivery to all listed users simultaneously

SMS

SMS text message content:

`ssss_SMSALL:OFF`

Value: ssss - 4-digit SMS password.

Example: `1111_SMSALL:OFF`

Config Tool

This operation may be carried out from the PC using the *ELDES Configuration Tool* software.

ATTENTION: SMS ACK (delivery report) parameter applies to all SMS text messages delivered by the system.



By default, the system dials the first available user in case of alarm. If the user did not answer the call or was unavailable, the system will attempt to dial the next listed user phone number. However, if the phone call was answered or rejected by the user, the system will not dial the next listed user phone number. To change the alarm/restore phone call algorithm, user can enable/disable the following parameter for alarm/restore events:

- **Call to all users simultaneously in case of alarm/restore** - This parameter determines whether to ignore the answered or rejected calls by the previous user in case of alarm/restore or not. Once enabled, the system will attempt to dial every listed user phone number that is enabled to receive an alarm/restore event from the system by phone call.

Enable alarm/restore phone call to all listed users

SMS

SMS text message content:

`ssss_CALLALL:ON`

Value: ssss - 4-digit SMS password.

Example: `1111_CALLALL:ON`

Config Tool

This operation may be carried out from the PC using the *ELDES Configuration Tool* software.

Disable alarm/restore phone call to all listed users

SMS

SMS text message content:

`ssss_CALLALL:OFF`

Value: ssss - 4-digit SMS password.

Example: `1111_CALLALL:OFF`

Config Tool

This operation may be carried out from the PC using the *ELDES Configuration Tool* software.

12. AUDIO FILES

The system comes equipped with a feature allowing to record up to 5 audio files of up to 15 seconds length using the microphone of the PC. The recorded file can be assigned to the input alarm and/or restore event and be played when the alarm/restore is caused by input with an audio file assigned. This feature will be available only if the system is pre-configured to dial a user phone number in the event of an input alarm and/or restore and if the user answers the call. The supported audio file format is as follows:

- Max. number of audio files: up to 10 (5 for input alarm event and 5 for input restore event)
- Max. audio length: up to 15 seconds
- File format: .wav
- Specifications: 8,000 kHz; 8 Bit; Mono

Record and manage the audio files

Config Tool

This operation may be carried out from the PC using the *ELDES Configuration Tool* software.

NOTE: It is highly recommended to use *ELDES Configuration Tool* software's built-in sound recorder to record an audio file.

13. OUTPUT (-S)

ESIM251 comes equipped with 1 built-in output, while ESIM252 - with 2 outputs for electrical appliance or non-GSM alarm panel's zone connection. Normally, the output can be used to open/close garage doors, activate lights, heating, watering as well as a key-switch for non-GSM alarm system arming/disarming. When the output turns ON, the system triggers any device or relay connected to it.

The system supports the following output control methods:

- Free of charge phone call from the user phone number (see **13.2. Output Control by Free of Charge Phone Call**).
- SMS text message from the user phone number (see **13.3. Output Control by SMS Text Message**).
- Automatically in accordance with the scheduled time (see **13.4. Automatic Output Control**).

View output state

SMS

SMS text message content:

`ssss_STATUS`

Value: ssss - 4-digit SMS password.

Example: 1111_STATUS

Config Tool

This operation may be carried out from the PC using the *ELDES Configuration Tool* software.

13.1. Output Name (-s)

The output (-s) has a name that can be customized. Typically, the name specifies a device type connected to a determined output, for example: *Pump*. The name can be used instead of output number when controlling the output by SMS text message. In addition, the output name is always included in output control confirmation SMS text message (if enabled).

By default, the output names are as follows: C1 - *Controll1* (ESIM251, ESIM252), C2 - *Controll2* (ESIM252).

Set output name

SMS

SMS text message content:

`ssss_C1.out-name`

Value: ssss - 4-digit SMS password; *out-name* - up to 11 characters output name.

Example: 1111_C1:Pump

ONLY FOR ESIM251

Config Tool

This operation may be carried out from the PC using the *ELDES Configuration Tool* software.

Set output name

ONLY FOR ESIM252

SMS

SMS text message content:

`ssss_Co:out-name`

Value: ssss - 4-digit SMS password; o - output number, range [1 - output C1; 2 - output C2]; *out-name* - up to 11 characters output name.

Example: 1111_C2:Boiler

Config Tool

This operation may be carried out from the PC using the *ELDES Configuration Tool* software.

View output name

SMS

SMS text message content:

`ssss_STATUS`

Value: ssss - 4-digit SMS password.

Example: 1111_STATUS

Config Tool

This operation may be carried out from the PC using the *ELDES Configuration Tool* software.

ATTENTION: Space, colon, semi-colon characters, parameter names and/or values, such as PSW, STATUS, ON, OFF etc. are NOT allowed in output names.

13.2. Output Control by Free of Charge Phone Call



Once enabled, the specified user can control the electrical appliance connected to the system's output by dialling the system's phone number from any available user phone number (see **8. USER PHONE NUMBERS** for phone number management). The phone call is free charge as the system rejects it and turns ON/OFF the output (-s) resulting in the electrical appliance turning ON or OFF, depending on the current output state. The output can also be used for a key switch feature allowing to arm/disarm a non-GSM alarm panel. If there is more than one preset caller dialing to the system at the same time, the system will accept the incoming call from the caller who was the first to dial while other caller (-s) will be ignored.

The system supports the following output control actions upon free of charge phone call:

- **Turn ON** - Turns ON the output and keeps it in this state for a set up period of time.
- **Turn OFF** - Turns OFF the output and keeps it in this state for a set up period of time.
- **Toggle** - Turns ON the output and keeps it in this state until the phone call reoccurs. The set up period of time has no effect on this action.

Enable output control by free of charge phone call for a certain user

ONLY FOR ESIM251

SMS

SMS text message content:

`ssss_SMSEXTRA:COC:CEu`

Value: ssss - 4-digit SMS password; u - user phone number slot, range - [1... 5].

Example: 1111_SMSEXTRA:COC:CE5

Config Tool

This operation may be carried out from the PC using the *ELDES Configuration Tool* software.

Disable output control by free of charge phone call for a certain user

ONLY FOR ESIM251

SMS

SMS text message content:

`ssss_SMSEXTRA:COC:CDu`

Value: ssss - 4-digit SMS password; u - user phone number slot, range - [1... 5].

Example: 1111_SMSEXTRA:COC:CD5

Config Tool

This operation may be carried out from the PC using the *ELDES Configuration Tool* software.

Set output action as Turn ON

ONLY FOR ESIM251

SMS

SMS text message content:

`ssss_SMSEXTRA:COC:MSu1`

Value: ssss - 4-digit SMS password; u - user phone number slot, range - [1... 5].

Example: 1111_SMSEXTRA:COC:MS41

Config Tool

This operation may be carried out from the PC using the *ELDES Configuration Tool* software.

Set output action
as Turn OFF

ONLY FOR ESIM251

SMS

SMS text message content:

`ssss_SMSEXTRA:COC:MSu0`

Value: ssss - 4-digit SMS password; *u* - user phone number slot, range - [1... 5].

Example: 1111_SMSEXTRA:COC:MS20

Config
Tool

This operation may be carried out from the PC using the *ELDES Configuration Tool* software.

Set output control
duration for Turn ON/
Turn OFF action

ONLY FOR ESIM251

SMS

SMS text message content:

`ssss_SMSEXTRA:COC:MSuThr.mn.sc`

Value: ssss - 4-digit SMS password; *u* - user phone number slot, range - [1... 5]; *hr* - hours, range - [00... 23]; *mn* - minutes, range - [00... 59]; *sc* - seconds, range - [00... 59].

Example: 1111_SMSEXTRA:COC:MS5T05.12.30

Config
Tool

This operation may be carried out from the PC using the *ELDES Configuration Tool* software.

Set output action
as Toggle

ONLY FOR ESIM251

SMS

SMS text message content:

`ssss_SMSEXTRA:COC:MSu2`

Value: ssss - 4-digit SMS password; *u* - user phone number slot, range - [1... 5].

Example: 1111_SMSEXTRA:COC:MS42

Config
Tool

This operation may be carried out from the PC using the *ELDES Configuration Tool* software.

Enable output control
by free of charge phone
call for a certain user

ONLY FOR ESIM252

SMS

SMS text message content:

`ssss_SMSEXTRA:COC:CEu`

Value: ssss - 4-digit SMS password; *o* - output number, range - [1... 2]; *u* - user phone number slot, range - [1... 5].

Example: 1111_SMSEXTRA:COC1:CE5

Config
Tool

This operation may be carried out from the PC using the *ELDES Configuration Tool* software.

Disable output control
by free of charge phone
call for a certain user

ONLY FOR ESIM252

SMS

SMS text message content:

`ssss_SMSEXTRA:COC:CDu`

Value: ssss - 4-digit SMS password; *o* - output number, range - [1... 2]; *u* - user phone number slot, range - [1... 5].

Example: 1111_SMSEXTRA:COC2:CD2

Config
Tool

This operation may be carried out from the PC using the *ELDES Configuration Tool* software.

Set output action
as Turn ON

ONLY FOR ESIM252

SMS

SMS text message content:

`ssss_SMSEXTRA:COC:MSu1`

Value: ssss - 4-digit SMS password; *o* - output number, range - [1... 2]; *u* - user phone number slot, range - [1... 5].

Example: 1111_SMSEXTRA:COC2:MS41

Config
Tool

This operation may be carried out from the PC using the *ELDES Configuration Tool* software.

Set output action as Turn OFF

ONLY FOR ESIM252

SMS

SMS text message content:

ssss_SMSEXTRA:COC:MSu0

Value: ssss - 4-digit SMS password; o - output number, range - [1... 2]; u - user phone number slot, range - [1... 5].

Example: 1111_SMSEXTRA:COC1:MS20

Config Tool

This operation may be carried out from the PC using the *ELDES Configuration Tool* software.

Set output control duration for Turn ON/ Turn OFF action

ONLY FOR ESIM252

SMS

SMS text message content:

ssss_SMSEXTRA:COC:MSuThr.mn.sc

Value: ssss - 4-digit SMS password; o - output number, range - [1... 2]; u - user phone number slot, range - [1... 5]; hr - hours, range - [00... 23]; mn - minutes, range - [00... 59]; sc - seconds, range - [00... 59].

Example: 1111_SMSEXTRA:COC2:MS5T05.12.30

Config Tool

This operation may be carried out from the PC using the *ELDES Configuration Tool* software.

Set output action as Toggle

ONLY FOR ESIM252

SMS

SMS text message content:

ssss_SMSEXTRA:COC:MSu2

Value: ssss - 4-digit SMS password; o - output number, range - [1... 2]; u - user phone number slot, range - [1... 5].

Example: 1111_SMSEXTRA:COC1:MS42

Config Tool

This operation may be carried out from the PC using the *ELDES Configuration Tool* software.

NOTE: Multiple users can be managed by a single SMS text message **Example:** 1111_SMSEXTRA:COC2:CE245

13.2.1. Output Control via Call Confirmation

After turning the output ON or OFF, the system can send a confirmation reply by an SMS text message, containing the output name (see **13.1. Output Name (-s)**), to the user phone number that has initiated the output control action by free of charge phone call. In addition, the system can make a phone call confirming that the output control action has been successfully carried out. Once enabled, output ON action will be followed by a 2-second (by default) ring, while the OFF action will be indicated by a 8-second (by default) ring to the user phone number that has initiated the output control action by call.

By default, the output control confirmations are disabled. To manage the output control via call confirmations, please refer to the following configuration methods.

Enable output control via call confirmation by SMS

ONLY FOR ESIM251

SMS

SMS text message content:

ssss_SMSEXTRA:COC:SSu

Value: ssss - 4-digit SMS password; u - user phone number slot, range - [1... 5].

Example: 1111_SMSEXTRA:COC:SS2

Config Tool

This operation may be carried out from the PC using the *ELDES Configuration Tool* software.

Disable output control via call confirmation by SMS

ONLY FOR ESIM251

SMS

SMS text message content:

ssss_SMSEXTRA:COC:SCu

Value: ssss - 4-digit SMS password; u - user phone number slot, range - [1... 5].

Example: 1111_SMSEXTRA:COC:SC4

Config Tool

This operation may be carried out from the PC using the *ELDES Configuration Tool* software.

Enable output control via call confirmation by call back

ONLY FOR ESIM251

SMS

SMS text message content:

`ssss_SMSEXTRA:COC:CSu`

Value: ssss - 4-digit SMS password; *u* - user phone number slot, range - [1... 5].

Example: `1111_SMSEXTRA:COC:CS3`

Config Tool

This operation may be carried out from the PC using the *ELDES Configuration Tool* software.

Disable output control via call confirmation by call back

ONLY FOR ESIM251

SMS

SMS text message content:

`ssss_SMSEXTRA:COC:CCu`

Value: ssss - 4-digit SMS password; *u* - user phone number slot, range - [1... 5].

Example: `1111_SMSEXTRA:COC:CC3`

Config Tool

This operation may be carried out from the PC using the *ELDES Configuration Tool* software.

Set call back duration for output ON action

ONLY FOR ESIM251

SMS

SMS text message content:

`ssss_SMSEXTRA:COC:CTu1cd`

Value: ssss - 4-digit SMS password; *u* - user phone number slot, range - [1... 5]; *cd* - call back duration, range - [0... 60] seconds.

Example: `1111_SMSEXTRA:COC:CT4120`

Config Tool

This operation may be carried out from the PC using the *ELDES Configuration Tool* software.

Set call back duration for output OFF action

ONLY FOR ESIM251

SMS

SMS text message content:

`ssss_SMSEXTRA:COC:CTu0cd`

Value: ssss - 4-digit SMS password; *u* - user phone number slot, range - [1... 5]; *cd* - call back duration, range - [0... 60] seconds.

Example: `1111_SMSEXTRA:COC:CT2025`

Config Tool

This operation may be carried out from the PC using the *ELDES Configuration Tool* software.

Enable output control via call confirmation by SMS

ONLY FOR ESIM252

SMS

SMS text message content:

`ssss_SMSEXTRA:COC:SSu`

Value: ssss - 4-digit SMS password; *o* - output number, range - [1... 2]; *u* - user phone number slot, range - [1... 5].

Example: `1111_SMSEXTRA:COC2:SS2`

Config Tool

This operation may be carried out from the PC using the *ELDES Configuration Tool* software.

Disable output control via call confirmation by SMS

ONLY FOR ESIM252

SMS

SMS text message content:

`ssss_SMSEXTRA:COC:SCu`

Value: ssss - 4-digit SMS password; *o* - output number, range - [1... 2]; *u* - user phone number slot, range - [1... 5].

Example: `1111_SMSEXTRA:COC2:SC4`

Config Tool

This operation may be carried out from the PC using the *ELDES Configuration Tool* software.

Enable output control via call confirmation by call back

ONLY FOR ESIM252

SMS

SMS text message content:

ssss_SMSEXTRA:COCo:CSu

Value: ssss - 4-digit SMS password; o - output number, range - [1... 2]; u - user phone number slot, range - [1... 5].

Example: 1111_SMSEXTRA:COc1:CS3

Config Tool

This operation may be carried out from the PC using the *ELDES Configuration Tool* software.

Disable output control via call confirmation by call back

ONLY FOR ESIM252

SMS

SMS text message content:

ssss_SMSEXTRA:COCo:CCu

Value: ssss - 4-digit SMS password; o - output number, range - [1... 2]; u - user phone number slot, range - [1... 5].

Example: 1111_SMSEXTRA:COc1:CC5

Config Tool

This operation may be carried out from the PC using the *ELDES Configuration Tool* software.

Set call back duration for output ON action

ONLY FOR ESIM252

SMS

SMS text message content:

ssss_SMSEXTRA:COCo:CTu1cd

Value: ssss - 4-digit SMS password; o - output number, range - [1... 2]; u - user phone number slot, range - [1... 5]; cd - call back duration, range - [0... 60] seconds.

Example: 1111_SMSEXTRA:COc:CT4120

Config Tool

This operation may be carried out from the PC using the *ELDES Configuration Tool* software.

Set call back duration for output OFF action

ONLY FOR ESIM252

SMS

SMS text message content:

ssss_SMSEXTRA:COCo:CTu0cd

Value: ssss - 4-digit SMS password; o - output number, range - [1... 2]; u - user phone number slot, range - [1... 5]; cd - call back duration, range - [0... 60] seconds.

Example: 1111_SMSEXTRA:COc:CT2025

Config Tool

This operation may be carried out from the PC using the *ELDES Configuration Tool* software.

13.3. Control by SMS Text Message

SMS

To turn ON or turn OFF the output (-s), send the SMS text message from any of 5 available user phone numbers (see **8. USER PHONE NUMBERS** for phone number management). To instantly turn ON/OFF the output and set its state to ON/OFF when the system starts-up, please refer to the following configuration methods.

Turn ON output/Set output start-up state as ON

ONLY FOR ESIM251

SMS

SMS text message content:

`§§§§_C1:ON` or `§§§§_out-name:ON`

Value: §§§§ - 4-digit SMS password; *out-name* - up to 11 characters output name.

Example: `1111_C1:ON`

Config Tool

This operation may be carried out from the PC using the *ELDES Configuration Tool* software.

Turn OFF output/Set output start-up state as OFF

ONLY FOR ESIM251

SMS

SMS text message content:

`§§§§_C1:OFF` or `§§§§_out-name:OFF`

Value: §§§§ - 4-digit SMS password; *out-name* - up to 11 characters output name.

Example: `1111_Pump:OFF`

Config Tool

This operation may be carried out from the PC using the *ELDES Configuration Tool* software.

Turn ON output/Set output start-up state as ON

ONLY FOR ESIM252

SMS

SMS text message content:

`§§§§_Co:ON` or `§§§§_out-name:ON`

Value: §§§§ - 4-digit SMS password; *o* - output number, range - [1... 2]; *out-name* - up to 11 characters output name.

Example: `1111_Lamp:ON`

Config Tool

This operation may be carried out from the PC using the *ELDES Configuration Tool* software.

Turn OFF output/Set output start-up state as OFF

ONLY FOR ESIM252

SMS

SMS text message content:

`§§§§_Co:OFF` or `§§§§_out-name:OFF`

Value: §§§§ - 4-digit SMS password; *o* - output number, range - [1... 2]; *out-name* - up to 11 characters output name.

Example: `1111_C2:OFF`

Config Tool

This operation may be carried out from the PC using the *ELDES Configuration Tool* software.

To turn ON/OFF the output (-s) for a determined time period (pulse), please refer to the following configuration methods.

Turn ON output for time period

ONLY FOR ESIM251

SMS

SMS text message content:

`§§§§_C1:ON:hr.mn.sc` or `§§§§_out-name:ON:hr.mn.scv`

Value: §§§§ - 4-digit SMS password; *hr* - hours, range - [00... 23]; *mn* - minutes, range - [00... 59]; *sc* - seconds, range - [00... 59]; *out-name* - up to 11 characters output name.

Example: `1111_Pump:ON:00.10.13`

Config Tool

This operation may be carried out from the PC using the *ELDES Configuration Tool* software.

Turn OFF output
for time period

ONLY FOR ESIM251

SMS

SMS text message content:

`§sss_C1:OFF:hr.mn.sc` or `§sss_out-name:OFF:hr.mn.sc`

Value: §sss - 4-digit SMS password; *hr* - hours, range - [00... 23]; *mn* - minutes, range - [00... 59]; *sc* - seconds, range - [00... 59]; *out-name* - up to 11 characters output name.

Example: `1111_C1:OFF:00.00.15`

Config
Tool

This operation may be carried out from the PC using the *ELDES Configuration Tool* software.

Turn ON output
for time period

ONLY FOR ESIM252

SMS

SMS text message content:

`§sss_Co:ON:hr.mn.sc` or `§sss_out-name:ON:hr.mn.sc`

Value: §sss - 4-digit SMS password; *o* - output number, range - [1... 2]; *hr* - hours, range - [00... 23]; *mn* - minutes, range - [00... 59]; *sc* - seconds, range - [00... 59]; *out-name* - up to 11 characters output name.

Example: `1111_C2:ON:00.00.09`

Config
Tool

This operation may be carried out from the PC using the *ELDES Configuration Tool* software.

Turn OFF output
for time period

ONLY FOR ESIM252

SMS

SMS text message content:

`§sss_Co:OFF:hr.mn.sc` or `§sss_out-name:OFF:hr.mn.sc`

Value: §sss - 4-digit SMS password; *o* - output number, range - [1... 2]; *hr* - hours, range - [00... 23]; *mn* - minutes, range - [00... 59]; *sc* - seconds, range - [00... 59]; *out-name* - up to 11 characters output name.

Example: `1111_C1:OFF:00.11.49`

Config
Tool

This operation may be carried out from the PC using the *ELDES Configuration Tool* software.

13.3.1. Output Control via SMS Confirmation

By default, after turning the output ON or OFF, the system will send a confirmation reply by an SMS text message, containing the output name (see **13.1. Output Name (-s)**), to the user phone number that has initiated the output control action by SMS text message.

In addition, the system can make a phone call confirming that the output control action has been successfully carried out. Once enabled, output ON action will be followed by a 2-second (by default) ring, while the OFF action will be indicated by a 8-second (by default) ring to the user phone number that has initiated the output control action by SMS text message.

To manage the output control via SMS confirmations, please refer to the following configuration methods.

Disable output
control via SMS
confirmation by SMS

ONLY FOR ESIM251

SMS

SMS text message content:

`§sss_SMSEXTRA:OCS:SB0`

Value: §sss - 4-digit SMS password.

Example: `1111_SMSEXTRA:OCS:SB0`

Config
Tool

This operation may be carried out from the PC using the *ELDES Configuration Tool* software.

Enable output control
via SMS confirmation
by SMS

ONLY FOR ESIM251

SMS

SMS text message content:

`§sss_SMSEXTRA:OCS:SB1`

Value: §sss - 4-digit SMS password.

Example: `1111_SMSEXTRA:OCS:SB1`

Config
Tool

This operation may be carried out from the PC using the *ELDES Configuration Tool* software.

Enable output control via SMS confirmation by call back

ONLY FOR ESIM251

SMS

SMS text message content:

`ssss_SMSEXTRA:OCS:CB1`

Value: ssss - 4-digit SMS password.
Example: 1111_SMSEXTRA:OCS:CB1

Config Tool

This operation may be carried out from the PC using the *ELDES Configuration Tool* software.

Disable output control via SMS confirmation by call back

ONLY FOR ESIM251

SMS

SMS text message content:

`ssss_SMSEXTRA:OCS:CB0`

Value: ssss - 4-digit SMS password.
Example: 1111_SMSEXTRA:OCS:CB0

Config Tool

This operation may be carried out from the PC using the *ELDES Configuration Tool* software.

Set call back duration for output ON action

ONLY FOR ESIM251

SMS

SMS text message content:

`ssss_SMSEXTRA:OCS:CT1cd`

Value: ssss - 4-digit SMS password; cd - call back duration, range - [0... 60] seconds.
Example: 1111_SMSEXTRA:OCS:CT15

Config Tool

This operation may be carried out from the PC using the *ELDES Configuration Tool* software.

Set call back duration for output OFF action

ONLY FOR ESIM251

SMS

SMS text message content:

`ssss_SMSEXTRA:OCS:CT0cd`

Value: ssss - 4-digit SMS password; cd - call back duration, range - [0... 60] seconds.
Example: 1111_SMSEXTRA:OCS:CT020

Config Tool

This operation may be carried out from the PC using the *ELDES Configuration Tool* software.

Disable output control via SMS confirmation by SMS

ONLY FOR ESIM252

SMS

SMS text message content:

`ssss_SMSEXTRA:OCS:o:SB0`

Value: ssss - 4-digit SMS password; o - output number, range - [1... 2].
Example: 1111_SMSEXTRA:OCS2:SB0

Config Tool

This operation may be carried out from the PC using the *ELDES Configuration Tool* software.

Enable output control via SMS confirmation by SMS

ONLY FOR ESIM252

SMS

SMS text message content:

`ssss_SMSEXTRA:OCS:o:SB1`

Value: ssss - 4-digit SMS password; o - output number, range - [1... 2].
Example: 1111_SMSEXTRA:OCS1:SB1

Config Tool

This operation may be carried out from the PC using the *ELDES Configuration Tool* software.

Enable output control via SMS confirmation by call back

ONLY FOR ESIM252

SMS

SMS text message content:

`ssss_SMSEXTRA:OCSo:CB1`

Value: ssss - 4-digit SMS password; o - output number, range - [1... 2].

Example: 1111_SMSEXTRA:OCS2:CB1

Config Tool

This operation may be carried out from the PC using the *ELDES Configuration Tool* software.

Disable output control via SMS confirmation by call back

ONLY FOR ESIM252

SMS

SMS text message content:

`ssss_SMSEXTRA:OCSo:CB0`

Value: ssss - 4-digit SMS password; o - output number, range - [1... 2].

Example: 1111_SMSEXTRA:OCS2:CB0

Config Tool

This operation may be carried out from the PC using the *ELDES Configuration Tool* software.

Set call back duration for output ON action

ONLY FOR ESIM252

SMS

SMS text message content:

`ssss_SMSEXTRA:OCSo:CT1.cd`

Value: ssss - 4-digit SMS password; o - output number, range - [1... 2]; cd - call back duration, range - [0... 60] seconds.

Example: 1111_SMSEXTRA:OCS2:CT15

Config Tool

This operation may be carried out from the PC using the *ELDES Configuration Tool* software.

Set call back duration for output OFF action

ONLY FOR ESIM252

SMS

SMS text message content:

`ssss_SMSEXTRA:OCSo:CT0.cd`

Value: ssss - 4-digit SMS password; o - output number, range - [1... 2]; cd - call back duration, range - [0... 60] seconds.

Example: 1111_SMSEXTRA:OCS1:CT020

Config Tool

This operation may be carried out from the PC using the *ELDES Configuration Tool* software.

13.4. Automatic Output Control

ATTENTION: System date and time must be set, otherwise the system will NOT be able to control the output (-s) automatically. For more details on how to set date and time, please refer to **9. DATE AND TIME**.

The system comes equipped with an automatic output control in accordance with the scheduled time. When the scheduler is set up, the output will automatically turn ON/OFF on based on the specified time set for a certain duration. Once set up, the scheduler will operate once per day.

By default, the scheduler is not set up. To set up the scheduler and manage the output state, please refer to the following configuration methods.

Set scheduler start time

ONLY FOR ESIM251

SMS

SMS text message content:

`ssss_SMSEXTRA:OCTE:WThr.mn`

Value: ssss - 4-digit SMS password; hr - hours, range - [00... 23]; mn - minutes, range - [00... 59].

Example: 1111_SMSEXTRA:OCTE:WT14.16

Config Tool

This operation may be carried out from the PC using the *ELDES Configuration Tool* software.

Set scheduler duration

ONLY FOR ESIM251

SMS

SMS text message content:

`ssss_SMSEXTRA:OCTE:PT hr . mn`

Value: ssss - 4-digit SMS password; hr - hours, range - [00... 23]; mn - minutes, range - [00... 59].

Example: 1111_SMSEXTRA:OCTE:PT00.15

Config Tool

This operation may be carried out from the PC using the *ELDES Configuration Tool* software.

Set output state to ON

ONLY FOR ESIM251

SMS

SMS text message content:

`ssss_SMSEXTRA:OCTE:ST1`

Value: ssss - 4-digit SMS password.

Example: 1111_SMSEXTRA:OCTE:ST1

Config Tool

This operation may be carried out from the PC using the *ELDES Configuration Tool* software.

Set output state to OFF

ONLY FOR ESIM251

SMS

SMS text message content:

`ssss_SMSEXTRA:OCTE:ST0`

Value: ssss - 4-digit SMS password.

Example: 1111_SMSEXTRA:OCTE:ST0

Config Tool

This operation may be carried out from the PC using the *ELDES Configuration Tool* software.

Set scheduler start time

ONLY FOR ESIM252

SMS

SMS text message content:

`ssss_SMSEXTRA:OCTEo:W Thr . mn`

Value: ssss - 4-digit SMS password; o - output number, range - [1... 2]; hr - hours, range - [00... 23]; mn - minutes, range - [00... 59].

Example: 1111_SMSEXTRA:OCTE2:WT14.16

Config Tool

This operation may be carried out from the PC using the *ELDES Configuration Tool* software.

Set scheduler duration

ONLY FOR ESIM252

SMS

SMS text message content:

`ssss_SMSEXTRA:OCTEo:PT hr . mn`

Value: ssss - 4-digit SMS password; o - output number, range - [1... 2]; hr - hours, range - [00... 23]; mn - minutes, range - [00... 59].

Example: 1111_SMSEXTRA:OCTE1:PT00.15.10

Config Tool

This operation may be carried out from the PC using the *ELDES Configuration Tool* software.

Set output state to ON

ONLY FOR ESIM252

SMS

SMS text message content:

`ssss_SMSEXTRA:OCTEo:ST1`

Value: ssss - 4-digit SMS password; o - output number, range - [1... 2].

Example: 1111_SMSEXTRA:OCTE1:ST1

Config Tool

This operation may be carried out from the PC using the *ELDES Configuration Tool* software.

Set output state to OFF

ONLY FOR ESIM252

SMS

SMS text message content:

`ssss_SMSEXTRA:OCTE:STO`

Value: ssss - 4-digit SMS password; o - output number, range - [1... 2].

Example: `1111_SMSEXTRA:OCTE2:STO`

Config Tool

This operation may be carried out from the PC using the *ELDES Configuration Tool* software.

13.4.1. Output Control using Scheduler Confirmation

After turning the output ON or OFF, the system can send a confirmation reply by an SMS text message, containing the output name (see **13.1. Output Name (-s)**), to the user phone number that is specified to receive it upon execution of the output control action by scheduled time. In addition, the system can make a phone call confirming that the output control action has been successfully carried out. Once enabled, output ON action will be followed by a 2-second (by default) ring, while the OFF action will be indicated by a 8-second (by default) ring to the user phone number that is specified to receive it upon execution of the output control action by scheduled time.

By default, the output control using scheduler confirmations are disabled. To manage the output control using scheduler confirmations, please refer to the following configuration methods.

Select user for output control confirmation acceptance

ONLY FOR ESIM251

SMS

SMS text message content:

`ssss_SMSEXTRA:OCTE:UC1`

Value: ssss - 4-digit SMS password; u - user phone number slot, range - [1... 5].

Example: `1111_SMSEXTRA:OCTE:UC2`

Config Tool

This operation may be carried out from the PC using the *ELDES Configuration Tool* software.

Enable output control confirmation by SMS text message for scheduler start

ONLY FOR ESIM251

SMS

SMS text message content:

`ssss_SMSEXTRA:OCTE:SS1`

Value: ssss - 4-digit SMS password.

Example: `1111_SMSEXTRA:OCTE:SS1`

Config Tool

This operation may be carried out from the PC using the *ELDES Configuration Tool* software.

Disable output control confirmation by SMS text message for scheduler start

ONLY FOR ESIM251

SMS

SMS text message content:

`ssss_SMSEXTRA:OCTE:SS0`

Value: ssss - 4-digit SMS password.

Example: `1111_SMSEXTRA:OCTE:SS0`

Config Tool

This operation may be carried out from the PC using the *ELDES Configuration Tool* software.

Enable output control confirmation by SMS text message for scheduler end

ONLY FOR ESIM251

SMS

SMS text message content:

`ssss_SMSEXTRA:OCTE:SE1`

Value: ssss - 4-digit SMS password.

Example: `1111_SMSEXTRA:OCTE:SE1`

Config Tool

This operation may be carried out from the PC using the *ELDES Configuration Tool* software.

Disable output control confirmation by SMS text message for scheduler end

ONLY FOR ESIM251

SMS

SMS text message content:

`ssss_SMSEXTRA:OCTE:SE0`

Value: ssss - 4-digit SMS password.

Example: `1111_SMSEXTRA:OCTE:SE0`

Config Tool

This operation may be carried out from the PC using the *ELDES Configuration Tool* software.

Enable output control confirmation by call back for scheduler start

ONLY FOR ESIM251

SMS

SMS text message content:

`ssss_SMSEXTRA:OCTE:CS1`

Value: ssss - 4-digit SMS password.

Example: `1111_SMSEXTRA:OCTE:CS1`

Config Tool

This operation may be carried out from the PC using the *ELDES Configuration Tool* software.

Disable output control confirmation by call back for scheduler start

ONLY FOR ESIM251

SMS

SMS text message content:

`ssss_SMSEXTRA:OCTE:CS0`

Value: ssss - 4-digit SMS password.

Example: `1111_SMSEXTRA:OCTE:CS0`

Config Tool

This operation may be carried out from the PC using the *ELDES Configuration Tool* software.

Enable output control confirmation by call back for scheduler end

ONLY FOR ESIM251

SMS

SMS text message content:

`ssss_SMSEXTRA:OCTE:CE1`

Value: ssss - 4-digit SMS password.

Example: `1111_SMSEXTRA:OCTE:CE1`

Config Tool

This operation may be carried out from the PC using the *ELDES Configuration Tool* software.

Disable output control confirmation by call back for scheduler end

ONLY FOR ESIM251

SMS

SMS text message content:

`ssss_SMSEXTRA:OCTE:CE0`

Value: ssss - 4-digit SMS password.

Example: `1111_SMSEXTRA:OCTE:CE0`

Config Tool

This operation may be carried out from the PC using the *ELDES Configuration Tool* software.

Set call back duration for output ON action

ONLY FOR ESIM251

SMS

SMS text message content:

`ssss_SMSEXTRA:OCTE:CT1cd`

Value: ssss - 4-digit SMS password; *cd* - call back duration, range - [0... 60] seconds.

Example: `1111_SMSEXTRA:OCTE:CT15`

Config Tool

This operation may be carried out from the PC using the *ELDES Configuration Tool* software.

Set call back duration for output OFF action

ONLY FOR ESIM251

SMS

SMS text message content:

ssss_SMSEXTRA:OCTE:CTOcd

Value: ssss - 4-digit SMS password; cd - call back duration, range - [0... 60] seconds.

Example: 1111_SMSEXTRA:OCTE:CTO20

Config Tool

This operation may be carried out from the PC using the *ELDES Configuration Tool* software.

Select user phone number for output control confirmation acceptance

ONLY FOR ESIM252

SMS

SMS text message content:

ssss_SMSEXTRA:OCTEo:UCu

Value: ssss - 4-digit SMS password; o - output number, range - [1... 2]; u - user phone number slot, range - [1... 5].

Example: 1111_SMSEXTRA:OCTE1:UC2

Config Tool

This operation may be carried out from the PC using the *ELDES Configuration Tool* software.

Disable output control confirmation by SMS text message for scheduler start

ONLY FOR ESIM252

SMS

SMS text message content:

ssss_SMSEXTRA:OCTEo:SS0

Value: ssss - 4-digit SMS password; o - output number, range - [1... 2].

Example: 1111_SMSEXTRA:OCTE2:SS0

Config Tool

This operation may be carried out from the PC using the *ELDES Configuration Tool* software.

Enable output control confirmation by SMS text message for scheduler start

ONLY FOR ESIM252

SMS

SMS text message content:

ssss_SMSEXTRA:OCTEo:SS1

Value: ssss - 4-digit SMS password; o - output number, range - [1... 2].

Example: 1111_SMSEXTRA:OCTE1:SS1

Config Tool

This operation may be carried out from the PC using the *ELDES Configuration Tool* software.

Disable output control confirmation by SMS text message for scheduler end

ONLY FOR ESIM252

SMS

SMS text message content:

ssss_SMSEXTRA:OCTEo:SE0

Value: ssss - 4-digit SMS password; o - output number, range - [1... 2].

Example: 1111_SMSEXTRA:OCTE1:SE0

Config Tool

This operation may be carried out from the PC using the *ELDES Configuration Tool* software.

Enable output control confirmation by SMS text message for scheduler end

ONLY FOR ESIM252

SMS

SMS text message content:

ssss_SMSEXTRA:OCTEo:SE1

Value: ssss - 4-digit SMS password; o - output number, range - [1... 2].

Example: 1111_SMSEXTRA:OCTE2:SE1

Config Tool

This operation may be carried out from the PC using the *ELDES Configuration Tool* software.

Enable output control confirmation by call back for scheduler start

ONLY FOR ESIM252

SMS

SMS text message content:

`ssss_SMSEXTRA:OCTEo:CS1`

Value: ssss - 4-digit SMS password; o - output number, range - [1... 2].

Example: 1111_SMSEXTRA:OCTE2:CS1

Config Tool

This operation may be carried out from the PC using the *ELDES Configuration Tool* software.

Disable output control confirmation by call back for scheduler start

ONLY FOR ESIM252

SMS

SMS text message content:

`ssss_SMSEXTRA:OCTEo:CS0`

Value: ssss - 4-digit SMS password; o - output number, range - [1... 2].

Example: 1111_SMSEXTRA:OCTE1:CS0

Config Tool

This operation may be carried out from the PC using the *ELDES Configuration Tool* software.

Enable output control confirmation by call back for scheduler end

ONLY FOR ESIM252

SMS

SMS text message content:

`ssss_SMSEXTRA:OCTEo:CE1`

Value: ssss - 4-digit SMS password; o - output number, range - [1... 2].

Example: 1111_SMSEXTRA:OCTE1:CE1

Config Tool

This operation may be carried out from the PC using the *ELDES Configuration Tool* software.

Disable output control confirmation by call back for scheduler end

ONLY FOR ESIM252

SMS

SMS text message content:

`ssss_SMSEXTRA:OCTEo:CE0`

Value: ssss - 4-digit SMS password; o - output number, range - [1... 2].

Example: 1111_SMSEXTRA:OCTE2:CE0

Config Tool

This operation may be carried out from the PC using the *ELDES Configuration Tool* software.

Set call back duration for output ON action

ONLY FOR ESIM252

SMS

SMS text message content:

`ssss_SMSEXTRA:OCTEo:CT1cd`

Value: ssss - 4-digit SMS password; o - output number, range - [1... 2]; cd - call back duration, range - [0... 60] seconds.

Example: 1111_SMSEXTRA:OCTE2:CT15

Config Tool

This operation may be carried out from the PC using the *ELDES Configuration Tool* software.

Set call back duration for output OFF action

ONLY FOR ESIM252

SMS

SMS text message content:

`ssss_SMSEXTRA:OCTEo:CT0cd`

Value: ssss - 4-digit SMS password; o - output number, range - [1... 2]; cd - call back duration, range - [0... 60] seconds.

Example: 1111_SMSEXTRA:OCTE1:CT020

Config Tool

This operation may be carried out from the PC using the *ELDES Configuration Tool* software.

14. SYSTEM INFORMATION. INFO SMS

The system supports an informational SMS text message identified as the Info SMS, which can be delivered upon request. Once requested, the system will reply with Info SMS that provides the following:

- System date & time.
- GSM signal strength.
- State of inputs (OK/alarm).

Request for system information

SMS

SMS text message content:

`ssss_INFO`

Value: ssss - 4-digit SMS password.

Example: `1111_INFO`

14.1. Periodic Info SMS

By default, the system sends Info SMS to user phone number periodically once a day at 11:00 (frequency - 1 day; time - 11). The minimum period is every 1 hour (frequency - 0 days; time - 1). Typically, this feature is used to verify the power supply and online status of the system. To set a different frequency and time or disable periodic Info SMS, please refer to the following configuration methods.

Set periodic Info SMS frequency and time

SMS

SMS text message content:

`ssss_INFO:fff:it`

Value: ssss - 4-digit SMS password; *fff* - frequency, range - [00... 99] days; *it* - time, range - [01... 23].

Example: `1111_INFO:3.15`

Config Tool

This operation may be carried out from the PC using the *ELDES Configuration Tool* software.

Disable periodic Info SMS

SMS

SMS text message content:

`ssss_INFO:00:00`

Example: `1111_INFO:00.00`

Config Tool

This operation may be carried out from the PC using the *ELDES Configuration Tool* software.

ATTENTION: System date and time must be set, otherwise periodic Info SMS will be delivered incorrectly. For more details on how to set date and time, please refer to **9. DATE AND TIME**.

15. SYSTEM NOTIFICATIONS

By default in case of a certain event, the system attempts to send an SMS text message to the first listed user phone number only. If the user phone number is unavailable and the system fails to receive the SMS delivery report within 45 seconds, it will attempt to send the SMS text message to the next listed user phone number. The user phone number may be unavailable due to the following reasons:

- mobile phone was switched off.
- was out of GSM signal coverage.

The system will continue sending the SMS text message to the next listed user phone numbers in the priority order until one is available. The system sends the SMS text message only once and will not return to the first user phone number if the last one was unavailable.

To change the SMS text message delivery algorithm, user can enable/disable the following parameter:

SMS ACK (delivery report) - This parameter determines whether to request for SMS delivery report or not. Once disabled, the system will not verify the status of the SMS text message delivery and will attempt to deliver the SMS text message only to the first listed user phone number regardless if the next listed user phone number (-s) is enabled to receive a certain event by SMS text message or not.

The following table provides the description of system notifications by SMS text message sent to the user phone number.

Seq. No.	Event	Description
1	System Startup	SMS text message sent to the user on system startup. For more details on how to manage this notification, please refer to the configuration methods below.
2	Input Alarm	SMS text message sent to the user in case input is violated. For more details on how to manage this notification, please refer to 11. ALARM/RESTORE NOTIFICATIONS .
3	Input Restore	SMS text message sent to the user in case input is restored. For more details on how to manage this notification, please refer to 11. ALARM/RESTORE NOTIFICATIONS .
4	Periodic Info	Status SMS text message sent to the user periodically by the set up hours. For more details on how to manage this notification, please refer to 14. SYSTEM INFORMATION. INFO SMS .

By default, System Startup notification is enable. To disable/enable it , please refer to the following configuration method.

Manage System
Startup notification

Config
Tool

This operation may be carried out from the PC using the *ELDES Configuration Tool* software.

15.1. SMSC (Short Message Service Center) Phone Number

An SMS center (SMSC) is a GSM network element, which routes SMS text messages to the destination recipient and stores the SMS text message if the recipient is unavailable. Typically, the phone number of the SMS center is already stored in the SIM card provided by the GSM operator. If the user fails to receive replies from the system, the SMS center phone number, provided by the GSM operator, must be set manually.

Set SMSC phone
number

SMS

SMS text message content:

`ssss_SMS_+ttteeeInnuumm`

Value: ssss - 4-digit SMS password; ttteeeInnuumm - up to 15 digits SMSC phone number.

Example: `1111_SMS_+441703111111`

16. EVENT LOG

This feature allows to chronologically register up to 500 timestamped records regarding the following system events:

- Input alarm and restore events
- Output control by free of charge phone call and SMS text message events
- Automatic output control based on scheduler beginning.
- Automatic output control based on scheduler ending.
- Periodic info event

The event log is of LIFO (last in, first out) type that allows the system to automatically replace the oldest records with the the latest ones.

By default, event log is disabled. To enable/disable this feature, please refer to the following configuration methods.

**Enable/disable
event log**

**Config
Tool**

This operation may be carried out from the PC using the *ELDES Configuration Tool* software.

To export the event log to .log file or clear it, please refer to the following configuration methods.

**Export/clear
event log**

**Config
Tool**

This operation may be carried out from the PC using the *ELDES Configuration Tool* software.

17. REMOTE LISTENING

ESIM251/ESIM252 may be equipped with a microphone that allows the user to listen on his mobile phone to what is happening in the area surrounding the microphone. Remote listening feature can operate under the following conditions:

- The system makes a phone call via GSM to a listed user phone number in case of input alarm/restore and the user answers the call. The "conversation" will last for up to 36 seconds until the system automatically hangs up.
- The user initiates remote listening by sending the SMS text message, the system makes a phone call to the user phone number that the SMS text message was sent from and the user answers the call. The "conversation" will last until the user hangs up.

Initiate remote listening

SMS

SMS text message content:

`§sss_MIC`

Value: §sss - 4-digit SMS password.

Example: `1111_MIC`

Set microphone gain

Config Tool

This operation may be carried out from the PC using the *ELDES Configuration Tool* software.

ATTENTION: The system will NOT transmit any data to the monitoring station while remote listening is in progress. However, during the remote listening process, the data messages will be queued up and transmitted to the monitoring station after the remote listening process is over.

18. GPRS NETWORK SETTINGS

The GPRS network settings are used for device communication with the remote configuration server or monitoring station via GPRS network connection. To set the GPRS network settings, please refer to the following configuration methods.

Set APN

SMS

SMS text message content:

`§sss_SETGPRS:APN:acc-point-name`

Value: §sss - 4-digit SMS password; *acc-point-name* - up to 31 character APN (Access Point Name) provided by the GSM operator.

Example: `1111_SETGPRS:APN:internet`

Set user name

SMS

SMS text message content:

`§sss_SETGPRS:USER:usr-name`

Value: §sss - 4-digit SMS password; *usr-name* - up to 31 character user name provided by the GSM operator.

Example: `1111_SETGPRS:USER:mobileusr`

Set password

SMS

SMS text message content:

`§sss_SETGPRS:PSW:password`

Value: §sss - 4-digit SMS password; *password* - up to 31 character password provided by the GSM operator.

Example: `1111_SETGPRS:PSW:mobilepsw`

View GPRS settings

SMS

SMS text message content:

`§sss_SETGPRS?`

Value: §sss - 4-digit SMS password.

Example: `1111_SETGPRS?`

NOTE: Multiple parameters can be set by single SMS text message, **Example:** `1111_SETGPRS:APN:internet;USER:mobileusr;PSW:mobilepsw`

19. MONITORING STATION

The system can be configured to report events to the monitoring station by transmitting data messages to the monitoring station. The system connects to the monitoring station when the MS (Monitoring Station) mode is enabled.

Enable/disable
MS mode

Config
Tool

This operation may be carried out from the PC using the *ELDES Configuration Tool* software.

Account is a 4-digit number (By default - 9999) required to identify the alarm system unit by the monitoring station.

Set account

Config
Tool

This operation may be carried out from the PC using the *ELDES Configuration Tool* software.

ATTENTION: The system will NOT transmit any data to the monitoring station while remote configuration, remote firmware update or remote listening is in progress. However, during the remote configuration session, firmware update process or remote listening process, the data messages will be queued up and transmitted to the monitoring station after the remote configuration session, firmware update or remote listening process is over.

19.1. Data Messages - Events

The configuration of data messages is based on Ademco Contact ID protocol. The data messages can either be transmitted to the monitoring station alone or with duplication by SMS text message to the listed user phone number. For more details on system notifications by SMS text message, please refer to **15. SYSTEM NOTIFICATIONS**.

Seq. No.	Contact ID® Code	Event	Description
1	1130	Input alarm	Transmitted in case an input is violated.
2	3130	Input restore	Transmitted in case an input is restored.
3	1602	Test event	Transmitted for system online status verification purposes.
4	3626	Date/time not set	Transmitted in case system date & time is not set.
5	1354	GPRS connection loss	Transmitted in case the GPRS connection is lost.

Manage data
messages

Config
Tool

This operation may be carried out from the PC using the *ELDES Configuration Tool* software.

19.2. Communication

The system supports the following communication methods and protocols:

- GPRS network - EGR100 and Kronos protocol.
- Voice calls (GSM audio channel) - Ademco Contact ID protocol.

Any communication method can be set as primary or backup connection. The user can set up to 5 backup connections in any sequence order.

Initially, the system communicates via primary connection with the monitoring station. By default, if the initial attempt to transmit data is unsuccessful, the system will make additional attempts until the data is successfully delivered. If all attempts are unsuccessful, the system will follow this pattern:

- a) The system switches to the backup connection.
- b) The system then attempts to transmit data by the backup connection.
- c) If the initial attempt is unsuccessful, the system will make additional attempts until the data is successfully delivered. The connection is considered unsuccessful under the following conditions:
 - GPRS network - The system has not received the ACK data message from the monitoring station within 40 seconds.
 - Voice calls:
 - The system has not received the "handshake" signal from the monitoring station within 40 seconds.
 - The system has not received the "kissoff" signal from the monitoring station within 5 attempts each lasting 1 second.
- e) If one of the attempts is successful, the system will transmit all queued up data messages by this connection.

- f) The system then returns to the primary connection and attempts to transmit the next data messages by primary connection.
- g) If the system ends up with all unsuccessful attempts by all connections, it will wait until the *Delay after last communication attempt* time (By default - 600 seconds) expires and will return to the primary connection afterwards.
- h) If a new data message, except Test Event (ping), is generated during *Delay after last communication attempt* time, the system will immediately attempt to transmit it to the monitoring station, regardless of *Delay after last communication attempt* being in progress.

Set primary/backup connection



This operation may be carried out from the PC using the *ELDES Configuration Tool* software.

If all attempts by all set connections are unsuccessful, the system will wait until the delay time (By default - 600 seconds) expires and will attempt to transmit data to the monitoring station again starting with the primary connection.

Set delay after last communication attempt



This operation may be carried out from the PC using the *ELDES Configuration Tool* software.

NOTE: 0 value disables delay after last communication attempt.

NOTE: The system is fully compatible with Kronos NET/Kronos LT monitoring station software for communication via GPRS network. When using a different monitoring station software, EGR100 middleware is required. EGR100 is freeware and can be downloaded at www.eldes.lt/en/download

NOTE: Voice Calls communication method is supported by product s/n: 0010742 and up.

19.2.1. GPRS Network

The system supports data transmission to the monitoring station via IP-based networks by GPRS network. The supported data formats are the following:

- EGR100
- Kronos

To set up the system for data transmission via GPRS network, please follow the basic configuration steps:

1. Enable MS Mode parameter (see **19. MONITORING STATION**).
2. Set 4-digit Account number (see **19. MONITORING STATION**).
3. Set server IP address, which is a public IP address of the machine running EGR100 middle-ware or Kronos monitoring station software.
4. Set server port, which is a port of the machine running EGR100 middle-ware or Kronos monitoring station software.
5. Select TCP or UDP protocol. UDP is highly recommended for EGR100 data format.
6. Select data format: EGR100 or Kronos.
7. In case EGR100 is selected, set 4-digit Unit ID number. Unit ID number can be identical to Account number.
8. Set up APN, user name and password provided by the GSM operator. Depending on the GSM operator, only APN might be required to set up (see **18. GPRS NETWORK SETTINGS**).

For detailed step-by-step instructions on how to establish the communication between ESIM364 alarm system and EGR100 middleware, please refer to the middleware's HELP file.

Set server IP address



SMS text message content:

`ssss_SETGPRS:IP:add.add.add.add`

Value: ssss - 4-digit SMS password; *add.add.add.add* - server IP address.

Example: `1111_SETGPRS:IP:65.82.119.5`

Set server port



SMS text message content:

`ssss_SETGPRS:PORT:pprrt`

Value: ssss - 4-digit SMS password; *pprrt* - server port number, range - [1... 65535].

Example: `1111_SETGPRS:PORT:5521`

Set protocol

SMS

SMS text message content:

`ssss_SETGPRS:PROTOCOL:ptc`

Value: ssss - 4-digit SMS password; ptc - protocol, range - [TCP... UDP].

Example: 1111_SETGPRS:PROTOCOL:UDP

Set Set data format as EGR100 or Kronos

Config Tool

This operation may be carried out from the PC using the *ELDES Configuration Tool* software.

Set DNS1/ DNS2 server IP address

Config Tool

This operation may be carried out from the PC using the *ELDES Configuration Tool* software.

NOTE: Kronos NET/Kronos LT software communicates via TCP protocol, while EGR100 middle-ware v1.2 and up supports both - TCP and UDP protocols. However, TCP protocol is NOT recommend to use with EGR100.

ATTENTION: It is necessary to restart the system locally by powering down and powering up the system the system after changing the IP address or switching from TCP to UDP.

By default, if the initial attempt to transmit data to the monitoring station via GPRS network method is unsuccessful, the system will make up to 2 additional attempts. If all attempts are unsuccessful, the system will switch to next backup connection that follows in the sequence and will attempt to transmit data until it is successfully delivered to the monitoring station.

Set attempts

Config Tool

This operation may be carried out from the PC using the *ELDES Configuration Tool* software.

To report the online status, the system periodically transmits (By default - every 180 seconds) Test Event data message (ping) to the monitoring station via GPRS network.

Set test period

Config Tool

This operation may be carried out from the PC using the *ELDES Configuration Tool* software.

NOTE: 0 value disables test period.

Unit ID is a 4-digit number (By default - 0000) required to identify the alarm system unit by EGR100 middle-ware. It is MANDATORY to change the default Unit ID before using EGR100.

Set Unit ID

Config Tool

This operation may be carried out from the PC using the *ELDES Configuration Tool* software.

View GPRS settings

SMS

SMS text message content:

`ssss_SETGPRS?`

Value: ssss - 4-digit SMS password.

Example: 1111_SETGPRS?

NOTE: Multiple parameters can be set by single SMS text message, Example: 1111_SETGPRS:IP:22.66.33.44;PORT:1234;PROTOCOL:UDP

19.2.2. Voice Calls

The system supports up to 3 monitoring station phone numbers for communication with the alarm system by Voice Calls communication method using Ademco Contact ID data format. Tel. Number 1 is mandatory, the other two can be used as backup phone numbers and are not necessary. The supported phone number formats are the following:

- **International (with plus)** - The phone numbers must be entered starting with plus and an international country code in the following format: +[international code][area code][local number], example for UK: +441709xxxxxxx.
- **International (with 00)** - The phone numbers must be entered starting with 00 and an international country code in the following format: 00[international code][area code][local number], example for UK: 00441709xxxxxxx.

- **Local** – The phone numbers must be entered starting with an area code in the following format: [area code][local number], example for UK: 01709xxxxxx.

To set up the system for data transmission via Voice Calls, please follow the basic configuration steps:

1. Enable MS Mode parameter (see **19. MONITORING STATION**).
2. Set 4-digit Account number (see **19. MONITORING STATION**).
3. Set Tel. Number 1... 3.

Set/delete monitoring station phone number

Config Tool

This operation may be carried out from the PC using the *ELDES Configuration Tool* software.

By default, if the initial attempt to transmit data to the monitoring station's Tel Number 1 via Voice Calls method is unsuccessful, the system will make up to 4 additional attempts. After all unsuccessful attempts, the system will continue to communicate with the monitoring station by switching to the next phone number that follows in the sequence and making up to 4 additional attempts if the initial attempt is unsuccessful. If all attempts to all phone numbers are unsuccessful, the system will switch to the backup connection and will attempt to transmit data until it is successfully delivered to the monitoring station.

Set attempts

Config Tool

This operation may be carried out from the PC using the *ELDES Configuration Tool* software.

Due to the individual configuration of each monitoring station, the system may fail to deliver the data message via Voice Calls communication method. In such cases it is recommended to adjust the microphone gain until the optimal value, leading to successful data message delivery, is discovered.

Set microphone gain

Config Tool

This operation may be carried out from the PC using the *ELDES Configuration Tool* software.

NOTE: Voice Calls communication method is supported by product s/n: 0010742 and up.

20. PROJECT EXAMPLES AND CONFIGURATION

20.1. Using in Enterprises

The user wants to connect ESIM251 system to an existing alarm system in a building where enterprise A and enterprise B are based at. Both enterprises use the same alarm system that features two zones. The alarm system has 5 PGM outputs.

Task NO1:

Configuring the system in the way so that the director of a particular enterprise would be informed regarding system arming depending on which enterprise worker has carried out the system arming process. The director of enterprise A (NO1) wants to receive an SMS text message only and does not wish to receive any calls, while the director of enterprise B (NO2) wants to receive a call and does not wish to receive any SMS text messages.

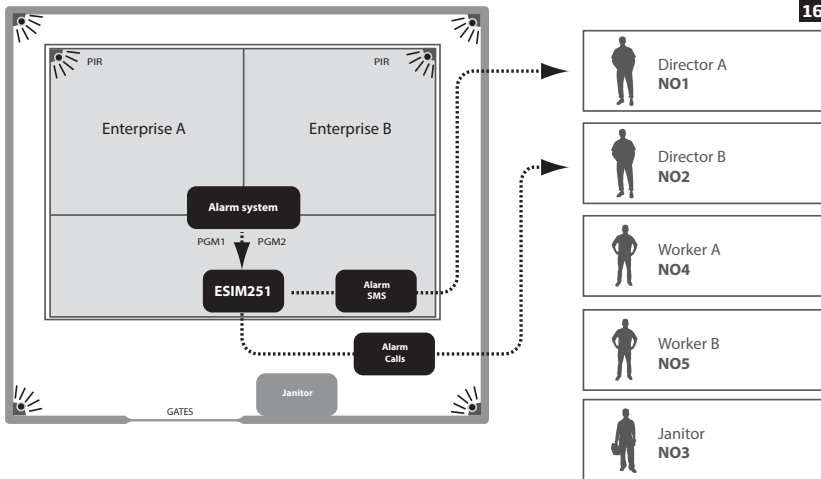

By default, SMS text message sending feature in the case of alarm is enabled for all users until the first successful delivery of the SMS text message, therefore it is necessary to remove the users that should not receive any alarm SMS text messages. In addition, by default, calls in case of alarm are also enabled for all users, therefore this feature must be disabled for all users, except user NO2.

- First of all the alarm system unit must be configured in the way so that arming the system in enterprise A, would result in PGM1 being turned ON, while when the system is disarmed in enterprise B, PGM2 would result in being turned OFF.
- PGM1 has to be connected to ESIM251 input Z1, while PGM2 must be connected to ESIM251 input Z2. (PGM2 must be of "high level")
- The following SMS text messages must be sent to ESIM251 system:

`ssss_SMSEXTRA:Z1:SC2345,CC12345`

SC2345 = alarm SMS text message sending to users NO2-NO5 is disabled if Z1 input is violated.

CC12345 = alarm calls are disabled for all users NO1-NO5 if Z1 input is violated.

`ssss_SMSEXTRA:Z2:SC12345,CC1345`

SC12345 = alarm SMS text message sending is disabled for all users NO1-NO5 if Z2 input is violated.

CC1345 = all alarm calls are disabled for users NO1, NO3-NO5 if Z2 input is violated.

Task NO2:

Configuring the system in the way so that the janitor (NO3) would be informed regarding the triggered PIR sensor in the secured area by SMS text message and a phone call; when the sensor is restored, the janitor receives the SMS text message only.

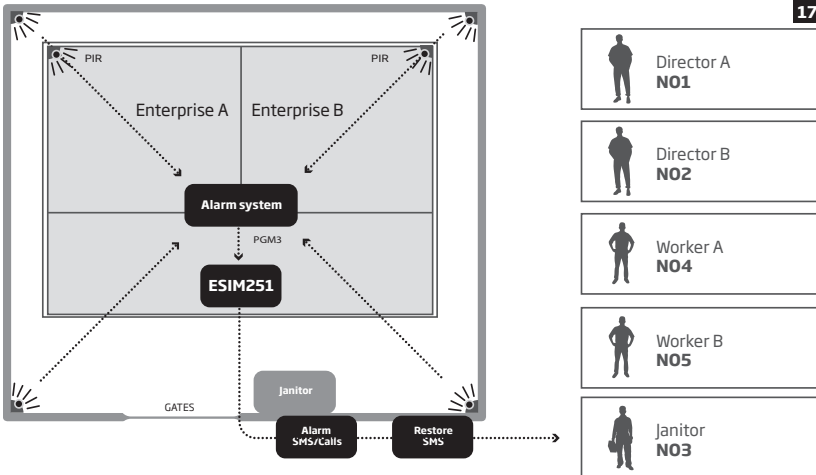

By default, SMS text message sending feature in the case of alarm is enabled for all users until the first successful delivery of the SMS text message, therefore it is necessary to remove the users that should not receive any alarm messages. In addition, by default, calls in case of alarm are also enabled for all users, therefore this feature must be disabled for all users, except user NO3. SMS text message sending feature must also be enabled for user NO3 when input Z3 is restored.

- a) First of all alarm system unit must be configured in the way so that triggering PIR sensor would result in PGM3 being turned ON.
- b) PGM3 has to be connected to ESIM251 input Z3
- c) The following SMS text message must be sent to ESIM251 system:

```
ssss_SMSEXTRA:Z3:SC1245,CC1245,SE3
```

SC1245 = alarm SMS text message sending to users NO1, NO2, NO4 and NO5 is disabled after Z3 is violated.

CC1245 = alarm call feature is disabled for users NO1, NO2, NO4 and NO5 after input Z3 is violated.

SE3 = SMS text message sending feature is enabled for user NO3 after Z3 input is violated.

Task N03:

Configuring the system in the way so that the intrusion to enterprise A premises would be reported to the janitor (N03) and enterprise A worker (N04) by SMS text messages and calls. Enterprise A worker (N04) wishes to receive a call only if the janitor (N03) has not answered the call, his mobile phone is out of GSM signal coverage or in case it provides a "busy" tone.

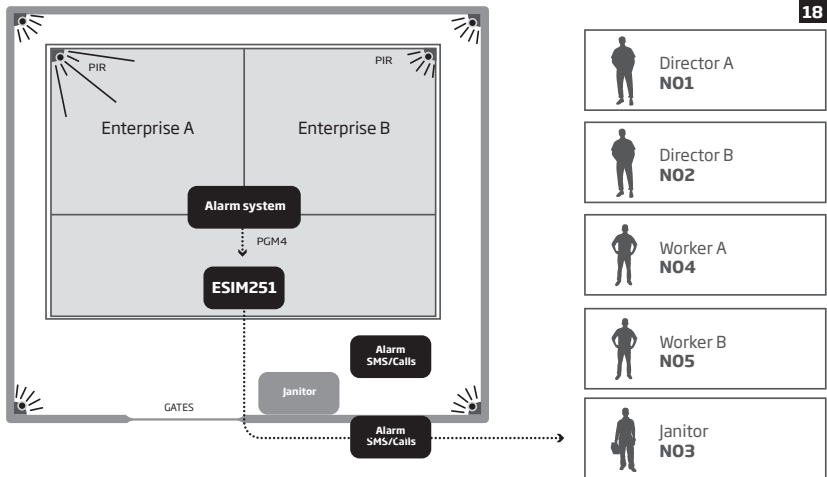

By default, SMS text message sending feature in the case of alarm is enabled for all users until the first successful delivery of the SMS text message, therefore it is necessary to enable mandatory SMS text message delivery and to remove the users who should not receive alarm messages. In addition, by default, calls in case of alarm are also enabled for all users, therefore this feature must be disabled for all users, except users N03 and N04. By default, in the case of alarm the system rings until the first answered call, therefore in this case nothing should be configured.

- First of all alarm system unit must be configured in the way so that triggering a PIR sensor of enterprise A would result in PGM4 being turned ON.
- PGM4 has to be connected to ESIM251 input Z4
- The following SMS text messages must be sent to ESIM251 system:

```
ssss_SMSALL:ON
```

SMSALL = enables mandatory SMS text message delivery feature for all users.

```
ssss_SMSEXTRA:Z4:SC125,CC12
```

SC125 = alarm SMS text message delivery feature is disabled for users N01, N02 and N05 if Z4 input is violated.

CC125 = alarm calls are disabled for users N01, N02 and N05 if Z4 input is violated.

Task NO4:

Configuring the system in the way so that the intrusion to enterprise B premises would be reported to the janitor (NO3) and enterprise B worker (NO5) by SMS text messages and calls, and the director of enterprise B (NO2) by SMS text message only. Enterprise B worker (NO5) must receive a phone call even if the janitor (NR3) has answered the call.

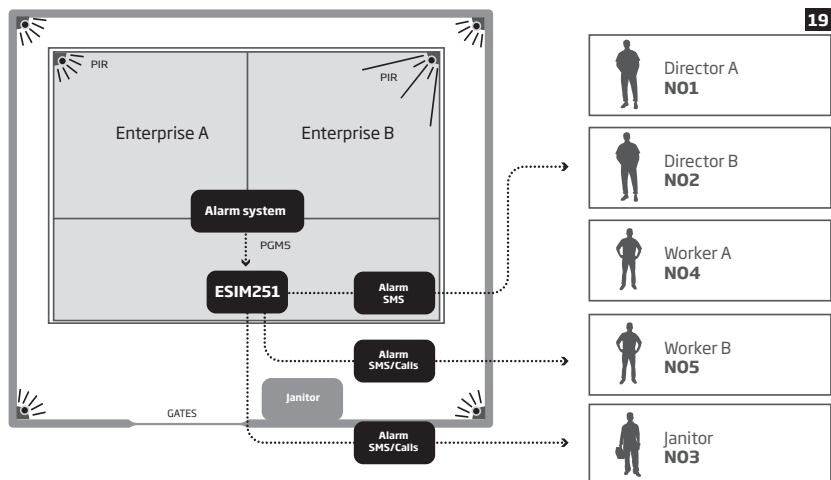

By default, SMS text message sending feature in the case of alarm is enabled for all users until the first successful delivery of the SMS text message, therefore it is necessary to enable mandatory SMS text message delivery and to remove the users who should not receive alarm messages. In addition, by default, calls in case of alarm are also enabled for all users, therefore this feature must be disabled for users NO1, NO2 and NO4, and left enabled for users NO3 and NO5. Also, it is necessary to enable mandatory calling feature for all listed users.

- First of all alarm system unit must be configured in the way so that triggering a PIR sensor of enterprise A would result in PGM5 being turned ON.
- PGM has to be connected to ESIM251 input Z5
- The following SMS text messages must be sent to ESIM251 system:

```
ssss_SMSALL:ON
```

SMSALL = enables mandatory SMS text message delivery feature for all users.

```
ssss_CALLALL:ON
```

CALLALL = enables mandatory calling feature for all users.

```
ssss_SMSEXTRA:Z5;SC14,CC124
```

SC14 = alarm SMS text message sending feature is disabled for users NO1 and NO4 if Z5 input is violated.

CC124 = alarm calls are disabled for users NO1, NO2 and NO4 if Z5 input is violated.

20.2. Using in a Private House

The user wants to connect ESIM251 system to the PGM outputs of an existing alarm system. House area is accessible through electrically controlled gates. There are 5 users in total. NO1 is the housekeeper, NO2 is a neighbour, while NO3-NO5 are the family members.

Task NO1:

Configuring the system in the way so that the alarm activation in house would be reported to the housekeeper (NO1) by SMS text message and a call as well as to the neighbour (NO2) by SMS text message only.

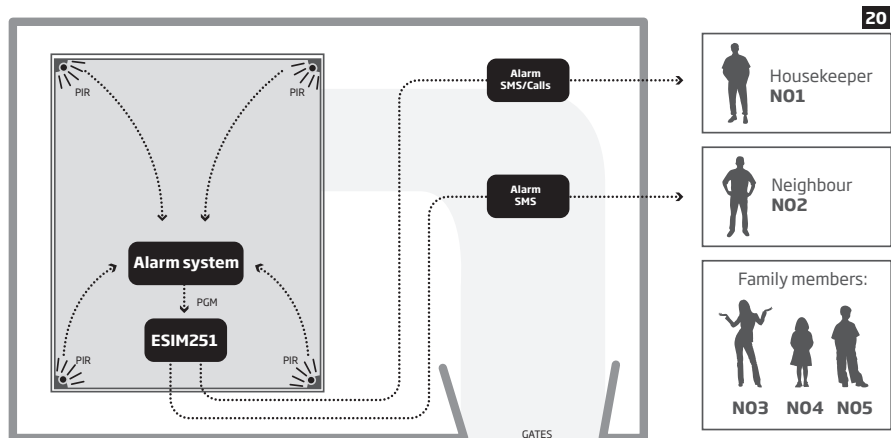

By default, SMS text message sending feature in the case of alarm is enabled for all users until the first successful delivery of the SMS text message, it is necessary to enable mandatory SMS text message delivery and to remove the users who should not receive alarm messages. In addition, by default, calls in case of alarm are also enabled for all users, therefore this feature must be disabled for users NO2-NO5 and left enabled for NO1 only.

- First of all alarm system unit must be configured in the way so that triggering a PIR sensor in a house would result in PGM being turned ON.
- PGM has to be connected to ESIM251 input Z1
- The following SMS text messages must be sent to ESIM251 system:

`ssss_SMSALL:ON`

SMSALL = enables mandatory SMS text message delivery for all users.

`ssss_SMSEXTRA:Z1:SC345,CC2345`

SC345 = alarm SMS text message sending is disabled for users NO3, NO4 and NO5 if Z1 input is violated.

CC2345 = alarm calls are disabled for all users except NO1 after Z1 input is violated.

Task N02:

Configuring the system in the way so that house gates could be opened via free of charge calls by the housekeeper (N01) and his family members (N03), (N04) and (N05). After every successful gate opening the user N05 wishes to receive a confirmation call (CALLBACK) lasting for 3 seconds, while user N03 wishes to receive a confirmation by SMS text message.

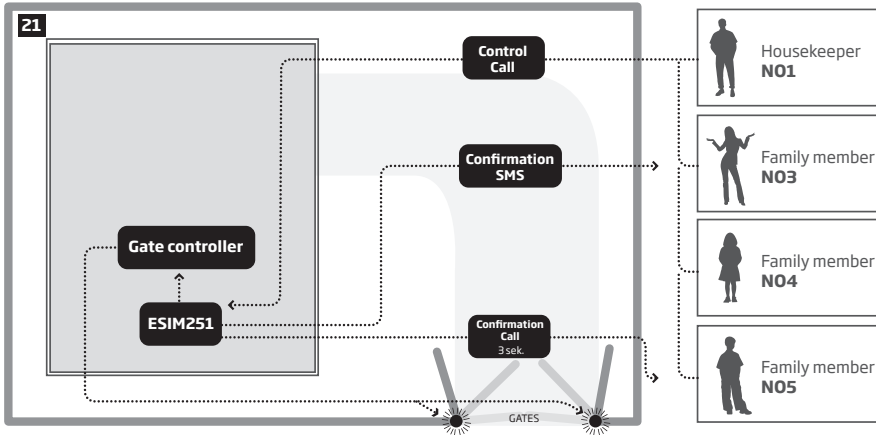

By default, C1 output control via calls is disabled for all users, therefore it is necessary to enable this feature and to set the users who will be able to control the output. In addition, it is also necessary to set the output state for every user when he/she dials the system phone number. In this case the output must be turned ON for 1 second; once this this period expires, the output will return to the previous state. Confirmation call feature must be enabled for user N05 and it is necessary to set the duration parameters for that call. Also, confirmation by SMS text messages have to be enabled for user N03.

a) First of all ESIM251 output has to be connected to the gate automation equipment.

b) The following SMS text message must be sent to ESIM251 system:

```
ssss_SMSEXTRA:COC:CE1345,CS5,CT513,SS3,MS10,MS30,MS40,MS50,MS1T0.0.1,MS3T0.0.1,MS4T0.0.1,MS5T0.0.1
```

CE1345 = C1 relay control via call is enabled for users N01, N03-N05.

CS5 = confirmation call feature is enabled for user N05 after C1 relay status changes.

CT513 = user N05 will receive a confirmation call when the relay gets activated and call duration is 3 seconds.

SS3 = user N03 will be informed about C1 relay status change by SMS text message.

MS10 = output is turned ON when user N01 calls the system.

MS30 = output is turned ON when user N03 calls the system.

MS40 = output is turned ON when user N04 calls the system.

MS50 = output is turned ON when user N05 calls the system.

MS1T0.0.1 = output state is changed for 1 second when user N01 calls the system.

MS3T0.0.1 = output state is changed for 1 second when user N03 calls the system.

MS4T0.0.1 = output state is changed for 1 second when user N04 calls the system.

MS5T0.0.1 = output state is changed for 1 second when user N05 calls the system.

20.3. Using with Heating System and Flood Detector

The user wants to connect ESIM251 system to the heating system of the house.

Task No1:

Configuring the system in the way so that house heating system is turned ON and turned OFF by the user (N01) using a free of charge phone call. This user should also receive a free of charge confirmation regarding successful turning ON or turning OFF of the heating system.

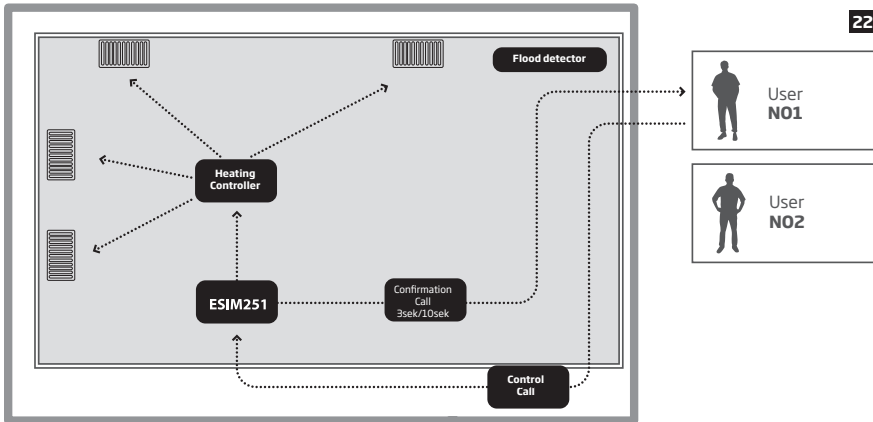

By default, C1 output control via call is disabled for all users, therefore it is necessary to enable this feature and set the users who will be able to control the output - in this case it is user N01. In addition, it is also necessary to set the output state for user N01 when he/she dials the system phone number. In this case it is necessary to set the system so that the output is turned OFF after one call and turned OFF after another one (Toggle) and so on. User N01 needs to enable confirmation call feature and set the duration parameters for that call. To identify whether the output has been turned ON, the confirmation call will last for 3 seconds, while when the output has been turned OFF, the confirmation call will last for 10 seconds

- First of all ESIM251 output C1 has to be connected to the heating system control unit.
- The following SMS text message must be sent to ESIM251 system:

```
5555_SMSEXTRA:COC:CE1,CS1,CT113,CT1010,MS12
```

CE1 = C1 output control via call is enabled for users N01.

CS1 = confirmation call feature is enabled for user N01 if C1 output state changes.

CT113 = user N01 will receive a confirmation call when the output is turned ON and call duration is 3 seconds.

CT1010 = user N01 will receive a confirmation call when the output is turned OFF and call duration is 10 seconds.

MS12 = Toggle mode is enabled for user N01, which means that the output state is changed with every call.

Task No2:

Configuring the system in the way so that users (N01) and (N02) receive an SMS text message regarding a burst of a water pipe (flood) at home. SMS text messages must be delivered to both users.

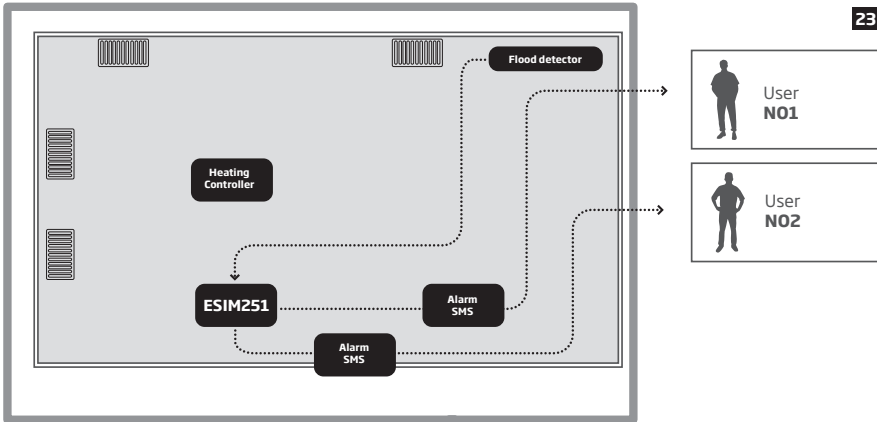

By default, SMS text message sending feature in case of alarm is enabled for all users until the first successful delivery of the SMS text message and calling in the case of alarm is enabled for all users until the first answered call, therefore the calls in case of alarm must be disabled for users N01 and N02. Mandatory SMS delivery to all users must be enabled.

- First of all a flood sensor has to be connected to ESIM251 input Z1.
- The following configuration SMS text messages must be sent to ESIM251 system:

`ssss_SMSALL:ON`

SMSALL = enables mandatory SMS text message delivery feature for all users.

`ssss_SMSEXTRA:Z1:CC12`

CC12 = alarm call feature is disabled for users N01, N02 if Z1 input is violated. We make an assumption that users N03-N05 are not listed in the system at all.

20.4. Using for Breakdown Reports

The company taking care of automatic systems needs to be informed regarding some critical breakdowns of mechanisms and has to quickly respond in order to eliminate the breakdown. There are three members of the operating personnel (NO1), (NO2) and (NO3).

Task No1:

Configuring the system in the way so that operating personnel member (NO1) receives SMS text message regarding the breakdown of gas boiler. While the gas boiler is operating normally it transmits a signal; when it breaks down the signal is no longer transmitted.

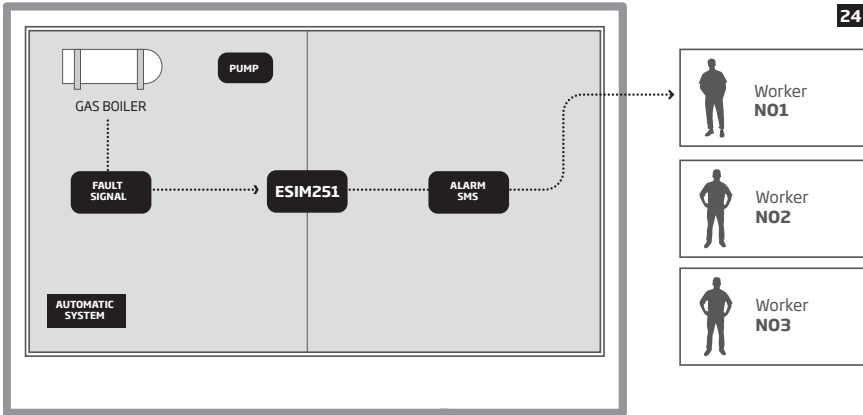

By default, SMS text message sending feature in the case of alarm is enabled for all users until the first successful delivery of the SMS text message, therefore it is necessary to remove users NO2 and NO3 and disable alarm calls for all users. It is also necessary to invert ESIM251 input from NO to NC mode so that alarm is given only if the signal disappears.

- First of all signal wires (fault output) indicating gas boiler breakdown is connected to ESIM251 input Z1.
- The following SMS text message must be sent to ESIM251 system:

```
5555_SMSEXTRA:Z1:SC23,CC123,L11
```

SC23 = alarm SMS text message sending is disabled for users NO2, NO3 if Z1 input is violated.

CC123 = alarm calls are disabled for users NO1, NO2 and NO3 after Z1 input is activated. We make an assumption that users NO4-NO5 are not listed in the system at all.

L11 = NC - "normally closed" input connection type is enabled for the input.

Task No2:

Configuring the system in the way so that the operating personnel member (N02) receives SMS text message if the pump has been triggered for 10 times.

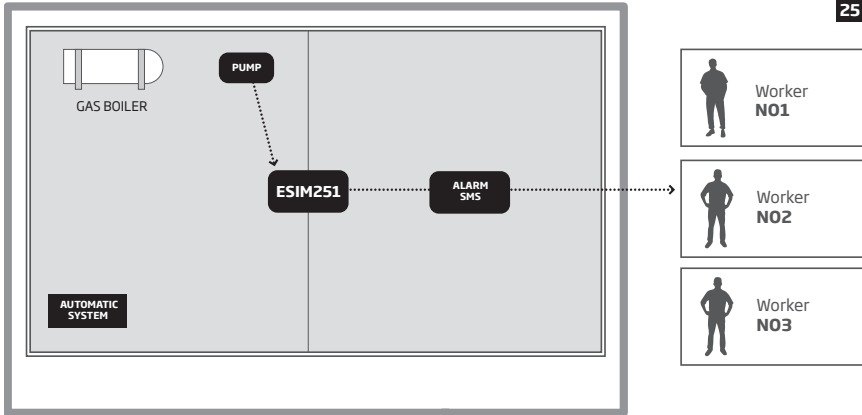

By default, SMS text message sending feature in case of alarm is enabled for all users until the first successful delivery of the SMS text message, therefore it is necessary to remove users N01 and N03 and disable alarm calls for all users. It is also necessary to enable pulse counting feature for ESIM251 input Z3 and set the number of expected pulses.

- First of all signal wires (fault output) indicating the pump triggering has to be connected to ESIM251 input Z3.
- The following SMS text message must be sent to ESIM251 system:

```
ssss_SMSEXTRA:Z3:SC13,CC123,IE1,IC10
```

SC13 = alarm SMS text message sending is disabled for users N01, N03 if Z3 input is violated.

CC123 = alarm calls are disabled for users N01, N02 and N03 if Z3 input is violated. We make an assumption that users N04-N05 are not listed in the system at all.

IE1 = enables pulse counting feature for input Z3.

IC10 = alarm is given by Z3 input after 10 pulses are achieved.

Task No3:

Configuring the system in the way so that operating personnel members (NO1), (NO2) and (NO3) can remotely reboot the "frozen" automatic control system by a free of charge phone call without visiting the installation location.

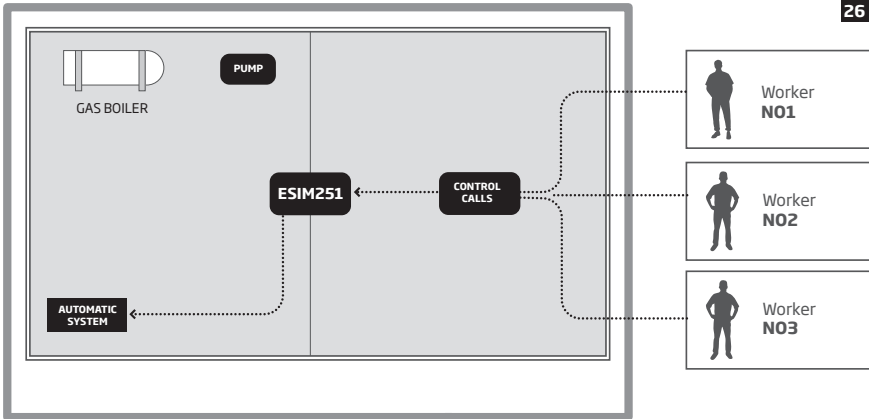

By default, C1 output control via calls is disabled for all users, therefore it is necessary to enable this feature and to set the users who will be able to control the output. In addition, it is also necessary to set output state for every user when he/she dials the system phone number. In this case the output must be turned ON for 2 seconds; once this this period expires, the output will return to the previous state.

- a) First of all ESIM251 output has to be connected to the automatic system control unit.
- b) The following SMS text message must be sent to ESIM251 system:

```
5555_SMSEXTRA:COC:CE123,MS10,MS20,MS30,MS1T0.0.2,MS2T0.0.2,MS3T0.0.2
```

CE123 = C1 output control via call is enabled for users NO1-NO3.

MS10 = output is turned ON when user NO1 calls the system.

MS20 = output is turned ON when user NO2 calls the system.

MS30 = output is turned ON when user NO3 calls the system.

MS1T0.0.2 = output state is changed for 2 seconds when user NO1 calls the system.

MS2T0.0.2 = output state is changed for 2 seconds when user NO2 calls the system.

MS3T0.0.2 = output state is changed for 2 seconds when user NO3 calls the system.

21. TECHNICAL SUPPORT

21.1. Troubleshooting

Indication	Possible reason
Indicators SIM STAT and NETW are OFF	<ul style="list-style-type: none">• No mains power• Wrong wiring• Blown fuse• Disconnected antenna• Micro-controller could not start due to electrical mains noise or static discharge
Indicator SIM STAT is ON	<ul style="list-style-type: none">• Missing SIM card• PIN code is enabled• SIM card is inactive
Indicator SIM STAT is flashing	<ul style="list-style-type: none">• GSM connection fault
Unable to receive any SMS text messages to the user phone number or control the output	<ul style="list-style-type: none">• Insufficient SIM card credit balance• Caller's phone number is set up as withheld (hidden)• No GSM network signal• Wrong user phone number• User phone number is not set• SIM card was replaced before disconnecting mains power• Incorrect SMS center phone number
Unable to connect to the device remotely via GPRS connection	<ul style="list-style-type: none">• GPRS settings (APN, user name, password) not set.• Insufficient SIM card credit balance• Mobile internet service (GPRS) not activated on the SIM card.
Received SMS text message "Wrong syntax"	<ul style="list-style-type: none">• Incorrect SMS text message structure• Unnecessary space character might have been typed in SMS text message

For product warranty repair service please, contact your local retail store where this product was purchased.

If your problem could not be fixed by the self-guide above, please contact your local distributor. More up to date information about your device and other products can be found at the manufacturer's website www.eldes.lt

21.2. Restoring Default Parameters

1. Power down the device.
2. Short-circuit (connect) the DEF pins.
3. Power up the device for 7 seconds.
4. Power down the device.
5. Remove the short-circuit from DEF pins.
6. Parameters restored to default.

21.3. Updating the Firmware via USB Cable

1. Power down the device.
2. Short-circuit (connect) the DEF pins.
3. Connect the device via USB cable to the PC.
4. Power up the device.
5. The new window must pop-up where you will find the .bin file. Otherwise open *My Computer* and look for *Boot Disk* drive.
6. Delete the .bin file found in the drive.
7. Copy the new firmware .bin file to the very same window.
8. Power down the device.
9. Unplug the USB cable.
10. Remove the short-circuit from DEF pins.
11. Power up the device.
12. Firmware updated.

NOTE: It is strongly recommended to restore default parameters after the firmware update.

21.4. Updating the Firmware via GPRS Connection Remotely

ATTENTION: The system will NOT transmit any data to monitoring station while updating the firmware remotely via GPRS network. However, during the firmware update process, the data messages are queued up and transmitted to the monitoring station after the firmware update process is over.

Before updating the firmware remotely via GPRS connection, please ensure that:

- SIM card is inserted into the SIM CARD slot (see **2.2. Main Unit, LED & Connector Functionality**).
- Mobile internet service (GPRS) is enabled on the SIM card.
- ESIM251/ESIM252 is powered up.
- Default SMS password is changed to a new 4-digit password (see **7. SMS PASSWORD**).
- User 1 phone number is set up (see **8. USER PHONE NUMBERS**).
- APN, user name and password are set up (see **18. GPRS NETWORK SETTINGS**).

ESIM251/ESIM252 system supports FOTA (firmware-over-the-air) feature. This allows to update the firmware remotely via GPRS connection. Once the update process is initiated, the system connects to the specified FTP server address where the firmware file is hosted and begins downloading and re-flashing the firmware. The firmware file must be located in a folder titled **Firmware**. In order to initiate the update process, please send the following SMS text message.

Initiate FOTA

SMS

SMS text message content:

`ssss_FOTA:ftp-server-ip,port,firmware-file-name.bin,user-name,password`

Value: *ssss* - 4-digit SMS password; *ftp-server-ip* - public IP address of FTP server where ESIM251/ESIM252 firmware file is stored; *port* - port number of FTP server (usually - 21); *firmware-file-name.bin* - name of the firmware file, allowed max. length - up to 31 character; *user-name* - user name of FTP server login, allowed max. length - up to 31 character; *password* - password of FTP server login, allowed max. length - up to 31 character.

Example: `1111_FOTA:84.15.143.111,21,esim251fw.bin,eldesuser,eldespassword`

ATTENTION: Firmware filename MUST be renamed in lowercase format before using it.

ATTENTION: *Comma* character is NOT allowed to use in user name and firmware file name.

ATTENTION: "ELDES UAB" does not run a FTP server and does not host the firmware files online. Please, contact your local distributor to request the latest firmware file.

NOTE: It is strongly recommended to restore default parameters after the firmware update.

22. RELATED PRODUCTS



ME1 - metal cabinet



EBU1 - power backup unit



Power supply



IP66 - plastic enclosure



Adhesive flat GSM antenna



Magnet mount straight GSM antenna



Microphone

Made in the European Union
www.eldes.it