

SB-130, SB-230 and SB-330

TK 54731-2-OP (Rev. 1, 04/2011)

**Copyright© 2010 Thermo King Corp., Minneapolis, MN, USA
Printed in USA**

Disclaimer

This manual is published for informational purposes only. Thermo King Corporation makes no representations or warranties, express or implied, with respect to the information, recommendations and descriptions contained in this manual and such information, recommendations and descriptions should not be regarded as all-inclusive or covering all contingencies. In the event you have any questions or require further information, please contact your local Thermo King dealer.

The procedures described herein should only be undertaken by suitably qualified personnel. Failure to implement these procedures correctly may cause damage to the Thermo King unit or other property or personal injury.

Thermo King Corporation and its affiliates shall have no liability in contract or tort (including negligence and/or strict liability) or otherwise, to any person or entity for any personal injury, property damage or any other direct, indirect, special or consequential damage or liability whatsoever, arising out of or resulting from any actions by any person that are contrary to this manual or any of the information, recommendations or descriptions contained herein or the failure of any person to implement the procedures described herein correctly or to follow caution and safety decals located on the Thermo King unit.

Table of Contents

Table of Contents	3	First Aid	21
List of Figures	7	First Aid–Refrigerant	21
Introduction	13	First Aid–Refrigerant Oil	21
EPA Emission Control System Warranty		Safety Decals and Locations	22
Statement	15	Unit Description	25
Responsibilities	16	Unit Overview	25
Thermo King Corporation Responsibilities	16	Design Features	26
Owner Responsibilities	17	Diesel Engine	29
Limitations	17	ELC (Extended Life Coolant)	30
Safety Precautions	19	EMI 3000	30
General Safety Practices	19	Thermo King X426L and X430L Reciprocating	
Automatic Start/Stop Operation	20	Compressors	31
Electrical Hazard	20	Electronic Throttling Valve	31
Refrigerant	20	SMART REEFER 3 (SR-3) Control System	32
Refrigerant Oil	21	CYCLE-SENTRY Operation	32
		Continuous Run Operation	32
		CYCLE-SENTRY Start-Stop Controls	33
		Data Logging	34
		OptiSet Plus	35

FreshSet	35	Alarm Display	65
Defrost	36	Starting the Diesel Engine	66
Opening the Front Doors	37	Unit Fails To Start	66
Opening the Secondary Door Latch	37	After Start Inspection	67
Closing the Front Doors	38	Electric Standby Operation	68
Unit Protection Devices	40	Starting the Unit on Electric Standby Operation ..	69
Remote Status Display (Optional)	45	Unit Fails to Start	70
Manual Pretrip Inspection		Switching from Diesel to Electric	71
(Before Starting the Unit)	49	Switching from Electric to Diesel	72
Operating Instructions	51	Changing the Setpoint	74
SMART REEFER 3 (SR-3) Controller Overview	51	Selection of Operating Modes	77
HMI Control Panel	53	Selecting CYCLE-SENTRY or Continuous Mode	78
Control Panel Display	53	Initiating a Manual Defrost Cycle	81
Control Panel Keys	54	Terminating a Defrost Cycle	83
Turning Unit On	56	Viewing Gauge Readings	84
More Than One Language Enabled	59	Gauges Available	84
Turning Unit Off	61	Viewing Sensor Readings	87
Standard Display	62	Sensors Available	87
Standard Display Variations when OptiSet Plus		Navigating the Main Menu	91
is in Use	63	Main Menu Choices	92
Temperature Watch Display	64	Language Menu	94
		Return to English at Any Time	97
		Alarms Menu	98
		Important Alarm Notes	99

Datalogger Menu	101	Selecting a Named Product	134
Initiating a Start of Trip	101	Selecting the Setpoint for a Named Product	137
Printing a Trip Report	103	Changing the Setpoint for a Named Product	139
Hourmeters Menu	107	Selecting a Setpoint	142
Mode Menu	110	Optional Rear Remote Control Panel	145
Turn Cycle Sentry On or Off	110	Rear Remote Control Panel Functionality	145
Select Temperature Units	110	Rear Remote Control Action set to Run	145
Keypad Lockout	110	Rear Remote Control Action Set to Stand By	146
Start Sleep Mode	110	Keypad	148
Turning CYCLE-SENTRY On or Off	112	Display	149
Selecting Keypad Lockout	114	Reading a Typical Remote Standard Display	150
Selecting Sleep Mode	116	Remote Control Panel Lockout	150
Pretrip Tests	120	Turning the Unit ON or OFF (Configured for STAND BY Operation)	151
Pretrip Test Conditions	120	Turning the Unit On and Off (Configured for RUN Operation)	151
Conditions where Pretrip Tests are not allowed	120	Changing the Setpoint	152
Full Pretrip	120	Selecting Cycle-Sentry or Continuous Mode	153
Running Pretrip	121	Displaying the Discharge Air Temperature	154
Pretrip Test Issues	122	Viewing and Clearing Alarm Codes	155
Initiating a Pretrip Test	123	Starting a Manual Defrost Cycle	156
Stopping a Pretrip Test	124	Sending a Start of Trip Marker	157
Electric Standby/Diesel Mode	126	Running a Pretrip Test	158
Adjust Brightness Menu	128		
Time Display	131		
OptiSet Plus	132		

Loading and Enroute Inspections	161	Electric Fuel Heater (Optional)	200
Pre-Loading Inspection	161	Warranty	201
Post-Loading Inspection	163	Glossary	203
Enroute Inspections	164	Maintenance Inspection Schedule	209
Inspection Procedure	164	Serial Number Locations	215
Inspection Troubleshooting	164	Emergency Cold Line	219
Alarm Codes	167	Recover Refrigerant	220
Introduction	167	CALIFORNIA Proposition 65 Warning	221
Alarm Types	167	Index	223
Pretrip Alarm Codes	169		
Clearing Alarm Codes	170		
Jump Starting	187		
Specifications	191		
Engine	191		
Belt Tension	194		
Refrigeration System	196		
Electrical Control System	197		
Electrical Standby (Model 50 Units Only)	198		
Electric Motor and Overload Relay	198		
Electric Heater Strips	198		
Standby Power Cord Requirements	199		

List of Figures

ELC (Extended Life Coolant) Nameplate	22
Belt Warning	22
Belt Replacement Caution	22
Automatic Start Caution	23
Fan Caution	23
Door Latch Warning	24
Front View	25
TK486V	29
Compressor	31
HMI Controller and Data Ports	35
Door Latch Location	37
Opening Secondary Door Latch	37
Engine Compartment	39
Control Box With Service Door Open	42
Control Box With Control Box Door Open	43
Base Controller	43
Remote Status Display	45
Normal Operation No Alarms	45
Check Alarm	46
Shutdown Alarm	46
Remote Status Display with Fuel Level	47
Remote Status Display with Fuel Level and Temperature	47
SR-3 HMI Control Panel	51
Control Box With Service Door Open	52
Control Panel Display and Keys	53
Press On Key	56
Turning Unit On Screen Sequence, One Language Enabled	58
NO Key	59
Language Menu	59
New Language	60
Standard Display	60

Press Off Key	61
Turning Unit Off Screen Sequence.	61
Standard Display	62
Standard Display Variations	63
Temperature Watch Display	64
Alarm Display	65
Electric Power Receptacle	68
Electric Standby Detected Screen	69
Electric Motor Starting Screen	70
Electric Standby Detected Screen	71
Programming Electric Standby Screen	71
Electric Standby Undetected Screen	72
Programming Diesel Mode Screen	72
Changing Setpoint	74
Changing the Setpoint Screen Sequence.	76
Changing Mode	78
Screen Sequence for Changing from CYCLE-SENTRY Mode to Continuous Mode	79

Screen Sequence for Changing from Continuous Mode to CYCLE-SENTRY Mode	80
Initiating a Manual Defrost Cycle	81
Initiating Manual Defrost Screen Sequence	82
Viewing Gauges	85
Viewing Gauges Screen Sequence	86
Viewing Sensors	87
NEXT, BACK, LOCK Keys	87
Viewing Sensors Screen Sequence	89
Accessing Main Menu	91
Main Menu Choices	92
Standard Display	95
Change Language Screen Sequence	96
Standard Display	97
+ or - Keys, YES Key	97
Standard Display	98
Viewing and Clearing Alarms Screen Sequence	100

Standard Display	101	Pretrip Test Screen Sequence	125
Start of Trip Screen Sequence	102	Standard Display	126
Printer Port Location	103	Programming Diesel Mode	127
Standard Display	104	Programming Electric Standby Mode	128
Print Report Screen Sequence	105	Standard Display	129
Sample Delivery Ticket	106	Adjusting Display Brightness Screen Sequence	130
Sample Trip Ticket	106	Time and Date Screens	131
Standard Display	107	Standard Display with Product Soft Key	132
Viewing Hourmeters Screen Sequence	108	Standard Display with Product/Setpoint Soft Key	133
Standard Display	112	Selecting Named Product	134
Selecting Mode Screen Sequence	113	Selecting or Changing Named Product Screen Sequence	136
Standard Display	114	Selecting Setpoint for Named Product Screen Sequence	138
Mode Menu Display	114	Changing Setpoint for Named Product	139
Keypad Lockout Display	115	Changing Setpoint for Named Product Screen Sequence	141
Standard Display	117		
Selecting Sleep Mode Screen Sequence	119		
Standard Display	123		
No Pretrip Alarm Active Display	123		

Selecting or Changing Setpoint	142	Press Select Key Twice.	154
Selecting or Changing Numeric Setpoint		Press Select Key Three Times	155
Screen Sequence	144	Press Enter Key	155
Rear Remote Control Panel	145	No Alarms Display	155
Rear Remote Control Panel Display	147	Press Defrost Key	156
Unit HMI Control Panel Display	147	Press Enter Key	156
Press Select Key	147	Defrost Icon Displayed	156
Rear Remote Control Panel	148	Press TK Logo Key	157
Rear Remote Control Panel	149	Press Enter Key	157
Remote Standard Display	150	Press Pretrip Key	158
Remote Lock Out Display	150	Press Enter Key	158
Stand By Display	151	Pretrip Display	159
Standard Display	152	Pass Pretrip Display	159
Press Up or Down Arrow Keys	152	Loading Considerations	162
Press Enter Key.	153	Log Alarms Screen	168
Press Select Key	153	Alarm Display	168
Press Up or Down Arrow Keys	154	Shutdown Alarm Display	169
Press Enter Key	154	Unit Battery	188

Sequence for Connecting Jumper Cables . . .	188
Unit Engine	189
Sequence for Disconnecting Jumper Cables .	190
Compressor Serial Number Location	216
Engine Serial Number Location	216
Unit Serial Number Plate Locations	217
Unit Serial Number Plate	217

Introduction

There is nothing complicated about operating and maintaining your Thermo King unit, but a few minutes studying this manual will be time well spent.

Performing pre-trip checks and enroute inspections on a regular basis will minimize on-the-road operating problems. A regular maintenance program will also help to keep your unit in top operating condition. If factory recommended procedures are followed, you will find that you have purchased the most efficient and dependable temperature control system available.

All service requirements, major and minor, should be handled by a Thermo King dealer for four very important reasons:

- They are equipped with the factory recommended tools to perform all service functions
- They have factory trained and certified technicians
- They have genuine Thermo King replacement parts
- The warranty on your new unit is valid only when the repair and replacement of component parts is performed by an authorized Thermo King dealer.

IMPORTANT: This manual is published for informational purposes only and the information furnished herein should not be considered as all-inclusive or meant to cover all contingencies. If more information is required, consult your Thermo King Service Directory for the location and telephone number of the local dealer.

Introduction

EPA Emission Control System Warranty Statement

Thermo King warrants to the initial owner and each subsequent owner that the certified, non-road diesel engine in your unit is:

1. Designed, built and equipped so as to conform, at the time of sale, with all applicable regulations adopted by the United States Environmental Protection Agency (EPA).
2. Free from defects in materials and workmanship in specific emission related parts for a period of five years or 3,000 hours of operation, whichever comes first, after date of delivery to the initial owner.

If an emission-related part or component fails during the warranty period, it will be repaired or replaced. Any such part or component repaired or replaced under warranty is warranted for the warranty period.

During the term of this warranty, Thermo King will provide, through a Thermo King authorized service dealer or other establishment authorized by Thermo King, repair or replacement of any warranted part at no charge to the non-road engine owner.

In emergency, repairs may be performed at any service establishment, or by the owner, using any replacement part. Thermo King will reimburse the owner for their expenses, including diagnostic charges for such emergency repair. These expenses shall not exceed Thermo King's suggested retail price for all warranted parts replaced, and labor charges based on Thermo King's recommended time allowance for the warranty repair and the geographically appropriate hourly labor rate.

EPA Emission Control System Warranty Statement

Any replacement part can be used for maintenance or repairs. The owner should ensure that such parts are equivalent in design and durability to genuine Thermo King parts. However, Thermo King is not liable for parts that are not genuine Thermo King parts.

A part not being available within 30 days or repair not being completed within 30 days constitutes an emergency.

As a condition of reimbursement, replaced parts and received invoices must be presented at a place of business of a Thermo King authorized service dealer or other establishment authorized by Thermo King.

This warranty covers the following emission-related parts and components:

- Fuel Injection System
- Intake Manifold
- Exhaust Manifold
- Miscellaneous hoses, clamps, connectors and sealing devices used in the above systems.

If failure of one of these parts or components results in failure of another part or component, both will be covered by this warranty.

Responsibilities

This warranty is subject to the following:

Thermo King Corporation Responsibilities

During the emission warranty period, if a defect in material or workmanship of a warranted part or component is found, Thermo King will provide:

- New, remanufactured, or repaired parts or components required to correct the defect.

NOTE: Items replaced under this warranty become the property of Thermo King.

- Labor, during normal working hours, required to make the warranty repair. This includes diagnosis and labor to remove and install the engine, if necessary.

EPA Emission Control System Warranty Statement

Owner Responsibilities

During the emission warranty period, the owner is responsible for:

- The performance of all required maintenance. A warranty claim will not be denied because the scheduled maintenance was not performed. However, if the lack of required maintenance was the reason for the repair, then the claim will be denied.
- Premium of overtime cost.
- Cost to investigate complaints that are not caused by defects in Thermo King material or workmanship.
- Providing timely notice of a warrantable failure and promptly making the product available for repair.

Limitations

Thermo King is not responsible for resultant damages to an emission-related part or component resulting from:

- Any application or installation Thermo King deems improper as explained in this Operator's Manual, or any other manuals provided for the unit.

- Attachments, accessory items, or parts not authorized for use by Thermo King.
- Improper off-road engine maintenance, repair or abuse.
- Owner's unreasonable delay in making the product available after being notified of a potential product problem.

This warranty is in addition to Thermo King's standard warranty applicable to the off-road engine product involved.

Remedies under this warranty are limited to the provision of material and services as specified herein. Thermo King is not responsible for incidental or consequential damages such as downtime or loss of engine powered equipment.

EPA Emission Control System Warranty Statement

Safety Precautions

Thermo King recommends that servicing be done only by a Thermo King dealer. However, you should be aware of several safety practices. This chapter gives basic safety precautions for working with Thermo King units and describes the safety stickers on your unit that you should be familiar with.

General Safety Practices



DANGER: NEVER operate the unit with the compressor discharge valve closed. Doing so could cause the compressor to explode, causing death or serious injury.



WARNING: Always wear goggles or safety glasses when working with or around the refrigeration system or battery. Refrigerant or battery acid can cause permanent damage if it comes in contact with your eyes.



WARNING: Keep hands and loose clothing clear of fans and belts at all times when the unit is operating or when opening or closing compressor service valves.



WARNING: Exposed coil fins can cause painful lacerations. Service work on the evaporator or condenser coils should be done by a certified Thermo King technician.



WARNING: Do not apply heat to a closed cooling system. Before applying heat to a cooling system, drain it. Then flush it with water and drain the water. Antifreeze contains water and ethylene glycol. The ethylene glycol is flammable and can ignite if the antifreeze is heated enough to boil off the water.

Safety Precautions



CAUTION: Use extreme caution when drilling holes in the unit. Drilling into electrical wiring or refrigerant lines could cause a fire. Do not drill into structural components.

Automatic Start/Stop Operation

This unit is capable of automatic operation and could start at any time without warning.



WARNING: The unit can start at any time without warning. Press the **OFF** key on the HMI control panel and place the microprocessor On/Off switch in the Off position before inspecting or servicing any part of the unit.

Electrical Hazard



CAUTION: Turn off the high voltage power supply and disconnect the electric cable before working on the unit. Units with electric standby present a potential electrical hazard.

Refrigerant

Although fluorocarbon refrigerants are classified as safe, use caution when working with refrigerants or in areas where they are being used.



DANGER: Fluorocarbon refrigerants can produce toxic gases. In the presence of an open flame or electrical short, these gases are severe respiratory irritants **CAPABLE OF CAUSING DEATH**.



DANGER: Fluorocarbon refrigerants tend to displace air and can cause oxygen depletion which could result in **DEATH BY SUFFOCATION**. Provide adequate ventilation in enclosed or confined areas.



WARNING: Fluorocarbon refrigerants evaporate rapidly, freezing anything they contact if accidentally released into the atmosphere from the liquid state.

Refrigerant Oil

Observe the following precautions when working with or around refrigerant oil:



WARNING: *Always wear goggles or safety glasses to protect eyes from refrigerant oil contact.*



WARNING: *Protect skin and clothing from prolonged or repeated contact with refrigerant oil. Rubber gloves are recommended.*



WARNING: *Wash thoroughly immediately after handling refrigerant oil to prevent irritation.*

First Aid

First Aid–Refrigerant

Eyes: For contact with liquid, immediately flush eyes with large amounts of water. Get prompt medical attention.

Skin: Flush areas with large amounts of warm water. Do not apply heat. Wrap burns with dry, sterile, bulky dressing to protect from infection or injury. Get prompt medical attention.

Inhalation: Move victim to fresh air and restore breathing if necessary. Stay with victim until emergency personnel arrive.

First Aid–Refrigerant Oil

Eyes: Immediately flush eyes with large amounts of water for at least 15 minutes while holding the eyelids open. Get prompt medical attention.

Skin: Remove contaminated clothing. Wash thoroughly with soap and water. Get medical attention if irritation persists.

Inhalation: Move victim to fresh air and restore breathing if necessary. Stay with victim until emergency personnel arrive.

Ingestion: Do not induce vomiting. Immediately contact local poison control center or physician.

Safety Decals and Locations

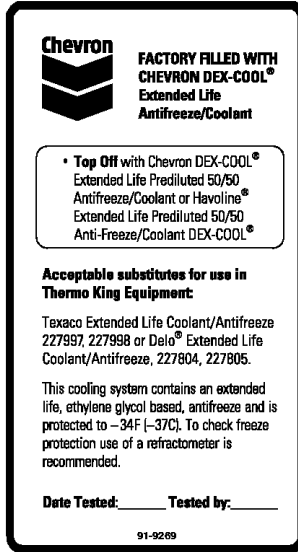

AJA1947

Figure 1: ELC (Extended Life Coolant) Nameplate
(Located on expansion tank in units equipped with ELC)

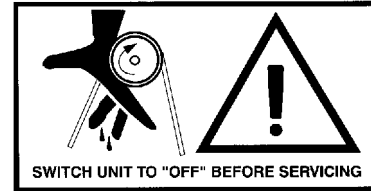

AKB65

Figure 2: Belt Warning
(Located on condenser housing)

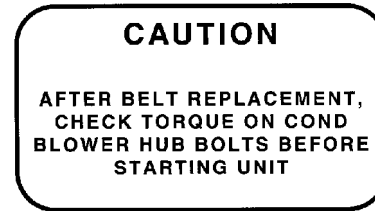

AKB66

Figure 3: Belt Replacement Caution
(Located on condenser housing)

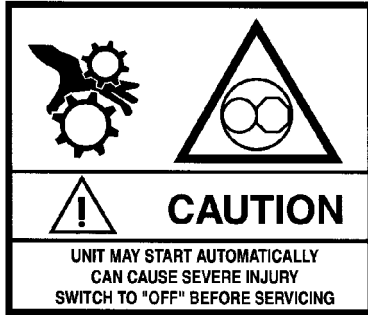

AKB67

Figure 4: Automatic Start Caution
(Locations vary depending on model. Decals are located near areas that contain moving parts which can cause severe injuries if hands or clothing become tangled when unit automatically starts.)



AKB68

Figure 5: Fan Caution
(Locations vary depending on model. Decals are located near areas that contain fans which can cause severe injuries when unit automatically starts.)

Safety Precautions



**Figure 6: Door Latch Warning
(Located on curbside door)**

Unit Description

Unit Overview

The Thermo King SB-130, SB-230 and SB-330 are one piece, self-contained, diesel powered, air cooling/heating units operating under the control of a SMART REEFER 3 (SR-3) programmable microprocessor controller. Each unit mounts on the front of the trailer with the evaporator extending through an opening in the front wall.

The units feature cooling and heating using a quiet running engine from the Thermo King TK486 engine family.

The units are available in the following models:

SB-130 30: Cooling and heating on diesel engine operation.

SB-230 30: Cooling and heating on diesel engine operation.

SB-230 50: Cooling and heating on diesel engine operation and electric standby operation.

SB-330 30: High capacity cooling and heating on diesel engine operation. Designed for engine operation at a high speed of 2600 rpm.

The Electronic Throttling Valve (ETV) provides enhanced control of the refrigeration system. The ETV is optional on the SB-130 and SB-230, and standard on the SB-330. See “Electronic Throttling Valve” on page 31.



Figure 7: Front View

Unit Description

In addition to the quiet TK486 engine, these Thermo King units include other sound deadening components as standard and optional equipment. Among them are a special exhaust system, sound-proof insulation, special door gaskets and sound-absorbing doors. See the Design Features list below.

Design Features

The following chart lists key design features and options.

- Standard Features
- Option/Factory installed
- Option/Dealer Installed

SB-130 / 230 / 330 Key Features & Options	SB-130 Model 30	SB-230 Model 30	SB-230 Model 50	SB-330 Model 30
SMART REEFER SR-3 Controller	●	●	●	●
OptiSet™ Plus	●	●	●	●
ETV (Electronic Throttling Valve)	○	○	○	●

SB-130 / 230 / 330 Key Features & Options	SB-130 Model 30	SB-230 Model 30	SB-230 Model 50	SB-330 Model 30
FreshSet™ Programmable Modes (requires ETV)	○	○	○	●
ServiceWatch™ Data Logger	●	●	●	●
CargoWatch™ Data Logger	●	●	●	●
CargoWatch™ Accessories:				
• Door Switches	○ / □	○ / □	○ / □	○ / □
• Temperature Sensor Kits	○ / □	○ / □	○ / □	○ / □
EMI-3000	●	●	●	●
High-Capacity Condenser Coil	●	●	●	●
Whisper Quiet Technology	○	○	○	○
Easy-access door design	●	●	●	●

Unit Description

SB-130 / 230 / 330 Key Features & Options	SB-130 Model 30	SB-230 Model 30	SB-230 Model 50	SB-330 Model 30
Composite Exterior Panels	●	●	●	●
Long-Life Coolant/Silicone Hoses	●	●	●	●
Remote Status Display	○ / □	○ / □	○ / □	○ / □
Remote Status Display with Fuel Level	□	□	□	□
Remote Status Display with Fuel Level and Temperature	□	□	□	□
Standard Unit Color White	●	●	●	●
Standard Grille Color Black	●	●	●	●

SB-130 / 230 / 330 Key Features & Options	SB-130 Model 30	SB-230 Model 30	SB-230 Model 50	SB-330 Model 30
Directional Air Delivery	●	●	●	●
Vibration Isolation System	●	●	●	●
Aluminum Undermount Fuel Tank 50 Gal. (186 Liter)	●	●	●	●
Fuel Level Sensor	○	○	○	○
Electric Fuel Heater	○	○	○	○
Frost Plug Heater	○	○	○	○
Alternator, 65 Amp, 12 Vdc	○	○	○	○
Special Color Grills	○	○	○	○
Fresh Air Exchange	○	○	○	○
REB Wireless Communication Platform	○	○	○	○

Unit Description

SB-130 / 230 / 330 Key Features & Options	SB-130 Model 30	SB-230 Model 30	SB-230 Model 50	SB-330 Model 30
iBox™ Interface	<input type="radio"/> / <input type="checkbox"/>	<input type="radio"/> / <input type="checkbox"/>	<input type="radio"/> / <input type="checkbox"/>	<input type="radio"/> / <input type="checkbox"/>
PrimAir™ bulkhead and duct system	<input type="checkbox"/>	<input type="checkbox"/>	<input type="checkbox"/>	<input type="checkbox"/>
Rear Remote Control	<input type="checkbox"/>	<input type="checkbox"/>	<input type="checkbox"/>	<input type="checkbox"/>
Humidity Sensor	<input type="checkbox"/>	<input type="checkbox"/>	<input type="checkbox"/>	<input type="checkbox"/>
Megatech Battery, 12 Volt, Wet Cell	<input type="checkbox"/>	<input type="checkbox"/>	<input type="checkbox"/>	<input type="checkbox"/>
EON Battery, 12 Volt, Dry Cell	<input type="checkbox"/>	<input type="checkbox"/>	<input type="checkbox"/>	<input type="checkbox"/>
24 Horsepower Electric Motor			<input type="radio"/>	
Remote Electric Power Receptacle			<input type="checkbox"/>	

Unit Description

Diesel Engine

The TK486V (Tier 2) family of engines are 4-cylinder, water cooled, direct injection diesel engines. The engine is coupled directly to the compressor on the Model 30. A centrifugal clutch transfers power from the engine to the compressor on the Model 50. Belts transmit power to the unit fans, alternator and water pump.

The SB-130 and SB-230 use a TK486V (Tier2), which is designed to run with a high speed of 2200 rpm.

The SB-330 uses a TK486VH (Tier2), which is designed to run with a high speed of 2600 rpm.

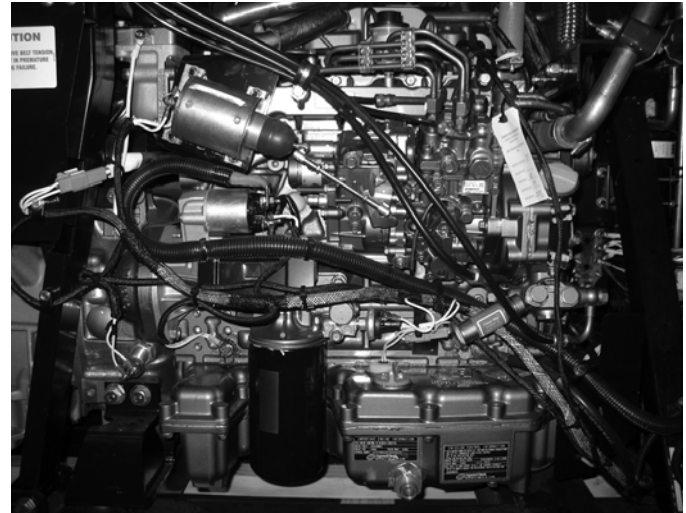

Figure 8: TK486V (TK486VH is Similar)

ELC (Extended Life Coolant)

ELC (Extended Life Coolant) is standard equipment. The maintenance interval for ELC is five years or 12,000 hours. A nameplate on the coolant expansion tank identifies units with ELC (see “Safety Decals and Locations”). The new engine coolant, Chevron Extended Life Coolant, is RED in color instead of the previous GREEN or BLUE-GREEN colored conventional coolants.



CAUTION: Do not add “GREEN” or “BLUE-GREEN” conventional coolant to cooling systems using “RED” Extended Life Coolant, except in an emergency. If conventional coolant is added to Extended Life Coolant, the coolant must be changed after 2 years instead of 5 years.

NOTE: The use of 50/50% pre-mixed ELC is recommended to assure that de-ionized water is being used. If 100% full strength concentrate is used, de-ionized or distilled water is recommended instead of tap water to insure the integrity of the cooling system is maintained.

EMI 3000

EMI 3000 is an extended maintenance interval package. It is standard equipment. The EMI 3000 package consists of the following key components:

- EMI 3000-Hour Cyclonic Air Cleaner Assembly and Air Cleaner Element
- EMI 5-Micron 3000-Hour Fuel Filter
- EMI 3000-Hour Dual Element Oil Filter
- API Rating CI-4 Mineral Oil
- Five Year or 12,000 Hour ELC (Extended Life Coolant)

The EMI package allows standard maintenance intervals to be extended to 3,000 hours, or 2 years, whichever occurs first.

NOTE: Units equipped with the EMI 3000 package do require regular inspection in accordance with Thermo King's maintenance recommendations.

NOTE: EMI 3000 oil filters and EMI 3000 air cleaners are NOT interchangeable with older style oil filters and air cleaners.

Unit Description

Thermo King X426L and X430L Reciprocating Compressors

The SB-130 is equipped with a Thermo King X426L reciprocating compressor with 25.9 cu. in. (424 cm³) displacement. The SB-230 and SB-330 are equipped with a Thermo King X430L reciprocating compressor with 30.0 cu. in. (492 cm³) displacement.

Electronic Throttling Valve

The Electronic Throttling Valve (ETV) is optional on the SB-130 and SB-230, and standard on the SB-330. The ETV provides enhanced control of the refrigeration system as follows:

- Allows the refrigeration system to fully utilize the power capabilities of the engine under varying conditions
- Provides an additional measure of protection against high discharge pressures
- Protects the engine from high coolant temperature shutdowns
- Provides a means of precise temperature control.

You can tell if the unit has an ETV by looking at the compressor. Units with an ETV have a suction valve adapter. Units without an ETV have a mechanical throttling valve.

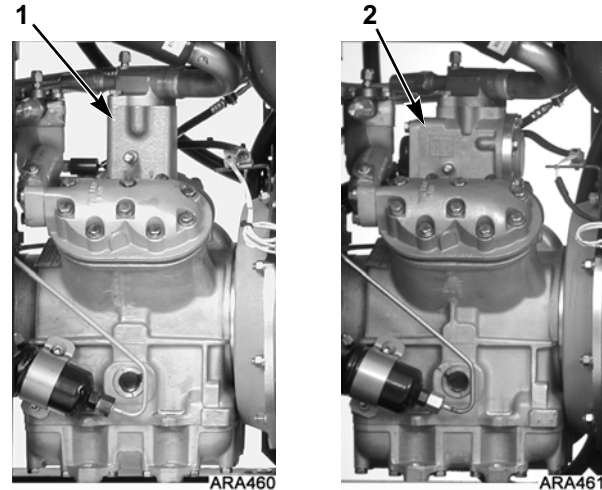

1.	Suction Valve Adapter (with ETV)
2.	Mechanical Throttling Valve (No ETV)

Figure 9: Compressor

Unit Description

SMART REEFER 3 (SR-3) Control System

The SR-3 Base Controller is a microprocessor control system designed for transport refrigeration. The SR-3 integrates the following functions: changing setpoint and operating mode, viewing gauge, sensor and hourmeter readings, initiating defrost cycles, and viewing and clearing alarms.

The microprocessor components are located inside the control box, which is located inside the lower roadside service door. The microprocessor is connected to an HMI (Human Machine Interface) Control Panel. It is used to operate the unit. The HMI control panel is mounted on the face of the control box. It is clearly visible through an opening in the lower roadside service door.

See “Operating Instructions” for more information about the SR-3 Base Controller.

Depending on the air temperature in the trailer, as sensed by the microprocessor Base Controller, the unit will typically operate in one of the following modes:

CYCLE-SENTRY Operation

- High Speed Cool
- Low Speed Cool
- Null (Engine Off)
- Low Speed Heat
- High Speed Heat
- Defrost

Continuous Run Operation

- High Speed Cool
- Low Speed Cool
- Low Speed Modulated Cool (Optional SB-130 and 230)
- Low Speed Modulated Heat (Optional SB-130 and 230)
- Low Speed Heat
- High Speed Heat
- Defrost

Unit Description

CYCLE-SENTRY Start-Stop Controls

The CYCLE-SENTRY Start-Stop fuel saving system provides optimum operating economy.



WARNING: The unit can start at any time without warning. Press the OFF key on the HMI control panel and place the microprocessor On/Off switch in the Off position before inspecting or servicing any part of the unit.

The CYCLE-SENTRY system automatically starts the unit on microprocessor demand, and shuts down the unit after those conditions are satisfied.

The system automatically monitors and maintains the compartment temperature, engine block temperature, and battery charge levels at a condition where quick, easy starts are possible.

Your Thermo King unit provides a wide range of control and programming flexibility. However, pre-programming of the unit Base Controller may prohibit operation in certain temperature ranges within some modes and may also prohibit certain modes of operation. If you have controller programming questions, contact your supervisor or your Thermo King dealer before requesting service.

Unit Description

Data Logging

There are two separate data loggers. The data is downloaded through the data ports on the front of the control box using an IBM® PC compatible laptop or desktop computer and Thermo King WinTrac 5.1 (or higher) software.

ServiceWatch™: ServiceWatch™ is standard equipment. It records operating events, alarm codes and compartment temperatures as they occur and at preset intervals. This information is typically used to analyze unit performance. Use the ServiceWatch Port to download the ServiceWatch data.

CargoWatch™: CargoWatch™ data logging requires the installation of optional sensors. Up to six temperature sensor/probes and four door switches can be installed. CargoWatch also logs the setpoint. Use the CargoWatch Port to download the CargoWatch data. If optional temperature sensors are installed, their readings are displayed as Datalogger Sensor (1-6) Temperature in the sensor readings.

A printer can also be used to print a report of the optional sensor readings.

USB Port: Standard USB drives that have been programmed with Wintrac can be used. Use of a USB drive eliminates the need for an on-site computer and does not require cables.

The USB port can be used to:

- Upload and download OptiSet™ Plus files.
- Download the CargoWatch and ServiceWatch Data Loggers.
- Flashload the Base Controller and HMI Control Panel.

Unit Description

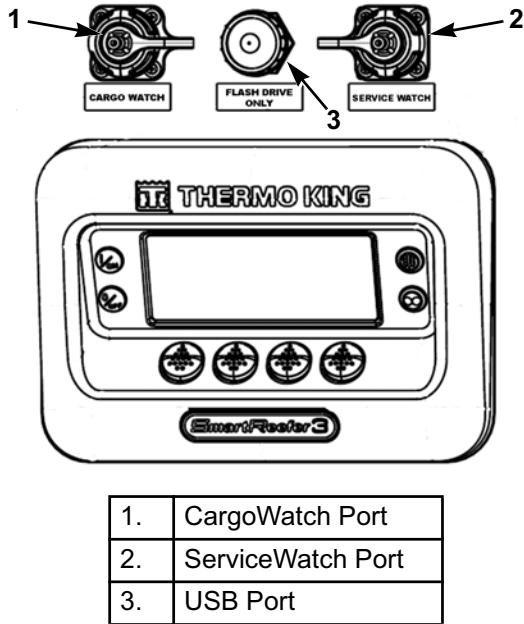

Figure 10: HMI Controller and Data Ports

OptiSet Plus

OptiSet™ Plus is a group of programmable functions that control how the unit will operate with specific setpoints or named products. This assures that when a particular setpoint or named product is selected, the unit will always operate the same way. This allows an entire fleet to be configured to match the customers' needs. Contact your Thermo King dealer for information about programming OptiSet Plus.

FreshSet

FreshSet™ is included in OptiSet Plus. FreshSet is a demand base temperature control for fresh products. FreshSet modifies and adjusts unit airflow operation to control temperature and to maximize protection of cargo, while keeping operating costs to a minimum. Contact your Thermo King dealer for information about programming FreshSet.

Unit Description

Defrost

Frost gradually builds-up on evaporator coils as a result of normal operation. The unit uses hot refrigerant to defrost the evaporator coil. Hot refrigerant gas passes through the evaporator coil and melts the frost. The water flows through collection drain tubes onto the ground. The methods of defrost initiation are Automatic, and Manual.

Automatic Defrost: The Base Controller automatically initiates timed or demand defrost cycles. The Base Controller can be programmed to initiate timed defrost cycles at intervals of 2, 4, 6, 8, or 12 hours. Demand defrost cycles occur if the differences between the return air temperature, discharge air temperature, and coil temperature exceed certain limits. The unit can enter defrost cycles as often as every 30 minutes if required.

Manual Defrost: In Manual Defrost mode, the operator initiates a defrost cycle. See “Initiating a Manual Defrost Cycle.”

NOTE: The unit will not perform a Manual Defrost Cycle unless the unit has been turned on with the ON key, the unit is running in Continuous or CYCLE-SENTRY Mode (or shut down in CYCLE-SENTRY Null Mode), and the coil temperature is below 45 F (7 C).

Unit Description

Opening the Front Doors

Pull the door latch handle to open the door and access the engine compartment.

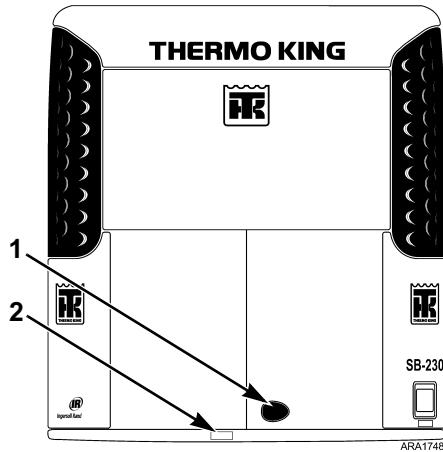

1.	Door Latch
2.	Secondary Door Latch Nameplate

Figure 11: Door Latch Location

Opening the Secondary Door Latch

The unit is also equipped with a secondary door latch. A secondary door latch nameplate is located below the front doors. After opening the door latch, reach between the front doors and lift the spring latch over the spring catch while opening the door.

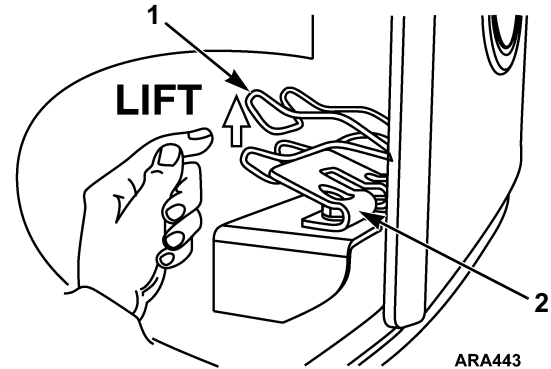

1.	Spring Latch
2.	Spring Catch

Figure 12: Opening Secondary Door Latch

Unit Description

Closing the Front Doors

Slam the door to close it. Do not push the door closed while holding the door latch handle open or the door will not close properly.

Engine Compartment Components

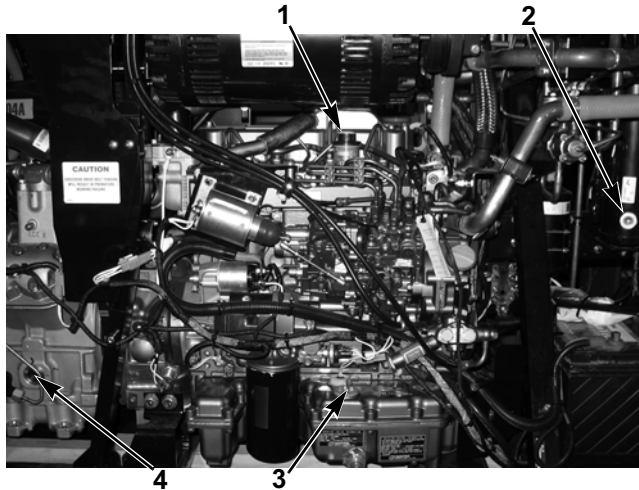

1.	Air Filter Restriction Indicator	3.	Engine Oil Dipstick
2.	Receiver Tank Sight Glass	4.	Compressor Oil Sight Glass

Figure 13: Engine Compartment

The following maintenance items can be checked visually.



WARNING: *The unit can start at any time without warning. Press the OFF key on the HMI control panel and place the microprocessor On/Off switch in the Off position before inspecting any part of the unit.*

Air Filter Restriction Indicator: The air filter restriction indicator is attached to the engine intake manifold. When the diaphragm indicates 25, service the air filter. Press the button on the bottom of the restriction indicator to reset after servicing the air cleaner.

Compressor Oil Sight Glass: Use this sight glass to check the compressor oil level. Check the compressor oil when there is evidence of oil loss (leaks). Refer to the unit Maintenance Manual for the correct procedure.

Engine Oil Dipstick: Use the engine oil dipstick to check the engine oil level.



CAUTION: *Make sure the engine is turned off before attempting to check the engine oil.*

Unit Description

Receiver Tank Sight Glass: This sight glass indicates the level of refrigerant in the receiver tank.

Operate the unit in high speed cool for approximately 15 minutes to stabilize operating conditions and temperature before attempting to check the refrigerant.

***NOTE:** If the ball floats, there is sufficient refrigerant in the unit for that load at that particular trailer temperature. This test does not determine if the unit contains a full charge or an overcharge of refrigerant.*

Unit Protection Devices

Coolant Level Switch: The coolant level switch closes if the coolant level drops below an acceptable level. If it stays closed for a specified time, the microprocessor records alarm code 37.

Engine Coolant Temperature Sensor: The microprocessor uses the engine coolant temperature sensor to monitor the engine coolant temperature. If the engine coolant temperature rises above an acceptable level, the microprocessor records alarm code 41 and possibly 18. The the microprocessor might also shut the unit down.

Fuse Link (Current Limiter): The fuse link is located in the positive battery cable. The fuse link protects the electric system from a short. If the fuse link burns out, replace it by replacing the positive battery cable.

High Pressure Cutout Switch: The high pressure cutout switch (HPCO) is located on the compressor discharge manifold. If the compressor discharge pressure becomes excessive, the switch opens the circuit to the run relay to stop the unit. The microprocessor will record Alarm Code 10.

High Pressure Relief Valve: This valve is designed to relieve excessive pressure in the refrigeration system. It is located on the receiver tank. If the high pressure relief valve opens, much of the refrigerant will be lost. Take the unit to a Thermo King dealer if this occurs.

Low Oil Level Switch: The low oil level switch closes if the oil drops below an acceptable level. If it stays closed for a specified time, the microprocessor shuts the unit down and records Alarm Code 66.

Low Oil Pressure Switch: The low oil pressure switch closes if the oil pressure drops below an acceptable level. If it stays closed for a specified time, the microprocessor shuts the unit down and records alarm code 19.

Unit Description

Preheat Buzzer: The preheat buzzer sounds when the base controller energizes the preheat relay. This warns anyone near the unit that the controller is about to start the engine.

Overload Relay—Automatic Reset (Model 50): An overload relay protects the standby electric motor. The overload relay opens the circuit to the electric motor if the motor overloads for any reason (e.g., low line voltage or improper power supply) while the unit is on electric standby operation. The microprocessor will record Alarm Code 90.

Smart FETs: Smart FETs in the base controller protect some circuits and components from an overcurrent condition.

Fuses: A number of fuses, located on the base controller, protect various circuits and components. The base controller is located inside the control box. Refer to the appropriate Microprocessor Controller Diagnostic Manual for more information about the fuses.

Fuse	Size	Function
F2	15A	Power to On/Off Switch
F3	40A	Fuel Sol Pull-In/Starter Circuit

Fuse	Size	Function
F4	None	No Fuse - All Bosch and Thermo King Alternators
	2A	2A Fuse - All Prestolite Alternators
F5	60A	Preheat Circuit
F6	15A	Damper and High Speed Circuits
F7	2A	8XP Circuit - Controller On Feedback to HMI
F8	5A	Power to CAN Connector J12
F9	5A	Power to CAN Connector J14
F10	10A	8X Power (Install fuse in right position)
F11	10A	Zone 1 LLS (Multi-Temp only)
F12	5A	Power to CAN Connector J13
F13	2A	8FC Circuit (Remote Status Light/Optional Power)
F15	P/S	On/Off Relay
F20	2A	Alternator Sense
F25	7.5A	HPCO Switch Circuit
F26	5A	Power to CAN Connector J98

Unit Description

Fuse	Size	Function
F4		Fuse F4 must be removed for Bosch and Thermo King alternators. Fuse F4 fuse must be in place for Prestolite alternators to charge.
F5		The F5 preheat fuse is a “slow blow” type fuse. It is designed for use with the Yanmar trailer engine air pre-heater. Always replace the fuse with the TK specified fuse.
F10		The F10 fuse must always be installed in the right position. CAUTION: When fuse F10 is installed in the left position the unit will start and run without the HMI control panel.
F15		The device identified as F15 is a poly switch. These over-current devices reset automatically and are not replaceable.

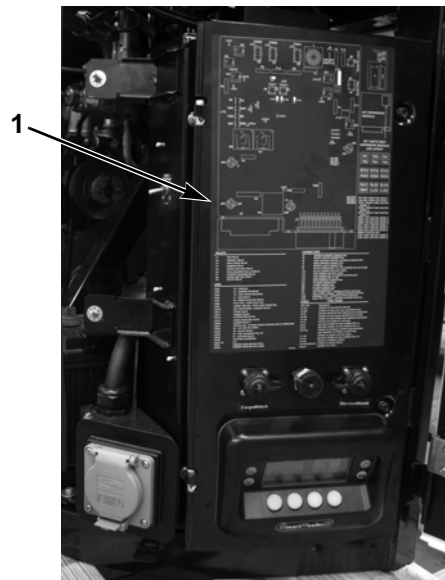

1.	Control Box
----	-------------

Figure 14: Control Box With Service Door Open

Unit Description

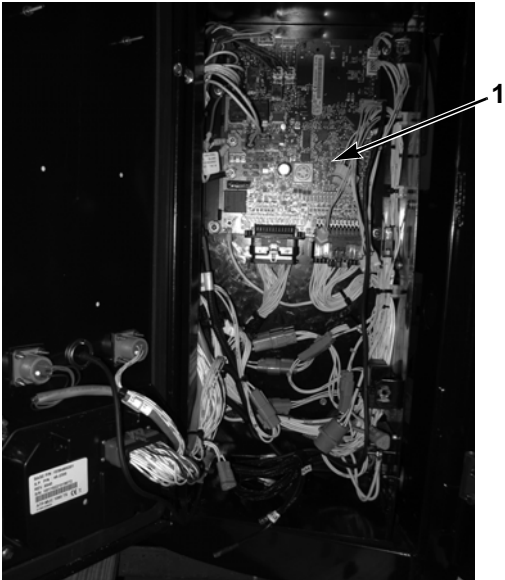

1. Base Controller

Figure 15: Control Box With Control Box Door Open

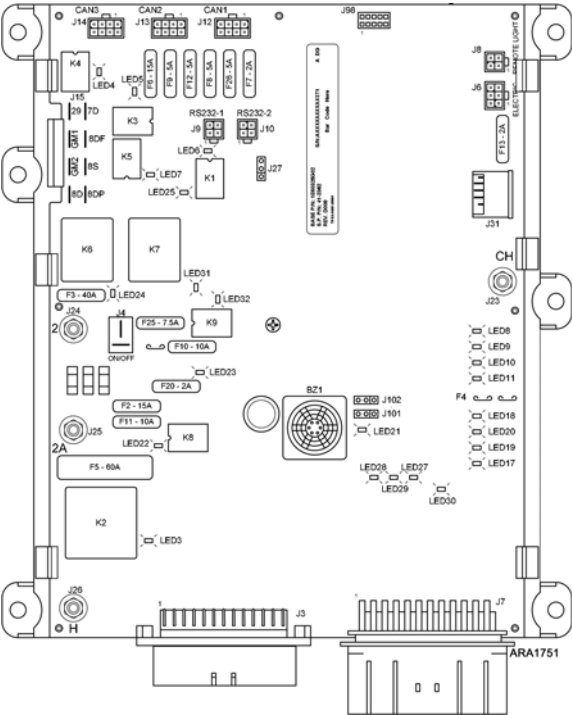

Figure 16: Base Controller

Unit Description

Remote Status Display (Optional)

The remote status display mounts on the cargo box for easy viewing of the unit's mode.



Figure 17: Remote Status Display (All LEDs Shown)

The remote status display indicates operating status as follows:

White Status LEDs: Illuminate the “T” portion of the TK logo when the unit is functioning properly with no alarm codes.



Figure 18: Normal Operation No Alarms

Remote Status Display (Optional)

Amber Status LEDs: Illuminate the “K” portion of the TK logo when the unit has a check alarm code, but is still functioning properly. Check the unit as soon as possible to correct the alarm condition.



Figure 19: Check Alarm

White and Amber Status LEDs: The two bottom LEDs in the “T” (in white) and the four bottom LEDs in the “K” (in amber) are illuminated when the unit has a shutdown alarm code and the load integrity is at risk. Correct the alarm condition immediately.



Figure 20: Shutdown Alarm

Remote Status Display (Optional)

Remote status displays that also show the fuel level or the fuel level and the box temperature are also available. The number of white LEDs illuminated in the fuel level indicator show the fuel level. When the fuel level falls below 10%, only the two amber LEDs at the top and bottom of the fuel level indicator are illuminated to indicate the low fuel level.

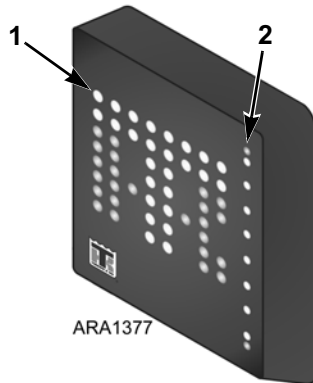

1.	Status Indicator
2.	Fuel Level Indicator

Figure 21: Remote Status Display with Fuel Level

The temperature display shows the box temperature, except when the unit is in defrost in which case it displays “dF”.

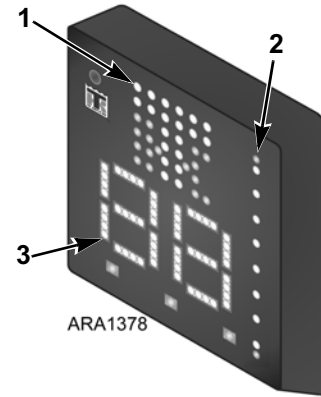

1.	Status Indicator
2.	Fuel Level Indicator
3.	Temperature Display

Figure 22: Remote Status Display with Fuel Level and Temperature

Remote Status Display (Optional)

Manual Pretrip Inspection (Before Starting the Unit)

Pretrip inspections are an important part of a preventative maintenance program designed to minimize operating problems and breakdowns. Perform this pretrip inspection before every trip involving refrigerated cargo.

NOTE: *Pretrip inspections are not intended to take the place of regular maintenance inspections.*

Fuel: Make sure the diesel fuel supply is adequate to guarantee engine operation to the next check point. Allow for maximum fuel consumption of one gallon per hour of engine operation.

Engine Oil: Check the engine oil level. It should be at the Full mark when the dipstick is threaded all the way into the oil pan. Do not overfill.



CAUTION: *Turn the engine off before checking the engine oil level.*

Engine Coolant: The engine coolant must have antifreeze protection to -30 F (-34 C). Add coolant if Alarm Code 37 is active. Check and add coolant to the expansion tank.



WARNING: *Do not remove the expansion tank cap while the coolant is hot.*

Battery: Make sure the battery terminals are tight and free of corrosion.

Belts: Make sure belts are in good condition and adjusted to the proper tension. For more information about belt tension, see the Specifications chapter.

Electrical: Check the electrical connections to make sure they are securely fastened. Wires and terminals should be free of corrosion, cracks, and moisture.

Structural: Visually inspect the unit for leaks, loose or broken parts, and other damage.

Manual Pretrip Inspection (Before Starting the Unit)

Damper: Make sure the damper in the evaporator air outlets move freely, with no sticking or binding.

Coils: Make sure the condenser and evaporator coils are clean and free of debris.

Cargo Box: Check the interior and exterior of the cargo box for damage. Any damage to the walls or insulation must be repaired.

Cargo Doors: Make sure that the cargo doors and weather seals are in good condition. The doors should latch securely and the weather seals should fit tightly.

Defrost Drains: Check the defrost drain hoses and fittings to make sure they are open.

Operating Instructions



Figure 23: SR-3 HMI Control Panel

SMART REEFER 3 (SR-3) Controller Overview

Thermo King has applied the latest advances in computer technology to develop a device that controls temperature and unit function, and displays operating information quickly and accurately.

There is nothing complicated about learning to operate the SR-3 Controller, but you will find that a few minutes studying the contents of this manual will be time well spent.



WARNING: Do not operate the unit until you are completely familiar with the location and function of each control.

Operating Instructions

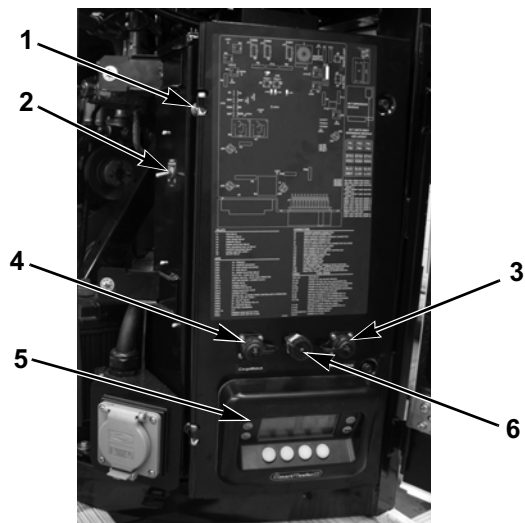

1.	Control Box	4.	CargoWatch Port
2.	Microprocessor On/Off Switch	5.	HMI Control Panel
3.	ServiceWatch Port	6.	USB Port

Figure 24: Control Box With Service Door Open

The microprocessor components are located inside the control box, which is located inside the lower roadside service door. The microprocessor is connected to an HMI (Human Machine Interface) Control Panel. It is used to operate the unit. The CargoWatch and ServiceWatch ports are used to retrieve data from the data logging system.

Microprocessor On/Off Switch: This switch supplies or removes electrical power to the microprocessor. It is located on the left side of the control box. See Figure 24.



WARNING: *The unit can start at any time without warning. Press the OFF key on the HMI control panel and place the microprocessor On/Off switch in the Off position before inspecting or servicing any part of the unit.*

Operating Instructions

HMI Control Panel

The HMI control panel has a display and eight touch sensitive keys. The display is capable of showing both text and graphics. The four keys on the left and right sides of the display are dedicated keys. The four keys under the display are “soft” keys. The function of “soft” keys change depending on the operation being performed. If a soft key is active, its function will be shown in the display directly above the key.

Control Panel Display

The display is used to supply unit information to the operator. This information includes setpoint, current box temperature operating information, unit gauge readings, system temperatures and other information as selected by the operator.

The default display is called the Standard Display. It is shown in Figure 25 and will be described in detail later in this chapter.

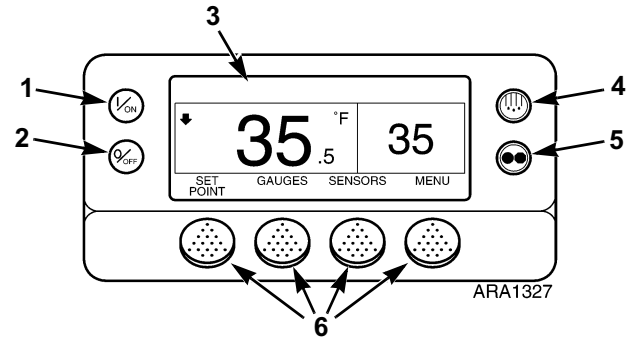

1.	On Key (Dedicated Key)
2.	Off Key (Dedicated Key)
3.	Display
4.	Defrost Key (Dedicated Key)
5.	CYCLE-SENTRY/Continuous Mode Key (Dedicated Key)
6.	Soft Keys

Figure 25: Control Panel Display and Keys

Control Panel Keys

The four keys on the left and right sides of the display screen are “dedicated keys” (see Figure 25). Their functions are listed below.



On Key: This key is used to turn the unit on. First the display will briefly show the Thermo King Logo and then the statement "Configuring System - Please Wait". When the power-up sequence is complete the display shows the Standard Display of box temperature and setpoint.



Off Key: This key is used to turn the unit off. First the display will briefly show "System is Powering Down - Please Wait. Press On to Resume" and then "Off" will appear momentarily. When the power-down sequence is complete the display will be blank.



Defrost Key: Press this key to initiate a Manual Defrost cycle.



CYCLE SENTRY/Continuous Mode Key:

Press this key to switch back and forth between the CYCLE-SENTRY mode and the Continuous Run mode. If OptiSet Plus is in use, it may not be possible to change the Mode.

Operating Instructions

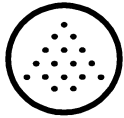

The four "soft" keys under the display are multi-purpose keys. Their function changes depending on the operation being performed. If a soft key is active the key function is shown in the display directly above the key. The keys are numbered from left to right, with Key 1 on the far left and Key 4 on the far right.

Typical soft key applications:

- Setpoint
- Gauges
- Sensors
- Menu
- Next/Back
- Yes/No
- +/-
- Select/Exit
- Clear/Help
- Hourmeters

Turning Unit On

Complete the following steps to turn on the unit:

1. Press the **ON** key. See Figure 26.

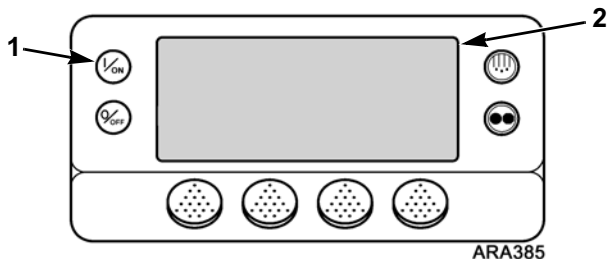

1.	On Key
2.	Display

Figure 26: Press On Key

2. The display briefly shows a Thermo King Logo. See Figure 27 on page 58.

IMPORTANT: The ON key must be held down until the Thermo King Logo appears. If the ON key is not held down long enough (approximately ½ second), the display may flicker but the unit will not start up. If this occurs, hold the ON key down until the Thermo King logo appears.

NOTE: With extremely cold ambient temperatures it may take up to 15 seconds for the first display to appear.

3. The “Configuring System” Screen briefly appears while communications are established and the unit prepares for operation. See Figure 27.

NOTE: If more than one language has been enabled, a prompt will appear at this point to allow the desired language to be chosen. If this occurs, go to “More Than One Language Enabled” on page 59 to continue the unit start up procedure. If this does not occur, only one language is enabled and you can continue with the unit start up Step 4 below.

4. The Standard Display showing box temperature and setpoint briefly appears. See “Figure 27: Turning Unit On Screen Sequence, One Language Enabled,” on page 58.
5. The “Diesel Engine Starting” Screen briefly appears as the engine preheats and starts.

Operating Instructions

6. The Standard Display showing box temperature and setpoint reappears when the unit is running. (See Figure 27.)

Operating Instructions

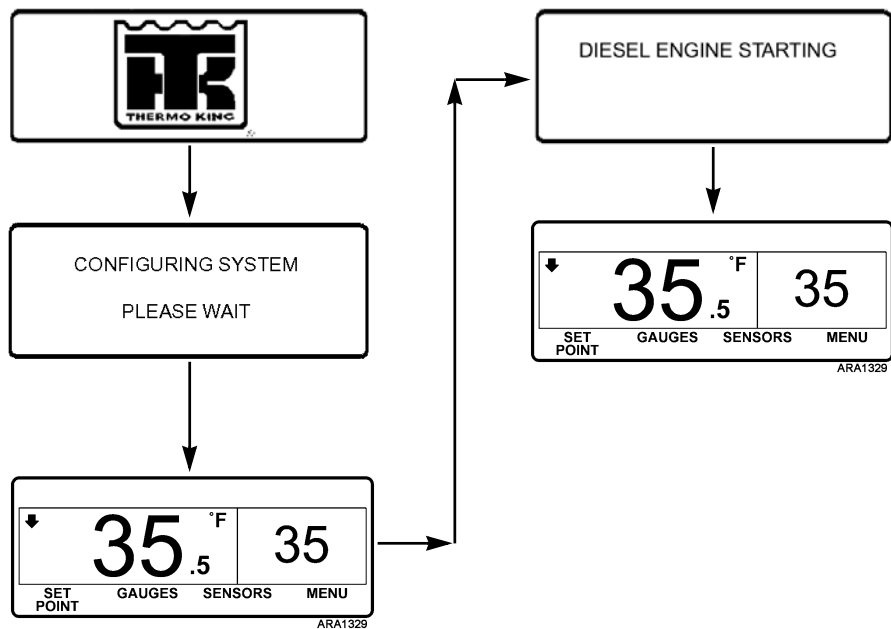

Figure 27: Turning Unit On Screen Sequence, One Language Enabled

Operating Instructions

More Than One Language Enabled

If more than one language has been enabled, a prompt will appear to allow the desired language to be chosen. Only languages enabled from the Guarded Access Menu are available. Press YES to select the language displayed. If a different language is desired, press the NO key as shown in Figure 28.

IMPORTANT: *The engine start is not delayed by the language prompt as shown in Figure 28. The prompt will appear for 10 seconds and then the engine will start. After the engine is started the display will return to the prompt shown in Figure 28.*

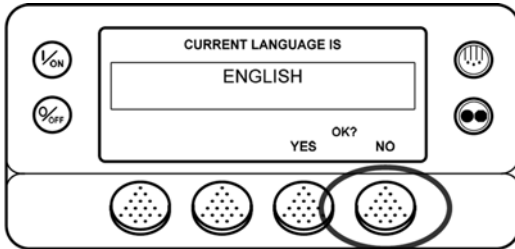

Figure 28: NO Key

The Language menu will appear as shown in Figure 29. Press the + or - keys to select the desired language. When the desired language is shown press the YES key to confirm the choice.

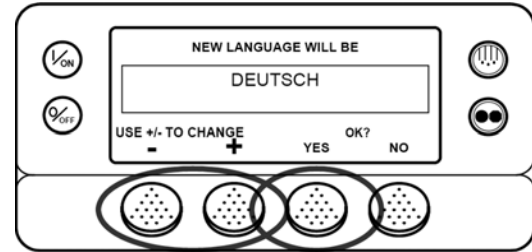

Figure 29: Language Menu

The display will briefly show PROGRAMMING LANGUAGE - PLEASE WAIT in the new language as shown in Figure 30.

Operating Instructions

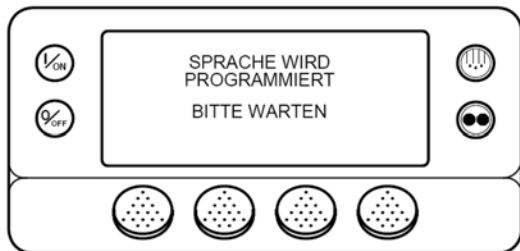

Figure 30: New Language

The new language is confirmed, and then the Standard Display will appear in the new language as shown in Figure 31. The unit is now ready to run.

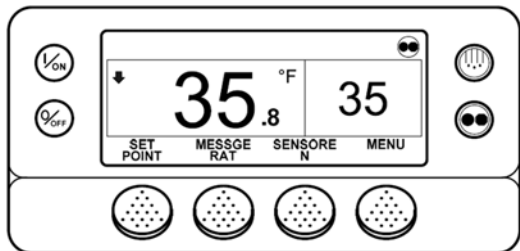

Figure 31: Standard Display

The “Diesel Engine Starting” Screen will briefly appear as the engine preheats and starts.

The Standard Display showing box temperature and setpoint will reappear (as shown in Figure 31) when the unit is running.

Operating Instructions

Turning Unit Off

Complete the following steps to turn unit off:

1. Press the **OFF** key.
2. The engine will immediately shut off.
3. The “System is Powering Down” Screen will briefly appear.
4. The Off Screen will briefly appear.
5. The screen goes blank when the unit power is off. To start the unit again, press the ON Key.

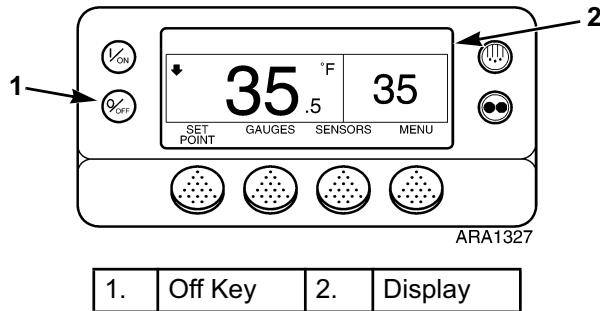

Figure 32: Press Off Key

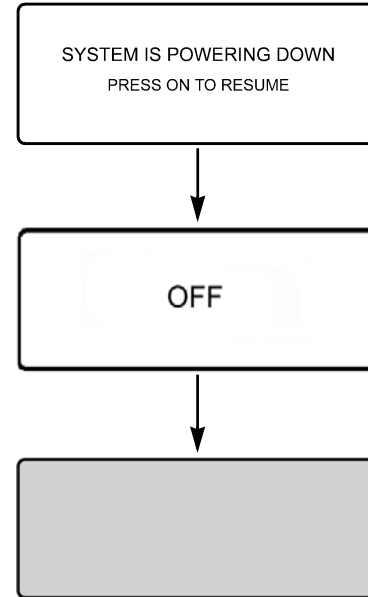
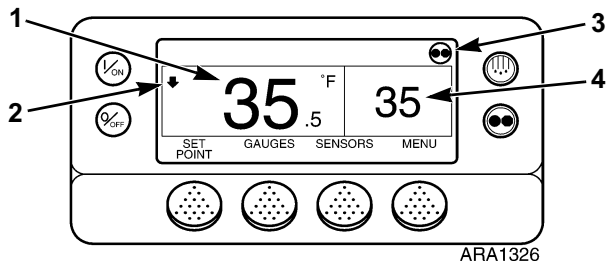

Figure 33: Turning Unit Off Screen Sequence

Standard Display

The Standard Display is the default display. It appears if no other display function is selected. The Standard Display shows the box temperature and setpoint. The box temperature is measured by the controlling sensor. The return air sensor is the controlling sensor except when the controller is programmed to use the discharge air sensor as the controlling sensor during modulation. The box temperature shown below in Figure 34 is 35.5 F. The setpoint shown is 35 F. The CYCLE-SENTRY Icon in the upper right corner of the display shows the unit is operating in the CYCLE-SENTRY mode. The arrow pointing down indicates the unit is cooling.

NOTE: *The CYCLE-SENTRY icon will appear when the unit is operating in CYCLE-SENTRY mode as shown below. If the CYCLE-SENTRY icon is not present the unit is operating in Continuous mode.*



1.	Box Temperature	3.	CYCLE-SENTRY Icon
2.	Cooling	4.	Setpoint

Figure 34: Standard Display

Standard Display Variations when OptiSet Plus is in Use

The Standard Display has variations. A display showing any of the following variations is still considered a Standard Display (see Figure 35).

The top of the display may show a named product if the controller has been programmed with OptiSet Plus temperature profiles. The far left soft key may display **PRODUCT** or **PRODUCT/SETPOINT** if the Base Controller has been programmed with OptiSet Plus temperature profiles. See “OptiSet Plus” on page 132 for information about selecting or changing the named product or the setpoint if the Base Controller has been programmed with OptiSet Plus temperature profiles. Contact your Thermo King dealer for information about programming the Base Controller with OptiSet Plus temperature profiles.

The temperature can be displayed in degrees Fahrenheit (F) or degrees Celsius (C). An arrow pointing upwards indicates the unit is heating. An arrow pointing downwards indicates the unit is cooling.

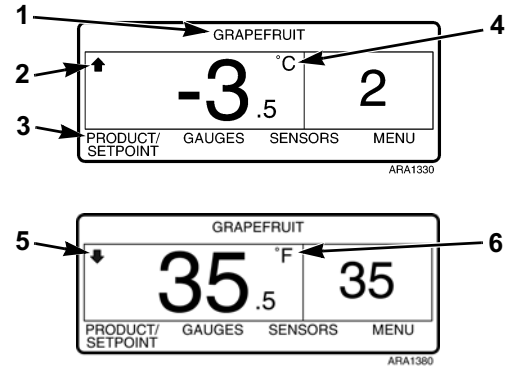

1.	Named Product
2.	Heating
3.	PRODUCT or PRODUCT/SETPOINT Soft Key
4.	Degrees Celsius
5.	Cooling
6.	Degrees Fahrenheit

Figure 35: Standard Display Variations

Temperature Watch Display

The Standard Display defaults to the Temperature Watch Display after about 2-1/2 minutes of non-use (when no keys are pressed) and no check, prevent or shutdown alarms are present. The Temperature Watch Display shows the same box temperature and setpoint but in larger fonts. This creates easy operator viewing from a distance. To return to the Standard Display press the **MENU** soft key (or any of the other three soft keys that are not assigned).

***NOTE:** A named product may appear above the temperature reading if the Base Controller has been programmed with OptiSet Plus temperature profiles and a named product has been selected.*

***NOTE:** The CYCLE-SENTRY icon will appear in the Temperature Watch display when the unit is operating in CYCLE-SENTRY mode as shown below. If the CYCLE-SENTRY icon is not present the unit is operating in Continuous mode.*

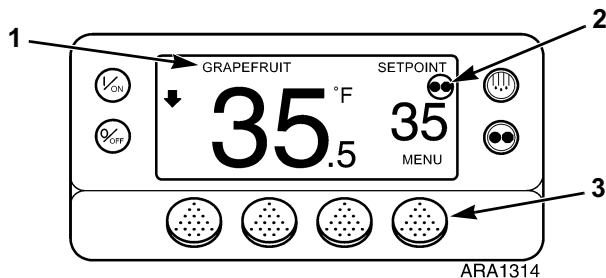

1.	Named Product (If Selected)
2.	CYCLE-SENTRY Icon
3.	Menu Soft Key

Figure 36: Temperature Watch Display

Operating Instructions

Alarm Display

If a unit alarm condition occurs the large Alarm Icon will appear on the Standard Display as shown below in Figure 37.

NOTE: A shutdown alarm will also cause the display and backlight to flash on and off, and the display will switch from normal video to reverse video and back to normal video (light areas become dark and dark areas become light).

IMPORTANT: Always record any Alarm Codes shown. This information is very valuable to service personnel.

See “Alarms Menu” on page 97 for information about displaying and clearing alarms.

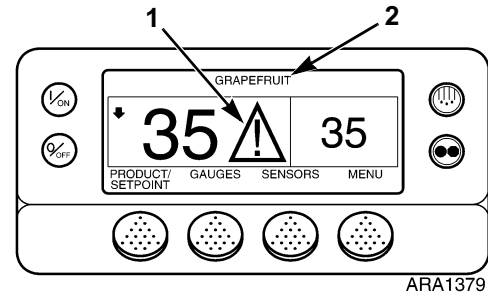

ARA1379

1.	Alarm Icon
2.	Named Product (If Selected)

Figure 37: Alarm Display

Starting the Diesel Engine

Diesel engine preheats and starts automatically in both Continuous Mode and CYCLE-SENTRY mode. The engine will preheat and start if necessary when the unit is turned on. The engine preheat and start will be delayed in CYCLE-SENTRY mode if there is no current need for the engine to run. If a key or sequence of keys are pressed on the HMI Control Panel before the engine starts, the engine will preheat and start approximately 10 seconds after pressing the last key.

See “Turning Unit On” on page 56.



CAUTION: *The engine may start automatically any time the unit is turned on.*



WARNING: *Never use starting fluid.*

NOTE: *Run a pretrip test if the unit has not been used recently. See “Pretrip Tests” on page 120.*

Unit Fails To Start

If the engine does not start and the Alarm Icon appears on the display, take the following steps.

1. Check for and correct any alarm conditions. See “Viewing and Clearing Alarms Screen Sequence” on page 100.
2. Clear all alarms. See “Viewing and Clearing Alarms Screen Sequence” on page 100.
3. Press the **OFF** key to turn the unit off.
4. Press the **ON** key to turn the unit on.
5. The Base Controller will go through the start up screens and then after a 10 second delay the unit will start automatically.
6. If the engine will still not start, turn the unit off. Determine and correct the cause for not starting.
7. Repeat the procedure.

Operating Instructions

After Start Inspection

After the unit is running, check the following items to confirm that the unit is running properly.

Oil Pressure: Check the engine oil pressure by pressing the **GAUGES** soft key. See “Viewing Gauge Readings” on page 84. The Engine Oil Pressure Display should indicate OK not LOW.

Ammeter: Check the ammeter reading by pressing the **GAUGES** soft key. See “Viewing Gauge Readings” on page 84. The Amps Display should indicate a positive charge amperage rate to the battery. A negative (-) number indicates a discharge condition.

Compressor Oil: The compressor oil level should be visible in the compressor sight glass after 15 minutes of operation. If not, check the compressor oil level using the procedure in the appropriate maintenance manual.

Pre-Cooling: Make sure that the setpoint is at the desired temperature. See “Changing the Setpoint” on page 74. Allow the unit to run for a minimum of 30 minutes (longer if possible) before loading the trailer.

This provides a good test of the refrigeration system while removing residual heat and the moisture from the trailer interior to prepare it for a refrigerated load.

Defrost: When the unit has finished pre-cooling the trailer interior, manually initiate a Defrost cycle. See “Initiating a Manual Defrost Cycle” on page 81. This will remove the frost that builds up while running the unit to pre-cool the trailer.

Electric Standby Operation

Model 50 units are equipped with Electric Standby. This feature allows the unit to operate on electric power as well as be powered by the standard diesel engine.

During Electric Standby operation, power to the unit is supplied by an electric motor connected to a high voltage power source. The required voltage is shown on a decal on the unit's electric power receptacle.



WARNING: Units equipped with electric standby may start at any time when the unit is connected to live electric power and the Base Controller is turned on.



CAUTION: Always turn the electric power supply off when handling, connecting, or disconnecting high voltage power cords.



CAUTION: Do not start the electric drive motor unless the diesel engine is completely stopped.

Electric Power Receptacle: The electric power receptacle is used to connect the unit to an appropriate electric power source for electric standby operation. The electric power receptacle is located next to the HMI Control Panel. Make sure the unit and the power supply are turned off before connecting or disconnecting a power cord.

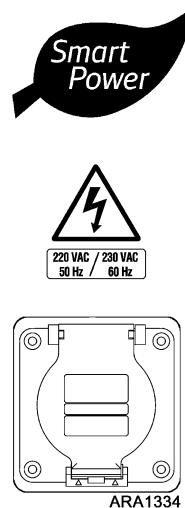

Figure 38: Electric Power Receptacle

Starting the Unit on Electric Standby Operation

Units equipped with the Electric Standby option only.

Electric motor starting is automatic in both Continuous Mode and Cycle Sentry Mode. The motor will start as required when the unit is turned on. If any keys are being pressed on the HMI control panel prior to the motor start, the motor start will be delayed until 10 seconds after the last key is pressed. Start the unit on Electric Standby operation as follows:

1. Press the controller **OFF** key to make sure the unit is turned off.
2. Connect the unit electric power receptacle to an appropriate electric power supply.
3. Press the controller **ON** key.



CAUTION: *The motor may start automatically any time the unit is turned on.*

4. If a screen asking if you wish to switch to Electric Standby appears, press the **YES** soft key. This screen does not appear if the Base Controller is programmed to automatically switch from Diesel to Electric Standby, or if the unit was in Electric Standby when it was turned off.

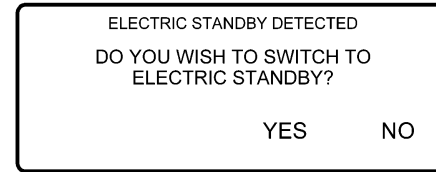

Figure 39: Electric Standby Detected Screen

Operating Instructions

5. If the microprocessor determines that the unit should cool or heat, the motor start screen appears as shown below. The preheat buzzer sounds for 20 seconds before the electric motor starts. It may not start if the return air sensor temperature is within a few degrees of setpoint. The electric motor cycles on and off in CYCLE-SENTRY Mode and runs continuously in Continuous Mode.



Figure 40: Electric Motor Starting Screen

6. Complete an After Start Inspection (see page 67) for Compressor Oil, Pre-Cooling and Defrost.

Unit Fails to Start

If the electric motor does not start and the Alarm Icon appears on the display, take the following steps.

1. Check for and correct any alarm conditions. See “Viewing and Clearing Alarms Screen Sequence” on page 100.
2. Clear all alarms. See “Viewing and Clearing Alarms Screen Sequence” on page 100.
3. Press the **OFF** key.
4. Press the **ON** key.
5. If the unit still does not start, repeat the above steps.

Operating Instructions

Switching from Diesel to Electric

Units equipped with the Electric Standby option only.

If the Diesel to Electric Autoswitch Enabled feature in Guarded Access is set YES then the unit will automatically switch to Electric Mode operation when standby power is connected and available.

If the Diesel to Electric Autoswitch Enabled feature in Guarded Access is set NO, then the prompt screen shown below will appear when standby power is connected and available.

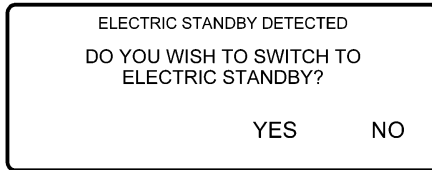

Figure 41: Electric Standby Detected Screen

If NO is selected, then the unit will continue to operate in Diesel Mode. If YES is selected then the display will briefly show the screen in Figure 42.



Figure 42: Programming Electric Standby Screen

Electric Mode operation will briefly be confirmed. If unit operation is required the electric motor will start as shown in “Starting the Unit on Electric Standby Operation” on page 69.

If the Diesel to Electric Autoswitch Enabled feature in Guarded Access is set NO then the unit can also be switched from Diesel mode to Electric mode operation using the Electric Standby Selection as shown in “Electric Standby/Diesel Mode” on page 126.

Switching from Electric to Diesel

Units equipped with the Electric Standby option only.

If the Electric to Diesel Autoswitch Enabled feature in Guarded Access is set YES then the unit will automatically switch to Diesel Mode operation when standby power is turned off or is no longer available.

If the Electric to Diesel Autoswitch Enabled feature in Guarded Access is set NO and standby power is disconnected or fails, the unit will not automatically switch to Diesel mode. This is primarily designed to prevent unauthorized diesel engine starts when the truck is indoors or on a ferry where engine operation is strictly prohibited. If the Electric to Diesel Autoswitch Enabled feature in Guarded Access is set NO then the prompt screen shown in Figure 43 will appear when standby power is turned off or is no longer available.

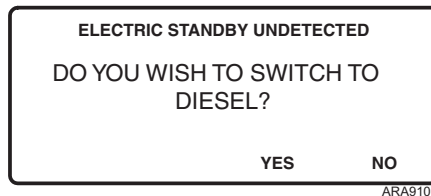

Figure 43: Electric Standby Undetected Screen

If YES is selected then the display will briefly show the screen below.

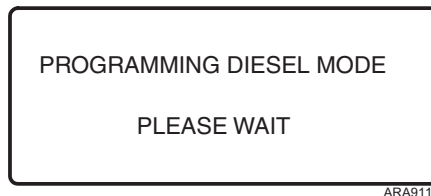

Figure 44: Programming Diesel Mode Screen

Diesel Mode operation will briefly be confirmed. If unit operation is required the diesel engine will start as shown in “Starting the Diesel Engine” on page 66.

Operating Instructions

If the Electric to Diesel Autoswitch Enabled feature in Guarded Access is set NO then the unit can also be switched from Diesel mode to Electric mode operation using the Diesel Selection as shown in “Navigating the Main Menu” on page 91.

Changing the Setpoint

To change the setpoint complete the following steps.

NOTE: If the **SETPOINT** soft key (far left) displays **PRODUCT** or **PRODUCT/SETPOINT**, the Base Controller has been programmed with *OptiSet Plus* temperature profiles. See “*OptiSet Plus*” on page 132 for information about selecting or changing the named product or the setpoint.

1. Begin at the Standard Display.
If the Temperature Watch Display is showing, press the **MENU** soft key once to return to the Standard Display.
2. Press the **SETPOINT** soft key on the Standard Display. See Figure 45. The “Setpoint” Screen briefly appears, then the “Current Setpoint” Screen appears. See Figure 46.
3. Press the **+** or **-** soft keys to change the setpoint reading. See Figure 46.

NOTE: If the setpoint is changed using the “+” or “-” keys, the change must be confirmed or rejected by pressing the **YES** or **NO** soft key within 10 seconds of changing the setpoint. A warning beep will sound for 5 seconds as a reminder.

4. Press the **YES** or **NO** soft key accordingly as described below. See Figure 46.

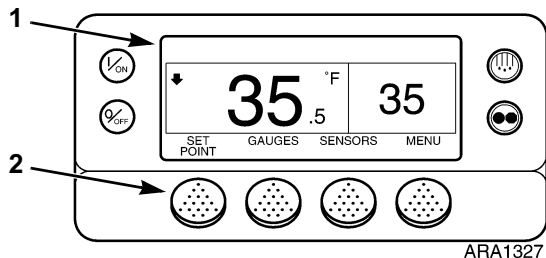

1.	Standard Display
2.	Setpoint Soft Key

Figure 45: Changing Setpoint

- If the **No** key is pressed the setpoint change made with the “+” or “-” soft keys **will not** be accepted, the setpoint will not be changed and the display will return to the Standard Display.
- If the **Yes** soft key is pressed, the setpoint change made with the “+” or “-” soft keys will be accepted, and display screens will appear as shown in Figure 46.

Operating Instructions

- If the YES or NO key is not pressed within 10 seconds of making a change with the "+" or "-" key, the setpoint is not changed and the display returns to the Setpoint Display. The display briefly shows [SETPOINT NOT CHANGED] and Alarm Code 127 Setpoint Not Entered is set, to indicate that the setpoint change was started but not completed.
5. The “Programming New Setpoint” Screen will appear. See Figure 46.
 6. The “New Setpoint Is XX” Screen briefly appears. See Figure 46.
 7. The Standard Display appears with setpoint changed to the new setpoint. See Figure 46.

Operating Instructions

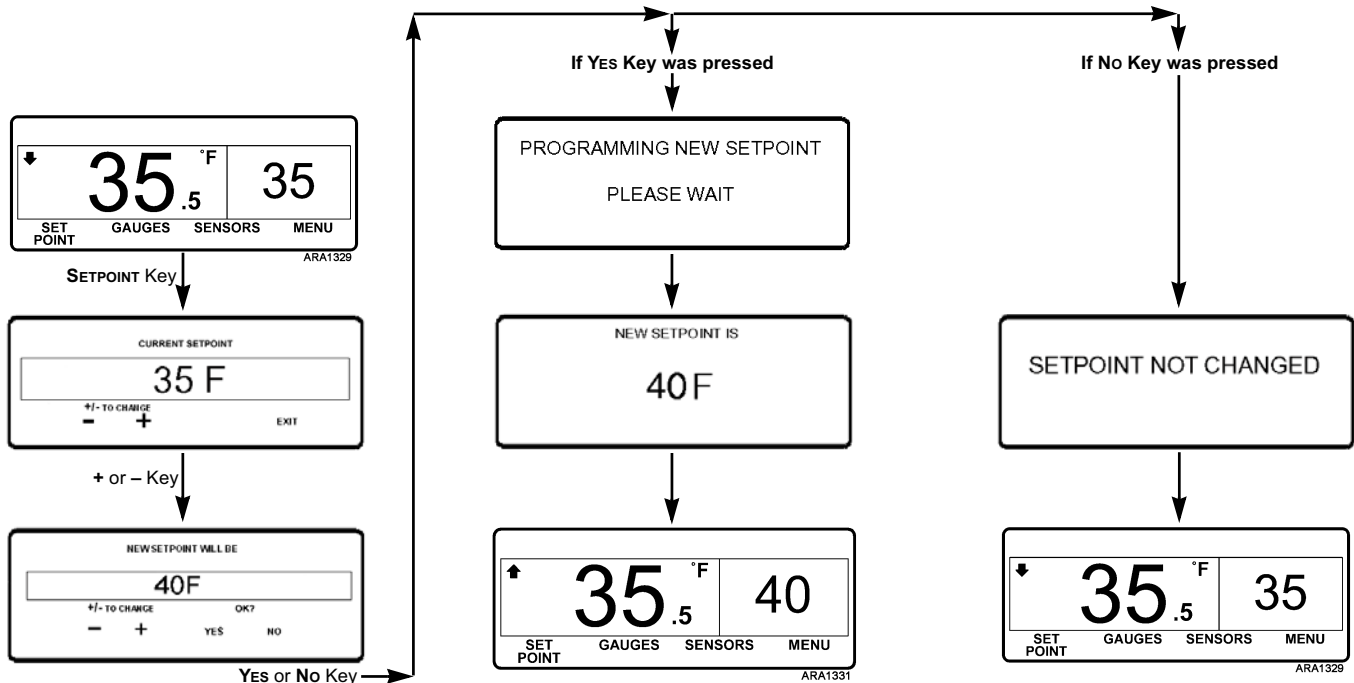

Figure 46: Changing the Setpoint Screen Sequence

Selection of Operating Modes

The Thermo King CYCLE-SENTRY system is designed to save refrigeration fuel costs. The savings vary with the commodity, ambient temperatures and trailer insulation. However, not all temperature controlled products can be properly transported using CYCLE-SENTRY operation. Certain highly sensitive products normally require continuous air circulation. Use the following guidelines to select the proper operating mode to protect the commodity you are transporting.

Examples of products normally acceptable for CYCLE-SENTRY Operation:

- Frozen foods (in adequately insulated trailers)
- Boxed or processed meats Poultry
- Fish
- Dairy products
- Candy
- Chemicals
- Film
- All non-edible products.

Examples of products normally requiring Continuous Run Operation for air flow:

- Fresh fruits and vegetables, especially asparagus, bananas, broccoli, carrots, citrus, green peas, lettuce, peaches, spinach, strawberries, sweet corn, etc.
- Non-processed meat products (unless pre-cooled to recommended temperature).
- Fresh flowers and foliage.

The above listings are not all inclusive. Consult your grower or shipper if you have any questions about the operating mode selection of your type of load.

IMPORTANT: If OptiSet Plus is in use, it may not be possible to change the Mode.

Selecting CYCLE-SENTRY or Continuous Mode

When CYCLE-SENTRY mode is selected the unit will start and stop automatically to maintain the setpoint, keep the engine warm, and the battery charged. When Continuous mode is selected, the unit will start automatically and run continuously to maintain setpoint and provide constant airflow.

If the unit is operating in Cycle Sentry Mode, the Cycle Sentry Icon will be present in the upper right corner of the display as shown in Figure 47. If the Cycle Sentry Icon is not present the unit is operating in Continuous Mode.

IMPORTANT: *If OptiSet Plus is in use, it may not be possible to change the Mode.*

Complete the following steps to change modes:

NOTE: *The mode can also be changed using the Mode Menu Screen in the Main Menu. See “Turning CYCLE-SENTRY On or Off” on page 112.*

1. Press the **CYCLE SENTRY/CONTINUOUS MODE** key. See Figure 47.

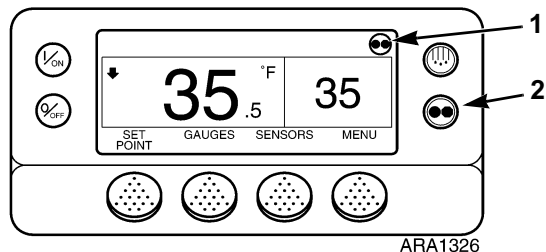

1.	CYCLE-SENTRY Icon Shows Mode Selected Displayed for CYCLE-SENTRY Mode Not Displayed for Continuous Mode
2.	CYCLE SENTRY/Continuous Mode Key

Figure 47: Changing Mode

2. The “Programming Continuous Mode” or “Programming CYCLE-SENTRY Mode” Screen briefly appears. See Figure 48 and Figure 49.
3. The “New System Mode is Continuous” Screen or the “New System Mode CYCLE-SENTRY” Screen briefly appears. See Figure 48 and Figure 49.

Operating Instructions

- The Standard Display appears showing the new mode. See Figure 48 and Figure 49.
- Press the **CYCLE SENTRY/CONTINUOUS MODE** key again to change the unit back to the previous mode.

IMPORTANT: *If the unit is in Cycle Sentry null and the mode is switched to Continuous Mode, the unit will start automatically.*

NOTE: *Cycle Sentry or Continuous mode may be disabled by OptiSet Plus.*

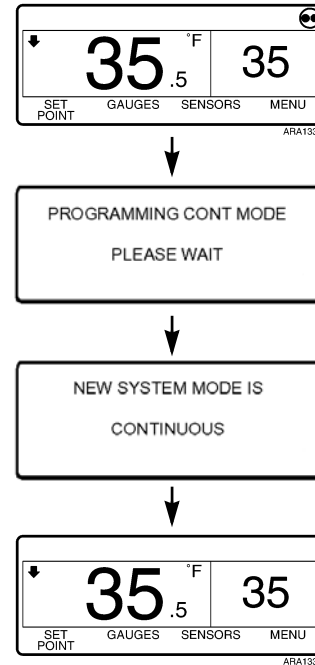

Figure 48: Screen Sequence for Changing from CYCLE-SENTRY Mode to Continuous Mode

Operating Instructions

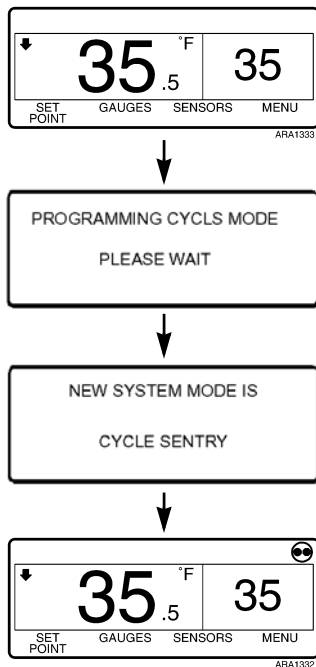

Figure 49: Screen Sequence for Changing from Continuous Mode to CYCLE-SENTRY Mode

Initiating a Manual Defrost Cycle

Defrost cycles are usually initiated automatically based on time or temperature. Manual Defrost is also available if the unit is running and the coil temperature is less than 45 F (7 C).

Other features such as door switch settings may not allow Manual Defrost to be initiated.

Use the following steps to initiate a Manual Defrost:

1. Press the **DEFROST** key. See Figure 50.
2. The “Defrost” Screen briefly appears. See Figure 51.
3. The “Programming Defrost” Screen briefly appears. See Figure 51.
4. The “Defrost Started” Screen briefly appears. See Figure 51.

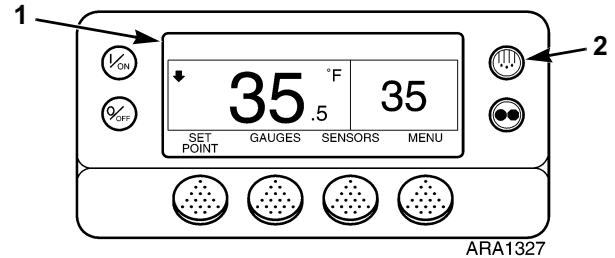

1.	Standard Display
2.	Defrost Key

Figure 50: Initiating a Manual Defrost Cycle

Operating Instructions

5. A modified Standard Display appears. The bar indicator will fill in showing time remaining to complete the Defrost cycle. The bar indicator in the figure shows that the Defrost cycle is 50% complete. When the Defrost cycle is complete the display returns to the Standard Display. See Figure 51.

The unit may be prevented from going into a Manual Defrost. For example, this can occur if the coil temperature is more than 45 F (7 C). If defrost is not available, the “Defrost Not Available” message will appear and the display will return to the Standard Display. See Figure 51.

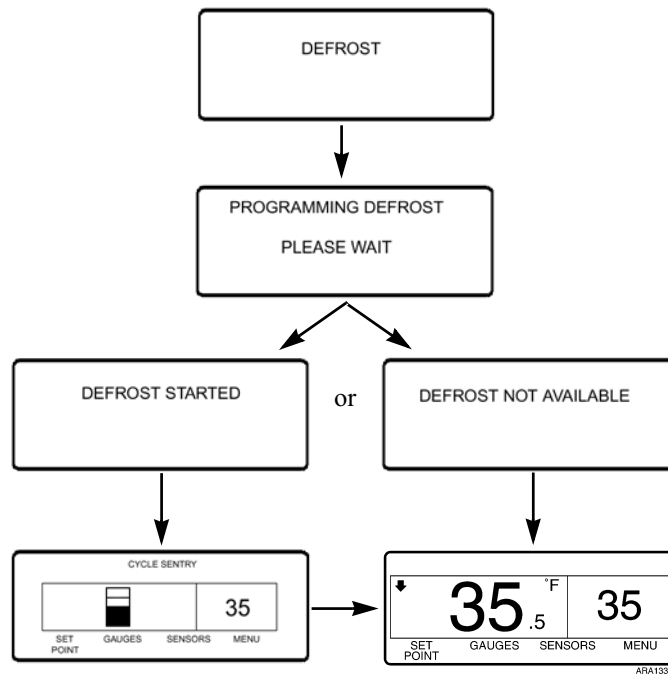

Figure 51: Initiating Manual Defrost Screen Sequence

Terminating a Defrost Cycle

The Defrost cycle will terminate automatically when the coil temperature reaches 58 F (14 C), or when the defrost timer expires. The defrost timer is normally set for 45 minutes, but can be set for 30 minutes. Defrost can also be terminated by turning the unit off.

NOTE: If the defrost timer consistently terminates Defrost because the evaporator coil temperature fails to reach 58 F (14 C), have the unit checked by a Thermo King dealer to see if it is working properly.

Viewing Gauge Readings

Use the following steps to view the gauge readings:

1. Begin at the Standard Display.
If the Temperature Watch Display is showing, press the **MENU** soft key once to return to the Standard Display.
2. Press the **GAUGES** soft key to enter the Gauges Menu. See Figure 52.
3. Press **BACK** or **NEXT** soft keys to scroll through available gauges:

Gauges Available

Coolant Temperature: Displays the temperature of the engine coolant.

Coolant Level: Displays the coolant level in the overflow tank.

Oil Pressure: Displays the engine oil pressure as OK or LOW.

Oil Level: Displays the engine oil level as OK or LOW.

Amps: Displays the current flow in amps flowing to or from the unit battery

Battery Voltage: Displays the voltage of the unit battery.

Engine RPM: Displays the engine speed in RPMs.

Fuel Level Sensor: Displays the fuel level if a fuel level sensor is installed.

Discharge Pressure: Displays the unit discharge pressure. (ETV units only)

Suction Pressure: Displays the unit suction pressure. (ETV units only)

ETV Position: Displays the current position of the ETV valve. (ETV units only)

I/O (Input/Output State): Displays the current state of the input/output devices listed below.

- High Speed Relay/Electric Heat as ON or OFF
- Run Relay
- Run Relay Feedback
- Alternator Excite Output

Operating Instructions

- Defrost Damper
- Heat Output
- Alternator Frequency
- Diesel/Electric Relay (Model 50 units only)
- Electric Ready Input (Model 50 units only)
- Electric overload (Model 50 units only)
- Hot Gas Bypass (ETV units only)

Selecting I/O enters a group of screens that are used only by technicians. See Figure 53. If no keys are pressed within 30 seconds, the screen will return to the standard display.

NOTE: Units without an Electronic Throttling Valve (ETV) will not display the Discharge Pressure, Suction Pressure, and ETV Position. See “Electronic Throttling Valve” on page 36 for more information about the ETV and how to tell if the unit has an ETV.

4. Press the **LOCK** soft key to display any Gauge Screen for an indefinite period. Press the key again to unlock the screen.

5. Press the **EXIT** soft key to return to the Standard Display.

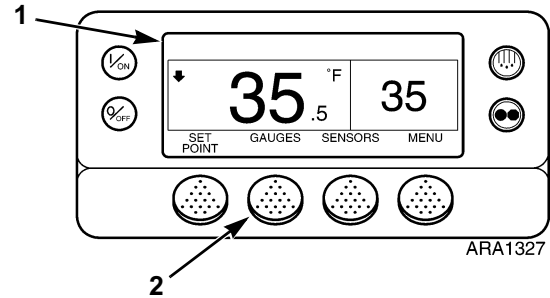

1.	Standard Display Screen
2.	Gauges Soft Key

Figure 52: Viewing Gauges

Operating Instructions

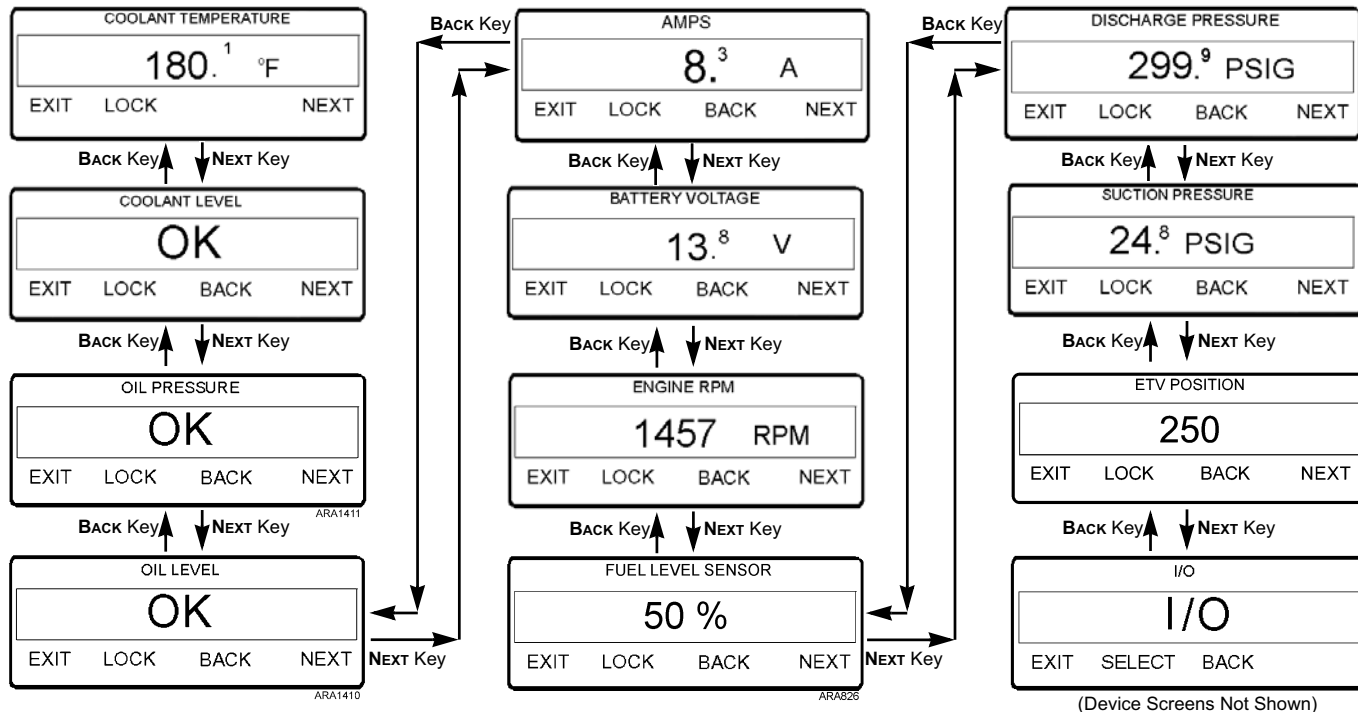

Figure 53: Viewing Gauges Screen Sequence

Operating Instructions

Viewing Sensor Readings

Use the following steps to view the sensor readings.

1. Begin at the Standard Display.
If the Temperature Watch Display is showing, press the **MENU** soft key once to return to the Standard Display.
2. Press the **SENSOR** soft key to enter the Sensor Menu. See Figure 54.

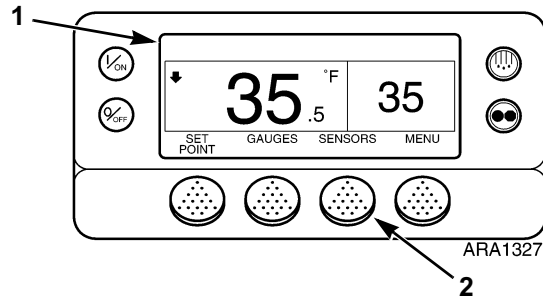

1.	Standard Display
2.	Sensors Soft Key

Figure 54: Viewing Sensors

3. Press the **BACK** or **NEXT** soft keys to scroll through the sensor screens. Pressing the **LOCK** key will lock the current sensor on the display. (Figure 55)

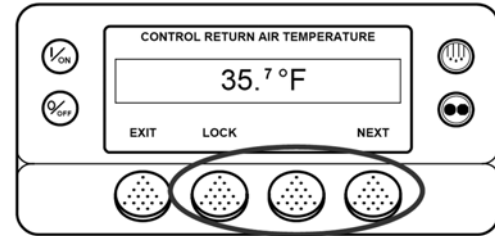

Figure 55: NEXT, BACK, LOCK Keys

Sensors Available

Control Return Air Temperature - Displays the temperature of the control return air sensor.

Display Return Air Temperature - Displays the temperature of the display return air sensor.

Control Discharge Air Temperature - Displays the temperature of the control discharge air sensor.

Operating Instructions

Display Discharge Air Temperature - Displays the temperature of the display discharge air sensor.

Temperature Differential - Displays the calculated difference between the control return air sensor and the control discharge air sensor.

Evaporator Coil Temperature - Displays the temperature of the evaporator coil sensor.

Ambient Air Temperature - Displays the temperature of the ambient air sensor.

Spare 1 Temperature - Displays the temperature of the spare 1 temperature sensor.

Log Sensor 1 - Displays the temperature of the CargoWatch Data Logger temperature sensor 1.

Log Sensor 2 - Displays the temperature of the CargoWatch Data Logger temperature sensor 2.

Datalogger Sensor 3 Temperature - Displays the temperature of the CargoWatch Data Logger temperature sensor 3.

Datalogger Sensor 4 Temperature - Displays the temperature of the CargoWatch Data Logger temperature sensor 4.

Datalogger Sensor 5 Temperature - Displays the temperature of the CargoWatch Data Logger temperature sensor 5.

Datalogger Sensor 6 Temperature - Displays the temperature of the CargoWatch Data Logger temperature sensor 6.

Board Temperature Sensor - Displays the internal temperature of the HMI Control Panel pc board. The Base Controller will turn the HMI display heater on if this temperature goes below a certain point in extremely cold ambient temperatures.

See Figure 56 and Figure 57. If no keys are pressed within 30 seconds, the screen will return to the Standard Display.

4. Press the **LOCK** soft key to display any sensor screen for an indefinite period. Press the key again to unlock the screen.
5. Press the **EXIT** soft key to return to the Standard Display.

Operating Instructions

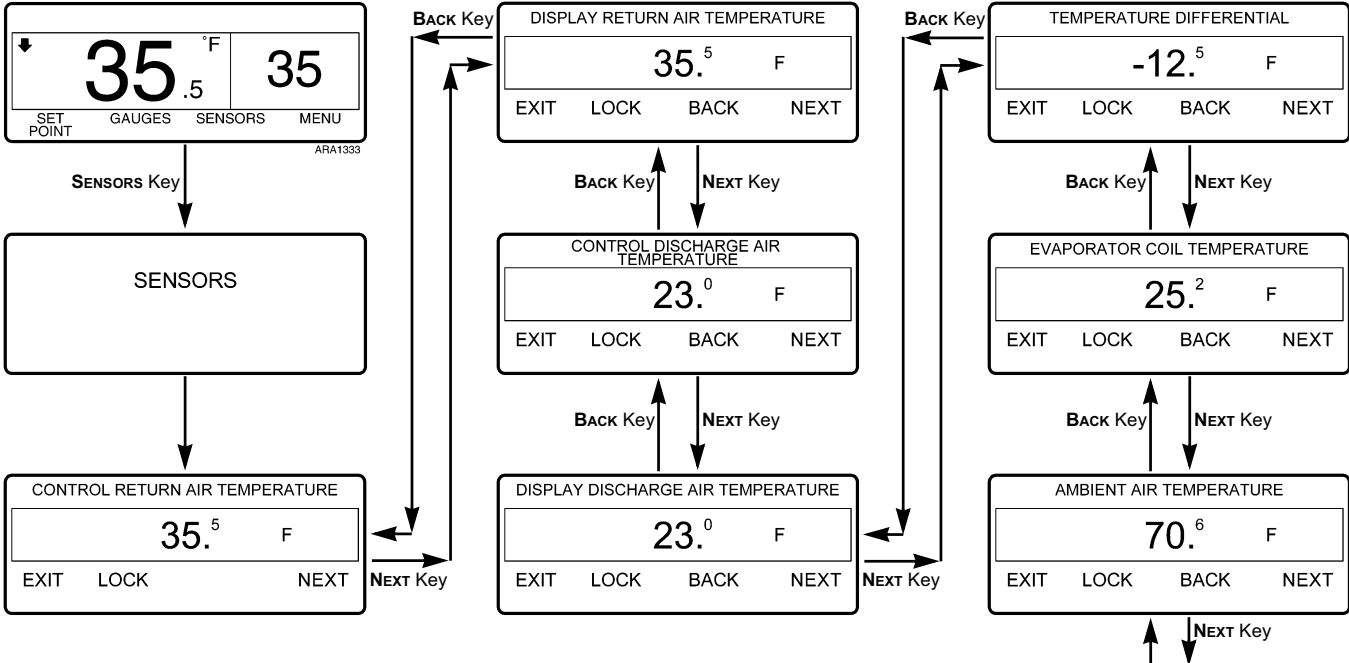

Figure 56: Viewing Sensors Screen Sequence (continued on next page)

Operating Instructions

Continued from previous page

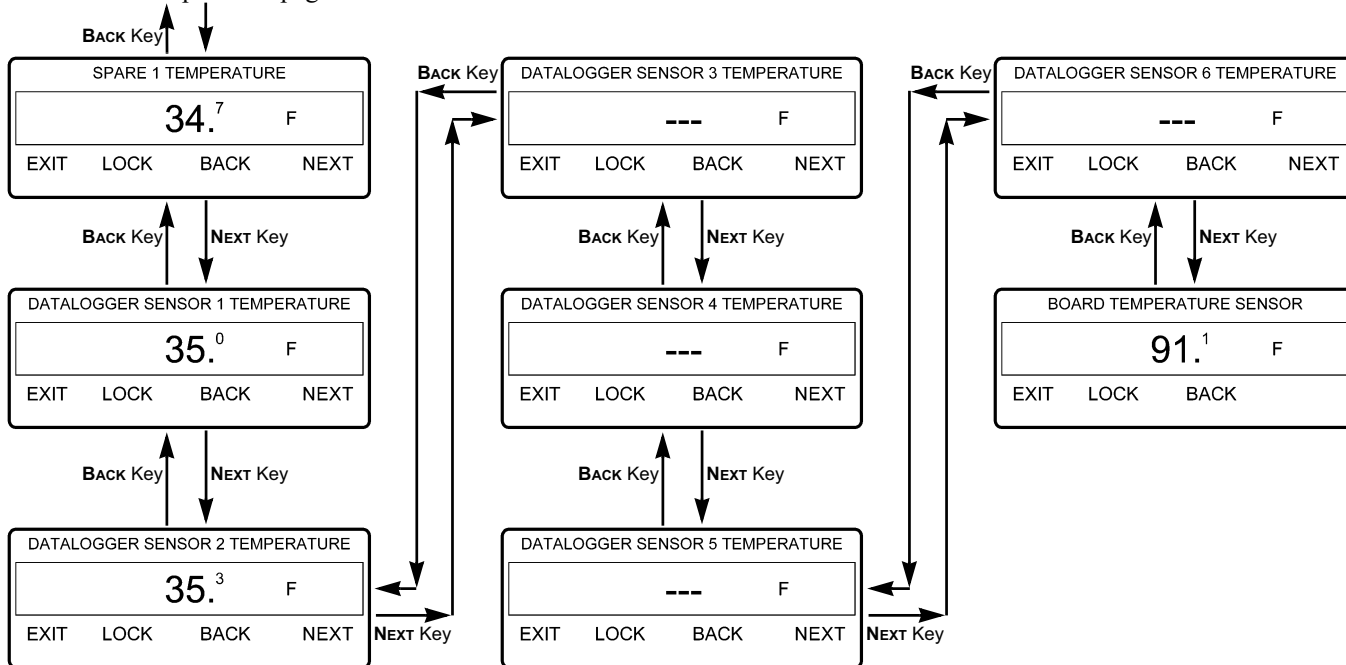
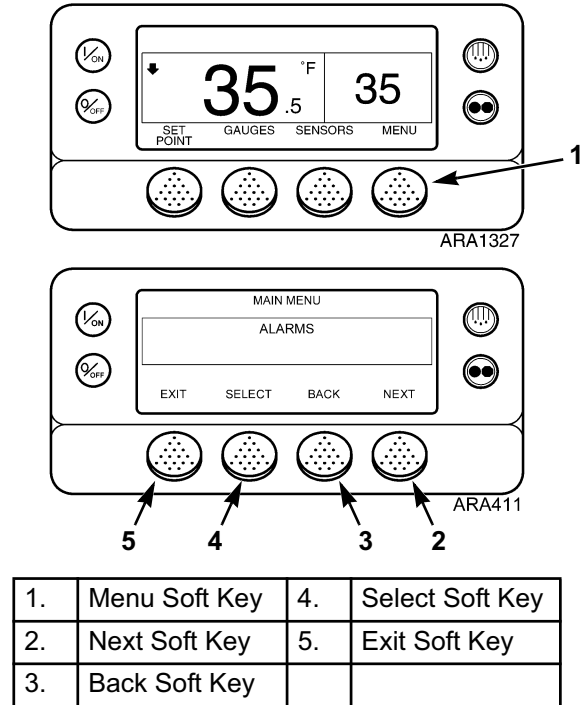

Figure 57: Viewing Sensors Screen Sequence (continued from previous page)

Navigating the Main Menu

The Main Menu contains several additional submenus that allow the operator to view information and modify unit operation. Use the following steps to access these menu areas:

1. Begin at the Standard Display.
If the Temperature Watch Display is showing, press the **MENU** soft key once to return to the Standard Display.
2. Press the **MENU** soft key. See Figure 58.
3. Press **NEXT** and **BACK** soft keys to scroll up or down through the main menu areas. See Figure 58 and Figure 59.
4. Press the **SELECT** soft key to access a specific menu area when shown on the display screen. See Figure 58.
5. Press the **EXIT** soft key. To return to the Standard Display. The Main Menu choices are shown on the next page. For detailed information on each menu area, see the individual explanations of each menu item on the following pages of this manual.



1.	Menu Soft Key	4.	Select Soft Key
2.	Next Soft Key	5.	Exit Soft Key
3.	Back Soft Key		

Figure 58: Accessing Main Menu

Operating Instructions

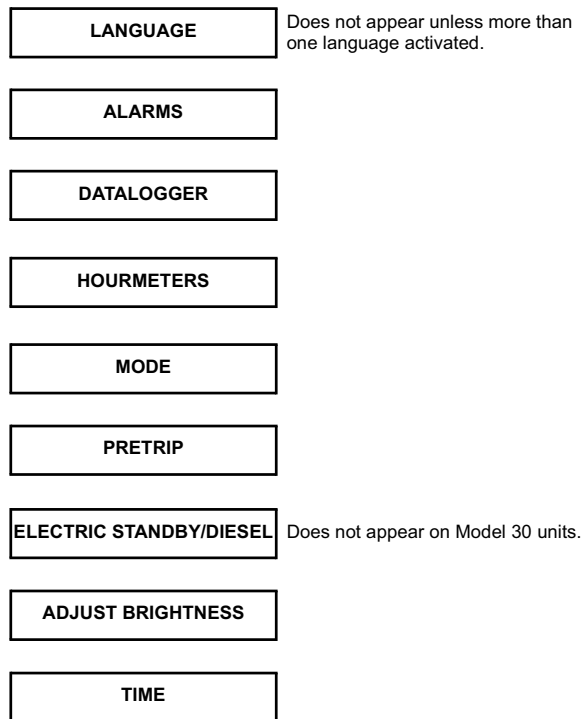

Figure 59: Main Menu Choices

Main Menu Choices

1. Language Menu: This menu only appears if the Base Controller is programmed to activate more than one language. It allows the operator to select which language is used. All other subsequent displays are shown in the selected language. English is the default language. See page 94.

2. Alarms Menu: Shows any active alarms and allows alarms to be cleared. See page 97.

3. Datalogger Menu: Allows the operator to view the datalogger displays. See page 101.

4. Hourmeters Menu: If enabled, allows the operator to view the hourmeter displays. See page 107.

5. Mode Menu: Allows the operator to change unit operating modes between CYCLE-SENTRY mode and Continuous Run mode, select Keypad Lockout, and start Sleep mode. See page 110.

6. Pretrip: Allows the operator to run a Pretrip. See page 120.

Operating Instructions

7. Electric Standby/Diesel Mode (Model 50 Only): This menu only appears on Model 50 units. It allows the operator to manually select Electric Standby or Diesel operation. See page 126.

8. Adjust Brightness: Allows the operator to adjust the display intensity as required by conditions. See page 128.

9. Time: Allows the operator to view the Time and Date. The Time is displayed in 24 hour military time. See page 131.

Language Menu

If the Language feature is enabled, an alternate language can be selected from the Language Menu. After a new language is chosen all displays will appear in that language. If the language feature is not enabled this menu does not appear. The default language is English. Only languages that have been enabled in Guarded Access will appear.

IMPORTANT: Exercise care when changing languages, as once changed all HMI Control panel displays will be in the new language. If the user is not familiar with the new language, problems may be experienced returning to the default language.

The languages available are dependent on the HMI control panel software revision.

- Software Revision 65xx supports English, Spanish, French, German, Italian, Dutch, Portuguese, Greek, Turkish, Hebrew and Arabic.
- Software Revision 66xx supports English, Danish, Russian, Norwegian, Swedish, Finnish, Polish, Hungarian, Romanian, Bulgarian and Czech.

- Software Revision 67xx supports English, Japanese and Chinese.
- Software Revision 68xx supports English, English and Spanish or allows any 5 languages from Software Revision 65xx and Software Revision 66xx to be selected. Note that Japanese and Chinese are not available for use with this feature.

Other than the languages supported, software revisions 65xx, 66xx, 67xx and 68xx are identical.

To select an alternate language:

1. Begin at the Standard Display.

NOTE: If the Temperature Watch Display is showing, press the MENU soft key once to return to the Standard Display.

2. Press the **MENU** soft key on the Standard Display. See Figure 60.

Operating Instructions

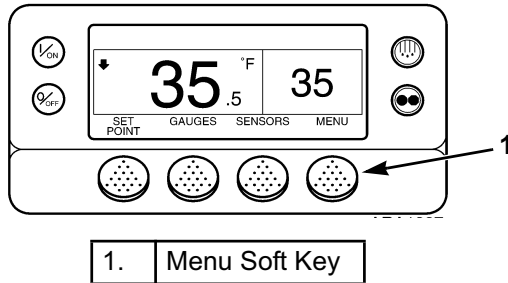

Figure 60: Standard Display

- -
 3. If more than one language is enabled, the Language Menu is the first Main Menu item to appear. Press the **SELECT** soft key to choose the Language Menu Screen. See the Language Menu Screen in Figure 61.
 4. The “NEW LANGUAGE WILL BE” Screen will appear. See Figure 61.
 5. Press the **+** or **-** soft keys to select the desired language. Only languages enabled from the Guarded Access Menu are available. German is shown in Figure 61.
 6. When the desired language is shown, press the **YES** soft key to confirm the choice.
 7. The “PROGRAMMING LANGUAGE PLEASE WAIT” Screen briefly appears. See Figure 61.
 8. The “LANGUAGE SELECTED IS XXX” Screen briefly appears.
 9. The display returns to Language Menu Screen, but will show the new language. German is shown in Figure 61.
 10. The Standard Display will appear in the new language. German is shown in Figure 61.
- NOTE: Exercise care when changing languages, as once changed all HMI Control panel displays will be in the new language. If the user is not familiar with the new language, problems may be experienced returning to the default language.***
- -
 -
 -
 -
 -
 -
 -
 -
 -
 11. Repeat the process to select a different language. Press the **NEXT** soft key to select a different Main Menu item. Press the **EXIT** soft key to return to the Standard Display.

Operating Instructions

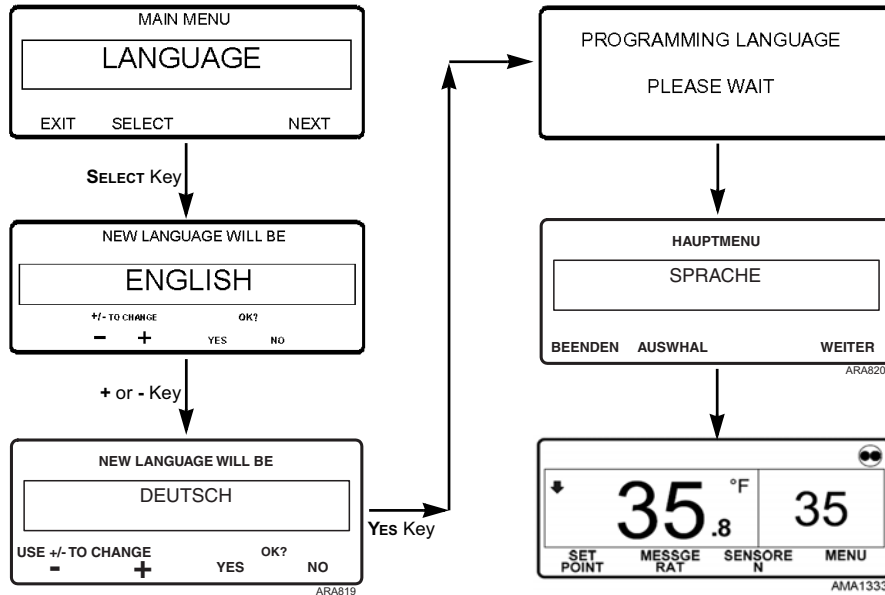
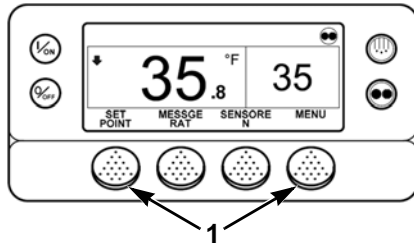

Figure 61: Change Language Screen Sequence

Return to English at Any Time

IMPORTANT: *If necessary, English and all other languages in the software version may be accessed from the Standard Display.*

When the Standard Display is shown press and hold the first and last soft key for 5 seconds as shown in Figure 62. This example is Deutsch (German).



1.	Press These Soft Keys
----	-----------------------

Figure 62: Standard Display

After 5 seconds the Language Menu will appear in the current language as shown in Figure 63. Press the + or - Keys to select the desired language. When the desired language is shown press the YES Key to confirm the choice.

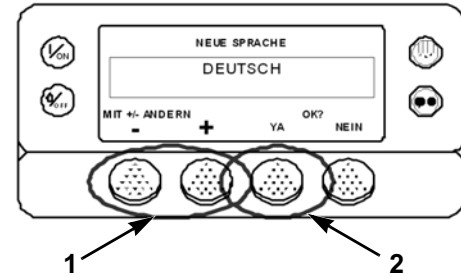

1.	+ or - Keys	2.	YES Key
----	-------------	----	---------

Figure 63: + or - Keys, YES Key

NOTE: *All languages in the installed software can be selected using this method.*

Alarms Menu

If an alarm condition occurs the large Alarm Icon will appear on the Standard Display. See “Alarm Display” on page 65.

Alarms are viewed and cleared using the Alarm Menu as follows:

1. Begin at the Standard Display.
If the Temperature Watch Display is showing, press the **MENU** soft key once to return to the Standard Display.
2. Press the **MENU** soft key on the Standard Display.

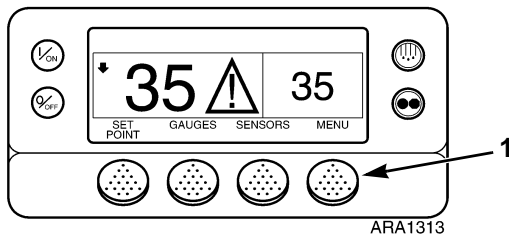

1.	Menu Soft Key
----	---------------

Figure 64: Standard Display

3. The Language Menu or Alarm Menu will appear. If the Language Menu appears, press the **NEXT** soft key until the Alarm Menu appears.
4. Press the **SELECT** soft key. The Alarm Display will appear. See Figure 65.
5. If no alarms are present, the “No Alarm” Screen is shown. Press the **EXIT** soft key to return to the Standard Display.
6. If alarms are present, the quantity of alarms (if more than one), the alarm code number and alarm description will be shown on the display. In the following example (see Figure 65), there are two alarms present. The most recent is Alarm Code 6. This alarm code indicates a problem with the coolant temperature sensor.

NOTE: *If a serious alarm occurs, the unit will be shut down to prevent damage to the unit or the load. If this occurs, the display will show that the unit is shut down and display the alarm code that caused the shutdown.*

IMPORTANT: *Always record any Alarm Codes that occur - in the order that they occur - as well as any other pertinent information. This information is extremely valuable to service personnel.*

Operating Instructions

7. After the alarm situation is resolved press the **CLEAR** key to clear the alarm. To display the next alarm, press the **NEXT** key (see Figure 65).

NOTE: For additional information regarding the alarm shown on the display press the **HELP** soft key. A help message will appear.

Important Alarm Notes

- If an alarm will not clear, it may still exist. If the alarm is not corrected, it will not clear.
- If an alarm cannot be cleared from the Main menu, the **CLEAR** key will not appear. These alarms must be cleared from the Guarded Access Menus.
- All alarms must be viewed before any of the alarms can be cleared.

- If optional Fuel Level Sensor is installed, Check Alarm Code 96 (Low Fuel Level) is set when the fuel level falls to 15%. The Base Controller can be programmed to set a shutdown Alarm Code 44 (Check Fuel System) when the fuel level falls to 5%. Shutdown Alarm Code 44 can be manually cleared with the **CLEAR** key. In that case it becomes a check alarm and the unit will continue to run until it runs out of fuel (if it is not refilled). Alarm Code 96 and Alarm Code 44 are both automatically reset when the fuel tank is refilled above 25%.

NOTE: Shutdown Alarm Code 44 reappears when it is manually cleared from the Alarms Menu. However, it changes to a check alarm so the unit will now start after you exit the Alarms Menu.

Contact your supervisor or a Thermo King dealer for information about alarm codes that will not clear.

Operating Instructions

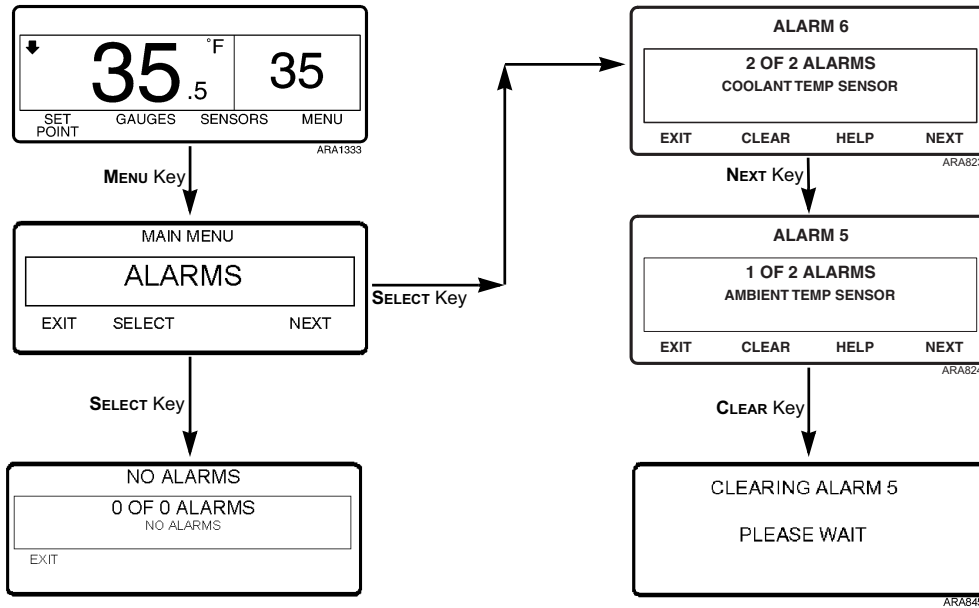

Figure 65: Viewing and Clearing Alarms Screen Sequence

Datalogger Menu

Initiating a Start of Trip

A “Start Of Trip” places a marker in the datalogger memory. It is typically initiated when the cargo is being loaded. The Start Of Trip marker then shows when the trip started in the data that is downloaded or printed from the datalogger. A Start Of Trip can be initiated through the use of WinTrac datalogging software, or manually in the field. The following procedure covers manual initiation. For more information on datalogging, see the WinTrac User Manual included with the WinTrac software.

1. Begin at the Standard Display.
If the Temperature Watch Display is showing, press the **MENU** soft key once to return to the Standard Display. See Figure 66.
2. Press the **MENU** soft key on the Standard Display.
3. Press the **NEXT** soft key until the Datalogger Menu appears. See Figure 67.
4. Press the **SELECT** soft key on the Datalogger Menu. The “Start Trip” Screen will appear.

5. Press the **SELECT** soft key. The “Start Of Trip” Screen will appear.
6. Press the **SELECT** soft key to initiate a start of trip.
7. A Start Of Trip Marker has been inserted into the datalogger memory.

NOTE: *The start of trip marker is sent to both the CargoWatch and ServiceWatch data loggers.*

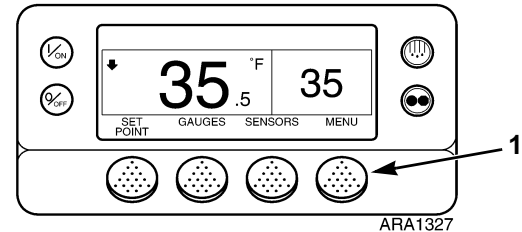

1. Menu Soft Key

Figure 66: Standard Display

Operating Instructions

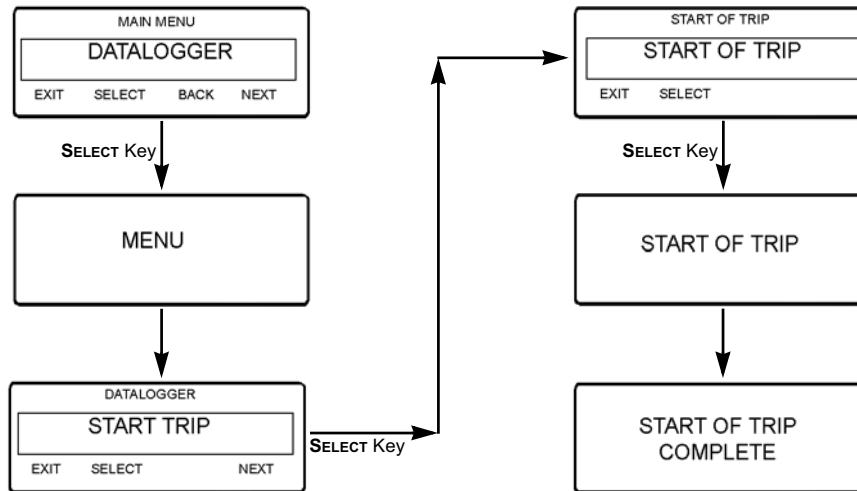

Figure 67: Start of Trip Screen Sequence

Printing a Trip Report

This procedure prints the current CargoWatch datalogger record directly to a handheld printer. The printed record shows things such as the unit and Base Controller identification numbers, dates and times, the setpoint, and the data from the optional sensors connected to the CargoWatch datalogger. If no sensors are connected, the printed record shows the same things without the sensor data.

1. Connect the printer to the 6-pin printer port located inside the control box.

NOTE: *Contact your Thermo King dealer about printer port location options.*

2. Begin at the Standard Display.
If the Temperature Watch Display is showing, press the **MENU** soft key once to return to the Standard Display. See Figure 69.
3. Press the **MENU** soft key on the Standard Display.



1.	CargoWatch Port
2.	Printer Port

Figure 68: Printer Port Location

Operating Instructions

4. Press the **NEXT** soft key until the Datalogger Menu appears. See Figure 70.
5. Press the **SELECT** soft key on the Datalogger Menu. The “Start Trip” Screen will appear.
6. Press the **NEXT** soft key. The “Print/View” Screen will appear.
7. Press the **SELECT** soft key. The “Delivery Ticket” Screen will appear. Press the **SELECT** soft key to print a Delivery Ticket. The Delivery Ticket is a short ticket that shows delivery specific details including the current temperature. See Figure 71.
8. Press the **NEXT** soft key to go to the “Trip Ticket” Screen. Press the **SELECT** soft key to print a Trip Ticket. The Trip Ticket is a long ticket that shows details for the current trip including a temperature history. The Trip Ticket is also called a Journey Ticket. See Figure 72.
9. Pressing the EXIT key returns the display to the Main Menu.

For additional information concerning the CargoWatch Data Logger contact your Thermo King dealer.

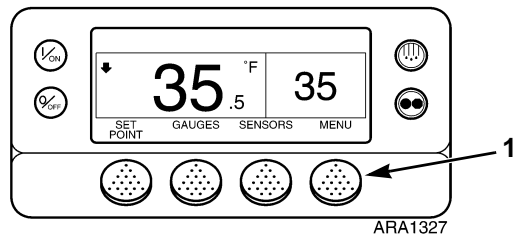

1.	Menu Soft Key
----	---------------

Figure 69: Standard Display

Operating Instructions

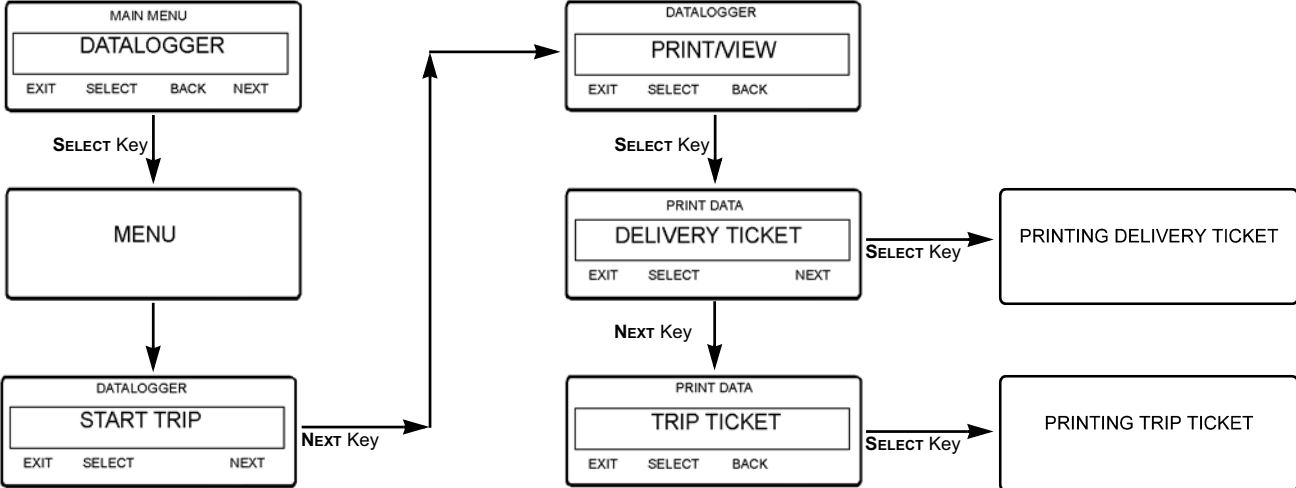

Figure 70: Print Report Screen Sequence

Operating Instructions

```
UNIT SERIAL NUMBER:          xxxxxxxxx
CONTROLLER SERIAL NUMBER:    A00021506190T3
TRAILER ID:                  xxxxxxxxx
CONTROLLER VERSION NUMBER:   B007
CONTROLLER TYPE:             SR2
DATALOGGER VERSION NUMBER:   6512
TEMPERATURE UNITS:          FAHRENHEIT
START:                       05/30/08 08:29:08
FINISH:                       05/30/08 09:18:33
SENSORS:                      2
SETPOINT:                     32.0

Sensor    Min    Ave    Max    Last
#1:       35    35    35    35
#2:       ---    ---    ---    ---

SENSOR #1:                      LOG SENSOR 1
SENSOR #2:                      LOG SENSOR 2
```

Figure 71: Sample Delivery Ticket

```
UNIT SERIAL NUMBER:          xxxxxxxxx
CONTROLLER SERIAL NUMBER:    A00021506190T3
TRAILER ID:                  xxxxxxxxx
CONTROLLER VERSION NUMBER:   B007
CONTROLLER TYPE:             SR2
DATALOGGER VERSION NUMBER:   6512
TEMPERATURE UNITS:          FAHRENHEIT
START:                       05/30/08 09:50:08
FINISH:                       05/30/08 13:07:33
SENSORS:                      1
SETPOINT:                     32.0

30 - MAY - 2008
1305    35.0
1250    35.2
1235    35.1
1220    35.2
1205    35.1
30 - MAY - 2008
1150    35.0
1135    35.0
1120    35.0
1105    34.9
1050    35.0
1035    35.0
1020    35.0
1005    35.1
0950    35.1

SENSOR #1:                      LOG SENSOR 1
SENSOR #2:                      LOG SENSOR 2
```

Figure 72: Sample Trip Ticket

Operating Instructions

Hourmeters Menu

The Hourmeters are programmable to be visible or hidden in the Base Controller. Hourmeters that are visible are displayed. Hourmeters that are hidden are not displayed, but they do count hours. The default setting for Model 30 units is to display only the Engine Hours. The default setting for Model 50 units is to display Total Run Time Hours, Engine Hours, and Electric Run Hours. The Hourmeters Menu will not appear if all hourmeters are hidden. Contact your Thermo King dealer for information about programming the Base Controller.

Hourmeters can be viewed in the Hourmeters Menu as follows:

1. Begin at the Standard Display.
If the Temperature Watch Display is showing, press the **MENU** soft key once to return to the Standard Display.
2. Press the **MENU** soft key on the Standard Display.
3. Press the **NEXT** soft key until the Hourmeters Menu appears. See Figure 74.
4. Press the **SELECT** soft key to enter the Hourmeters Menu.

5. Press the **NEXT** and **BACK** soft keys to view the hourmeter displays. Press the Exit soft key to return to the Standard Display.

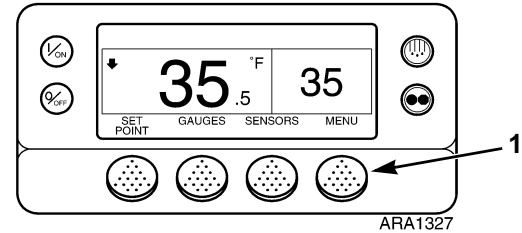

1.	Menu Soft Key
----	---------------

Figure 73: Standard Display

Operating Instructions

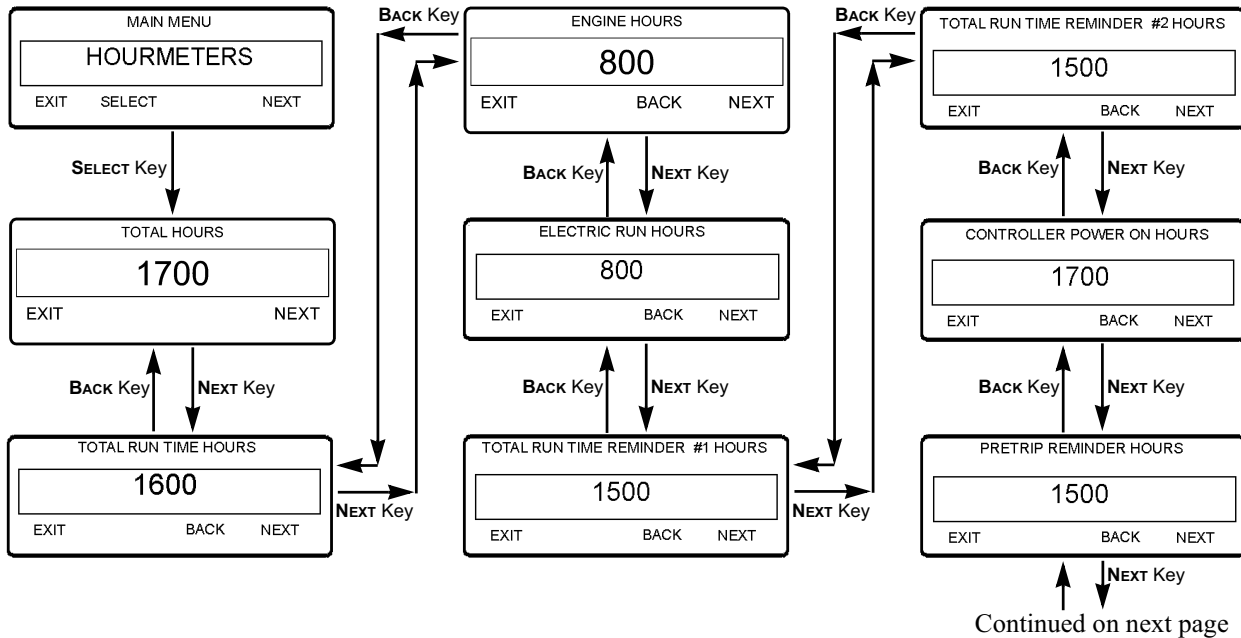

Figure 74: Viewing Hourmeters Screen Sequence (continued on next page)

Operating Instructions

Continued from previous page

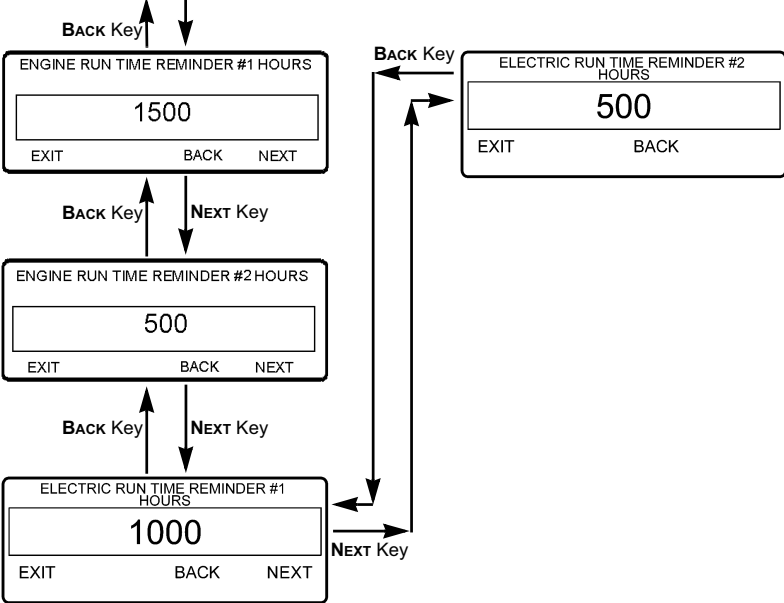

Figure 75: Viewing Hourmeters Screen Sequence (continued from previous page)

Mode Menu

Various operating modes can be selected using the Mode menu. Not all modes may be available, depending on OptiSet Plus usage and settings of other programmable features. The following modes may be available.

Turn Cycle Sentry On or Off

The CYCLE-SENTRY Mode can be turned On or Off. If CYCLE-SENTRY is turned off the unit runs in Continuous mode. See “Turning CYCLE-SENTRY On or Off” on page 112.

NOTE: OptiSet Plus may prevent selecting CYCLE-SENTRY or Continuous. If this happens, the display will advise that the selection is not available.

Select Temperature Units

If this feature is enabled in Guarded Access / Main Menu Configuration, the operator can select temperature units to be displayed as either degrees Fahrenheit or degrees Celsius.

Keypad Lockout

If enabled in Guarded Access, the keypad can be locked to prevent unauthorized use. If the keypad is locked only the On and Off keys function. The keypad will remain locked even if the unit is turned off and back on. If Keypad Lockout is active, press and hold any soft key for 5 seconds to deactivate the feature. See “Selecting Keypad Lockout” on page 114.

Start Sleep Mode

If this feature is enabled in Guarded Access / Main Menu Configuration, the operator can select and set Sleep Mode from the Mode Menu. Sleep Mode is used to keep the engine warm and the battery charged when the unit is not in use. When the unit is in Sleep Mode the display will show “SLEEP” and the current time. See “Selecting Sleep Mode” on page 116.

- Program Wakeup Time: This feature allows a wakeup time to be specified. When the selected time is reached the unit will start and resume normal operation.

If Wakeup Time is selected:

- Day to Wake Up: The day the unit is to wake up can be specified.

Operating Instructions

- Hour to Wake Up: The hour the unit is to wake up can be specified.
- Minute to Wake Up: The minute the unit is to wake up can be specified.
- Run Pretrip on Wake Up: A Pretrip Test can be enabled to automatically run when the unit wakes up.

Turning CYCLE-SENTRY On or Off

The easiest way to switch between CYCLE-SENTRY and Continuous Run is to press the Mode key (see page 78). But you can also switch modes in the Mode Menu as follows:

1. Begin at the Standard Display.
If the Temperature Watch Display is showing, press the **MENU** soft key once to return to the Standard Display.
2. Press the **MENU** soft key on the Standard Display.
3. Press the **NEXT** soft key until the Mode Menu appears.
4. Press **SELECT** soft key to enter the Mode Menu. See Figure 77.
5. Press the **SELECT** soft key, to switch between modes.
6. The new mode is then confirmed for 10 seconds.
7. The display then returns to the Mode Menu. Press the **SELECT** soft key again to change the mode again.



CAUTION: *If the unit is in CYCLE-SENTRY null and the mode is switched to Continuous mode, the unit will start automatically.*

IMPORTANT: *If OptiSet Plus is in use, it may not be possible to change the Mode.*

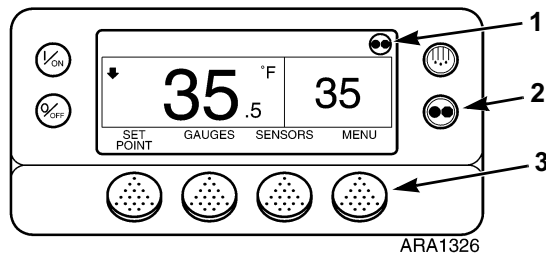

1.	CYCLE-SENTRY Icon Shows Current Mode Displayed for CYCLE-SENTRY Mode Not Displayed for Continuous Mode
2.	Mode Key
3.	Menu Soft Key

Figure 76: Standard Display

Operating Instructions

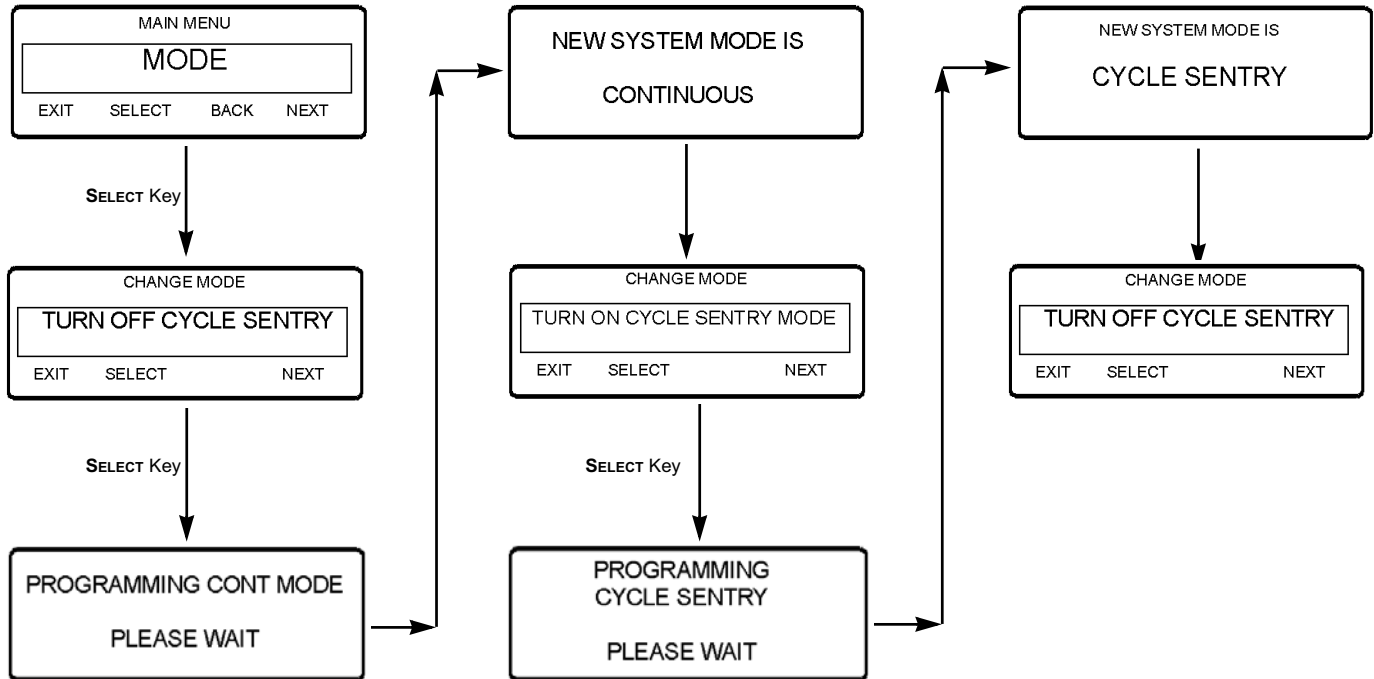
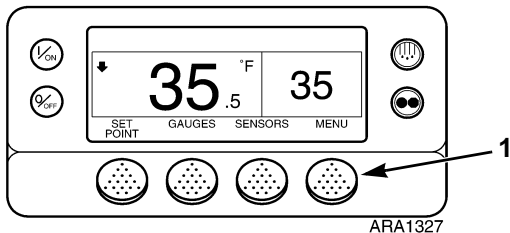

Figure 77: Selecting Mode Screen Sequence

Selecting Keypad Lockout

This feature must be enabled in Guarded Access to be available. See “Keypad Lockout” on page 110 for more information about Keypad Lockout. Use the following steps to select Keypad Lockout:

1. Begin at the Standard Display.
If the Temperature Watch Display is showing, press any soft key to return to the Standard Display.
2. Press the **MENU** soft key on the Standard Display.



1. Press Menu Soft Key

Figure 78: Standard Display

3. Press the **NEXT** soft key until the Mode Menu appears.
4. Press the **SELECT** soft key to enter the Mode Menu. The Turn CYCLE-SENTRY On/Off Screen will appear.

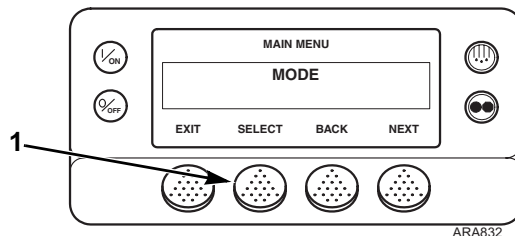

1. Press Select Soft Key

Figure 79: Mode Menu Display

5. Press the **NEXT** soft key until the Keypad Lockout Display appears.

Operating Instructions

6. Press the **SELECT** soft key to select Keypad Lockout.

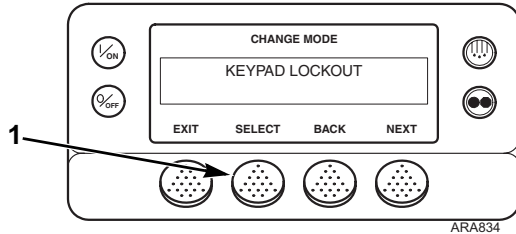

1.	Press Select Soft Key
----	-----------------------

Figure 80: Keypad Lockout Display

7. The new mode is then confirmed for 10 seconds.
8. The display then returns to the Mode Menu.
9. Press the Exit soft key to return to the Standard Display. If no keys are pressed within 30 seconds, the screen will return to the Standard Display.

NOTE: *If Keypad Lockout is active, press and hold any soft key for 5 seconds to deactivate the feature.*

Selecting Sleep Mode

This feature must be enabled in Guarded Access to be available. Sleep mode starts and stops the unit as required to keep the unit battery in a charged condition and keep the unit engine warm in cold ambient conditions. Sleep mode does not maintain setpoint. Sleep Mode keeps the compartment temperature near the ambient temperature when the unit is running. This is useful in extremely cold weather or when the unit is to be out of service for an extended time.

The following features are available in Sleep Mode.

Program Wakeup Time: This feature allows a wakeup time to be specified. When the selected time is reached the unit will start and resume normal operation.

If a Wakeup Time is selected the following features are available:

Day to Wake Up: The day the unit is to wake up can be specified.

Hour to Wake Up: The hour the unit is to wake up can be specified.

Minute to Wake Up: The minute the unit is to wake up can be specified.

Run Pretrip on Wakeup: A Pretrip Test can be enabled to automatically run when the unit wakes up.

Sleep mode operates in both Diesel mode and Electric mode. In Diesel mode the unit will start and stop as required to maintain engine temperature and battery charge. In Electric mode the unit starts and stops as necessary to maintain battery charge only.

When Sleep mode is entered, the operator can program an automatic Wake-up Time up to a week away. Using this feature, the unit will automatically restart and run normally at the determined time. If a Wake-up Time is programmed, the operator can also program an automatic Pretrip Test when the unit restarts.

Select Sleep Mode as follows:

1. Begin at the Standard Display.
If the Temperature Watch Display is showing, press the **MENU** soft key once to return to the Standard Display.
2. Press the **MENU** soft key on the Standard Display.

Operating Instructions

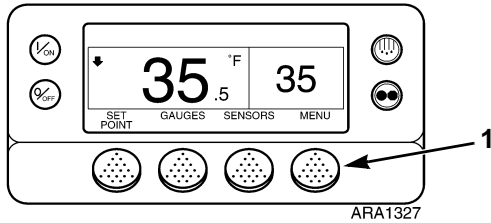

1.	Menu Soft Key
----	---------------

Figure 81: Standard Display

- Press the **NEXT** soft key until the Mode Menu appears. See Figure 82.
- Press **SELECT** soft key to enter the Mode Menu.
- Press the **NEXT** soft key as required to display the Sleep Mode Screen.
- Press the **SELECT** soft key to start the Sleep mode.
- You now choose to program a Sleep mode Wake-up Time or simply enter Sleep mode immediately. Press the **No** soft key to immediately enter Sleep mode.
 - The display will show “SLEEP” and the unit will start and stop as required to keep engine warm and/or the battery charged. Sleep mode does not maintain the compartment temperature.
 - Press the **EXIT** soft key to exit Sleep mode or turn the unit off and back on. The unit will resume normal operation and control to setpoint.
- To enter a Wake-up Time verify that the unit clock is set properly (see “Time Display” on page 131). Then press the **YES** soft key at the “Program A Wake-Up Time?” Screen.
- Press the **+** or **-** soft keys to select the day the unit is to restart in normal operation. In this example Monday has been chosen. Press the **YES** soft key to confirm the day.
- The display will now prompt you for the hour the unit is to restart in normal operation. In this example 18:00 hours has been chosen. Note that 24 hour “military time” is used. Press the **YES** soft key to confirm the hour.
- The display will now prompt you for the minute the unit is to restart in normal operation. In this example 18:37 hours has been chosen. Press the **YES** soft key to confirm the minute.

Operating Instructions

12. The display will now prompt you to “Run A Pretrip On Wake-Up?” Press **YES** soft key or the **NO** soft key accordingly and the display will show the unit is programming the Sleep mode.
13. The display will show “SLEEP” and the unit will start and stop as required to keep the engine warm and/or the battery charged. Sleep mode does not maintain setpoint.
14. The unit will restart at the programmed time (in this example 18:37 hours) and perform a Pretrip (if selected). After the Pretrip is complete the test results will be displayed and the unit will resume normal operation and control to setpoint.
15. To exit Sleep mode before the selected Wake-up time press the **EXIT** soft key or turn the unit off and back on. The unit will resume normal operation and control to setpoint.

Operating Instructions

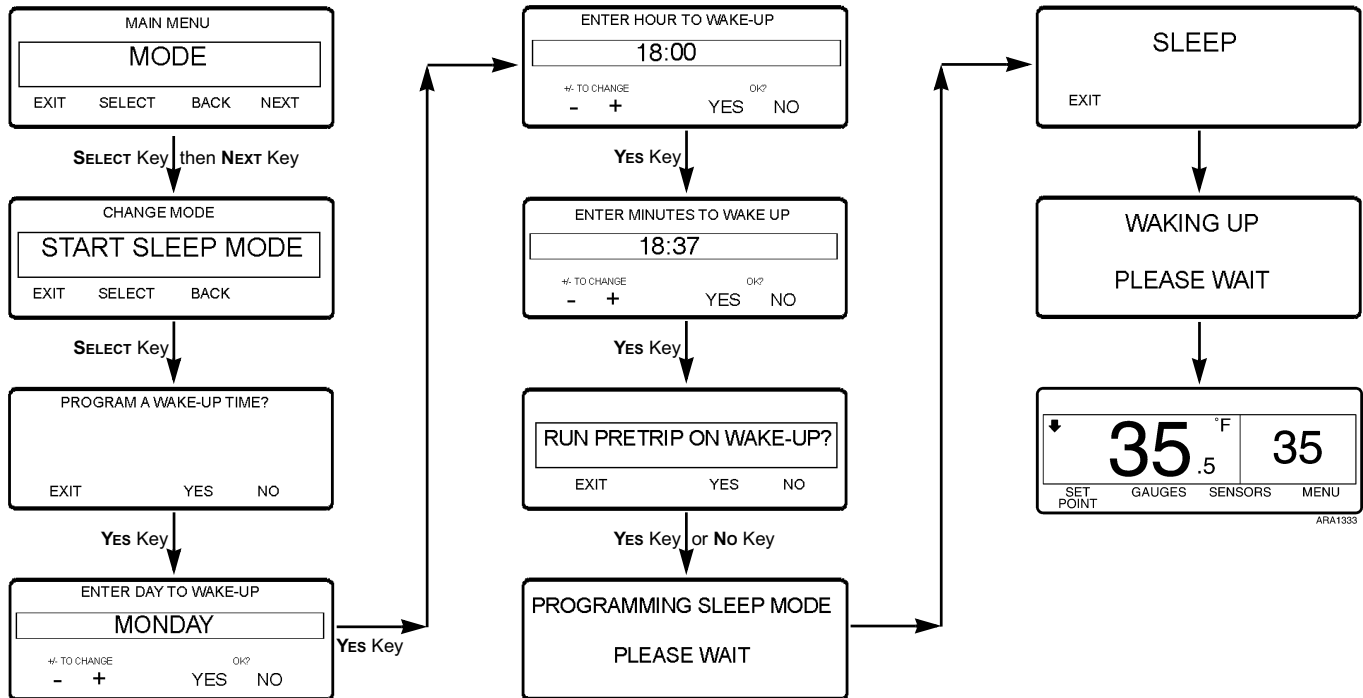

Figure 82: Selecting Sleep Mode Screen Sequence

Pretrip Tests

A Pretrip test verifies unit operation. This display allows a Pretrip Test to be selected and initiated by the operator. If the Pretrip Test is entered with the unit shut down a Full Pretrip Test with device amp checks will be performed. If the Pretrip Test is entered with the unit running in either diesel or electric mode a Running Pretrip Test is performed. Test results are reported as PASS, CHECK or FAIL when the Pretrip Test is completed.

Pretrip Test Conditions

- Current unit settings are saved and restored at the end of the Pretrip Test or if the unit is turned off and back on.
- Pretrip Test can be run in either Diesel or Electric Mode.
- The unit will auto switch from Diesel Mode to Electric Mode or from Electric Mode to Diesel Mode during a Pretrip Test if these features are enabled and the auto switch conditions occur.
- Engine or Electric Motor Start – The engine or electric

Conditions where Pretrip Tests are not allowed

- If any shutdown alarms are present. Pretrip tests are allowed with some Check and Log alarms.
- If the unit is in Sleep Mode.
- If the unit is in Service Test Mode, Interface Board Test Mode or Evacuation Mode.



CAUTION: Monitor the return air temperature when performing a Pretrip Test on a loaded trailer. The controller may not maintain setpoint during the Pretrip Test.

Full Pretrip

A Full Pretrip occurs when Pretrip is initiated before the engine or electric motor starts running. The Full Pretrip test proceeds in the order shown below:

- Amp Checks – Each electrical control component is energized and the current drawn is confirmed to be within specification.
motor will start automatically.

Operating Instructions

- Defrost – If the coil temperature is below 45 F (7 C), a Defrost cycle is initiated.
- Cool Check – The ability of the unit to cool in low speed is checked.
- RPM Check (Diesel Mode only) – If the unit is running in the Diesel Mode, the engine RPM in high and low speed is checked during the Cool Check.
- Heat Check - The ability of the unit to heat in low speed is checked.
- Report Test Results – The test results are reported as “PASS”, “CHECK” or “FAILED” when the Pretrip is completed. If test results are Check or Failed, alarm codes will exist to direct the technician to the source of the problem.

Running Pretrip

A Running Pretrip occurs when Pretrip is initiated after the engine or electric motor is running. The Running Pretrip test proceeds in the order shown below:

- Defrost – If the coil temperature is below 45 F (7 C), a Defrost cycle is initiated.
- Cool Check – The ability of the unit to cool in low speed is checked.
- RPM Check (Diesel Mode only) – If the unit is running in the Diesel Mode, the engine RPM in high and low speed is checked during the Cool Check.
- Heat Check - The ability of the unit to heat in low speed is checked.
- Report Test Results – The test results are reported as “PASS”, “CHECK” or “FAILED” when the Pretrip is completed. If test results are Check or Failed, alarm codes will exist to direct the technician to the source of the problem.

Operating Instructions

Pretrip Test Issues

When performing a Pretrip Test, the following issues should be considered.

- Whenever possible, run pretrip tests on empty, dry trailers with the doors closed.
- If running a Pretrip Test on a trailer loaded with dry cargo, insure that proper airflow can occur around the load. If the load restricts airflow, false test results may occur. Also, SR-3 units have high refrigeration capacity which results in rapid temperature changes. Sensitive dry cargo may be damaged as a result.
- If running a Pretrip Test on a trailer that has just been washed down, the extremely high humidity inside the trailer may result in false test results.
- If running a Pretrip Test on a trailer loaded with sensitive cargo, monitor the load temperature during the test as normal temperature control is suspended during pre-trip operation.
- Always perform Pretrip Tests with the trailer cargo doors closed to prevent false test failures.

Operating Instructions

Initiating a Pretrip Test

Before initiating a Pretrip Test, clear all alarm codes.

To stop a Pretrip Test at any time, turn the unit off.

Use the following procedure to initiate a Full Pretrip or a Running Pretrip. A Running Pretrip can also be initiated by starting at step 3 with the unit running.

1. If the unit is running, press the **OFF** key to stop the unit.
2. Press the **ON** key to turn the unit on.

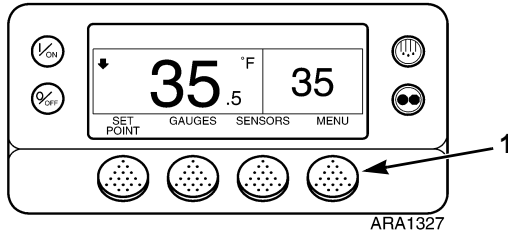

1.	Menu Soft Key
----	---------------

Figure 83: Standard Display

3. To initiate a Full Pretrip press the **MENU** soft key as soon as the Standard Display appears and before the unit starts. To initiate a Running Pretrip let the unit start before pressing the **MENU** soft key on the Standard Display.
4. Press the **NEXT** soft key until the Pretrip Screen appears. See Figure 85.
5. Press the **SELECT** soft key to start a Pretrip.

NOTE: *If all alarms were not cleared, a prompt appears as shown below. Press the **EXIT** key to exit the Pretrip Test, clear all alarms and repeat the Pretrip Test.*

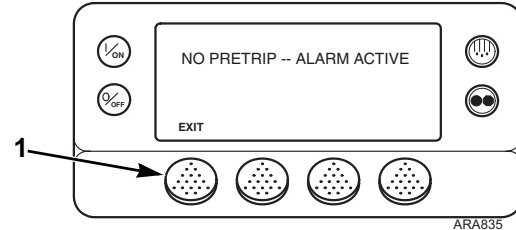

1.	Press Exit Soft Key
----	---------------------

Figure 84: No Pretrip Alarm Active Display

Operating Instructions

6. The Pretrip display appears. See Figure 85.
 - The top line of the display indicates the unit is performing the non-running (or running) portion of the Pretrip Test.
 - The second line shows Test 1 of 49 is being performed. Note that the tests may not be performed in numerical order.
 - The soft keys may be used during the Pretrip Test to select the Hourmeter, Gauge or Sensor menus.

In a Full Pretrip, when the non-running tests are complete the unit will start automatically and continue with the running tests.

7. When all tests are complete, the results are reported as “PASS”, “CHECK” or “FAILED”. If “FAILED” appears, the unit will shut down. If the results are Check or Failed, the accompanying alarm codes will direct the technician to the cause of the problem.

8. If the Pretrip Test results are “CHECK” or “FAILED”, the problem should be diagnosed and corrected and the Pretrip Test repeated and passed before the unit is released for service. The Pretrip Test result screen will exit to the Main Menu Alarm Submenu for convenient access to any alarms generated during the Pretrip Test.

Stopping a Pretrip Test

Turn the unit off to stop a Pretrip Test at any time. This will generate Alarm Code 28–Pretrip Abort. Other alarm codes may also be generated. This is normal when the Pretrip test is stopped before completion.

Operating Instructions

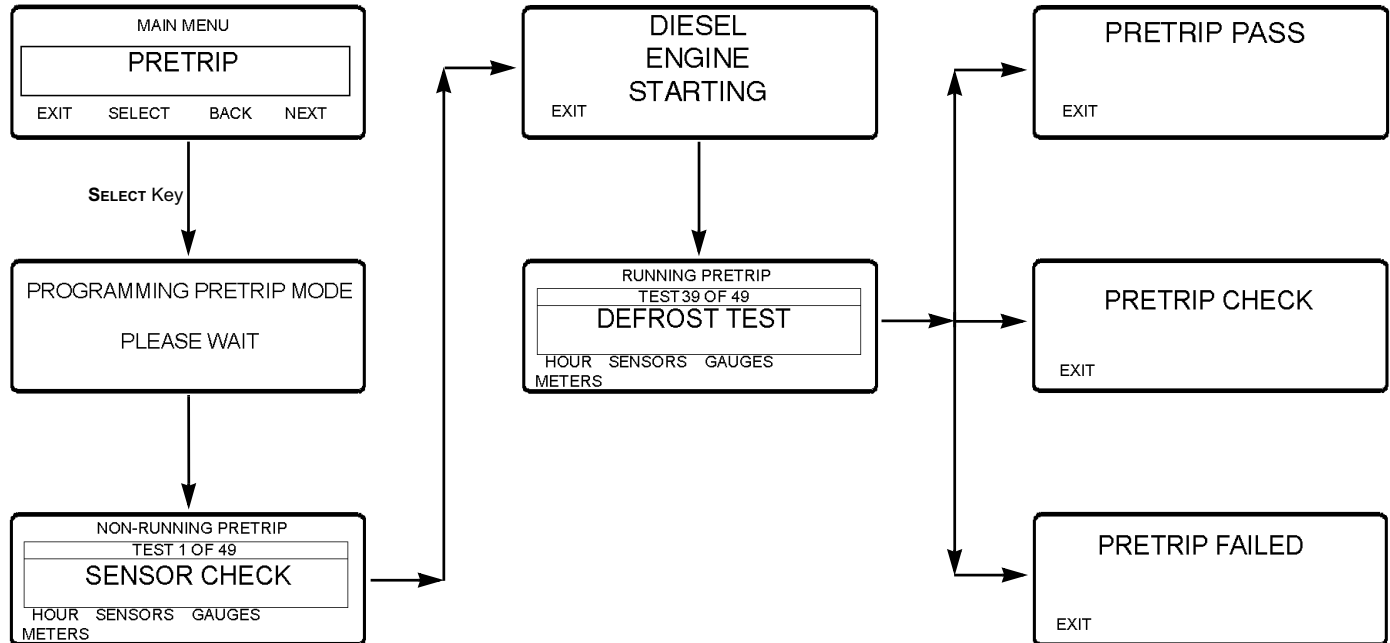

Figure 85: Pretrip Test Screen Sequence

Electric Standby/Diesel Mode

The Electric Standby/Diesel Mode display allows the operator to manually select Electric Standby or Diesel Mode operation. The unit can also be programmed to automatically select Electric Standby operation when standby power is available and Diesel Mode operation if standby power fails or is removed. Contact your Thermo King dealer for information about programming the Base Controller.

NOTE: *Manual selection is the default setting for both Electric Standby and Diesel Mode.*

A screen asking if you wish to switch to Electric Standby will appear if the unit is connected to standby power when in the Diesel Mode.

A screen asking if you wish to switch to Diesel Mode will appear if standby power is disconnected when in Electric Standby. Pressing the **YES** soft key will switch unit operation to the Diesel Mode. Pressing the **NO** soft key will force the unit to remain in Electric Standby even though standby power is not available. The unit will not run and Alarm Code 91 Check Electric Ready Input will be set as a prevent alarm.

Select Electric Standby or Diesel Mode as follows:

1. Begin at the Standard Display.
If the Temperature Watch Display is showing, press the **MENU** soft key once to return to the Standard Display.
2. Press the **MENU** soft key on the Standard Display.

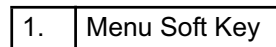
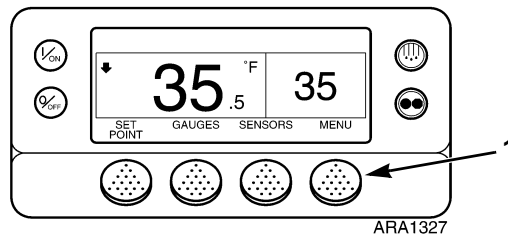

Figure 86: Standard Display

Operating Instructions

3. Press the **NEXT** soft key until the Electric Standby/Diesel Mode Screen appears. See Figure 87 and Figure 88.

NOTE: *The Electric Standby Screen will not appear if diesel to electric switchover is enabled. The Diesel Mode Screen will not appear if electric to diesel switchover is enabled.*

4. Press the **SELECT** soft key to select the mode shown on the display.

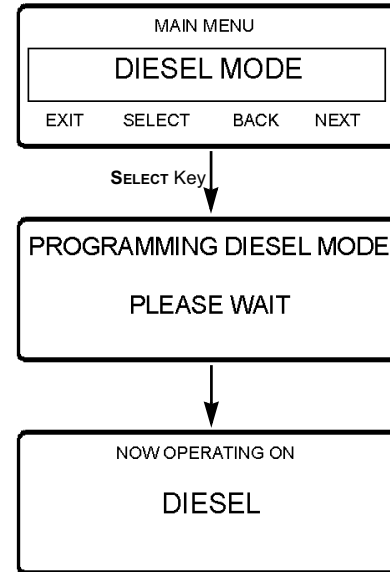

Figure 87: Programming Diesel Mode

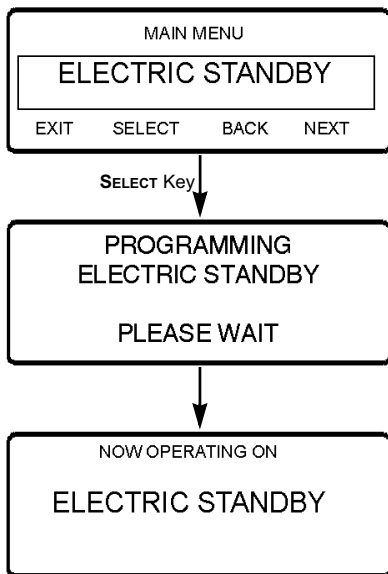

Figure 88: Programming Electric Standby Mode

Adjust Brightness Menu

The brightness of the HMI Control Panel display backlight can be adjusted to allow for changing ambient light conditions. The choices available to the operator are HIGH, MEDIUM, LOW, and OFF. OFF actually results in a very dim backlight suitable for low light conditions.

IMPORTANT: Before replacing an HMI Control Panel with no backlight, check the Adjust Backlight feature to be sure the backlight is turned on.

Adjust the display brightness as follows:

1. Begin at the Standard Display.
If the Temperature Watch Display is showing, press the **MENU** soft key once to return to the Standard Display.

Operating Instructions

2. Press the **MENU** soft key on the Standard Display.

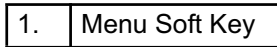
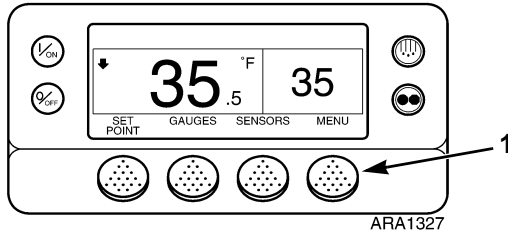

Figure 89: Standard Display

3. Press the **NEXT** soft key until the Adjust Brightness Menu appears. See Figure 90.
4. Press the **SELECT** soft key to enter the Adjust Brightness Menu. See Figure 90.
5. Press the **+** or **-** soft keys to select the desired brightness. See Figure 90. This example shows changing screen brightness from low to medium.
6. Press the **YES** soft key to enter the new brightness level.
7. The “ADJUSTING BRIGHTNESS - PLEASE WAIT” Screen briefly appears.
8. The selected level appears on the screen.
9. The Adjust Brightness Main Menu Screen reappears.
10. Press the Exit soft key to return to the Standard Display. If no keys are pressed within 30 seconds, the screen will return to the Standard Display.

Operating Instructions

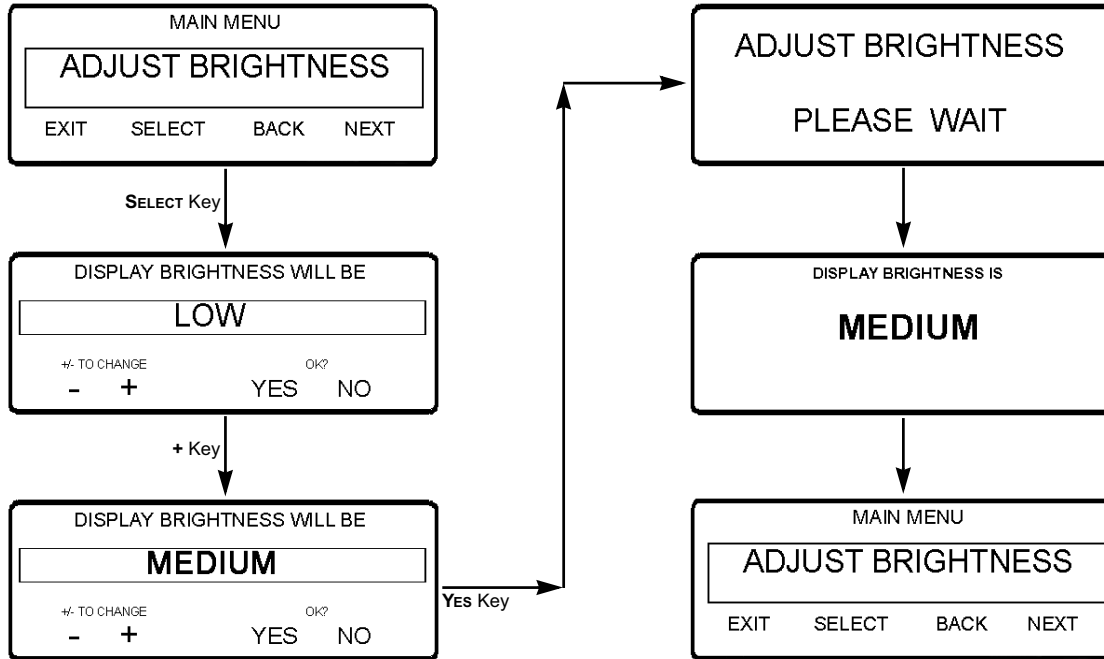

Figure 90: Adjusting Display Brightness Screen Sequence

Time Display

The time and date held by the HMI Control Panel real time clock can be checked. Time and Date cannot be changed from the Main Menu. The time and date are changed by programming the HMI Control Panel. Contact your Thermo King dealer for information about programming the HMI Control Panel.

View the time and date as follows:

1. Begin at the Standard Display.
If the Temperature Watch Display is showing, press the **MENU** soft key once to return to the Standard Display.
2. Press the **MENU** soft key on the Standard Display.
3. Press the **NEXT** soft key until the Time Display appears.
4. Press the **SELECT** soft key to view the time and date.

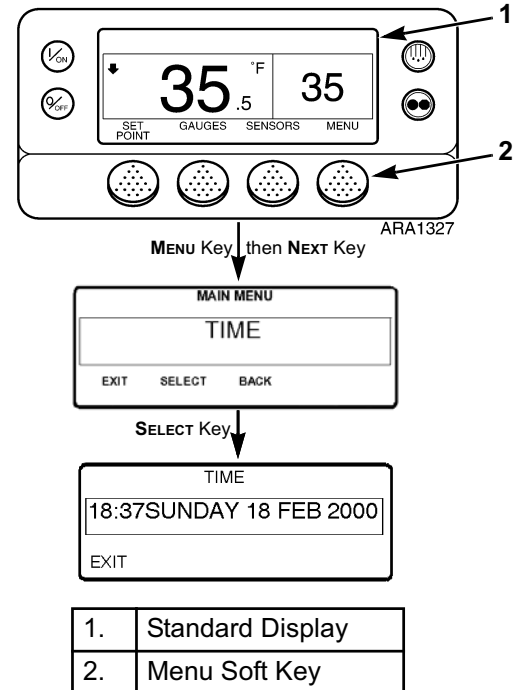

Figure 91: Time and Date Screens

OptiSet Plus

The Base Controller can be programmed with OptiSet Plus temperature profiles that allow the user to select named products. Contact your Thermo King dealer for information about programming the Base Controller with OptiSet Plus temperature profiles.

- Named products can have a single setpoint, or they can have a setpoint range that allows the user to select a setpoint within that range.
- The Base Controller can be programmed to allow only named products to be selected. In which case the far left soft key will display **PRODUCT**. See Figure 92.
- The Base Controller can be programmed to allow named products or numeric setpoints to be selected. In which case the far left soft key will display **PRODUCT/SETPOINT**. See Figure 93.

NOTE: In OptiSet Plus the terms “numeric setpoint” and “setpoint” mean the same thing and are displayed as numbers. The terms “named product” and “product” mean the same thing and are displayed as words.

See “Selecting a Named Product” on page 134 for information about selecting or changing the named product.

See “Changing the Setpoint for a Named Product” on page 139 for information about changing the setpoint for a named product.

See “Selecting a Setpoint” on page 142 for information about selecting or changing the setpoint.

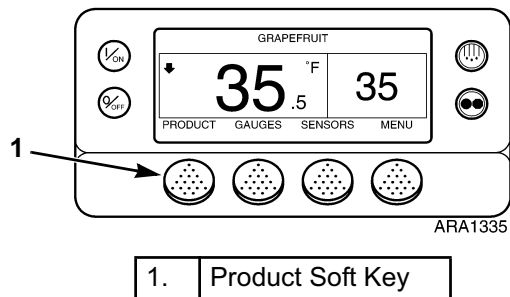
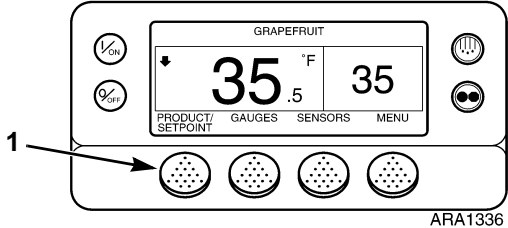

Figure 92: Standard Display with Product Soft Key

Operating Instructions



- | | |
|----|---------------------------|
| 1. | Product/Setpoint Soft Key |
|----|---------------------------|

Figure 93: Standard Display with Product/Setpoint Soft Key

Selecting a Named Product

To select or change a named product complete the following steps. This example shows the Standard Display with the **PRODUCT/SETPOINT** soft key. Using the Standard Display with the **PRODUCT** soft key is basically the same but some of the screens differ slightly.

1. Begin at the Standard Display.
If the Temperature Watch Display is showing, press the **MENU** soft key once to return to the Standard Display.
2. Press the **PRODUCT/SETPOINT** (or **PRODUCT**) soft key on the Standard Display. See Figure 94.
3. The “Named Product / Numeric Setpoint?” (or Named Product) Screen briefly appears, then the “Named Product or Numeric Setpoint?” (or Named Product) Screen will appear. See Figure 95.
4. Press the **NAMED** soft key. See Figure 95.
5. The “Product” Screen briefly appears, then the “Current Product Is” Screen will appear. See Figure 95.
6. Press the **+** or **-** soft keys to change the named product. See Figure 95.

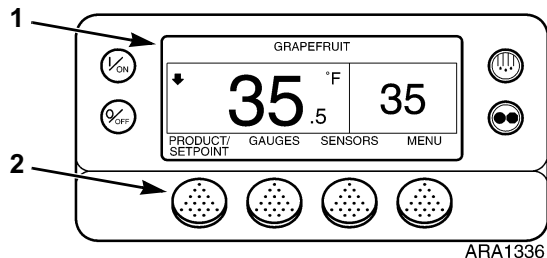

1.	Standard Display
2.	Product/Setpoint Soft Key

Figure 94: Selecting Named Product

7. Press the **YES** or **NO** soft key accordingly as described below. See Figure 95.
 - If the **NO** key is pressed the named product change made with the “+” or “-” soft keys **will not** be accepted, the named product will not be changed and the display will return to the Standard Display.
 - If the **YES** soft key is pressed, the named product change made with the “+” or “-” soft keys will be accepted, and the following screens will appear.

Operating Instructions

NOTE: Alarm Code 127 may be generated if the + or - soft keys are used to change the named product, but the YES or NO soft keys are not used to accept or decline the new named product.

8. The “Programming Named Product” Screen will briefly appear. See Figure 95.

NOTE: If the “Change Setpoint for XXXXX” Screen appears, the named product has been programmed with a setpoint range. See “Selecting the Setpoint for a Named Product” on page 137.

9. The “New Named Product Is XXXXX” Screen briefly appears. See Figure 95.
10. The Standard Display appears with the new named product. See Figure 95.

NOTE: Pressing the EXIT soft key at any point will return to the Standard Display.

NOTE: If no keys are pressed for 30 seconds while in the Named Product Changer Screens, the HMI Control Panel will return to the Standard Display.

Operating Instructions

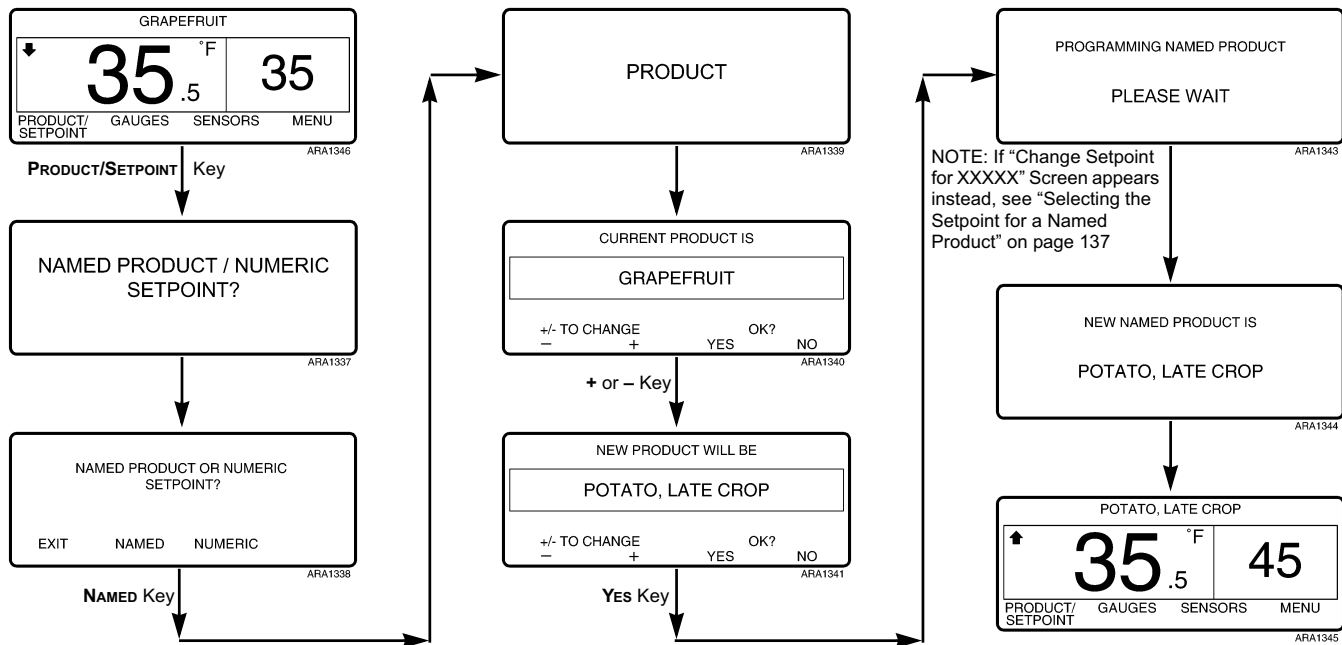

Figure 95: Selecting or Changing Named Product Screen Sequence

Operating Instructions

Selecting the Setpoint for a Named Product

If the “Change Setpoint for XXXXX” Screen appears after pressing the **YES** soft key to select a named product, the named product has been programmed with a setpoint range. Complete the following steps to select a setpoint for the named product.

1. The “Change Setpoint for XXXXX” Screen briefly appears, then the “Current Setpoint of XXXXX & Setpoint Range Is XX to XX” Screen will appear. See Figure 96.
2. Press the **+/-** or **EXIT** soft keys accordingly as described below. See Figure 96.
 - Press the **+** or **-** soft keys to change the current setpoint for the named product and then go to step 3.
 - Press the **EXIT** soft key to accept the current setpoint for the named product. The Standard Display will appear with the named product and setpoint. See Figure 96.
3. If the **+** or **-** soft keys were pressed to change the current setpoint for the named product, the “New Setpoint for XXXXX Will Be” Screen will appear. See Figure 96.

4. Press the **YES** soft key to accept the new setpoint for the named product.

NOTE: If the **NO key is pressed the setpoint will not be changed and the display will return to the Standard Display.**

5. The “Programming New Setpoint for XXXXX” Screen will briefly appear. See Figure 96.
6. The “New Setpoint Is XX” Screen briefly appears. See Figure 96.
7. The Standard Display appears with the named product and new setpoint. See Figure 96.

NOTE: Pressing the **EXIT soft key at any point will return to the Standard Display.**

NOTE: If no keys are pressed for 30 seconds while in the Named Product Changer Screens, the HMI Control Panel will return to the Standard Display.

Operating Instructions

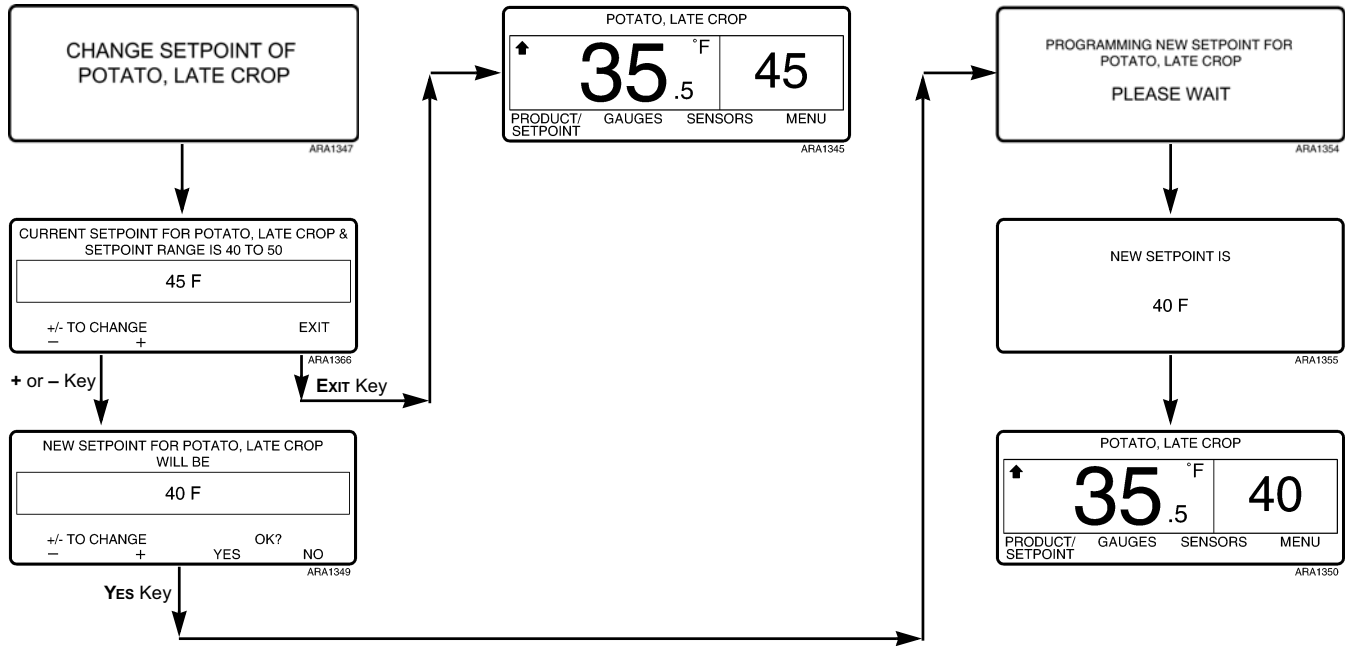
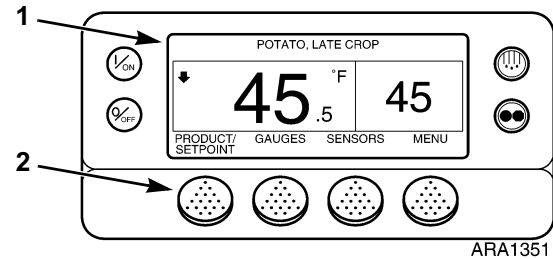

Figure 96: Selecting Setpoint for Named Product Screen Sequence

Changing the Setpoint for a Named Product

If the named product has been programmed with a setpoint range, the setpoint for the named product can be changed. Complete the following steps to change the setpoint for a named product. This example shows the Standard Display with the **PRODUCT/SETPOINT** soft key. Using the Standard Display with the **PRODUCT** soft key is basically the same but some of the screens differ slightly.

1. Begin at the Standard Display.
If the Temperature Watch Display is showing, press the **MENU** soft key once to return to the Standard Display.
2. Press the **PRODUCT/SETPOINT** (or **PRODUCT**) soft key on the Standard Display. See Figure 97.
3. The “Named Product, Numeric Setpoint or Change Setpoint?” (or Named Product or Change Setpoint?) Screen will appear. See Figure 98.



1.	Standard Display
2.	Product/Setpoint Soft Key

Figure 97: Changing Setpoint for Named Product

4. Press the **CHANGE SP** soft key. See Figure 98.
5. The “Change Setpoint for XXXXX” Screen briefly appears, then the “Current Setpoint for XXXXX & Setpoint Range Is XX to XX” Screen will appear. See Figure 98.
6. Press the **+** or **-** soft keys to change the setpoint reading. See Figure 98.

Operating Instructions

7. Press the **YES** or **NO** soft keys accordingly as described below. See Figure 98.
 - If the **NO** key is pressed the named product setpoint change made with the “+” or “-” soft keys **will not** be accepted, the named product setpoint will not be changed and the display will return to the Standard Display.
 - If the **YES** soft key is pressed, the named product setpoint change made with the “+” or “-” soft keys will be accepted, and the following screens will appear.
8. The “Programming New Setpoint for XXXXX” Screen will briefly appear. See Figure 98.
9. The “New Setpoint Is XX” Screen briefly appears. See Figure 98.
10. The Standard Display appears with the new setpoint. See Figure 96.

NOTE: Pressing the EXIT soft key at any point will return to the Standard Display.

NOTE: If no keys are pressed for 30 seconds while in the Named Product Changer Screens, the HMI Control Panel will return to the Standard Display.

Operating Instructions

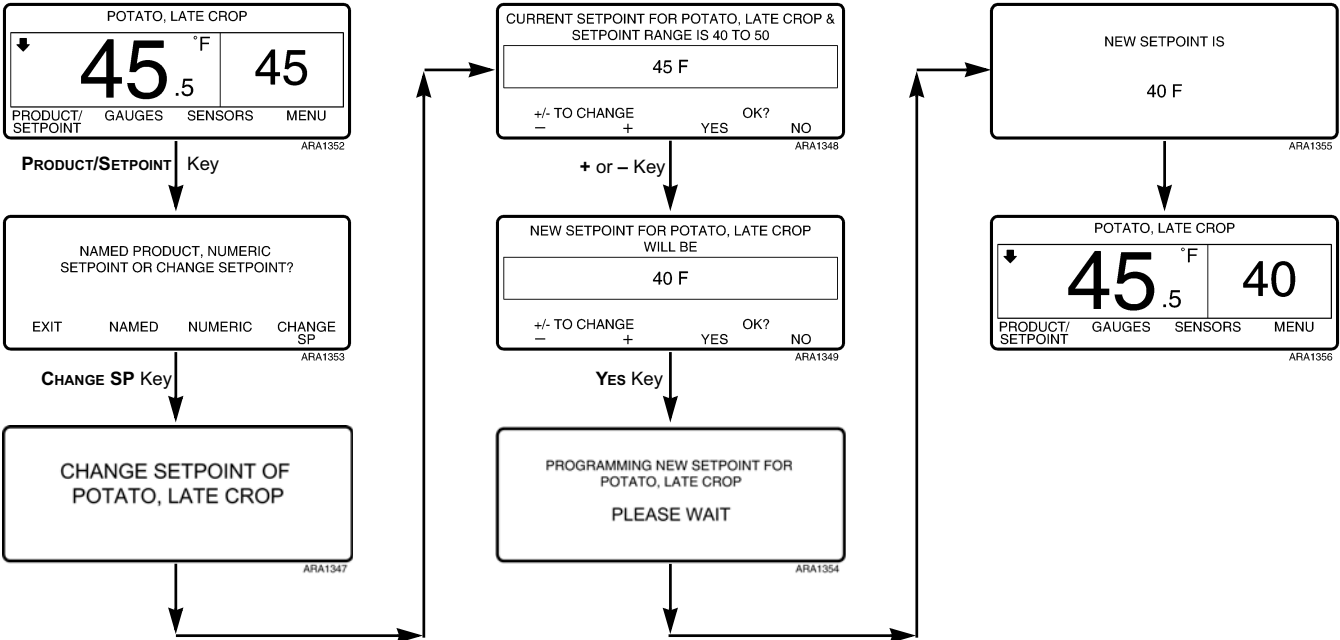
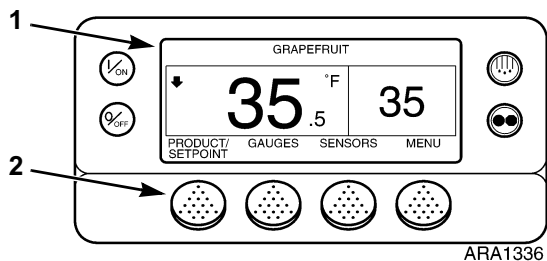

Figure 98: Changing Setpoint for Named Product Screen Sequence

Selecting a Setpoint

To select or change a setpoint complete the following steps.

1. Begin at the Standard Display.
If the Temperature Watch Display is showing, press the **MENU** soft key once to return to the Standard Display.
2. Press the **PRODUCT/SETPOINT** soft key on the Standard Display. See Figure 99.



1.	Standard Display
2.	Product/Setpoint Soft Key

Figure 99: Selecting or Changing Setpoint

3. The “Named Product / Numeric Setpoint?” Screen briefly appears, then the “Named Product or Numeric Setpoint?” Screen will appear. See Figure 100.
4. Press the **NUMERIC** soft key. See Figure 100.
5. The “Setpoint” Screen briefly appears, then the “Current Setpoint Is” Screen will appear. See Figure 100.
6. Press the **+** or **-** soft keys to change the setpoint. See Figure 100.
7. Press the **YES** or **No** soft key accordingly as described below. See Figure 100.
 - If the **No** key is pressed the setpoint change made with the “+” or “-” soft keys **will not** be accepted, the setpoint will not be changed and the display will return to the Standard Display.
 - If the **YES** soft key is pressed, the setpoint change made with the “+” or “-” soft keys will be accepted, and the following screens will appear.
8. The “Programming New Setpoint” Screen will appear. See Figure 100.

Operating Instructions

9. The “New Setpoint Is XX” Screen briefly appears. See Figure 100.
10. The Standard Display appears with setpoint changed to the new setpoint. See Figure 100.

NOTE: Pressing the EXIT soft key at any point will return to the Standard Display.

NOTE: If no keys are pressed for 30 seconds while in the Named Product Changer Screens, the HMI Control Panel will return to the Standard Display.

Operating Instructions

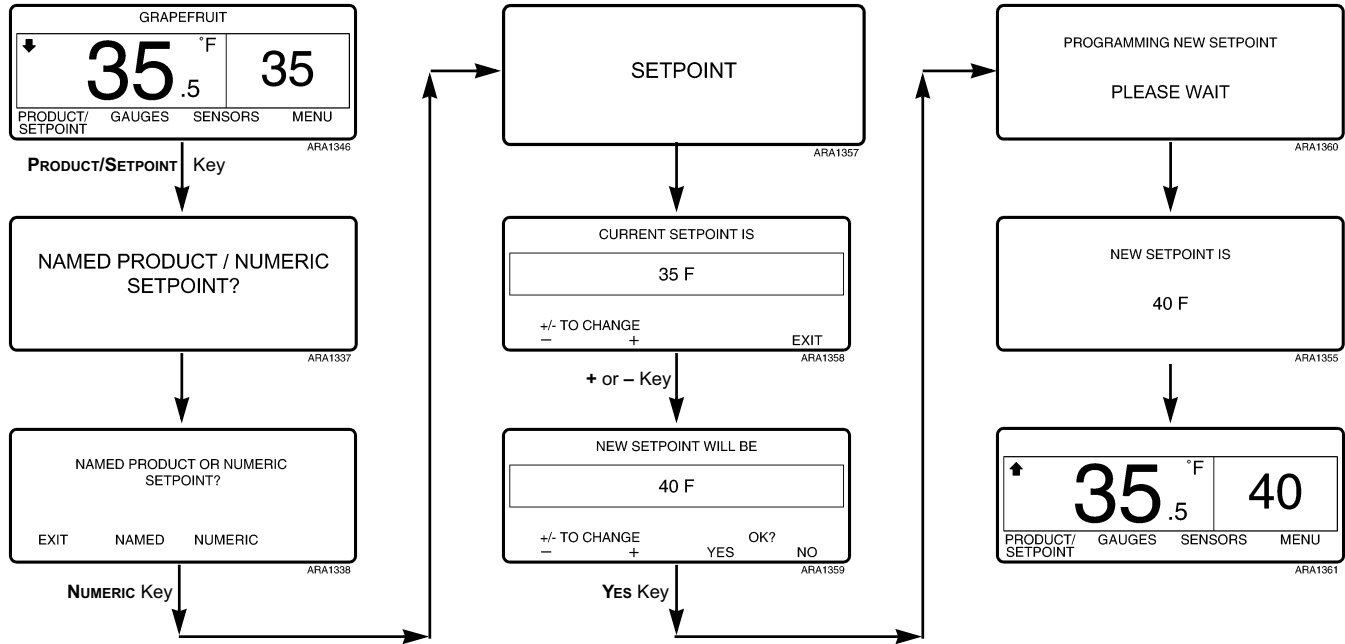

Figure 100: Selecting or Changing Numeric Setpoint Screen Sequence

Optional Rear Remote Control Panel

The optional Rear Remote Control Panel is connected to the control system and is used to operate the unit from a remote location, typically at the rear of the trailer. In the illustration below all display segments are turned on.

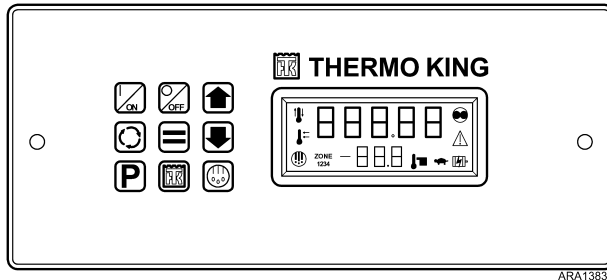

Figure 101: Rear Remote Control Panel

Rear Remote Control Panel Functionality

The Rear Remote Control Panel functions that are available to the user are determined by the setting of the Rear Remote Control Action features in the Guarded Access / Unit Configuration Menu. The Rear Remote Control Action can be set to either RUN or STAND BY.

When the unit is turned on at the Rear Remote Control Panel either the Standard Display or [STAnd by] will appear on the display.

Rear Remote Control Action set to Run

If the Rear Remote Control Action is set to RUN the Standard Display will be present on the Rear Remote Control Panel and the unit will start and run when the Rear Remote Control Panel ON Key is pressed. Pressing the Rear Remote Control Panel OFF Key will turn the unit off.

Optional Rear Remote Control Panel

If the control system is powered up from the Rear Remote Control Panel the Standard Display will appear in both the Rear Remote Control Panel display and the unit HMI Control Panel display. When set to RUN the Rear Remote Control Panel allows the following:

- Turn the unit on and off
- Unit will start and run
- Change the Setpoint
- Select Cycle-Sentry or Continuous Mode
- Display discharge air temperature
- Display and clear alarm codes
- Initiate a manual defrost cycle
- Send a Start of Trip marker to the ServiceWatch and CargoWatch Data Loggers
- Initiate a Pretrip Test

Rear Remote Control Action Set to Stand By

If the Rear Remote Control Action is set to STAND BY, pressing the Rear Remote Control Panel ON Key will power up the control system, but the unit will not start and run. Pressing the Rear Remote Control Panel OFF Key will turn the unit off. The HMI Control Panel on the unit must be used to start and stop unit operation.

In addition to turning the unit on and off, when set to STAND BY the Rear Remote Control Panel allows the following:

- Turn the unit on and off
- Unit will not start and run
- Change the Setpoint
- Select Cycle Sentry or Continuous Mode (unless prevented by OptiSet Plus)
- Display discharge air temperature
- Display and clear alarm codes
- Send a Start of Trip marker to the ServiceWatch and CargoWatch Data Loggers

Optional Rear Remote Control Panel

When in STAND BY, the unit will not start and run and a defrost cycle or Pretrip Test cannot be started.

If the control system is powered up from the remote control panel a stand by message will appear in both the remote control panel display and the unit HMI Control Panel display as shown in Figure 102 and Figure 103.



Figure 102: Rear Remote Control Panel Display



Figure 103: Unit HMI Control Panel Display

When the StAnd bY display is shown, press the Select Key to show the Remote Standard Display. When the remote standard Display is shown, the setpoint and operating mode can be changed, the discharge air temperature can be displayed and alarms can be viewed and cleared. In addition, a Start of Trip can be sent to the data loggers.

After the last key is pressed, the display will return to the StAnd bY display shown in Figure 104 in about 10 seconds.

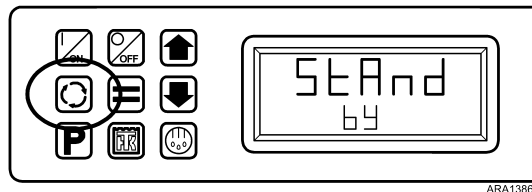

Figure 104: Press Select Key

Optional Rear Remote Control Panel

Keypad

The nine touch sensitive keys are used to turn the unit on and off. They also allow the setpoint to be changed, Cycle Sentry or Continuous Mode to be selected, Alarm Codes and other operating data to be displayed and Pretrip Tests and Defrost Cycles to be performed. A Start of Trip marker can also be sent to the data loggers.

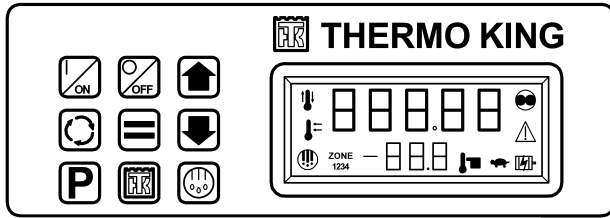



Figure 105: Rear Remote Control Panel

ARA1387

	ON Key	Turns the unit on as determined by the setting of Rear Remote Control Action.
	OFF Key	Turns the unit off.
	Up Arrow Key	Increases setpoint or changes other setting.
	Down Arrow Key	Decreases setpoint or changes other setting.
	Select Key	Allows Cycle-Sentry to be turned on and off, displays the discharge air temperature and alarms.
	Enter Key	Executes a prompt or loads a new setpoint or other setting.
	Pretrip Key	Initiates a Pretrip Test.

Optional Rear Remote Control Panel

	TK Logo Key	Sends a Start of Trip marker to the data logger.
	Defrost Key	Initiates a defrost cycle if conditions allow.

Display

The display normally shows the Standard Display of return air temperature and setpoint. The icons on either side of the display indicate operating modes and alarms. The display shown here has all possible segments lighted. The display icons are defined below.

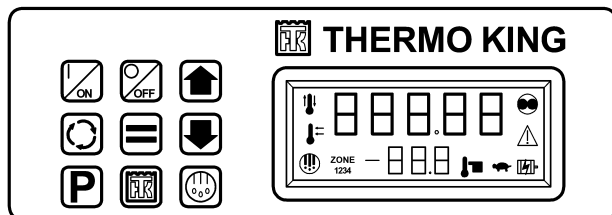











Figure 106: Rear Remote Control Panel

ARA1387

	Cool Icon	This icon appears when the unit is cooling.
	Heat Icon	This icon appears when the unit is heating.
	Modulation Icon	This icon appears when the unit is in modulation.
	Defrost Icon	This icon appears when the unit is defrosting.
	Cycle-Sentry Icon	This icon appears when the unit is operating in Cycle-Sentry mode.
	Alarm Icon	This icon appears when an alarm condition has been detected.
	Electric Standby Icon	This icon appears when the unit is operating in the optional electric standby mode.
	Setpoint Icon	This icon appears when the setpoint is being shown in the display.
	Not Used	This icon appears during a remote control panel test but is not currently used.

Optional Rear Remote Control Panel

Reading a Typical Remote Standard Display

The Remote Standard Display shows the temperature and setpoint. The icons at the sides of the display indicate operating conditions.

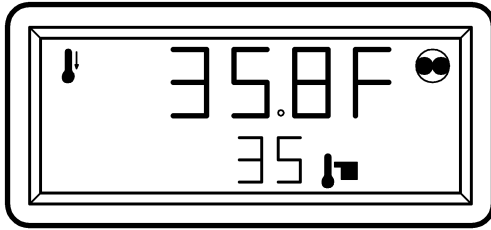

ARA1388

Figure 107: Remote Standard Display

The Remote Standard Display in Figure 107 shows the following information:

- The temperature (typically return air temperature) is 35.8°F.
- The setpoint is 35°F.

- The unit is cooling as shown by the icon at the upper left side of the display.
- The unit is operating in Cycle Sentry mode as shown by the icon at the upper right side of the display.

Remote Control Panel Lockout

The remote control panel may be locked out during some control system functions such as Service Test Mode, Interface Board Test Mode and while setting programmable features. If this is the case the display shown in Figure 108 will appear. The display will return to the Remote Standard Display when allowed by the control system.

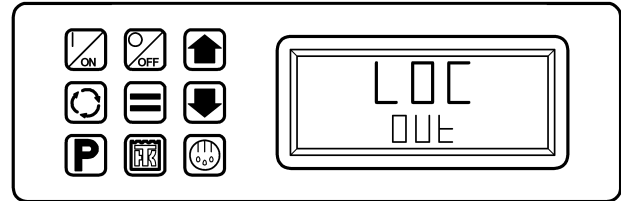

ARA1389

Figure 108: Remote Lock Out Display

Optional Rear Remote Control Panel

Turning the Unit ON or OFF (Configured for STAND BY Operation)

The control system is turned on by pressing the ON Key and off by pressing the OFF Key. When the On Key is pressed the remote display briefly shows all segments and then StAnd by as shown in Figure 109. A stand by message will also appear on the unit HMI Control Panel display. The setpoint can be changed but the unit will not start and run. Only the Select Key, Enter Key and Up and Down Arrow Keys are functional. The unit can be started and run by pressing the unit HMI Control Panel ON Key.

IMPORTANT: To change the setpoint, press the Select Key to show the Remote Standard Display. The setpoint can now be changed as shown on page 152.

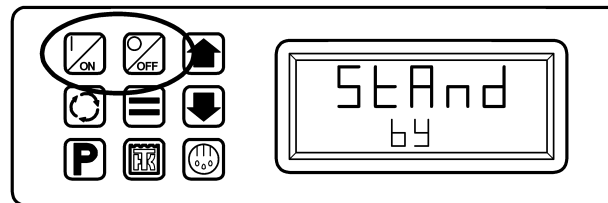

ARA1390

Figure 109: Stand By Display

Turning the Unit On and Off (Configured for RUN Operation)

The unit is turned on by pressing the ON key and off by pressing the OFF key. When the ON key is pressed the remote display briefly shows all segments and then COn FIG as the control system initializes. Then the Remote Standard Display will appear as shown in Figure 110. The unit will start and run if necessary.

Optional Rear Remote Control Panel

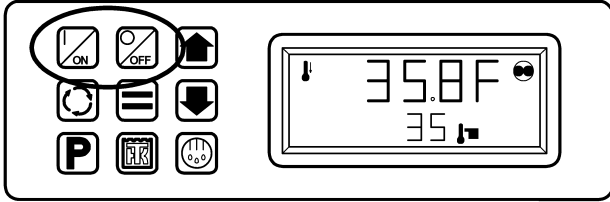

Figure 110: Standard Display

ARA1391

Changing the Setpoint

The setpoint can be changed when the Remote Standard Display is shown.

1. When the Remote Standard Display is shown, press the Up or Down Arrow Keys to select the desired setpoint (Figure 111).

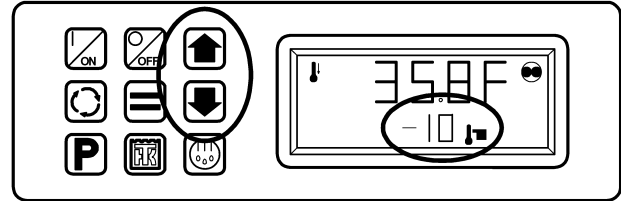

Figure 111: Press Up or Down Arrow Keys

ARA1392

Optional Rear Remote Control Panel

2. When the desired setpoint is shown on the display, immediately press the Enter Key to load the new setpoint. The display will briefly show [Lod] and then the new setpoint will reappear in the display.

IMPORTANT: The Enter key (Figure 112) must be pressed or the setpoint will not be changed. The display will return to the Standard Display and the setpoint will return to the old setpoint in about 10 seconds if the Enter Key is not pressed. Alarm Code 127 Setpoint Not Entered is set, to indicate that the setpoint change was started but not completed.

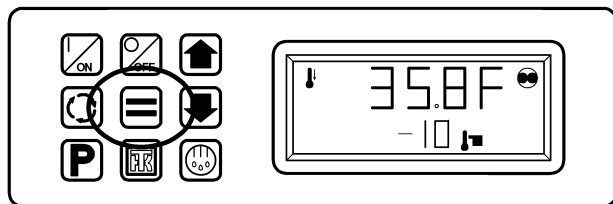

Figure 112: Press Enter Key

IMPORTANT: Confirm that the correct setpoint is set.

Selecting Cycle-Sentry or Continuous Mode

Cycle Sentry or Continuous Mode operation can be changed using the Select Key.

1. When the Remote Standard Display is shown, press the Select key once to display the Cycle Sentry prompt.

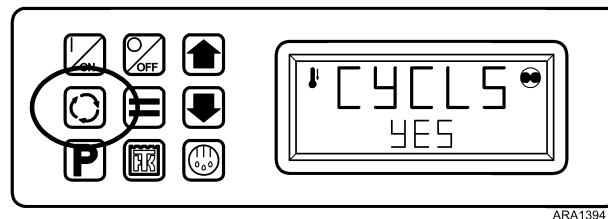

Figure 113: Press Select Key

2. Use the Up and Down Arrow Keys to choose either YES or nO. Yes = Cycle Sentry Mode. nO = Continuous Mode.

Optional Rear Remote Control Panel

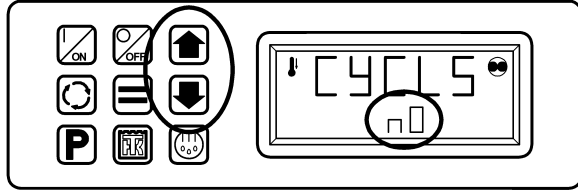

Figure 114: Press Up or Down Arrow Keys

3. When the desired selection is shown, press the Enter Key (Figure 115) to load the setting. The display will briefly show [Lod] and then the new selection will briefly appear in the display.

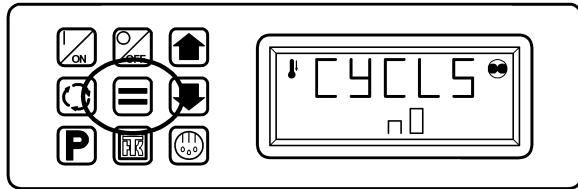

Figure 115: Press Enter Key

4. The display will then return to the Remote Standard Display.

Displaying the Discharge Air Temperature

The discharge air temperature can be shown using the Select Key.

1. When the Remote Standard Display is shown, press the Select Key twice. The discharge air temperature will be shown in the display for about 10 seconds.

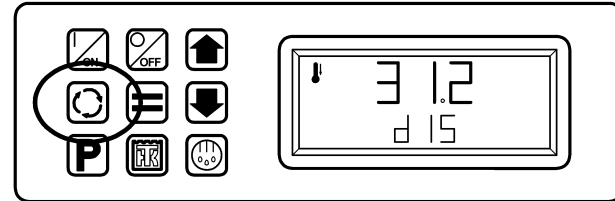

Figure 116: Press Select Key Twice

2. The display will then return to the Remote Standard Display.

Optional Rear Remote Control Panel

Viewing and Clearing Alarm Codes

Alarm Codes can be displayed and cleared using the Select Key.

1. When the Remote Standard Display is shown, press the Select Key three times. Any alarm codes present will be shown in the display, with the most recent alarm code shown first. If no alarm codes are present the display will show [00].

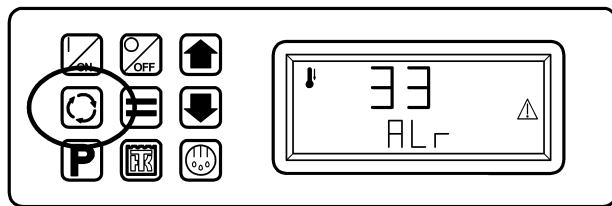

Figure 117: Press Select Key Three Times

2. To clear a displayed alarm code, press the Enter Key. The display will briefly show CLEAR ALM.

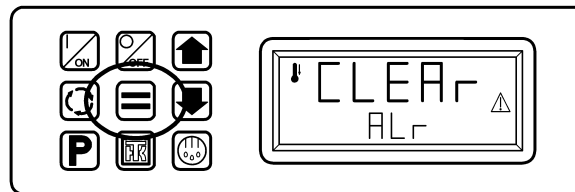

Figure 118: Press Enter Key

3. If any additional alarms are present, the next alarm will be shown. If no other alarms are present the display will briefly show [00].

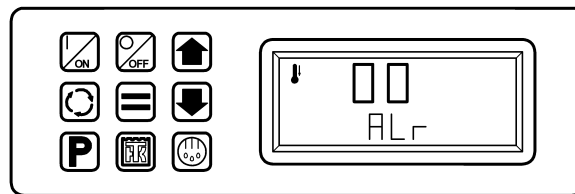

Figure 119: No Alarms Display

4. The display will then return to the Remote Standard Display.

Optional Rear Remote Control Panel

Starting a Manual Defrost Cycle

If conditions allow, a manual defrost cycle can be initiated using the Defrost Key.

1. Press the Defrost Key. The defrost prompt [EnTER dEF] will appear in the display.

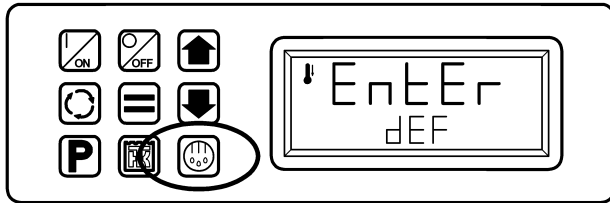
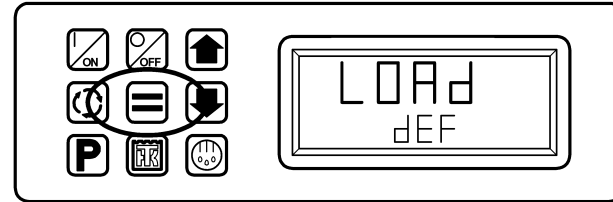

Figure 120: Press Defrost Key

ARA1401

2. When the defrost prompt is shown, press the Enter Key to start a manual defrost. The display will briefly show LOAd dEF and then a defrost cycle will begin if conditions allow.



ARA1402

Figure 121: Press Enter Key

3. The display will return to the Remote Standard Display. The Defrost Icon will be shown in the display.

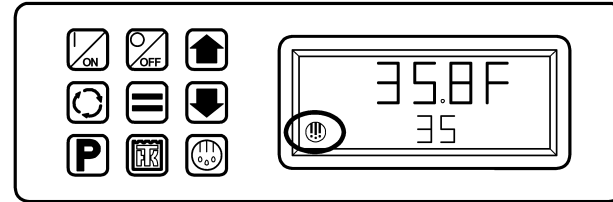

ARA1403

Figure 122: Defrost Icon Displayed

4. The defrost cycle will terminate automatically.

Optional Rear Remote Control Panel

Sending a Start of Trip Marker

A Start of Trip marker can be sent to the data loggers using the TK Logo Key.

1. Press the TK Logo Key. The Start of Trip [EnTEr SOt] prompt will appear in the display.

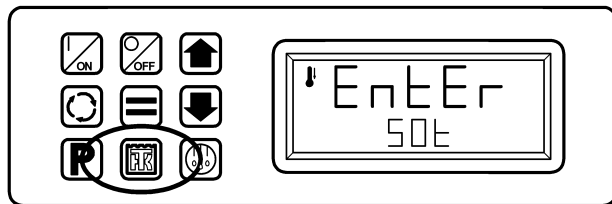
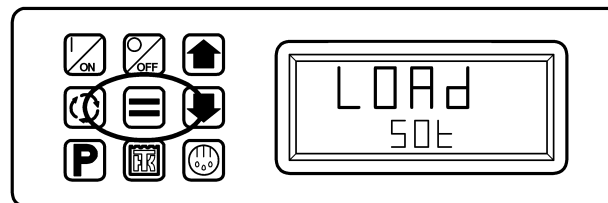

Figure 123: Press TK Logo Key

ARA1404

2. When the Start of Trip prompt is shown, press the Enter Key to send a Start of Trip marker to the CargoWatch and ServiceWatch data loggers. The display will briefly show LOAD SOt.



ARA1405

Figure 124: Press Enter Key

3. The display will then return to the Remote Standard Display.

Optional Rear Remote Control Panel

Running a Pretrip Test

A Pretrip Test can be started using the Pretrip Key as long as the unit is not in STAND BY. If the unit is not running when the Pretrip Test is started a Full Pretrip Test will be performed. If the unit is running when the Pretrip Test is started a Running Pretrip Test will be performed.

1. Clear any alarm codes as shown previously.
2. Press the Pretrip Key. The Pretrip [EntEr PrE] prompt will appear in the display.

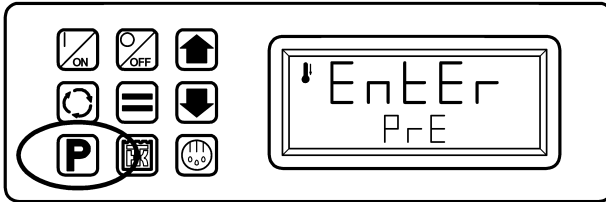

Figure 125: Press Pretrip Key

3. When the Pretrip prompt is shown, press the Enter Key to start a Pretrip Test. The display will briefly show LOAd PrE. If the unit is not running a Full Pretrip Test will be performed. If the unit is running a Running Pretrip Test will be performed.

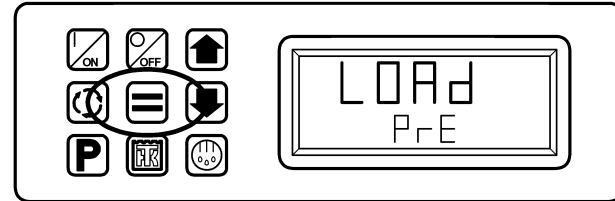
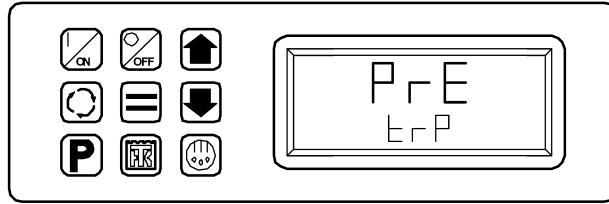

Figure 126: Press Enter Key

Optional Rear Remote Control Panel

4. When the Pretrip Test is running the display will show PrE trP. The HMI Control Panel will show the Pretrip Test progress.
5. When the Pretrip Test is complete the display will show PASS, CHEC or FAIL. Pressing the Select Key will return to the Remote Standard Display.



ARA1408

Figure 127: Pretrip Display

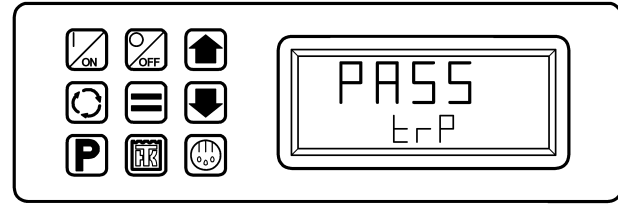

ARA1409

Figure 128: Pass Pretrip Display

Optional Rear Remote Control Panel

Loading and Enroute Inspections

This chapter describes pre-loading, post loading, and enroute inspection procedures. Thermo King refrigeration units are designed to maintain the required product load temperature during transit. Follow these recommended loading and enroute procedures to help minimize temperature related problems.

Pre-Loading Inspection

1. Pre-cool products before loading. Note any variances on the manifest.
2. Inspect door seals and vent doors for condition and a tight seal with no air leakage.
3. Inspect the trailer inside and out. Look for:
 - Damaged or loose trailer skin and insulation
 - Damaged walls, air ducts, floor channels or “T” flooring
 - Clogged defrost drain tubes
 - Blocked return air bulkhead
4. Verify that the setpoint temperature is correct for your cargo. Pre-cool the trailer as required.
5. Supervise product loading to ensure sufficient air space around and through the load. Airflow around the cargo must not be restricted.

NOTE: If the warehouse is not refrigerated, operate the unit with doors closed until cargo is ready to be loaded. Then turn off the unit, open cargo doors and load cargo. When cargo is loaded, close trailer doors and restart the unit.

The unit can be operated with the cargo box doors open if the truck is backed into a refrigerated warehouse and the dock door seals fit tightly around the trailer.

Loading and Enroute Inspections

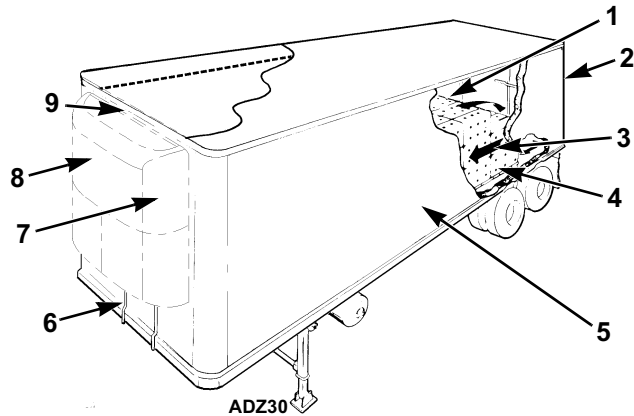

1.	Correct load height (trailers without chutes)
2.	Tight doors and gaskets
3.	Good air circulation around load
4.	Proper cargo temperature (prior to loading)
5.	Interior/exterior walls and insulation in good condition
6.	Clear defrost drains
7.	Good outside air circulation
8.	Unit inspection
9.	Tight seals

Figure 129: Loading Considerations

Post-Loading Inspection

Post-loading inspections ensure the cargo has been loaded properly. To perform a post-load inspection:

1. Inspect the evaporator outlets for blockage.
2. Turn the unit off before opening the cargo box doors to maintain efficient operation.

NOTE: The unit can be operated with the cargo box doors open if the truck is backed into a refrigerated warehouse and the dock door seals fit tightly around the trailer.

3. Perform a final check of the load temperature. If the load is above or below temperature, make a final notation on the manifest.



CAUTION: Cargo must be pre-cooled to the proper temperature before loading. The unit is designed to maintain temperature, not cool an above-temperature load.

4. Close or supervise the closing of the cargo box doors. Make sure they are securely locked.
5. Make sure the setpoint is at the temperature listed on the manifest.
6. If the unit was stopped, restart using the correct starting procedure. See the Operating Instruction chapter in this manual.
7. Start a manual defrost cycle 30 minutes after loading. See the Manual Defrost procedure in this manual.

Enroute Inspections

Complete the following enroute inspection every four hours. This will help minimize temperature related problems.

Inspection Procedure

1. Verify setpoint is correct.
2. Check the return air temperature reading. It should be within the desired temperature range.
3. Initiate a manual defrost cycle after each enroute inspection.

Inspection Troubleshooting

1. If a temperature reading is not within the desired temperature range, refer to the troubleshooting table on the following pages. Correct problem as required.

2. Repeat the Enroute Inspection every 30 minutes until the compartment temperature is within the desired temperature range. Stop the unit if the compartment temperature is not within the desired temperature range on two consecutive 30 minute inspections, especially if the compartment temperature appears to be moving away from the setpoint.
3. Immediately contact the nearest Thermo King Service Center or your company office.
4. Take all necessary steps to protect and maintain proper load temperature.



CAUTION: Stop the unit if the compartment temperature remains higher than the desired temperature range from the setpoint on two consecutive 30 minute inspections. Contact the nearest Thermo King Service Center or your company office immediately. Take all necessary steps to protect and maintain proper load temperature.

Inspection Troubleshooting

Problem	Cause	Remedy
A return air temperature reading is not within desired temperature range of the setpoint.	The unit has not had time to cool down to correct temperature.	Refer to the load log history. Look for above temperature load records, properly pre-cooled cargo compartment, length of time on road, etc. Correct as required. Continue monitoring return air temperature until the reading is within the desired temperature range of the setpoint.
	The unit may have a low refrigerant charge.	Check the receiver tank sight glass for refrigerant level. If liquid is not showing in the receiver tank sight glass, the refrigerant charge may be low. A competent refrigeration technician is required to add refrigerant or repair the system. Contact the nearest Thermo King dealer, authorized Service Center, or call the Thermo King Cold Line for referral. Consult the Table of Contents for Cold Line information.
	The unit is in defrost or has just completed a defrost cycle.	Monitor the return air temperature after the defrost cycle is completed to see if the temperature returns to the desired temperature range of the setpoint.
	The evaporator is plugged with frost.	Initiate a manual defrost cycle. The defrost cycle will automatically terminate when complete. Continue monitoring the return air temperature until the reading is within the desired temperature range of the setpoint.

Loading and Enroute Inspections

Problem	Cause	Remedy
	Improper air circulation in the cargo compartment.	Inspect the unit and cargo compartment to determine if the evaporator fan(s) are working and properly circulating the air. Poor air circulation may be due to improper loading of the cargo, shifting of the load, or fan belt slippage. Correct as required. Continue monitoring return air temperature until problem is corrected.
	The unit did not start automatically.	Determine the cause for not starting. Correct as required. Continue monitoring the return air temperature until the reading is within the desired temperature range of the setpoint.

Alarm Codes

Introduction

An alarm code is generated when the microprocessor senses an abnormal condition. Alarms direct an operator or service technician to the source of a problem.

Multiple alarms can be present at one time. All generated alarms will be stored in memory until cleared by the operator. Document all alarm occurrences and report them to the service technician.

See “Alarms Menu” in the Operation Instructions Chapter for information about viewing and clearing alarms.

NOTE: Some alarms (3, 4, 74, 203, and 204) cannot be cleared in the Alarms Menu, they must be cleared in the Maintenance Menu or the Guarded Access Menu. Contact your supervisor or a Thermo King dealer about clearing those alarms.

IMPORTANT: Always record any Alarm Codes that occur - in the order that they occur - as well as any other pertinent information. This information is extremely valuable to service personnel.

NOTE: In some cases alarms cannot be cleared, or cannot be cleared after they have occurred a specified number of times. If such is the case, these alarms must be cleared by service personnel. See “Clearing Alarm Codes” on page 170.

Alarm Types

The four types of alarms are described below.

Log Alarms: Log Alarms are indicated by the Log Alarms screen, which appears for approximately 30 seconds (just before the Standard Display appears) each time the unit is turned on. The Alarm Display must be used to view the existing alarms. This level of alarm serves as a notice to take

Alarm Codes

corrective action before a problem becomes severe. Maintenance items such as a maintenance reminder hour meter reaching its time limit are log alarms.

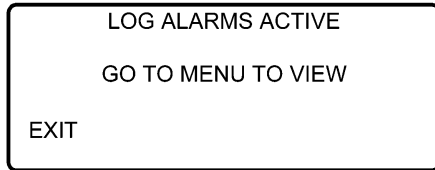

Figure 130: Log Alarms Screen

Check Alarms: Check Alarms are indicated by the Alarm Display in which the large Alarm Icon will appear on the Standard Display as shown below in Figure 131. The Alarm Menu must be used to view the existing alarms. This level of alarm serves as a notice to take corrective action before a problem becomes severe. The unit will run with check alarms but some features and functions may be inhibited.

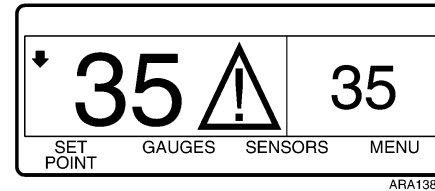

Figure 131: Alarm Display

Prevent Alarms: Prevent Alarms are also indicated by the Alarm Display as shown in Figure 131. The Alarm Menu must be used to view the existing alarms. The unit may stop running and wait a timed interval or until conditions allow and then restart. If the unit is waiting to restart, Alarm Code 84 Restart Null will be present along with the Prevent Alarm. In other cases the unit may restart or run with reduced performance to determine if continued operation is possible. If the alarm does not reoccur with reduced performance the unit will then return to full performance. If the unit is operating with reduced performance Alarm Code 85 Forced Unit Operation will also be present.

Alarm Codes

Shutdown Alarms: Shutdown Alarms are indicated by the Alarm Display. Shutdown alarms also cause the display and backlight to flash on and off, and the display will switch from normal video to reverse video and back to normal video (light areas become dark and dark areas become light as shown in Figure 132). Shutdown alarms force the unit into shutdown. The unit will remain in shutdown and will not restart until the shutdown alarm is cleared. Exceptions are some engine and electric shutdown alarms become that log alarms when switched to the alternate operating mode (diesel to electric or electric to diesel).

If a shutdown alarm occurs that affects only diesel mode operation and the unit is switched to electric (either manually or automatically), the diesel mode shutdown alarm becomes an electric mode log alarm. This allows the unit to run in electric mode without clearing the shutdown alarm that is preventing diesel mode operation. If the unit is switched back to diesel mode, the alarm again becomes a diesel mode shutdown alarm and prevents unit operation. If the unit is configured for electric to diesel autoswitch, it automatically starts and runs in diesel mode if an electric shutdown occurs.

In the same manner, if a shutdown alarm occurs that affects only electric mode operation and the unit is switched to diesel (either manually or automatically), the electric mode shutdown alarm becomes a diesel mode log alarm to allow diesel mode operation. If the unit is switched back to electric mode, the alarm reverts to an electric mode shutdown alarm and prevents unit operation.

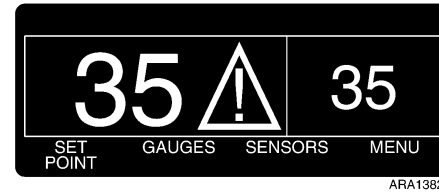

Figure 132: Shutdown Alarm Display

Pretrip Alarm Codes

If an alarm occurs during a Pretrip Test the alarm code will be displayed as Pretrip Alarm XX, where XX is the alarm code.

Clearing Alarm Codes

Most alarm codes can be cleared by the operator from the Alarm Menu using the CLEAR key.

The following control and display sensor alarm codes can only be cleared from the Maintenance Menu or Guarded Access Menu:

- Alarm Code 03 Check Control Return Air Sensor
- Alarm Code 04 Check Control Discharge Air Sensor
- Alarm Code 203 Check Display Return Air Sensor
- Alarm Code 204 Check Display Discharge Air Sensor

The following alarm codes clear automatically:

- Alarm Code 64 Pretrip Reminder - Clears when a Pretrip Test is performed.
- Alarm Code 84 Restart Null - Clears when the unit is no longer in a restart null due to a Prevent Alarm.
- Alarm Code 85 Forced Unit Operation - Clears when the unit is no longer running in a forced mode due to a Prevent Alarm.

- Alarm Code 91 Check Electric Ready Input - Clears automatically when the unit starts running.

The operator should contact a supervisor or a Thermo King dealer about clearing alarms using the Guarded Access Menu.

Refer to the table on the following pages for alarm corrective action.

NOTE: Document all alarm faults and report them to the service technician.

There are three levels of corrective action that can be taken when an alarm condition occurs.

OK To Run: An alarm condition exists but does not affect unit operation. Corrective action can occur at a later date.

Check As Specified: An alarm condition exists that could affect unit operation. Follow directions in the Corrective Action column on the following chart.

Take Immediate Action: An alarm condition exists that will damage the unit or load. Take immediate action to correct the problem.

Alarm Codes

NOTE: The corrective actions listed above and on the following chart are suggestions only. Always consult your company for final decisions.

NOTE: The chart on the following pages shows all possible alarm codes for all possible applications. Not all codes will be applicable to each individual unit.

Table of Alarm Codes

NOTE: Not all alarm codes are available with all microprocessor controllers or all revisions of software.

Code	Description	Corrective Action	Level Of Action		
			Ok To Run	Check	Shut Down
00	No Alarms Exist	None required	X		
2	Evaporator Coil Sensor	Manually monitor load temperature with independent thermometer. Report alarm at end of day.		X	
3	Control Return Air Sensor	Manually monitor load temperature with independent thermometer. Report alarm at end of day.		X	
4	Control Discharge Air Sensor	Manually monitor load temperature with independent thermometer. Report alarm at end of day.		X	
5	Ambient Air Sensor	Report alarm at end of day.		X	
6	Coolant Temp Sensor	Report alarm at end of day.		X	
7	Engine RPM Sensor	Report alarm at end of day.		X	
9	High Evaporator Temperature	Manually monitor load temperature. Report alarm at end of the day.		X	

Alarm Codes

Table of Alarm Codes

NOTE: Not all alarm codes are available with all microprocessor controllers or all revisions of software.

Code	Description	Corrective Action	Level Of Action		
			Ok To Run	Check	Shut Down
10	High Discharge Pressure	If unit is shut down repair immediately. Otherwise, report alarm at end of day.			X
11	Unit Controlling on Alternate Sensor	Manually monitor load temperature with independent thermometer. Report alarm at end of day.		X	
12	Sensor or Digital Input Shutdown	The indicated zone is no longer able to operate and has been shut down. Repair immediately.			X
13	Sensor Check	Manually monitor load temperature with independent thermometer. Report alarm at end of day.		X	
15	Check Glow Plugs/Intake Air Heater	If unit is shut down, repair immediately. Otherwise, report alarm at end of day.		X	
17	Engine Failed to Crank	If unit is shut down repair immediately. Otherwise, report alarm at end of day.		X	
18	High Engine Coolant Temperature	If unit is shutdown repair immediately. Otherwise, report alarm at end of day.		X	

Table of Alarm Codes

NOTE: Not all alarm codes are available with all microprocessor controllers or all revisions of software.

Code	Description	Corrective Action	Level Of Action			
			Ok To Run	Check	Shut Down	
19	Low Engine Oil Pressure	If unit is shutdown repair immediately. Otherwise report alarm at end of day.		X		
20	Engine Failed to Start	If unit is shutdown repair immediately. Otherwise, report alarm at end of day.		X		
21	Cooling Cycle Check	Manually monitor load temperature with independent thermometer. Report alarm at end of day.		X		
22	Heating Cycle Check	Manually monitor load temperature with independent thermometer. Report alarm at end of day.		X		
23	Cooling Cycle Fault	The indicated zone is no longer able to operate and has been shut down. Repair immediately.				X
24	Heating Cycle Fault	The indicated zone is no longer able to operate and has been shut down. Repair immediately.				X
25	Alternator Check	If unit is shutdown repair immediately. Otherwise, report alarm at end of day.		X		

Alarm Codes

Table of Alarm Codes

NOTE: Not all alarm codes are available with all microprocessor controllers or all revisions of software.

Code	Description	Corrective Action	Level Of Action		
			Ok To Run	Check	Shut Down
26	Refrigeration Capacity	Manually monitor load temperature with independent thermometer. Report alarm at end of day.		X	
28	Pretrip or Self Check Abort	Report alarm at end of day.	X		
29	Defrost Damper Circuit	If unit is shutdown, repair immediately. Otherwise, report alarm at end of day.		X	
30	Defrost Damper Stuck	If unit is shutdown, repair immediately. Otherwise, report alarm at end of day.			X
31	Oil Pressure Switch	If unit is shutdown repair immediately. Otherwise, report alarm at end of day.		X	
32	Refrigeration Capacity Low	The indicated zone is no longer able to operate and has been shut down. Repair immediately.			X
33	Check Engine RPM	Report alarm at end of day.	X		

Table of Alarm Codes

NOTE: Not all alarm codes are available with all microprocessor controllers or all revisions of software.

Code	Description	Corrective Action	Level Of Action			
			Ok To Run	Check	Shut Down	
35	Run Relay Circuit	If unit is shutdown, repair immediately. Otherwise, report alarm at end of day.			X	
36	Electric Motor Failed to Run	If unit is shutdown, repair immediately. Otherwise, report alarm at end of day.			X	
37	Engine Coolant Level	Check coolant level, add as needed. Report alarm at end of day.	X			
38	Electric Phase Reversed	If unit is shutdown, repair immediately. Otherwise, report alarm at end of day.			X	
39	Water Valve Circuit	If unit is shutdown, repair immediately. Otherwise, report alarm at end of day.		X		
40	High Speed Circuit	If unit is shutdown, repair immediately. Otherwise, report alarm at end of day.		X		
41	Check Engine Coolant Temperature	If unit is shutdown, repair immediately. Otherwise, report alarm at end of day.	X			

Alarm Codes

Table of Alarm Codes

NOTE: Not all alarm codes are available with all microprocessor controllers or all revisions of software.

Code	Description	Corrective Action	Level Of Action			
			Ok To Run	Check	Shut Down	
42	Unit Forced to Low Speed	Report alarm at end of day.	X			
43	Unit Forced to Low Speed Modulation	Report alarm at end of day.	X			
44	Check Fuel System	Refill fuel tank.		X		X
45	Hot Gas Bypass or Hot Gas Bypass Circuit	If unit is shutdown repair immediately. Otherwise, report alarm at end of day.		X		
46	Check Air Flow	If unit is shut down repair immediately. Otherwise, report alarm at end of the day. Cargo may be restricting air flow, check load.		X		
48	Check Belts/Clutch	If unit is shutdown, repair immediately. Otherwise, report alarm at end of day.				X
50	Reset Clock	Report alarm at end of day.	X			

Table of Alarm Codes

NOTE: Not all alarm codes are available with all microprocessor controllers or all revisions of software.

Code	Description	Corrective Action	Level Of Action			
			Ok To Run	Check	Shut Down	
52	Heat Circuit	If unit is shutdown, repair immediately. Otherwise, report alarm at end of day.		X		
54	Test Mode Time-out	Service Test or Interface Board Test time out after 15 minutes. Report alarm at end of day.	X			
61	Low Battery Voltage	If unit is shutdown, repair immediately. Otherwise, report alarm at end of day.		X		
62	Ammeter Out of Calibration	If unit is shutdown, repair immediately. Otherwise, report alarm at end of day.				X
63	Engine Stopped	If unit is shutdown, repair immediately. Otherwise, report alarm at end of day.				X
64	Pretrip Reminder	Report alarm at end of day.	X			
65	Abnormal Temperature Differential	If unit is shutdown, repair immediately. Otherwise, report alarm at end of day		X		

Alarm Codes

Table of Alarm Codes

NOTE: Not all alarm codes are available with all microprocessor controllers or all revisions of software.

Code	Description	Corrective Action	Level Of Action		
			Ok To Run	Check	Shut Down
66	Low Engine Oil Level	Check engine oil level. If unit is shutdown, repair immediately. Otherwise, report alarm at end of day.			X
67	Liquid Line Solenoid Circuit	If unit is shutdown, repair immediately. Otherwise, report alarm at end of day.			X
68	Internal Controller Fault	Report alarm at end of day.	X		
70	Hourmeter Failure	Report alarm at end of day.	X		
74	Controller Reset to Defaults	Report alarm at end of day.	X		
77	Controller EPROM Checksum Failure	If unit is shutdown, repair immediately. Otherwise, report alarm at end of day.			X
79	Internal Data Logger Overflow	Report alarm at end of day.	X		
80	Compressor Temp Sensor	Report alarm at end of day.	X		
81	High Compressor Temp	If unit is shutdown repair immediately. Otherwise, report alarm at end of day.			X

Table of Alarm Codes

NOTE: Not all alarm codes are available with all microprocessor controllers or all revisions of software.

Code	Description	Corrective Action	Level Of Action			
			Ok To Run	Check	Shut Down	
82	High Compressor Temperature Shutdown	If unit is shutdown repair immediately. Otherwise, report alarm at end of day.			X	
83	Low Engine Coolant Temperature	If unit is shutdown repair immediately. Otherwise, report alarm at end of day.			X	
84	Restart Null	Report alarm at end of day.		X		
85	Forced Unit Operation	Report alarm at end of day.		X		
86	Discharge Pressure Sensor	Report alarm at end of day.		X		
87	Suction Pressure Sensor	Report alarm at end of day.		X		
89	Check Electronic Throttling Valve Circuit	If unit is shutdown repair immediately. Otherwise, report alarm at end of day.		X		
90	Electric Overload	If unit is shutdown, repair immediately. Otherwise, report alarm at end of day.			X	

Alarm Codes

Table of Alarm Codes

NOTE: Not all alarm codes are available with all microprocessor controllers or all revisions of software.

Code	Description	Corrective Action	Level Of Action		
			Ok To Run	Check	Shut Down
91	Electric Ready Input	If unit is shutdown, repair immediately. Otherwise, report alarm at end of day.			X
92	Sensor Grades Not Set	Report alarm at end of day.		X	
93	Low Compressor Suction Pressure	If unit is shutdown, repair immediately. Otherwise, report alarm at end of day.			X
94	Loader #1 Circuit	If unit is shutdown, repair immediately. Otherwise, report alarm at end of day.		X	
95	Loader #2 Circuit	If unit is shutdown, repair immediately. Otherwise, report alarm at end of day.		X	
96	Low Fuel Level	Check engine fuel level and add fuel. If unit is shutdown, repair immediately. Otherwise, report alarm at end of day.		X	
98	Fuel Level Sensor	Report alarm at end of day.	X		

Table of Alarm Codes

NOTE: Not all alarm codes are available with all microprocessor controllers or all revisions of software.

Code	Description	Corrective Action	Level Of Action			
			Ok To Run	Check	Shut Down	
99	High Compressor Pressure Ratio	If unit is shutdown, repair immediately. Otherwise, report alarm at end of day.			X	
108	Door Open Time-out	Close Doors. Report alarm at end of day.		X		
111	Unit Not Configured Correctly	Report alarm at end of day.	X			
113	Electric Heat Circuit	If unit is shutdown, repair immediately. Otherwise, report alarm at end of day.		X		
114	Multiple Alarms - Cannot Run	If unit is shutdown repair immediately. Otherwise, report alarm at end of day.			X	
117	Auto switch from Diesel to Electric	Report alarm at end of day.	X			
118	Auto switch from Electric to Diesel	Report alarm at end of day.	X			

Alarm Codes

Table of Alarm Codes

NOTE: Not all alarm codes are available with all microprocessor controllers or all revisions of software.

Code	Description	Corrective Action	Level Of Action		
			Ok To Run	Check	Shut Down
120	Alternator Exciter Circuit	If unit is shutdown, repair immediately. Otherwise, report alarm at end of day.		X	
121	Liquid Injection Circuit	If unit is shutdown, repair immediately. Otherwise report alarm at end of day.		X	
122	Diesel/Electric Relay Circuit	If unit is shutdown, repair immediately. Otherwise, report at end of day.		X	
127	Setpoint Not Entered	Be sure the setpoint is set to the required temperature.		X	
128	Engine Run Time Maintenance Reminder #1	Report alarm at end of day.	X		
129	Engine Run Time Maintenance Reminder #2	Report alarm at end of day.	X		
130	Electric Run Time Maintenance Reminder #1	Report alarm at end of day.	X		

Table of Alarm Codes

NOTE: Not all alarm codes are available with all microprocessor controllers or all revisions of software.

Code	Description	Corrective Action	Level Of Action				
			Ok To Run	Check	Shut Down		
131	Electric Run Time Maintenance Reminder #2	Report alarm at end of day.	X				
132	Total Unit Run Time Maintenance Reminder #1	Report alarm at end of day.	X				
133	Total Unit Run Time Maintenance Reminder #2	Report alarm at end of day.	X				
134	Controller Power On Hours	Report alarm at end of day.	X				
135	Check Spare Digital Inputs	Report alarm at end of day.	X				
136	Check Spare Digital Outputs	Report alarm at end of day.	X				
137	Check Damper Motor Heater Output	Report alarm at end of day.	X				
141	Autoswitch Diesel to Electric Disabled	Report alarm at end of the day.	X				

Alarm Codes

Table of Alarm Codes

NOTE: Not all alarm codes are available with all microprocessor controllers or all revisions of software.

Code	Description	Corrective Action	Level Of Action			
			Ok To Run	Check	Shut Down	
145	Loss of Controller "On" Feedback Signal	If unit is shut down repair immediately. Otherwise, report alarm at end of the day.		X		
146	Software Version Mismatch	If unit is shut down repair immediately. Otherwise, report alarm at end of the day.		X		
148	Autoswitch Electric to Diesel Disabled	Report alarm at end of the day.	X			
149	Alarm Not Identified	If unit is shut down repair immediately. Otherwise, report alarm at end of the day.		X		
150	Out of Range Low	Manually monitor load temperature. Report alarm at end of the day.	X			
151	Out of Range High	Manually monitor load temperature. Report alarm at end of the day.	X			
157	OptiSet Plus Mismatch	Manually monitor load temperature. Report alarm at the end of the day		X		

Table of Alarm Codes

NOTE: Not all alarm codes are available with all microprocessor controllers or all revisions of software.

Code	Description	Corrective Action	Level Of Action			
			Ok To Run	Check	Shut Down	
203	Display Return Air Sensor	Manually monitor load temperature with independent thermometer. Report alarm at end of day.		X		
204	Display Discharge Air Sensor	Manually monitor load temperature with independent thermometer. Report alarm at end of day.		X		
252	Check Fresh Air Exchange Circuit	If unit is shutdown, repair immediately. Otherwise, report alarm at end of day.		X		

Jump Starting

If the battery in a unit is discharged or run down, the unit may be jump started using jumper cables and another battery or vehicle. Consider the following precautions and be careful when jump starting a unit.



WARNING: A battery can be dangerous. A battery contains a flammable gas that can ignite or explode. A battery stores enough electricity to burn you if it discharges quickly. A battery contains battery acid that can burn you. Always wear goggles or safety glasses and personal protective equipment when working with a battery. If you get battery acid on you, immediately flush it with water and get medical attention.



CAUTION: Unhook the semi tractor from the trailer before using the tractor to jump start the unit on the trailer. The negative ground circuit is complete when the tractor is hooked to the trailer. This can cause dangerous sparks when the positive connection is made at the battery.

IMPORTANT: Make sure to use a 12-volt battery to jump start the unit. If you are using a vehicle, make sure it has a 12-volt battery with a negative ground system. Do not use a “hot shot” booster device or a 24-volt source.

Read and understand the following procedure completely before connecting any jumper cables. Use good jumper cables made with #2 gauge (or larger) cables.

1. Make sure the unit is turned off. If you are using a vehicle, make sure its ignition is also turned off.
2. Open the front doors on the unit. The battery is located to the right of the engine.
3. Check the discharged battery to make sure it is not damaged or frozen. Do not jump start a damaged or frozen battery. Check the vent caps to make sure they are tight.
4. Identify the positive (+) and negative (-) battery terminals.

Jump Starting



CAUTION: Do not use a match or lighter as a light near the battery. Use a flashlight. A flame or a spark can ignite the gas in the battery and cause it to explode.

5. Remove the red cover from the positive (+) battery terminal on the unit's battery.

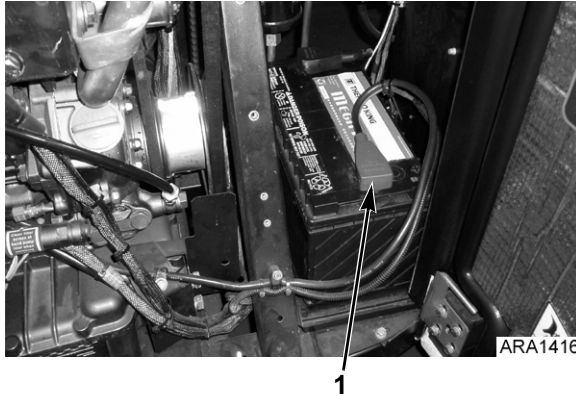

1.	Red Cover on Positive (+) Battery Terminal
----	--

Figure 133: Unit Battery

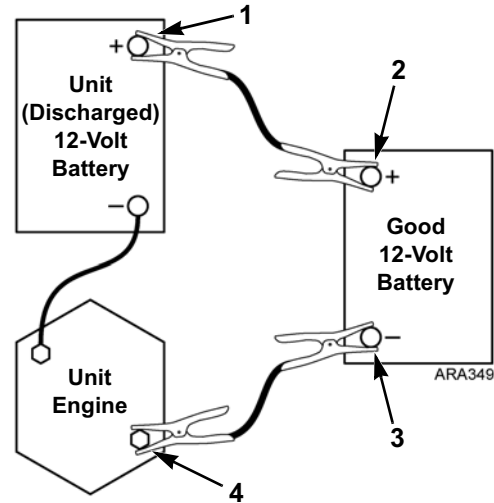

1.	Positive (+) Terminal on Unit Battery
2.	Positive (+) Terminal on Good Battery
3.	Negative (-) Terminal on Good Battery
4.	Starter Mounting Bolt on Unit Engine

Figure 134: Sequence for Connecting Jumper Cables

Jump Starting

6. Connect the red positive (+) jumper cable to the positive (+) battery terminal on the unit's battery. Do not let the other end of the jumper cable touch anything that conducts electricity.



CAUTION: *Allowing the positive (+) jumper cable to short can produce dangerous sparks.*

7. Connect the other end of the red positive (+) jumper cable to the positive (+) battery terminal on the good battery.
8. Connect the black negative (-) jumper cable to the negative (-) battery terminal on the good battery. Do not let the other end of the jumper cable touch anything that conducts electricity.
9. Connect the black negative (-) jumper cable to the lower starter mounting bolt on the unit's engine.

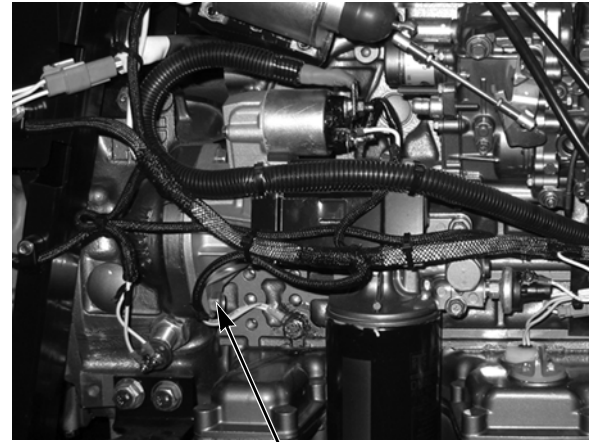

1

1.	Lower Starter Mounting Bolt
----	-----------------------------

Figure 135: Unit Engine

Jump Starting

10. If you are using a vehicle to jump start the unit, start the vehicle and let it run for a few minutes. This will help charge the discharged battery.



CAUTION: *Be careful around fans and belts. Keep your hands away from moving parts when an engine is running.*

11. Turn the unit on and let it start automatically or start it manually. If the unit will not crank or start, contact a qualified technician.

NOTE: *Some units with microprocessors will show an alarm code and will not try to start until the battery voltage is above 10 volts.*

12. After the unit starts, remove the jumper cables in reverse order: black negative (–) from the unit starter mounting bolt, black negative (–) from the good battery, red positive (+) from the good battery, and red positive (+) from the unit battery (that was discharged).

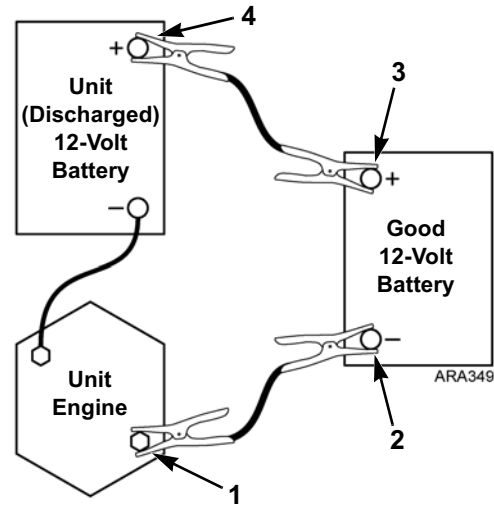

1.	Starter Mounting Bolt on Unit Engine
2.	Negative (–) Terminal on Good Battery
3.	Positive (+) Terminal on Good Battery
4.	Positive (+) Terminal on Unit Battery

Figure 136: Sequence for Disconnecting Jumper Cables

Specifications

Engine

Model:	SB-130 and SB-230 SB-330	TK486V (Tier 2) TK486VH (Tier 2)
Number of Cylinders		4
Cylinder Arrangement		In-line vertical, number 1 on flywheel end
Firing Order		1-3-4-2
Direction of Rotation		Counterclockwise viewed from flywheel end
Fuel Type		No. 2 diesel fuel under normal conditions No. 1 diesel fuel is acceptable cold weather fuel
Oil Capacity		13 quarts (12.3 liters) crankcase and oil filter Fill to full mark on dipstick
Oil Type		API Classification CI-4 or better (ACEA Rating E3 or better for Europe)

Specifications

Engine

Oil Viscosity	14 F to 122 F (-10 C to 50 C): SAE 15W-40 (Synthetic) 5 to 104 F (-15 to 40 C): SAE 15W-40 -13 to 104 F (-25 to 40 C): SAE 10W-40 -13 to 86 F (-25 to 30 C): SAE 10W-30 -22 to 122 F (-30 to 50 C): SAE 5W-40 (Synthetic) Below -22 F (-30 C): SAE 0W-30 (Synthetic)
Engine rpm: SB-130 and SB-230 Low Speed Operation SB-130 and SB-230 High Speed Operation SB-330 Low Speed Operation SB-330 High Speed Operation	1450 ± 25 rpm 2200 ± 25 rpm 1450 ± 25 rpm (1720 ± 25 rpm with High Capacity Fresh Option) 2600 ± 25 rpm
Engine Oil Pressure	The microprocessor will display OK if the oil pressure is within the acceptable range and LOW if the oil pressure is below the acceptable range.
Low Oil Pressure Switch (Normally Closed)	17 ± 3 psi (117 ± 21 kPa)
Engine Coolant Thermostat	160 F (71 C)

Specifications

Engine

Engine Coolant Type	ELC (Extended Life Coolant), which is “RED” Use a 50/50 concentration of any of the following equivalents: Chevron Dex-Cool Texaco ELC Havoline Dex-Cool® Havoline XLC for Europe Shell Dexcool® Shell Rotella Saturn/General Motors Dex-Cool® Caterpillar ELC Detroit Diesel POWERCOOL® Plus <i>CAUTION: Do not add “GREEN” or “BLUE-GREEN” conventional coolant to cooling systems using “RED” Extended Life Coolant, except in an emergency. If conventional coolant is added to Extended Life Coolant, the coolant must be changed after 2 years instead of 5 years.</i>
Coolant System Capacity	7.5 quarts (7.1 liters)
Radiator Cap Pressure	7 psi (48 kPa)

Specifications

Engine

Drive:	Model 30	Direct to compressor; belts to fans, alternator, and water pump
	Model 50	Centrifugal clutch to compressor; belts to electric standby motor, fans, alternator, and water pump

Belt Tension

Model 30	Tension No. on TK Gauge P/N 204-427	
	New Belt	Field Reset
Alternator Belt:		
SB-130 and SB-230 with 37 Amp Alternator	74	71
SB-130 and SB-230 with 65 Amp Alternator	75	72
SB-330 with 37 Amp Alternator	73	70
SB-330 with 65 Amp Alternator	74	71
Lower Fan Belt (Engine to Idler):		
SB-130 and SB-230	88	84
SB-330	87	84
Upper Fan Belt (Fan to Idler)	88	85

Specifications

Belt Tension

Model 50 (SB-230 Only)			
Alternator Belt:			
14 HP Electric Motor and 37 Amp Alternator		76	73
14 HP Electric Motor and 65 Amp Alternator		77	74
24 HP Electric Motor and 37 Amp Alternator		74	71
24 HP Electric Motor and 65 Amp Alternator		75	72
Compressor Drive Belts		94	91
Fan Belt:	14 HP Electric Motor	91	88
	24 HP Electric Motor	90	86
Water Pump Belt		74	71

Refrigeration System

Compressor:	SB-130 SB-230 and SB-330	Thermo King X426LSC5 Thermo King X430LSC5
Refrigerant Charge—Type:	SB-130 and SB-230 SB-330	13 lb (5.9 kg)—R404A 16 lb (7.3 kg)—R404A
Compressor Oil Charge		4.3 qt (4.1 liters)*
Compressor Oil Type		Polyol Ester type P/N 203-513
Heat/Defrost Method:	Engine Operation Electric Operation	Hot gas Hot gas and electric heater strips
<p>* When the compressor is removed from the unit, oil level should be noted or the oil removed from the compressor should be measured so that the same amount of oil can be added before placing the replacement compressor in the unit.</p>		

Specifications

Electrical Control System

Voltage	12.5 Vdc
Battery	One, group C31, 12 volt, (950 CCA recommended for operation below -15 F [-26 C])
Fuses	See "Fuses" on page 85.
Battery Charging	12 volt, 37 amp, brush type, Thermo King Alternator (65 amp alternator optional)
Voltage Regulator Setting	13.95 to 14.35 volts @ 77 F (25 C)
<i>NOTE: Fuse F4 (Bypass resistor for Prestolite Alternator) must be removed for the Thermo King Alternator. Thermo King Alternators are painted black.</i>	

Electrical Standby (Model 50 Units Only)

Electric Motor and Overload Relay

Voltage/Phase/Frequency	Horsepower	Kilowatts	rpm	Full Load (amps)	Overload Relay Setting (amps)
230/3/60	14.0	10.4	1755	37.8	38
460/3/60	14.0	10.4	1755	18.9	20
460/3/60	24.0	17.9	3500	29	31

Electric Heater Strips

Number	3
Watts	1000 watts (each)
Resistance	48 ohms (each)

Specifications

Standby Power Cord Requirements

Supply Circuit Breaker: 14 HP Motor 230/3/60	70 amps
14 HP Motor 460/3/60	40 amps
24 HP Motor 460/3/60	60 amps
Extension Cord Size: 14 HP Motor 230/3/60	8 AWG Power Cable, 25 to 50-foot length
14 HP Motor 230/3/60	6 AWG Power Cable, 75-foot length
14 HP Motor 460/3/60	10 AWG Power Cable, up to 75-foot length
24 HP Motor 460/3/60	8 AWG, 4-Conductor, 2000V, Type W Power Cable, up to 75-foot length

Specifications

Electric Fuel Heater (Optional)

Electric Fuel Heater:	Resistance	0.9 to 1.1 ohms
	Current Draw at 12.5 Vdc	11.4 to 13.9 amps
Internal Thermostat Minimum Closing Temp.		30 F (-1 C)
Internal Thermostat Maximum Opening Temp.		75 F (24 C)
W Fuse		3 amps
Diesel Power Fuse		3 amps
2A/2FH Circuit Breaker		20 amps, manual reset

Warranty

Terms of the Thermo King Warranty are available on request. Please reference document TK 50046 for the Thermo King Trailer Unit Warranty.

See the “EPA Emission Control System Warranty Statement” chapter earlier in this manual for the EPA Emission Control System Warranty.

Warranty

Glossary

This glossary is published for informational purposes only and the information being furnished herein should not be considered as all-inclusive or meant to cover all contingencies.

NOTE: *Additional terms not found in the glossary may be located in the index section of this manual.*

accumulator: A device located in the suction line to collect liquid refrigerant and meter it safely back to the compressor as gas.

ambient air temperature: Temperature of the air surrounding an object.

amp: Abbreviation for ampere. The basic measuring unit of electrical current.

bar: A metric unit of pressure. 1 bar = 100 kPa = 14.5 psi.

Battery Sentry: Part of the CYCLE-SENTRY™ system. The Battery Sentry module monitors alternator charge rate and will keep the unit running until the battery is adequately charged.

box temperature: The temperature within a temperature-controlled compartment.

Btu (british thermal unit): The quantity of heat required to raise the temperature of one pound of water by one degree Fahrenheit. 1 Btu = 252 calories.

bulkhead: 1) *return air bulkhead.* A metal or plastic “wall” placed at the front of the box to prevent loading of product tightly against the Thermo King unit. (Loading too close to the unit restricts air flow and system efficiency.) 2) *bulkhead divider.* A thick, insulated “wall” used to separate compartments of a multi-temperature truck or trailer.

calorie: The amount of heat required to raise temperature of one gram of water one degree Celsius. 1 calorie = 0.004 Btu.

Celsius: The metric unit of temperature measurement. The preferred alternate to the term centigrade. Abbreviated “C.”

centigrade. See *Celsius*.

Glossary

CFC: Chlorofluorocarbon. A chlorine-based refrigerant consisting of chlorine, fluorine and carbon. Example: R12. In many countries it is illegal to release this type of refrigerant to the atmosphere because chlorine damages the earth's atmosphere. CFC refrigerants are not used in modern Thermo King units.

circuit breaker: A thermal device that automatically interrupts an electrical circuit when the current in the circuit exceeds the predetermined amperage rating of the breaker. See *amp*.

coil: A cooling or heating element made of pipe or tube, formed into a helical or serpentine shape, that may be equipped with thin metal fins to aid heat transfer.

cold curtains: Flexible vinyl curtains used to reduce air exchange between the refrigerated compartment and the outside during door openings.

compound gauge: A gauge calibrated in psig (or kPa) to measure pressure, and in inches of mercury (Kg/cm²) to measure vacuum.

compressor: The refrigeration component that compresses refrigerant vapor and creates refrigerant flow.

condenser: An arrangement of tubing in which the vaporized and compressed refrigerant is liquefied as heat is removed.

cycles per second: See *Hertz*.

damper door: A door on the evaporator section that closes during defrost to prevent hot air from entering the refrigerated cargo compartment.

data logger: An electronic device that monitors and stores unit operating and temperature data for later review. Examples: DMS, DAS, DRS and AccuTrac.

DE: Dual Evaporator. A multi-temp host unit with two evaporators capable of refrigerating two separate, longitudinal compartments.

defrost: The removal of accumulated ice from an evaporator coil. Periodic defrost is necessary when the evaporator coil is operating below freezing. Defrost is required more frequently when the air passing through the evaporator has a high moisture content.

defrost termination switch: A component that terminates defrost operation at a specific temperature.

Glossary

defrost timer: A solid state module that initiates defrost at selected intervals. Also establishes a maximum defrost duration if normal circuits malfunction.

dehydrator: A device used to remove moisture from refrigerant. Also called a drier.

discharge air temperature: The temperature of air leaving the evaporator.

drier: See *dehydrator*.

ECT: A ceiling-mounted Thermo King remote evaporator. See *EW* and *TLE*.

ERC: Extended Remote Unit Control. (Door switches) An option on Thermo King multi-temperature units to improve temperature control when doors are opened during delivery. When a compartment door is opened, the refrigeration unit for that compartment may be forced to NULL, defrost, or some other mode. Opening a compartment door may also affect the operating mode of other compartments. ERC systems are connected in a variety of ways to meet customer needs.

ETV (Electronic Throttling Valve) : A device used with a microprocessor to precisely control the refrigeration system.

evaporator: The part of the refrigeration system that absorbs heat during the cooling cycle.

EW: A wall-mounted Thermo King remote evaporator. See *ECT* and *TLE*.

F: See *Fahrenheit*.

Fahrenheit: A unit of temperature measurement used in the United States. Abbreviated “F.”

freeze up: 1) Failure of a refrigeration system to operate normally due to moisture in the refrigerant and the formation of ice at the expansion valve. The expansion valve may be frozen shut or open, causing improper unit operation in either case. 2) The formation of a solid ice mass over the evaporator coil reducing air flow.

fuse: An electrical safety device (typically a cartridge) inserted into an electrical circuit. It contains material that will melt or break when the current is increased beyond a specific value. When this occurs, the circuit is opened and electrical current flow is stopped.

Glossary

fusible link: An electrical safety device (typically a short piece of wire) inserted into an electrical circuit. The wire melts or breaks when the current is increased beyond a specific value. When this occurs, the circuit is opened and electrical current flow is stopped.

HCFC: Hydrochlorofluorocarbon. A chlorine-based refrigerant containing hydrogen, chlorine, fluorine and carbon. Example: R22. Because chlorine damages the earth's atmosphere, in many countries, it is illegal to release this type of refrigerant to the atmosphere. HCFC refrigerants are not used in modern Thermo King units.

Hertz: A unit of frequency equal to one cycle per second. Abbreviated "Hz."

HFC: A refrigerant consisting of hydrogen, fluorine and carbon. Examples: R134a and 404A. HFC refrigerants contain no chlorine and are, therefore, considered "safe" for the environment.

high pressure relief valve: A safety valve on the refrigeration system that allows refrigerant to escape from the system if pressure exceeds a predetermined value.

hp (horsepower): A unit of power equivalent to 746 watts or 550 foot-pounds per second.

HPCO (High Pressure Cut Out Switch): A pressure-operated switch that opens to stop unit operation when discharge pressure reaches a predetermined maximum.

invertible: A multi-temperature truck or trailer unit designed to allow the placement of deep-frozen cargo in any compartment. See *Multi-Temp*.

kPa: Kilopascals. A metric unit of pressure. 1 kPa = 0.01 bar = 0.145 psi.

load: 1) The product being refrigerated and transported.
2) The amount of heat being removed by the refrigeration system. (For example, a compressor is under a heavy heat load when expected to cool a very warm box.)

LPCO (Low Pressure Cut Out Switch): A pressure-operated switch that opens to stop unit operation when suction pressure reaches a predetermined minimum.

modulation: An optional system that reduces load (product) dehydration and avoids "top freeze."

Glossary

movable bulkhead: A thick, insulated, portable wall-like device used to compartmentalize a temperature-controlled truck or trailer. See *bulkhead*.

Multi-Temp: A Thermo King truck or trailer unit capable of maintaining different set-points in multiple compartments.

no. 1 diesel fuel: A grade of diesel fuel formulated to prevent “jelling” in low ambient temperatures.

no. 2 diesel fuel: A grade of diesel fuel formulated for moderate to warm ambient temperatures.

ohm: An electrical unit measuring the amount of resistance (opposition to the current flow) in an electrical circuit.

pre-cooling: 1) To cool down an empty box (temperature-controlled area) to the desired load temperature prior to loading. 2) To cool cargo to a desired temperature before loading.

pre-heat: The heating of diesel engine glow plugs prior to start-up. Some engines use an intake manifold heater rather than glow plugs.

pre-trip inspection: Checking the operation of a refrigeration system before loading.

psi: Pounds per square inch. A unit of pressure.
1 psi = 0.069 bar = 6.89 kPa.

psig: Pounds per Square Inch Gauge. Pressure in pounds per square inch as displayed by a gauge calibrated to zero when open to the atmosphere.

receiver tank: A refrigerant storage device included in nearly all Thermo King units.

refrigerant: The medium of heat transfer in a refrigeration system which absorbs heat by evaporating at a low temperature and releases heat by condensing at a higher temperature.

refrigerant oil: A special oil used to lubricate compressors in refrigeration systems.

remote evaporator: A separate evaporator unit located in a second or third compartment of a multi-temperature truck or trailer unit.

return air bulkhead: A structure (metal or plastic) mounted in the front of a trailer and designed to prevent restriction of return air flow to the Thermo King unit due to improper loading. See *bulkhead*.

Glossary

return air temperature: The temperature of the air returning to the evaporator. See box temperature.

rpm: Revolutions per minute.

setpoint: The temperature selected on a thermostat or microprocessor controller. This is normally the desired box temperature.

short cycling: When a refrigeration unit cycles between the heat and cool modes more often than normal.

sight glass: A system component that permits visual inspection of oil or refrigerant level and condition.

thermostat: A device that controls unit modes of operation to maintain a selected box temperature.

TLE: Thin-line evaporator. A Thermo King remote evaporator designed to be compact (thin) while supplying superior air flow. See *ECT* and *EW*.

top freeze: When the top portion of perishable cargo is damaged by freezing temperatures discharged from the refrigeration unit. This may occur near the front of the box when product is placed too close to the cold, discharge air flow.

Vac (volts alternating current): An electric current that reverses direction at regularly recurring intervals.

Vdc (volts direct current): An electric current that flows in one direction only and is constant in value.

volts: The basic measuring unit of electrical potential.

watt: The basic measuring unit of electrical power.

Maintenance Inspection Schedule

Pretrip	Every 1,500 Hours	Every 3,000 Hours*	Annual/4 ,500 Hours	Inspect/Service These Items
				Microprocessor
•				Run Pretrip Test (see Pretrip Test in this manual).
				Engine
•				Check fuel supply.
•				Check engine oil level.
•	•	•	•	Inspect/clean fuel pre-strainer.
•	•	•	•	Inspect belts for condition and proper tension (belt tension tool No. 204-427).
•	•	•	•	Check engine oil pressure hot, on high speed (should display “OK”).
•	•	•	•	Listen for unusual noises, vibrations, etc.
•	•	•	•	Check engine coolant level and antifreeze protection (-30 F [-40 C]).
<p>*3,000 hours or two years, whichever occurs first. ** Based on EPA 40 CFR Part 89.</p>				

Maintenance Inspection Schedule

Pretrip	Every 1,500 Hours	Every 3,000 Hours*	Annual/4 ,500 Hours	Inspect/Service These Items
•	• • • •	• • • • • •	• • • • —	<p>Check air cleaner restriction indicator (change filter when indicator reaches 25 in.). Replace EMI 3000 air cleaner element at 3,000 hours or two years (whichever occurs first) if indicator has not reached 25 in.</p> <p>• Drain water from fuel tank and check vent.</p> <p>• Inspect/clean fuel transfer pump inlet strainer (prefilter).</p> <p>• Check and adjust engine speeds (high and low speed).</p> <p>• Check condition of drive coupling bushings per Service Bulletin T&T 171.</p> <p>• Check engine mounts for wear.</p> <p>• Replace fuel filter/water separator.</p> <p>• Change engine oil and oil filter (hot). Requires oil with API Rating CI-4 or better (ACEA Rating E3 for Europe).</p> <p>— Change ELC (red) engine coolant every 5 years or 12,000 hours. Units equipped with ELC have an ELC nameplate on the expansion tank.</p> <p>• Test fuel injection nozzles at least every 3,000 hours. **</p>
<p>*3,000 hours or two years, whichever occurs first.</p> <p>** Based on EPA 40 CFR Part 89.</p>				

Maintenance Inspection Schedule

Pretrip	Every 1,500 Hours	Every 3,000 Hours*	Annual/4,500 Hours	Inspect/Service These Items
			—	Replace fuel return lines between fuel injection nozzles every 10,000 hours.
				Electrical
•	• • •	• • •	• • •	Inspect battery terminals and electrolyte level. Inspect wire harness for damaged wires or connections. Check operation of damper door (closes on defrost initiation and opens on defrost termination).
			• •	Inspect alternator wire connections for tightness. Inspect electric motor, replace bearings yearly or every 6,000 hours.
<p>*3,000 hours or two years, whichever occurs first. ** Based on EPA 40 CFR Part 89.</p>				

Maintenance Inspection Schedule

Pretrip	Every 1,500 Hours	Every 3,000 Hours*	Annual/4 ,500 Hours	Inspect/Service These Items
				Refrigeration
•	• • • •	• • • •	• • • • —	<ul style="list-style-type: none"> Check refrigerant level. Check for proper suction pressure. Check compressor oil level and condition. Check throttling valve regulating pressure (units with mechanical throttling valve only). Check compressor efficiency and pump down refrigeration system. Empty oil collection container mounted on compressor (if so equipped). Replace dehydrator and check discharge and suction pressure every two (2) years.
<p>*3,000 hours or two years, whichever occurs first. ** Based on EPA 40 CFR Part 89.</p>				

Maintenance Inspection Schedule

Pretrip	Every 1,500 Hours	Every 3,000 Hours*	Annual/4,500 Hours	Inspect/Service These Items
				Structural
•	•	•	•	Visually inspect unit for fluid leaks.
•	•	•	•	Visually inspect unit for damaged, loose or broken parts (includes air ducts and bulkheads).
	•	•	•	Inspect tapered roller bearing fanshaft and idlers for leakage and bearing wear (noise).
	•	•	•	Clean entire unit including condenser and evaporator coils and defrost drains.
	•	•	•	Check all unit and fuel tank mounting bolts, brackets, lines, hoses, etc.
	•	•	•	Check evaporator damper door adjustment and operation.
<p>*3,000 hours or two years, whichever occurs first. ** Based on EPA 40 CFR Part 89.</p>				

Maintenance Inspection Schedule

Serial Number Locations

Unit: Nameplates on the bulkhead above the compressor inside the curbside door and on the roadside of the evaporator.

Engine: See the engine identification plate located on the engine valve cover.

Compressor: Stamped between the cylinders on the front end above the oil pump.

Serial Number Locations

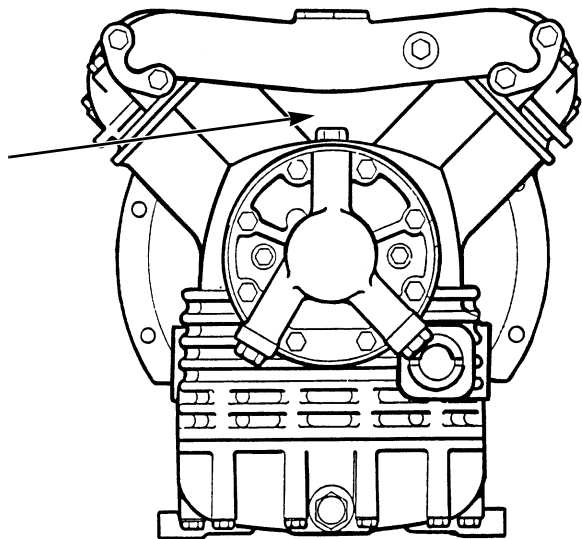

Figure 137: Compressor Serial Number Location

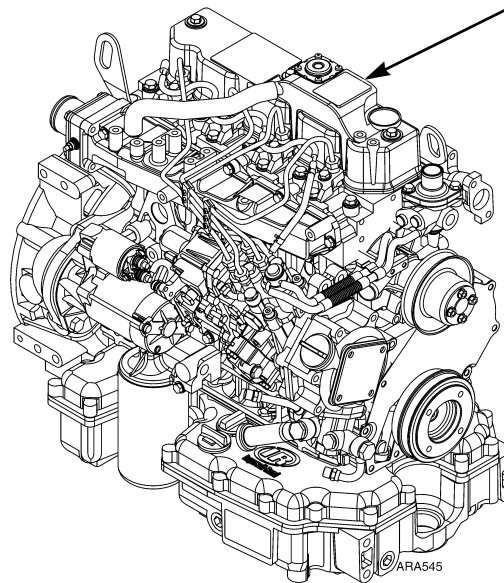
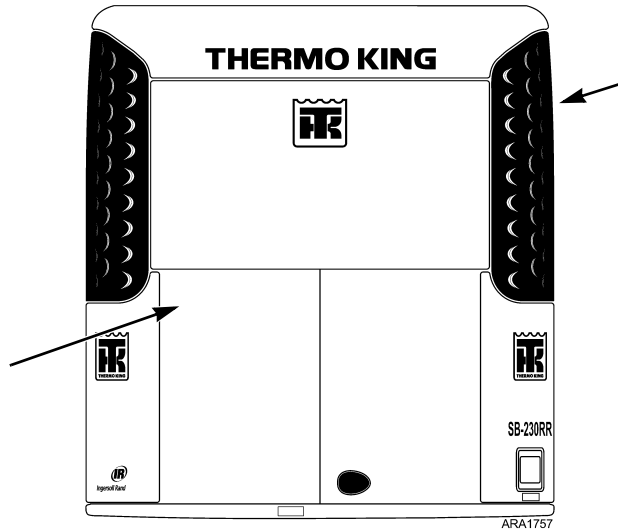
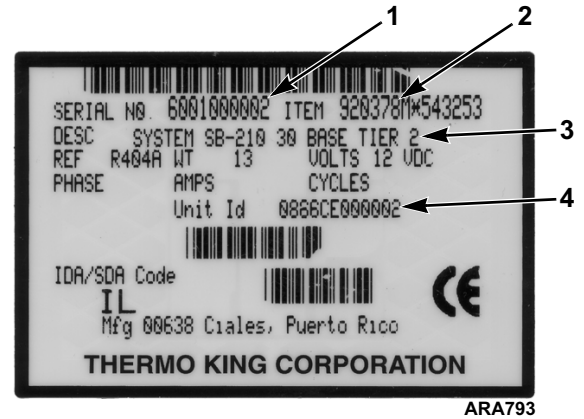

Figure 138: Engine Serial Number Location

Serial Number Locations



**Figure 139: Unit Serial Number Plate Locations
(on the bulkhead above compressor inside curbside door and on roadside of evaporator)**



1.	Unit Serial Number
2.	Bill of Material Number
3.	Unit Model
4.	Unit ID

Figure 140: Unit Serial Number Plate

Serial Number Locations

Emergency Cold Line

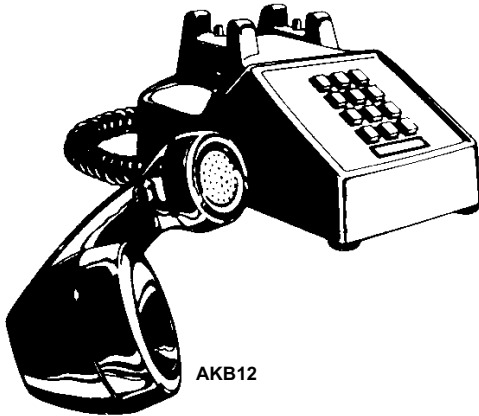

If you can't get your rig rolling, and you have tried the Thermo King North American Service Directory (available from any Thermo King dealer) to reach a dealer without success, *then* call the Toll Free Emergency Cold Line Number (888) 887-2202.

The answering service at the factory will assist you in reaching a dealer to get the help you need. The Cold Line is answered 24 hours a day by personnel who will do their best to get you quick service at an authorized Thermo King Dealer.

Recover Refrigerant

At Thermo King, we recognize the need to preserve the environment and limit the potential harm to the ozone layer that can result from allowing refrigerant to escape into the atmosphere.

We strictly adhere to a policy that promotes the recovery and limits the loss of refrigerant into the atmosphere.

In addition, service personnel must be aware of Federal regulations concerning the use of refrigerants and the certification of technicians. For additional information on regulations and technician certification programs, contact your local THERMO KING dealer.

CALIFORNIA Proposition 65 Warning

**Diesel exhaust is a chemical known to
the State of California to cause cancer.**

Index

A

adjust brightness menu	128
air cleaner restriction indicator	39
alarm codes	167
corrective action	170
types	167
amber status light	46
automatic start/stop safety precautions	20

B

battery inspection	49
belt tension, specifications	194
belts inspection	49

C

coils inspection	50
compressor oil sight glass	39
continuous mode	
selecting	78
continuous run operation	32
control panel	53

display	53
---------	----

keys	54
------	----

CYCLE-SENTRY

selecting	78
-----------	----

start-stop controls	33
---------------------	----

D

damper inspection	50
-------------------	----

data logging	34
--------------	----

datalogger menu	101
-----------------	-----

defrost	36
---------	----

defrost drain inspection	50
--------------------------	----

Defrost key	54
-------------	----

diesel mode, selecting	126
------------------------	-----

door inspection	50
-----------------	----

E

ELC (extended life coolant)	30
-----------------------------	----

electric power receptacle	68
---------------------------	----

electric standby	
------------------	--

operation	68
-----------	----

selecting	126
starting unit on	69
electrical control system, specifications	197
electrical hazards	20
electrical inspection	49
electrical standby, specifications	198
electronic throttling valve (ETV)	31
Emergency Cold Line	219
EMI 3000	30
engine compartment components	39
engine coolant level	49
engine oil dipstick	39
engine oil level	49
engine, specifications	191
enroute inspections	164
ETV (electronic throttling valve)	31
extended life coolant (ELC)	30
F	
first aid for refrigerant	21
first aid for refrigerant oil	21
FreshSet	35
front doors	
closing	38

opening	37
fuel level	49
fuse link	40
fuses	41
G	
gauge readings, viewing	84
H	
high pressure cutout switch	40
high pressure relief valve	40
HMI control panel	53
hourmeters menu	107
I	
introduction	13
J	
jump starting	187
K	
keypad lockout	110
selecting	114

L	
language menu	94
loading procedures	
enroute inspections	164
post-loading inspection	163
pre-loading inspection	161
low oil level switch	40
low oil pressure switch	40
M	
main menu	
choices	92
navigating	91
maintenance inspection schedule	209
manual defrost cycle, initiating	81
manual pretrip inspection	49
microprocessor On/Off switch	52
Mode key	54
mode menu	110

O	
Off key	54
On key	54
OptiSet Plus	35, 132
overload relay	41
P	
post-loading inspection	163
preheat buzzer	41
pre-loading inspection	161
pretrip inspection, manual	49
pretrip tests	120
protection devices	40
R	
rear remote control panel	145
receiver tank sight glass	40
refrigerant oil safety	21
refrigerant safety	20
refrigeration system, specifications	196
remote status light	45

S	
safety precautions	19
automatic start/stop operation	20
decals locations	22
electrical hazards	20
first aid for refrigerant	21
first aid for refrigerant oil	21
general safety practices	19
refrigerant	20
refrigerant oil	21
selection of operating modes	77
sensor readings, viewing	87
Serial Number Locations	215
setpoint, changing	74
sleep mode	110
sleep mode, selecting	116
smart FETs	41
SMART REEFER 3 (SR-3) Controller	32, 51
soft keys	55
specifications	
electric fuel heater	200
SR-3 Controller	32, 51
standard display	60, 62
start of trip, initiating	101

status light, remote	45
structural inspection	49

T	
temperature watch display	64
time display	131
trip report, printing	103

U	
unit description	25

W	
warranty	201