User's Manual

**Hotel Electronic Lock / Key
Management Software
Version 4.2u**

UCA, Inc.
©2002 all rights reserved

1. Summary	3
1.1. Classification.....	3
1.2 Card description.....	3
1.3 ES901 series hotel electronic door locking system.....	3
1.3.1 Electronic door lock.....	3
1.3.1.1 Main structure	3
1.3.1.2 Working principle.....	4
1.3.2 Function of Various Cards.....	4
1.3.3 Management system.....	5
1.3.4 other	5
1.4 Characteristics of ES901 Series Locking system.....	5
1.4.1 Leading technology.....	5
1.4.2 Perfect management.....	5
1.4.3 Safety and convenient	6
1.5 Technical reference and quality standard	7
2. Lock installation.....	7
2.1 Cut-out dimensions	7
2.2 Installation.....	10
3.Management system.....	11
3.1 key parts of management system	11
3.1.1 Computer.....	11
3.1.2 Encoder	11
3.1.3 Management Software	11
3.1.4 Printer, UPS.....	12
4. Lock Maintenance.....	12
4.1 Sound and Light signal of door lock	12
4.2 Initialization of door lock.....	13
4.3 Daily operation.....	14
4.3.1 open the lock (door)	14
4.3.2 Always-open status	14
4.3.3 Double-locked.....	14
4.3.4 Mechanical key (To lock and unlock)	14
4.3.5 Report to lose	14
4.3.6 Cover.....	14
4.3.7 Forbid.....	15
4.3.8 Adjust clock.....	15
4.3.9 Record collecting	15
4.3.10 Replace battery.....	16
4.3.11 Delete	16
4.3.12 Change system Cipher.....	16
4.4 Suggestion on door locking system management.	16
4.4.1 Responsibility of each department	16
4.4.2 Suggestion on management.....	17
5 Maintenance and troubleshooting	17
5.1 Trouble shooting	17
5.2 Daily maintenance.....	19
6 Other explanation.....	19

1. Summary

ES901 series hotel electronic locking systems are the worldwide fashionable door locking system nowadays. They incorporate high microcomputer technology, mechanical-electrical technology, advanced mechanical processing techniques and perfect surface finish techniques as an integral whole. Taking various users' requirements into consideration, they are of significant meaning to strengthen the safety of hotel as well as improving its management.

1.1. Classification

For their key cards are of different types, the locks can be classified into the following models:

1. ES9010 ----- IC card electronic door lock
2. ES9011 ----- Magnetic card electronic door lock
3. ES9012 ----- TM card (IB card) electronic door lock
4. ES9013 ----- RF card electronic door lock (it also has two types: TEMIC card and MIFARE card).

1.2 Card description

Description of different cards

IC card	Magnetic card	RF card	TM(IB) card
----------------	----------------------	----------------	--------------------

- (1) IC card: a PVC plastic card with IC chip;
Outline dimension: 85x54x0.8mm
- (2) Magnetic card: a PVC plastic card with a magnetism strip.
Outline dimension: 85x 54x0.8mm
- (3) RF card: a PVC plastic card with an IC chip and metal induction winding.
Outline dimension: 85x54x0.8mm
- (4) TM (IB) card: a round metal case with an IC chip.
Outline dimension: $\Phi 16 \times 6$ mm

1.3 ES901 series hotel electronic door locking system

ES901 series hotel electronic door locking system is mainly composed of electronic door locks, various keys (cards) of different function (hereinafter called cards) and management system etc.

1.3.1 Electronic door lock

1.3.1.1 Main structure

Electronic door lock is mainly composed of a front escutcheon, back escutcheon and lock case etc.

The lock case is the main mechanical component and from its appearance you can see the shell, main latch, dead latch and stop latch etc. An electric motor is located

inside the lock and by which the lock can be driven to open or close automatically.

We provide mechanical key to each electronic door lock, which can be used while battery box is not installed in the lock or because of an electronic fault.

1.3.1.2 Working principle

While leaving factory, all locks are the same. After installation, first initialize the locks with “Cipher Card”, “Room number Card” and “Clock Card”, meaning to set cipher, room number and adjust correct time to each lock.

Then, apply card to lock, the computer control board inside the lock will read the card, by logical analysis to judge whether this card is legal or not (including whether the Cipher, Room number or Time is correct or not), meanwhile, replies with output various corresponding signals to drive signal light, buzzer and lock motor to work.

If the card is legal, the lock motor will run clockwise, you push the door handle, door can be opened, then, loosen the handle, the computer control board inside the lock drive the motor run anti-clockwise, the door closed.

System stipulates that Passage function can be divided into 4 types: Non-passage (i.e.: use as common room), Floor Passage, Building Passage and General Passage. Among it, locks of Floor Passage can be opened by all effective cards of this floor such as: Emergency Card, Master Card, Multi-Floor Card (Within its authority to open) and all Room Cards of this floor; locks of Building Passage can be opened by any effective card of this building while locks of General Passage can be opened by any effective card made by this system.

Below is a brief description of working principle of door locks; the details please refer to the following chapters.

1.3.2 Function of Various Cards

The card system supply over ten types of cards of different function and authority:

- 1. Cipher Card:** Set the lock **System Cipher** when installation, cannot open lock.
- 2. Room number Card:** Set **Room number** and **Passage function** after installation, cannot open lock.
- 3. Clock Card:** Set or adjust the lock inner clock time to card-making time, cannot open lock.
- 4. Discontinue Card:** To delete all user information except system cipher, room number and passage mark.
- 5. Report loss Card:** To report loss and forbid one lost card from opening its authorized locks, make it invalid. Cannot open lock.
- 6. Forbidden Card:** Forbid the appointed room from being used by a formal Guest Card
- 7. Record Card:** Extract the trial of latest 200 entries (including the time, room number, card type, mechanical key or door closing etc.)
- 8. Emergency Card:** Can open all the locks in the unit, even includes double-locked doors.
- 9. Master Card:** Can open all the locks in the unit. Even including double-locked door.

-
10. **Supervisor card:** Can open all the locks of some designated floors in a building.
 11. **Server card:** Can open all the locks of one designated floor in a building.
 12. **Guest card:** can open the designated door in a certain time limit
 13. **Switch Card:** Keep the designated door in always open status
 14. **One-off Card:** To open designated door by staff. Become invalid after used once.

1.3.3 Management system

Management system is composed of one computer, one encoder and one hotel Manage software etc.

Hotel Lock management software (hereinafter called management software) is used to manage the using status of hotel rooms (including booked, occupied room, satisfying room and OK room etc.), also it is used for card-making, information registration, statistics, query and printing, for the details, please refer to Chapter 3 “Lock management system and its operation.”

1.3.4 other

For its own superiority and applicability, the door locking system can be jointly used with other management system; realize the aim of one card is for multiple uses.

1.4 Characteristics of ES901 Series Locking system

Electronic door lock is one of the most advanced locks nowadays, and its main superiority is as follows,

1.4.1 Leading technology

- All key circuits are made of imported components of excellent capability
- Imported micro motor are reliable and of low power consumption.
- Lock latches meet international standard, safety and user friendly.
- Inner real time clock, precision.
- Various signal indication, simple and direct.
- Run in Win95 or Win98, convenient for operation.

1.4.2 Perfect management

- Strict authority control
Different cards have different authority. For example: Guest Card can only open the designated door lock; Server Card can only open door locks of designated floor, Supervisor Card can only open the door locks of some designated floors; while Emergency Card and Master Card can open all the system locks.
Management has four different authority levels: Operator lever, Supervisor lever, Manager lever and Maintainer Lever.
With different authority lever, you can make different cards or do maintenance.
- Strict time limit

All lock cards are limited by time, as soon as the limited time is up, cards will become invalid automatically.

- Perfect losing-preventing function
In case card found lost, only need to make a Report Lose Card, and use it to refresh all the relevant locks once, the lost card will become invalid automatically, or redo a new card, use the new card to refresh all the relevant locks.
- Enough unlocking record
The E²PROM inside the computer control board of lock can memorize the latest 200 entries (including unlocked by mechanical key, Card, door not properly closed etc.), if necessary, the Data-collector can be used to pick up “data”, then, connect with management system to check when or how the locks be opened or closed. For its own characteristics, the E2PROM can effectively save the data even locks are broken or without electricity.
- Flexible cipher control
By **Cipher Card**, the cipher of the whole lock system can be revised quickly and easily, however, because the new Cipher Card contains the old cipher information, also the inner computer control board should verify old cipher before change into new one, so, if old cipher be verified unqualified, the cipher cannot be changed.

1.4.3 Safety and convenient

- Safety
For the using of card, the probability to decode the cipher is only $1/2^{32}$; the international standard latch is against inserting and destroying, also, the management software has multilevel password setting to assure the high security of system; All operator’s work can be record for information.
- User friendly
After check-in, guests can open door directly with card. The card will be valid until expiration. In case several guests share one room, Guest Card B can be used to realize one people holds one card, no interference to each other.
Guest card can also be used to open Safe, Energy saving switch etc.
When this locking system is jointly used with other system, the Guest Card also has other use, such as: pay consumption fee etc.
When doors locked in, only mechanical key and Emergency Card can open it, no other card has this function.
When door is not properly closed (Main latch is not in its proper place), the lock will give alarm signal.

Also, the lock can be set in **Always-open status**.

- Complete software operation record
Management software will record all users' successful operation, this record cannot be man-made modified.

1.5 Technical reference and quality standard

- (1) Power Supply: DC6V; 4 AAA alkaline batteries; low pressure alarm at 4.8V
- (2) Shell material: Steel, Copper and Gahnite
- (3) Durable Shock: More than 1000 kg
- (4) Adaptable door thickness: 40 — 50 mm
- (5) Weight: About 3 kg
- (6) Environment requirements: temperature: -20℃—50℃; humidity $\leq 95\%$; without corrosive gas and powder.

2. Lock installation

Electronic lock is complexity and precision. The installation people must be familiar with the technology.

There are left-handed lock and right-handed lock (Picture 2-1)

When place order; the quantity of each type should be marked clearly.

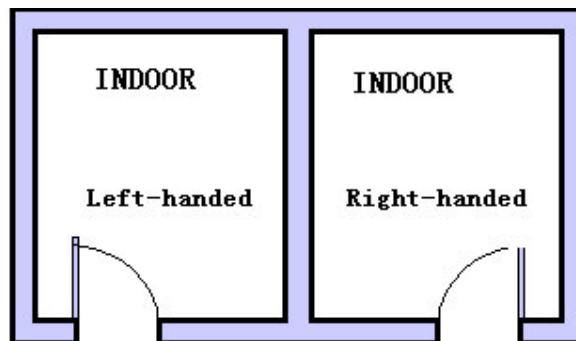

Picture 2-1 Left and right-handed door

The lock can be installed in metal or wooden door. Holes should be opened in the metal door before installation; for wooden door, please refer to this direction. Pay attention that different thickness of door matches different screws.

2.1 Cut-out dimensions

Please refer to picture 2-2,2-3.

For the quality of holes opening directly influence the using quality of the locks, so you must open the holes strictly according to the standard size listed, to be precise, smooth and no wooden scraps.

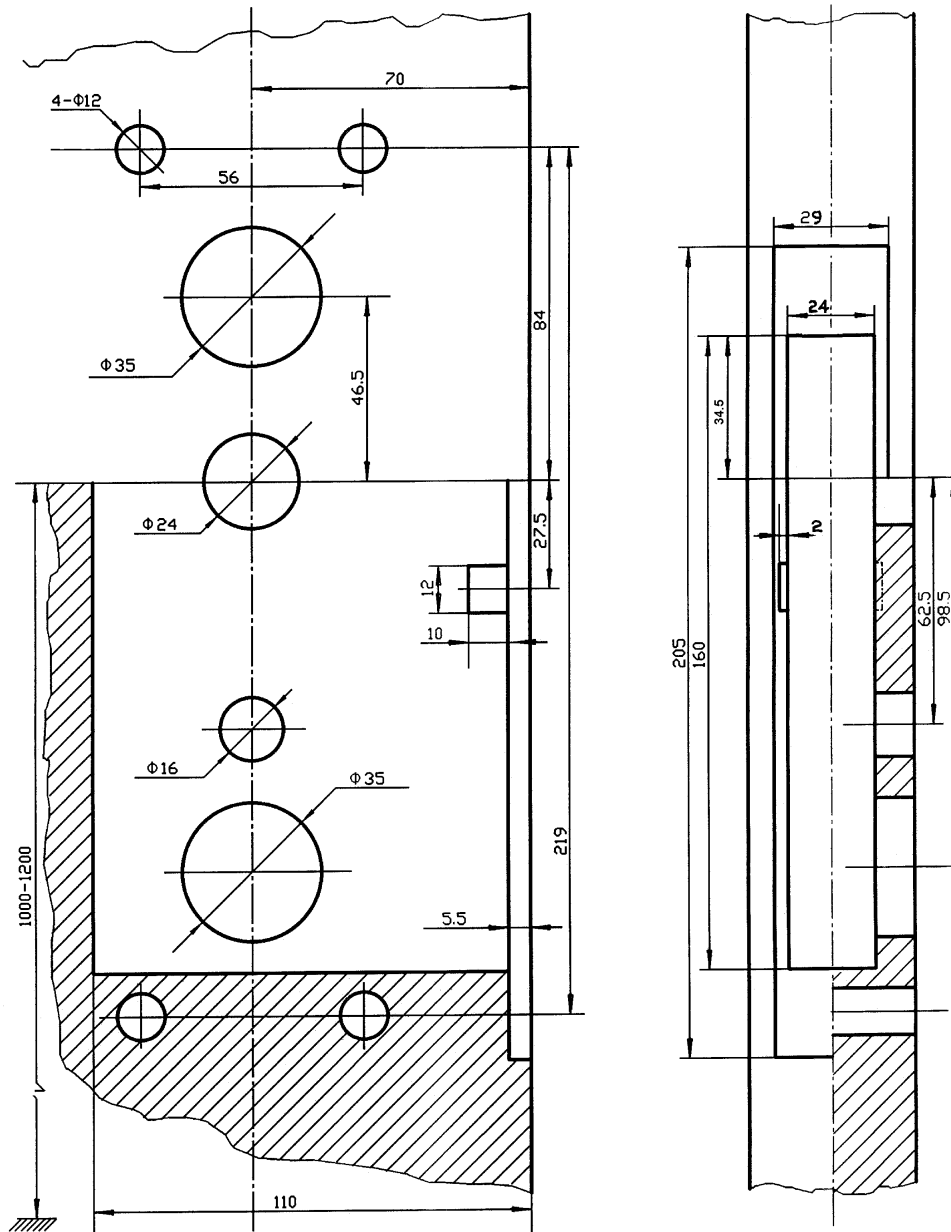

Picture 2-2 Door Cut-out Dimension
Dimension given in mm

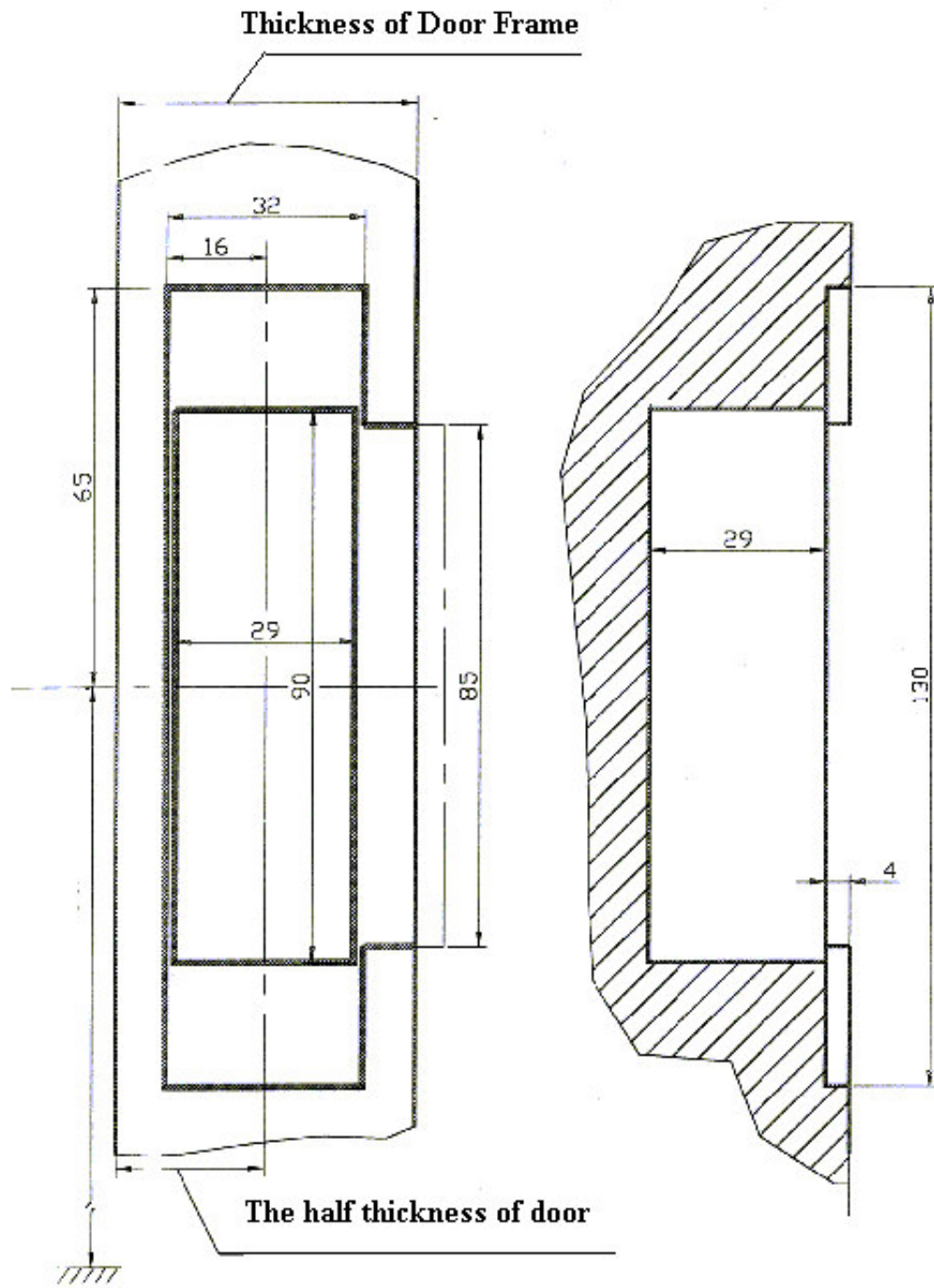

Picture 2-3 Door-Frame Door cut out dimension
Dimensions given in mm

2.2 Installation

The installation of electronic door locks shall strictly according to this Direction, avoid dirtying and spoiling the locks; you'd better install them after other fitments have been finished.

Picture 2-4 shows the main components of electronic door lock.

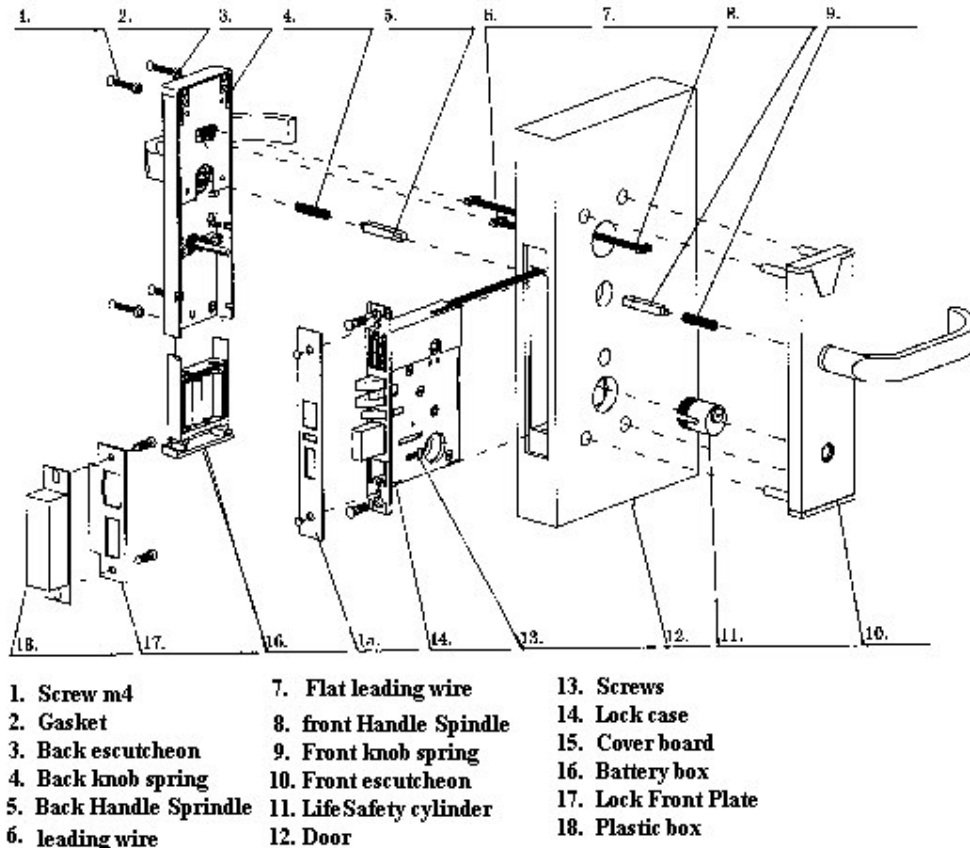

Picture 2-4 Main components and installation

Steps of installation:

1. Position the **lock case** (14) into the door edge, pay attention not to break the **leading wire** (6). Draw the leading wire into the door, fasten the lock case with two screws.
2. Take the **Life Safety cylinder** (11) into the proper place of screw hole, let its convex surface be up and fix it with **Screws** (13) from the side.
3. Install the **Front Handle Spindle** (8) into the front clutch hole of the main **Lock case** (14); connect one top of the **Flat leading wire** (7) into the jack of the front cover; install **Front knob spring** (9) into the hole of knob in the front cover, then press the **Front escutcheon** (10) in the outside of the door.
4. Put the **Nylon gasket** (2) onto the **Screws** (1), get ready for the following.
5. Install the **Back Handle Spindle** (5) into the back clutch hole of the main **Lock case** (14) and put the **Back knob spring** (4) into the hole of knob in the

-
- back cover. Then connect the other top of the **Flat leading wire** (7) with the jack of the back cover.
6. Install the **Battery box** (16) to its proper place.
 7. Fix the back cover with four **Screws** (1), then set the **Cover board** (15)
 8. Revolve mechanical key, front knob, back knob, to examine if the lock works well. If it works inflexibly, readjust them to their proper place.
 9. Use a card that can unlock to test if the lock works well or not.
 10. If the whole lock works well, install the **Plastic box** (18) and the **Lock Front Plate** (17) into the door.
 11. Check again to confirm its installation. Now the thorough installation is over.

3. Management system

The main task of HotelLockManage4.2 is to manage hotel guests, guest rooms, to manage cards. It is the key part of the whole door locking system. Please read this chapter carefully before operation.

Note: SQLANY5504 (including in this CD) is required to install on your computer before installing the HotellockManage 4.2.

3.1 key parts of management system

Management system is mainly composed of computer, encoder, software, printer and UPS etc.

3.1.1 Computer

Card making system demands:

CPU: above Pentium 166

Memory: above 64M

With CD-ROM, with COM1 or COM2

Resolution: 800 x 600 higher color monitor

Win9x/NT/2000/XP

3.1.2 Encoder

This system support Magnetic card encoder (ES7011 series), IC card encoder (ES7010 series), RF card encoder (ES7013, ES7014 series), TM card encoder (ES7012 series).

The encoder can be connected with computer COM1 or COM2 by DB9 cable.

3.1.3 Management Software

HotelLockManage4.2 electronic door lock management software is specially developed for hotel use, its direct and clear menu makes your job easy and efficient.

Software is written down in a CD--ROM

3.1.4 Printer, UPS

Printer can help you to print report forms.













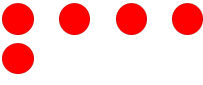
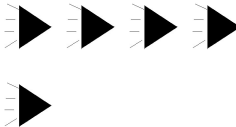
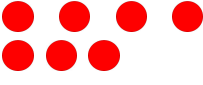
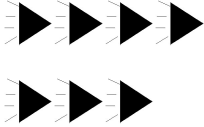

To avoid system breakdown or data-losing, we strongly suggest user to have a UPS, for it can supply power in case of electricity suddenly cut (usually small UPS supply power only several minutes, thus, you'd better quit form system and close computer immediately.)

4. Lock Maintenance

4.1 Sound and Light signal of door lock

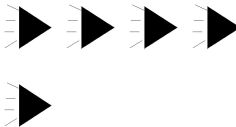
Note: To keep the longest battery usage, please use Alkaline AA battery (**No rechargeable battery**)

	Number of LED Flash	Number of Beeps	Possible Reason	Solution
1			Invalid hotel card (Wrong Site id)	Check the Site Code, or Redo Site Card
2			Room Number Error	Re-issue Room Card
3			Lock Memory Error	Use the initialization card to clean up the lock memory
4			Mechanic Key Cylinder test ok	No Action
5			Data format error	Re-issue clock card
6			Room number issued already	Room number is correct. No action needed
7			Normal unlock card	No action
8		 	Mortise latch doesn't close properly	Close door properly
9			Lock test: Site/Room/Discontinue/Authorization/Clear/Report loss/Data card	
10			Clock error (Short flash and long beep for 2 second)	Redo-clock card
11			Reading error (IC card lock)	Flip over the card

12			Deadbolt is on	Use emergency card should open the lock
13			Card is expired	Re-issue guest card
14			Low battery shut down the lock	Use initialization card to clean the low battery count. And change battery
15			Invalid card. Card has been terminated	Re-issue card
16			Forbidden card	Re-issue card
17			Card has been cancelled with a newer issued card	Use the initialization card, then re-issue card
18			Low battery warning	Change battery
19			Lock is in passage mode	
20			Incomplete data card process	

4.2 Initialization of door lock

Initialization must be done when first installation or changing main board. The detailed procedure is as follows:

- a) Use “Cipher Card” to set lock with system Cipher
- b) Use “Room Number Card” to set lock with its relevant room number
- c) Use “Clock Card” to adjust the clock inside clock into current time

After these three steps, the initialization finished, the door locks can be put into use.

Attention:

- (1) One “Cipher Card” can only be input once, if input the second time, red light will flash 0.5 second, twice.
- (2) In case same “Room Number Card” be input repeatedly, the yellow light will flash 0.5 second, three times.
- (3) In case room number changed or passage function need to be changed,

only input the room number card can be done.

4.3 Daily operation

To judge the correctness of following daily operation, please refer to sound and light signals.

4.3.1 open the lock (door)

Apply card to door lock, green light flashes, turn the handle, you can open the door.

In case lock cannot be effectively opened, please refer to sound and light signals for reason.

The “Beep” sound and lock opening time interval could be possibly different due to different cards type or using times.

4.3.2 Always-open status

Use Switch Card the first time, green light flash once, the lock will in always-open status. In this status, if apply any other card, the light and sound signal will reply as above mentioned No. 9 under Section 4.1

Use card the second time, green light flash once, the lock closed.

4.3.3 Double-locked

When enter into room, push and make main latch works, the door will be double-locked. Only mechanical key or “Emergency Card” can open the double-locked door from inside or outside, if use any other card, the lock will output warning signals.

4.3.4 Mechanical key (To lock and unlock)

No matter whether the door lock circuit works normally or not, mechanical key can be used to open the door. Mechanical key can also be used to make the door double-clocked or open double-clocked door from outside.

4.3.5 Report to lose

When high level management cards (Emergency Card, Master Card, Supervisor Card or Server Card) found the card lost, must report to lose at once.

The procedure is as follows:

First, make one “Report lose Card”, and then apply this card to all its relevant door locks once. To judge the operation success or not, please refer to sound and light signals.

Passage Locks cannot be reported lose.

4.3.6 Cover

If room cards (Guest Card, One-off Card, Switch Card, Standby Card) lost, please make a card of same type immediately (Its making time should later than the lost one), and apply it to the relating lock once.

4.3.7 Forbid

In case guest checkout before scheduled time, to assure safety, floor waiter can apply Forbidden Card to its relating lock to make current Guest Card invalid. The next guest can direct draw new card to use.

4.3.8 Adjust clock

Clock time inside lock shall be set to be correct when first installation. The principal shall check and adjust the clock time periodically (once every month).

Before time setting, a "Clock Card" shall be made just in time, then, set locks with it ASAP.

Clock card must be set as current time to ensure the time of the system is assorted with the real time. Make sure the computer time is right.

Clock card can be used to all locks, unnecessary to be make it for each lock separately.

In case too many rooms, the setting job can be done for several times in order to avoid lock time slower too much than real time.

In case the lock time is wrong, which possibly arouse lock cannot be opened by card, even can be opened, the recorded time is wrong.

4.3.9 Record collecting

The latest 200 times of lock opening and closing can be stored by Computer Control Board of lock (including the time, room number, card type, mechanical key or door closing etc.) can be picked up for your reference. Different types of lock have different ways to pick the record. The detailed procedure is as follows:

1. For ES9010 and ES9012

- (1) Write a Record Card with Encoder; (This card specially supplied by manufacturer)
- (2) Apply Record Card to door lock, green light lit;
- (3) After 10 seconds, green light flash and buzzer beep twice, record be picked up.
- (4) Read Record Card with Encoder, the record will be show in computer.

2. For ES9011 and ES9013

- (1) Write a Record Card
- (2) Insert the "Data-collector" to the "Record Socket" at the bottom of the front escutcheon, switch on the "data-collector", the indicator light flashes.
- (3) Touch " the Inductive window (triangular area) with record card, move it away when buzzer beeps be heard.
- (4) Now, the yellow light will flash for 10 seconds, then, green light flash, buzzer beep twice, the record is picked out.
- (5) Remove the "data-collector" and connect it with the Encoder and computer correctly, you can get the record.

Note: In case the time in record is obviously wrong (which may caused by inner clock time error), please calculate actual time according to current time.

Record Card can be repeated used, needn't write card again.

4.3.10 Replace battery

The lock accepts four AAA size batteries to supply the unit with power, and other types of batteries are not suggested to use. While open door with card, in case low voltage warning sound and light signal like "Yellow light flashes and buzzer beep 0.1 second, 5 times", the batteries shall be replaced by new ones. If not, the lock still can be opened for 30 times, however, after 30 times, it will refuse to be opened by any cards and will give warning signal when card touch it.

During examine and repair, if battery voltage were found below 5.2V (the limit of low voltage is 4.8V), still suggest replacing the batteries. If poor quality battery is found (leakage), please replace it immediately.

4.3.11 Delete

Under specially condition (User's data confusion in lock memory), "Discontinue Card" Can be used to delete all user information except system cipher, room number and Passage sign.

Normally please don't use "Discontinue Card".

4.3.12 Change system Cipher

If system cipher need to be changed under special condition, can revise cipher in card making system, then, make a new "Cipher Card", use this "Cipher Card" to set each locks once, thus, the old cipher is invalid.

Please don't change "System Cipher" except emergency, for if the cipher changed, all cards must be re-made. So, before changing, please think about it twice, and please inform manufacturer's after-sales department.

Attention: "System Cipher" is strictly prohibited to be revised twice or above continuously (Details refer to 1.4), for which will arouse system confusion.

4.4 Suggestion on door locking system management.

Although Electronic Card Locking system is of high safety and great convenience, however, which must be under the precondition of strictly management.

4.4.1 Responsibility of each department

All related person must grasp the base knowledge of this system, the detailed assignment as followed:

IT department responsible for the installation, maintenance and technical support of Card-making system and software;

The management level responsible for make, keep and manage all kinds of cards.

Common operators make the cards with low level. The high level cards are to be made only by the specially assigned people.

System Cipher and all passwords must be kept confidential.

Adopted cards and mechanical key must be registered for record.

Special people in engineering department shall be assigned to responsible for door

lock repairing and maintenance, feeding back the running status of door locks.

4.4.2 Suggestion on management

After the locking system installed, one person familiar with mechanical and electric must be assigned by user to take charge of the lock running process, this person shall received the manufacturer's training.

In trial running, it's better to use the system in an easy way, for example, don't make cards with time limit (default time limit is 12:00 Dec. 30th, 2099).

Don't use "Authorization Card" and "Clear Card" etc. in order not to arouse unnecessary trouble. Try other functions after familiar with the system.

Some trouble may happen in trial stage, such as inflexible handle caused by distortion of door board, operation error etc., in case trouble occurs, be calm down to analyze its reason and try to cooperate with manufacturer to solve it.

Adjust the clock monthly at fixed period to avoid clock mistake.

Copy the sheet of lock sound and light signals to respective department.

5 Maintenance and troubleshooting

Special person must be assigned by user to be in charge of maintenance and troubleshooting.

Maintainer shall carefully read the User Manual to be familiar with various sound and light signals for troubleshooting.

In case a lock could be opened by any card, it means that this lock's function is ok. In case cannot be opened by part of the cards, first, confirm the cards in the management system, then, deal with it later.

Attention:

1. In case electricity cut suddenly during maintenance, the "Clock Card" must be re-made.

2. When circuit doubted to be wrong, please first use new batteries to test it, because if the voltage is too low (lower than 4.2V) or battery inner Resistance is not big (if only use Multimeter, it cannot be tested out), the SCM is possibly provide incorrect sound and light signals due to its load capability, thus, arouse misunderstanding.

5.1 Trouble shooting

Electronic Hotel Lock Trouble Shooting Flow Chart

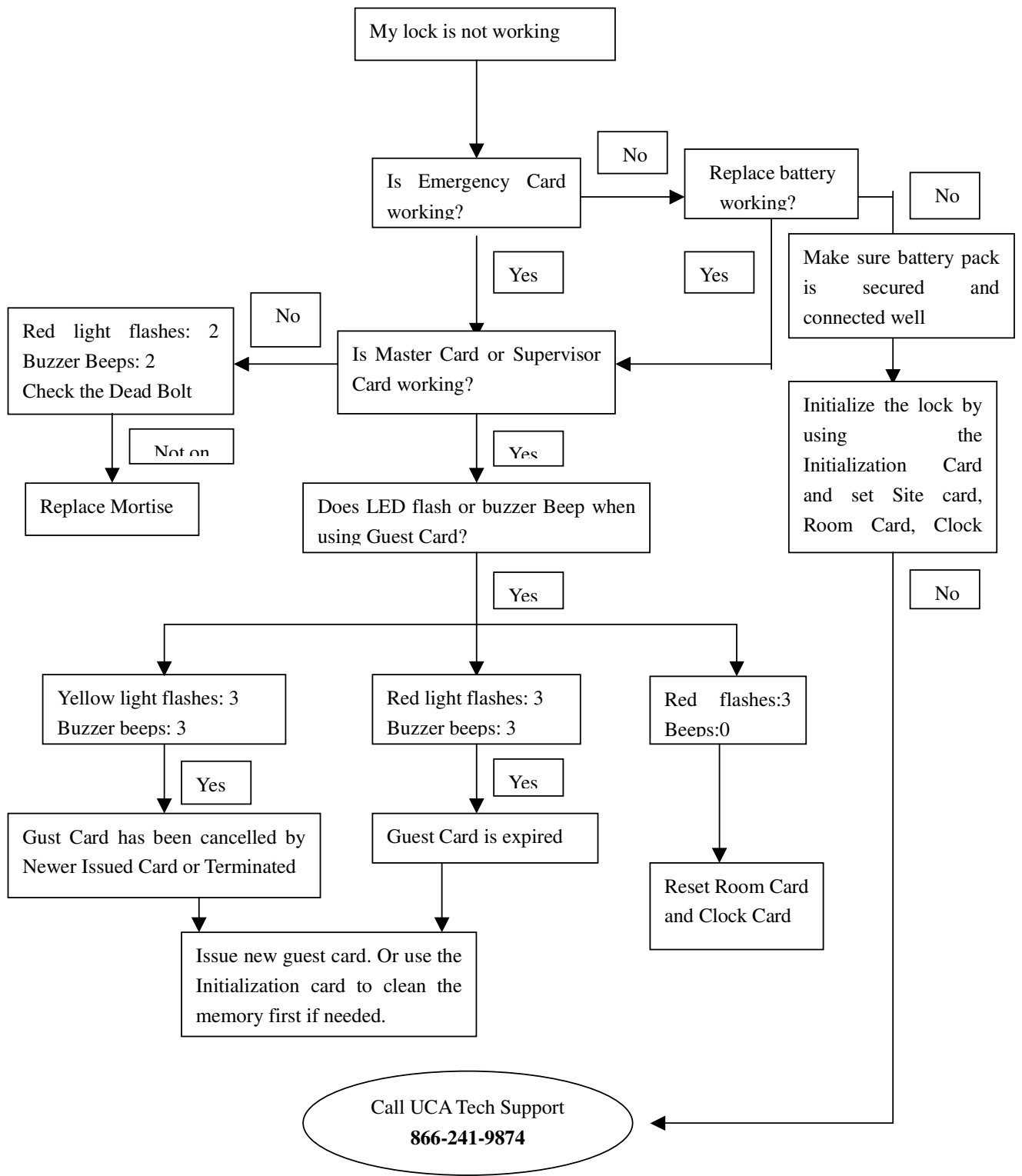

5.2 Daily maintenance

- (1) One management personnel shall be assigned to watch the locks running condition periodically.
- (2) Do not clean the surface of door lock with water, alcohol or other chemical liquid in order to not cause damage or corrosion; Dry them with cloth when necessary.
- (3) Fix the installation screws periodically.

6 Other explanation

- (1) User can directly make Query to retailer or manufacturer for unmentioned information in this user manual.
- (2) For ES901 series Card Locking system, we supply you several color options:
 - Satin Brass (SB)
 - Satin Chrome (SC)
 - Satin Gold (SG)
 - Satin Silver (SS)
 - Pearl Silver (PS)
 - Pearl Gold (PG)There have prepared other surfaces effect to choose such as
- (3) In case product not agrees with this User Manual because of updating, please excuse without further announcement offered.