

ADAM-5000 Series

I/O Module User's Manual



**2.4 rd Edition
May 2008**

Introduction

This manual introduces the detail specifications functions and application wiring of each ADAM-5000 I/O modules. To organize an ADAM-5510 Series Controller, you need to select I/O modules to interface the main unit with field devices or processes that you have previously determined. Advantech provides 23 types of ADAM-5000 I/O modules for various applications so far. Following table is the I/O modules support list we provided for user's choice.

Module	Name	Specification	Reference
Analog I/O	ADAM-5013	3-ch. RTD input	Isolated
	ADAM-5017	8-ch. AI	Isolated
	ADAM-5017P	8-ch. AI with independent Input	Isolated
	ADAM-5017H	8-ch. High-speed AI	Isolated
	ADAM-5017UH	8-ch. Ultra High-speed AI	Isolated
	ADAM-5018	7-ch. Thermocouple input	Isolated
	ADAM-5018P	7-ch. Thermocouple input with independent Input	Isolated
	ADAM-5024	4-ch. AO	Isolated
Digital I/O	ADAM-5050	7-ch. D I/O	Non-isolated
	ADAM-5051	16-ch. DI	Non-isolated
	ADAM-5051D	16-ch. DI w/LED	Non-isolated
	ADAM-5051S	16-ch. Isolated DI w/LED	Isolated
	ADAM-5052	8-ch. DI	Isolated
	ADAM-5053S	32-ch. Isolated DI	Isolated
	ADAM-5055S	16-ch. Isolated DI/O w/LED	Isolated
	ADAM-5056	16-ch. DO	Non-isolated
	ADAM-5056D	16-ch. DO w/LED	Non-isolated
	ADAM-5056S	16-ch. Isolated DO w/LED	Isolated
	ADAM-5056SO	16-ch. Iso. DO w/LED (source)	Isolated
	ADAM-5057S	32-ch. Isolated DO	Isolated

Table 1: I/O Module Support List

I/O Module Introduction

Module	Name	Specification	Reference
Relay Output	ADAM-5060	6-ch. Relay output	Isolated
	ADAM-5068	8-ch. Relay output	Isolated
	ADAM-5069	8-ch. Relay output	Isolated
Counter/Frequency	ADAM-5080	4-ch. Counter/Frequency	Isolated
	ADAM-5081	4-ch/8-ch High Speed Counter/Frequency	Isolated
Serial I/O	ADAM-5090	4-port RS232	Non-isolated
	ADAM-5091	4-port RS232 with Share Interrupt	Non-isolated
	ADAM-5095	2-port CAN with Isolation protection	Isolated
Storage	ADAM-5030	2-slot SD Storage Module	
Motion	ADAM-5202	2-port AMONet Master Module	

Table 2: I/O Module Support List

1. Analog Input Modules

Analog input modules use an A/D converter to convert sensor voltage, current, thermocouple or RTD signals into digital data. The digital data is then translated into engineering units. The analog input modules protect your equipment from ground loops and power surges by providing opto-isolation of the A/D input and transformer based isolation up to

$3,000 V_{DC}$.

ADAM-5013 3-channel RTD input module

The ADAM-5013 is a 16-bit, 3-channel RTD input module that features programmable input ranges on all channels. This module is an extremely cost-effective solution for industrial measurement and monitoring applications. Its opto-isolated inputs provide $3,000 V_{DC}$ of isolation between the analog input and the module, protecting the module and peripherals from damage due to high input line voltage.

Note: Owing to the conversion time required by the A/D converter, the initialization time of each ADAM-5013 module is 5 seconds. Thus the total initialization time will be about 20 seconds if all 4 I/O slots in an ADAM-5000 main unit contain ADAM-5013 modules.

ADAM-5013

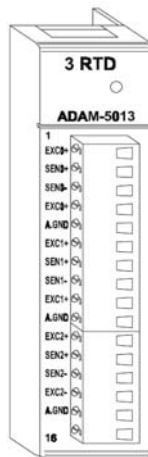

Figure 1: ADAM-5013 module frontal view

Application wiring

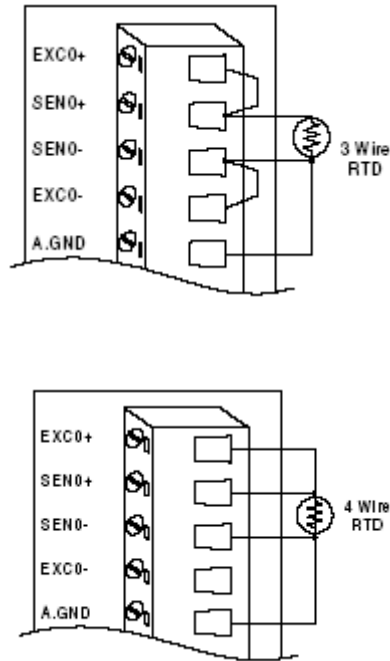

Figure 2: RTD inputs

Technical specifications of ADAM-5013

Analog input channels	three
Input type	Pt or Ni RTD
RTD type and temperature range	Pt -100 to 100°C a=0.00385 Pt 0 to 100°C a=0.00385 Pt 0 to 200°C a=0.00385 Pt 0 to 600°C a=0.00385 Pt -100 to 100°C a=0.00392 Pt 0 to 100°C a=0.00392 Pt 0 to 200°C a=0.00392 Pt 0 to 600°C a=0.00392 Ni -80 to 100°C Ni 0 to 100°C
Isolation voltage	3000 V _{DC}
Sampling rate	10 samples/sec (total)
Input impedance	2 MΩ
Bandwidth	13.1 Hz @ 50 Hz 15.72 Hz @ 60 Hz
Input connections	2, 3 or 4 wire
Accuracy	± 0.1% or better
Zero drift	± 0.015 °C/°C
Span drift	± 0.01 °C/°C
CMR@50/60 Hz	150 dB
NMR@50/60 Hz	100 dB
Power consumption	1.2 W

Table 2: Technical specifications of ADAM-5013

ADAM-5013 RTD Input Resistance Calibration

1. Apply power to the module and let it warm up for about 30 minutes.
2. Make sure that the module is correctly installed and is properly configured for the input range you want to calibrate. You can use the ADAM utility software to help in this.
3. Connect the correct reference self resistance between the screw terminals of the ADAM-5013 as shown in the following wiring diagram. Table 2 below shows the correct values of the span and zero calibration resistances to be connected. Reference resistances used can be from a precision resistance decade box or from discrete resistors with the values 60, 140, 200 and 440 ohms.

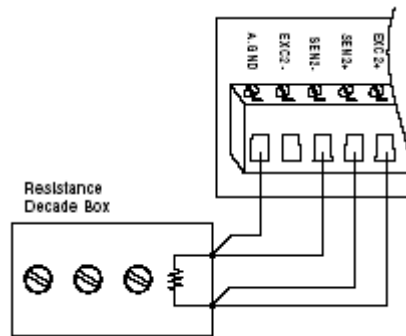

Figure 3: Applying calibration resistance

4. First, with the correct zero (offset) calibration resistance connected as shown above, issue a Zero Calibration command to the module using the Calibrate option in the ADAM utility software.
5. Second, with the correct span resistance connected as shown above, issue a Span Calibration command to the module using the Calibrate option in the ADAM utility software. Note that the module zero calibration must be completed prior to the span calibration.

Note: If the above procedure is ineffective, the user must first issue an RTD Self Calibration command \$aaSi2 to the module and then complete steps 4 and 5 after self calibration is complete.

I/O Module Introduction

Calibration resistances (ADAM-5013)

Input Range Code (Hex)	Input Range	Span Calibration Resistance	Zero Calibration Resistance
20	Pt, -100 to 100°C A = 0.00385	140 Ohms	60 Ohms
21	Pt, 0 to 100°C A = 0.00385	140 Ohms	60 Ohms
22	Pt, 0 to 200°C A = 0.00385	200 Ohms	60 Ohms
23	Pt, 0 to 600°C A = 0.00385	440 Ohms	60 Ohms
24	Pt, -100 to 100°C A = 0.00392	140 Ohms	60 Ohms
25	Pt, 0 to 100°C A = 0.00392	140 Ohms	60 Ohms
26	Pt, 0 to 200°C A = 0.00392	200 Ohms	60 Ohms
27	Pt, 0 to 600°C A = 0.00392	440 Ohms	60 Ohms
28	Ni, -80 to 100° C	200 Ohms	60 Ohms
29	Ni, 0 to 100°C	200 Ohms	60 Ohms

Table 3: Calibration resistances of ADAM-5013

ADAM-5017 8-channel analog input module

The ADAM-5017 is a 16-bit, 8-channel analog differential input module that provides programmable input ranges on all channels. It accepts millivolt inputs ($\pm 150\text{mV}$, $\pm 500\text{mV}$), voltage inputs ($\pm 1\text{V}$, $\pm 5\text{V}$ and $\pm 10\text{V}$) and current input ($\pm 20\text{ mA}$, requires 120 ohms resistor). The module provides data to the host computer in engineering units (mV, V or mA). This module is an extremely cost-effective solution for industrial measurement and monitoring applications. Its opto-isolated inputs provide $3,000 V_{\text{DC}}$ of isolation between the analog input and the module, protecting the module and peripherals from damage due to high input line voltage. Additionally, the module uses analog multiplexers with active over-voltage protection. The active protection circuitry assures that signal fidelity is maintained even under fault conditions that would destroy other multiplexers. This module can withstand an input voltage surge of 70 Vp-p with $\pm 15\text{ V}$ supplies. The jumpers of ADAM-5017 are designed for current input.

ADAM-5017

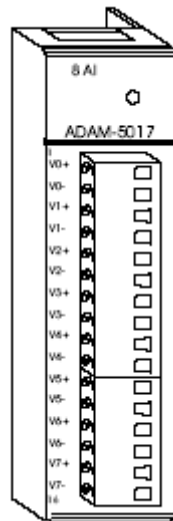

Figure 4: ADAM-5017 module frontal view

I/O Module Introduction

Application wiring

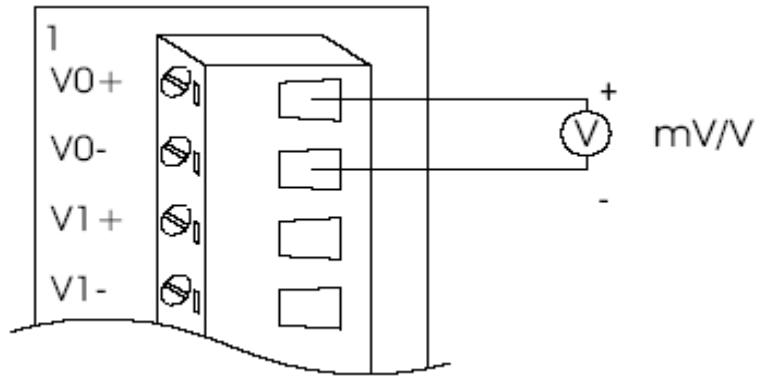

Figure 5: Millivolt and volt input

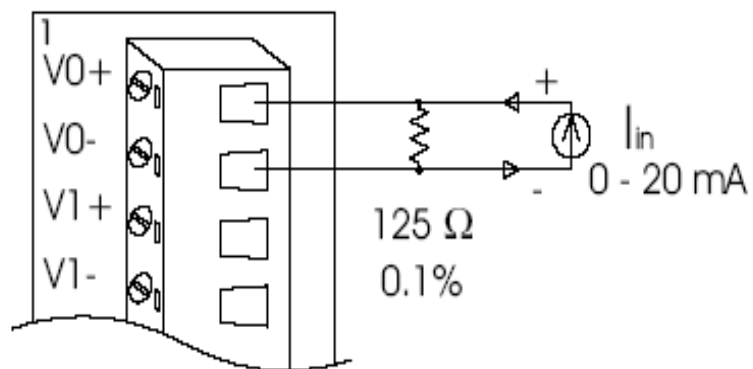

Figure 6: Process current input

Note: To keep measurement accuracy please short the channels that are not in use.

Technical specifications of ADAM-5017

Analog Input Channels	Eight differential
Input Type	mV, V, mA
Input Range	± 150 mV, ± 500 mV, ± 1 V, ± 5 V, ± 10 V and ± 20 mA
Isolation Voltage	3000 V _{DC}
Sampling Rate	10 samples/sec (total)
Analog Input Signal Limit	15 V max.
Max. allowable voltage difference between two connectors in a module	15 V max.
Input Impedance	2 Mohms
Bandwidth	13.1 Hz @ 50 Hz, 15.72 Hz @ 60 Hz
Accuracy	$\pm 0.1\%$ or better
Zero Drift	± 1.5 μ V/ $^{\circ}$ C
Span Drift	± 25 PPM/ $^{\circ}$ C
CMR @ 50/60 Hz	92 dB min.
Power Requirements	+ 10 to + 30 V _{DC} (non-regulated)
Power Consumption	1.2 W

Table 4: Technical specifications of ADAM-5017

ADAM-5017P 8-channel analog input module with independent input range

The ADAM-5017P is a 16-bit, 8-channel analog differential input and independent configuration module. It accepts millivolt inputs ($\pm 150\text{mV}$, $\pm 500\text{mV}$, $0\sim 150\text{mV}$, $0\sim 500\text{mV}$, $0\sim 1\text{V}$, $0\sim 5\text{V}$, $0\sim 10\text{V}$, $0\sim 15\text{V}$), voltage inputs ($\pm 1\text{V}$, $\pm 5\text{V}$, $\pm 10\text{V}$, and $\pm 20\text{V}$) and current input ($\pm 20\text{mA}$, $4\sim 20\text{mA}$, requires 120ohms resistor). The module provides data to the host computer in engineering units (mV, V (supports uni-polar and bipolar) or mA). This module is an extremely cost-effective solution for industrial measurement and monitoring applications. Its high common mode provides 200V_{DC} , protecting the module and peripherals from damage due to high input line volt-ages. Additionally, the module uses analog multiplexers with active over-voltage protection. The active protection circuitry assures that signal fidelity is maintained even under fault conditions that would destroy other multiplexers. This module can withstand an input voltage surge of $\pm 60\text{V}_{\text{DC}}$.

ADAM-5017P

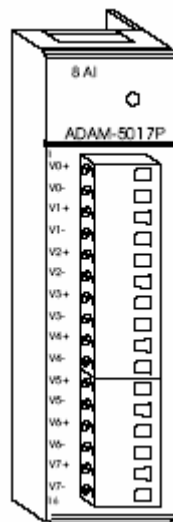

Figure 7: ADAM-5017P module frontal view

Application wiring

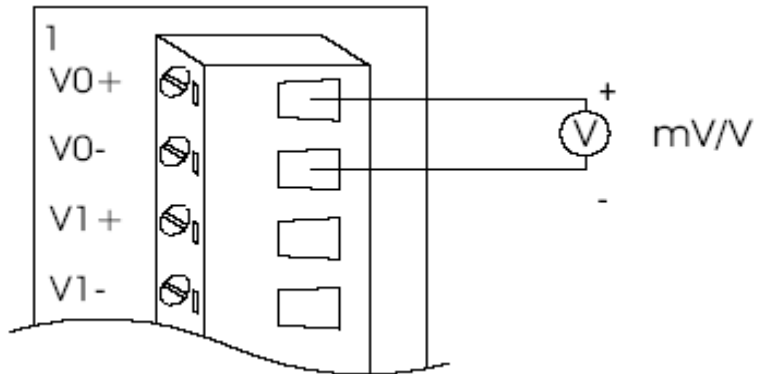

Figure 8: Millivolt and volt input

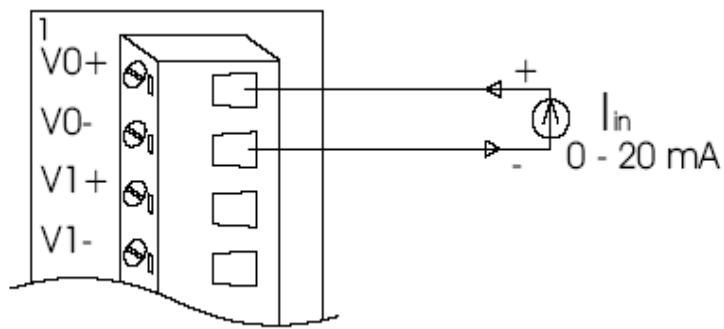

Figure 9: Process current input

I/O Module Introduction

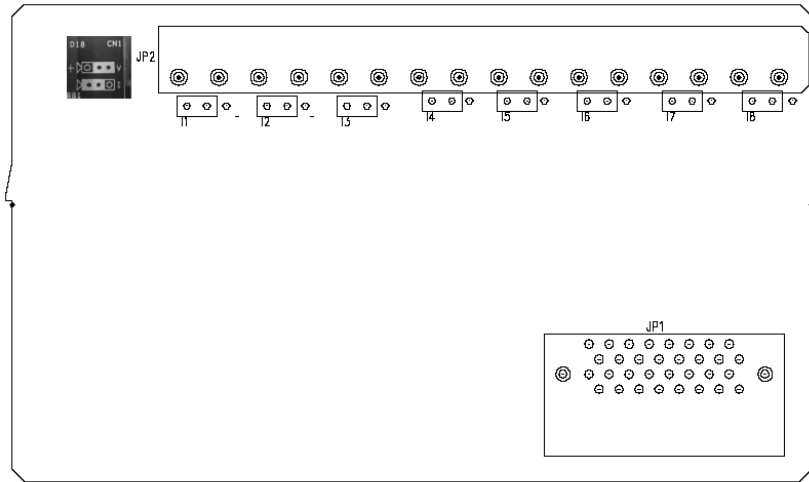

Figure 13: Locations of Jumpers

Note: To maintain measurement accuracy please short channels not in use.

Technical specifications of ADAM-5017P

Analog Input Channels	Eight differential and independent
Input Type	mV, V(uni-polar and bipolar), mA
Input Range	± 150 mV, ± 500 mV, ± 1 V, ± 5 V, ± 10 V, 0~150mV, 0~500mV, 0~1V, 0~5V, 0~10V, 0~15V and ± 20 mA, and 4~20mA
High common mode	200 V _{DC}
Sampling Rate	10 samples/sec (total)
Resolution	16 bits
Over Voltage	± 60 V _{DC}
Input Impedance	20 Mohms Voltage 120 ohms Current
Built-in TVS/ESD protection	yes
Accuracy	$\pm 0.1\%$ or better Voltage mode $\pm 0.2\%$ or better Current mode
Zero Drift	± 6 μ V/ $^{\circ}$ C
Span Drift	± 25 PPM/ $^{\circ}$ C
CMR @ 50/60 Hz	92 dB min.
Power Consumption	1.25 W (Max)

Table 5: Technical specifications of ADAM-5017P

ADAM-5017H 8-channel high speed analog input module

The ADAM-5017H is a 12-bit plus sign bit; 8-channel analog differential input module that provides programmable input ranges on each channel. It accepts millivolt inputs (± 500 mV, 0-500 mV), voltage inputs (± 1 V, 0-1 V, ± 2.5 V, 0-2.5 V, ± 5 V, 0-5 V, ± 10 V and 0-10 V) and current inputs (0-20 mA and 4-20 mA; it was built in a 200 ohms resistor). The module provides data to the host microprocessor in engineering units (mV, V or mA) or two's complement format. Its sampling rate depends on the data format received: up to 100 Hz (total). Each input channel has 3000 V_{DC} of optical isolation between the outside analog input line and the module, protecting the module and peripherals from high input line voltages. Additionally, the module uses analog multiplexers with active over-voltage protection. The active protection circuitry assures that signal fidelity is maintained even under fault conditions that would destroy other multiplexers. The analog inputs can withstand a constant 70 Vp-p input with ± 15 V supplies. The jumpers of ADAM-5017H are designed for current input.

ADAM-5017H

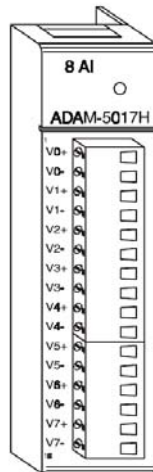

Figure 10: ADAM-5017H module frontal view

Application wiring

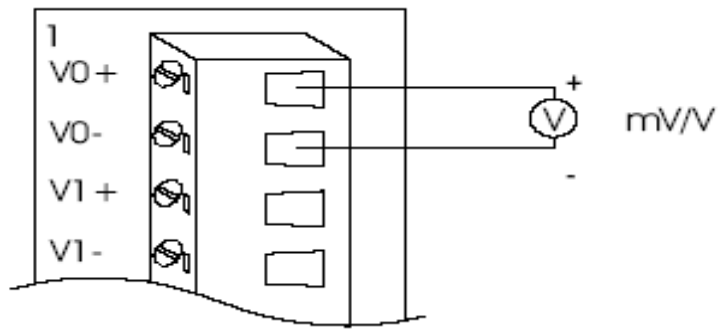

Figure 11: Millivolt and volt input

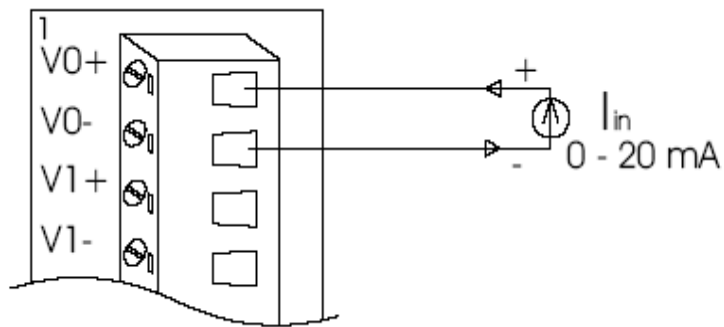

Figure 12: Process current input

I/O Module Introduction

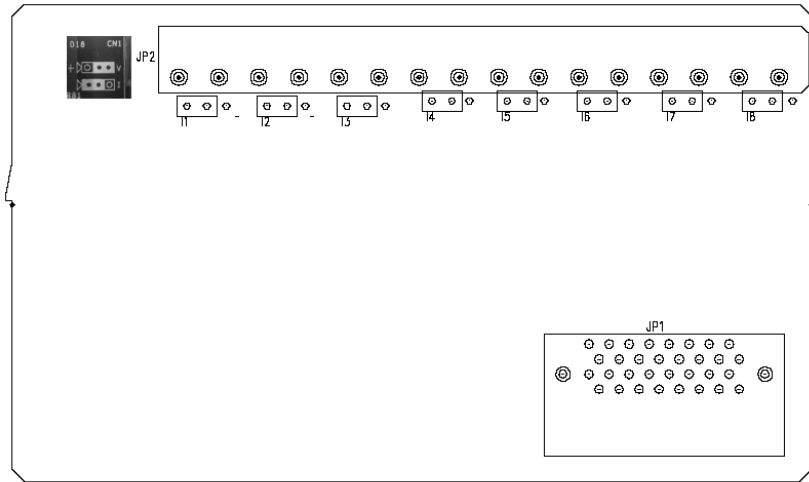

Figure 13: Locations of Jumpers

Note: To maintain measurement accuracy please short channels not in use.

Technical specifications of ADAM-5017H

Analog Input Channels	8 differential
ADC Resolution	12 bits, plus sign bit
Type of ADC	Successive approximation
Isolation Voltage	3000 V _{DC}
Sampling Rate	100 Hz
Input Impedance	20 Mohms (voltage inputs) 200 ohms (current inputs; built in on the board)
Signal Input Bandwidth	1000 Hz for both voltage inputs and current inputs
Analog Signal Range	±15 V max.
Analog Signal Range for any two measured Pins	±15 V max.
Power Requirements	+10 to +30 V _{DC} (non-regulated)
Power Consumption	1.8 W
Accuracy	± 0.1% or better

Table 5: Technical specifications of ADAM-5017H

I/O Module Introduction

	Input Range	With Overranging	Offset Error @ 25°C	Offset Error @ -10 to +70°C	Gain Error @ 25°C	Gain Error @ -10 To +70°C	Offset Drift	Gain Drift	Display Resolution
Voltage Inputs	0 ~ 10 V	0 ~ 11 V	±1 LSB	±2 LSB	±1 LSB	±2 LSB	17 $\mu\text{V}/^\circ\text{C}$	50 $\text{ppm}/^\circ\text{C}$	2.7 mV
	0 ~ 5 V	0 ~ 5.5 V	±1 LSB	±2 LSB	±1.5 LSB	±2 LSB	16 $\mu\text{V}/^\circ\text{C}$	50 $\text{ppm}/^\circ\text{C}$	1.3 mV
	0 ~ 2.5 V	0 ~ 2.75 V	±1 LSB	±2 LSB	±1.5 LSB	±2 LSB	20 $\mu\text{V}/^\circ\text{C}$	55 $\text{ppm}/^\circ\text{C}$	0.67 mV
	0 ~ 1 V	0 ~ 1.375 V	±1 LSB	±2.5 LSB	±2 LSB	±2.5 LSB	20 $\mu\text{V}/^\circ\text{C}$	60 $\text{ppm}/^\circ\text{C}$	0.34 mV
	0 ~ 500 mV	0 ~ 687.5 mV	-	±5 LSB	±3 LSB	±3.5 LSB	20 $\mu\text{V}/^\circ\text{C}$	67 $\text{ppm}/^\circ\text{C}$	0.16 mV
	±10 V	±11 V	±1 LSB	±2 LSB	±1 LSB	±2 LSB	17 $\mu\text{V}/^\circ\text{C}$	50 $\text{ppm}/^\circ\text{C}$	2.7 mV
	±5 V	±0 ~ 5.5 V	±1 LSB	±2 LSB	±1.5 LSB	±2 LSB	17 $\mu\text{V}/^\circ\text{C}$	50 $\text{ppm}/^\circ\text{C}$	1.3 mV
	±2.5 V	±0 ~ 2.75 V	±1 LSB	±2 LSB	±1.5 LSB	±2 LSB	20 $\mu\text{V}/^\circ\text{C}$	55 $\text{ppm}/^\circ\text{C}$	0.67 mV
	±1 V	±0 ~ 1.375 V	±1 LSB	±2.5 LSB	±2 LSB	±2.5 LSB	20 $\mu\text{V}/^\circ\text{C}$	60 $\text{ppm}/^\circ\text{C}$	0.34 mV
	±500 mV	±0 ~ 687.5 mV	-	±5 LSB	±3 LSB	±3.5 LSB	20 $\mu\text{V}/^\circ\text{C}$	67 $\text{ppm}/^\circ\text{C}$	0.16 mV
Current Inputs	0 ~ 20 mA	22 mA	±1 LSB	±1 LSB	±1.5 LSB	±2 LSB	nA/°C	ppm/°C	5.3 μA
	4 ~ 20 mA	22 mA	±1 LSB	±1 LSB	±1.5 LSB	±2 LSB	nA/°C	ppm/°C	5.3 μA

Table 6: ADAM-5017H input signal ranges

ADAM-5017UH 8-channel Ultra high speed analog input module

The ADAM-5017UH is a 12-bit plus sign bit, 8-channel analog differential input module that provides programmable input ranges on each channel. It accepts voltage inputs (± 10 V and 0-10 V) and current inputs (0-20 mA and 4-20 mA). The module provides data to the host microprocessor in engineering units (mV, V or mA) or two's complement format. Its sampling rate depends on the data format received: up to 200k Hz (total). Space is reserved for 125-ohm, 0.1%, 10 ppm resistors (See Figure 9). Each input channel has 3000 V_{DC} of optical isolation between the outside analog input line and the module, protecting the module and peripherals from high input line voltages. Additionally, the module uses analog multiplexers with active overvoltage protection. The active protection circuitry assures that signal fidelity is maintained even under fault conditions that would destroy other multiplexers. The analog inputs can withstand a constant 70 Vp-p input with ± 15 V supplies. The jumpers of ADAM-5017UH are designed for current input.

ADAM-5017UH

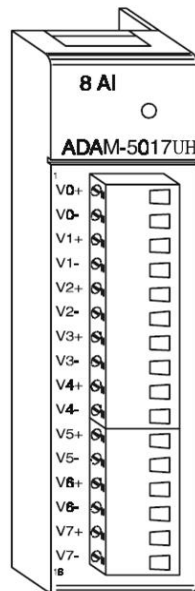

Figure 11: ADAM-5017UH module frontal view

Application wiring

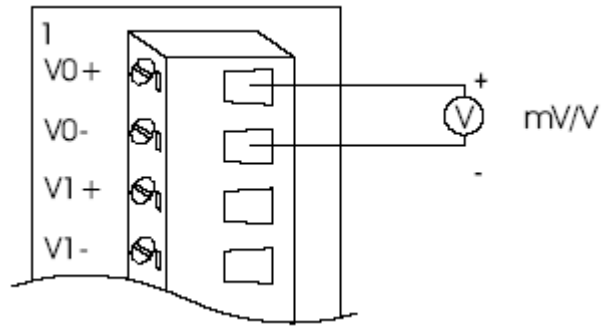

Figure 12: Millivolt and volt input

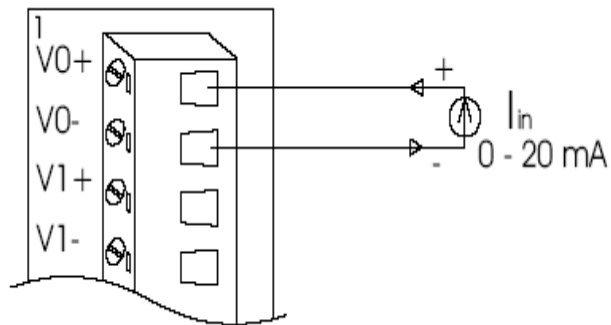

Figure 13: Process current input

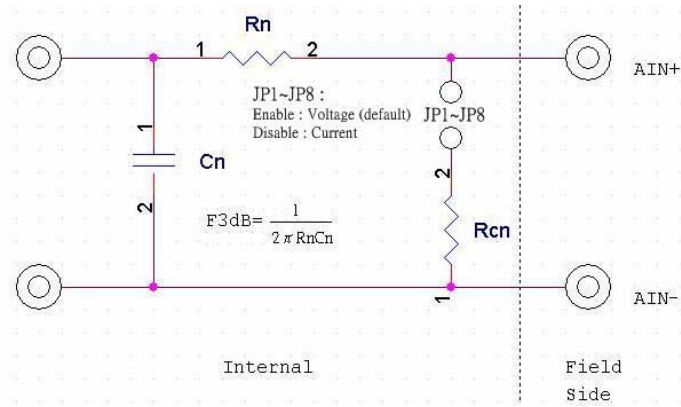

Figure 14: Locations of RC Filter Jumper setting

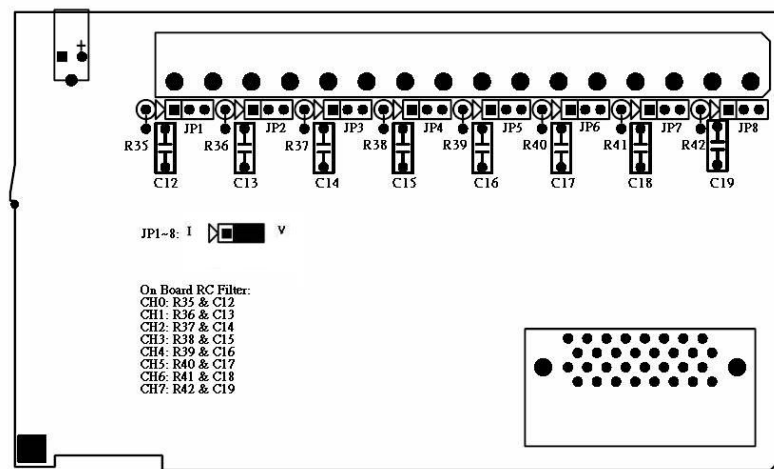

Figure 15: Locations of RC Filter Jumper setting

Note: To maintain measurement accuracy please short channels not in use.

Technical specifications of ADAM-5017UH

Analog Input Channels	Eight differential
Resolution	12 bits
Input Type	mV, V, mA
Input Range	+0~10V , ± 10 V , +4~20mA and ± 20 mA
Isolation Voltage	3000 V _{DC}
Sampling Rate	200k samples/sec (single channel) 50k samples/sec (8 channel)
Analog Input Signal Limit	15 V max.
Max. allowable voltage difference between two connectors in a module	15 V max.
Input Impedance	20 Mohms (Voltage input) 120 Ω (current input)
Bandwidth	200kHz
Accuracy	$\pm 0.1\%$ or better
Low or high pass filter	Configured by User
CMR @ 50/60 Hz	92 dB min.
Power Requirements	+ 10 to + 30 V _{DC} (non-regulated)
Power Consumption	1.75 W (typical); 2.2W (max)
Signal Input Bandwidth	200kHz for both voltage and current inputs

Table 7: Technical specifications of ADAM-5017UH

	Input Range	Offset Error @ 25°C	Offset Error @ -10 to +70°C	Gain Error @ 25°C	Gain Error @ -10 to +70°C	Display Resolution
Voltage Inputs	0 ~ 10 V	± 1 LSB	± 2 LSB	± 1 LSB	± 2 LSB	2.7 mV
	± 10 V	± 1 LSB	± 2 LSB	± 1 LSB	± 2 LSB	2.7 mV
Current Inputs	0 ~ 20 mA	± 1 LSB	± 1 LSB	± 1.5 LSB	± 2 LSB	5.3 μ A
	4 ~ 20 mA	± 1 LSB	± 1 LSB	± 1.5 LSB	± 2 LSB	5.3 μ A

Table 8: ADAM-5017UH input signal ranges

~~ADAM-5018 7-channel thermocouple input module~~

The ADAM-5018 is a 16-bit, 7-channel thermocouple input module that features programmable input ranges on all channels. It accepts millivolt inputs (± 15 mV, ± 50 mV, ± 100 mV, ± 500 mV), voltage inputs (± 1 V, ± 2.5 V), current input (± 20 mA, requires 125 ohms resistor) and thermocouple input (J, K, T, R, S, E, B).

The module forwards the data to the host computer in engineering units (mV, V, mA or temperature $^{\circ}$ C). An external CJC on the plug-in terminal is designed for accurate temperature measurement.

ADAM-5018

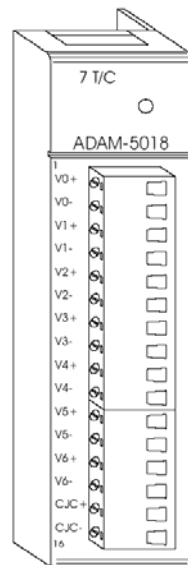

Figure 16: ADAM-5018 module frontal view

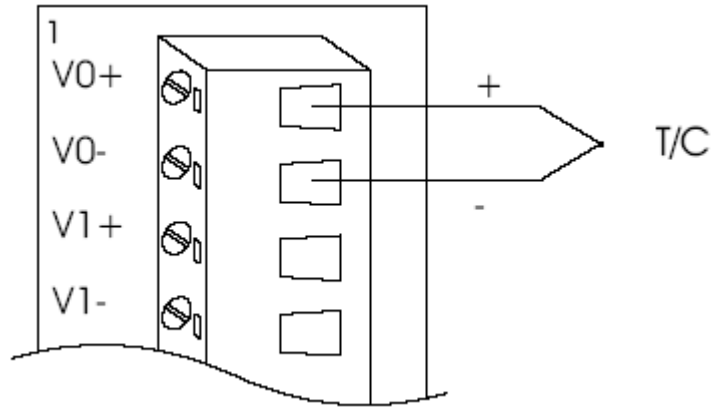

Figure 17: Thermocouple input

Technical specifications of ADAM-5018

Analog Input Channels	Seven differential
Input Type	mV, V, mA, Thermocouple
Input Range	± 15 mV, ± 50 mV, ± 100 mV, ± 500 mV, ± 1 V, ± 2.5 V and ± 20 mA
T/C Type and Temperature Range	J 0 to 760 °C K 0 to 1370 °C T -100 to 400 °C E 0 to 1400 °C R 500 to 1750 °C S 500 to 1750 °C B 500 to 1800 °C
Isolation Voltage	3000 V _{DC}
Sampling Rate	10 samples/sec (total)
Input Impedance	2 Mohms
Bandwidth	13.1 Hz @ 50 Hz, 15.72 Hz @ 60 Hz
Accuracy	$\pm 0.1\%$ or better
Zero Drift	± 0.3 μ V/°C
Span Drift	± 25 PPM/°C
CMR @ 50/60 Hz	92 dB min.
Power Consumption	1.2 W

Table 9: Technical specifications of ADAM-5018

ADAM-5018P 7-channel thermocouple input module

The ADAM-5018P is a 16-bit, 8-channel Thermocouple Independent input module that provides programmable input ranges on all channels. It accepts Various Thermocouple inputs (Type J, K, T, E, R, S, B) and provides data to the host computer in engineering units ($^{\circ}\text{C}$) In order to satisfy various temperature requirements in one module, each analog channel is allowed to configure an individual range for several applications.

ADAM-5018P

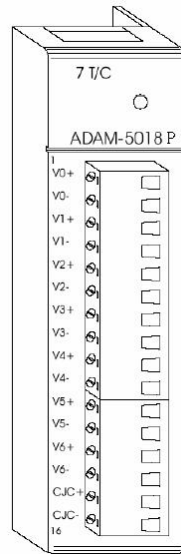

Figure 18: ADAM-5018P module frontal view

Application wiring

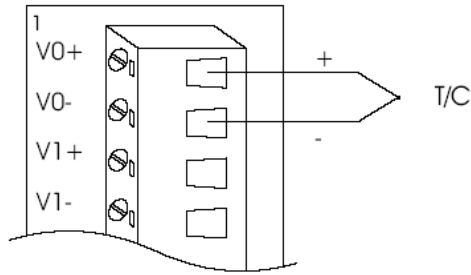

Figure 19: Thermocouple input

Technical specifications of ADAM-5018P

Analog Input Channels	Seven differential & independent thermocouple														
Input Type	mV, V, mA, Thermocouple														
Input Range	± 15 mV, ± 50 mV, ± 100 mV, ± 500 mV, ± 1 V, ± 2.5 V and ± 20 mA														
T/C Type and Temperature Range	<table> <tr> <td>J</td> <td>0 to 760 °C</td> </tr> <tr> <td>K</td> <td>0 to 1370 °C</td> </tr> <tr> <td>T</td> <td>-100 to 400 °C</td> </tr> <tr> <td>E</td> <td>0 to 1400 °C</td> </tr> <tr> <td>R</td> <td>500 to 1750 °C</td> </tr> <tr> <td>S</td> <td>500 to 1750 °C</td> </tr> <tr> <td>B</td> <td>500 to 1800 °C</td> </tr> </table>	J	0 to 760 °C	K	0 to 1370 °C	T	-100 to 400 °C	E	0 to 1400 °C	R	500 to 1750 °C	S	500 to 1750 °C	B	500 to 1800 °C
J	0 to 760 °C														
K	0 to 1370 °C														
T	-100 to 400 °C														
E	0 to 1400 °C														
R	500 to 1750 °C														
S	500 to 1750 °C														
B	500 to 1800 °C														
Isolation Voltage	3000 V _{DC}														
Sampling Rate	10 samples/sec (Selected by Utility)														
Input Impedance	20 Mohms (Voltage input) 120 Ω (current input)														
Bandwidth	13.1 Hz @ 50 Hz, 15.72 Hz @ 60 Hz														
Accuracy	$\pm 0.1\%$ or better														
Zero Drift	± 6 μ V/°C														
Span Drift	± 25 PPM/°C														
CMR @ 50/60 Hz	92 dB min.														
Power Consumption	0.5 W														

Table 10: Technical specifications of ADAM-5018P

2. Analog Output Modules

ADAM-5024 4-channel analog output module

The ADAM-5024 is a 4-channel analog output module. It receives its digital input through the RS-485 interface of the ADAM-5510 system module from the host computer. The format of the data is engineering units. It then uses the D/A converter controlled by the system module to convert the digital data into output signals.

You can specify slew rates and start up currents through the configuration software. The analog output can also be configured as current or voltage through the software utility. The module protects your equipment from ground loops and power surges by providing opto-isolation of the D/A output and transformer based isolation up to 500 V_{DC}.

Slew rate

The slew rate is defined as the slope indicated the ascending or descending rate per second of the analog output from the present to the required.

ADAM-5024

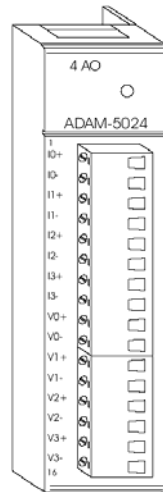

Figure20: ADAM-5024 module frontal view

Application wiring

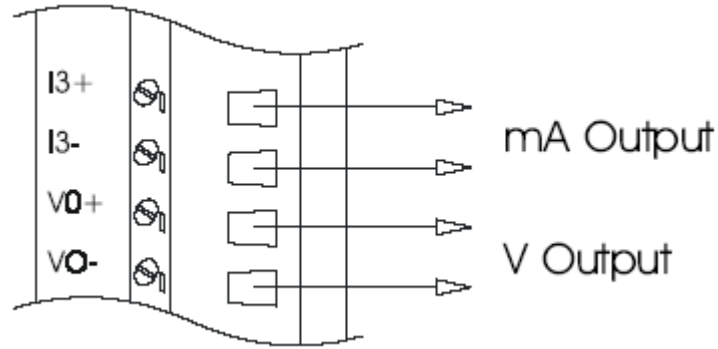

Figure 21: Analog output

Technical specifications of ADAM-5024

Analog Output Channels	Four
Output Type	V, mA
Output Range	0-20mA, 4-20mA, 0-10V
Isolation Voltage	3000 Vdc
Output Impedance	0.5 Ohms
Accuracy	±0.1% of FSR for current output ±0.2% of FSR for voltage output
Zero Drift	Voltage output: ±30 μ V/°C Current output: ±0.2 μ A/°C
Resolution	±0.015% of FSR
Span Temperature Coefficient	±25 PPM/°C
Programmable Output Slope	0.125-128.0 mA/sec 0.0625-64.0 V/sec
Current Load Resistor	0-500 Ohms (source)
Power Consumption	2.5W (Max.)

Table 11: Technical specifications of ADAM-5024

I/O Module Introduction

3. Analog I/O Modules Calibration

Analog input/output modules are calibrated when you receive them. However, calibration is sometimes required. No screwdriver is necessary because calibration is done in software with calibration parameters stored in the ADAM-5000 analog I/O module's onboard EEPROM.

The ADAM-5000 system comes with the ADAM utility software that supports calibration of analog input and analog output. Besides the calibration that is carried out through software, the modules incorporate automatic Zero Calibration and automatic Span Calibration at boot up or reset.

Analog input module calibration

Modules: ADAM-5017, 5017H, 5018

1. Apply power to the ADAM-5000 system that the analog input module is plugged into and let it warm up for about 30 minutes
2. Assure that the module is correctly installed and is properly configured for the input range you want to calibrate. You can do this by using the ADAM utility software.
3. Use a precision voltage source to apply a span calibration voltage to the module's V0+ and V0- terminals. (See Table 12 for reference voltages for each range.)

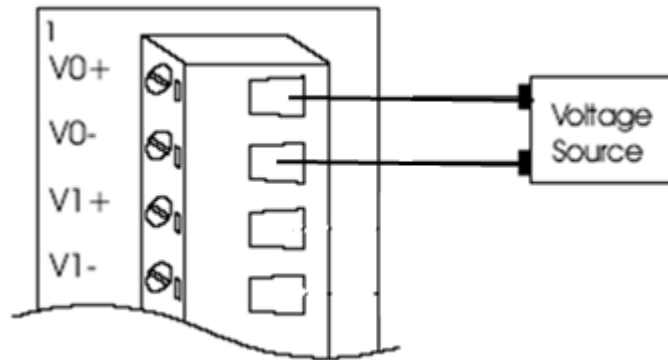

Figure 22: Applying calibration voltage

- Execute the Zero Calibration command (also called the Offset Calibration command).

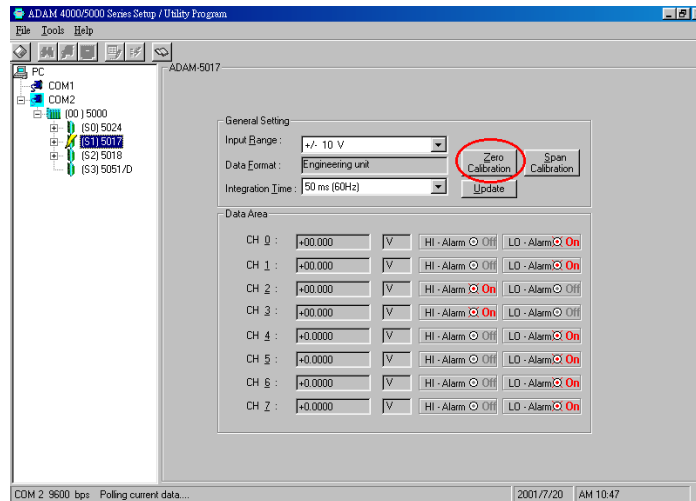

Figure 23: Zero calibration

- Execute the Span Calibration command. This can be done with the ADAM utility software.

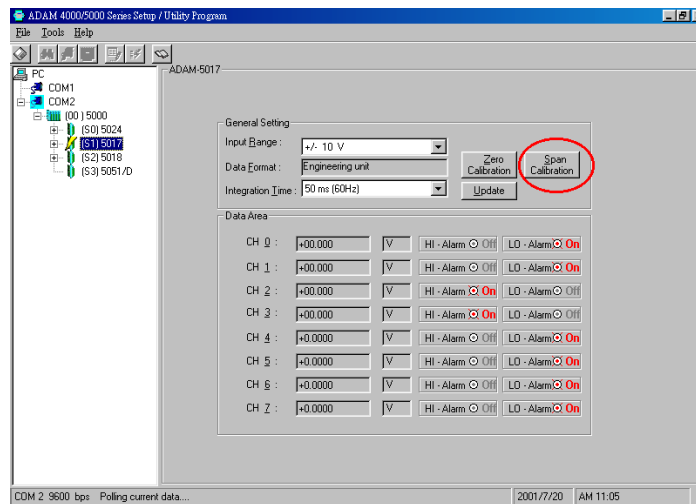

Figure 24: Span calibration

I/O Module Introduction

6. CJC Calibration (only for T/C input module)

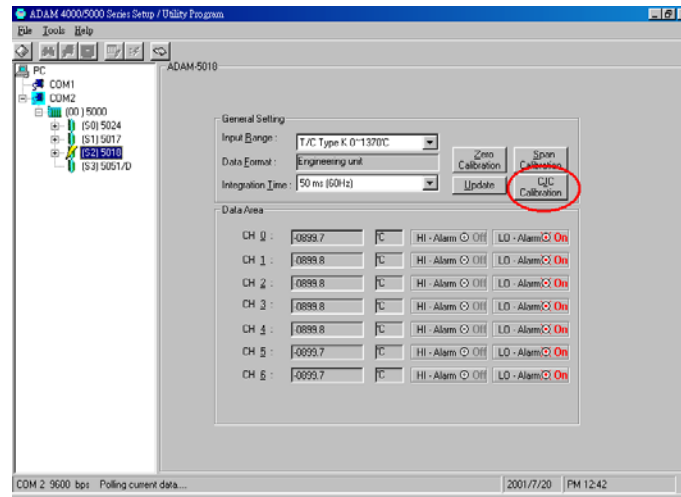

Figure 25: Cold junction calibration

- * **Note:** Zero calibration and span calibration must be completed before CJC calibration. To calibrate CJC, the thermocouple attached to ADAM-5018 and a standard thermometer should be used to measure a standard known temperature, such as the freezing point of pure water. The amount of offset between the ADAM-5018 and the standard thermometer is then used in the ADAM utility to complete CJC calibration.

Calibration voltage (ADAM-5017/5018)

Module	Input Range Code (Hex)	Input Range	Span Calibration Voltage
5018	00h	±15 mV	+15 mV
	01h	±50 mV	+50 mV
	02h	±100 mV	+100 mV
	03h	±500 mV	+500 mV
	04h	±1 mV	+1 V
	05h	±2.5 V	+2.5 V
	06h	±20 mV	+20 mA (1)
	0Eh	J thermocouple 0 to 1370°C	+50 mV
	0Fh	K thermocouple 0 to 1370°C	+50 mV
	10h	T thermocouple -100 to 400°C	+22 mV
	11h	E thermocouple 0 to 1000°C	+80 mV
	12h	R thermocouple 500 to 1750°C	+22 mV
	13h	S thermocouple 500 to 1800°C	+22 mV
	14h	B thermocouple 500 to 1800°C	+152 mV
5017	07h	Not used	
	08h	°C±10 V	+10 V
	09h	±5 V	+5 V
	0Ah	±1 V	+1 V
	0Bh	±500 mV	+500 mV
	0Ch	±150 mV	+150 mV
	0Dh	±20 mA	+20 mV (1)

Table 12: Calibration voltage of ADAM-5017/5018

Calibration voltage (ADAM-5017H)

Module	Input Range Code (Hex)	Input Range	Span Calibration Voltage
5017H	00h	±10 V	+10 V
	01h	0 ~ 10 V	+10 V
	02h	±5 V	+5 V
	03h	0 ~ 5 V	+5 V
	04h	±2.5 V	+2.5 V
	05h	0 ~ 2.5 V	+2.5 V
	06h	±1 V	+1 V
	07h	0 ~ 1 V	+1 V
	08h	±500 mV	+500 mV
	09h	0 ~ 500 mV	+500 mV
	0ah	4 ~ 20 mA	*(1)
	0bh	0 ~ 20 mA	*(1)

Table 13: Calibration voltage of ADAM-5017H

Note: You can substitute 2.5 V for 20 mA if you remove the current conversion resistor for that channel. However, the calibration accuracy will be limited to 0.1% due to the resistor's tolerance.

Calibration voltage (ADAM-5018P)

Module	Input Range Code (Hex)	Input Range	Span Calibration Voltage
5018P	00h	±15 mV	+15 mV
	01h	±50 mV	+50 mV
	02h	±100 mV	+100 mV
	03h	±500 mV	+500 mV
	04h	±1 mV	+1 V
	05h	±2.5 V	+2.5 V
	06h	±20 mV	+20 mA (1)
	07h	4 ~ 20 mA	+16 mA (1)
	0Eh	J thermocouple 0 to 1370°C	+50 mV
	0Fh	K thermocouple 0 to 1370°C	+50 mV
	10h	T thermocouple -100 to 400°C	+22 mV
	11h	E thermocouple 0 to 1000°C	+80 mV
	12h	R thermocouple 500 to 1750°C	+22 mV
	13h	S thermocouple 500 to 1800°C	+22 mV
	14h	B thermocouple 500 to 1800°C	+152 mV

Table 14: Calibration voltage of ADAM-5018P

Calibration voltage (ADAM-5017UH)

Module	Input Range Code (Hex)	Input Range	Span Calibration Voltage
5017H	08h	±10 V	+10 V
	48h	0 ~ 10 V	+10 V
	46h	0 ~ 20 mA	*(1)
	07h	4 ~ 20 mA	*(1)

Table 15: Calibration voltage of ADAM-5017UH

Note: You can substitute 2.5 V for 20 mA if you remove the current conversion resistor for that channel. However, the calibration accuracy will be limited to 0.1% due to the resistor's tolerance.

Analog output module calibration

The output current of analog output modules can be calibrated by using a low calibration value and a high calibration value. The analog output modules can be configured for one of two ranges: 0-20 mA and 4-20 mA. Since the low limit of the 0-20 mA range (0 mA) is internally an absolute reference (no power or immeasurably small power), just two levels are needed for calibration: 4 mA and 20 mA.

1. Apply power to the ADAM-5000 system including the analog output module for about 30 minutes.
2. Assure that the module is correctly installed and that its configuration is according to your specifications and that it matches the output range you want to calibrate. You can do this by using the ADAM utility software.
3. Connect either a 5-digit mA meter or voltmeter with a shunt resistor (250 ohms, .01 % and 10 ppm) to the screw terminals of the module.

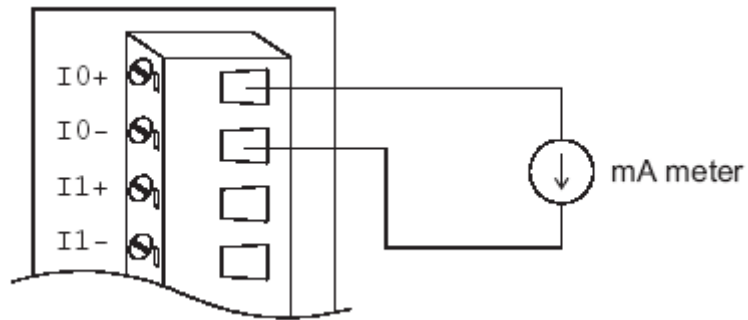

Figure 26: Output module calibration

I/O Module Introduction

4. Issue the Analog Data Out command to the module with an output value of 4 mA.
5. Check the actual output value at the modules terminals. If this does not equal 4 mA, use the "Trim" option in the "Calibrate" submenu to change the actual output. Trim the module until the mA meter indicates exactly **4 mA**, or in case of a voltage meter with shunt resistor, the meter indicates exactly **1 V**. (When calibrating for **20 mA** using a voltage meter and shunt resistor, the correct voltage should be **5 V**.)
6. Issue the 4 mA Calibration command to indicate that the output is calibrated and to store the calibration parameters in the module's EEPROM.
7. Execute an Analog Data Out command with an output value of 20 mA. The module's output will be approximately 20 mA.
8. Execute the Trim Calibration command as often as necessary until the output current is equal to exactly 20 mA.
9. Execute the 20 mA Calibration command to indicate that the present output is exactly 20 mA. The analog output module will store its calibration parameters in the unit's EEPROM.

4. Digital Input/Output Modules

ADAM-5050 16-channel universal digital I/O module

The ADAM-5050 features sixteen digital input/output channels. Each channel can be independently configured to be an input or an output channel by the setting of its DIP switch. The digital outputs are open collector transistor switches that can be controlled from the ADAM-5000. The switches can also be used to control solid-state relays, which in turn can control heaters, pumps and power equipment. The ADAM-5000 can use the module's digital inputs to determine the state of limit or safety switches, or to receive remote digital signals.

Warning! A channel may be destroyed if it is subjected to an input signal while it is configured to be an output channel.

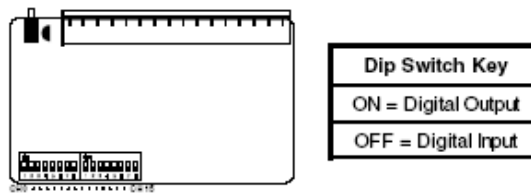

Figure 27: Dip switch setting for digital I/O channel

ADAM-5050

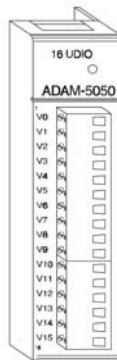

Figure 28: ADAM-5050 module frontal view

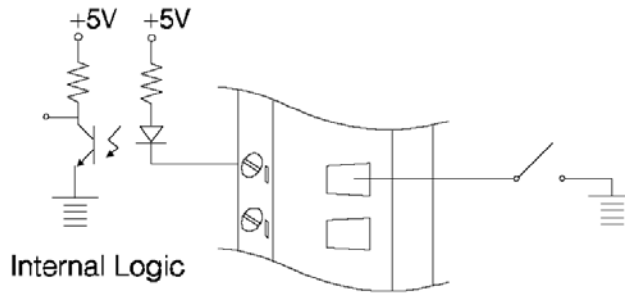

Figure 29: Dry contact signal input (ADAM-5050)

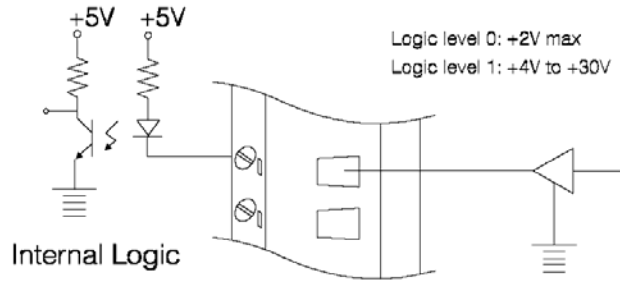

Figure 30: Wet contact signal input (ADAM-5050)

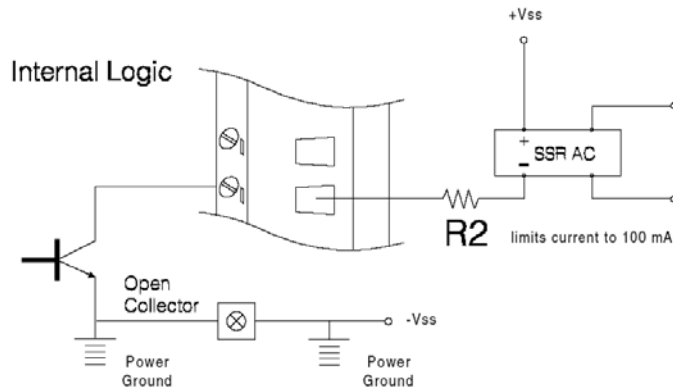

Figure 31: Digital output used with SSR (ADAM-5050/5056)

Technical specifications of ADAM-5050

Points	16
Channel Setting	Bitwise selectable by DIP switch
Digital Input	Dry Contact Logic Level 0: close to GND Logic Level 1: open Wet Contact Logic Level 0: +2 V max Logic Level 1: +4 V to 30 V
Digital Output	Open collector to 30 V, 100mA max load
Power Dissipation	450 mW
Power Consumption	0.4 W

Table 16: Technical specifications of ADAM-5050

I/O Module Introduction

ADAM-5051(D) 16-channel digital input module

The ADAM-5051 provides sixteen digital input channels. The ADAM-5051 can use the module's digital inputs to determine the state of limit or safety switches or to receive remote digital signals.

ADAM-5051/5051 D

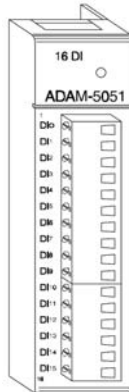

Figure 32: ADAM-5051 module frontal view

Application wiring

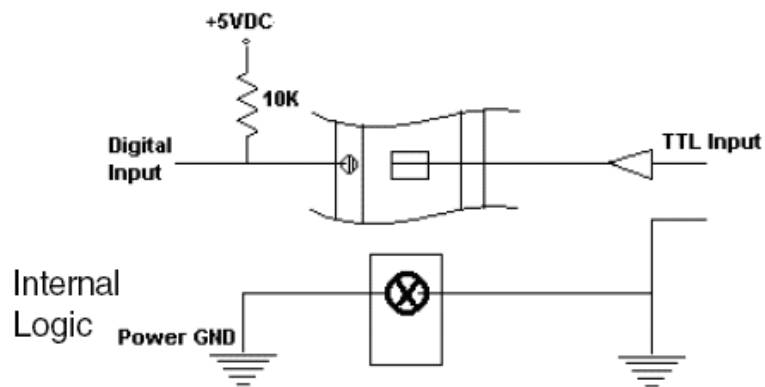

Figure 33: TTL input (ADAM-5051/5051D)

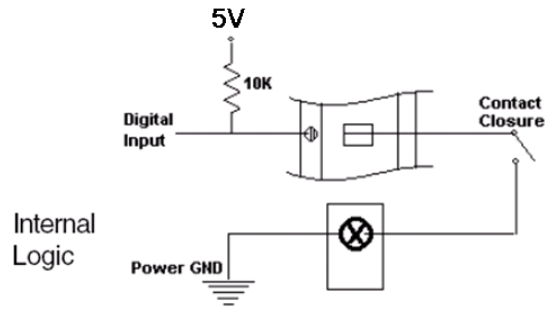

Figure 34: Contact closure input (ADAM-5051/5051D)

Technical specifications of ADAM-5051/5051D

Points	16
Digital input	Logic level 0: + 1 V max Logic level 1: + 3.5 to 30 V Pull up current: 0.5 mA 10 kΩ resistor to + 5 V
Power consumption	0.3 W
Indicator	ADAM-5051 D only

Table 17: Technical specifications of ADAM-5051

I/O Module Introduction

ADAM-5051S 16-channel Isolated Digital Input Module with LED

The ADAM-5051S provides 16 isolated digital input channels for critical environments need individual channel isolating protection. Different from other ADAM-5000 I/O modules, ADAM-5051S designed with 21 pins plug terminal.

ADAM-5051S

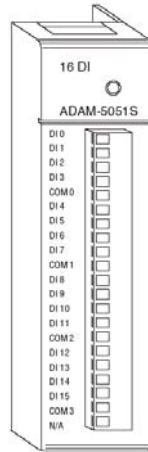

Figure 35: ADAM-5051S module front view

Application Wiring

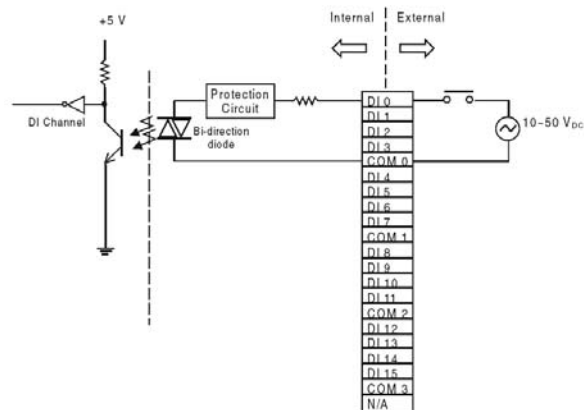

Figure 36: ADAM-5051S module wiring diagram

Technical specification of ADAM-5051S

Point	16(4-channel/group)
Digital Input	Logic Level 0: + 3 V max Logic Level 1: + 10 to 50 V
Optical Isolation	2500 V _{DC}
Opto-isolator response time	25 μ s
Over-voltage Protection	70 V _{DC}
Power Consumption	0.8 W
LED Indicator	On when active
I/O Connector Type	21-pin plug-terminal

Table 18: Technical specification of ADAM-5051S

ADAM-5052 8-channel isolated digital input module

The ADAM-5052 provides eight fully independent isolated channels. All have 5000 V_{RMS} isolation to prevent ground loop effects and to prevent damage from power surges on the input lines.

ADAM-5052

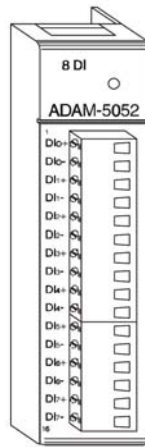

Figure 37: ADAM-5052 module frontal view

Application wiring

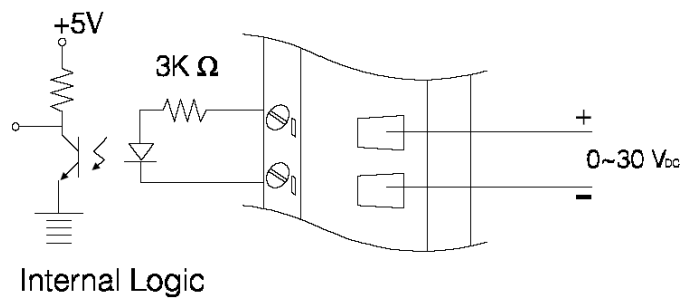

Figure 38: Isolation digital input (ADAM-5052)

Technical specifications of ADAM-5052

Points	8 Differential
Digital input	Logic level 0: + 1 V max Logic level 1: + 3.5 to 30 V Isolation voltage: 5000 V _{RMS} Resistance: 3 k Ω / 0.5 W
Power consumption	0.4 W

Table 19: Technical specifications of ADAM-5052

I/O Module Introduction

ADAM-5053S 32-channel Isolated Digital Input Module

The ADAM-5053S provides 32 isolated digital input channels for critical environments need individual channel isolating protection. Different from other ADAM-5000 I/O modules, ADAM-5053S designed with 40-pin flat cable wiring terminal.

ADAM-5053S

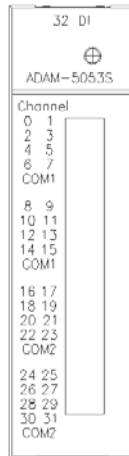

Technical specification of ADAM-5053S

Point	32
Digital Input	Logic Level 0: + 5 V max Logic Level 1: 19 to 35 V
Optical Isolation	2500 V _{DC}
Opto-isolator response time	25 μs
Over-voltage Protection	35 V _{DC}
Power Consumption	1 W (max.)
I/O Connector Type	40-pin flat cable wiring terminal

Application Wiring

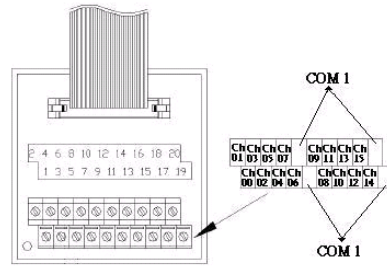

ADAM-5038S Digital Input Wiring

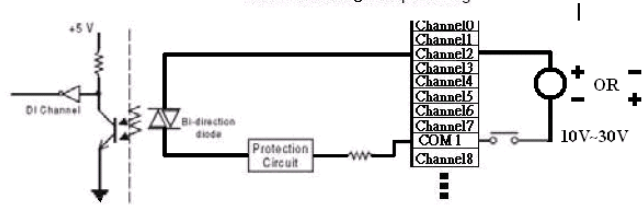

I/O Module Introduction

ADAM-5055S 16-channel Isolated Digital I/O Module with LED

The ADAM-5056S provides 8 isolated digital input and 8 isolated output channels for critical environments need individual channel isolating protection. Different from other ADAM-5000 I/O modules, ADAM-5055S designed with 21 pins plug terminal.

ADAM-5055S

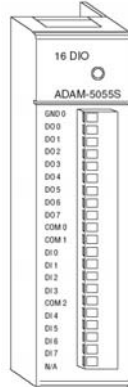

Figure 39: ADAM-5055S module front vie

Application Wiring

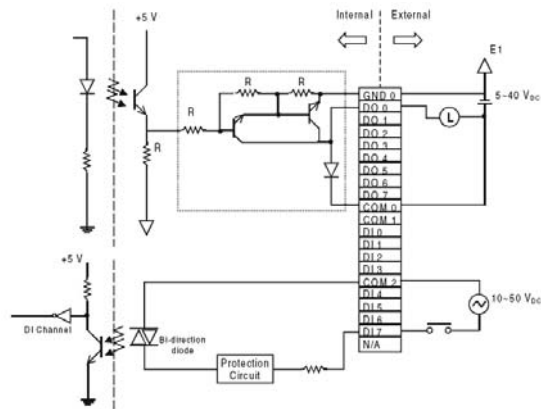

Figure 40: ADAM-5055S module wiring diagram

Technical specification of ADAM-5055S

Points	16
Digital Output	8 (8-channel/group)
Open collector to 40 V	200 mA max load per channel
Optical Isolation	2500 V _{DC}
Opto-isolator response time	25 μs
Supply Voltage	5 ~ 40 V _{DC}
Digital Input	8(4-channel/group) Dry Contact Logic Level 0: close to GND Logic Level 1: open Wet Contact Logic Level 0: + 3 V max Logic Level 1: + 10 to 50 V
Dry Contact & Wet contact	Selectable
Optical Isolation	2500 V _{DC}
Opto-isolator response time	25 μs
Over-voltage Protect	70 V _{DC}
Power Consumption	0.68 W
LED Indicator	On when active
I/O Connector Type	21-pin plug-terminal

Table 20: Technical specification of ADAM-5055S

I/O Module Introduction

Jumper Setting

Below is the jumper setting for both JP1 & JP2.

JP1(DI0~DI3)

JP2(DI4~DI7)



Wet Contact



Dry Contact

Dry Contact wiring

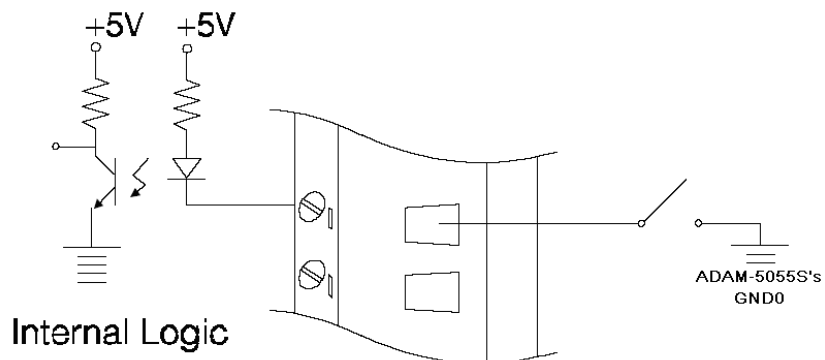

Note: Be sure to adjust the jumper to the right place.

ADAM-5056(D) 16-channel digital output module w/LED

The ADAM-5056 features sixteen digital output channels. The digital outputs are open-collector transistor switches that you can control from the ADAM-5000 main unit. You also can use the switches to control solid-state relays.

ADAM-5056

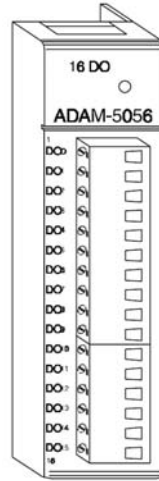

Figure 41: ADAM-5056 module frontal view

Application wiring

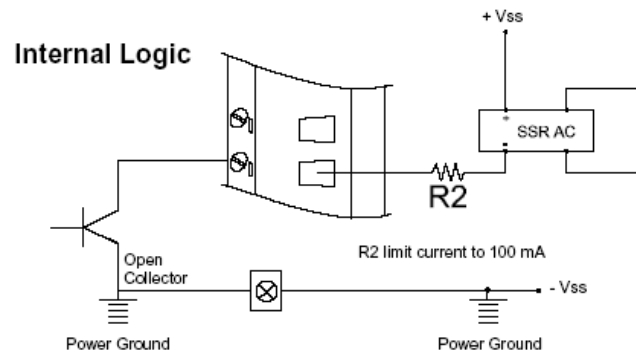

Figure 42: Digital output used with SSR (ADAM-5050/5056)

Technical specifications of ADAM-5056

There are 16-point digital input and 16-point digital output modules in the ADAM-5000 series. The addition of these solid state digital I/O devices allows these modules to control or monitor the interfaces between high power DC or AC lines and TTL logic signals. A command from the host converts these signals into logic levels suitable for the solid-state I/O devices.

Points	16
Digital output	Open collector to 30 V 100 mA max load
Power dissipation	450 mW
Power consumption	0.25 W

Table 21: Technical specifications of ADAM-5056

ADAM-5056S 16-channel Isolated Digital Output Module with LED

The ADAM-5056S provides 16 isolated digital output channels for critical environments need individual channel isolating protection. Different from other ADAM-5000 I/O modules, ADAM-5056S designed with 21 pins plug terminal.

ADAM-5056S

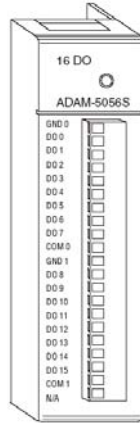

Figure 43: ADAM-5056S module front view

Application wiring

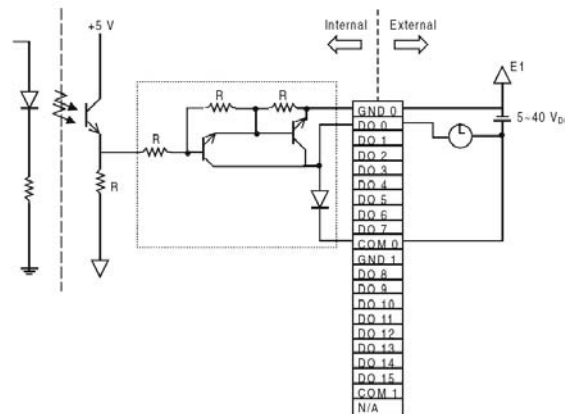

Figure 44: ADAM-5056S module wiring diagram

Technical Specification of ADAM-5056S

Points	16(8-channel/group)
Digital Output	Open collector to 40 V 200 mA max load per channel
Optical Isolation	2500 V _{DC}
Opto-isolator response time	25 μs
Supply Voltage	5 ~ 40 V _{DC}
Power consumption	0.6 W
LED Indicator	On when active
I/O Connector Type	21-pin plug-terminal

Table 22: Technical specification of ADAM-5055S

ADAM-5056SO 16-channel Isolated Digital Output Module with LED

The ADAM-5056SO provides 16 channels source type isolated digital output for critical environments need individual channel isolating protection. Addition to the source output wiring, all of the specification and command sets are the same with ADAM-5056S.

ADAM-5056SO

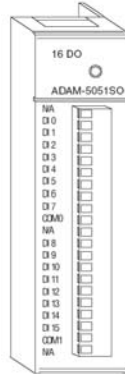

Figure 45: ADAM-5056SO module front view

Application wiring

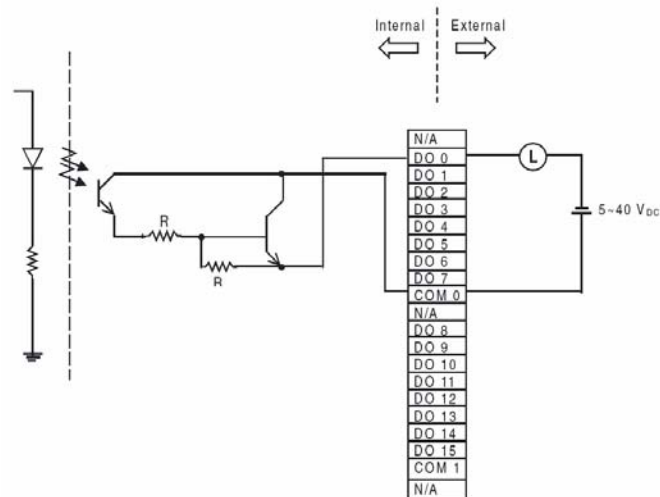

Figure 46: ADAM-5056SO module wiring diagram

Technical Specification of ADAM-5056SO

Points	16(8-channel/group)
Digital Output	Open collector to 40 V 200 mA max load per channel
Optical Isolation	2500 VDC
Opto-isolator response time	25 us
Supply Voltage	5 ~ 40 VDC
Power consumption	0.6 W
LED Indicator	On when active
I/O Connector Type	21-pin plug-terminal

Table 23: Technical specification of ADAM-5056SO

I/O Module Introduction

~~ADAM-5057S 32-channel Isolated Digital Output Module~~

The ADAM-5057S provides 32 isolated digital output channels for critical environments need individual channel isolating protection. Different from other ADAM-5000 I/O modules, ADAM-5057S designed with 40-pin flat cable wiring terminal.

ADAM-5057S

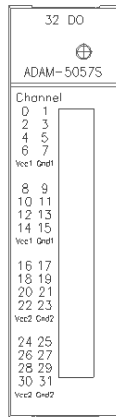

Technical specification of ADAM-5057S

Points	32
Digital Output	Contact with ADAM-3920R
Optical Isolation	2500 V _{DC}
Contact Rating	10 A 250V _{AC} , 10 A 30V _{DC}
Power Input	+24 V _{DC}
Power consumption	1 W (max.)
Relay Type	SPST (Form A)
I/O Connector Type	40-pin flat cable wiring terminal

Application wiring

I/O Module Introduction

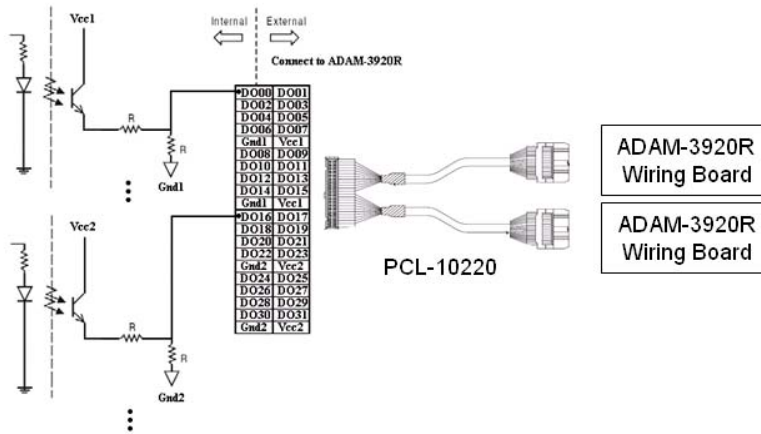

Note: Please be noted that the Cable, PCL-10220 & Wiring Board, ADAM-3920R are additional option.

Pin Assignments for ADAM-3920R

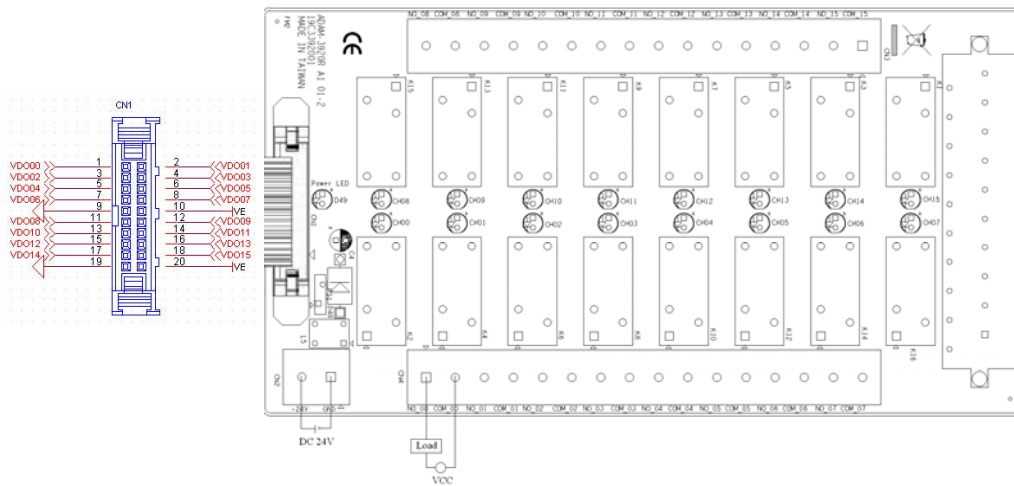

5. Relay Output Modules

ADAM-5060 relay output module

The ADAM-5060 relay output module is a low-cost alternative to SSR modules. It provides 6 relay channels, two of Form A and four of Form C.

ADAM-5060

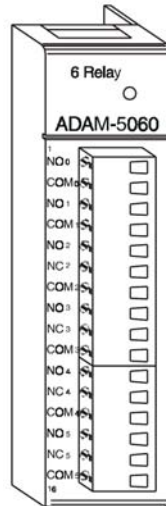

Figure 47: ADAM-5060 module frontal view

Application wiring

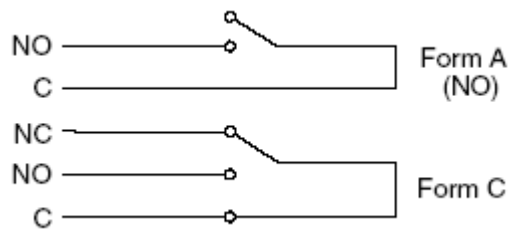

Figure 48: Relay output

Technical specifications of ADAM-5060

Points	6, two Form A and four Form C
Contact rating	AC: 125 V @ 0.6A; 250 V @ 0.3 A DC: 30 V @ 2 A; 110 V @ 0.6 A
Breakdown voltage	500 V _{AC} (50/60 Hz)
Relay on time (typical)	3 ms
Relay off time (typical)	1 ms
Total switching time	10 ms
Insulation resistance	1000 M Ω min. @ 500 V _{DC}
Power consumption	0.7 W

Table 24: Technical specifications of ADAM-5060

ADAM-5068 relay output module

The ADAM-5068 relay output module provides 8 relay channels of Form A. Switches can be used to control the solid-state relays.

ADAM-5068

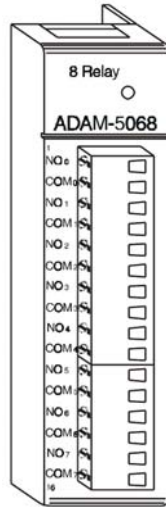

Figure 49: ADAM-5068 module frontal view

Application wiring

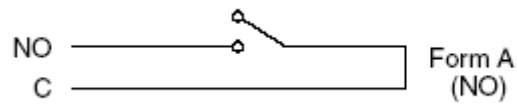

Figure 50: Relay output

Points	8 Form A
Contact Rating	AC: 120 V @ 0.5 A DC: 30 V @ 1 A
Breakdown Voltage	500 V _{AC} (50/60 Hz)
Relay On Time (typical)	7 msec.
Relay Off Time (typical)	3 msec.
Total Switching Time	10 msec.
Power Consumption	2.0 W

Table 25: Technical specifications of ADAM-5068

ADAM-5069 relay output module

The ADAM-5069 relay output module provides 8 relay channels of Form A. Switches can be used to control the relays. Considered to user friendly, the ADAM-5069 also built with LED indicator for status reading easily. And it also provides a choice to clear or keep output status when reset by adjusting a jumper.

Specification

- **Number of Output Channel:** 8 Form A
- **Contact Rating:** AC:250V@5A
DC:30V@5A

- **Breakdown Voltage :** 750 V_{AC} (50/60 Hz)
- **Insulation Resistance:** 1000M Ω @500V_{DC}
- **LED Indicator:** On: Active
Off: Non-active
- **Power Consumption:** 0.25W(typical) 2.2W(Max)
- **Isolation Resistance:** 4000 V_{RMS}
- **Relay response Time:** ON :5 ms
Off :5.6 ms
- Clear or Keep Relay Status when reset (selectable by jumper)

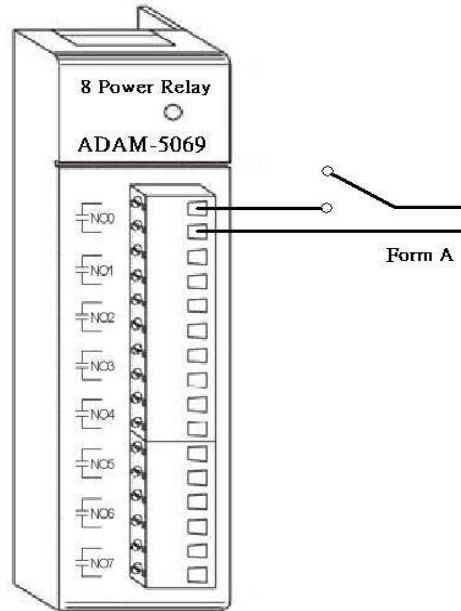

Figure 51: the wiring of ADAM-5069 module frontal view

6. Counter/Frequency Module

Overview

Compatible ADAM-5000 Series Main Units

ADAM-5080 is a 4-channel counter/frequency module designed to be implemented within the following Advantech ADAM-5000 series main units:

ADAM-5000/485

ADAM-5510

ADAM-5511

ADAM-5510M

ADAM-5510E

ADAM-5510/TCP

ADAM-5510E/TCP

Please make sure that the ADAM-5080 counter/frequency module is properly inserted into the compatible main units.

ADAM-5080 4-channel Counter/Frequency Module

With ADAM-5080 4-Channel Counter/Frequency Module, users can select either counter or frequency mode for data output. ADAM-5080 offers users a variety of very flexible and versatile applications such as below:

Counter Mode or Frequency Mode

If you want to measure the number of input signals for totalizer function, you may use counter mode to measure quantities such as movement and flow quantity. Alternatively, you can also select frequency mode to calculate the instantaneous differential of quantities such as rotating speed, frequency or flow rate, and present them in specific engineering formats.

Up/Down or Bi-direction Function

When operating in counter mode, you can choose either the Up/Down function or the Bi-direction function for different application purposes. The counter will count up or down according to your applications. This counting function helps users obtain the most accurate data.

Alarm Setting Function

While in counter mode, you can set alarm status--Disable and Latch. If you want to disable it, you can select Disable. If Latch status is selected, it means the Alarm status will be "latched" whenever the alarm is being triggered. Once the alarm status being "latched," it will thereafter stay in that triggered state. Users will have to issue a "Clear Alarm Status" command to return the "latched" alarm status back to normal. Users can designate the high-limit value and low-limit value to regulate your alarm behavior through the utility program.

Digital Output Mapping

Users can either run the utility program or issue a "Set Alarm Connection" command to designate a specific digital output module for the alarm signal to be sent through.

ADAM-5080 Module Diagram

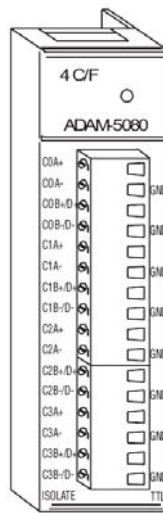

Figure 52: ADAM-5080 Module

ADAM-5080 Application Wiring

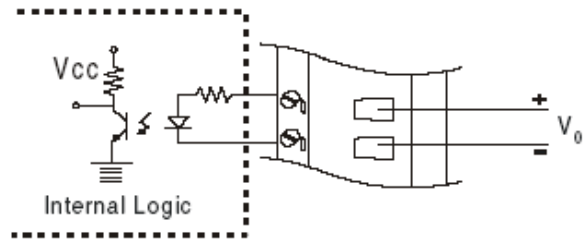

Figure 53: Isolated Input Level

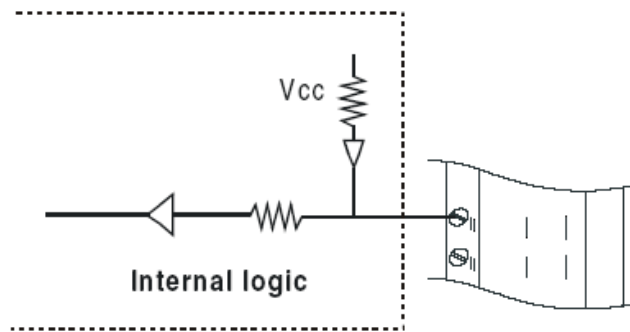

Figure 54: TTL Input Level

ADAM-5080 Counter/Frequency Mode Selection

Users can select Bi-direction, Up/Down Counter or Frequency option as shown in Figure 44.

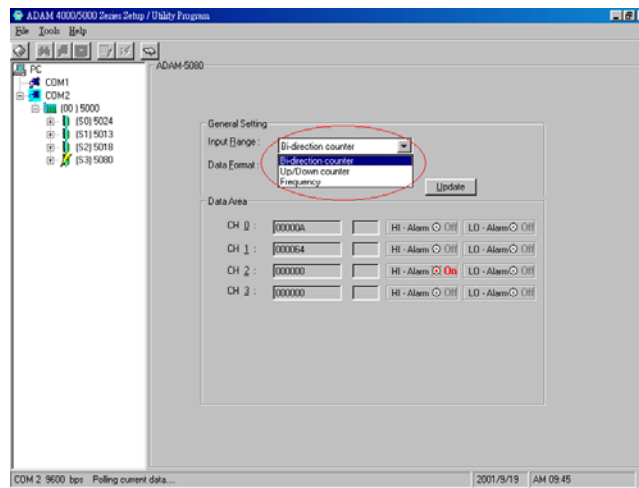

Figure 55: Counter / Frequency Mode

Note: All four channels of ADAM-5080 will operate simultaneously in the mode you have selected. i.e. If you switch the ADAM-5080 to Counter Mode, all four channels will operate in Counter Mode.

Features -- Counter Mode

Up/Down Counting

The Up/Down Counter Function offers two types of counting: Up Counting (increasingly) and Down Counting (decreasingly).

Up Counting: when C0A+ and C0A- sense any input signals, the counter counts up.

Down Counting: when C0B+ and C0B- sense any input signals, the counter counts down. On receiving Up and Down signal simultaneously, the counter will not perform each specific counting accordingly, but will remain at the previous counting value, since these simultaneous signals won't have any effect on counting values.

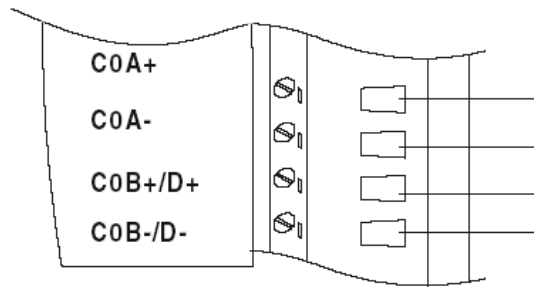

Figure 56: Wiring for Up/Down Counting

Note: If you need only one type of counting, connect C0A+ and C0A- for Up Counting only; or connect C0B+ and C0B- for Down Counting only.

Bi-direction Counting

For implementing Bi-direction Counting, you need to connect C0B+/D+ and C0B-/D- to implement the control function for Up/Down Counting. **Up Counting:** when the input signal is within logic level "1", the counter value increases.

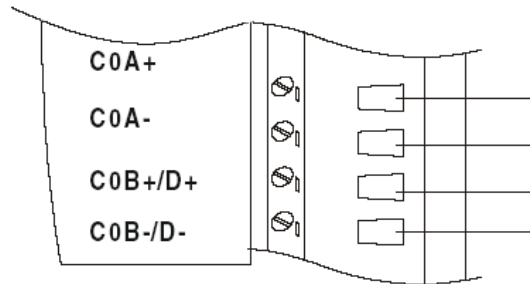

Figure 57: Wiring for Bi-direction Counting

Down Counting: when the input signal is within logic level "0", the counter value decreases.

Note: If users select TTL mode and don't connect C0B+ C0B-, the counter value will increase. If users select Isolated mode and don't connect C0B+ C0B-, the counter value will decrease.

I/O Module Introduction

Features -- Frequency Mode

If users want to select frequency mode, they can only utilize Up Counting type, and can only connect to C0A+ and C0A-.

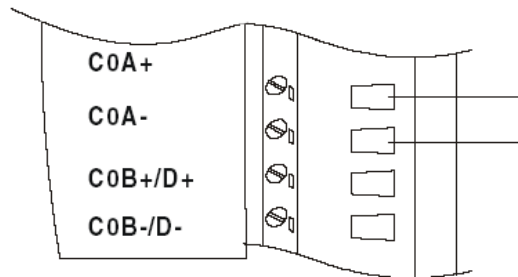

Figure 58: Wiring for Frequency Mode

Features -- Alarm Setting

According to your application purposes, you can run the utility program to set different limit values for High/Low Alarm.

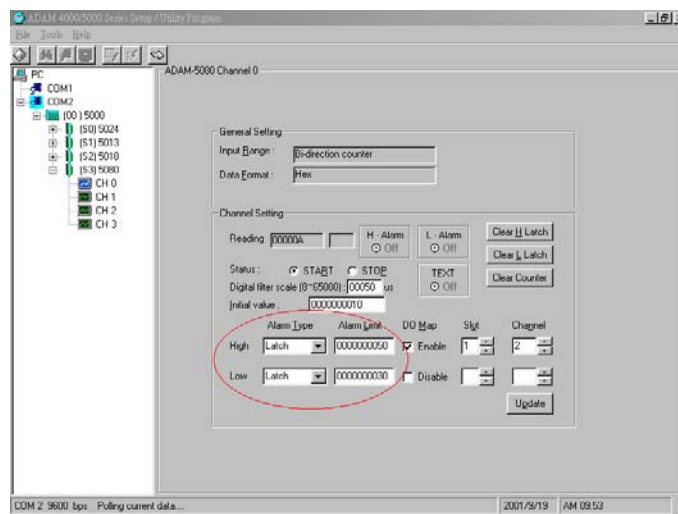

Figure 59: Setting Alarm Limit

Setting Initial Counter Value

In order to utilize the alarm function, users have to set a high-alarm limit value and/or a low alarm limit value, and a initial value to fulfill the requirements for a basic alarm setting.

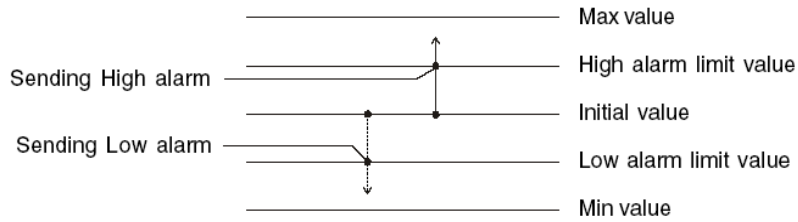

Figure 60: Sending Alarm Signal (recommended settings)

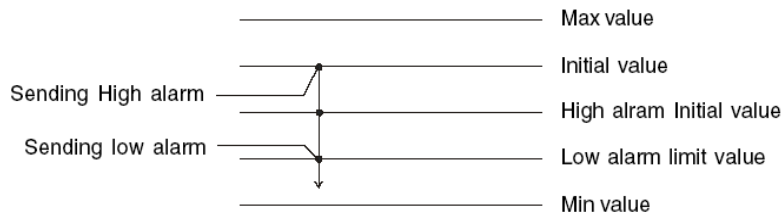

Figure 61: Sending Alarm Signal (settings not recommended)

Overflow Value

Overflow value is the number of times the counter value exceeds the Max/Min values you specified. When the counter value exceeds Maximum value, the overflow value increases; when the counter value goes under Minimum value, the overflow value decreases. Besides, when the counter value runs beyond the range of Max/Min value, it will continue counting from the initial value. Furthermore, if users want to check the counter value to see if it is higher or lower than the Max/Min value, they can use the "ReadOverflowFlag" library to gain readout of the overflow value.

I/O Module Introduction

Getting the Totalizer Value

If users want to get the actual counter value, a formula such as follows can facilitate an easy calculation from the initial counter value, overflow value and current counter value:

$$V_{tol} = \{|V_{ini} - V_{min} \text{ (or } V_{max})| + 1\} \times |V_{vf}| + |V_{ini} - V_{cur}|$$

V_{tol} : totalizer value

V_{ini} : initial counter value

V_{min} : min. counter value = 0 (fixed value)

V_{max} : max. counter value = $2^{32} = 4,294,967,295$ (fixed value)

V_{vf} : overflow value

V_{cur} : current counter value

Example:

If the initial value = 10, overflow value = 4, min. value = 0, current counter value = 3, the totalizer value could be calculated as

$$\text{Totalizer value} = \{|10 - 0| + 1\} \times 4 + |10 - 3| = 51$$

Features--Digital Output Mapping

If users want to use Digital Output function, ADAM utility is available for setting specifically which module, channel or slot to receive the alarm signals.

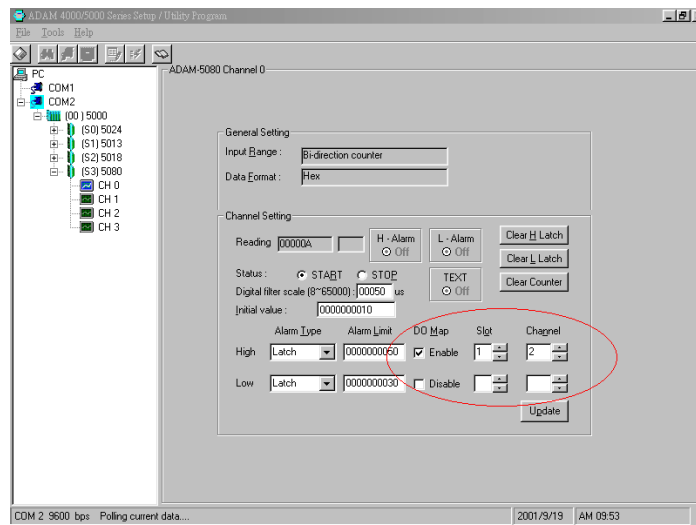

Figure62: Digital Output Mapping

- 1: High Alarm State**--Set Alarm state to "Latch" or "Disable".
- 2: High Alarm Limit**--Set Alarm limit from 0 to 4,294,967,295.
- 3: High Alarm Output Mode**--Enable or Disable D.O. Mapping.
- 4: High Alarm Output Slot**--Users can select D.O Modules such as ADAM-5050, ADAM-5055, ADAM-5056, ADAM-5060, ADAM-5068 for the alarm signal to be sent through.
- 5: High Alarm Output Channel**--Select Alarm Output Channel
- 6: Clear Latch Alarm**--Users can select "Enable" or "Disable" option. When selecting "Enable", the latch will be relieved and the alarm state will return to normal. Once the alarm state returns to normal, the **Clear Latch Alarm** will return to "Disable".

I/O Module Introduction

TTL/Isolated Input Level

According to your need, you can select either TTL or Isolated Input Level by setting the configuration for the jumpers. Select the proper jumper settings for either TTL or Isolated Input according to Figure 53. Please note that you must configure all six jumpers to the correct configuration for proper function.

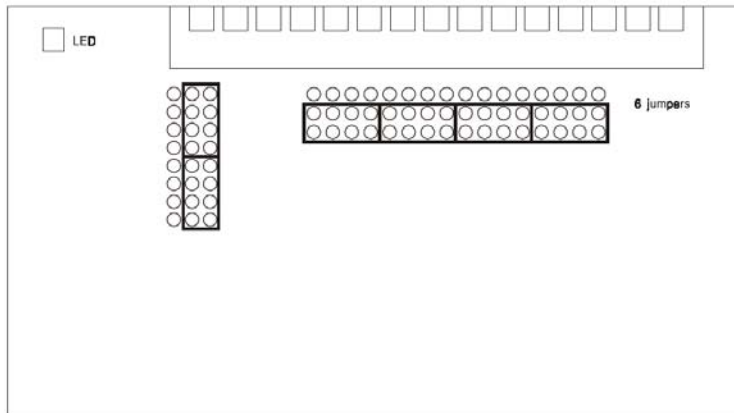
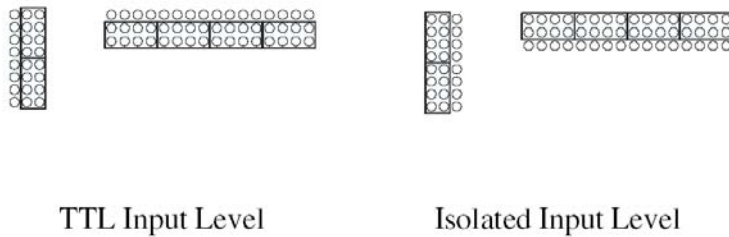

Figure 63: Jumper Location on the ADAM-5080 Module



TTL Input Level

Isolated Input Level

Figure 64: TTL/Isolated Input Level Selecting

ADAM-5080 Technical Specifications

Channel	4
Input Frequency	0.3 ~ 1000 Hz max. (Frequency mode) 5000 Hz max. (Counter mode)
Input Level	Isolated or TTL level
Minimum Pulse Width	500 μ sec. (Frequency mode) 100 μ sec. (Counter mode)
Minimum Input Current	2mA (Isolated)
Isolated Input Level	Logic Level 0 : +1 V _{MAX} Logic Level 1 : + 3.5 V to 30 V
TTL Input Level	Logic Level 0 : 0 V to 0.8 V Logic Level 1 : 2.3 to 5 V
Isolated Voltage	1000 V _{RMS}
Mode	Counter (Up/Down, Bi-direction) Frequency
Programmable Digital Noise Filter	8 ~ 65000 μ sec

Table 26: ADAM-5080 technical specifications

ADAM-5081 4-ch/8-ch High Speed Counter/Frequency Mode Selection

Users can select Bi-direction, Up/Down Counter or Frequency option as shown in Figure 55.

Note: this high speed module can support ADAM-5550 Series, ADAM-5000/485, ADAM-5000E, ADAM-5000/TCP and ADAM-5510M(TCP).

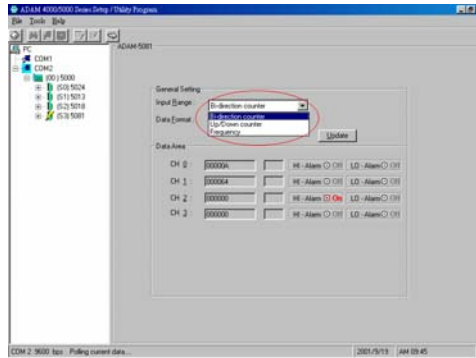

Figure 55: Counter / Frequency Mode

Note: All four channels of ADAM-5081 will operate simultaneously in the mode you have selected. i.e. If you switch the ADAM-5081 to Counter Mode, all four channels will operate in Counter Mode.

Features -- Counter Mode

Up/Down Counting

The Up/Down Counter Function offers two types of counting: Up Counting (increasingly) and Down Counting (decreasingly).

Up Counting: when C0A+ and C0A- sense any input signals, the counter counts up.

Down Counting: when C0B+ and C0B- sense any input signals, the counter counts down. On receiving Up and Down signal simultaneously, the counter will not perform each specific counting accordingly, but will remain at the previous counting value, since these simultaneous signals won't have any effect on counting values.

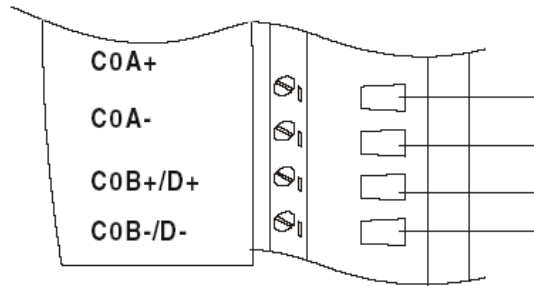

Figure 56: Wiring for Up/Down Counting

Note: If you need only one type of counting, connect C0A+ and C0A- for Up Counting only; or connect C0B+ and C0B- for Down Counting only.

Bi-direction Counting

For implementing Bi-direction Counting, you need to connect C0B+/D+ and C0B-/D- to implement the control function for Up/Down Counting. **Up Counting:** when the input signal is within logic level "1", the counter value increases.

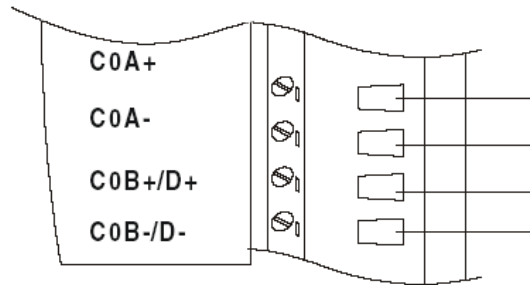

Figure 57: Wiring for Bi-direction Counting

Down Counting: when the input signal is within logic level "0", the counter value decreases.

Note: If users select TTL mode and don't connect C0B+ C0B-, the counter value will increase. If users select Isolated mode and don't connect C0B+ C0B-, the counter value will decrease.

I/O Module Introduction

Features -- Frequency Mode

If users want to select frequency mode, they can only utilize Up Counting type, and can only connect to C0A+ and C0A-.

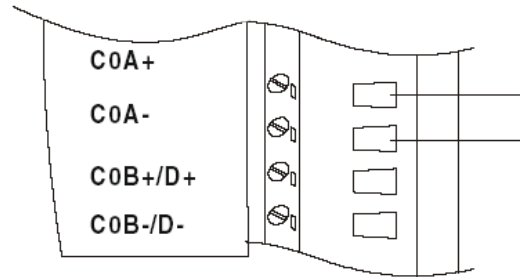

Figure 58: Wiring for Frequency Mode

Features -- Alarm Setting

According to your application purposes, you can run the utility program to set different limit values for High/Low Alarm.

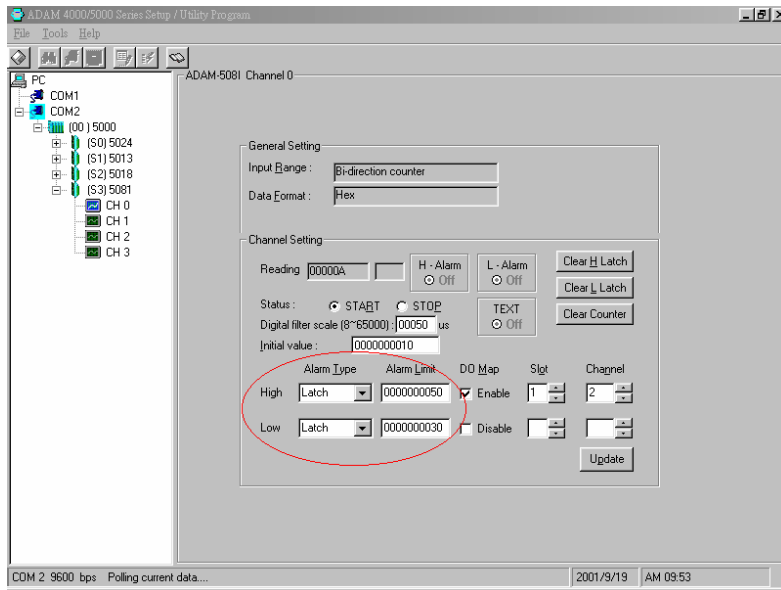

Figure 59: Setting Alarm Limit

Setting Initial Counter Value

In order to utilize the alarm function, users have to set a high-alarm limit value and/or a low alarm limit value, and an initial value to fulfill the requirements for a basic alarm setting.

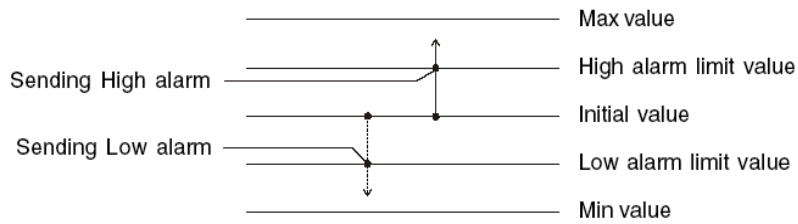

Figure 60: Sending Alarm Signal (recommended settings)

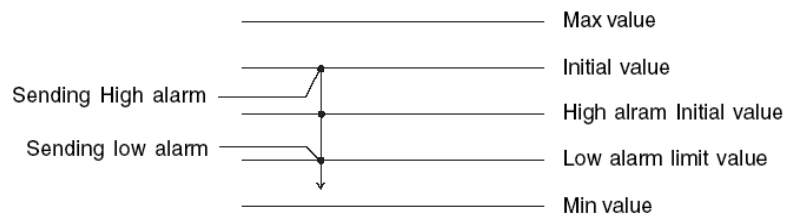

Figure 61: Sending Alarm Signal (settings not recommended)

Overflow Value

Overflow value is the number of times the counter value exceeds the Max/Min values you specified. When the counter value exceeds Maximum value, the overflow value increases; when the counter value goes under Minimum value, the overflow value decreases. Besides, when the counter value runs beyond the range of Max/Min value, it will continue counting from the initial value. Furthermore, if users want to check the counter value to see if it is higher or lower than the Max/Min value, they can use the "ReadOverflowFlag" library to gain readout of the overflow value.

Getting the Totalizer Value

If users want to get the actual counter value, a formula such as follows can facilitate an easy calculation from the initial counter value, overflow value and current counter value:

$$V_{tol} = \{ |V_{ini} - V_{min} \text{ (or } V_{max})| + 1 \} \times |V_{vf}| + |V_{ini} - V_{cur}|$$

V_{tol} : totalizer value

V_{ini} : initial counter value

V_{min} : min. counter value = 0 (fixed value)

V_{max} : max. counter value = $2^{32} = 4,294,967,295$ (fixed value)

V_{vf} : overflow value

V_{cur} : current counter value

Example:

If the initial value = 10, overflow value = 4, min. value = 0, current counter value = 3, the totalizer value could be calculated as

$$\text{Totalizer value} = \{ |10 - 0| + 1 \} \times 4 + |10 - 3| = 51$$

Features--Digital Output Mapping

If users want to use Digital Output function, ADAM utility is available for setting specifically which module, channel or slot to receive the alarm signals.

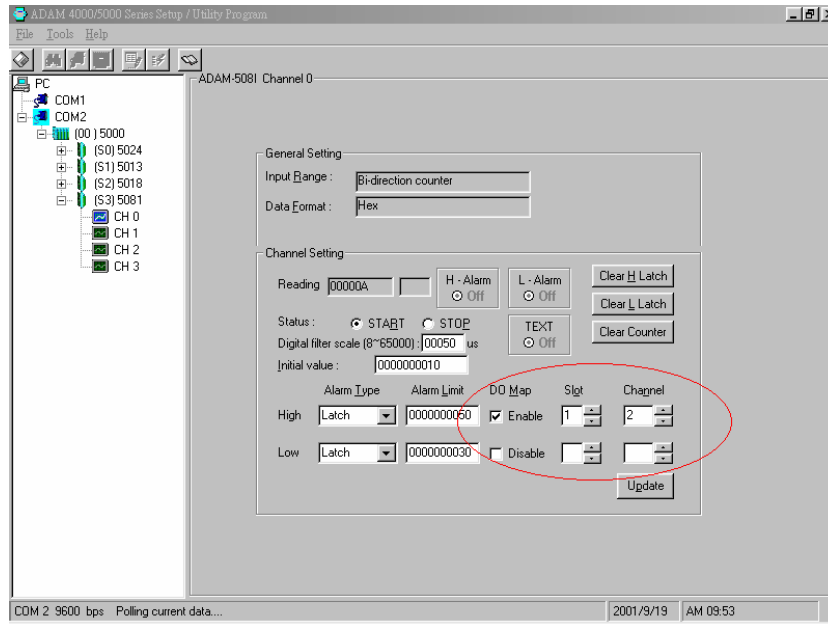

Figure62: Digital Output Mapping

- 1: **High Alarm State**--Set Alarm state to "Latch" or "Disable".
- 2: **High Alarm Limit**--Set Alarm limit from 0 to 4,294,967,295.
- 3: **High Alarm Output Mode**--Enable or Disable D.O. Mapping.
- 4: **High Alarm Output Slot**--Users can select D.O Modules such as ADAM-5050, ADAM-5055, ADAM-5056, ADAM-5060, ADAM-5068 for the alarm signal to be sent through.
- 5: **High Alarm Output Channel**--Select Alarm Output Channel
- 6: **Clear Latch Alarm**--Users can select "Enable" or "Disable" option. When selecting "Enable", the latch will be relieved and the alarm state will return to normal. Once the alarm state returns to normal, the **Clear Latch Alarm** will return to "Disable".

TTL/Isolated Input Level

According to your need, you can select either TTL or Isolated Input Level by setting the configuration for the jumpers. Select the proper jumper settings for either TTL or Isolated Input according to Figure 63. Please note that you must configure all six jumpers to the correct configuration for proper function.

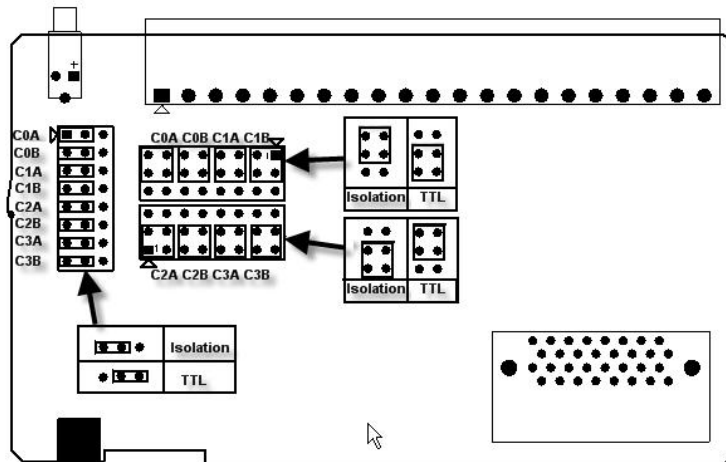

Figure 63: Jumper Location on the ADAM-5081 Module

ADAM-5081 Technical Specifications

Channel	4
Input Frequency	5 Hz~1 MHz max. (Frequency mode) 1 MHz max. (Counter mode)
Input Level	Isolated or TTL level
Minimum Pulse Width	1 μ sec. (Frequency mode) 1 μ sec. (Counter mode)
Minimum Input Current	2mA (Isolated)
Isolated Input Level	Logic Level 0 : +3 V _{MAX} Logic Level 1 : + 10 V to 30 V
TTL Input Level	Logic Level 0 : 0 V to 0.8 V Logic Level 1 : 2.3 to 5 V
Isolated Voltage	2500 V _{RMS}
Mode	Counter (Up/Down, Bi-direction, up, A/B Phase) Frequency
Programmable Digital Noise Filter	1 ~ 65000 μ sec

Table 27: ADAM-5081 technical specifications

I/O Module Introduction

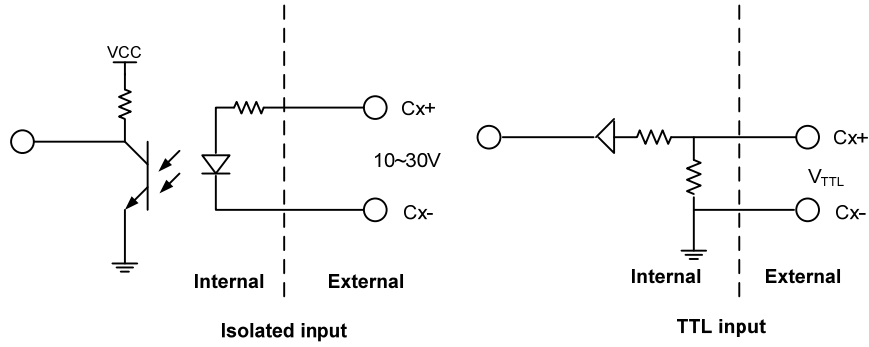

Output

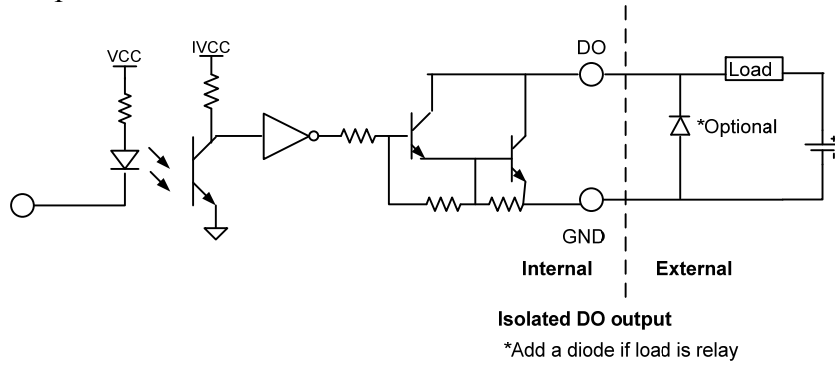

7. Serial Module

Overview

Compatible ADAM-5000 Series Main Units

The ADAM-5090 is a 4-port RS-232 communication module to be implemented with the following Advantech ADAM-5000 series main units: ADAM-5510 (with library Version V1.10 or above)

ADAM-5511 (with library Version V1.10 or above)

ADAM-5090 4-port RS-232 Communication Module

Bi-direction Communication

The ADAM-5090 is equipped with four RS-232 ports, which makes it especially suitable for bi-direction communication. It can simultaneously read data from other third-party devices such as Bar Code and PLC as long as these devices are equipped with a RS-232 interface. Furthermore, the ADAM-5090 can issue commands to control other devices. It is fully integrated with the ADAM-5000, ADAM-5500 and ADAM-4000 series, and transmits data to each other through the RS-232 port. The whole integrated system is an intelligent stand-alone system and can connect and issue commands to control devices such as printers and PLCs in remote factory location.

The ADAM-5090 transmits and receives data by polling communication, and each port can receive up to 128 bytes in the FIFO. For continuous data longer than 128 bytes, please refer to Table 20 for Baud Rate setting to avoid data loss.

Baud Rate (bps)	115200	57600	38400	19200	9600	4800	2400
Polling interval (ms)	11.11	22.22	33.33	66.66	133.33	266.66	533.33

Table 27: Baud Rate setting reference table

I/O Module Introduction

Communication Backup Function

With the ADAM-5090 you can implement dual communication channels between your PC and the ADAM system. Even when one of the two communication channels is down, your system can still function through the alternative communication channel. This dual communication channels can be implemented by application software.

ADAM-5090 Module Diagram

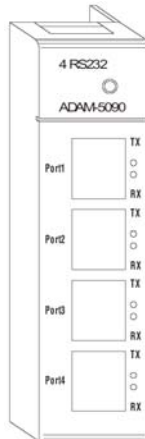

Figure 65: ADAM-5090 Module

ADAM-5090 Application Wiring

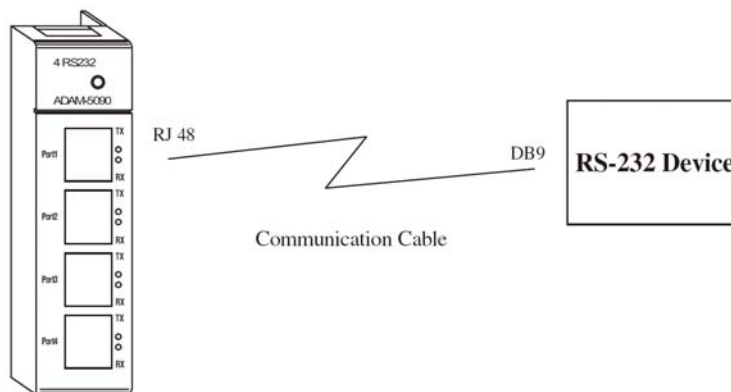

Figure 66: ADAM-5090 Application Wiring

PIN Mapping

PIN Name	RJ-48	DB9
/DCD	1	1
RX	2	2
TX	3	3
/DTR	4	4
GND	5	5
/DSR	6	6
/RTS	7	7
/CTS	8	8
RI or +5V	9	9
GND	10	X

Table 28: Pin Mapping

ADAM-5090 Technical Specification

Function	Provides communication ports for the ADAM-5510 to integrate other devices with communication function into your system
Electrical Interface	4 ports (RS-232)
Communication Rates	4800, 9600, 19200, 38400, 115200bps
FIFO	128 bytes/per UART (Tx/Rx)
Indicator	Tx (Orange), Rx (Green)
Power Required	100mA @ 5V _{DC} Default in RI mode (*)

Table 29: ADAM-5090 technical specifications

- User can define the communication ports with 5VDC output by switching the jumper, and the maximum current output is 400mA.

I/O Module Introduction

I/O Slots and I/O Ports Numbering

The ADAM-5090 module provides four RS-232 ports for communication with target devices. The ports are numbered 1 through 4. For programming, the definition of port number depends on the slot number and port number. For example, the second port on the ADAM-5090 in slot 1 is defined to port 12.

Jumper Settings

This section tells you how to set the jumpers to configure your ADAM-5090 module. There are four jumpers on the PC Board. User can choose RI signal or 5V output for each port by setting these jumpers (system default is RI signal).

The following figure shows the location of the jumpers:

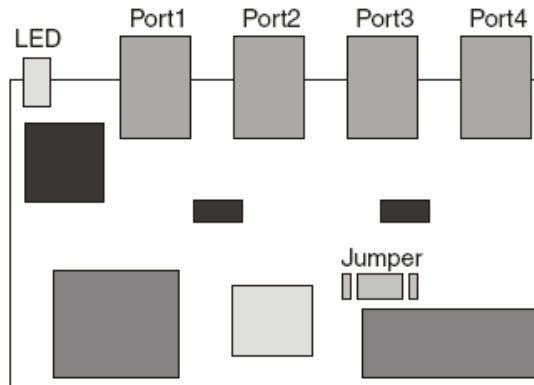

Figure 67: Jumper locations on the CPU card

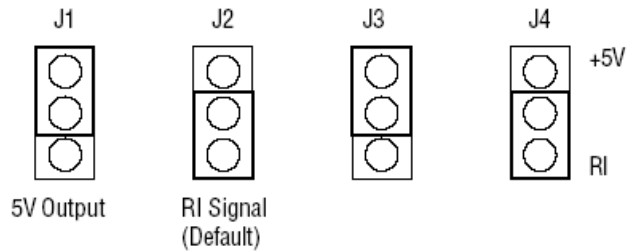

Figure 68: Jumper Settings

LED Status of the ADAM-5090 Module

There are two LEDs for each port on the front panel of the ADAM-5090 to display specific communication status:

- a. **Green LED (RX):** Data Receiving Status; the LED indicator is on when the port is receiving data.
- b. **Orange LED (TX):** Data Transmitting Status; the LED indicator is on when the port is transmitting data.

Configure Your ADAM-5090 Module

This section explains how to configure an ADAM-5090 module before implementing it into your application.

Quick Start

Step 1: Get your host PC ready, and run the ADAM-5510 Utility Software.

Step 2: Install the ADAM-5090 Module and power on your ADAM-5510 main unit.

Step 3: Download the executable program to the main unit

Step 4: Monitor the ADAM-5090 Module's current status from the PC through the utility software.

A basic example program for the ADAM-5090

```
main ()
{
//Install the port you would like to use. Here we install slot 0,
port 1.
port_install(1);
// Here we install slot 2, port 2.
port_install(22);

//Select working port. Here we select slot 0, port 1.
port_select(1);
//Set port data format.
//Here we set the data format of port 1 as length:8; parity:0;stop_bit:1.
(N81)

port_set_format(1,8,0,1);

//Set port speed. Here we set communication speed of port 1 as 115200
bps.
//(L is necessary)
```

I/O Module Introduction

```
port_set_speed(1,115200L);

//Enable Port FIFO. Here we enable 128 byte FIFO for port1.
port_enable_fifo(1);

//After these above settings are enabled, you can apply any
other function library to implement your program.
}
```

—A receive-and-transmit example program for the ADAM-5090

```
main()
{
int err_value, char character port_installed(1)
:
:
port_enable_fifo(1);

//check whether error has been received or not
err_value=port_rx_error(1);

//if error detected, print out the message
if(err_value)
{
printf("\n Rx Error, The LSR Value=%02X", Err_value);
}
//check whether FIFO receives data or not; if data received, read a
character
if(port_rx_ready(1))

{
character=port_rx(1);
}

//check whether FIFO is empty or not, if empty, send a character
if(port_tx_empty(1));
{
port_tx(1, character)
}
}
```

ADAM-5091 4-port RS-232 Communication Module with share interrupt (Only for ADAM-5550 Series)

Bi-direction Communication

The ADAM-5091 is equipped with four RS-232 ports with share interrupt, which makes it especially suitable for bi-direction communication. It can simultaneously read data from other third-party devices such as Bar Code and PLC as long as these devices are equipped with a RS-232 interface. Furthermore, the ADAM-5091 can issue commands to control other devices. It is fully integrated with the ADAM-5550, and transmits data to each other through the RS-232 port. The whole integrated system is an intelligent stand-alone system and can connect and issue commands to control devices such as printers and PLCs in remote factory location.

The ADAM-5091 transmits and receives data by sharing interrupt communication, and each port can receive up to 128 bytes in the FIFO. For continuous data longer than 128 bytes, please refer to Table 27 for Baud Rate setting to avoid data loss.

Baud Rate (bps)	115200	57600	38400	19200	9600	4800	2400
Polling interval (ms)	11.1	22.2	33.3	66.66	133.33	266.66	533.33

Table 27: Baud Rate setting reference table

Communication Backup Function

With the ADAM-5091 you can implement dual communication channels between your PC and the ADAM system. Even when one of the two communication channels is down, your system can still function through the alternative communication channel. This dual communication channels can be implemented by application software.

ADAM-5091 Module Diagram

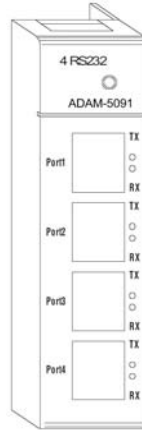

Figure 65: ADAM-5091 Module

ADAM-5091 Application Wiring

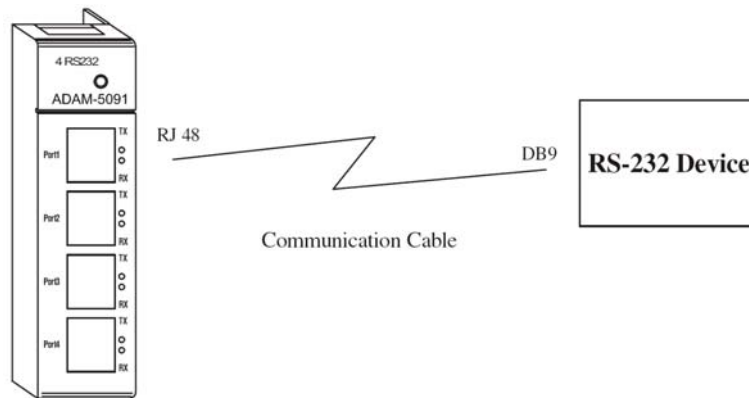

Figure 66: ADAM-5091 Application Wiring

PIN Mapping

PIN Name	RJ-48	DB9
/DCD	1	1
RX	2	2
TX	3	3
/DTR	4	4
GND	5	5
/DSR	6	6
/RTS	7	7
/CTS	8	8
RI or +5V	9	9
GND	10	X

Table 28: Pin Mapping

ADAM-5091 Technical Specification

Function	Provides communication ports for the ADAM-5550 to integrate other devices with communication function into your system
Electrical Interface	4 ports RS-232
Communication Rates	4800, 9600, 19200, 38400, 115200bps
FIFO	128 bytes/per UART (Tx/Rx)
Indicator	Tx (Green), Rx (Red)
Power Required	100mA @ 5V _{DC} Default in RI mode (*)

Table 29: ADAM-5091 technical specifications

- User can define the communication ports with 5VDC output by switching the jumper, and the maximum current output is 400mA.

I/O Module Introduction

I/O Slots and I/O Ports Numbering

The ADAM-5091 module provides four RS-232 ports for communication with target devices. For more information about the number of slot and COM port, you may refer to the section of "ADAM-5091 COM port configuration" in ADAM-5550KW series Manual.

LED Status of the ADAM-5091 Module

There are two LEDs for each port on the front panel of the ADAM-5091 to display specific communication status:

- a. **Red LED (RX):** Data Receiving Status; the LED indicator is on when the port is receiving data.
- b. **Green LED (TX):** Data Transmitting Status; the LED indicator is on when the port is transmitting data.

ADAM-5095 2-port CAN Serial Communication Module with isolation protection (Only for B version of ADAM-5550 Series)

ADAM-5095 is a special purpose communication module that offers the connectivity of the Controller Area Network (CAN). With its built-in CAN controllers, the ADAM-5095 provides bus arbitration and error detection with an automatic transmission repeat function. This drastically reduces the chance of data loss and ensures system reliability. The on-board CAN controllers are located at different positions in the memory, and you can run both CAN controllers independently at the same time. With high-compatibility, the ADAM-5095 can be used in diverse systems.

ADAM-5095 Diagram

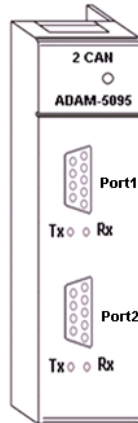

Specification

General

1. Connector: 2 × DB9-M
2. LED Indicator: Tx(Yellow), Rx(Green) For Each Port
3. Power Consumption: 1W (max.)

Communication

1. CAN Controller: SJA-1000
2. CAN Transceiver: 82C250
3. Protocol: CAN2.0 A/B
4. Signal Support: CAN-H, CAN-L
5. Speed: 1Mbps

Protection

1. Isolation Protection: 1000V_{DC}

I/O Module Introduction

CAN Serial Port Pin Assignment

Table 1: CAN Serial Port Pin Assignment (CAN1 ~ CAN2)

Pin	CAN Signal Definition

Termination Resistor Setting

Terminal resistors are factory installed to allow for impedance matching. These resistors can be enabled by utilizing SW1 and SW2 for each port (shown below). The value of the resistor should equal the characteristic impedance of the signal wires (approximately 120 ohms). The following figure shows resistor placements.

Enable Termination Resistor for CAN1 and CAN2 Ports (SW1 and SW2)

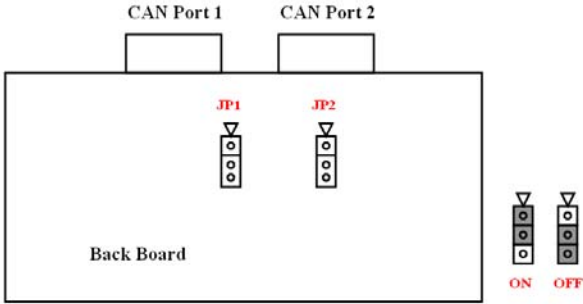

I/O Slots and I/O Ports Numbering

There're two PCI slots on the version B of ADAM-5550 series. If only one ADAM-5095 module is used, no matter which PCI slot is plugged, the port number shown in the Utility would be CAN1 and CAN2. If two ADAM-5095 modules are used, the port number shown in the Utility would be CAN1 and CAN2 for the first PCI slot and CAN3 and CAN4 for the second PCI slot.

CAN Serial Port Wiring

The CAN standard supports **half-duplex** communication. This means that just two wires are used to transmit and receive data.

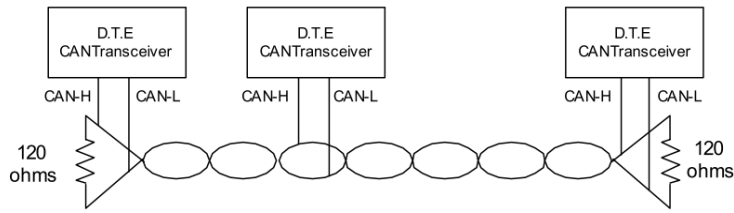

Wiring connections are as follows:

Table 2: ADAM-5095 DTE Pin Wiring

Pin	ADAM-5095 DTE(DB9-M) Pin Signal	DTE Pin Signal
7	CAN-H	CAN-H
3	GND	GND
2	CAN-L	CAN-L

Maximum Bit Rate vs. Bus Length

For a Controller Area Network, the maximum possible bus length depends on the bit rate. The bit rate can always be slower than the maximum possible speed for a given bus length. Conversely, the bus length can be shorter than the maximum possible bus length for a given transmission speed.

Table 3: Maximum Bit rate vs. Bus Length

Bit Rate	Bus Length
1M bps	25m
800k bps	50m
500k bps	100m
250k bps	250m
125k bps	500m
50k bps	1000m
20k bps	2500m
10k bps	5000m

8. Storage Module

Overview

Compatible ADAM-5000 Series Main Units

The ADAM-5030 is a 2-slot SD storage module to be implemented with the following Advantech ADAM-5000 series main units:

ADAM-5550KW

ADAM-5030 SD storage module

The ADAM-5030 storage module provides 2 slot of SD cards. When you insert the SD card into the ADAM-5030, please remove the name plate first. Please be careful to remove it. If you remove it with great exertion, it may be damaged.

ADAM-5030 Diagram

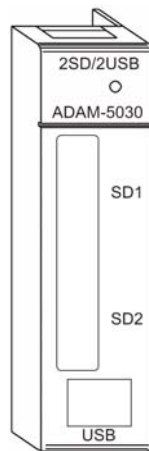

Figure 69: ADAM-5030 module frontal view

Technical specifications of ADAM-5030

USB Type	USB Rev 2.0 (Compliant)
USB Number	2
Storage Type	SD (Secure Digital Card)
Storage Number	2
Operating Temperature	0~60°C (32~140°F)
Certification	CE
Power Consumption	3 W (Max)
Max Storage	1G (Max) x 2
Format	FAT16
Surge Protection	10kW
Hot Swap	Yes

Table 30: Technical specifications of ADAM-5030

9. Motion Module

Overview

Compatible ADAM-5550 Series Main Units

The ADAM-5202 is a 4-port AMONet Master module to be implemented with the following Advantech ADAM-5000 series main units:

ADAM-5550KW (Only)

ADAM-5202 4-port AMONet Master Module

The ADAM-5202 provides 4-port AMONet Master Module. When you insert the SD card into the ADAM-5202, please remove the name plate first. Please be careful to remove it. If you remove it with great exertion, it may be damaged.

ADAM-5202 Diagram

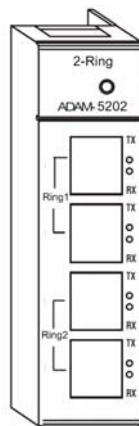

Figure 70: ADAM-5202 module frontal view

Technical specifications of ADAM-5202

Certifications	CE
Power Consumption	0.5 W (Max.)
Connectors	RJ-45
LED Indicators	Active, Error (Each Port)
Number of Rings	2
Transmission Speed	2.5, 5, 10 or 20 Mbps with automatic data flow control
Serial Interface	Half duplex RS-485 with transformer isolation
Cable Type	CAT5 UTP/STP Ethernet cable
Surge Protection	10 kV
Communication	Max. 100 m (20 Mbps/32 slave modules) 50 m (20 Mbps/64 slave modules) Distance
Communication	Slave 2 Rings with Max. 128 (1 Ring with 64 slaves) Module Number
Operating Temperature	0 ~ 50° C (32 ~ 122° F)

Table 31: Technical specifications of ADAM-5202