

Fireworks™

By Vanguard

UNVENTED (VENT FREE) GAS LOG HEATER OWNER'S OPERATION AND INSTALLATION MANUAL



ANSI Z21.11.2a-2003
ANSI Z21.60-2003
APPROVED



We recommend that our products be installed and serviced by professionals who are certified in the U.S. by NFI (National Fireplace Institute). www.nficertified.org

**VFRMV18NA, VFRMV18PA
VFRMV24NA, VFRMV24PA**

Vent-free Models Also Design-Certified
As Vented Decorative Appliances

WARNING: If the information in this manual is not followed exactly, a fire or explosion may result causing property damage, personal injury or loss of life.

- Do not store or use gasoline or other flammable vapors and liquids in the vicinity of this or any other appliance.
- **WHAT TO DO IF YOU SMELL GAS**
 - Do not try to light any appliance.
 - Do not touch any electrical switch; do not use any phone in your building.
 - Immediately call your gas supplier from a neighbor's phone. Follow the gas supplier's instructions.
 - If you cannot reach your gas supplier, call the fire department.
- Installation and service must be performed by a qualified installer, service agency or the gas supplier.

WARNING: Improper installation, adjustment, alteration, service or maintenance can cause injury or property damage. Refer to this manual for correct installation and operational procedures. For assistance or additional information consult a qualified installer, service agency or the gas supplier.

WARNING: This appliance is for installation only in a solid-fuel burning masonry or UL127 factory-built fireplace or in a listed ventless firebox enclosure. It is design-certified for these installations in accordance with ANSI Z21.11.2. Exception: Do not install this appliance in a factory-built fireplace that includes instructions stating it has not been tested or should not be used with unvented gas logs.

WARNING: This is an unvented gas-fired heater. It uses air (oxygen) from the room in which it is installed. Provisions for adequate combustion and ventilation air must be provided. Refer to *Air for Combustion and Ventilation* section on page 6 of this manual.

This appliance may be installed in an aftermarket,* permanently located, manufactured (mobile) home, where not prohibited by local codes.

This appliance is only for use with the type of gas indicated on the rating plate. This appliance is not convertible for use with other gases.

* Aftermarket: Completion of sale, not for purpose of resale, from the manufacturer

TABLE OF CONTENTS

Safety Information	3	Cleaning and Maintenance.....	20
Product Identification	5	Wiring Diagram	21
Local Codes	5	Troubleshooting	22
Unpacking	5	Specifications	26
Optional Remote Control Accessories.....	5	Replacement Parts	26
Product Features	5	Service Hints	26
Air For Combustion and Ventilation	6	Technical Service	26
Installation	8	Accessories	26
Operating Heater	16	Illustrated Parts Breakdown and Parts List	28
Inspecting Burners	19	Warranty Information	32

SAFETY INFORMATION

IMPORTANT: Read this owner's manual carefully and completely before trying to assemble, operate or service this log set. Improper use of this log set can cause serious injury or death from burns, fire, explosion, electrical shock and carbon monoxide poisoning.

⚠ DANGER: Carbon monoxide poisoning may lead to death!

Carbon Monoxide Poisoning: Early signs of carbon monoxide poisoning resemble the flu, with headaches, dizziness or nausea. If you have these signs, the log set may not be working properly. **Get fresh air at once!** Have log set serviced. Some people are more affected by carbon monoxide than others. These include pregnant women, people with heart or lung disease or anemia, those under the influence of alcohol and those at high altitudes.

Natural & Propane/LP Gas: Natural & Propane/LP gas are odorless. An odor-making agent is added to the gas. The odor helps you detect a gas leak. However, the odor added to the gas can fade. Gas may be present even though no odor exists.

Make certain you read and understand all warnings. Keep this manual for reference. It is your guide to safe and proper operation of this log set.

⚠ WARNING: Any change to this log set or its controls can be dangerous.

⚠ WARNING: Do not use a blower insert, heat exchanger insert or other accessory not approved for use with this appliance.

⚠ WARNING: This appliance is equipped with (natural or propane/LP) gas. Field conversion is not permitted.

⚠ WARNING: Do not allow fans to blow directly into the fireplace. Avoid any drafts that alter burner flame patterns. Ceiling fans can create drafts that alter burner flame patterns. Altered burner patterns can cause sooting.

⚠ WARNING: Do not place log scraps or lava rocks on burner

Due to high temperatures, the appliance should be located out of traffic and away from furniture and draperies.

Do not place clothing or other flammable material on or near the appliance. Never place any objects on the heater.

Heater assembly becomes very hot when running heater. Keep children and adults away from hot surface to avoid burns or clothing ignition. Heater will remain hot for a time after shutdown. Allow surface to cool before touching.

Carefully supervise young children when they are in the room with appliance. When using the hand-held remote accessory, keep selector switch in the OFF position to prevent children from turning on burners with remote.

You must operate this heater with a fireplace screen in place. Make sure fireplace screen is closed before running heater.

SAFETY INFORMATION

Continued

Keep the appliance area clear and free from combustible materials, gasoline and other flammable vapors and liquids.

Solid fuels shall not be burned in a fireplace in which an unvented room heater installed.

Children and adults should be alerted to the hazard of high temperature and should stay away to avoid burns or clothing ignition.

1. This appliance, as supplied, is only for use with the type of gas indicated on the rating plate. This appliance is not convertible for use with other gases.
2. Do not place propane/LP supply tank(s) inside the structure. Locate propane/LP supply tank(s) outdoors (propane/LP units only).
3. If you smell gas
 - shut off gas supply
 - do not try to light any appliance
 - do not touch any electrical switch; do not use any phone in your building
 - immediately call your gas supplier from a neighbor's phone. Follow the gas supplier's instructions
 - if you cannot reach your gas supplier, call the fire department
4. This heater shall not be installed in a bedroom or bathroom, unless installed as a vented appliance. See *Installing Damper Clamp Accessory for Vented Operation*, page 12.
5. Before installing in a solid fuel burning fireplace, the chimney flue and firebox must be cleaned of soot, creosote, ashes and loose paint by a qualified chimney cleaner. Creosote will ignite if highly heated. Inspect chimney flue for damage. If damaged, repair flue before operating appliance.
6. If fireplace has glass doors, never operate with glass doors closed. If you operate heater with doors closed, heat buildup inside fireplace will cause glass to burst. Also if fireplace opening has vents at the bottom, you must open the vents before operating heater.
7. To prevent the creation of soot, follow the instructions in *Cleaning and Maintenance*, page 20.
8. Before using furniture polish, wax, carpet cleaner or similar products, turn heater off. If heated, the vapors from these products may create a white powder residue within the burner box or on adjacent walls and furniture.
9. This heater needs fresh, outside air ventilation to run properly this heater has an Oxygen Depletion Sensing (ODS) safety shutoff system. The ODS shuts down the heater if enough fresh air is not available. See *Air Combustion and Ventilation* page 6. If the heater keeps shutting off, see *Troubleshooting*, page 22.
10. Do not run heater
 - where flammable liquids or vapors are used or stored
 - under dusty conditions
11. Do not use heater to cook food or burn paper or other objects.
12. Do not use heater if any part has been exposed to or under water. Immediately call a qualified service technician to inspect the room heater and to replace any part of the control system and any gas control which has been under water.
13. Do not operate heater if any log is broken. Do not operate heater if a log is chipped (dime-size or larger).
14. Turn heater off and let cool before servicing, installing or repairing. Make sure the selector switch is in the OFF position. Only a qualified service person should install, service or repair heater.
15. Make sure the selector switch is in the OFF position when you are away from home for long periods of time.
16. Remote-ready heaters shall not be connected to any external electrical source.
17. Operating heater above elevations of 4,500 feet may cause pilot outage.
18. To prevent performance problems, do not use propane/LP tank(s) of less than 100 lb. capacity (propane/LP units only).
19. Provide adequate clearances around air openings.

 **WARNING: Failure to position the parts in accordance with these diagrams or failure to use only parts specifically approved with this heater may result in property damage or personal injury.**

PRODUCT IDENTIFICATION

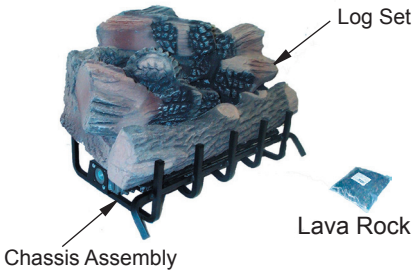

Figure 1 - Product Identification

LOCAL CODES

Install and use the heater with care. Follow all local codes. In the absence of local codes, use the latest edition of the *National Fuel Gas Code ANSI Z223.1/NFPA 54**

*Available from:

American National Standards Institute, Inc.
1430 Broadway
New York, NY 10018
National Fire Protection Association, Inc.
Battery march park
Quincy, MA 02269

Note: Where listed vented decorative logs are required, thermostat operations is not permitted. The installation of appliances designed for manufactured home (U.S. only) or mobile home installation must conform with the *Standard CAN/CSA Z240 MH, Standard, Title 24 CFR, Part 3280*, in the United States or when such a Standard is not applicable, *ANSI/NCSSBCS A225.1/NFPA 501A Manufactured Home Installations Standard*.

State of Massachusetts: The installation must be made by a licensed plumber or gas fitter in the Commonwealth of Massachusetts.

Sellers of unvented propane or natural gas-fired supplemental room heaters shall provide to each purchaser a copy of 527 CMR 30 upon sale of the unit.

Vent-free gas products are prohibited for bedroom and bathroom installation in the Commonwealth of Massachusetts.

UNPACKING

CAUTION: Do not remove the data plates from the grate assembly. The data plates contain important warranty and safety information.

1. Remove log set assembly from carton.
Note: Do not pick up assembly by logs. This could damage the unit. Always handle assembly by grate.
2. Remove all protective packaging applied to log set for shipment.
3. Check all items for any shipping damage. If damaged, promptly inform dealer where you bought appliance.

OPTIONAL REMOTE CONTROL ACCESSORIES

There are four optional remote controls that can be purchased separately:

Wall switch Hand-held ON/OFF remote
Wall thermostat Hand-held thermostat remote
See *Accessories*, page 26

The wall thermostat or hand-held thermostat may not be used where vented decorative listings is required.

PRODUCT FEATURES

OPERATION

This heater is clean burning. It requires no outside venting. There is no heat loss out a vent or up a chimney. Heat is generated by both realistic flames and glowing coals. This heater is designed for vent-free operation with flue damper closed. It has been tested and approved to ANSI Z21.11.2 standard for unvented heaters. State and local codes in some areas prohibit the use of vent-free heaters. This heater may also be operated as a vented decorative (ANSI Z21.60) product by opening the flue damper.

SAFETY DEVICE

This heater has a pilot with an Oxygen Depletion Sensing (ODS) safety shut off system. The ODS/pilot is a required feature for vent-free room heaters. The ODS/pilot shuts off the heater if there is not enough fresh air.

PIEZO IGNITION SYSTEM

This heater has a piezo ignitor. This system requires no matches, batteries or other sources to light heater.

AIR FOR COMBUSTION AND VENTILATION

 **WARNING:** This heater shall not be installed in confined space or unusually tight construction unless provisions are provided for adequate combustion and ventilation air. Read the following instructions to insure proper fresh air for this and other fuel-burning appliances in your home.

Today's homes are built more energy efficient than ever. New materials, increased insulation and new construction methods help reduce heat loss in homes. Home owners weather strip and caulk around windows and doors to keep the cold air out and the warm air in. During heating months, home owners want their homes as airtight as possible.

While it is good to make your home energy efficient, your home needs to breathe. Fresh air must enter your home. All fuel-burning appliances need fresh air for proper combustion and ventilation.

Exhaust fans, fireplaces, clothes dryers and fuel burning appliances draw air from the house to operate. You must provide adequate fresh air for these appliances. This will insure proper venting of vented fuel-burning appliances.

PROVIDING ADEQUATE VENTILATION

The following are excerpts from *National Fuel Gas Code, ANSI Z223.1/NFPA 54, Section 5.3, Air for Combustion and Ventilation*.

All spaces in homes fall into one of the three following ventilation classifications:

1. Unusually Tight Construction
2. Unconfined Space
3. Confined Space

The information on pages 6 through 8 will help you classify your space and provide adequate ventilation.

Unusually Tight Construction

The air that leaks around doors and windows may provide enough fresh air for combustion and ventilation. However, in buildings of unusually tight construction, you must provide additional fresh air.

Unusually tight construction is defined as construction where:

- a. Walls and ceilings exposed to the outside atmosphere have a continuous water vapor retarder with a rating of one perm (6 x 10⁻¹¹ kg per pa-sec-m²) or less with openings gasketed or sealed and
- b. weather stripping has been added on openable windows and doors and
- c. caulking or sealants are applied to areas such as joints around window and door frames, between sole plates and floors, between wall-ceiling joints, between wall panels, at penetrations for plumbing, electrical and gas lines and at other openings.

If your home meets all of the three criteria above, you must provide additional fresh air. See Ventilation Air From Outdoors, page 6.

If your home does not meet all of the three criteria above, proceed to *Determining Fresh-Air Flow For Appliance Location*.

Confined and Unconfined Space

The *National Fuel Gas Code, ANSI Z223.1/NFPA 54* defines a confined space as a space whose volume is less than 50 cubic feet per 1,000 Btu per hour (4.8 m³ per kw) of the aggregate input rating of all appliances installed in that space and an unconfined space as a space whose volume is not less than 50 cubic feet per 1,000 Btu per hour (4.8 m³ per kw) of the aggregate input rating of all appliances installed in that space. Rooms communicating directly with the space in which the appliances are installed*, through openings not furnished with doors, are considered a part of the unconfined space.

* Adjoining rooms are communicating only if there are odorless passageways or ventilation grills between them.

DETERMINING FRESH-AIR FLOW FOR APPLIANCE LOCATION

Determining if You Have a Confined or Unconfined Space

Use this work sheet to determine if you have a confined or unconfined space.

Space: Includes the room in which you will install appliance plus any adjoining rooms with doorless passageways or ventilation grills between the rooms.

AIR FOR COMBUSTION AND VENTILATION

Continued

- Determine the volume of the space (length x width x height).

Length x Width x Height = _____ cu. ft.
(volume of space)

Example: Space size 20 ft. (length) x 16 ft. (width) x 8 ft. (ceiling height) = 2560 cu. ft. (volume of space)

If additional ventilation to adjoining room is supplied with grills or openings, add the volume of these rooms to the total volume of the space.

- Multiply the space volume by 20 to determine the maximum Btu/Hr the space can support.

_____ (volume of space) x 20 =
(Maximum Btu/Hr the space can support)

Example: 2560 cu. ft. (volume of space) x 20 = 51,200 (maximum Btu/Hr the space can support)

- Add the Btu/Hr of all fuel burning appliances in the space.

Vent-free appliance	_____ Btu/Hr
Gas water appliance*	_____ Btu/Hr
Gas furnace	_____ Btu/Hr
Vented gas appliance	_____ Btu/Hr
Gas fireplace logs	_____ Btu/Hr
Other gas appliances*	+ _____ Btu/Hr
Total	= _____ Btu/Hr

* Do not include direct-vent gas appliances. Direct-vent draws combustion air from the outdoors and vents to the outdoors.

Example:

Gas water appliance	40,000	Btu/Hr
Vent-free appliance	+ 33,000	Btu/Hr
Total	= 73,000	Btu/Hr

- Compare the maximum Btu/Hr the space can support with the actual amount of Btu/Hr used.

_____ Btu/Hr (maximum the space can support)
_____ Btu/Hr (actual amount of Btu/Hr used)

Example: 51,200 Btu/Hr (maximum the space can support)

73,000 Btu/Hr (actual amount of Btu/Hr used)

The space in the previous example is a confined space because the actual Btu/Hr used is more than the maximum Btu/Hr the space can support. You must provide additional fresh air. Your options are as follows:

- Rework worksheet, adding the space of an adjoining room. If the extra space provides an unconfined space, remove door to adjoining room or add ventilation grills between rooms. See *Ventilation Air From Inside Building*.
- Vent room directly to the outdoors. See *Ventilation Air From Outdoors*, page 8.
- Install a lower Btu/Hr appliance, if lower Btu/Hr size makes room unconfined.

If the actual Btu/Hr used is less than the maximum Btu/Hr the space can support, the space is an unconfined space. You will need no additional fresh air ventilation.

⚠ WARNING: If the area in which the appliance may be operated is smaller than that defined as an unconfined space or if the building is of unusually tight construction, provide adequate combustion and ventilation air by one of the methods described in the *National Fuel Gas Code, ANSI Z223.1/NFPA 54 Section 5.3* or applicable local codes.

VENTILATION AIR

Ventilation Air From Inside Building

This fresh air would come from an adjoining unconfined space. When ventilating to an adjoining unconfined space, you must provide two permanent openings: one within 12" of the ceiling and one within 12" of the floor on the wall connecting the two spaces (see options 1 and 2, Figure 2 on page 8). You can also remove door into adjoining room (see option 3, Figure 2). Follow the *National Fuel Gas Code, ANSI Z223.1/NFPA 54, Section 5.3, Air for Combustion and Ventilation* for required size of ventilation grills or ducts.

AIR FOR COMBUSTION AND VENTILATION

Continued

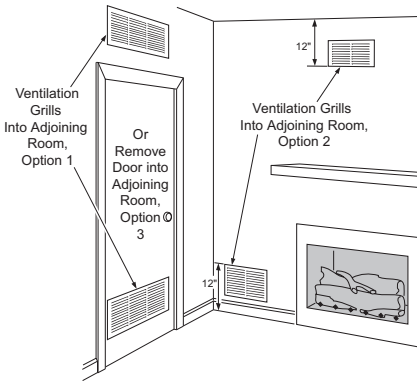

Figure 2 - Ventilation Air from Inside Building

Ventilation Air From Outdoors

Provide extra fresh air by using ventilation grills or ducts. You must provide two permanent openings: one within 12" of the ceiling and one within 12" of the floor. Connect these items directly to the outdoors or spaces open to the outdoors. These spaces include attics and crawl spaces. Follow the *National Fuel Gas Code, ANSI Z223.1/NFPA 54, Section 5.3, Air for Combustion and Ventilation* for required size of ventilation grills or ducts.

IMPORTANT: Do not provide openings for inlet or outlet air into attic if attic has a thermostat-controlled power vent. Heated air entering the attic will activate the power vent.

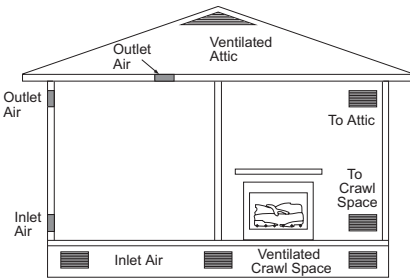

Figure 3 - Ventilation Air from Outdoors

INSTALLATION

NOTICE: This heater is intended for use as supplemental heat. Use this heater along with your primary heating system. Do not install this heater as your primary heating source. If you have a central heating system, you may run system's circulating blower while using heater. This will help circulate the heat throughout the house. In event of a power outage, you can use this heater as your primary heat source.

WARNING: A qualified service person must install heater. Follow all local codes.

NOTICE: State or local codes may only allow operation of this appliance in a vented configuration. Check your state or local codes.

WARNING: Make sure the selector switch is in the OFF position before installing heater.

WARNING: Before installing in a solid fuel burning fireplace, the chimney flue and firebox must be cleaned of soot, creosote, ashes and loose paint by a qualified chimney cleaner. Creosote will ignite if highly heated. A dirty chimney flue may create and distribute soot within the house. Inspect chimney flue for damage. If damaged, repair flue damper before operating appliance.

INSTALLATION

Continued

⚠ WARNING: Seal any fresh air vents or ash clean-out doors located on floor or wall of fireplace. If not, drafting may cause pilot outage or sooting. Use a heat-resistant sealant. Do not seal chimney flue damper.

⚠ WARNING: Never install the heater

- in a bedroom or bathroom unless installed as a vented appliance, see page 12
- in a recreational vehicle
- where curtains, furniture, clothing or other flammable objects are less than 42 inches from the front, top or sides of heater
- in high traffic areas
- in windy or drafty areas

⚠ CAUTION: This heater creates warm air currents. These currents move heat to wall surfaces next to heater. Installing heater next to vinyl or cloth wall coverings or operating heater where impurities (such as, but not limited to, tobacco smoke, aromatic candles, cleaning fluids, oil or kerosene lamps, etc..) in the air exist, may discolor walls or cause odors.

IMPORTANT: Vent-free heaters add moisture to the air. Although this is beneficial, installing heater in rooms without enough ventilation air may cause mildew to form from too much moisture. See *Air for Combustion and Ventilation*, page 6.

CHECK GAS TYPE

Use the correct gas type (natural or propane/LP) for your unit. If your gas supply is not correct, do not install in fireplace. Call dealer where you bought the appliance for proper type of appliance.

⚠ WARNING: This appliance is equipped for (natural or propane/LP) gas. Field conversion is not permitted.

INSTALLATION AND CLEARANCES FOR VENT-FREE OPERATION

⚠ WARNING: Maintain the minimum clearances. If you can, provide greater clearances from floor, ceiling and adjoining wall.

MINIMUM FIREPLACE CLEARANCE TO COMBUSTIBLE MATERIALS

LOG SIZE	18", 24"
SIDE WALL	16"
CEILING	42"
FLOOR	5"

LOG SIZING REQUIREMENTS

LOG SIZE	MINIMUM FIREBOX SIZE			
	HEIGHT	DEPTH	FRONT WIDTH	REAR WIDTH
18"	18"	14"	30"	20.5"
24"	18"	14"	35"	24.5"

*Measured at 14" depth

Allow adequate clearances for accessibility for purposes of servicing and proper operation

Carefully follow the instructions below. This will ensure safe installation into masonry, UL127-listed manufactured fireplace or listed vent-free firebox.

Minimum Clearances For Side Combustible Material, Side Wall and Ceiling

- A. Clearances from the side of the fireplace cabinet to any combustible material and wall should follow diagram in Figure 4, page 10.
Example: The face of a mantel, bookshelf, etc.. is made of combustible material must be 4" from the side of the fireplace to the cabinet (see Figure 4, page 10).
- B. Clearances from the top of the fireplace opening to the ceiling should not be less than 42 inches.

INSTALLATION

Continued

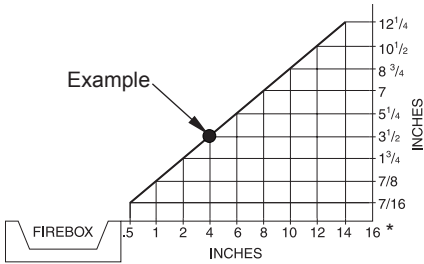

*Minimum 16 inches from Side Wall

Figure 4 - Minimum Clearance for Combustible to Wall

NOTICE: Non thermostat controlled heaters may be used as a vented product. If so, you must always run heater with chimney flue damper open and damper clamp installed. If running heater with damper open, noncombustible material above the fireplace opening is not needed. Go to *Installing Damper Clamp Accessory for Vented Operation*, page 12.

Minimum Noncombustible Material Clearances

If Not Using Mantel

Note: If using a mantel proceed to *If Using Mantel*. If not using mantel, follow the information on this page.

You must have noncombustible material(s) above the fireplace opening. Noncombustible materials (such as slate, marble, tile, etc.) Must be at least 1/2 inch thick. With sheet metal, you must have noncombustible material behind it. Noncombustible material must extend at least 8" up (for all models). If noncombustible material is less than 12", you must install the fireplace hood accessory (24" Models Only). See Figure 5 for minimum clearances.

Noncombustible Material Distance (A)	Requirements for Safe Installation
12" or more	Noncombustible material OK.
Between 8" and 12"	24" Models: Install fireplace hood accessory (GA6050, GA6052, GA6053, see <i>Accessories</i> , page 26). 18" Model: Noncombustible material OK.
Less than 8"	Noncombustible material must be extended to at least 8". See Between 8" and 12", above. If you cannot extend material, you must operate heater with flue damper open and damper clamp installed

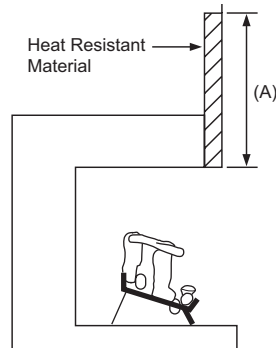

Figure 5 - Heat Resistant Material (Slate, Marble, Tile, etc.) Above Fireplace

If Using Mantel

You must have noncombustible material(s) above the fireplace opening. Noncombustible materials (such as slate, marble, tile, etc.) must be at least 1/2 inch thick. With sheet metal, you must have noncombustible material behind it. Noncombustible material must extend at least 8 inches up (for all models). If noncombustible material is less than 12", you must install the fireplace hood accessory (24" Models Only). Even if noncombustible material is more than 12", you may need the hood accessory to deflect heat away from your mantel shelf. See Figure 5 and Figures 6 and 7, page 11, for minimum clearances.

IMPORTANT: If you cannot meet these minimum clearances, you must operate heater with chimney flue damper open. Go to *Installing Damper Clamp Accessory for Vented Operation*, page 12.

INSTALLATION

Continued

INSTALLING DAMPER CLAMP ACCESSORY FOR VENTED OPERATION

Note: When used as a vented decorative, appliance must be installed only in a solid-fuel burning fireplace with a working flue and constructed of noncombustible material.

If your heater is a non-thermostatically-controlled model, you may use this heater as a vented product. There are three reasons for operating your heater in the vented mode.

1. The fireplace does not meet the clearance to combustibles requirements for vent-free operation.
2. State or local codes do not permit vent-free operation.
3. You prefer vented operation.

If reasons number 1 or 2 above apply to you, you must permanently open chimney flue damper. You must install the damper clamp accessory (to order, see *Accessories*, page 26). This will insure vented operation (see Figure 10). The damper clamp will keep damper open. Installation instructions are included with clamp accessory.

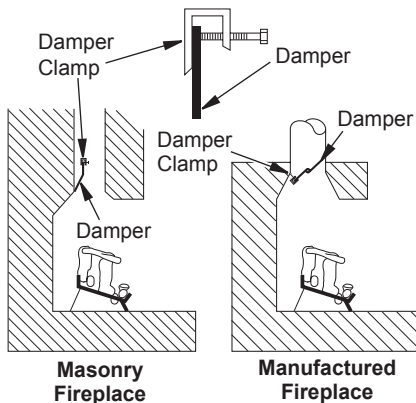

Figure 10 - Attaching Damper Clamp

See chart below for minimum permanent flue opening you must provide. Attach damper clamp so the minimum permanent flue opening will be maintained at all times.

Area of Various Standard Round Flues	
Diameter (ins.)	Area (sq. ins.)
5"	20 sq. inches
6"	29 sq. inches
7"	39 sq. inches
8"	51 sq. inches

Chimney Height (ft.)	Minimum Permanent Flue Opening (sq. ins.)
6' to 15'	39 sq. inches
15' to 30'	29 sq. inches

INSTALLING HEATER ASSEMBLY

⚠ WARNING: If installing in a sunken fireplace, special care is needed. You must raise the fireplace floor to allow access to heater control panel. This will insure adequate air flow and guard against sooting. Raise fireplace floor with noncombustible material. Make sure material is secure.

⚠ CAUTION: Do not pick up heater assembly by logs. This could damage unit. Only handle assembly by grates.

IMPORTANT: Make sure the heater burners are level. If heater is not level, heater will not work properly.

Installation Items Needed

- control cover kit (provided with heater)
- approved flexible gas hose and fittings (provided with heater) (if allowed by local codes)
- sealant (resistant to propane/LP gas, not provided)

INSTALLATION

Continued

Note: Install optional GHRCTB Receiver and Hand-Held Remote Control Kit (see *Accessories*, page 26) before installing gas log heater. See installation instructions included with the kit.

1. Apply pipe joint sealant lightly to male threads of gas fitting (not provided). Connect approved flexible gas hose to inlet side of gas control (see Figure 11).
2. Position heater assembly in fireplace.
3. Connect to gas supply. See *Connecting To Gas Supply*.

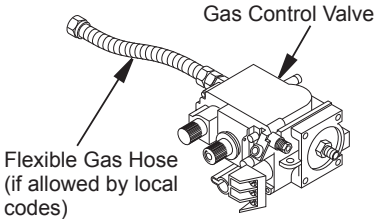

Figure 11 - Attaching Flexible Gas Hose to Heater Gas Regulator

CONNECTING TO GAS SUPPLY

WARNING: This appliance requires a 3/8" NPT (National Pipe Thread) inlet connection to the pressure regulator.

WARNING: A qualified service person must connect heater to gas supply. Follow all local codes.

CAUTION: Never connect propane/LP fireplace directly to the propane/LP supply. This heater requires an external regulator (not supplied). Install the external regulator between the heater and propane/LP supply.

WARNING: Never connect natural gas fireplace to private (non-utility) gas wells. This gas is commonly known as wellhead gas.

Installation Items Needed

Before installing heater, make sure you have the items listed below.

- external regulator (supplied by installer)
- piping (check local codes)
- sealant (resistant to propane/LP gas)
- equipment shutoff valve *
- test gauge connection *
- sediment trap
- tee joint
- pipe wrench
- approved flexible gas line with gas connector (if allowed by local codes) (provided)

* A CSA design-certified equipment shutoff valve with 1/8" NPT tap is an acceptable alternative to test gauge connection. Purchase the optional CSA design-certified equipment shutoff valve from your dealer. See *Accessories*, page 26.

For propane/LP units, the installer must supply an external regulator. The external regulator will reduce incoming gas pressure. You must reduce incoming gas pressure to between 11 and 14 inches of water. If you do not reduce incoming gas pressure, heater regulator damage could occur. Install external regulator with the vent pointing down as shown in Figure 12. Pointing the vent down protects it from freezing rain or sleet.

CAUTION: Use only new, black iron or steel pipe. Internally-tinned copper tubing may be used in certain areas. Check your local codes. Use pipe of 1/2" diameter or greater to allow proper gas volume to heater. If pipe is too small, undue loss of volume will occur.

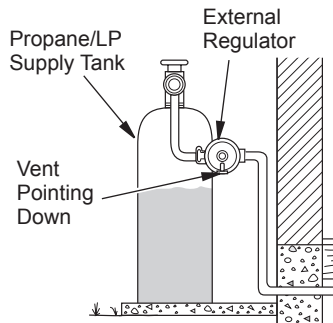

Figure 12 - External Regulator With Vent Pointing Down

INSTALLATION

Continued

Installation must include an equipment shutoff valve, union and plugged 1/8" NPT tap. Locate NPT tap within reach for test gauge hook up. NPT tap must be upstream from heater (see Figure 13).

IMPORTANT: Install equipment shutoff valve in an accessible location within 6 feet of the appliance. The equipment shutoff valve is for turning on or shutting off the gas to the appliance.

Apply pipe joint sealant lightly to male NPT threads. This will prevent excess sealant from going into pipe. Excess sealant in pipe could result in clogged heater valves.

WARNING: Use pipe joint sealant that is resistant to liquid petroleum (LP) gas.

We recommend that you install a sediment trap in supply line as shown in Figure 13, depending on your model. Locate sediment trap where it is within reach for cleaning. Install in piping system between fuel supply and heater. Locate sediment trap where trapped matter is not likely to freeze. A sediment trap traps moisture and contaminants. This keeps them from going into heater controls. If sediment trap is not installed or is installed wrong, heater may not run properly.

Approved Flexible Gas Hose
(if allowed by local codes)

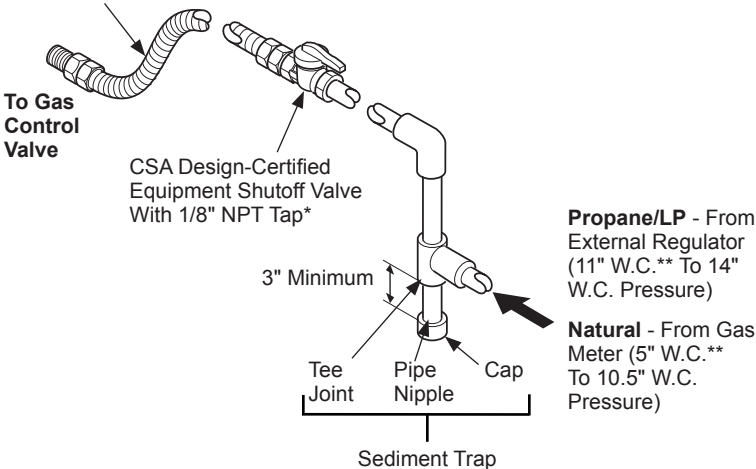

Figure 13 - Gas Connection (Remote-Ready Models Only)

* Purchase the optional CSA design-certified equipment shutoff valve from your dealer. See *Accessories*, page 26.

**Minimum inlet pressure for purpose of input adjustment.

CAUTION: Avoid damage to gas control. Hold gas control with wrench when connecting it to gas piping and/or fittings.

CHECKING GAS CONNECTIONS

WARNING: Test all gas piping and connections for leaks after installing or servicing. Correct all leaks at once.

WARNING: Never use an open flame to check for a leak. Apply a noncorrosive leak detection fluid to all joints. Bubbles forming show a leak. Correct all leaks at once.

CAUTION: Make sure external regulator has been installed between propane/LP supply and heater. See guidelines under *Connecting to Gas Supply*, page 13.

INSTALLATION

Continued

PRESSURE TESTING GAS SUPPLY PIPING SYSTEM

Test Pressures In Excess Of 1/2 PSIG (3.5 kPa)

1. Disconnect appliance with its appliance main gas valve (control valve) and equipment shutoff valve from gas supply piping system. Pressures in excess of 1/2 psig will damage heater regulator.
2. Cap off open end of gas pipe where equipment shutoff valve was connected.
3. Pressurize supply piping system by either opening propane/LP supply tank valve for propane/LP gas or opening main gas valve located on or near gas meter for natural gas or using compressed air.
4. Check all joints of gas supply piping system. Apply noncorrosive leak detection fluid to all joints. Bubbles forming show a leak.
5. Correct all leaks at once.
6. Reconnect heater and equipment shutoff valve to gas supply. Check reconnected fittings for leaks.

Test Pressures Equal To or Less Than 1/2 PSIG (3.5 kPa)

1. Close equipment shutoff valve (see Figure 14).
2. Pressurize supply piping system by either opening propane/LP supply tank valve for propane/LP gas or opening main gas valve located on or near gas meter for natural gas or using compressed air.
3. Check all joints from gas meter to equipment shutoff valve for natural gas or propane/LP supply to equipment shutoff valve for propane/LP (see Figure 15 or 16). Apply noncorrosive leak detection fluid to all joints. Bubbles forming show a leak.
4. Correct all leaks at once.

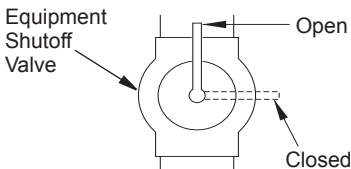

Figure 14 - Equipment Shutoff Valve

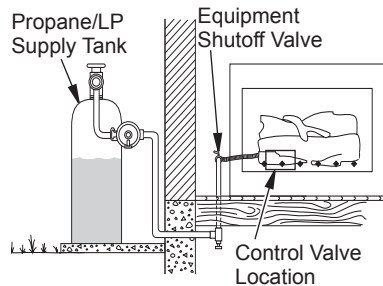

Figure 15 - Checking Gas Joints (Propane/LP Gas Only)

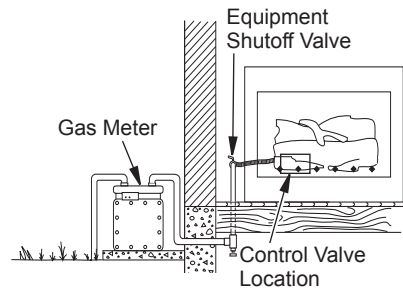



Figure 16 - Checking Gas Joints (Natural Gas Only)

PRESSURE TESTING HEATER GAS CONNECTIONS

1. Open equipment shutoff valve (see Figure 14).
2. Open main gas valve located on or near gas meter for natural gas or open propane/LP supply tank valve.
3. Make sure control knob of heater is in the OFF position.
4. Check all joints from equipment shutoff valve to gas control (see Figures 15 and 16). Apply noncorrosive leak detection fluid to all joints. Bubbles forming show a leak.
5. Correct all leaks at once.
6. Light heater (see *Operating Heater*, page 16). Check all other internal joints for leaks.
7. Turn off heater.

OPERATING HEATER

FOR YOUR SAFETY READ
BEFORE LIGHTING

 **WARNING:** If you do not follow these instructions exactly, a fire or explosion may result causing property damage, personal injury or loss of life.

- A. This appliance has a pilot which must be lighted by hand. When lighting the pilot, follow these instructions exactly.
- B. **BEFORE LIGHTING** smell all around the appliance area for gas. Be sure to smell next to the floor because some gas is heavier than air and will settle on the floor.
- WHAT TO DO IF YOU SMELL GAS**
- Do not try to light any appliance.
 - Do not touch any electric switch; do not use any phone in your building.
 - Immediately call your gas supplier from a neighbor's phone. Follow the gas supplier's instructions.
 - If you cannot reach your gas supplier, call the fire department.
- C. Use only your hand to push in or turn the gas control knob. Never use tools. If the knob will not push in or turn by hand, don't try to repair it, call a qualified service technician or gas supplier. Force or attempted repair may result in a fire or explosion.
- D. Do not use this appliance if any part has been under water. Immediately call a qualified service technician to inspect the appliance and to replace any part of the control system and any gas control which has been under water.

LIGHTING INSTRUCTIONS

WARNING

- If fireplace has glass doors, never operate this heater with glass doors closed. If you operate heater with doors closed, heat buildup inside fireplace will cause gas to burst. Also if fireplace opening has vents at the bottom, you must open the vents before operating heater.
- You must operate this heater with a fireplace screen in place. Make sure fireplace screen is closed before running heater.

NOTICE: During initial operation of new heater, burning logs will give off a paper-burning smell. Orange flame will also be present. Open damper or window to vent smell. This will only last a few hours.

Note: Home owners generally prefer to operate their heater with the chimney damper closed. This will put all the heat into the room. However, there may be times you will desire the full flames of the HI heat setting but will find the heat output excessive. You can open the chimney damper (if you have one) fully or partially to release some of the heat.

 **WARNING:** Damper handle will be hot if heater has been running.

1. **STOP!** Read the safety information, starting in column 1, of this page.
2. Make sure equipment shutoff valve is fully open.
3. Set switch in the OFF position.
4. Press in and turn control knob clockwise  to the OFF position (see Figure 17, page 17).

OPERATING HEATER

Continued

⚠ WARNING: Burners will come on automatically within one minute when the switch is in the ON position after the pilot is lit.

5. Wait five (5) minutes to clear out any gas. Then smell for gas, including near the floor. If you smell gas, STOP! Follow "B" in the safety information, starting in column 1 of this page. If you don't smell gas, go to the next step.

6. Press in and turn control knob counterclockwise ↶ to the PILOT position. Press in control knob for five (5) seconds (see Figure 17).

Note: You may be running this heater for the first time after hooking up to gas supply. If so, the control knob may need to be pressed in for 30 seconds or more. This will allow air to bleed from the gas system.

7. With control knob pressed in, press and release ignitor button. This will light pilot. The pilot is attached to the front burner. If needed, keep pressing ignitor button until pilot lights.

Note: If pilot does not stay lit, contact a qualified service person or gas supplier for repairs. Until repairs are made, light pilot with match. To light pilot with match, see *Manual Lighting Procedure*, page 18.

8. Keep control knob pressed in for 30 seconds after lighting pilot. After 30 seconds, release control knob.

• If control knob does not pop out when released, contact a qualified service person or gas supplier for repairs.

Note: If pilot goes out, repeat steps 4 through 8, page 16.

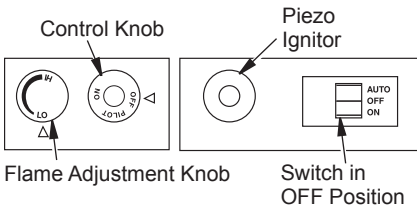

Figure 17 - Control Knob and Ignitor Button Location, Manual Controlled

9. Slightly push in and turn control knob counterclockwise ↶ to the ON position.
10. Wait one minute and switch selector switch to the ON position to light burners. **Note:** AUTO is only functional when using GWMT1 or GWMS2 optional accessories.
11. Set flame adjustment knob to any level between HI and LO.

⚠ CAUTION: Do not try to adjust heating levels by using the equipment shutoff valve.

⚠ WARNING: Make sure the selector switch is in the OFF position when you are away from home for long periods of time. Heater will come on automatically with selector switch in the ON position.

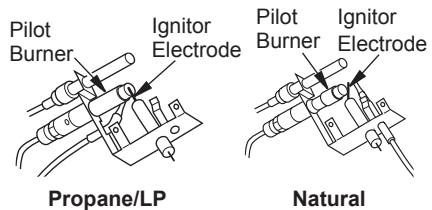

Figure 18 - Pilot

TO TURN OFF GAS TO APPLIANCE

Shutting Off Heater

1. Turn control knob clockwise ↷ to the OFF position.
- 2a. Set selector switch in the OFF position.
- 2b. If Using Optional Hand-Held Remote: Set selector switch in the OFF position to prevent draining battery.

Shutting Off Burner Only (pilot stays lit)

You may shut off the burners and keep the pilot lit by doing one of the following:

1. Turn control knob clockwise ↷ to the PILOT position.
2. Use remote control manual OFF button.
3. Set selector switch in the OFF position.

OPERATING HEATER

Continued

MANUAL LIGHTING PROCEDURE

1. Follow steps 1 through 6 under *Lighting Instructions*, page 16.
2. Depress control knob and light pilot with match.
3. Keep control knob pressed in for 30 seconds after lighting pilot. After 30 seconds, release control knob. Now follow steps 9 through 11, *Lighting Instructions*, page 17.

OPTIONAL HAND-HELD REMOTE OPERATION

Note: All remote control accessories must be purchased separately (see *Accessories*, page 26). Follow instructions included with the remote control.

NOTICE: You must light the pilot before using the hand-held remote control unit. See *Lighting Instructions* on page 16.

After lighting, let pilot flame burn for about one minute. Turn control knob to ON position. Adjust flame adjustment knob anywhere between HI and LO. Slide the selector switch to the REMOTE position (see Figure 19). **Note:** The burner may light if hand-held remote was on when selector switch was last turned off. You can now turn the burner on and off with the hand-held remote control unit.

IMPORTANT: Do not leave the selector switch in the REMOTE or ON position when the pilot is not lit. This will drain the battery.

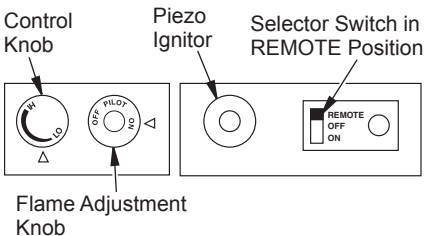

Figure 19 - Setting the Selector Switch, Control Knob and Flame Adjustment Knob for Remote Operation

ON/OFF SERIES (MODEL GHRCB)

Hold the control button on the hand-held remote until burner turns on. Hold the control button again until burner turns off (see Figure 20).

To Lock press both buttons on hand-held remote control until light stops flashing. Hand-held remote control is now locked. If the fire is on it will be turned off automatically. In the locked state, the light will not light up when any button is pressed.

To Unlock press both buttons together on hand-held remote control until the light stops flashing. The hand-held remote is now unlocked.

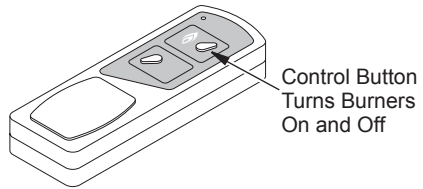

Figure 20 - On/Off Hand-Held Remote Control Unit (GHRCB)

THERMOSTAT SERIES (MODEL GHRCTB)

The hand-held remote can be operated using either the manual mode (MANU) or thermostatic mode (AUTO) (see Figure 21, page 19). To select Fahrenheit/Centigrade mode display, carefully press the °C/°F mode button with the end of a paper clip or similar blunt object.

Manual Mode

1. Press the **POWER** and **LOCK** buttons together to turn on the hand-held remote control.
2. Press the **MANU** button to turn on the fireplace.
3. Press the **POWER** and **LOCK** buttons together to turn off the fireplace.

Auto (Thermostatic) Mode

1. Press the **POWER** and **LOCK** buttons together to turn on the hand-held remote control.
2. Press **AUTO** button to select this mode.
3. Set the desired room temperature by pressing the **TEMP +** or **-** buttons.
4. Press the **POWER** and **LOCK** buttons together to turn off the fireplace.

OPERATING HEATER

Continued

Note: Do not leave the hand-held remote in the AUTO mode close to the fireplace. The radiant heat from the fireplace will turn off the fireplace. Ideally, place the hand-held remote in the center of the room facing towards the fireplace.

Note: Do not hold the hand-held remote for a long time. Body temperature will affect its operation in the AUTO mode.

Safety Features

When away from home for an extended period of time or as a child safety feature to prevent accidental ignition of the fireplace, the receiver ON/OFF/REMOTE switch should be in the OFF position.

Auto Shutoff Feature

1. If the average room temperature exceeds 82 degrees Fahrenheit (28 degrees Centigrade), the hand-held remote control will perform a safety override and shut the fireplace off. This feature is not available in the MANU mode.
2. The receiver continuously receives signals from the hand-held remote to control the room temperature. If the hand-held remote is misplaced, obstructed or for any reason cannot transmit to the receiver, the receiver will shut off the fireplace after 8 minutes.

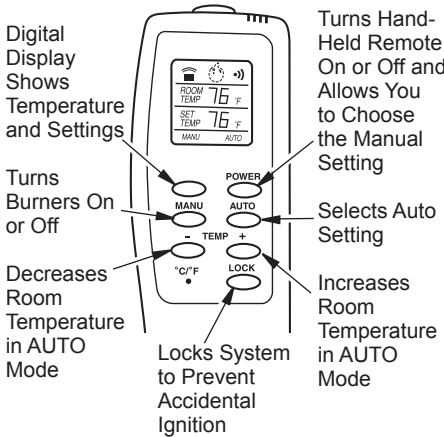

Figure 21 - Thermostat Hand-Held Remote Control Unit (GHRCTB)

Key Pad Lock Feature

This feature allows the user to lock/unlock the keypad on the hand-held remote in the MANU or AUTO mode to prevent inadvertent operation (i.e. children operating the hand-held remote control, etc.). The keypad is locked in either on or off. Press the POWER and LOCK buttons together to turn the unit on or off.

INSPECTING BURNERS

Check pilot flame pattern and burner flame patterns often.

PILOT FLAME PATTERN

Figure 22 shows a correct pilot flame pattern. Figure 23 shows an incorrect pilot flame pattern. The incorrect pilot flame is not touching the thermocouple. This will cause the thermocouple to cool. When the thermocouple cools, the heater will shut down.

If pilot flame pattern is incorrect, as shown in Figure 23

- turn heater off (see *To Turn Off Gas to Appliance*, page 17)
- see *Troubleshooting*, page 22

Note: The pilot flame on natural gas units will have a slight curve, but flame should be blue and have no yellow or orange color.

Pilot Burner

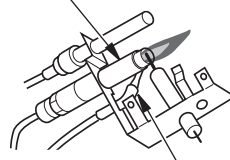

Thermocouple

Figure 22 - Correct Pilot Flame Pattern (Your pilot may vary from pilots shown)

Pilot Burner

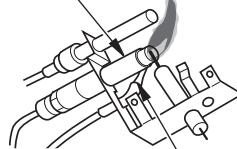

Thermocouple

Figure 23 - Incorrect Pilot Flame Pattern (Your pilot may vary from pilots shown)

INSPECTING BURNERS

Continued

BURNER FLAME PATTERN

Figure 24 shows correct burner flame pattern.

NOTICE: Do not mistake orange flames with yellow tipping. Dirt or other fine particles are burned by heater, causing brief patches of orange flame.

If burner flame pattern is incorrect, as shown in Figure 25

- turn heater off (see *To Turn Off Gas to Appliance*, page 17)
- see *Troubleshooting*, page 22

The flames from the burner travel horizontally through the log set and emerge at the middle and rear of the set against the back logs.

The flames are blue off the burner and as they progress through the log set, change to a light yellow color, yellow decorative flames are visible as the flames exit the log set.

The base of the log set and the underside of the top logs glow red. Natural gas models will burn with more blue flame, while propane gas model will burn with bright yellow flame.

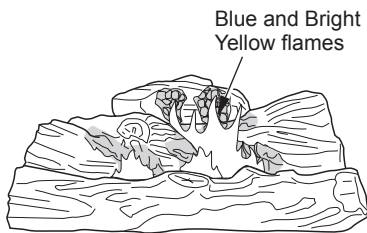

Figure 24 - Correct Burner Flame Pattern

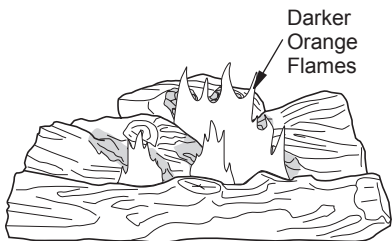

Figure 25 - Incorrect Burner Flame Pattern

CLEANING AND MAINTENANCE

WARNING: Turn off heater and let cool before cleaning.

CAUTION: You must keep control areas, burners and circulating air passageways of heater clean. Inspect these areas of heater before each use. Have heater inspected yearly by a qualified service person. Heater may need more frequent cleaning due to excessive lint from carpeting, pet hair, bedding material, etc.

WARNING: Failure to keep the primary air openings of the burner clean may result in soot-ing and property damage.

BURNER INJECTOR HOLDER AND PILOT AIR INLET HOLE

The primary air inlet openings allow the proper amount of air to mix with the gas. This provides a clean burning flame. Keep these holes clear of dust, dirt, lint and pet hair. Clean these air inlet openings prior to each heating season. Blocked air openings will create soot. We recommend that you clean the unit every three months during operation and have heater inspected yearly by a qualified service person.

We also recommend that you keep the burner tube and pilot assembly clean and free of dust and dirt. To clean these parts we recommend using compressed air no greater than 30 PSI. Your local computer store, hardware store or home center may carry compressed air in a can. You can use a vacuum cleaner in the blow position. If using compressed air in a can, please follow the directions on the can. If you don't follow directions on the can, you could damage the pilot assembly.

CLEANING AND MAINTENANCE

Continued

1. Shut off the unit, including the pilot. Allow the unit to cool for at least thirty minutes.
2. Inspect burner, pilot and primary air inlet opening on injector holder for dust and dirt (see Figure 26).
3. Blow air through the ports/slots and holes in the burner.
4. Check the injector holder located at the end of the burner tube again. Remove any large particles of dust, dirt, lint or pet hair with a soft cloth or vacuum cleaner nozzle.
5. Blow air into the primary air opening on the injector holder.
6. In case any large clumps of dust have now been pushed into the burner repeat steps 3 and 4.

Clean the pilot assembly also. A yellow tip on the pilot flame indicates dust and dirt in the pilot assembly. There is a small pilot air inlet hole about two inches from where the pilot flame comes out of the pilot assembly (see Figure 27). With the unit off, lightly blow air through the air inlet hole in the same direction as gas flow. You may blow through a drinking straw if compressed air is not available.

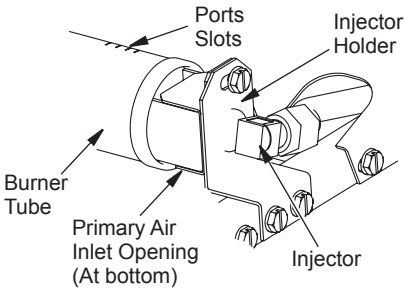
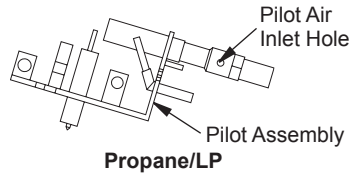
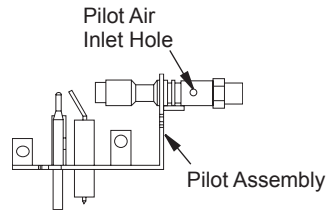

Figure 26 - Injector Holder On Outlet Burner Tube



Propane/LP



Natural

Figure 27 - Pilot Inlet Air Hole (Your pilot may vary from pilots shown)

WIRING DIAGRAM

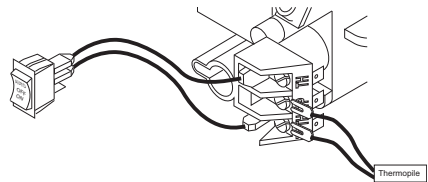

TROUBLESHOOTING

⚠ WARNING: Turn off and unplug heater and let cool before servicing. Only a qualified service person should service and repair heater.

⚠ CAUTION: Never use a wire, needle or similar object to clean ODS/pilot. This can damage ODS/pilot unit.

Note: All troubleshooting items are listed in order of operation.

OBSERVED PROBLEM	POSSIBLE CAUSE	REMEDY
When ignitor button is pressed, there is no spark at ODS/pilot	1. Ignitor electrode not connected to ignitor cable	1. Reconnect ignitor cable
	2. Ignitor cable pinched or wet	2. Free ignitor cable if pinched by any metal or tubing. Keep ignitor cable dry
	3. Piezo ignitor nut is loose	3. Tighten nut holding piezo ignitor to base panel of log set. Nut is located behind base panel.
	4. Broken ignitor cable	4. Replace ignitor cable
	5. Bad piezo ignitor	5. Replace piezo ignitor
	6. Ignitor electrode positioned wrong or broken	6. Replace pilot assembly for remote-ready units; Replace ignitor electrode for variable manually controlled units
When ignitor button is pressed, there is spark at ODS/pilot but no ignition	1. Gas supply turned off or equipment shutoff valve closed	1. Turn on gas supply or open equipment shutoff valve
	2. Control knob not in PILOT position	2. Turn control knob to PILOT position
	3. Control knob not pressed in while in PILOT position	3. Press in control knob while in PILOT position
	4. Air in gas lines when installed	4. Continue holding down control knob. Repeat igniting operation until air is removed
	5. Depleted gas supply (propane/LP only)	5. Contact local propane/LP gas company
	6. ODS/pilot is clogged	6. Clean ODS/pilot (see <i>Cleaning and Maintenance</i> , page 20) or replace ODS/pilot assembly
	7. Gas regulator setting is not correct	7. Replace gas regulator

TROUBLESHOOTING

Continued

OBSERVED PROBLEM	POSSIBLE CAUSE	REMEDY
ODS/pilot lights but flame goes out when control knob is released	<ol style="list-style-type: none">1. Control knob not fully pressed in2. Control knob not pressed in long enough3. Safety interlock system has been triggered4. Equipment shutoff valve not fully open5. Pilot flame not touching thermocouple, which allows thermocouple to cool, causing pilot flame to go out. This problem could be caused by one or both of the following:<ol style="list-style-type: none">A) Low gas pressureB) Dirty or partially clogged ODS/pilot6. Thermocouple connection loose at control valve7. Thermocouple damaged8. Control valve damaged	<ol style="list-style-type: none">1. Press in control knob fully2. After ODS/pilot lights, keep control knob pressed in 30 seconds3. Wait one minute for safety interlock system to reset. Repeat ignition operation4. Fully open equipment shutoff valve5. A) Contact local natural or propane/LP gas company B) Clean ODS/pilot (see <i>Cleaning and Maintenance</i>, page 20) or replace ODS/pilot assembly6. Hand tighten until snug, then tighten 1/4 turn more7. Replace pilot assembly8. Replace control valve
One or both burners do not light after ODS/pilot is lit	<ol style="list-style-type: none">1. Inlet gas pressure is too low2. Burner orifice(s) clogged3. Mislocated crossover tube4. Burner orifice(s) diameter is too small5. Remote selector in OFF position6. Wire disconnected from gas control	<ol style="list-style-type: none">1. Contact local natural or propane/LP gas company2. Clean burner(s) (see <i>Cleaning and Maintenance</i>, page 20) or replace burner orifice(s)3. Contact qualified service person4. Replace burner orifice(s)5. Put remote selector in ON position6. See <i>Wiring Diagram</i>, page 21
Delayed ignition of burner	<ol style="list-style-type: none">1. Manifold pressure is too low2. Burner orifice(s) clogged3. Mislocated crossover tube	<ol style="list-style-type: none">1. Contact local natural or propane/LP gas company2. Clean burner(s) (see <i>Cleaning and Maintenance</i>, page 20) or replace burner orifice(s)3. Contact qualified service person
Burner backfiring during combustion	<ol style="list-style-type: none">1. Burner orifice is clogged or damaged2. Damaged burner3. Gas regulator defective	<ol style="list-style-type: none">1. Clean burner (see <i>Cleaning and Maintenance</i>, page 20) or replace burner orifice2. Replace damaged burner3. Replace gas regulator

TROUBLESHOOTING

Continued

OBSERVED PROBLEM	POSSIBLE CAUSE	REMEDY
Orange flame in burner during burner combustion	<ol style="list-style-type: none">1. Not enough air2. Gas regulator defective	<ol style="list-style-type: none">1. Check burner(s) for dirt and debris. If found, clean burner(s) (see <i>Cleaning and Maintenance</i>, page 20)2. Replace gas regulator
Slight smoke or odor during initial operation	<ol style="list-style-type: none">1. Residues from manufacturing processes and logs curing	<ol style="list-style-type: none">1. Problem will stop after a few hours of operation
Heater produces a whistling noise when burners are lit	<ol style="list-style-type: none">1. Turning control knob to HI position when burners are cold2. Air in gas line3. Air passageways on heater blocked4. Dirty or partially clogged burner orifice(s)	<ol style="list-style-type: none">1. Turn control knob to LO position and let warm up for a minute2. Operate burners until air is removed from line. Have gas line checked by local natural or propane/LP gas company3. Observe minimum installation clearances (see pages 9 through 12)4. Clean burners (see <i>Cleaning and Maintenance</i>, page 20) or replace burner orifice(s)
White powder residue forming within burner box or on adjacent walls or furniture	<ol style="list-style-type: none">1. When heated, vapors from furniture polish, wax, carpet cleaners, etc. turn into white powder residue	<ol style="list-style-type: none">1. Turn heater off when using furniture polish, wax, carpet cleaners or similar products
Moisture/condensation noticed on windows	<ol style="list-style-type: none">1. Not enough combustion/ventilation air	<ol style="list-style-type: none">1. Refer to <i>Air for Combustion and Ventilation</i> requirements (page 6)
Heater produces a clicking/ticking noise just after burners are lit or shut off	<ol style="list-style-type: none">1. Metal expanding while heating or contracting while cooling	<ol style="list-style-type: none">1. This is common with most heaters. If noise is excessive, contact qualified service person

TROUBLESHOOTING

Continued



WARNING: If you smell gas

- Shut off gas supply.
- Do not try to light any appliance.
- Do not touch any electrical switch; do not use any phone in your building.
- Immediately call your gas supplier from a neighbor's phone. Follow the gas supplier's instructions.
- If you cannot reach your gas supplier, call the fire department.

IMPORTANT: Operating heater where impurities in air exist may create odors. Cleaning supplies, paint, paint remover, cigarette smoke, cements and glues, new carpet or textiles, etc., create fumes. These fumes may mix with combustion air and create odors. These odors will disappear over time.

OBSERVED PROBLEM	POSSIBLE CAUSE	REMEDY
Heater produces unwanted odors	<ol style="list-style-type: none">1. Heater burning vapors from paint, hair spray, glues, cleaners, chemicals, new carpet, etc. (See <i>IMPORTANT</i> statement above)2. Low fuel supply (propane/LP only)3. Gas leak. See Warning statement at top of page	<ol style="list-style-type: none">1. Open window to ventilate room. Stop using odor causing products while heater is running2. Refill supply tank (propane/LP only)3. Locate and correct all leaks (see <i>Checking Gas Connections</i>, page 14)
Heater shuts off in use (ODS operates)	<ol style="list-style-type: none">1. Not enough fresh air is available2. Low line pressure3. ODS/pilot is partially clogged	<ol style="list-style-type: none">1. Open window and/or door for ventilation2. Contact local natural or propane/LP gas company3. Clean ODS/pilot (see <i>Cleaning and Maintenance</i>, page 20)
Gas odor even when control knob is in OFF position	<ol style="list-style-type: none">1. Gas leak. See Warning statement at top of page2. Control valve or gas control defective	<ol style="list-style-type: none">1. Locate and correct all leaks (see <i>Checking Gas Connections</i>, page 14)2. Replace control valve or gas control
Gas odor during combustion	<ol style="list-style-type: none">1. Foreign matter between control valve and burner2. Gas leak. See Warning statement at top of page	<ol style="list-style-type: none">1. Take apart gas tubing and remove foreign matter2. Locate and correct all leaks (see <i>Checking Gas Connections</i>, page 14)
Log set cycles to pilot, but room temperature drops to a lower than ideal level before log set comes back on	<ol style="list-style-type: none">1. Hand-held remote control is too close to heater	<ol style="list-style-type: none">1. Move hand-held remote control unit farther away from the heater

SPECIFICATIONS

	VFRMV18NA	VFRMV24NA	VFRMV18PA	VFRMV24PA
Btu (Variable)	24,000/36,000	28,000/39,000	26,000/34,000	31,000/39,000
Type Gas	Natural Gas Only	Natural Gas Only	Propane/LP Only	Propane/LP Only
Ignition	Piezo	Piezo	Piezo	Piezo
Manifold Pressure	3.5" - 1.6"W.C.	3.5" - 1.6"W.C.	10" - 6.3"W.C.	10" - 6.3"W.C.
Inlet Gas Pressure (in. of water)				
Maximum	10.5" W.C.	10.5" W.C.	14" W.C.	14" W.C.
Minimum*	5.0" W.C.	5.0" W.C.	11" W.C.	11" W.C.

* For purpose of input adjustment

Manufactured by: DESA FMI, LLC, 1769 E. Lawrence St. Russellville, AL 35653

Note: This appliance has been designed-certified by ANS Z21.11.2a-2003 Unvented Room Heaters and ANS Z21.60-2003.

Decorative Gas Appliances for Installation in Solid Fuel Burning Fireplaces by OMNI Test Laboratories.

REPLACEMENT PARTS

Note: Use only original replacement parts. This will protect your warranty coverage for parts replaced under warranty.

PARTS UNDER WARRANTY

Contact authorized dealers of this product. If they can't supply original replacement part(s), call DESA Technical Service Department at 1-866-672-6040.

When calling DESA, have ready

- your name
- your address
- model and serial numbers of your heater
- how heater was malfunctioning
- type of gas used (propane/LP or natural gas)
- purchase date

Usually, we will ask you to return the part to the factory.

PARTS NOT UNDER WARRANTY

Contact authorized dealers of this product. If they can't supply original replacement part(s), call DESA at 1-866-672-6040 for referral information.

When calling DESA, have ready

- model and serial numbers of your heater
- the replacement part number

SERVICE HINTS

When Gas Pressure Is Too Low

- pilot will not stay lit
- burners will have delayed ignition
- heater will not produce specified heat
- propane/LP gas supply may be low

You may feel your gas pressure is too low. If so, contact your local propane/LP or natural gas supplier.

TECHNICAL SERVICE

You may have further questions about installation, operation or troubleshooting. If so, contact DESA Technical Service Department at 1-866-672-6040. When calling please have your model and serial numbers of your heater ready.

You can also visit DESA technical services web site at www.desatech.com.

ACCESSORIES

Purchase these heater accessories from your local dealer. If they can not supply these accessories, call DESA at 1-866-672-6040 for referral information. You can also write to the address listed on the back page of this manual.



EQUIPMENT SHUTOFF VALVE GA5010

For all models. Equipment shutoff valve with 1/8" NPT tap. Fits 1/2" NPT pipe.

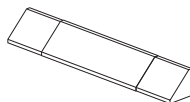

FIREPLACE HOOD

Black - GA6050

Brass - GA6052

Antique Brass - GA6053

For all models. Helps deflect heat away from mantel or wall above fireplace. Fits openings 28" to 48" wide.

ACCESSORIES

Continued

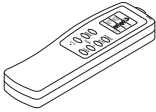

RECEIVER AND HAND-HELD THERMOSTAT REMOTE CONTROL KIT - GHRCTB

For all models. Allows the gas log heater to be operated in a manually or thermostatically controlled mode. You can turn the gas log heater on and off without ever leaving the comfort of your easy chair.

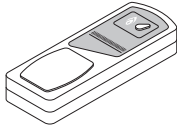

RECEIVER AND HAND-HELD REMOTE CONTROL KIT - GHRCB

For all models. Allows the gas log heater to be turned on and off by using a hand-held remote control.

WALL-MOUNT THERMOSTAT SWITCH - GWMT1 (Not Shown)

For all models. The desired comfort setting can be selected on the wall thermostat and the log heater will automatically cycle from pilot to the heat setting selected.

WALL-MOUNT ON/OFF SWITCH GWMS2 (Not Shown)

For all models. Allows the gas log heater to be turned on and off with a wall switch.

VENT-FREE LOGMATE® FIREBOXES (Not Shown)

Available in 32", 36" and 42" models. Circulating fireboxes feature louvers and an optional blower. Non-circulating, smooth face models are ideal for custom trim applications such as stone or marble.

FB32C (CIRCULATING), FB32NC (NON-CIRCULATING) SERIES (Not Shown)

For all models.

FB36CA, FB42C SERIES (CIRCULATING), FB36NCA, FB42NC SERIES (NON-CIRCULATING) (Not Shown)

For all models.

DAMPER CLAMP - GA6080 (Not Shown)

For all models. Permanently opens chimney flue damper for vented operation.

LAVA ROCK - GA6060 (Not Shown)

For all models. Order when additional rock is desired. (1.8 lb. bag)

CLEANING KIT - GCK (Not Shown)

For all models. Your vent-free gas appliance requires regular cleaning and maintenance to prevent performance problems. This kit gives you the tools and instructions to make it easy to clean all critical areas of your appliance.

INFORMATION VIDEO - 108917-01

For all models. A care and maintenance video is available by calling 1-866-672-6040.

FLOOR MEDIA KIT - FM100

For all models. This kit is used to blend the edge of the burner to the fireplace floor for a more natural appearance. It includes embers, lava rock and nine fiber log pieces.

CONTROL COVER MEDIA KIT CC100

For all models. This kit is used as an addition to or instead of the Floor Media Kit FM100. It includes 6 fiber log chunks to be placed on the fireplace floor in front of the controls for a more natural appearance.

ILLUSTRATED PARTS BREAKDOWN

VFRMV18NA, VFRMV18PA
VFRMV24NA (Shown), VFRMV24PA

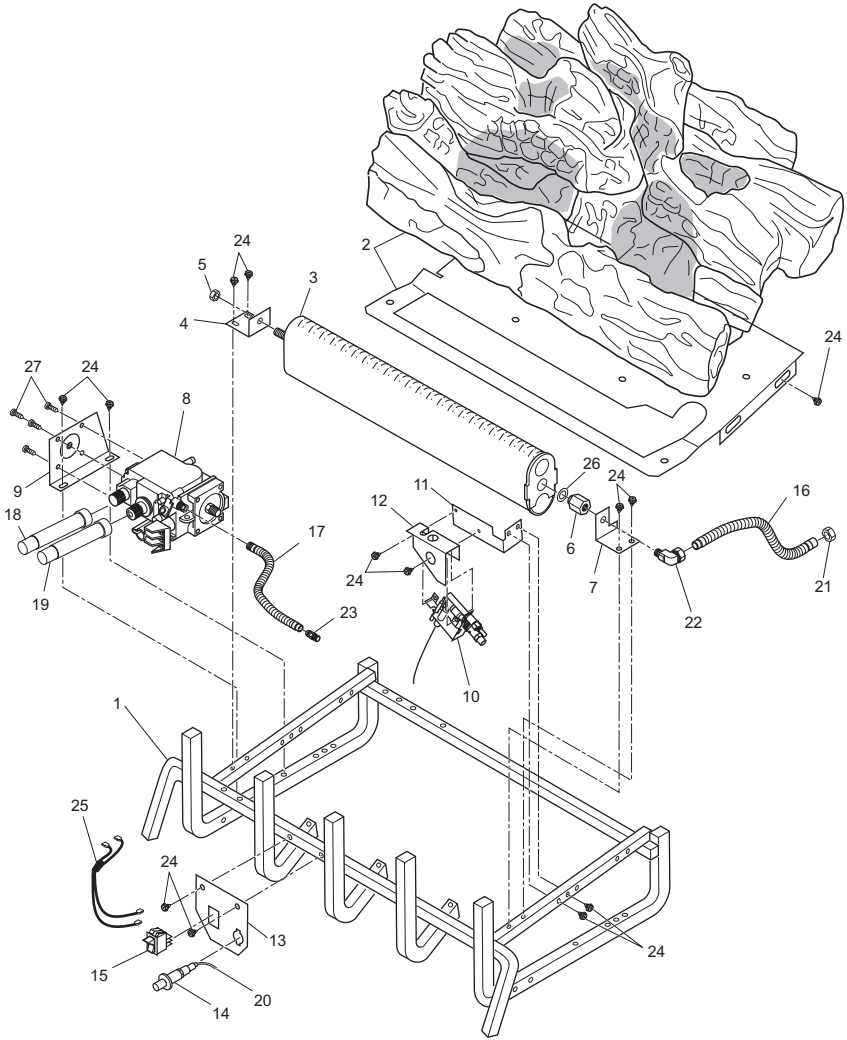

PARTS LIST

This list contains replaceable parts used in your heater. When ordering parts, follow the instructions listed under *Replacement Parts* on page 26 of this manual.

KEY NO.	PART NUMBER				DESCRIPTION	QTY.
	VFRMV18NA	VFRMV24NA	VFRMV18PA	VFRMV24PA		
1	114854-01	114790-01	114854-01	114790-01	Grate Assembly	1
2	114860-01	114807-01	114860-01	114807-01	Log Set Assembly	1
3	114858-02	114797-02	114858-01	114797-01	Burner	1
4	114798-01	114798-01	114798-01	114798-01	Burner Support Bracket	1
5	11209	11209	11209	11209	10-24 Hex Nut	1
6	114799-04	114799-03	114799-02	114799-01	Orifice	1
7	114802-01	114802-01	114802-01	114802-01	Orifice Bracket	1
8	111807-01	111807-01	111807-02	111807-02	SIT Millivolt Valve	1
9	114795-01	114795-01	114795-01	114795-01	Valve Mounting Bracket	1
10	103779-01	112376-01	114859-01	114859-01	ODS Pilot Assy	1
11	114805-01	114805-01	114805-01	114805-01	Pilot Bracket	1
12	115027-01	115027-01	115027-01	115027-01	Pilot Shield	1
13	114793-01	114793-01	114793-01	114793-01	Piezo/Switch Bracket	1
14	097159-04	097159-04	097159-04	097159-04	Piezo	1
15	14579	14579	14579	14579	Rocker Switch	1
16	111817-01	111817-01	111817-01	111817-01	Main Gas Line	1
17	114804-01	114804-01	114804-01	114804-01	ODS Pilot Line	1
18	103784-01	103784-01	103784-01	103784-01	ON/PILOT/OFF Knob Extension	1
19	103784-02	103784-02	103784-02	103784-02	HI/LO Knob Extension	1
20	098271-13	098271-13	097271-13	098271-13	Piezo Wire	1
21	111828-01	111828-01	111828-01	111828-01	Compression Sleeve And Nut, 3/16"	1
22	111824-01	111824-01	111824-01	111824-01	Fitting 3/8" NPT Male To 3/8" Comp.	1
23	114801-01	114801-01	114801-01	114801-01	Fitting 1/8" NPT Male To 3/8" Comp.	1
24	111800-01	111800-01	111800-01	111800-01	10-24 x 3/8" Screw	16
25	103284-02	103284-02	103284-02	103284-02	Wire Harness	1
26	114800-01	114800-01	114800-01	114800-01	3/8" Flat Washer	2
27	111816-01	111816-01	111816-01	111816-01	#10-32 x 3/8" Screw	2
PARTS AVAILABLE NOT SHOWN						
	100563-01	100563-01	100563-01	100563-01	Warning Plate	1
	103877-01	103877-01	103877-01	103877-01	Lighting Instruction Plate	1
	100639-01	100639-01	100639-01	100639-01	Caution Decal	1
	GA6060	GA6060	GA6060	GA6060	Lava Rock	1

WARRANTY INFORMATION

KEEP THIS WARRANTY

Model _____
Serial No. _____
Date Purchased _____

Always specify model and serial numbers when communicating with the factory.

We reserve the right to amend these specifications at any time without notice. The only warranty applicable is our standard written warranty. We make no other warranty, expressed or implied.

LIMITED WARRANTY VENT-FREE GAS LOG HEATERS

DESA warrants this product to be free from defects in materials and components for four (4) years from the date of first purchase, provided that the product has been properly installed, operated and maintained in accordance with all applicable instructions. To make a claim under this warranty the Bill of Sale or cancelled check must be presented.

This warranty is extended only to the original retail purchaser. This warranty covers the cost of part(s) required to restore this heater to proper operating condition and an allowance for labor when provided by a DESA Authorized Service Center. Warranty part(s) MUST be obtained through authorized dealers of this product and/or DESA who will provide original factory replacement parts. Failure to use original factory replacement parts voids this warranty. The heater MUST be installed by a qualified installer in accordance with all local codes and instructions furnished with the unit.

This warranty does not apply to parts that are not in original condition because of normal wear and tear or parts that fail or become damaged as a result of misuse, accidents, lack of proper maintenance or defects caused by improper installation. Travel, diagnostic cost, labor, transportation and any and all such other costs related to repairing a defective heater will be the responsibility of the owner.

TO THE FULL EXTENT ALLOWED BY THE LAW OF THE JURISDICTION THAT GOVERNS THE SALE OF THE PRODUCT; THIS EXPRESS WARRANTY EXCLUDES ANY AND ALL OTHER EXPRESSED WARRANTIES AND LIMITS THE DURATION OF ANY AND ALL IMPLIED WARRANTIES, INCLUDING WARRANTIES OF MERCHANTABILITY AND FITNESS FOR A PARTICULAR PURPOSE TO FOUR (4) YEARS ON ALL COMPONENTS FROM THE DATE OF FIRST PURCHASE; AND DESA'S LIABILITY IS HEREBY LIMITED TO THE PURCHASE PRICE OF THE PRODUCT AND DESA SHALL NOT BE LIABLE FOR ANY OTHER DAMAGES WHATSOEVER INCLUDING INDIRECT, INCIDENTAL OR CONSEQUENTIAL DAMAGES.

Some states do not allow a limitation on how long an implied warranty lasts or an exclusion or limitation of incidental or consequential damages, so the above limitation on implied warranties or exclusion or limitation on damages may not apply to you.

This warranty gives you specific legal rights and you may also have other rights that vary from state to state.

For information about this warranty write:



2701 Industrial Drive
P.O. Box 90004
Bowling Green, KY 42102-9004
www.desatech.com



114745 01
NOT A UPC

114745-01
Rev. B
10/04