

# **Omnidirectional Laser Scan Module**



## **User's Manual**

No warranty of any kind is made in regard to this material, including, but not limited to, implied warranties of merchantability or fitness for a particular purpose. We are not liable for any errors contained herein nor incidental or consequential damages in connection with furnishing, performance or use of this material.

No part of this document may be reproduced, transmitted, stored in a retrieval system, transcribed, or translated into any language or computer language in any form or by any means electronic, mechanical, magnetic, optical, chemical, manual or otherwise, without express written consent and authorization.

We reserve the right to make changes in product design without reservation and without notification. The material in this guide is for information only and is subject to change without notice.

All trademarks mentioned herein, registered or otherwise, are the properties of their various respective owners.

Copyright © 2004. All rights reserved.

## **Radio Notice**

This equipment generates, uses and can radiate radio frequency energy. If not installed and used in accordance with the instructions in this manual, it may cause interference to radio communications. The equipment has been tested and found to comply with the limits for a Class A computing device pursuant to EN55022 an 47 CFR, Part 2 and Part 15 of the FCC Rules. These specifications are designed to provide reasonable protection against interference when operated in a commercial environment.

## **Radio and Television Interference**

Operation of this equipment in a residential area can cause interference to radio or television reception. This can be determined by turning the equipment off and on. The user is encouraged to try to correct the interference by one or more of the following measures:

\*\*Re-orient the receiving antenna.

\*\*Relocate the device with respect to the receiver.

- \*\*Move the device away from the receiver.
- \*\*Plug the device into a different outlet so that the device and the receiver are on different branch circuits.

If necessary the user may consult the manufacturer, an authorized dealer, or experienced radio/television technician for additional suggestions. The user may find the following booklet prepared by the Federal Communications Commission helpful: "How to Identify and Resolve Radio-TV Interference Problems." This booklet is available from the U.S. Government Printing Office, Washington, DC20402 U.S.A., Stock No. 004000003454.

### **For CE-countries**

This scanner is in conformity with CE standards. Please note that an approved, CE-marked power supply unit should be used in order to maintain CE conformance.

## Laser Safety

---

The Omnidirectional Laser Scan Module complies with safety standard IEC 60825 for a Class I laser product. It also complies with CDRH as applicable to a Class IIa laser product. Avoid long term starting into direct laser light.

**Radiant Energy:** The Omnidirectional Laser Scan Module uses one low-power visible laser diode operating at 650nm in an opto-mechanical scanner resulting in less than  $3.9\mu\text{W}$  radiated power as observed through a 7mm aperture and averaged over 10 seconds. Do not attempt to remove the protective housing of the scanner, as unscanned laser light with a peak output up to 0.8mW would be accessible inside.

**Laser Light Viewing:** The scan window is the only aperture through which laser light may be observed from this product. A failure of the scanner motor, while the laser diode continues to emit a laser beam, may cause emission levels to exceed those for safe operation. The scanner has safeguards to prevent this occurrence, If, however, a stationary laser beam is emitted, the failing scanner should be disconnected from its power source immediately.

**Adjustments:** Do not attempt any adjustments or alteration of this product. Do not remove the protective housing of the scanner. There are no user-serviceable parts inside.

**Caution:** Use of controls or adjustments or performance of procedures other than those specified herein may result in hazardous laser light exposure.

**Optical:** The use of optical instruments with this product will increase the eye hazard. Optical instruments include binoculars, magnifying glasses, and microscopes but do not include normal eye glasses worn by the user.

## Table of Contents

<b>Introduction.....</b>	<b>1</b>
<b>Unpacking.....</b>	<b>1</b>
<b>Finding Your Way Around.....</b>	<b>2</b>
<b>Connecting and Mounting.....</b>	<b>3</b>
Power.....	3
Verifying Scanner Operation.....	3
Mounting.....	4
Connecting to the Host.....	6
<b>Setting Up the Scanner.....</b>	<b>6</b>
Scan Test.....	6
Set Up.....	7
<b>Operation.....</b>	<b>7</b>
LED Indications.....	8
Beeps.....	9
Changing the Beep Volume.....	9
Sleep Mode.....	9
Controlling from a Host System.....	10
<b>Maintaining the Scanner.....</b>	<b>10</b>
<b>Specifications.....</b>	<b>11</b>
<b>Dimensions.....</b>	<b>13</b>
<b>Troubleshooting.....</b>	<b>15</b>

## **Introduction**

---

This Omnidirectional Laser Scan Module is an easy-to-integrate unit that performs 5 directions of scan field with a 20-line scan pattern cycling at 1200 scan per second for quick accurate reads. The scanner's smart small cubic design allows for easy integration into new equipment and efficiently reduces overall equipment size. Multiple interfaces include keyboard, RS232C, USB1.1, and wand are offered at owner's convenience.

## **Unpacking**

---

The package should contain:

Omnidirectional  
Laser Scanner with cable  
1 ea.



User's Manual



Programming Guide



5V Adaptor (optional)  
1 ea.



If any package contents are damage or missing, please contact your dealer immediately.

## **Finding Your Way Around**

---

### **Front View**

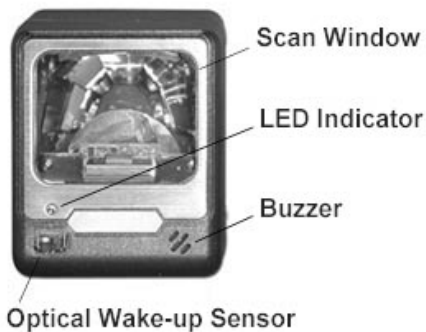

### **Back View**



### **Bottom View**



## **Connecting and Mounting**

---

### **Power**

The scanner needs a minimum of 200mA at 5V power. The power link interface cable that comes with the scanner supports both direct power (where the scanner takes power from the host machine) and external power (the power adapter that's plugged into an AC outlet). If the host machine supplies power, it must be the same as the input power specified (200mA @ 5V). When external power is used, the scanner does not take power from the host machine.

There is no on/off switch on the scanner. It turns on when power is connected and turns off when power is removed.

It is advised to turn off your POS or host system before installing the scanner to avoid electronic damage to your computer.

Make sure to use only AC/DC power adaptor approved for the scanner. The usage of other power supplies may cause damage to the product that's not covered by factory warranty.

### **Verifying Scanner Operation**

Before installing the scanner, follow the procedures below to make sure scanning goes on properly.

1. Connect the scanner with host through cable that is attached to the scanner.
2. (If adaptor is not required, go directly to step 4) Insert the 8-pin modular plug of the power link cable into the "host" connector in the back of the scanner until a firm click is heard.
3. Plug the power adaptor into the jack on the power link cable.



4. When the scanner powers up, LED light up in green and the buzzer makes four short beep sounds. When the self-test is finished the LED light will turn red.
5. Place the "test barcode" in front of the scanner. If the scanner works right, it will make a short beep sound, and the LED will show green light indicating a good read, then the "test barcode" can be removed.

**NOTE:**

- (1) If the scanner does not make any beep sounds or makes the wrong beep sound or no LED light shows when power is connected, remove power from scanner and refer to troubleshooting section.
- (2) If the scanner is using RS-232 or keyboard wedge interface cables, it is able to scan barcodes continuously when power is on. If the scanner is using USB interface cable, it will only be able to scan barcodes continuously only when connected to a host. If the scanner is not connected to a host, it will be able to read one barcode only (LED light stays green).

**Mounting**

1. Scan performance will not be affected by the mounting direction of the scanner.
2. Use mounting holes on the bottom or/and back of the scanner to mount the scanner onto host machine (templates at the last two pages of the manual can be used).

### Back View

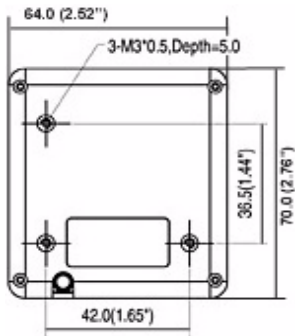

### Bottom View

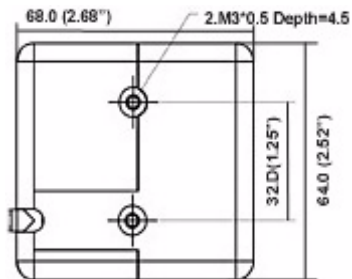

Unit: mm (inch)

\*\*\* SR (strain release) that is connected to the cable rotates 90° to comply with the way the scanner is mounted. Therefore the scanner will be positioned horizontally to the host machine without cable interference for optimal mounting. (See pictures below).

### Horizontal Mounting



### Vertical Mounting



### Connecting to the Host

The scanner connects to a host terminal by an interface cable. This cable connects to the scanner with a modular connector, and connects to the host terminal with the connector required by the host (RS-232, keyboard wedge, or USB. Different connectors used depending on the host.)

Please make sure the right cable is used for connecting the scanner to your host terminal.

### Setting Up the Scanner

---

No set up is required if the scanner is either pre-programmed or it auto-detects and is ready to be used. Otherwise, the scanner must be informed about the type of system it is connected to. This can be done quickly using the Programming Guide that's included in the package.

The Programming Guide is used to set parameters such as communication interface type (RS-232, Keyboard, USB), beep tone, beep volume, sleep mode timing and same-code delay time. Set up of a parameter does not interfere with another parameter.

### Scan Test

1. With the scanner running (LED red) and the host system on, scan few known-good barcodes.
2. Check result on host screen. If scanner is reading correctly, no further set up is necessary. If scanner reads incorrectly, then go to Set Up next.

## Set Up

1. With the scanner running (LED red) and the host system on, scan <Enter/Exit Programming Mode> barcode found on the inside cover of the Programming Guide.
2. Scanner is ready for programming if it gives one low beep sound followed immediately by a high beep sound and LED turns green.
3. Find the barcode which corresponds to the parameter you require in the Programming Guide.
4. Scan the desired barcodes one by one as the scanner beeps once for every barcode it memorizes.
5. When all finished, scan <Enter/Exit Programming Mode> barcode again. The scanner will beep twice, one long and one short. When LED turns red, the scanner has been programmed.
6. Test scan few known-good barcodes to make sure the scanner reads correctly. If not, try set up procedures again.

## Operation

This scanner is omnidirectional reading barcodes in sweep and presentation mode depending on the host system it is attached to. Sweep mode means moving items through the scan window (left to right, right to left, top to bottom, bottom to top etc. are all okay). Presentation mode is when an object is moved toward the scan window (“presented”) until the barcode is read, then the object is removed.

### LED indications

LED	Status Indications
off	no power applied to the scanner
steady red light	the scanner is on and ready to scan
one blink of green light	one barcode has been successfully decoded
steady green light	*scanner is in programming mode, *a barcode has been successfully decoded but the object has not been removed from the scan window
flashing red light	scanner entering sleep mode
steady orange light	this indicates motor failure (for motor failure, a periodic beeping sound will also be heard)
flashing orange light	scanner has a laser subsystem failure, return to repair.

## Beeps

Beeps	Status Indications
one beep	a barcode has been successfully decoded
series of 4 beeps	*scanner passed self-test and is operating properly *when scanner is powered up
series of 2 beeps	when scanner is entering programming mode
continual beep	failure indication, return to repair

## Changing Beep Volume

The scanner can be programmed with the Programming Guide to change beeper tone, volume and period. The default beep volume is loud. There are three sound levels: loud, medium, and low.

## Sleep Mode

After the scanner has been inactive for a period of time, the laser automatically turns off; after some more time, the motor turns off and the scanner enters “sleep mode” indicated by the red status LED blinking once a second. To wake up the unit, simply present an object close to the scanner window. The Sleep Mode feature is included to reduce power consumption and to extend scanner life.

Note: The scanner includes a motion sensor that detects activity in front of the scan window. The detecting distance is up to about 100mm from the scan window depending on ambient light.

### Controlling the Scanner from a Host System

The scanner can be controlled from the host system via the RS-232C interface. Control can be accomplished by transmitting the following single-byte commands to the scanner. The default setting for the commands are as follows:

ASCII Code	Function	Byte is Also Called
0E Hex	enable (resumes disable)	Shift Out or <Ctrl-N>
0F Hex	disable	Shift In or <Ctrl-O>
05 Hex	power-up re-initialization	ENQ or <Ctrl-E>
12 Hex	sleep	DC2 <Ctrl-R>
14 Hex	wake up (resumes sleep)	DC4 <Ctrl-T>

Note: When the scanner is disabled, the motor of the scanner will stay on until the scanner goes into sleep mode.

### Maintaining the Scanner

The scanner rarely needs any maintenance, only an occasional cleaning of the scanner window is necessary to remove any dirt or fingerprint. To clean the scanner window, use a soft lint-free cloth and non-abrasive cleaner to avoid scratching the scanner window. The scanner window can be cleaned while the scanner is running.

## Specifications

---

### Operational

Light source	650nm visible laser diode
Depth of Scan Field	0-210mm@ UPC/EAN 100%, PCS 90%
Number of Scan Lines	20
Scan Pattern	5 directions of scan field
Scan Speed	1200 scan per second
Minimum Bar Width	5mil @ PCS 90%
Print Contrast	30% @ UPC/EAN100%
Indicators (LED)	two-color LED (red and green)
Decode Capabilities	UPC/EAN/JAN, UPC Versions A&E, EAN-8, EAN-13, JAN-8, JAN-13, Addendum 2 or 5, ISBN/ISSN, Japanese Bookland, Code 39 (with full ASCII), Codabar (NW7), Code 128/EAN 128, Code93, Interleaved 2 of 5, MSI/Plessey, China Post Code, Code 32 (Italian Pharmaco)
	Optional: Industrial 2 of 5, Standard 2 of 5, Discrete 2 of 5, Matrix 2 of 5, IATA Code, Code-11, RSS-14, RSS-Expanded, RSS-Limited
Beeper Operational	Programmable tone and beep time
System Interfaces	Keyboard, RS-232C, USB1.1, Wand

### Physical

Height	72.0mm
Depth	68.0mm
Width	64.0mm
Weight	175g
Cable	Standard 2m straight



### Power

Input Voltage	5VDC+10%
Power	1.0Watts
Operating Current	200mA@ 5.0V
Laser Class	CDRH Class IIa, IEC 60825-1: Class 1
EMC	CE&FCC DOC compliance

### Environment

Operating Temperature	0°C-40°C
Storage Temperature	-20°C-60°C
Humidity	5%-95% RH (non-condensing)
Light Level	max. 2500LUX (fluorescent)
Shock	Designed to withstand 1m drops

## Dimensions

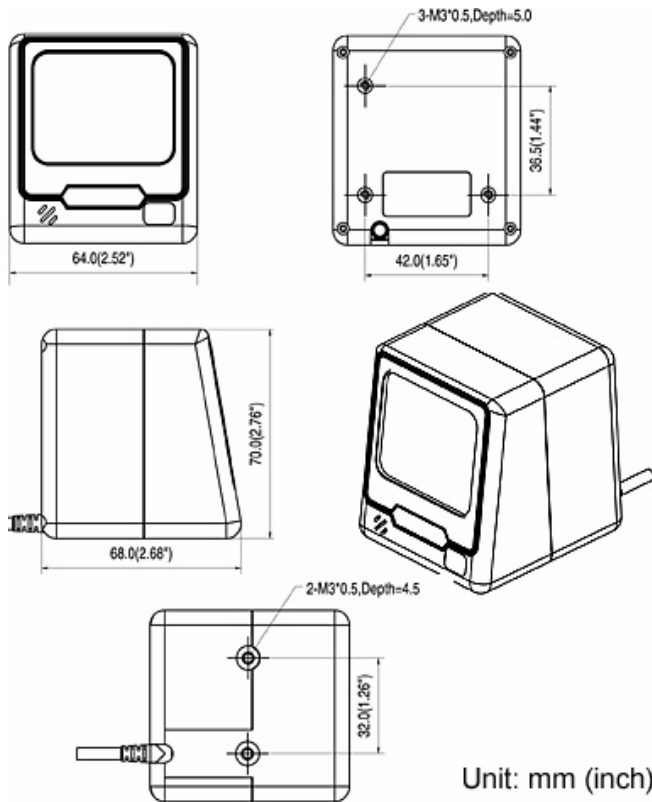

# Scan Field

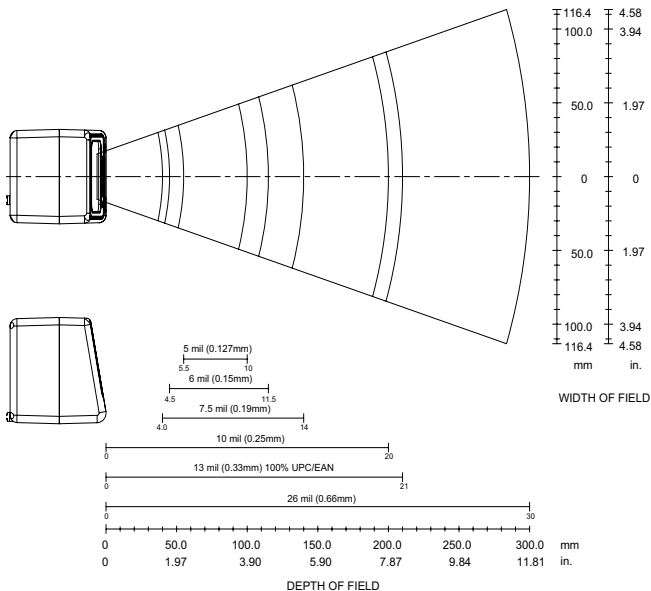

## Troubleshooting

Problem	Diagnostic Tips
The scanner is on but cannot read barcodes. The LED is red.	*The scanner window is dirty and must be cleaned as described in Maintenance section. *The presented barcode type is not enabled and must be programmed with the programming guide *The host disables the scanner. *The barcode type presented is not supported by this module.
The scanner is on but the motor is not rotating. LED is intermittently flashing red.	*The scanner has entered sleep mode. Simply present a barcode to the scanner to activate the scanner.
LED is orange.	*Possible failure of the scanning safeguard circuit. Disconnect the scanner from its power source immediately and contact your dealer.
The scanner does not accept more than 2 or 3 barcode labels.	*There is no proper handshaking with the host system. Switch on the host system and check connection and communication settings.
The scanner flashes alternating red and green LED with no motor nor pattern.	*The scanner detects a power insert failure. Please check if the power is connected properly.

Problem	Diagnostic Tips
LED remains green.	<p>*The scanner is continuously seeing a barcode. Remove all barcode labels out of the scan volume of the scanner and try again.</p> <p>*The scanner cannot send data to the host system. There is no proper handshaking between the scanner and the host. Make sure that all cables are connected and your host system is ready to receive data.</p>
Barcode is read by the scanner but not accepted by the host system.	<p>*The communication cable is not connected to the serial port of your host system. Refer to the manual of your host system to locate the serial port.</p> <p>*The communication setting of the system and scanner do not match. Adjust the setting to fix the problem.</p> <p>*The communication cable does not suit your host system. Contact your dealer for the correct communication cable.</p> <p>*The software running on the host system does not support the data format of the label.</p>

## Notes

## Notes

**Scale 1:1** Unit: mm

Note: 3 Mounting Holes; size- M3\*0.5, Depth=5.0

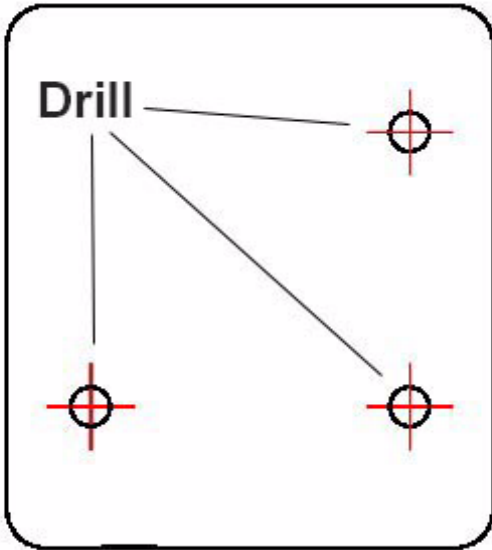

**Figure 1: Mounting Plate Boring Template- Back View**





**Scale 1:1** Unit: mm

Note: 2 Mounting Holes; size- M3\*0.5, Depth=4.5

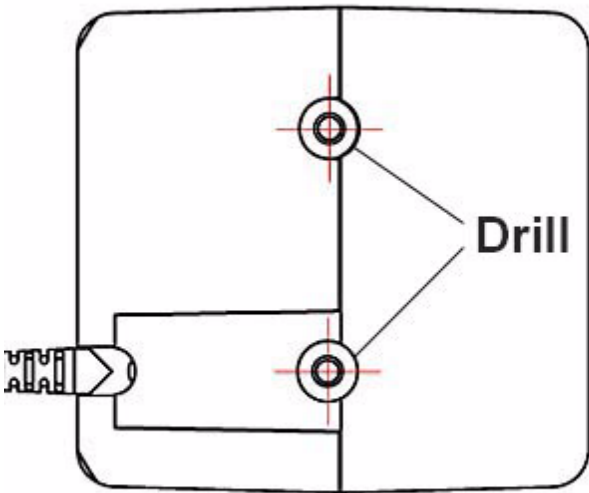

**Figure 2: Mounting Plate Boring Template- Bottom View**

Part no.: MUL-53252-01