

Levana®

MANUAL / MANUEL / MANUAL

Keera™



Digital Baby Video Monitor
Moniteur vidéo bébé numérique
Video Monitor Digital para Bebé



CAUTION: Keep small parts away from children.

ATTENTION: Gardez les petites pièces hors de la portée des enfants.

PRECAUCIÓN: Mantenga las piezas pequeñas fuera del alcance de los niños.

SAFETY WARNINGS



CAUTION: Keep small parts away from children.



Strangulation Hazard: Children can become entangled in cords. Power cords should be kept more than 3 feet away from the crib and baby's reach at all times. Baby monitors and cameras with power cords should never be hung on or near the crib.



This product is not a toy and should be kept out of children's reach.



This product contains small parts. Exercise care when unpacking and assembling the product.



Read and Keep Instructions: All the safety and operating instructions should be read before the video baby monitor is operated.

Water and Moisture: This product is designed for indoor use only. The unit should not be exposed to rain, moisture, dripping or splashing. No objects filled with liquid should be placed on top of, or beside the product, such as a glass or vase. This item should not be used near water.

Non-Use Periods: Always unplug the AC adapters from the wall outlets during long periods of non-use.

Ventilation: This baby monitor should not be used on a bed, sofa, rug or similar surface that may block the ventilation openings, or be placed in an enclosed area, such as a bookcase or drawer that may impede air flow.

Keep Away from Sources of Heat: This unit should not be exposed to direct heat sources such as a candle, fireplace, radiator, heat register, stove or other appliance that emits heat. The unit should not be left in direct sunlight.

Power Source: This unit should only be used with the AC power adapters included in this package (rated 6V 800mA)

Damage Requiring Service: This unit should be serviced by qualified personnel only when:

- a. Objects have fallen or liquid has been spilled into the product
- b. The units have been exposed to rain
- c. The units do not appear to operate normally or exhibits a distinct change in performance
- d. The units have been dropped or the enclosure damaged



This product cannot replace responsible adult supervision.



Use only with provided power supply.



The socket-outlet shall be installed near the equipment and shall be easily accessible.



RISK OF EXPLOSION IF BATTERY IS REPLACED BY AN INCORRECT TYPE!



Dispose of used batteries according to the instructions.



Use only batteries/power supplies listed in the user manual.

FCC STATEMENT

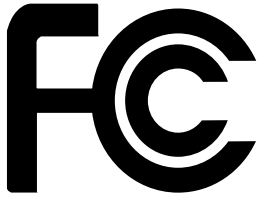

This device complies with part 15 of the FCC Rules. Operation is subject to the following two conditions:

- (1) This device may not cause harmful interference.
- (2) This device must accept any interference received, including interference that may cause undesired operation.

FCC WARNING

This equipment has been tested and found to comply with the limits for a Class B digital device, pursuant to Part 15 of the FCC Rules. These limits are designed to provide reasonable protection against harmful interference in a residential installation.

This equipment generates, uses and can radiate radio frequency energy and, if not installed and used in accordance with the instructions, may cause harmful interference to radio communications. However, there is no guarantee that interference will not occur in a particular installation. If this equipment does cause harmful interference to radio or television reception, which can be determined by turning the equipment off and on, the user is encouraged to try to correct the interference by one or more of the following measures:

- Reorient or relocate the receiving antenna.
- Increase the separation between the equipment and the receiver.
- Connect the equipment into an outlet different from that to which the receiver is connected.
- Consult the dealer or an experienced radio/TV technician for help.

IC STATEMENT / DÉCLARATION IC:

This Class B digital apparatus complies with ICES-003. / Cet appareil numérique de la classe B est conforme à la norme NMB-003 du Canada.

This device complies with Industry Canada licence-exempt RSS 210 standard(s). Operation is subject to the following two conditions: (1) this device may not cause interference, and (2) this device must accept any interference, including interference that may cause undesired operation of the device.

Le présent appareil est conforme aux CNR 210 d'Industrie Canada applicables aux appareils radio exempts de licence. L'exploitation est autorisée aux deux conditions suivantes : (1) l'appareil ne doit pas produire de brouillage, et (2) l'utilisateur de l'appareil doit accepter tout brouillage radioélectrique subi, même si le brouillage est susceptible d'en compromettre le fonctionnement.

Changes or modifications not expressly approved by the party responsible for compliance could void the user's authority to operate the equipment.

We take quality very seriously. This is why all of our products come with a one-year warranty from the original purchase date against defects in workmanship and materials. If you have warranty or support issues please contact us using any of the following methods:

Web: www.mylevana.com

Support: www.mylevana.com/support

LEVANA Canada

4080 Montrose Road
Niagara Falls, ON
Canada L2H 1J9

LEVANA USA

60 Industrial Parkway #Z64
Cheektowaga NY
USA 14227

Warranty Terms

1. LEVANA® products are guaranteed for a period of one year from the date of purchase against defects in workmanship and materials. This warranty is limited to the repair, replacement or refund of the purchase price at LEVANA's option.
2. This warranty becomes void if the product shows evidence of having been misused, mishandled or tampered with contrary to the applicable instruction manual.
3. Routine cleaning, normal cosmetic and mechanical wear and tear are not covered under the terms of this warranty.
4. The warranty expressly provided for herein is the sole warranty provided in connection with the product itself and no other warranty, expressed or implied is provided. LEVANA assumes no responsibilities for any other claims not specifically mentioned in this warranty.
5. This warranty does not cover the shipping cost, insurance or any other incidental charges.
6. You MUST contact LEVANA before sending any product back for repair. You will be sent a Return Authorization form with return instructions. When returning the product for warranty service, please pack it carefully in the original box with all supplied accessories, and enclose your original receipt or copy, and a brief explanation of the problem (include RA #).
7. This warranty is valid only in Canada and the continental U.S.
8. This warranty cannot be re-issued.

TABLE OF CONTENTS

SAFETY WARNINGS.....	2
FCC STATEMENT.....	3
WARRANTY	4
WHAT'S INCLUDED	7
BUTTONS AND CONNECTIONS - MONITOR.....	8
BUTTONS AND CONNECTIONS - CAMERA.....	9
SETUP.....	10
SD Card installation.....	10
Battery installation.....	10
Get the Most Out of Your Rechargeable Battery.....	11
Connecting Power to the Monitor / Charging Battery.....	12
Connecting Power to the Camera	12
Screen Icons	13
OPERATION	14
Turn the Monitor ON / OFF.....	14
Pairing the Cameras & Monitor.....	14
Placement of the Monitor	15
Placement of the Camera	15
Mounting the Camera on a Tabletop Safely.....	15
Mounting the Camera on a Wall Safely.....	16
Night Vision.....	17
Adjusting the Camera Angle - PTZ.....	17
Volume Control.....	18
Using the ZOOM Function	18
Using the Talk to Baby™ Two-Way Intercom.....	19
Selecting a Lullaby.....	19
Using PEEP Mode.....	20
Changing the Camera View.....	20
Setting the Brightness.....	21
Sound Sensitivity Settings	21
Taking a Picture.....	22

TABLE OF CONTENTS

Capturing Video	22
Viewing/Deleting Pictures - Monitor	23
Viewing/Deleting Video - Monitor	24
Viewing Saved Photos & Videos - Computer	25
Settings	25
Checking SD card space.....	26
Format SD card.....	26
Default Factory Settings	27
Contacting Customer Support.....	27
TRUBLESHOOTING.....	28
Maintenance	28
SPECIFICATIONS.....	29

WHAT'S INCLUDED

Keera

Meaning : Dark

- Pan/Tilt/Zoom Night Vision Camera
- Baby Video Monitor
- Rechargeable Battery
- 2 Power Adapters
- SD Card
- Instruction Manual
- 1 Year Warranty
- Lifetime Live Customer Support



This product is not a toy.

This product contains small parts. Exercise care when unpacking and assembling the product.

This product does not replace responsible adult supervision. Check on your child at regular intervals and make sure your monitor is always adequately charged.

LEVANA® does not endorse any LEVANA® products for illegal activities. Levana is not responsible or liable in any way for any damage, vandalism, theft or any other action that may occur while a LEVANA® product is in use by the purchaser.

We reserve the right to change models, configuration, or specifications without notice or liability. Product may not be exactly as shown.

©2012 LEVANA®. All rights reserved. LEVANA®, the LEVANA® logo, Keera™ and other LEVANA® marks may be registered. All other Trademarks are the property of their respective owners.

MONITOR

- 1. LOCK / UNLOCK BUTTON**
Disables ALL function buttons in the LOCK position
- 2. LCD SCREEN**
- 3. POWER & SCREEN ON/OFF**
- 4. POWER INPUT**
- 5. TALK TO BABY™**
Press and hold to talk, release to listen
- 6. PAN & TILT BUTTON**
- 7. MENU**
- 8. MICROPHONE**
- 9. COLOR-CHANGING LED RING**
Changes color with sound intensity/battery charge
- 10. SELECTION / ZOOM BUTTON**
- 11. DIRECTIONAL ARROWS / VOLUME CONTROL**
- 12. ANTENNA**
Extend to improve signal
- 13. TABLE STAND**
- 14. SPEAKER**
- 15. BATTERY COMPARTMENT**

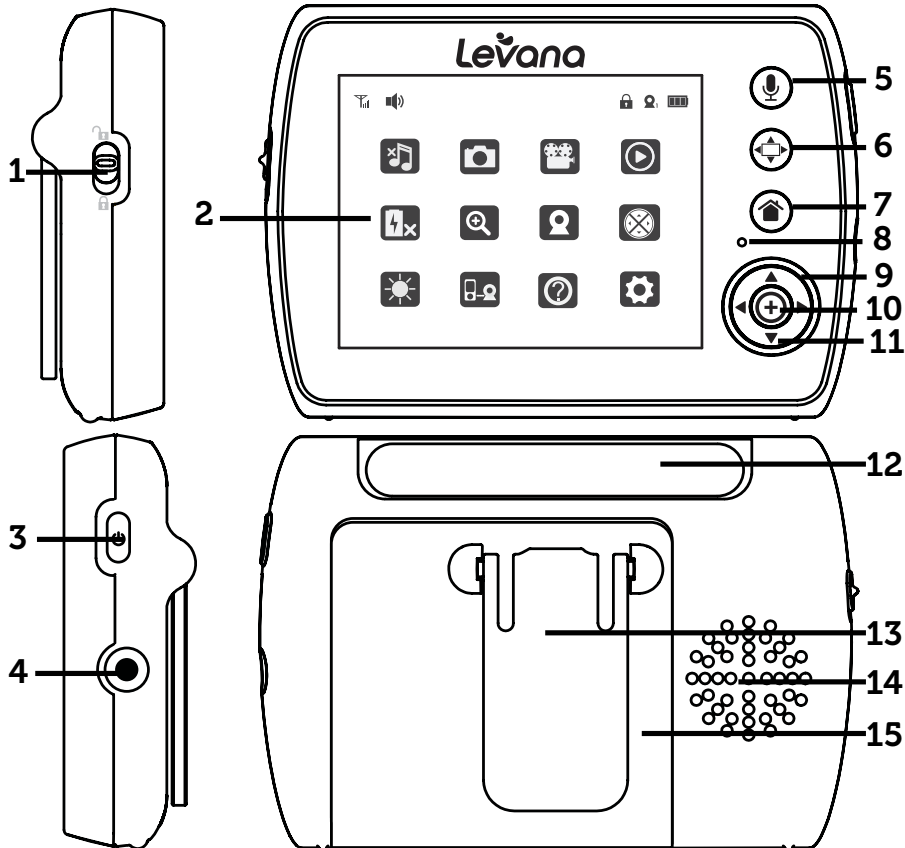

CAMERA

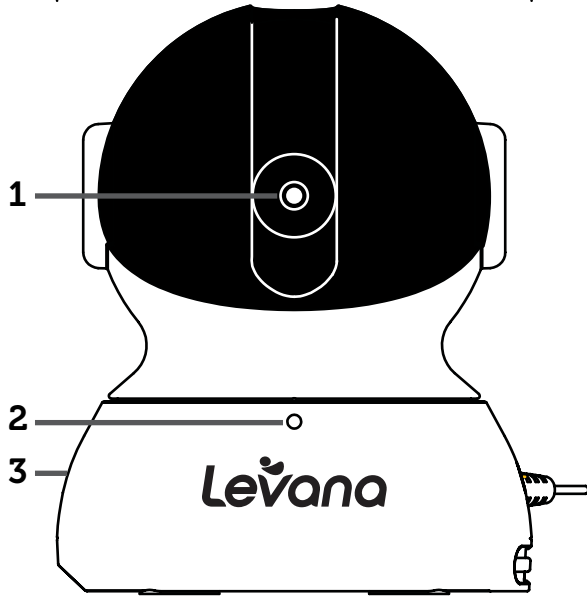

- 1. PTZ CAMERA
- 2. MICROPHONE
- 3. POWER LED
- 4. NIGHT VISION LIGHT SENSOR

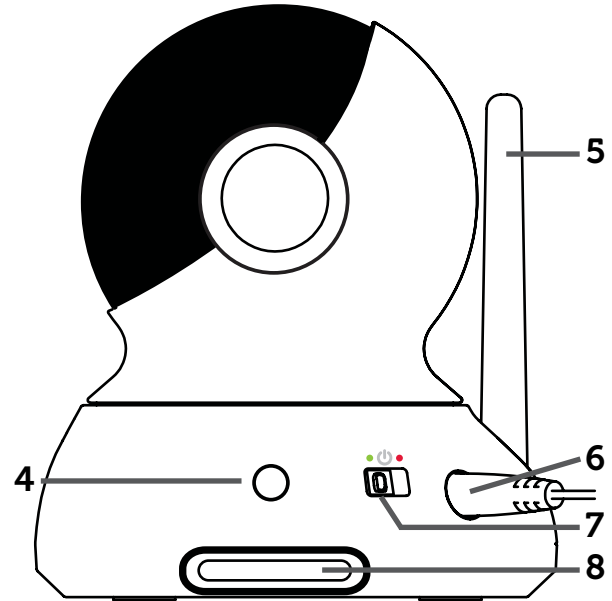

- 5. ANTENNA
- 6. POWER INPUT
- 7. POWER ON/OFF
- 8. SPEAKER

SETUP

LET'S GET STARTED!

SD Card Installation

1. Gently remove the BATTERY COMPARTMENT COVER on the back of the monitor by sliding down.
2. Slide the silver bracket to the right to unlock the MicroSD card holder. Remove the MicroSD card from the SD card adapter and insert the MicroSD card in the bracket as shown - slide the silver bracket to the left to lock the MicroSD card into place.

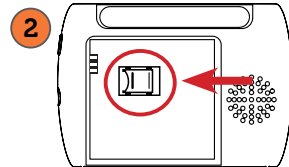
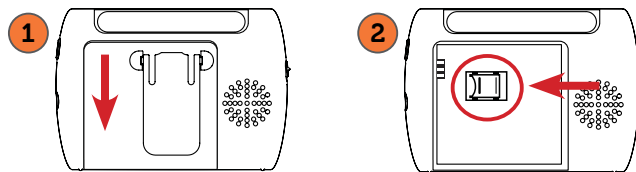

****PLEASE NOTE****
The monitor can support a Micro SD card UP TO 32GB (2GB Micro SD card included).

Battery Installation

1. Gently remove the BATTERY COMPARTMENT COVER on the back of the monitor by sliding down.
2. Insert the battery; the battery connectors on the battery should line up with the connectors inside the battery compartment.
3. Slide the BATTERY COMPARTMENT COVER back into place.
4. For extended periods of non-use, please remove battery from baby monitor.

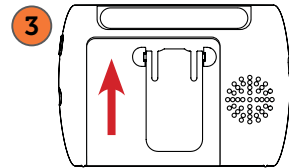
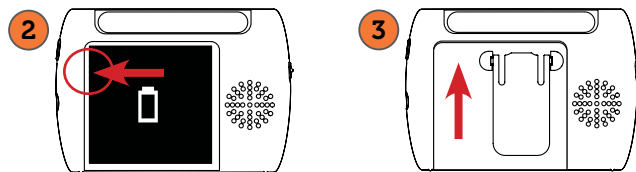
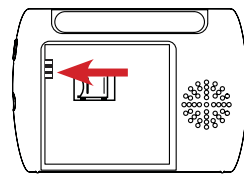
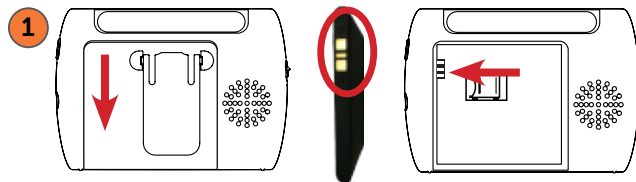

SETUP

Get the Most Out of Your Rechargeable Battery



- Fully charge battery (4 hours) before first use.



- To maximize battery life, charge battery before battery is fully drained.



- Avoid extreme heat or cold as this will affect the life of the battery.



- Turn LCD screen OFF; press POWER  button on the side of the monitor ONCE.





- **PEEP Mode:** After 45 seconds of inactivity, monitor enters standby/sleep mode.



- **Adjustable Brightness:** Decreasing screen brightness will extend battery life.

SETUP

Connecting Power to the Monitor / Charging Battery

1. Connect the small end of power adapter marked MONITOR  into the DC input on the side of the monitor as shown in the diagram. Connect the other end of the adapter into an available wall outlet. For safety reasons, ONLY use the adapters included in the package.
2. **Press and hold** the POWER  button on the side of the monitor to turn the monitor ON.
3. The icon in the top right corner of the main screen will show you the **battery power status**.
4. The **LED Ring** on the front of the monitor also indicates the **battery power status**.

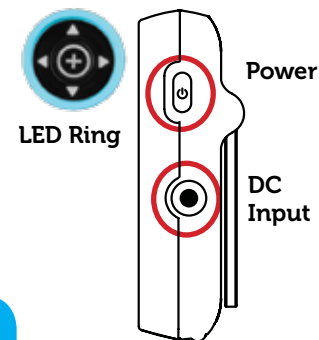

SOLID BLUE = BATTERY FULLY CHARGED **SLOW FLASHING BLUE = BATTERY CHARGING**
QUICK FLASHING BLUE = BATTERY LOW **FLASHING PINK = PAIRING UNSUCCESSFUL**



Connecting Power to the Camera

1. Take the second power adapter and connect the small end of the power adapter marked CAMERA  into the DC input on the side of the camera base as shown in the diagram. For safety reasons, ONLY use the adapters included in the package.

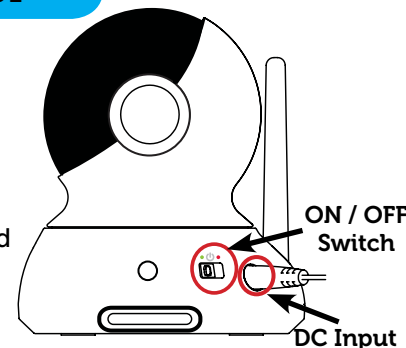

Note: Baby monitors and cameras with power cords should never be hung on or near the crib as it is a strangulation hazard. Power cords should be kept no less than 3 feet away from the crib and the baby's reach at all times.

SCREEN ICONS



LULLABIES



PICTURE



VIDEO



PLAY



PEEP MODE



ZOOM



CAMERA



LED / SOUND SENSITIVITY



BRIGHTNESS



PAIRING





SUPPORT



SETTINGS

OPERATION

Turn the MONITOR ON/OFF

- Press and hold the POWER  button on the side of the monitor to turn the monitor ON.
- Press and hold the POWER  button again to turn OFF the monitor.



Pairing the Camera(s) and Monitor

The camera and monitor come paired (connected) to each other automatically. However, if upon opening this package the devices do not automatically connect and transmit, you may do so manually. To pair additional cameras, repeat steps 1 to 4 and be sure to assign a different camera number to each additional camera.

Note: Before you begin pairing, be sure to have the monitor and the camera(s) side by side.

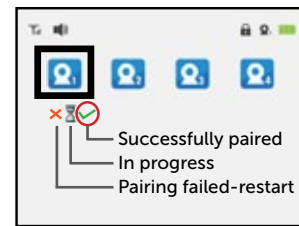
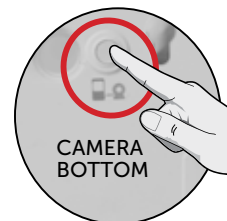
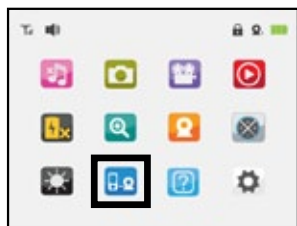
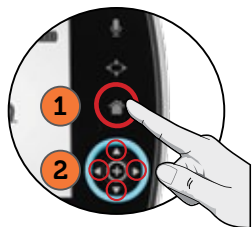

Note: Repeat steps above when pairing additional cameras.

OPERATION

Placement of the Monitor

This monitor can be placed on a tabletop.

- You can place the monitor on a tabletop by using the retractable table stand on the back of the monitor. When not in use, simply tuck the table stand away into the back of the monitor until you hear a "click".



Placement of the Camera

This camera can be placed on a tabletop or hung on the wall above the area being monitored.

- Place the camera within 15 feet of the area being monitored for best picture results.
- Do not place objects within 2 feet of the field of vision of the camera as the night vision will not activate correctly if objects are too close.

Mounting the Camera on a Tabletop Safely:

1. Place the camera on a tabletop no less than 3 feet away from your baby's crib.
2. Feed the power cord down the back of the table or use wall clips (not included) to secure the cord away so the baby cannot reach it.
3. Plug in the power cord, check the monitor to ensure that you are getting a good view of your child and there are no obstructions.

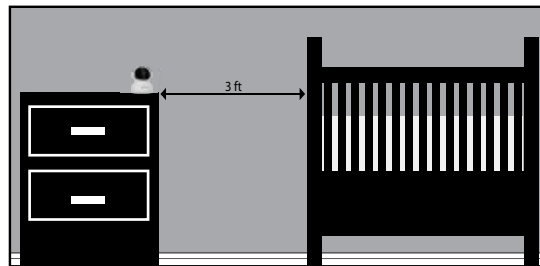

Note: Baby monitors and cameras with power cords should never be hung on or near the crib as it is a strangulation hazard. Power cords should be kept no less than 3 feet away from the crib and the baby's reach at all times.

OPERATION

Mounting the Camera on a Wall Safely:

Before drilling the holes, it is important to check the reception and camera positioning in the intended location on the wall. Ensure you are hanging the camera no less than 3 feet away from baby's crib.

Note: Baby monitors and cameras with power cords should never be hung on or near the crib as it is a strangulation hazard. Power cords should be kept no less than 3 feet away from the crib and the baby's reach at all times.

1. Pre-drill two holes in the wall using a 3/16", 4.8mm drill bit.
2. Insert wall anchors (not included) into each hole and tap gently with a hammer until the anchor is flush with the wall.
3. Insert a screw (not included) into each wall anchor and tighten until the screws only stick out about a 1/2 inch.
4. Plug the power cord into the power input of the camera.
5. Locate the wall mounting holes on the bottom of the camera base.
6. Slide the holes over the screws sticking out of the wall.
7. Confirm that the camera is secure, if it is loose you may have to tighten the screws more.
8. Use wall clips (not included) to secure the power cord away from the crib or the baby's reach.
9. Connect the other end of the adapter into an available wall outlet.

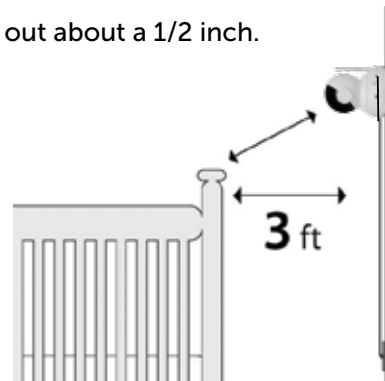

OPERATION

Night Vision

The camera is equipped with NEW Invisible IR (infrared) LEDs which keep the nursery dark. The LEDs are located on the front of the camera and allow you to see up to 12 feet in complete darkness so you can check on your baby at any time of night. The night vision LEDs will activate automatically when the Light Sensor on the side of the camera detects that the light levels are too low.

INVISIBLE
LEDs



Adjusting the Camera Angle - PTZ

The camera is equipped with Pan / Tilt / Zoom (PTZ). You can adjust the angle 300° degrees horizontal and 110° degrees vertical from the center position.

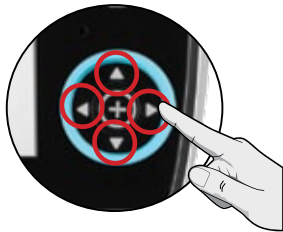
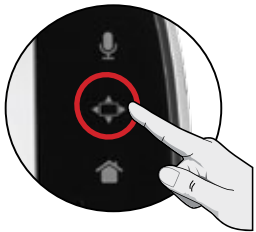

CENTER POSITION

OPERATION

Volume Control



Decrease / Increase

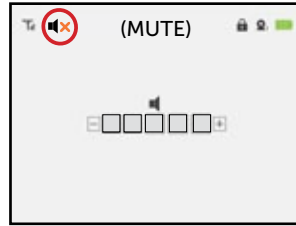
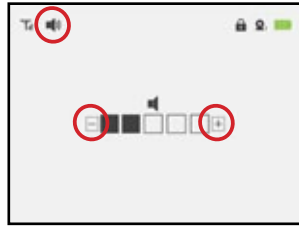

Note: Placing the monitor and camera too close together will create feedback. DECREASE or MUTE the volume and move the camera away from the monitor.

Using the ZOOM Function

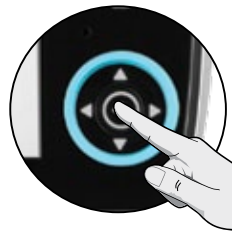
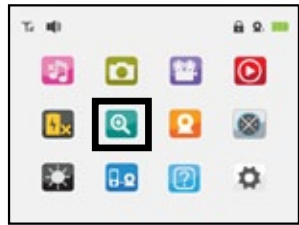
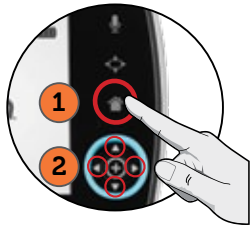

Select

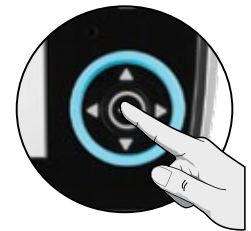



Zoom in/out

OPERATION

Using the Talk to Baby™ Two-Way Intercom

With the simple press of a button you can talk to your child at any time without entering the nursery.

1. To talk, press and hold the  button on the front of the monitor and release to listen.
2. To talk when using multiple cameras, select the camera in the MENU and press the  button, release to listen.

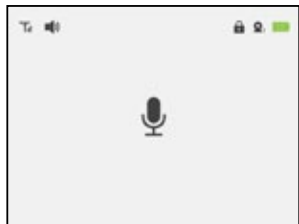
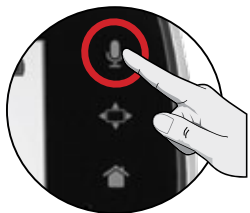

Setting a Lullaby

Choose from three different lullabies to soothe your baby to sleep.

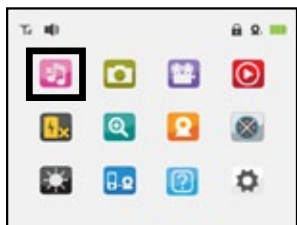
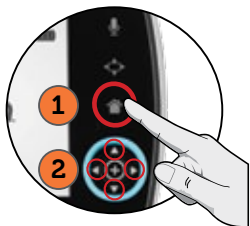

Select

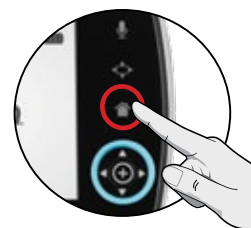

OPERATION

Using PEEP Mode

When in PEEP Mode, the monitor enters standby/sleep mode after 45 seconds of inactivity. When sound is detected, the screen changes to live view. In Quad Screen mode, use the ▲▼ to select the camera that will be triggered by sound.

- To access live view manually when the screen is off, press the POWER  button ONCE.
- PEEP Mode extends the battery life up to 24 hours.

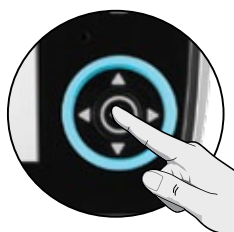
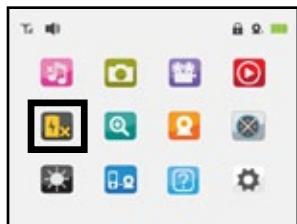
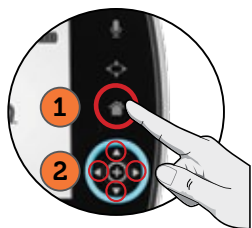

Select

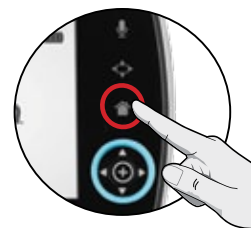
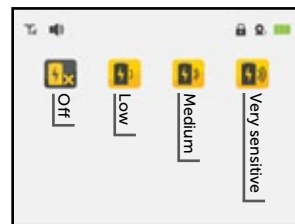

Changing the Camera View

- When in Quad View, volume +/- and PTZ functions default to camera 1.

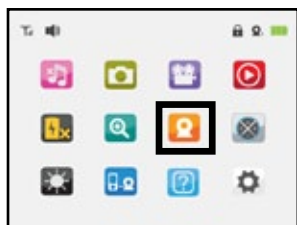
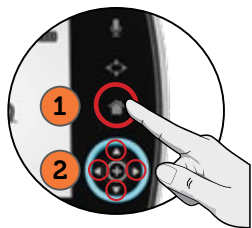

Select

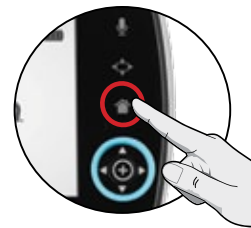
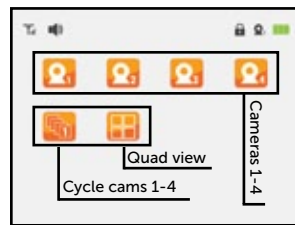

OPERATION

Setting the Brightness

Brightness Mode sets the brightness of the the screen. Brightness Mode also extends the battery life.

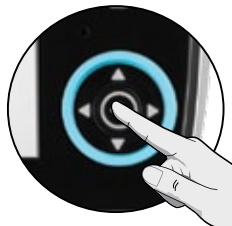
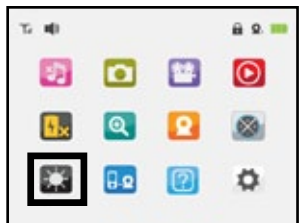
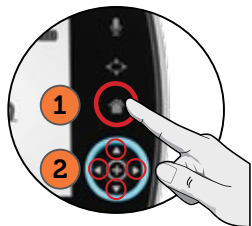

Select

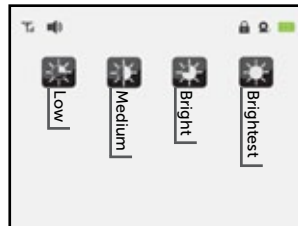

Sound Sensitivity Settings

Sensitivity Mode allows you to adjust the sensitivity of the sound the that the camera picks up. The **LED Ring** on the front of the monitor also indicates how loud the sound in the room is with colors.

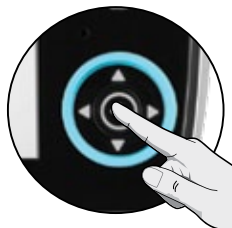
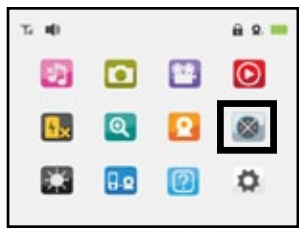
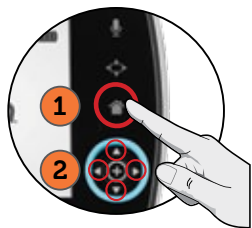

Select

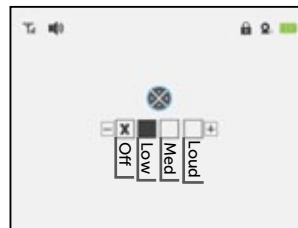

SOUND SENSIVITY COLORS

DISCO / WHISPER / MURMUR



COOING / CHATTER / YELLING



OPERATION

Record Video & Snap Photos Instantly

Capture precious moments as they are happening with your choice of recorded video or still photos on the included 2GB micro SD card. No need to scramble for a camera!

Taking a picture

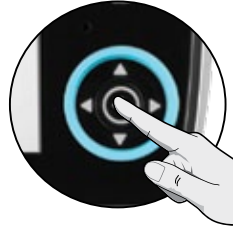
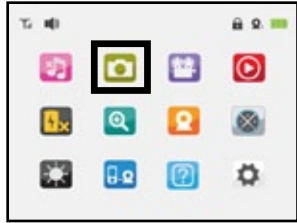
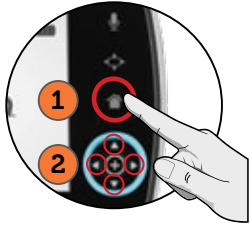

Select icon / Take picture

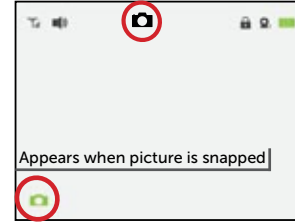

Capturing video

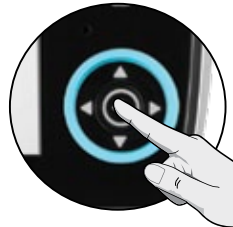
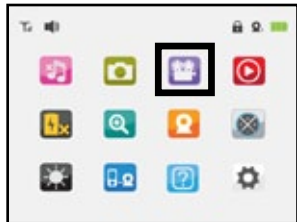
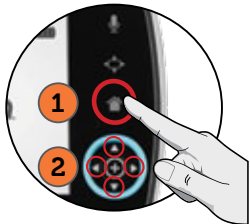

Select Icon / Start & Stop video

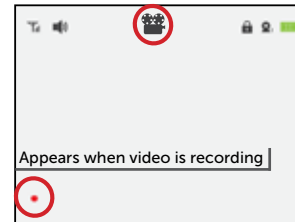

OPERATION

Viewing Saved Photos & Videos - Monitor

You can view your saved photos and videos that are on the included SD card from the monitor or on your computer using the included SD Card Adapter.

Viewing/Deleting pictures - Monitor

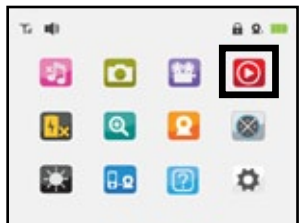
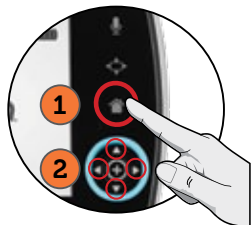

Select

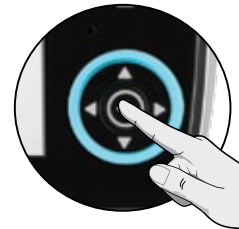
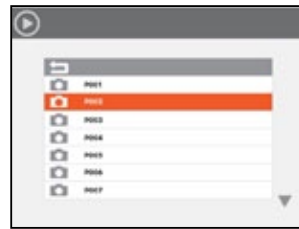

◀ ▶ ▲ ▼ To navigate
/ (+) To Select

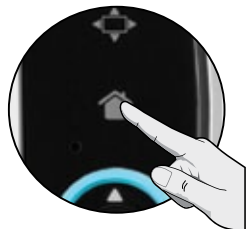
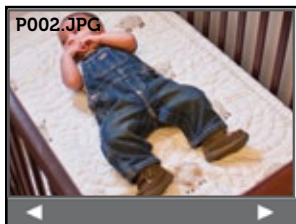

Go back to
previous screen



Press ◀ to delete &
(+) To Select/Delete;
press ▲ to Deselect

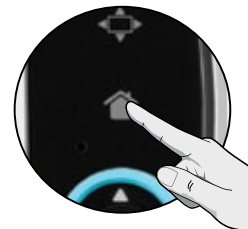

Go back to
previous screen

OPERATION

Viewing/Deleting video - Monitor

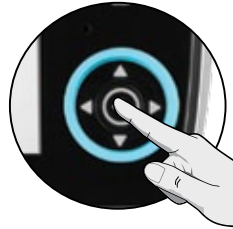
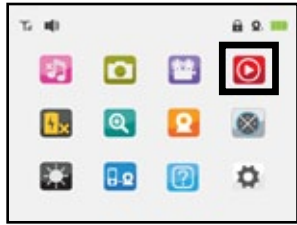
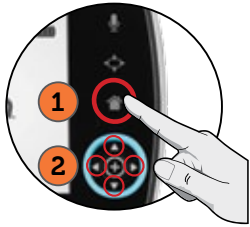

Select

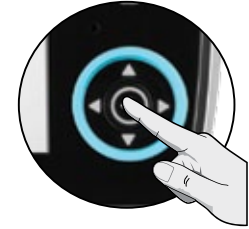
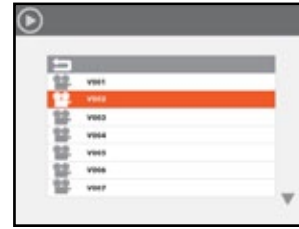

◀ ▶ ▲ ▼ To navigate
/ (+) To Select

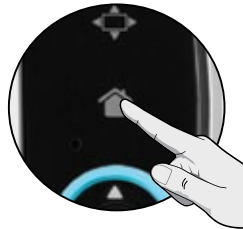

Go back to
previous screen

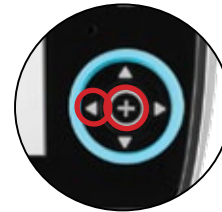

Press ◀ to delete &
(+) To Select/Delete;
press ▲ to Deselect

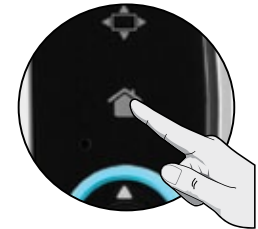

Go back to
previous screen

OPERATION

Viewing Saved Photos & Videos - Computer

You can view your saved photos and videos that are on the included SD card from your computer using the included SD Card Adapter.

**If you do not have an SD card slot on your computer, an SD Card Reader (not included) will be required.

1. Turn the monitor off and remove the battery cover on the back of the monitor. Remove the battery to expose the Micro SD card.
2. Slide the silver bracket to the right, releasing the bracket and remove the Micro SD card.
3. Place the Micro SD card in the SD Card Adapter provided and insert the SD Card Adapter in your computer or SD Card Reader.

Settings

Allows you to view remaining space on your SD Card, format the SD card and also allow you to restore your monitor to factory default settings.

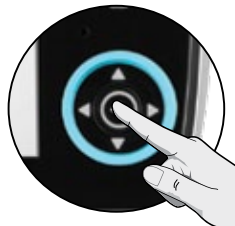
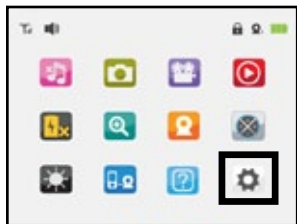
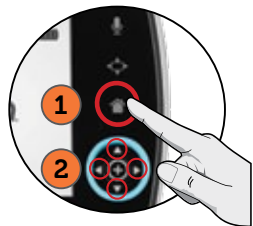

Select

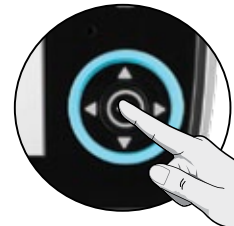
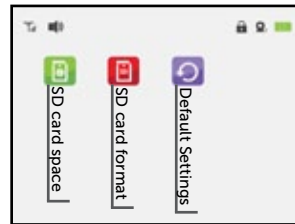

◀▶ To navigate
/ (+) To Select

OPERATION

Checking SD card space

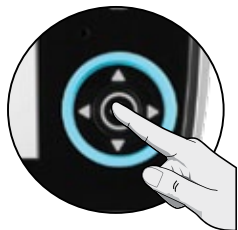

Select

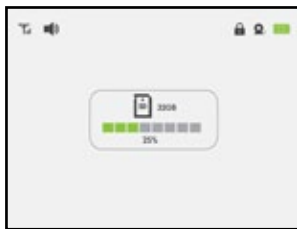

Go back to previous screen

Format SD card



Select

Cancels / Exits function



LAST CHANCE to Cancel / Exit function

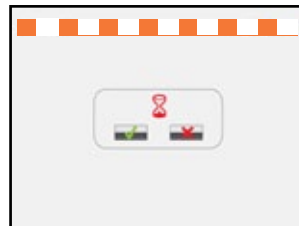

Go back to previous screen

NOTE: ONCE YOU HAVE FORMATTED YOUR SD CARD, ALL OF YOUR SAVED PICTURES/ VIDEO WILL BE ERASED.

OPERATION

Default Factory Settings

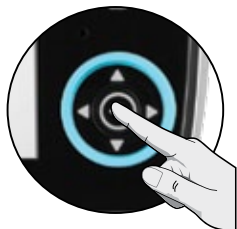

Select

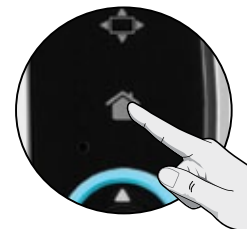
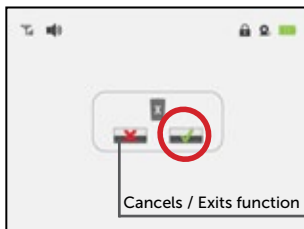

Go back to previous screen

Contacting Customer Support

Customer Support is just a click away whenever you need it! Our customer support team can be reached by live web chat or on our website at www.mylevana.com/support. Our experts will be happy to assist you in English, French and Spanish.

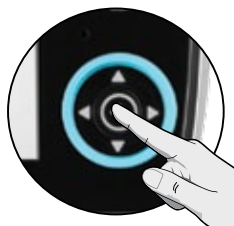
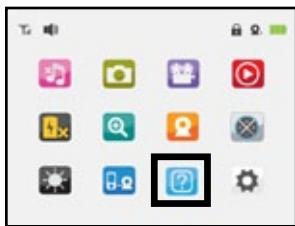
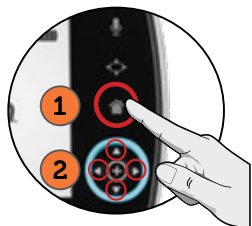

Select



Go back to previous screen

TROUBLESHOOTING

ISSUE	POSSIBLE SOLUTION
Equipment does not function	<ul style="list-style-type: none">• Confirm that the camera and monitor are ON• The battery may be depleted; charge battery• The power adapters may not be properly connected
No reception	<ul style="list-style-type: none">• Camera and monitor may not be properly paired; follow PAIRING instructions• Camera may be too far away from the monitor• Extend the antenna on the monitor
Reception Interference (static)	<ul style="list-style-type: none">• The camera and monitor may be too far apart• The battery power may be too low• Other electronic devices may be interfering with the signal• The camera or monitor may be placed too close to many metal objects
Feedback (screeching, static)	<ul style="list-style-type: none">• The camera and monitor may be too close together• The volume on the monitor may be set too high
Noise (static, beeping)	<ul style="list-style-type: none">• Battery power may be too low
The buttons are not working	<ul style="list-style-type: none">• LOCK/UNLOCK Button is in LOCKED position; move to UNLOCK position
Picture works but there is no sound	<ul style="list-style-type: none">• Volume setting may be too low
Picture is black and white	<ul style="list-style-type: none">• Night vision LEDs may be ON; increase the amount of light in the room being monitored
The rechargeable battery will not charge	<ul style="list-style-type: none">• The power adapters may not be connected• Battery pack may not be properly connected inside the battery compartment

Maintenance

- Clean the surfaces of the camera and monitor with a soft, lint-free cloth
- If the units become dirty, use a lightly dampened cloth to wipe surfaces, taking care to not allow water into any openings
- Never use cleaning agents or solvents

SPECIFICATIONS

MONITOR		MONITOR	
Monitor Type	TFT LCD	Microphone	Yes
Screen Size	3.5"	Talk to Baby	Yes
Resolution	320x240	Lullabies	Yes
Frame Rate	25 FPS	Battery Type	Li-Ion
LCD Brightness	Adjustable: 0,1,2,3,4	Battery Capacity	1700 mAh
Frequency	2.4GHz	Battery Connection	Charging Contact
Private Signal	Yes	Battery Life (video + audio on)	6 hours
Technology	Digital FHSS	Battery Life (LCD off)	7.5 hours
No. of hop/sec	300	Battery Life (PEEP Mode)	Up to 24 hours
No. of hopping channels	19	Battery Low - Visual Warning	Yes
Channel bandwidth	3.375 MHz	Battery Low - Audible Warning	Yes
Data Rate	3 Mbps	PEEP Mode (Power Save):	Yes
Transmission Power	+19 dBm	Volume Indicator LED	Yes
Max Transmission Range	750ft	Key Lock	Yes
Optimum Transmission Range	200ft	Touch Panel Keys	Yes
Expandable	Up to 4 Cameras	Housing Material	ABS Plastic, Chrome Plating
Micro SD Recording / Capacity	Yes, up to 32GB	Power Adapter Input	100~240VAC
Record Photo / Video	Yes	Power Adapter	6V 800mA DC
Zoom	2x	Limited charge voltage	4.2V
Quad Screen	Yes	Operating Temperature	0 to 50 Degrees Celsius
Scan View	Yes, 8 seconds/camera	Dimensions	4 ½" x 1" x 3 ¼"
Speaker	Yes	Weight	0.35 lbs

SPECIFICATIONS

CAMERA		CAMERA	
Image sensor	CMOS	Housing Material	ABS Plastic
Resolution	640 x 480	Wall Mountable	Yes
Viewing Angle	50 Degree	Power Adapter Input	100~240VAC, 50/60Hz 150mA
Focal Length	2.8mm	Power Adapter	6V 800mA DC
Optimal Focal Distance	2-10ft	Operating Temperature	0 to 50 Degree Celsius
PTZ	Yes	Dimensions	3 1/2 "x 4" x 4 1/2"
Range of Motion - Horizontal	300	Weight	0.55 lbs
Range of Motion - Vertical	110		
Frequency	2.4GHz	FCC	
Private Signal	Yes	FCC ID: SMH-30018BU	
Technology	Digital FHSS	FCC ID: SMH-30018PU	
Max Transmission Range	750ft		
Optimum Transmission Range	200ft	IC	
Number of IR LEDs	8	IC: 4593A-30018BU	
IR Wavelength	940nm	IC: 4593A-30018PU	
Night Vision Distance	12ft		
Battery Operable	No		
Microphone	Yes		
Speaker	Yes		

POWER

Adapter: BLJ5W059100P—U ; Input: 100– 240VAC 50/60Hz 150mA; Output: **6V 800mA**;

WARNING

1. Use only with provided power supply;
2. The socket-outlet shall be installed near the equipment and shall be easily accessible;

Battery: Model: 464854P, Li-ion battery, 3.7V 1700mAh 6.290Wh, Limited charge voltage: 4.2V.

OR

Battery: Model: 495255AR; Li-ion battery, 3.7V 1700mAh 6.290Wh, Limited charge voltage: 4.2V.

OR

Battery: Model: 495255; Li-ion battery, 3.7V 1700mAh 6.290Wh, Limited charge voltage: 4.2V.

WARNING

Dispose of used batteries according to the instructions ;

Use Only Batteries/Power Supplies Listed in the user Instructions.

Risk of explosion if battery is replaced by an incorrect type;