

# Comfort Glow<sup>®</sup>

## BLUE FLAME VENT-FREE NATURAL GAS HEATER

### OWNER'S OPERATION AND INSTALLATION MANUAL

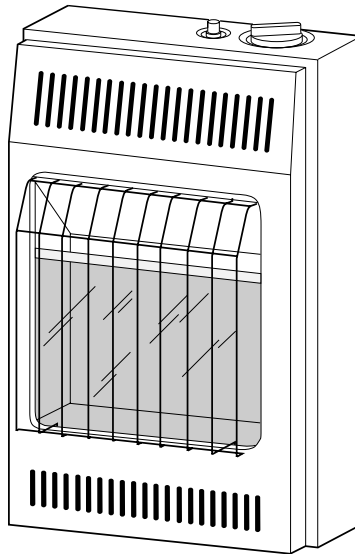

MODELS: CGN10A AND CGN6

**WARNING:** If the information in this manual is not followed exactly, a fire or explosion may result causing property damage, personal injury, or loss of life.

— Do not store or use gasoline or other flammable vapors and liquids in the vicinity of this or any other appliance.

— **WHAT TO DO IF YOU SMELL GAS**

- Do not try to light any appliance.
- Do not touch any electrical switch; do not use any phone in your building.
- Immediately call your gas supplier from a neighbor's phone. Follow the gas supplier's instructions.
- If you cannot reach your gas supplier, call the fire department.

— Installation and service must be performed by a qualified installer, service agency, or the gas supplier.

**WARNING:** This is an unvented gas-fired heater. It uses air (oxygen) from the room in which it is installed. Provisions for adequate combustion must be provided. Refer to page 3 of this manual.

This appliance may be installed in an aftermarket\* manufactured (mobile) home, where not prohibited by state or local codes.

\* Aftermarket: Completion of sale, not for purpose of resale, from the manufacturer

This appliance is only for use with the type of gas indicated on the rating plate. This appliance is not convertible for use with other gases.

**Save this manual for future reference.**

NATURAL GAS HEATER

SAFETY INFORMATION

**⚠ WARNINGS**

**IMPORTANT: Read this owner's manual carefully and completely before trying to assemble, operate, or service this heater. Improper use of this heater can cause serious injury or death from burns, fire, explosion, and carbon monoxide poisoning.**

**⚠ DANGER: Carbon monoxide poisoning may lead to death!**

**Carbon Monoxide Poisoning:** Early signs of carbon monoxide poisoning resemble the flu, with headaches, dizziness, or nausea. If you have these signs, the heater may not be working properly. **Get fresh air at once!** Have heater serviced. Some people are more affected by carbon monoxide than others. These include pregnant women, people with heart or lung disease or anemia, those under the influence of alcohol, and those at high altitudes.

**Natural Gas:** Natural gas is odorless. An odor-making agent is added to natural gas. The odor helps you detect a natural gas leak. However, the odor added to natural gas can fade. Natural gas may be present even though no odor exists.

Make certain you read and understand all warnings. Keep this manual for reference. It is your guide to safe and proper operation of this heater.

**⚠ WARNING: Any change to this heater or its controls can be dangerous.**

1. This appliance is only for use with the type of gas indicated on the rating plate. This appliance is not convertible for use with other gases.
2. If you smell gas
  - shut off gas supply
  - do not try to light any appliance
  - do not touch any electrical switch; do not use any phone in your building
  - immediately call your gas supplier from a neighbor's phone. Follow the gas supplier's instructions
  - if you cannot reach your gas supplier, call the fire department
3. Heater model CGN10A shall not be installed in a bathroom.
4. Never install the heater
  - in a recreational vehicle
  - where curtains, furniture, clothing, or other flammable objects are less than 36 inches from the front, top, or sides of the heater
  - as a fireplace insert
  - in high traffic areas
  - in windy or drafty areas
5. This heater needs fresh, outside air ventilation to run properly. This heater has an oxygen depletion sensor (ODS) pilot light safety system. The ODS shuts down the heater if not enough fresh air is available. See *Fresh Air for Combustion and Ventilation*, pages 3 through 5.
6. Keep all air openings in front and bottom of heater clear and free of debris. This will insure enough air for proper combustion.
7. If heater shuts off, do not relight until you provide fresh, outside air. If heater keeps shutting off, have it serviced.
8. Do not run heater
  - where flammable liquids or vapors are used or stored
  - under dusty conditions
9. Never place any objects on the heater.
10. Surface of heater becomes very hot when running heater. Keep children and adults away from hot surface to avoid burns or clothing ignition. Heater will remain hot for a time after shut-down. Allow surface to cool before touching.
11. Carefully supervise young children when they are in same room with heater.
12. Make sure grill guard is in place before running heater.
13. Do not use heater if any part has been under water. Immediately call a qualified service technician to inspect the room heater and to replace any part of the control system and any gas control which has been under water.
14. Turn off heater and let cool before servicing. Only a qualified service person should service and repair heater.
15. Operating heater above elevations of 4,500 feet could cause pilot outage.

# OWNER'S MANUAL

## PRODUCT IDENTIFICATION

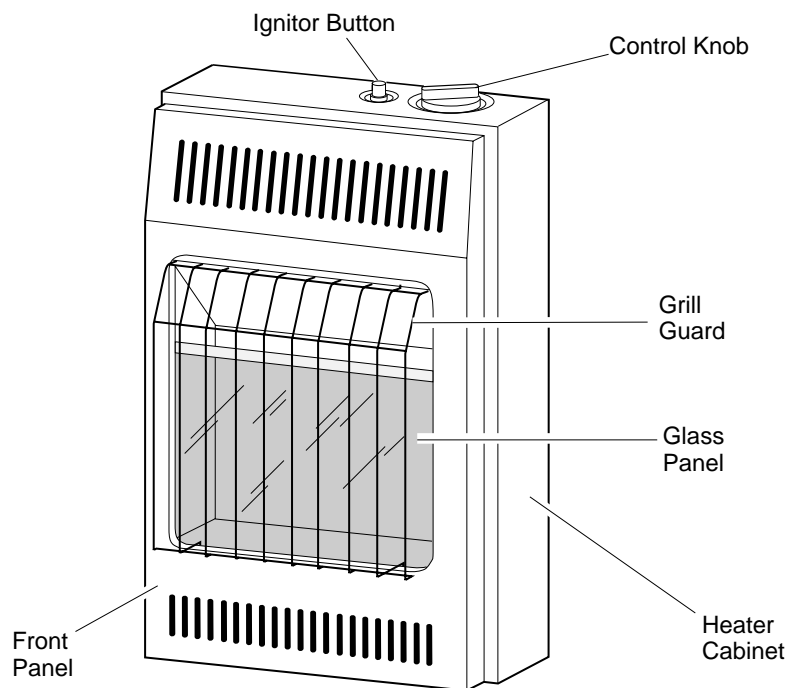

Figure 1 - Vent-Free Natural Gas Heater (Model CGN10A Shown)

## LOCAL CODES

Install and use heater with care. Follow all local codes. In the absence of local codes, use the latest edition of The National Fuel Gas Code ANSI Z223.1, also known as NFPA 54\*.

\*Available from:

American National Standards Institute,  
Inc.  
1430 Broadway  
New York, NY 10018

National Fire Protection Association, Inc.  
Batterymarch Park  
Quincy, MA 02269

## UNPACKING

1. Remove heater from carton.
2. Remove all protective packaging applied to heater for shipment.
3. Check heater for any shipping damage. If heater is damaged, promptly inform dealer where you bought heater.

## FRESH AIR FOR COMBUSTION AND VENTILATION

**⚠ WARNING:** This heater shall not be installed in a confined space unless provisions are provided for adequate combustion and ventilation air. Read the following instructions to insure proper fresh air for this and other fuel-burning appliances in your home.

Today's homes are built more energy efficient than ever. New materials, increased insulation, and new construction methods help reduce heat loss in homes. Home owners weather strip and caulk around windows and doors to keep the cold air out and the warm air in. During heating months, home owners want their homes as airtight as possible.

While it is good to make your home energy efficient, your home needs to breathe. Fresh air must enter your home. All fuel-burning appliances need fresh air for proper combustion and ventilation.

Exhaust fans, fireplaces, clothes dryers, and fuel burning appliances draw air from the house to operate. You must provide adequate fresh air for these appliances. This will insure proper venting of vented fuel-burning appliances.

## PROVIDING ADEQUATE VENTILATION

The following is excerpts from *National Fuel Gas Code, NFPA 54/ANSI Z223.1, Section 5.3, Air for Combustion and Ventilation.*

All spaces in homes fall into one of the three following ventilation classifications:

1. Unusually Tight Construction; 2. Unconfined Space; 3. Confined Space.

The information on pages 4 and 5 will help you classify your space and provide adequate ventilation.

*Continued*

NATURAL GAS HEATER

FRESH AIR FOR COMBUSTION AND VENTILATION

*Continued*

**Unusually Tight Construction**

The air that leaks around doors and windows may provide enough fresh air for combustion and ventilation. However, in buildings of unusually tight construction, you must provide additional fresh air.

**Unusually tight construction is defined as construction where:**

- a. walls and ceilings exposed to the outside atmosphere have a continuous water vapor retarder with a rating of one perm ( $6 \times 10^{-11}$  kg per pa-sec- $m^2$ ) or less with openings gasketed or sealed *and*
- b. weather stripping has been added on openable windows and doors *and*
- c. caulking or sealants are applied to areas such as joints around window and door frames, between sole plates and floors, between wall-ceiling joints, between wall panels, at penetrations for plumbing, electrical, and gas lines, and at other openings.

If your home meets all of the three criteria above, you must provide additional fresh air. See *Ventilation Air From Outdoors*, page 5.

If your home does not meet all of the three criteria above, proceed to *Determining Fresh-Air Flow For Heater Location*.

**Confined and Unconfined Space**

The National Fuel Gas Code (ANSIZ2123.1, 1992 Section 5.3) defines a confined space as a space whose volume is less than 50 cubic feet per 1,000 Btu per hour (4.8 m<sup>3</sup> per kw) of the aggregate input rating of all appliances installed in that space and an unconfined space as a space whose volume is not less than 50 cubic feet per 1,000 Btu per hour (4.8 m<sup>3</sup> per kw) of the aggregate input rating of all appliances installed in that space. Rooms communicating directly with the space in which the appliances are in-

stalled\*, through openings not furnished with doors, are considered a part of the unconfined space.

\* Adjoining rooms are communicating only if there are doorless passageways or ventilation grills between them.

**DETERMINING FRESH-AIR FLOW FOR HEATER LOCATION**

**Determining if You Have a Confined or Unconfined Space**

Use this worksheet to determine if you have a confined or unconfined space.

**Space:** Includes the room in which you will install heater plus any adjoining rooms with doorless passageways or ventilation grills between the rooms.

1. Determine the volume of the space (length x width x height).

Length x Width x Height = \_\_\_\_\_ cu. ft. (volume of space)

*Example:* Space size  
20 ft. (length) x 16 ft. (width) x 8 ft. (ceiling height) =  
2560 cu. ft. (volume of space)

If additional ventilation to adjoining room is supplied with grills or openings, add the volume of these rooms to the total volume of the space.

2. Divide the space volume by 50 cubic feet to determine the maximum Btu/Hr the space can support.

\_\_\_\_\_ (volume of space) ÷ 50 cu. ft. = (Maximum Btu/Hr the space can support)

*Example:* 2560 cu. ft. (volume of space) ÷ 50 cu. ft. = 51.2 or 51,200 (maximum Btu/Hr the space can support)

3. Add the Btu/Hr of all fuel burning appliances in the space.

Vent-free heater _____	Btu/Hr
Gas water heater* _____	Btu/Hr
Gas furnace _____	Btu/Hr
Vented gas heater _____	Btu/Hr
Gas fireplace logs _____	Btu/Hr
Other gas appliances* + _____	Btu/Hr
Total = _____	Btu/Hr

*Example:* Gas water heater

	44,000 Btu/Hr
Vent-free heater +	6,000 Btu/Hr
Total	= 50,000 Btu/Hr

\* Do not include direct-vent gas appliances. Direct-vent draws combustion air from the outdoors and vents to the outdoors.

4. Compare the maximum Btu/Hr the space can support with the actual amount of Btu/Hr used.

\_\_\_\_\_ Btu/Hr (maximum the space can support)

\_\_\_\_\_ Btu/Hr (actual amount of Btu/Hr used)

*Example:* 46,100 Btu/Hr (maximum the space can support)  
50,000 Btu/Hr (actual amount of Btu/Hr used)

The space in the above example is a confined space because the actual Btu/Hr used is more than the maximum Btu/Hr the space can support. You must provide additional fresh air. Your options are as follows:

- A. Rework worksheet, adding the space of an adjoining room. If the extra space provides an unconfined space, remove door to adjoining room or add ventilation grills between rooms. See *Ventilation Air From Inside Building*, page 5.
- B. Vent room directly to the outdoors. See *Ventilation Air From Outdoors*, page 5.
- C. Install a lower Btu/Hr heater, if lower Btu/Hr size makes room unconfined.

If the actual Btu/Hr used is less than the maximum Btu/Hr the space can support, the space is an unconfined space. You will need no additional fresh air ventilation.

**⚠ WARNING:** If the area in which the heater may be operated is smaller than that defined as an unconfined space, provide adequate combustion and ventilation air by one of the methods described in the *National Fuel Gas Code, ANSI Z223.1, 1992, Section 5.3 or applicable local codes.*

## FRESH AIR FOR COMBUSTION AND VENTILATION

*Continued*

### VENTILATION AIR

#### Ventilation Air From Inside Building

This fresh air would come from an adjoining unconfined space. When ventilating to an adjoining unconfined space, you must provide two permanent openings: one within 12" of the ceiling and one within 12" of the floor on the wall connecting the two spaces (see options 1 and 2, Figure 2). You can also remove door into adjoining room (see option 3, Figure 2). Follow the *National Fuel Gas Code NFPA 54/ANSI Z223.1, Section 5.3, Air for Combustion and Ventilation* for required size of ventilation grills or ducts.

**⚠ WARNING: Rework worksheet, adding the space of the adjoining unconfined space. The combined spaces must have enough fresh air to supply all appliances in both spaces.**

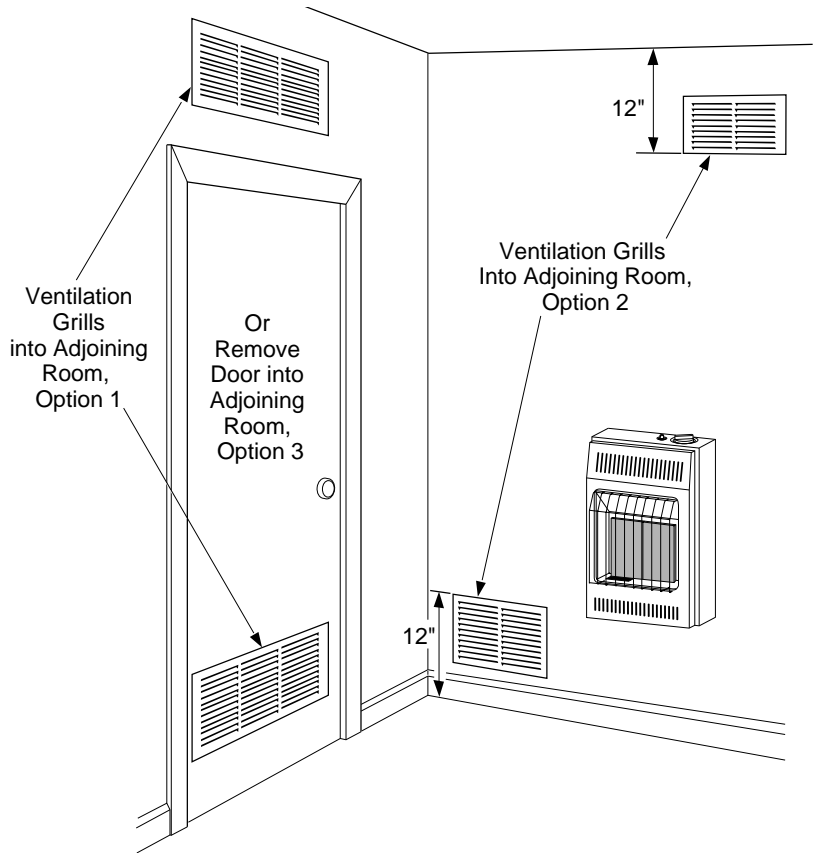
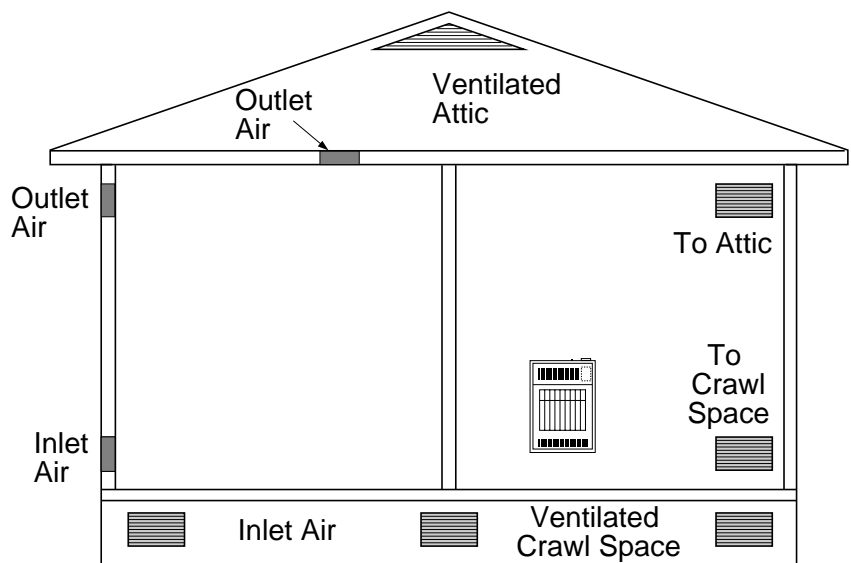

**Figure 2 - Ventilation Air from Inside Building**

#### Ventilation Air From Outdoors

Provide extra fresh air by using ventilation grills or ducts. You must provide two permanent openings: one within 12" of the ceiling and one within 12" of the floor. Connect these items directly to the outdoors or spaces open to the outdoors. These spaces include attics and crawl spaces.

**IMPORTANT:** Do not provide openings for inlet or outlet air into attic if attic has a thermostat-controlled power vent. Heated air entering the attic will activate the power vent.



**Figure 3 - Ventilation Air from Outdoors**

# Comfort Glow® CGN10A AND CGN6 NATURAL GAS HEATER

## INSTALLING TO WALL

**NOTICE: A qualified service person must install heater. Follow all local codes.**

### CHECK GAS TYPE

Use only natural gas. If your gas supply is not natural, do not install heater. Call dealer where you bought heater for proper type heater.

### INSTALLATION ITEMS

Before installing heater, make sure you have the items listed below:

- piping (check local codes)
- sealant (resistant to propane/LP gas)
- manual shutoff valve \*
- ground joint union
- test gauge connection \* (see Figure 12, page 8)
- sediment trap
- tee joint
- pipe wrench

\* An A.G.A. design-certified manual shutoff valve with 1/8" NPT tap is an acceptable alternative to test gauge connection. Purchase the optional A.G.A. design-certified manual shutoff valve from your dealer. See *Accessory*, page 15.

### LOCATING HEATER

This heater is designed to be mounted on a wall.

**WARNING: Maintain the minimum clearances shown in Figure 4. If you can, provide greater clearances from floor, ceiling, and joining wall.**

**WARNING: Never install the heater**

- in a bathroom (Model CGN10A - Input 10,000 Btu's)
- in a recreational vehicle
- where curtains, furniture, clothing, or other flammable objects are less than 36 inches from the front, top, or sides of the heater
- as a fireplace insert
- in high traffic areas
- in windy or drafty areas

**CAUTION: This heater creates warm air currents. These currents move heat to wall surfaces next to heater. Installing heater next to vinyl or cloth wall coverings or operating heater where impurities in the air (such as tobacco smoke) exist, may discolor walls.**

**IMPORTANT:** Vent-free heaters add moisture to the air. Although this is beneficial, installing heater in rooms without enough ventilation air may cause mildew to form from too much moisture. See *Fresh Air for Combustion and Ventilation*, pages 3 through 5.

**CAUTION: If you install the heater in a home garage**

- heater pilot and burner must be at least 18 inches above floor
- locate heater where moving vehicle will not hit it

For convenience and efficiency, install heater

- where there is easy access for operation, inspection, and service
- in coldest part of room

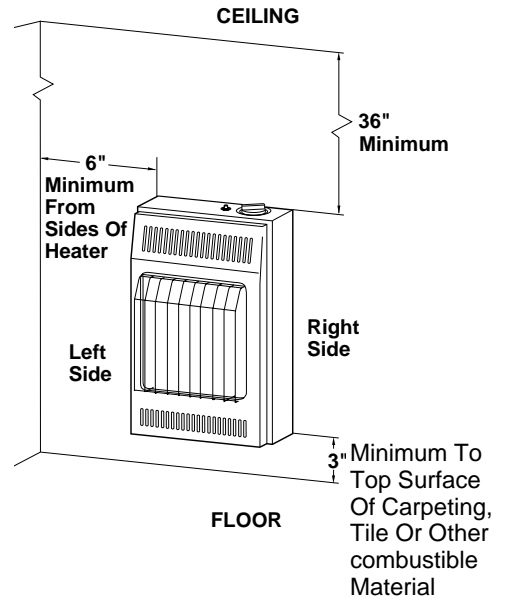

Figure 4 - Mounting Clearances As Viewed From Front of Heater

## INSTALLING HEATER TO WALL

### Marking Screw Locations

1. Determine where you will locate heater.

**WARNING: Maintain minimum clearances shown in Figure 5. If you can, provide greater clearances from floor and joining wall.**

2. Mark two mounting screw locations on wall (see Figure 5).

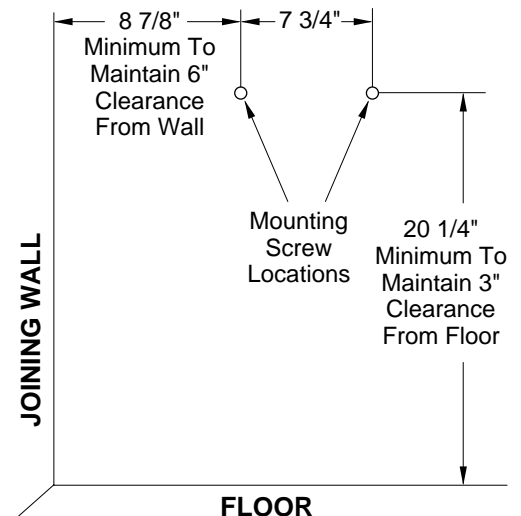

Figure 5 - Mounting Screw Locations

Continued

## INSTALLING TO WALL

### Continued

#### Installing Two Mounting Screws

*Note:* Wall anchors and mounting screws are in hardware package. The hardware package is provided with heater.

#### Attaching to wall stud method

For attaching mounting screw to wall stud

1. Drill hole at marked location using 9/64" drill bit.
2. Insert mounting screw into wall stud.
3. Tighten screw until 1/16" space (thickness of penny) is between screwhead and wall.

#### Attaching to wall anchor method

Follow instructions below to attach mounting screws to hollow walls (wall areas between studs) or solid walls (concrete or masonry).

1. Drill holes at marked locations using 5/16" drill bit. For solid walls (concrete or masonry), drill at least 1 1/4" deep.
2. Fold wall anchor (see Figure 6).

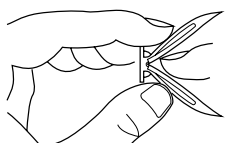

**Figure 6 - Folding Anchor**

3. Insert wall anchor (wings first) into hole. Tap anchor flush to wall.
4. For thin walls (1/2" or less), insert red key into wall anchor. Push red key to "pop" open anchor wings (see Figure 7). **IMPORTANT:** Do not hammer key!  
For thick walls (over 1/2" thick) or solid walls, do not pop open wings.

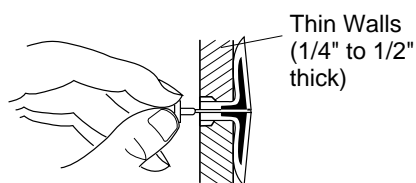

**Figure 7 - Popping Open Anchor Wings For Thin Walls**

5. Tighten two screws until 1/16" space (thickness of penny) is between screwheads and wall (see Figure 8).

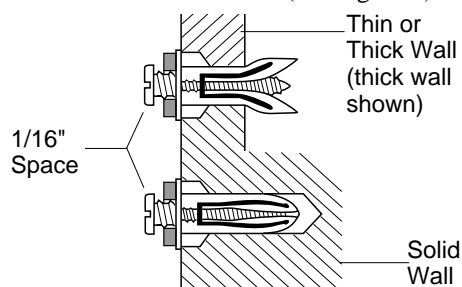

**Figure 8 - Tightening Anchors**

#### Placing Heater On Mounting Screws

1. Locate two keyhole slots on back panel of heater (see Figure 9).
2. Place large openings of slots over screwheads. Slide heater down until screws are in small portion of slots.

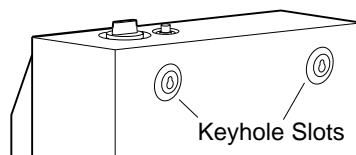

**Figure 9 - Location Of Keyhole Slots On Back Panel Of Heater**

#### Removing Front Panel Of Heater

1. Remove two screws near bottom corners of front panel.
2. Lift straight up on grill guard until it stops. Grill guard will slide up about 1/4".
3. Pull bottom of front panel forward, then down.

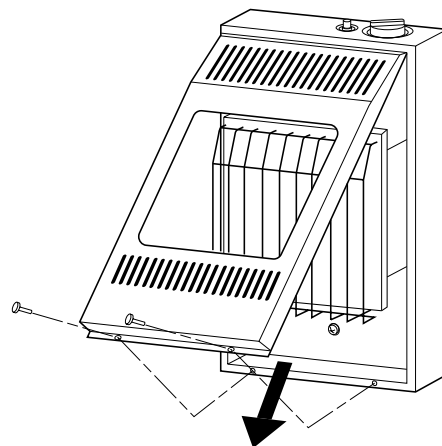

**Figure 10 - Removing Front Panel Of Heater**

#### Installing Bottom Mounting Screw

1. Locate bottom mounting hole. This hole is near bottom on back panel of heater (see Figure 11).
2. Mark screw location on wall.
3. Remove heater from wall.
4. If installing bottom mounting screw into hollow or solid wall, install wall anchor. Follow steps 1 through 5 under *Attaching To Wall Anchor Method*.

If installing bottom mounting screw into wall stud, drill hole at marked location using 9/64" drill bit.

5. Replace heater on wall.
6. Insert bottom anchor screw through back panel into bottom anchor or drilled hole (see Figure 11).
7. Tighten screw until heater is firmly secured to wall. Do not over tighten.

*Note:* Do not replace front panel at this time. Replace front panel after making gas connections and checking for leaks (see pages 8 and 9).

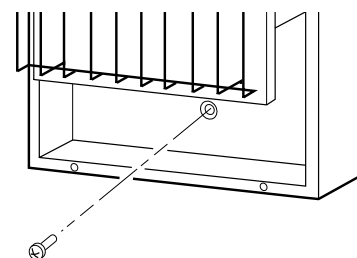

**Figure 11 - Installing Bottom Mounting Screw**

# Comfort Glow® CGN10A AND CGN6 NATURAL GAS HEATER

## CONNECTING TO GAS SUPPLY

**NOTICE:** A qualified service person must connect heater to gas supply. Follow all local codes.

**WARNING:** Never connect heater to private (non-utility) gas wells. This gas is commonly known as well-head gas.

**IMPORTANT:** Check gas line pressure before connecting heater to gas line. Gas line pressure must be no greater than 14 inches of water. If gas line pressure is higher, heater regulator damage could occur.

**CAUTION:** Use only new, black iron or steel pipe. Internally-tinned copper tubing may be used in certain areas. Check your local codes. Use pipe 3/8" diameter or greater to allow proper gas volume to heater. If pipe is too small, undue loss of pressure will occur.

Installation must include a manual shutoff valve, ground joint union, and plugged 1/8" NPT tap. Locate NPT tap within reach for test gauge hook up. NPT tap must be upstream from heater (see Figure 12).

Apply pipe joint sealant lightly to male threads. This will prevent excess sealant from going into pipe. Excess sealant in pipe could result in clogged heater valves.

**CAUTION:** Use pipe joint sealant that is resistant to liquid petroleum (LP) gas.

Install sediment trap in supply line as shown in Figure 12. Locate sediment trap where it is within reach for cleaning. Locate sediment trap where trapped matter is not likely to freeze. A sediment trap traps moisture and contaminants. This keeps them from going into heater controls. If sediment trap is not installed or is installed wrong, heater may not run properly.

**IMPORTANT:** Hold pressure regulator with wrench when connecting it to gas piping and/or fittings.

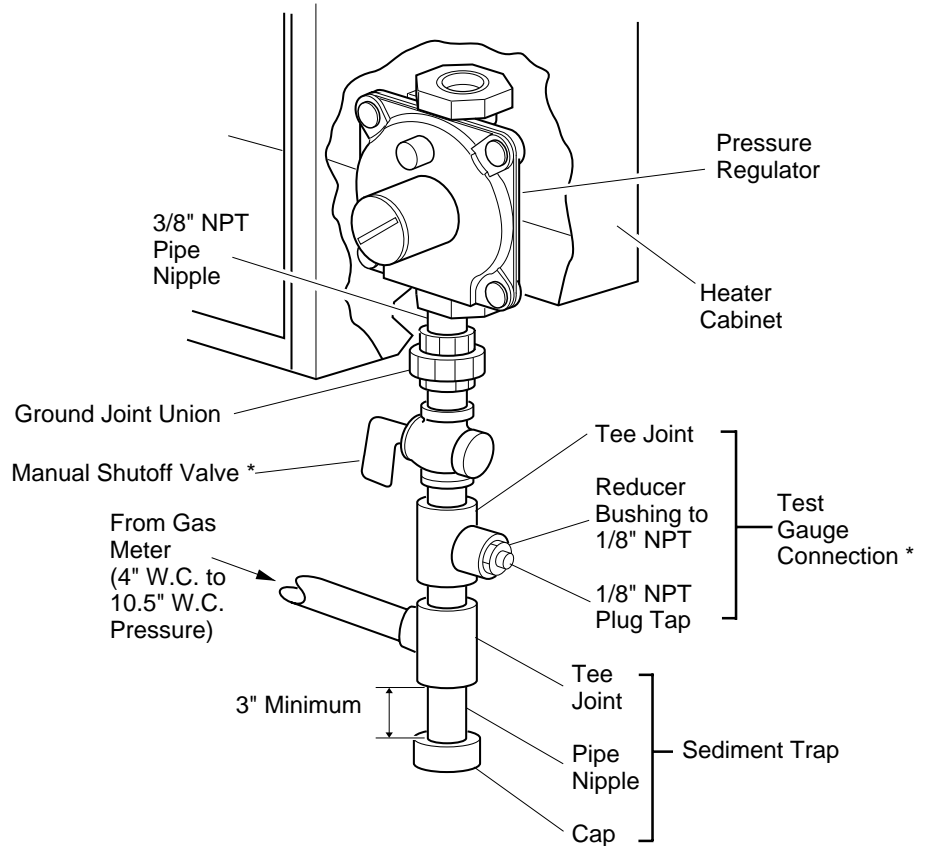

\* An A.G.A. design-certified manual shutoff valve with 1/8" NPT tap is an acceptable alternative to test gauge connection. Purchase the optional A.G.A. design-certified manual shutoff valve from your dealer. See *Accessory*, page 15.

**Figure 12 - Gas Connection**



## CHECKING GAS CONNECTIONS

**⚠ WARNING:** Test all gas piping and connections for leaks after installing or servicing. Correct all leaks at once.

**⚠ WARNING:** Never use an open flame to check for a leak. Apply a mixture of liquid soap and water to all joints. Bubbles forming show a leak. Correct all leaks at once.

## PRESSURE TESTING GAS SUPPLY PIPING SYSTEM

### Test Pressures In Excess Of 1/2 PSIG

1. Disconnect heater and its individual manual shutoff valve from gas supply piping system. Pressures in excess of 1/2 psig will damage heater regulator.
2. Cap off open end of gas pipe where manual shutoff valve was connected.
3. Pressurize supply piping system by either using compressed air or opening main gas valve located on or near gas meter.
4. Check all joints of gas supply piping system. Apply mixture of liquid soap and water to gas joints. Bubbles forming show a leak.
5. Correct all leaks at once.

### Test Pressures Equal To or Less Than 1/2 PSIG

1. Close manual shutoff valve (see Figure 13).
2. Pressurize supply piping system by either using compressed air or opening main gas valve located on or near gas meter.
3. Check all joints from gas meter to manual shutoff valve (see Figure 14). Apply mixture of liquid soap and water to gas joints. Bubbles forming show a leak.
4. Correct all leaks at once.

## PRESSURE TESTING HEATER GAS CONNECTIONS

1. Open manual shutoff valve (see Figure 13).
2. Open main gas valve located on or near gas meter.
3. Make sure control knob of heater is in the OFF position.
4. Check all joints from manual shutoff valve to control valve (see Figure 14). Apply mixture of liquid soap and water to gas joints. Bubbles forming show a leak.
5. Correct all leaks at once.
6. Light heater (see *Operating Heater*, pages 9 and 10). Check the rest of the internal joints for leaks.
7. Turn off heater (see *To Turn Off Gas to Appliance*, page 10).
8. Replace front panel.

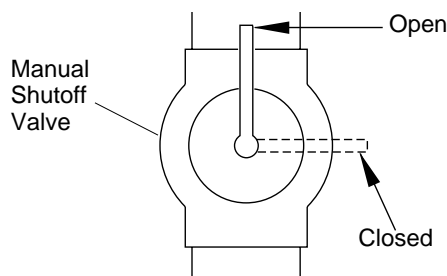

Figure 13 - Manual Shutoff Valve

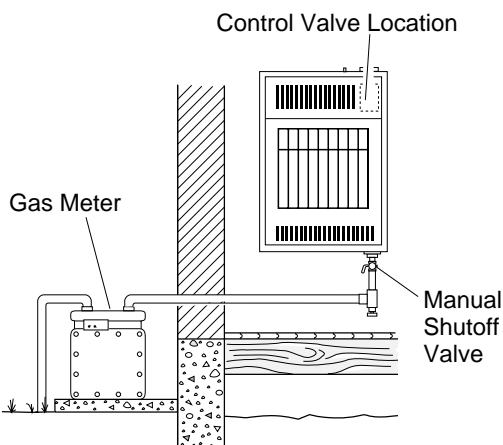

Figure 14 - Checking Gas Joints

## OPERATING HEATER

**FOR YOUR SAFETY READ BEFORE LIGHTING**

**⚠ WARNING:** If you do not follow these instructions exactly, a fire or explosion may result causing property damage, personal injury or loss of life.

- A. This appliance has a pilot which must be lighted by hand. When lighting the pilot, follow these instructions exactly.
- B. **BEFORE LIGHTING** smell all around the appliance area for gas. Be sure to smell next to the floor because some gas is heavier than air and will settle on the floor.

### WHAT TO DO IF YOU SMELL GAS

- Do not try to light any appliance.
  - Do not touch any electric switch; do not use any phone in your building.
  - Immediately call your gas supplier from a neighbor's phone. Follow the gas supplier's instructions.
  - If you cannot reach your gas supplier, call the fire department.
- C. Use only your hand to push in or turn the gas control knob. Never use tools. If the knob will not push in or turn by hand, don't try to repair it, call a qualified service technician or gas supplier. Force or attempted repair may result in a fire or explosion.
  - D. Do not use this appliance if any part has been under water. Immediately call a qualified service technician to inspect the appliance and to replace any part of the control system and any gas control which has been under water.

# Comfort Glow® CGN10A AND CGN6 NATURAL GAS HEATER

## LIGHTING INSTRUCTIONS

1. STOP! Read the safety information page 9, column 3.
2. Make sure manual shutoff valve is fully open.
3. Turn control knob clockwise to the OFF position.

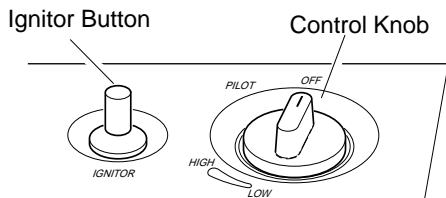

Figure 15 - Control Knob In The OFF Position

4. Wait five (5) minutes to clear out any gas. Then smell for gas, including near the floor. If you smell gas, STOP! Follow "B" in the safety information at the top of column 3, page 9. If you don't smell gas, go to the next step.

5. Press in control knob and turn counterclockwise to the PILOT position. Keep control knob pressed in for five (5) seconds (see Figure 15).

**Note:** You may be running this heater for the first time after hooking up to gas supply. If so, the control knob may need to be pressed in for 30 seconds. This will allow air to bleed from the gas system.

- If control knob does not pop up when released, contact a qualified service person or gas supplier for repairs.

6. With control knob pressed in, push down and release ignitor button. This will light pilot. The pilot is attached to the front of burner. The pilot can be seen through the glass panel. If needed, keep pressing ignitor button until pilot lights.

**Note:** If pilot does not stay lit, refer to *Troubleshooting*, pages 12 through 14. Also contact a qualified service person or gas supplier for repairs. Until repairs are made, light pilot with match. To light pilot with match, see *Manual Lighting Procedure*.

7. Keep control knob pressed in for 30 seconds after lighting pilot. After 30 seconds, release control knob.

**Note:** If pilot goes out, repeat steps 3 through 7.

8. Turn control knob counterclockwise to the HIGH position. The main burner should light. Set control knob to any heat level between HIGH and LOW. To turn control knob from HIGH to a lower setting, press in the control knob and turn counterclockwise.

**Note:** Both HIGH and LOW are locked positions. You must press in control knob before turning it from these positions.

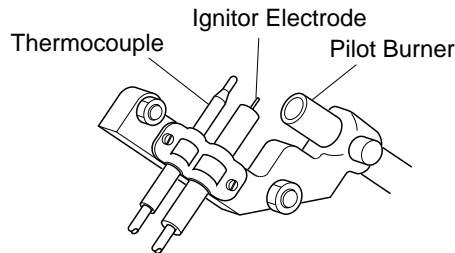

Figure 16 - Pilot

**CAUTION:** Do not try to adjust heating levels by using the manual shutoff valve.

## TO TURN OFF GAS TO APPLIANCE

### Shutting Off Heater

1. Turn control knob clockwise to the PILOT position.
2. Press in control knob and turn clockwise to the OFF position.

### Shutting Off Burner Only (pilot stays lit)

1. Turn control knob clockwise to the PILOT position.

## MANUAL LIGHTING PROCEDURE

1. Remove front panel (see Figure 10, page 7).
2. Follow steps 1 through 5 under *Lighting Instructions*.
3. With control knob pressed in, strike match. Hold match to pilot until pilot lights.
4. Keep control knob pressed in for 30 seconds after pilot is lit. After 30 seconds, release control knob.
5. Replace front panel.

## INSPECTING BURNER

Check pilot flame pattern and burner flame pattern often.

### PILOT FLAME PATTERN

Figure 17 shows a correct pilot flame pattern. Figure 18 shows an incorrect pilot flame pattern. The incorrect pilot flame is not touching the thermocouple. This will cause the thermocouple to cool. When the thermocouple cools, the heater will shut down.

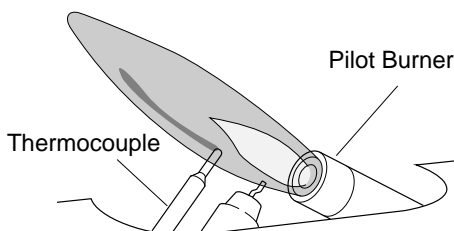

**Figure 17 - Correct Pilot Flame Pattern**

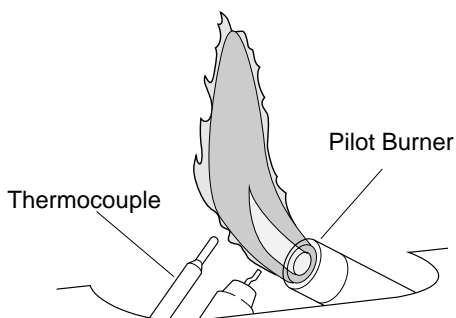

**Figure 18 - Incorrect Pilot Flame Pattern**

If pilot flame pattern is incorrect, as shown in Figure 18

- turn heater off (see *To Turn Off Gas to Appliance*, page 10)
- see *Troubleshooting*, pages 12 through 14

### BURNER FLAME PATTERN

Figure 19 shows a correct burner flame pattern. Figure 20 shows an incorrect burner flame pattern. The incorrect burner flame pattern shows yellow tipping of the flame. It also shows the flame higher than 1/2 the glass panel height.

**WARNING:** If yellow tipping occurs, your heater could produce increased levels of carbon monoxide. If burner flame pattern shows yellow tipping, follow instructions at bottom of this page.

**NOTICE:** Do not mistake orange flames with yellow tipping. Dust or other fine particles enter the heater and burn causing brief patches of orange flame.

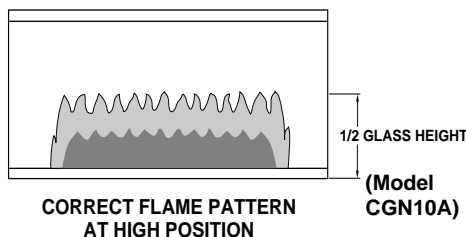

**(Model CGN6 will be lower due to lower input rating)**

**Figure 19 - Correct Burner Flame Pattern**

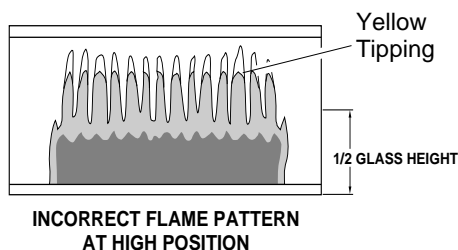

**Figure 20 - Incorrect Burner Flame Pattern**

If burner flame pattern is incorrect, as shown in Figure 20

- turn heater off (see *To Turn Off Gas to Appliance*, page 10)
- see *Troubleshooting*, pages 12 through 14

## CLEANING AND MAINTENANCE

**WARNING:** Turn off heater and let cool before cleaning.

**CAUTION:** You must keep control areas, burner, and circulating air passageways of heater clean. Inspect these areas of heater before each use. Have heater inspected yearly by a qualified service person. Heater may need more frequent cleaning due to excessive lint from carpeting, bedding material, etc.

### ODS/PILOT AND BURNER ORIFICE

- Use a vacuum cleaner, pressurized air, or small, soft bristled brush to clean.

### CABINET

#### Air Passageways

- Use a vacuum cleaner or pressurized air to clean.

#### Exterior

- Use a soft cloth dampened with a mild soap and water mixture. Wipe the cabinet to remove dust.

# Comfort Glow® CGN10A AND CGN6 NATURAL GAS HEATER

## TROUBLESHOOTING

Note: All troubleshooting items are listed in order of operation.

**⚠ WARNING:** Turn off heater and let cool before servicing. Only a qualified service person should service and repair heater.

**⚠ CAUTION:** Never use a wire, needle, or similar object to clean ODS/pilot. This can damage ODS/pilot unit.

### OBSERVED PROBLEM

### POSSIBLE CAUSE

### REMEDY

When ignitor button is pressed, there is no spark at ODS/pilot

1. Ignitor electrode positioned wrong
2. Ignitor electrode broken
3. Ignitor electrode not connected to ignitor cable
4. Ignitor cable pinched or wet
5. Piezo ignitor nut is loose
6. Broken ignitor cable
7. Bad piezo ignitor

1. Replace ignitor
2. Replace ignitor
3. Reconnect ignitor cable
4. Free ignitor cable if pinched by any metal or tubing. Keep ignitor cable dry
5. Tighten nut holding piezo ignitor to heater cabinet. Nut is located inside heater cabinet at top
6. Replace ignitor cable
7. Replace piezo ignitor

When ignitor button is pressed, there is spark at ODS/pilot but no ignition

1. Gas supply turned off or manual shutoff valve closed
2. Control knob not in PILOT position
3. Control knob not pressed in while in PILOT position
4. Air in gas lines when installed
5. ODS/pilot is clogged
6. Gas regulator setting is not correct

1. Turn on gas supply or open manual shutoff valve
2. Turn control knob to PILOT position
3. Press in control knob while in PILOT position
4. Continue holding down control knob. Repeat igniting operation until air is removed
5. Clean ODS/pilot (see *Cleaning and Maintenance*, page 11) or replace ODS/pilot assembly
6. Replace gas regulator

ODS/pilot lights but flame goes out when control knob is released

1. Control knob not fully pressed in
2. Control knob not pressed in long enough
3. Manual shutoff valve not fully open
4. Thermocouple connection loose at control valve
5. Pilot flame not touching thermocouple, which allows thermocouple to cool, causing pilot flame to go out. This problem could be caused by one or both of the following:
  - A) Low gas pressure
  - B) Dirty or partially clogged ODS/pilot
6. Thermocouple damaged
7. Control valve damaged

1. Press in control knob fully
2. After ODS/pilot lights, keep control knob pressed in 30 seconds
3. Fully open manual shut-off valve
4. Hand tighten until snug, then tighten 1/4 turn more
5. A) Contact local natural gas company  
B) Clean ODS/pilot (see *Cleaning and Maintenance*, page 11) or replace ODS/pilot assembly
6. Replace thermocouple
7. Replace control valve

Continued

# OWNER'S MANUAL

## TROUBLESHOOTING

### *Continued*

<b>OBSERVED PROBLEM</b>	<b>POSSIBLE CAUSE</b>	<b>REMEDY</b>
Burner does not light after ODS/pilot is lit	<ol style="list-style-type: none"><li>1. Burner orifice is clogged</li><li>2. Burner orifice diameter is too small</li><li>3. Inlet gas pressure is too low</li></ol>	<ol style="list-style-type: none"><li>1. Clean burner orifice (see <i>Cleaning and Maintenance</i>, page 11) or replace burner orifice</li><li>2. Replace burner orifice</li><li>3. Contact local natural gas company</li></ol>
Delayed ignition of burner	<ol style="list-style-type: none"><li>1. Manifold pressure is too low</li><li>2. Burner orifice is clogged</li></ol>	<ol style="list-style-type: none"><li>1. Contact local natural gas company</li><li>2. Clean burner orifice (see <i>Cleaning and Maintenance</i>, page 11) or replace burner orifice</li></ol>
Burner backfiring during combustion	<ol style="list-style-type: none"><li>1. Burner orifice is clogged or damaged</li><li>2. Burner damaged</li><li>3. Gas regulator defective</li></ol>	<ol style="list-style-type: none"><li>1. Clean burner orifice (see <i>Cleaning and Maintenance</i>, page 11) or replace burner orifice</li><li>2. Replace burner</li><li>3. Replace gas regulator</li></ol>
Yellow flame during burner combustion	<ol style="list-style-type: none"><li>1. Not enough air</li><li>2. Inlet gas pressure is too low</li><li>3. Gas regulator defective</li></ol>	<ol style="list-style-type: none"><li>1. Check burner for dirt and debris. If found, clean burner (see <i>Cleaning and Maintenance</i>, page 11)</li><li>2. Contact local natural gas company</li><li>3. Replace gas regulator</li></ol>
Slight smoke or odor during initial operation	<ol style="list-style-type: none"><li>1. Residues from manufacturing processes</li></ol>	<ol style="list-style-type: none"><li>1. Problem will stop after a few hours of operation</li></ol>
Heater produces a whistling noise when burner is lit	<ol style="list-style-type: none"><li>1. Turning control knob to HIGH position when burner is cold</li><li>2. Air in gas line</li><li>3. Air passageways on heater blocked</li><li>4. Dirty or partially clogged burner orifice</li></ol>	<ol style="list-style-type: none"><li>1. Turn control knob to LOW position and let warm up for a minute</li><li>2. Operate burner until air is removed from line. Have gas checked by local natural gas company</li><li>3. Observe minimum installation clearances (see Figure 4, page 6)</li><li>4. Clean burner (see <i>Cleaning and Maintenance</i>, page 11) or replace burner orifice.</li></ol>

*Continued*

# Comfort Glow® CGN10A AND CGN6 NATURAL GAS HEATER

## TROUBLESHOOTING *Continued*

**⚠ WARNING:** If you smell gas

- Shut off gas supply.
- Do not try to light any appliance.
- Do not touch any electrical switch; do not use any phone in your building.
- Immediately call your gas supplier from a neighbor's phone. Follow the gas supplier's instructions.
- If you cannot reach your gas supplier, call the fire department.

**IMPORTANT:** Operating heater where impurities in air exist may create odors. Cleaning supplies, paint, paint remover, cigarette smoke, cements and glues, new carpet or textiles, etc., create fumes. These fumes may mix with combustion air and create odors.

OBSERVED PROBLEM	POSSIBLE CAUSE	REMEDY
Heater produces a clicking/ticking noise just after burner is lit or shut off	1. Metal expanding while heating or contracting while cooling	1. This is common with most heaters. If noise is excessive, contact qualified service person
Heater produces unwanted odors	1. Heater burning vapors from paint, hair spray, glues, etc. See <b>IMPORTANT</b> statement above 2. Gas leak. <b>See Warning statement at top of page</b>	1. Ventilate room. Stop using odor-causing products while heater is running 2. Locate and correct all leaks (see <i>Checking Gas Connections</i> , page 9)
Heater shuts off in use (ODS operates)	1. Not enough fresh air is available 2. Low line pressure 3. ODS/pilot is partially clogged	1. Open window and/or door for ventilation 2. Contact local natural gas company 3. Clean ODS/pilot (see <i>Cleaning and Maintenance</i> , page 11)
Gas odor even when control knob is in OFF position	1. Gas leak. <b>See Warning statement at top of page</b> 2. Control valve defective	1. Locate and correct all leaks ( see <i>Checking Gas Connections</i> , page 9) 2. Replace control valve
Gas odor during combustion	1. Foreign matter between control valve and burner 2. Gas leak. <b>See Warning statement at top of page</b>	1. Take apart gas tubing and remove foreign matter 2. Locate and correct all leaks (see <i>Checking Gas Connections</i> , page 9)
Moisture/condensation noticed on windows	1. Not enough combustion/ventilation air.	1. Refer to <i>Fresh Air for Combustion and Ventilation</i> requirements (page 3)

# OWNER'S MANUAL

## SPECIFICATIONS

	CGN6	CGN10A
Btu (Variable)	4,400/6,000	5,000/10,000
Type Gas	Natural Only	Natural Only
Ignition	Piezo	Piezo
Pressure Regulator Setting	3" W.C.	3" W.C.
Inlet Gas Pressure (inches of water)		
Maximum	10.5"	10.5"
Minimum	4"	4"
Dimensions, Inches (H x W x D)		
Heater	20 1/2 x 13 1/2 x 5	20 1/2 x 13 1/2 x 5
Carton	25 x 16 11/16 x 7 1/2	25 x 16 11/16 x 7 1/2
Weight (pounds)		
Heater	13.5	13.5
Shipping	17	18

## TECHNICAL SERVICE

You may have further questions about installation, operation, or troubleshooting.

If so, contact DESA International's Technical Service Department at 1-800-323-5190.

## SERVICE HINTS

### When gas pressure is too low

- pilot will not stay lit
- burner will have delayed ignition
- heater will not produce specified heat

### When gas quality is bad

- pilot will not stay lit
- burner will produce flames and soot
- heater will backfire when lit

You may feel your gas pressure is too low or gas quality is bad. If so, contact your local natural gas supplier.

## SERVICE PUBLICATIONS

You can purchase a service manual from the address listed on the back page of this manual. Send a check for \$5.00 payable to DESA International.

## ACCESSORY

Purchase this heater accessory from your local dealer. If they cannot supply this accessory, either contact your nearest Parts Central (page 18) or call DESA International's Parts Department at 1-800-972-7879 for referral information. You can also write to the address listed on the back page of this manual.

### MANUAL SHUTOFF VALVE - GA5010

Manual shutoff valve with 1/8" NPT tap.

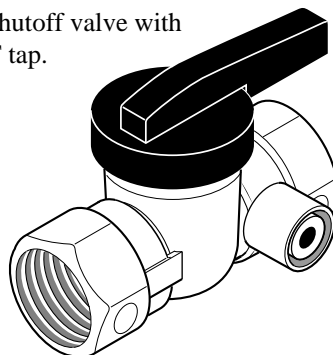

## REPLACEMENT PARTS

*Note:* Use only original replacement parts. This will protect your warranty coverage for parts replaced under warranty.

### Parts Under Warranty

Contact authorized dealer from whom you purchased this product. If they cannot supply original replacement part(s), call DESA International's Technical Service Department at 1-800-323-5190 for referral information.

When contacting your dealer or DESA International, have ready:

- your name
- your address
- model number of your heater
- how heater was malfunctioning
- type of gas used (propane/LP or natural gas)
- purchase date

Usually, we will ask you to return the defective part to the factory.

### Parts Not Under Warranty

Contact authorized dealers of this product. If they cannot supply original replacement part(s), either contact your nearest Parts Central (see page 18) or call DESA International's Parts Department at 1-800-972-7879 for referral information.

When calling DESA International, have ready:

- model number of your heater
- the replacement part number

# Comfort Glow® CGN10A AND CGN6 NATURAL GAS HEATER

## ILLUSTRATED PARTS LIST

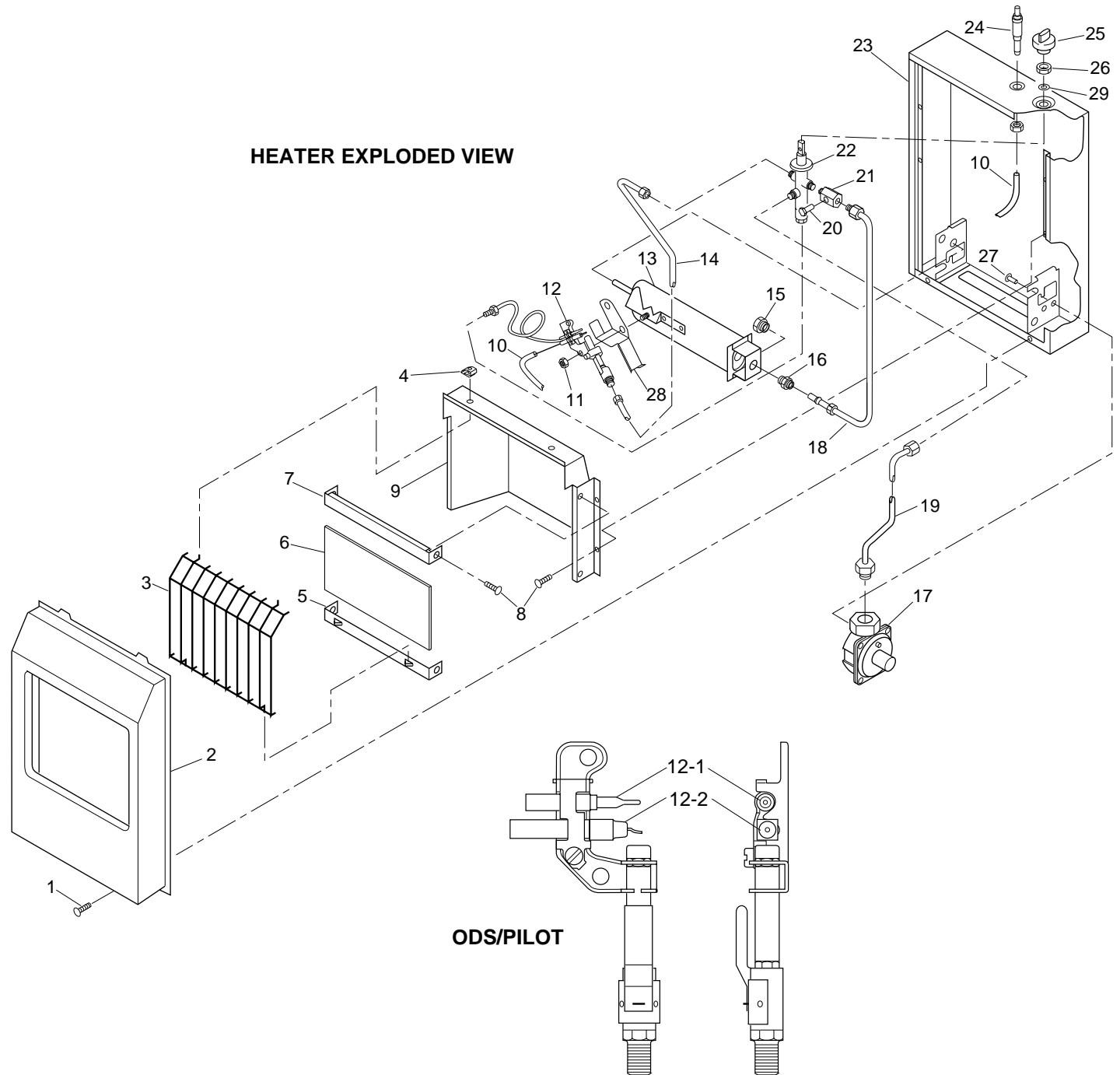



# OWNER'S MANUAL

## PARTS LIST

This list contains replaceable parts used in your heater. When ordering parts, follow the instructions listed under *Replacement Parts* on page 15 of this manual.

KEY NO.	PART NUMBER FOR		DESCRIPTION	QTY.
	CGN6	CGN10A		
1	098304-01	098304-01	Screw, #10 x 3/8"	2
2	099467-02	099467-02	Front Panel Assembly	1
3	099318-04	099318-04	Grill Guard	1
4	101108-01	101108-01	Grill Guard Clip	2
5	102018-01AA	102018-01AA	Bottom Glass Retainer	1
6	098260-03	098260-03	Glass Panel	1
7	098532-03AA	098532-03AA	Top Glass Retainer	1
8	M11084-38	M11084-38	Screw, #8 x 3/8"	8
9	098352-03BR	098352-03BR	Deflector Unit	1
10	098271-03	098271-03	Ignitor Cable	1
11	098249-01	098249-01	Nut, M5	2
12	100701-03	100701-03	ODS/Pilot Assembly	1
12-1	098514-01	098514-01	Thermocouple	1
12-2	098594-01	098594-01	Ignitor Electrode	1
13	099386-02	099386-02	Burner	1
14	099387-05	099387-05	Pilot Tubing	1
15	098251-01	098251-03	Injector	1
16	099463-01	099463-01	Injector Holder	1
17	099415-01	099415-01	Pressure Regulator	1
18	099462-01	099462-01	Burner Tubing	1
19	099391-02	099391-02	Regulator Tubing	1
20	098276-01	098276-01	1/8" NPT Plug	1
21	099057-01	099057-01	Pressure Tap Fitting	1
22	099413-01	099413-01	Control Valve	1
23	099468-12	099468-11	Cabinet	1
24	102445-01	102445-01	Piezo Ignitor	1
25	099393-01	099393-01	Control Knob	1
26	098508-01	098508-01	Valve Retainer Nut	1
27	098303-02	098303-02	Screw, #6 x 5/16"	2
28	099553-01	099553-01	Pilot Shield	1
29	099818-01	099818-01	Internal Tooth Washer	1
<b>PARTS AVAILABLE - NOT SHOWN</b>				
	099395-10	099395-03	Control Position Label	1
	100642-02	100642-02	Assembly, Hardware	1

# *Comfort Glow*® CGN10A AND CGN6 NATURAL GAS HEATER

---

## PARTS CENTRALS

These Parts Centrals are privately owned businesses. They have agreed to support our customer's needs by providing original replacement parts and accessories.

**Baltimore Electric**  
1348 Dixwell Avenue  
Hamden, CT 06514  
1-800-397-7553  
203-248-7553  
Parts Department

**Portable Heater Parts**  
342 N. County Rd. 400 East  
Valparaiso, IN 46383  
All States  
219-462-7441  
1-800-362-6951

**FBD**  
P.O. Box 1096  
1720 Kummer Road  
Franklin, KY 42134  
502-586-1922  
1-800-654-8534

**Four Flags Power  
Products**  
1115 Stateline Road  
Niles, MI 49120  
616-684-2697  
1-800-268-4983  
Parts Only

**Master Service Center**  
1184 Wilson NW  
Walker, MI 49504  
616-791-4760  
1-800-446-1446

**Washer Equipment Co.**  
1715 Main Street  
Kansas City, MO 64108  
KS, MO, AR  
816-842-3911

**East Coast Energy  
Products**  
707 Broadway  
W. Long Branch, NJ  
07764  
908-870-8809  
1-800-755-8809

**Tarantin Tank Co.**  
P.O. Box 6129  
Freehold, NJ 07728  
908-780-9340  
1-800-922-0724

**Dayton Hardware**  
P.O. Box 275  
North Dayton Station  
Dayton, OH 45404  
All States  
513-258-3721  
OH 1-800-762-3426

**Halco Enterprises**  
208 Carter Drive, Unit 21  
West Chester, PA 19382  
215-696-2670  
1-800-368-0803

**LA Porte's Parts & Service**  
2444 North 5th Street  
Hartsville, SC 29550  
803-332-0191  
Parts Department

**Cans Unlimited, Inc.**  
P.O. Box 645  
Taylor, SC 29687  
All States  
803-879-3009  
1-800-845-5301



# WARRANTY INFORMATION

## KEEP THIS WARRANTY

Model \_\_\_\_\_

Serial No. \_\_\_\_\_

Date Purchased \_\_\_\_\_

Always specify model and serial numbers when communicating with the factory.

We reserve the right to amend these specifications at any time without notice. The only warranty applicable is our standard written warranty. We make no other warranty, expressed or implied.

### LIMITED WARRANTY

#### COMFORT GLOW VENT-FREE RESIDENTIAL GAS HEATERS

DESA International warrants this product to be free from defects in materials and components for two (2) years from the date of first purchase, provided that the product has been properly installed, operated and maintained in accordance with all applicable instructions. To make a claim under this warranty the Bill of Sale or cancelled check must be presented.

This warranty is extended only to the original retail purchaser. This warranty covers only the cost of part(s) required to restore this heater to proper operating condition. Warranty part(s) MUST be obtained through authorized dealers of this product and/or DESA International who will provide original factory replacement parts. Failure to use original factory replacement parts voids this warranty. The heater MUST be installed by a qualified installer in accordance with all local codes and instructions furnished with the unit.

This warranty does not apply to parts that are not in original condition because of normal wear and tear, or parts that fail or become damaged as a result of misuse, accidents, lack of proper maintenance or defects caused by improper installation. Travel, diagnostic cost, labor, transportation and any and all such other costs related to repairing a defective heater will be the responsibility of the owner.

TO THE FULL EXTENT ALLOWED BY THE LAW OF THE JURISDICTION THAT GOVERNS THE SALE OF THE PRODUCT; THIS EXPRESS WARRANTY EXCLUDES ANY AND ALL OTHER EXPRESSED WARRANTIES AND LIMITS THE DURATION OF ANY AND ALL IMPLIED WARRANTIES, INCLUDING WARRANTIES OF MERCHANTABILITY AND FITNESS FOR A PARTICULAR PURPOSE TO TWO (2) YEARS FROM THE DATE OF FIRST PURCHASE; AND DESA INTERNATIONAL'S LIABILITY IS HEREBY LIMITED TO THE PURCHASE PRICE OF THE PRODUCT AND DESA INTERNATIONAL SHALL NOT BE LIABLE FOR ANY OTHER DAMAGES WHATSOEVER INCLUDING INDIRECT, INCIDENTAL OR CONSEQUENTIAL DAMAGES.

Some states do not allow a limitation on how long an implied warranty lasts or an exclusion or limitation of incidental or consequential damages, so the above limitation on implied warranties, or exclusion or limitation on damages may not apply to you.

This warranty gives you specific legal rights, and you may also have other rights that vary from state to state.

For information about this warranty write:

**DESA**  
INTERNATIONAL

2701 Industrial Drive  
P.O. Box 90004  
Bowling Green, KY 42102-9004

101870-01  
REV. F  
7/97