

Quick Start Guide Vision MINI Smart Camera



MICROSCAN.

Copyright ©2011 Microscan Systems, Inc.

P/N 83-126300 Rev A

Step 1 — Check Hardware

The list of hardware below can be used in a variety of applications and configurations. Consult with Microscan for further information about which items are most appropriate for your application.

Item	Description	Part Number
1	Vision MINI Smart Camera	GMV-6300-XXXXG
2	IC-332 Voltage Converter (to 10-28V)	FIS-0001-0035G
3	IB-131 Interface Box	99-000018-01
4	USB Type A to USB Type B Cable, 6'	60-000064-01
5	Communication Cable (IB-131 to Host, 6')	61-300026-03
6	Trigger (Photo Sensor, Visible, NPN, Dark On)	99-000017-01
7	Trigger (Photo Sensor, Visible, NPN, Light On)	99-000017-02
8	Trigger (Photo Sensor, Visible, NPN, Light On)	99-000019-01
9	Power Supply (90-264 VAC, 24VDC, USA/Euro plug)	97-100004-15
10	Power Supply (90-264 VAC, +5VDC)	97-000002-02

Step 2 — Connect the System

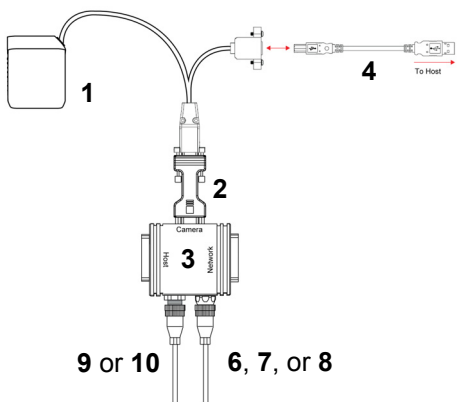

Hardware Configuration

1. Mount the camera (1) as required by the application.
2. Connect the USB side of the camera cable to the USB host cable (4).
3. Connect the IC-332 (2) to the IB-131 (3).
4. Connect the D-sub side of the camera cable to the IC-332 (2).
5. Connect the trigger (6, 7, or 8) to the IB-131 (3).
6. Connect the power supply (9 or 10) to the IB-131 (3).
7. Plug in the power supply (9 or 10).

Step 3 — Mount and Position the Camera

1. Place the camera and object in a location with as little ambient light as possible.
 2. Position the camera at a focal distance between 2" and 6" from the object.
 3. Tip the camera relative to the object to avoid glare from specular reflection. Avoid excessive skew or pitch. Maximum skew is $\pm 30^\circ$; maximum pitch is $\pm 30^\circ$.
- Proper lighting is critical to the success of a machine vision application. The Vision MINI features integrated lighting (SXGA version: built-in red LEDs @ 617nm; QXGA version: built-in white LEDs). Depending on the requirements of your application, you may also need to add external lighting from Microscan's NERLITE family of machine vision lighting products.

Consider the following:

- Is the surface of the object flat, slightly bumpy, or very bumpy?
- Is the surface matte or shiny?
- Is the object curved or flat?
- What is the color of the object or area being inspected?
- Is the object moving or stationary?

Machine vision lighting should maximize contrast of the areas or features being inspected while minimizing the contrast of everything else.

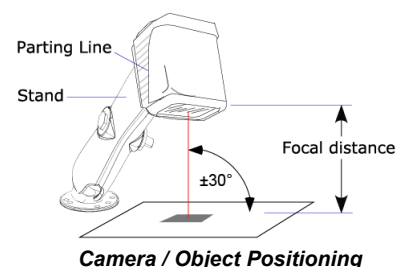

Step 4 — Install AutoVISION

AutoVISION can be found on the Microscan Tools Drive that is packaged with the camera.



1. Follow the prompts to install AutoVISION from the Tools Drive.
2. Click on the AutoVISION icon to run the program.

Note: AutoVISION can also be installed from the **Download Center** at www.microscan.com.

Minimum System Requirements

- Core2Duo processor
- Windows 7 32-bit or XP operating system
- Internet Explorer 7 or higher
- 2GB RAM/128MB Video RAM (Windows 7); 1GB/128MB Video RAM (XP)
- 750MB to 1GB hard drive space
- 16-bit color display
- 3.0 Windows Experience Index (4.0 preferred)

Step 5 — Connect to the Camera

After you launch AutoVISION, you will see the **Select a device to start editing a job** view.

Note: If there is a default job on the camera, AutoVISION will automatically skip the **Connect** step and you will see the **Image** view.

1. Select your camera from the **Select Device** dropdown menu.
2. Click the **Modify** button beneath the camera settings details to change camera settings.
3. Choose whether you want to create a new job, load a job (.avp) from your PC, or upload a job from the camera.

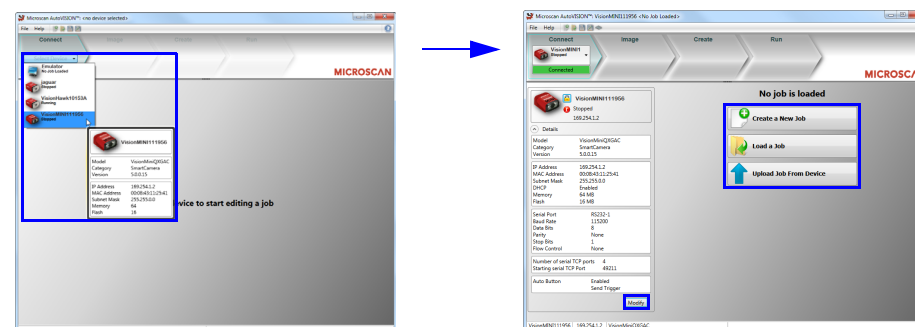

Step 6 — Evaluate a Captured Image and Auto Calibrate

You will see the **Image** view after selecting your device. This view allows you to evaluate your first image capture, providing information such as image size and a histogram. Click the **Auto Calibration** button to set optimal camera parameters automatically. You can also adjust **Exposure**, **Gain**, and **Focus** as needed, and set the desired **Lighting Mode**.

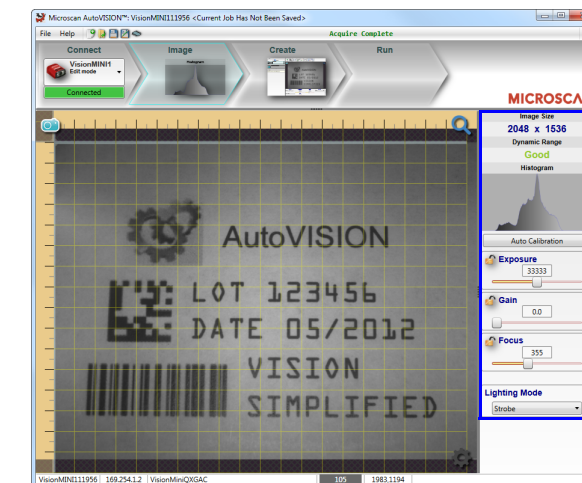

Step 7 — Create Your First Job with AutoVISION

After you have evaluated a captured image and Auto Calibrated the camera in the **Image** view, you will move to the **Create** view. This interface allows you to set camera parameters, add machine vision tools to captured images, set tool parameters, and configure I/O inspection outputs.

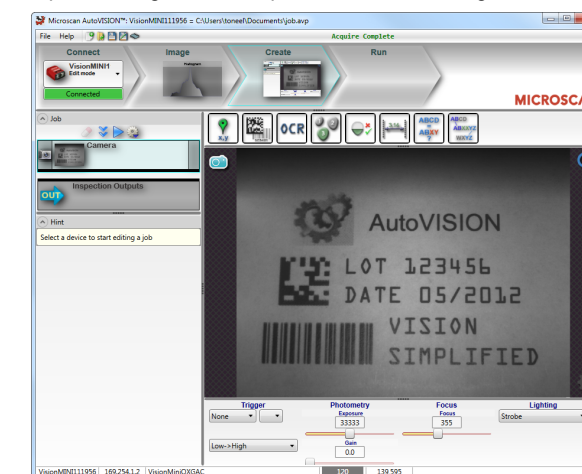

Step 8 — Explore the Interface

The **Create** view features a large image area with tool icons above and tool parameters below. When a tool is selected, its parameters appear below the image area.

Tools that have been added are shown in the job list to the left of the image area, below the **Camera** box. Image settings can be controlled using the icons in the corners of the image area.

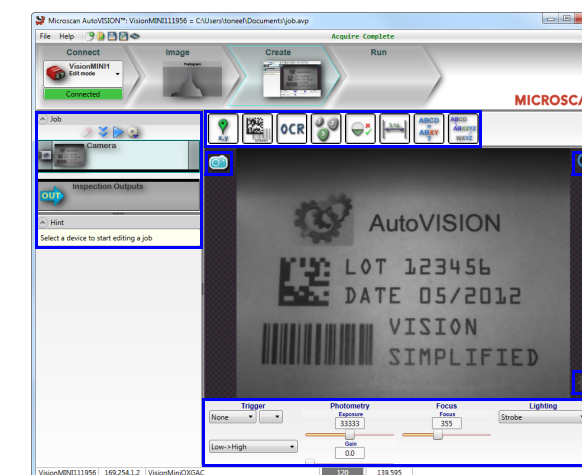

Step 9 — Set Camera Parameters

1. Click on the **Camera** box to the left of the image area.
2. In the camera parameters below the image area, select the desired type of **Trigger**, **Trigger Polarity**, **Photometry** (Exposure and Gain), **Focus**, and **Lighting**.

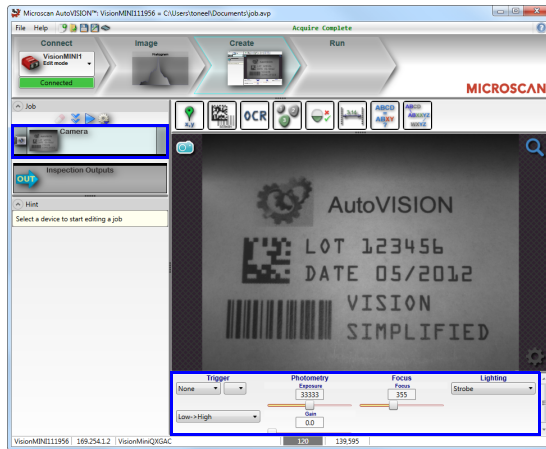

Step 10 — Add Tools to the Job

1. Click on the **Decode Tool** or drag it onto the image area.
2. Use the anchor points at the corners of the region of interest to form a box around the Data Matrix symbol. Leave plenty of space on each side of the symbol.
3. Now add a second Decode Tool and do the same for the 1D symbol below the Data Matrix symbol.
4. Finally, add an **OCR Tool** and drag the region of interest around the area of the image where "123456" is printed.

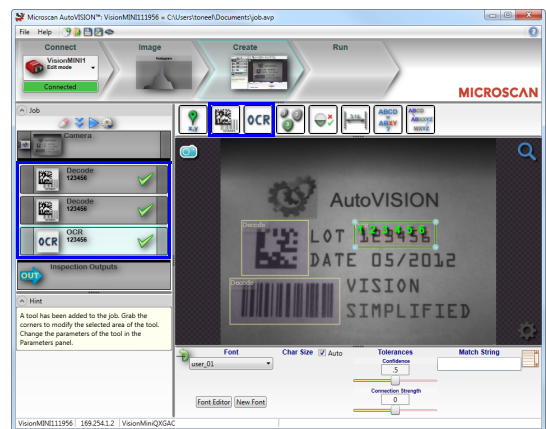

Step 11 — Try Out the Job

Once you have configured the tools as desired, use the arrow icons in the Job area to try the job you have just created.

Note: Most jobs will inspect multiple captured images. If only one image is being inspected, the effect of the arrow icons will not be evident.

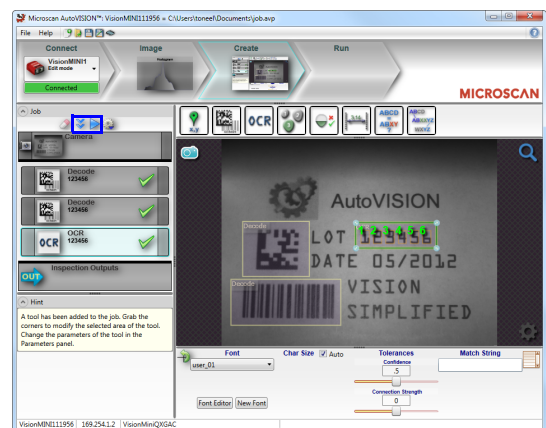

 **Try Out Job Once**

 **Try Out Job in Loop**

Step 12 — Run the Job

When all job parameters are set, click on the **Run** step at the top of the interface. The software will download the vision job just created to the camera and will begin the inspection. Inspection results and the list of active tools are shown at the right of the image view. That information can also be moved below the image area by clicking the orientation buttons above the inspection results area.



Test Jobs

Note: For descriptions of more advanced functionality, such as setting **Inspection Outputs** or using the **Locate Tool** and **Decode Tool's Dynamic Locate** functionality to track multiple tools from image to image, see the help documentation in AutoVISION software or the *AutoVISION User's Manual*.

Decode Tool, OCR Tool, Match Strings Tool, String Format Tool



Measure Tool, Count Tool



Measure:
Measure the distance between the jaws of the caliper gauges at left.

Count:
Count the circles on the dice shown at right.



Power Requirements and Pin Assignments

Power Requirements: 5VDC +/- 5%, 200 mV p-p max. ripple, 554 mA @ 5VDC (typ.)

Vision MINI USB and I/O connectors

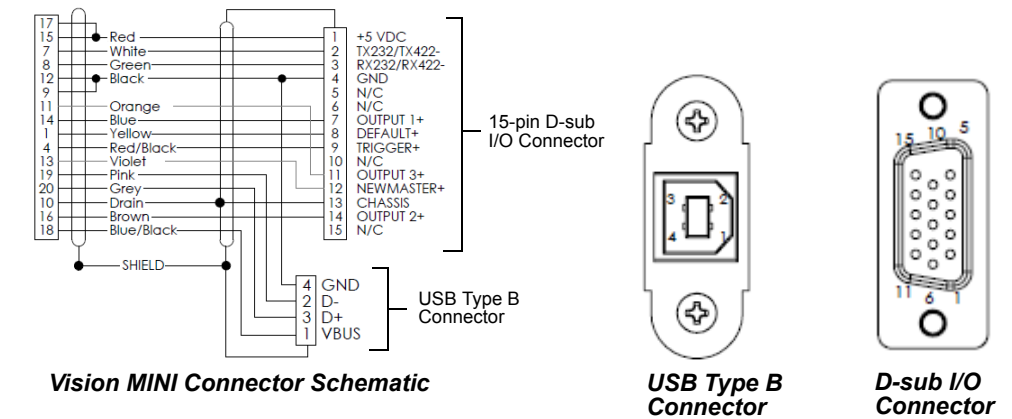

Vision MINI Smart Camera Accessories

Communication and I/O Devices and Cables		
IC-332 Adapter	FIS-0001-0035G	Connects the camera to an IB-131 interface device. Provides 5VDC power and optoisolation for the camera.
MS-Connect 210	FIS-0210-000XG	Connectivity box
USB Type A to USB Type B Cable, 6'	60-000064-01	Connects camera cable to host.
Trigger	99-000017-01	Photo Sensor, Visible, NPN, Dark On
Trigger (MS-Connect 210 configuration)	99-000017-02	Photo Sensor, Visible, NPN, Light On
Trigger (USB configuration)	99-000019-01	Photo Sensor, Visible, NPN, Light On
IB-131 Interface	99-000018-01	Allows cameras to be connected easily to power, trigger, and standard serial connections.
Host Cable	61-000105-01	MS-Connect 210 to Host, User-stripped to 9-pin
Camera Cable	61-000127-01	Camera to MS-Connect 210, 6' (1829 mm)
Communication Cable	61-300026-03	DB25 Plug to DB9 Socket, 6' (1829 mm)
Power Supply		
Power Supply	97-100004-15	90-264 VAC, 24VDC, USA/Euro plug
Mounting Options		
Mounting Arm Kit	98-000048-01	An adjustable mounting arm with ball and socket connections that allow the arm to be positioned in almost any orientation.
Extension Joint Kit	98-000053-01 (4") 98-000053-02 (3")	Allows the mounting arm to be extended. Kits include extension joint and mounting arm.
Base Plate Kit	98-000054-01	Plate for desktop presentation, 6" x 6" (152.4 mm x 152.4 mm).
Through-Hole Mount Bracket	98-000057-01	Allows the camera to be mounted to various surfaces.
Side Mount Bracket	98-000060-01	Allows the camera to be mounted at a 90° angle.
Right-Angle Mirror Kit	98-000088-01	Changes field of view direction by 90°.
Diffuser Accessory Kit	98-000098-01	Improves readability of direct part marks.
Demo Kit		
Demo Kit	98-000215-01	Carrying case, mounting blocks, mounting rods, power supply, IC-332, IB-131, cables, test cards, documentation.
Documentation		
Microscan Tools Drive	37-000010-01	Software, User's Manuals, Quick Start Guides, Configuration Guides, links to other documents on Microscan website

Note: Additional accessories are available in the Microscan Product Pricing Catalog.

Vision MINI Part Numbers

Vision MINI part numbers follow the format **GMV-6300-CLSYG**:

Comm = 2 for USB;

Lens = 1 for Standard Density, 2 for High Density 2.5;

Sensor = 1 for SXGA (1 megapixel), 2 for Color QXGA (3 megapixel);

Y (Options) = 0 for AutoVISION, 1 for Custom, 2 for Licensed (Visionscape), 3 for Custom + Licensed

G = RoHS-Compliant