

User's Manual

PBG50B: Electric Fireplace

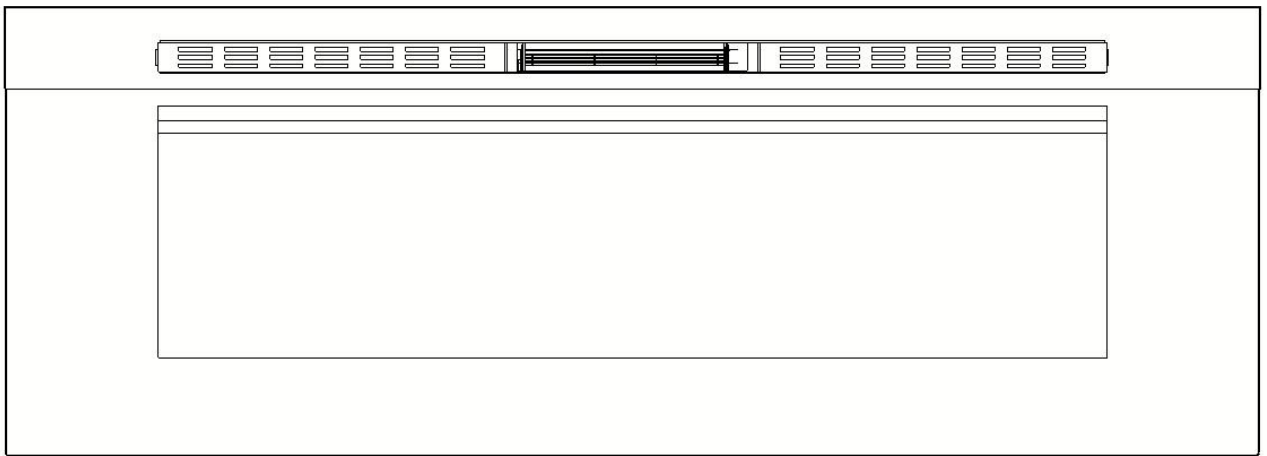

MODEL: PBG50B

Read this owner's manual very carefully before using it

Please retain for future reference



IMPORTANT: It is important to read these instructions carefully before using the appliance for the first time. Keep the instructions safe so that you can refer to them later if necessary.

【IMPORTANT INSTRUCTIONS】

When using electrical appliances basic precautions should always be followed to reduce the risk of fire, electric shock and injury to persons, including the following:

- 1) Read all instructions before using this heater.
- 2) This heater is hot when in use. To avoid burning, do not touch hot surface. If provided, use handles when moving this heater. Keep combustible materials, such as furniture, pillows, bedding, papers, clothes, and curtains at least 3ft from the front of the heater and keep them away from the sides and rear. In order to avoid overheating, do not cover the heater.
- 3) Extreme caution is necessary when any heater is used near children or the infirm and whenever the heater is left operating and unattended.
- 4) Always unplug heater when not in use.
- 5) Do not operate any heater with a damaged cord or plug or after the heater malfunctions, has been dropped or damaged in any manner, return heater to authorized service facility for examination, electrical or mechanical adjustment, or repair.
- 6) Do not use outdoors.
- 7) This heater is not intended for use in bathrooms, laundry areas and similar indoor locations. Never locate heater where it may fall into a bathtub or other water container.
- 8) Do not run cord under carpeting. Do not cover cord with throw rugs, runners, or similar coverings. Arrange cord away from traffic area and where it will not be tipped over.
- 9) To disconnect heater, turn controls to off, then remove plug from outlet.
- 10) Do not inset or allow foreign objects to enter any ventilation or exhaust opening as this may cause an electric shock or fire, or damage the heater.
- 11) To prevent a possible fire, do not block air intakes or exhaust in any manner. Do not use on soft surfaces, like a bed, where openings may become blocked.
- 12) A heater has hot and arcing or sparking parts inside. Do not use it in areas where gasoline, or flammable liquids are used or stored.
- 13) Use this heater only as describes in this manual. Any other use not recommended by the manufacturer may cause fire, electric shock, or injury to persons.
- 14) DANGER-HIGH Temperatures may be generated under certain abnormal conditions. Do not partially or fully cover or obstruct the front of this heater.
- 15) Replacement of the lamps should be done only while the heater is disconnected from the supply circuit.
- 16) This appliance is not intended for use by persons (including children) with reduced physical, sensory or capabilities, or lack of experience and knowledge, unless they have been given supervision or instruction concerning use of the appliance by a person responsible for their safety. Children should be supervised to ensure that they do not play with the appliance.
- 17) CAUTION: In order to avoid a hazard due to inadvertent resetting of the thermal cut-out, this appliance must not be supplied through an external switching device, such as a timer, or connected to a circuit that is regularly switched on and off by the utility.

UNPACKING AND TESTING APPLIANCE

Carefully remove the appliance from the box. Prior to installing the appliance, test to make sure the appliance operates properly by plugging the power supply cord into a conveniently located 110-120 Volt grounded outlet.

【Grounding Appliance】

This appliance is for use on 120 Volts. The cord has a plug as shown in (A). An adapter as shown in (C) is available for connecting three-blade grounding type plugs to two-slot receptacles. The green grounding lug extending from the adapter must be connected to a permanent ground such as a properly grounded outlet box. The adapter should not be used if a three-slot grounded receptacle is available.

To disconnect appliance, turn controls to off, then remove plug from outlet.

WARNING:

Keep the front of the appliance through which the heat is radiated at least 1 meter away from furniture, curtains and other flammable objects at all time.

Never use an extension lead. The mains cable must remain at the back of the appliance and must not be in contact with any hot elements.

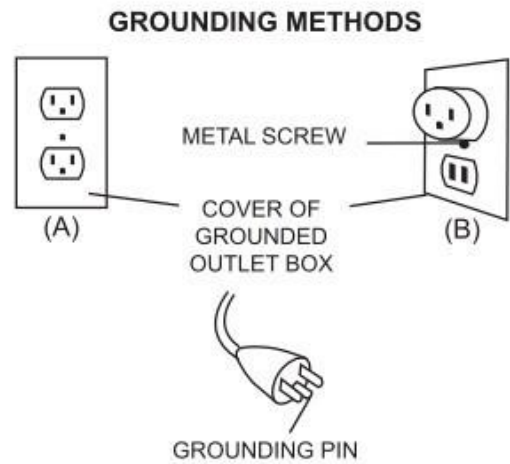

【INSTALLATION】



ALWAYS unplug this fireplace heater **before assembly** or **cleaning**, or **before relocating**. Failure to do so could result in **electric shock**, **fire**, or **personal injury**.

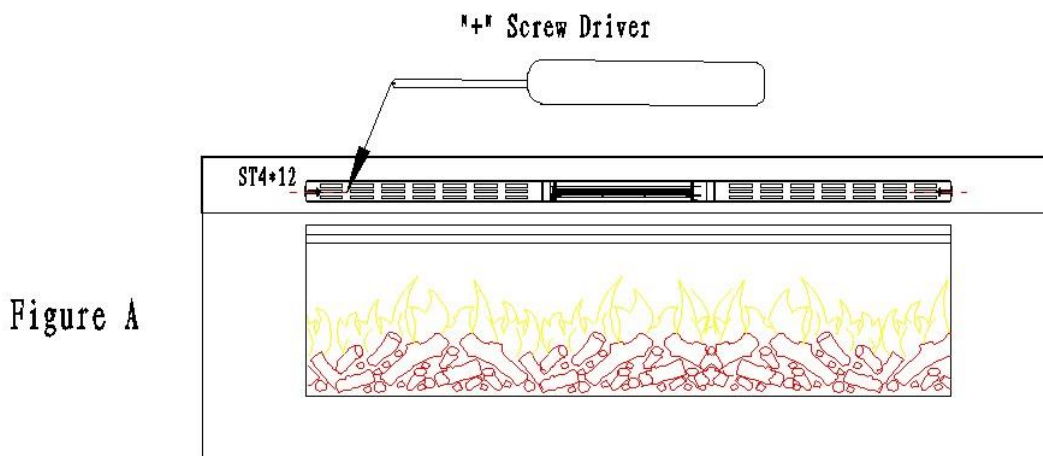
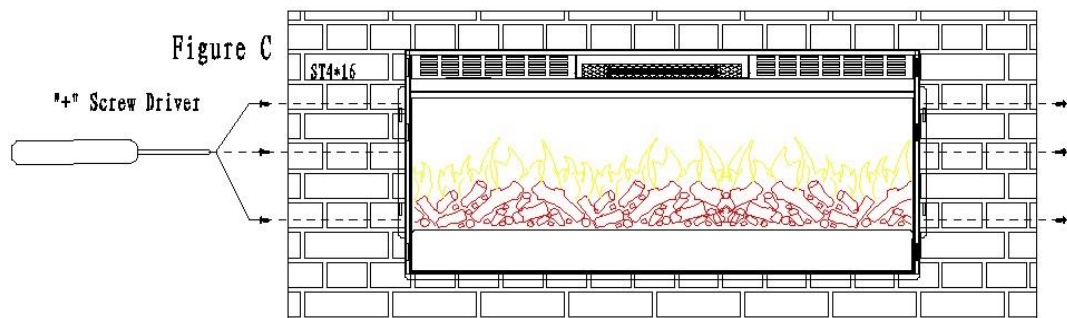
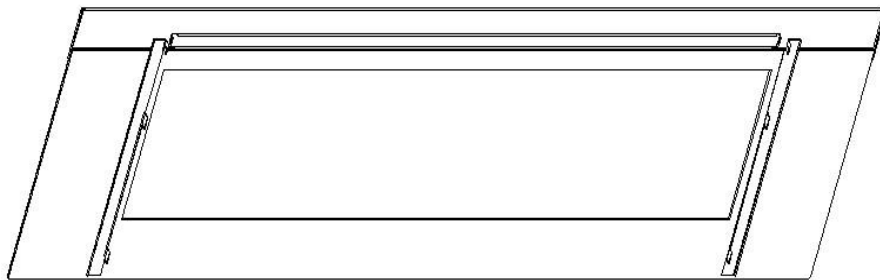

Figure A

Using the Philips Screw **Driver**"+" to take off the two screws in the front two sides **Figure (A)**, then have two people to take off the Glass Panel **Figure (B)**

Figure B



Put the Fireplace box into the wall, there're two hanger brackets in both sides of the fireplace box, using 6 pcs of **ST4X 16** screws(each side with 3 screws) to lock the fireplace in the wooden wall Figure (C)

Figure D

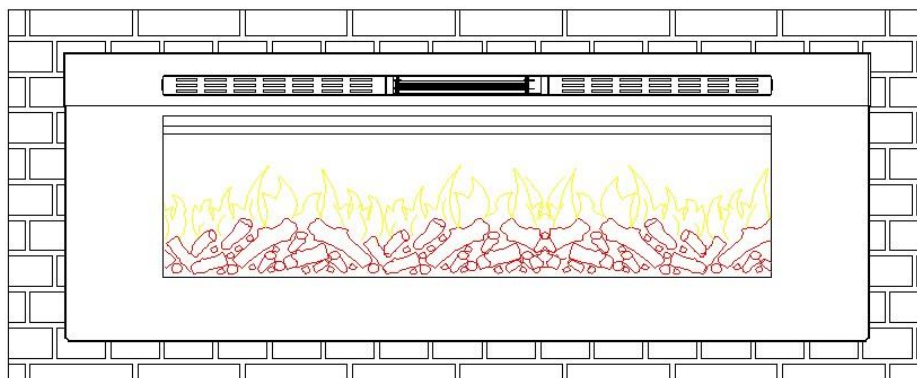

After firmly installed the Fireplace box, then move the Glass Panel back to the Fireplace box, using the two screws to lock in both sides Like Figure (A), the Fireplace will look like this after the installation see Figure (D)

Note: If your wall depth only 3.5-4 inch,pls install according to the following instruction

- 1) Taking the two metal strips in the cartons
- 2) Using ST4x8 screws to fix the metal strips,please refer the following drawing.

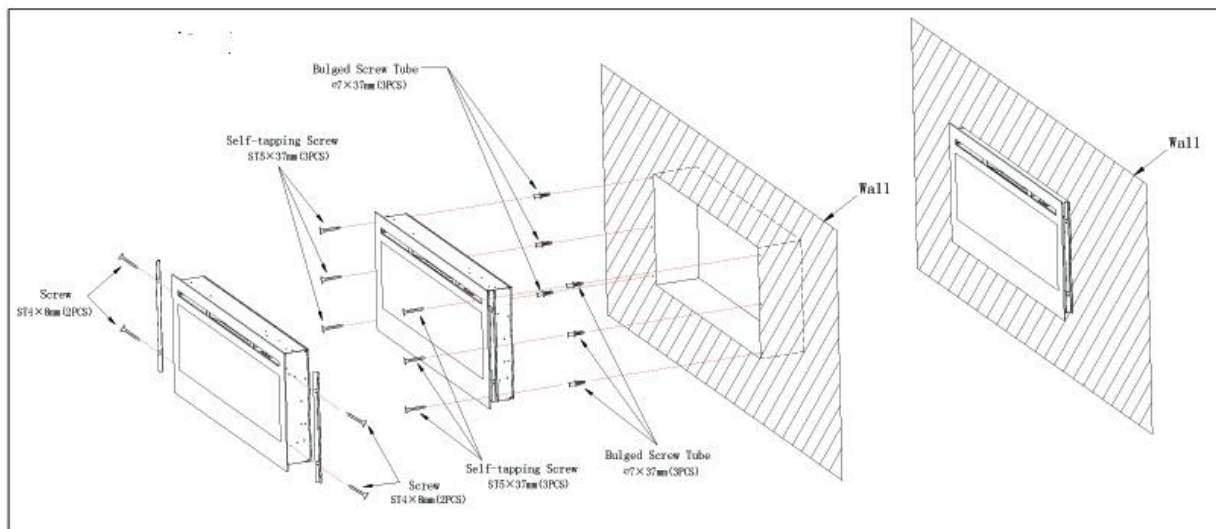

【Instruction for LOG, Rocks, Fireglass Media】

WARNING: Unplug the Fireplace before making any replacement

Take off the Front Glass panel before make replacement of LOG, Rocks, Or Glass Media. See Figure **(A,B)**

A. Using the Philips Screw **Driver" + "** to disassemble the two screws in both side of the fireplace box, then take out the LOG. Figure **(E)**

B. Put the Glass tray (included in carton) to the slot of the Fireplace, than laying the decorative Rocks or fireplace glass media (included in carton), Figure **(G,H)**

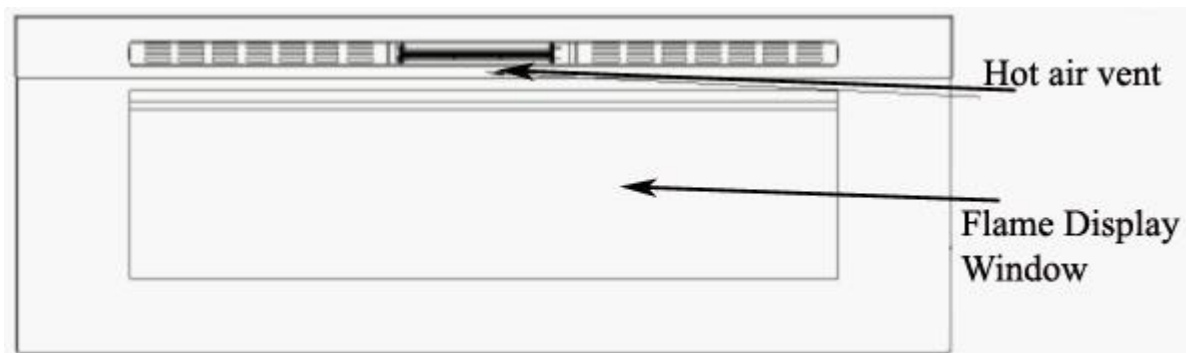
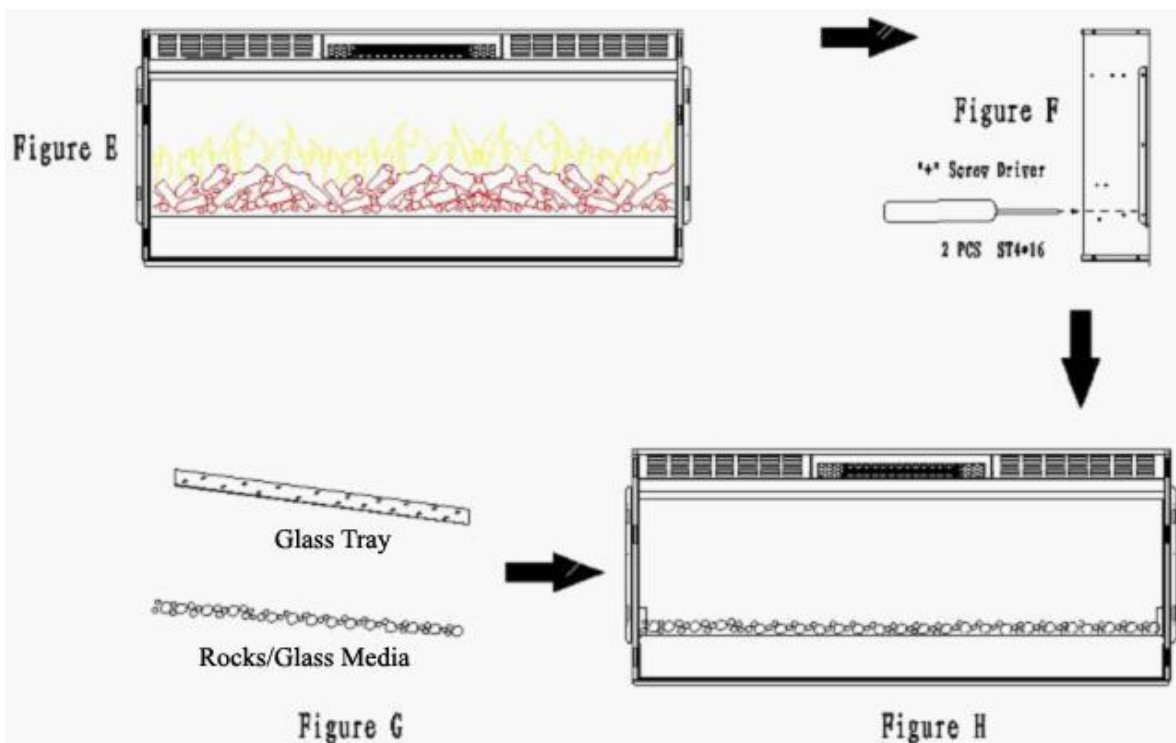

【Special characteristics of this Electric Fireplace】

- 1、 The smouldering glow of the flames can hardly be distinguished from that of a real fireplace.
- 2、 Produces the effect of a hot current of air.
- 3、 Automatic and constant temperature control.
- 4、 Fireplace can be both used as Wall Hanging and Build-in the wall
- 5、 Fireplace exchanged freely from LOG, Rocks and Glass Media
- 6、 Perfect for small to mid-sized rooms
- 7、 Timer (0.5hrs to 7.5hrs)
- 8、 Operated with remote control and Manual Panel Switch
- 9、 Dimmer (Five steps Flame adjust from Dimmer to Lighter)

【Safety instructions】

Only use the appliance in accordance with the instructions in this manual! It cannot be used for any other purpose.

Never operate the appliance when the appliance itself or the main cable show any signs of damage.

In order to avoid overheating, do not cover the heater.

Be responsible when handling the packing material. Warning: plastic wrapping may be lethal to children.
Do not place the appliance next to a socket.
Never operate the heater on a program switch, timer switch or any other appliance for automatic operation.
The heater is only suitable for indoor use.
Never use the heater in the bathroom, shower or near a swimming pool.
The heater must not be located immediately below a socket-outlet
If the supply cord is damaged, it must be replaced by the manufacturer or its service agent or a similarly qualified person in order to avoid a hazard.
Never leave small children unattended near the appliance.
In case of malfunction, disconnect the plug immediately.
When not in use for a considerable amount of time, unplug the appliance.
Components should only be be serviced by an approved electro technician.

【To switch on】

Plug in the appliance into the socket. Turn on the **Power Switch**
The control **Switch Panel** is under the Vent in front of the fireplace (**See pic**)

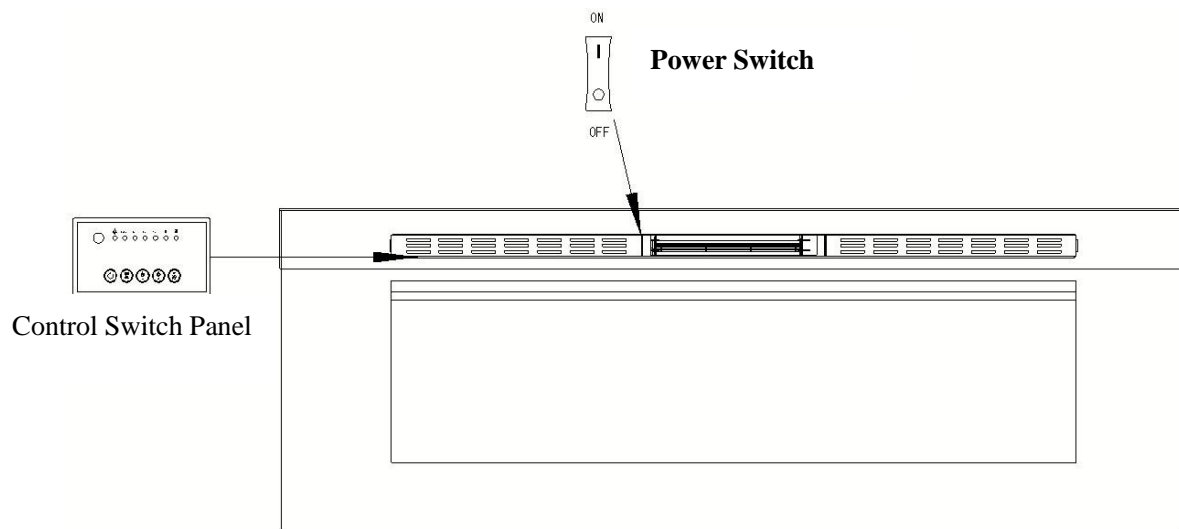

【Instruction for Remote Controller and Switch Panel】

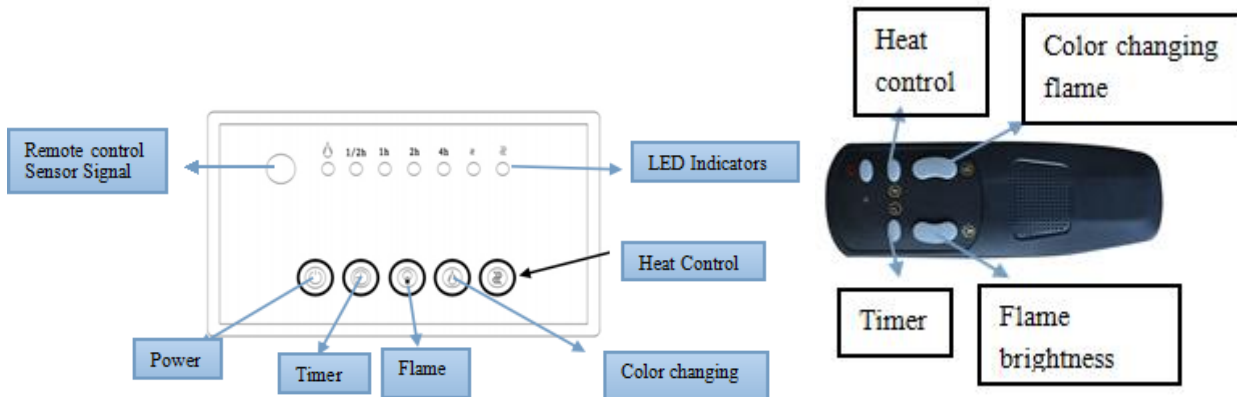

Remote Control & Switch Panel

Power switch Plug in power cord; the fireplace is now on standby mode. Press the power button once, the indicator lights up, Enjoy the view of the simulated charcoal lighting up and small flames in dancing tempo. Press the same power button again and the flames go off. The Fireplace is on standby mode again. Do not switch on fireplace when air outlets are blocked. Pressing air in 10 seconds.

Heat Control Press this button once and indicator lights up. Ten seconds after the mechanism is activated, warm air of 750W will be produced through the air outlets at the bottom. Press the same button again and the indicator lights up. The air outlets will produce hot air of 1400-1500W. Press the same button a third time, and the mechanism stops functioning after blowing out the remaining air in 10 seconds.

Simulated flames Press either the the  button, the indicator light will brighten up or dim the flames.

COLOR button: Press the  button, Makes the color flame effect changing. total 10 colors (yellow, red, green, blue, red+yellow, blue+yellow, red+green+yellow, blue+red+yellow, blue+green+yellow, red+blue+green+yellow)

Timer This sets the timing for switching the fireplace off automatically. The timer's duration ranges from 0.5 to 7.5 hours. The lighting up shown on the LED indicator indicates the setting of the timer.

Remote Control Device It is operated by AAA(#7) batteries (not included). Point it directly towards the fireplace and it functions within a distance of approx 3.5m. The functions are similar to that of the Control Panel.

【Cleaning the exterior of the appliance】

Before cleaning the appliance, disconnect it from the socket and leave to cool.

You can clean the exterior of the heater with a soft, damp cloth.

Do not use cleaning or polishing products.

【Manufacturers guarantee】

There is guarantee of one year. During this period, faulty components will be repaired or replaced free of charge, if the fault is due to a manufacturing defect.

In this case, consult the retailer where you have purchased the appliance.

(Below some more instructions for the approved electro technician who carries out maintenance or repairs to your Fireplace heater):

Appliance comes with the following led light :

PBG50B sixty-four 0.5W led light (max. 32W)

Technical data:

PBG50B

Rated Voltage: 120V~

Rated Frequency: 60Hz

Rated Power: 1500W

WEEE:



Meaning of crossed –out wheeled dustbin:

Do not dispose of electrical appliances as unsorted municipal waste, use separate collection facilities. Contact you local government for information regarding the collection systems available. If electrical appliances are disposed of in landfills or dumps, hazardous substances can leak into the groundwater and get into the food chain, damaging your health and well-being.

When replacing old appliances with new ones, the retailer is legally obligated to take back your old appliance for disposals at least free of charge.