



TDAS PLUS Level Trigger Device User's Manual



January 2015

Table of Contents

DTS Support 3

Introducing the TDAS PLUS Level Trigger Device..... 4

Control Panel 4

 Filter (Hz).....5

 G Level5

 Arm Mode5

 LED Indicators5

INTERFACE Connector 6

 Power Input6

 Event Outputs6

 External Arm Input.....6

 Accelerometer Data6

G SENSOR Connector 7

 External Accelerometer7

Basic Care and Handling..... 7

 Shock Rating7

Mounting Considerations8

 Thermal Considerations8

Power Management 8

Accelerometer Trigger Check..... 9

Appendix A: Connector Information..... 10

 Suggested Connector Sources10

Appendix B: Mechanical Specifications..... 11

Appendix C: Accelerometer Specifications..... 12

DTS Support

TDAS systems are designed to be reliable and simple to operate. Should you need assistance, DTS has support engineers worldwide with extensive product knowledge and crash test experience to help via telephone, e-mail or on-site visits.

The best way to contact a DTS support engineer is to submit a request through the DTS Help Center web portal (support.dtsweb.com). You must be registered (support.dtsweb.com/registration) to submit a request (<https://support.dtsweb.com/hc/en-us/requests/new>). Registration also enables access to additional self-help resources and non-public support information.

This manual supports the following products:

- 10100-00010: TDAS PLUS LTD (Level Trigger Device), external accel
- 10100-00020: TDAS PLUS LTD (Level Trigger Device), internal accel

Introducing the TDAS PLUS Level Trigger Device

The TDAS PLUS Level Trigger Device (LTD) is a crashworthy device that provides an opto-isolated, contact-closure event output when a predetermined acceleration threshold is exceeded. The TDAS PLUS LTD will initiate data collection or event trigger when used with TDAS PRO, TDAS G5, TDAS PLUS, or SLICE PRO equipment. The TDAS PLUS LTD can also be used with any other system or device capable of receiving a contact-closure event signal.

This manual discusses the features available with the TDAS PLUS LTD. To identify the specific hardware included with your system, please see your packing list.

- Built and tested for 100 g dynamic testing environments.
- User-selectable filter values, G levels, and arm mode.
- Overvoltage protection, overcurrent protection, power input polarity protection and event overvoltage protection.
- User-replaceable external accelerometer.
- Use with any TDAS PRO rack, TDAS G5 Vehicle Docking Station, TDAS PLUS Mini Distributor, fully-featured TDAS PLUS Distributor, SLICE PRO system or any other device capable of receiving a contact-closure event signal.
- Operates on nominal 12 VDC power (10-15 V range).
- Integral mounting flanges.

An interface cable appropriate for your application and feature set is typically provided with your unit. Please see your interface cable for the specific features included with your device.

Control Panel

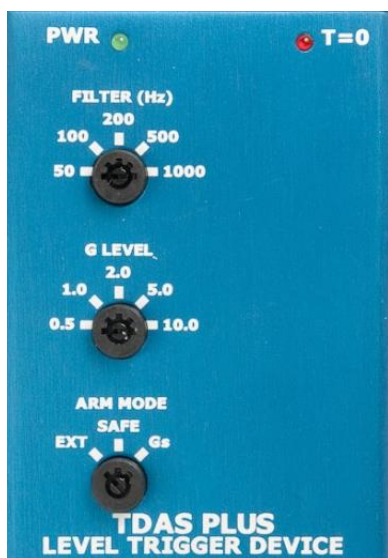

The control panel on the TDAS PLUS LTD allows you to select the operational parameters for the unit. Keys to change switch position are supplied with the unit, however a simple flat-head screwdriver can also be used. The keys must be removed from the unit prior to performing a test.

Filter (Hz)



Five filter options are available. Users should select the highest value appropriate for their application while keeping in mind that:

- The higher the value, the faster the response time,
- The lower the value, the less chance of a false trigger.

G Level



Five user-selectable G levels are available. Users should select the level appropriate for their application.

Arm Mode





There are three positions for this switch.

- EXT (external): Event output signal is only enabled when the unit receives an external signal.
- SAFE: Event output signal is disabled.
- Gs: The unit waits to sense the acceleration threshold (G Level) before sending an event signal.

| Arm Mode | | |
|--|----------|---------|
| EXT (external) | SAFE | Gs |
| Enabled only when external signal is present | Disabled | Enabled |

LED Indicators

The TDAS PLUS LTD has two LED indicators that provide power and acceleration threshold (G Level) information.

| LED Status |  |  * |
|------------|---|---|
| Off | No power, insufficient power, or external accelerometer is not connected | Acceleration threshold not reached |
| On | Power OK | Acceleration threshold reached or exceeded |

* Always enabled when unit is powered, regardless of Arm Mode (i.e., non-latching).

WARNING:

If the GREEN power LED on the TDAS PLUS LTD goes dark unexpectedly during the performance of a test, the test should be aborted if this can be done in a safe manner.

INTERFACE Connector



All functions, signals and power input are accessed via this connector. (See Appendix A for connector specifics and pin assignments.) An interface cable appropriate for your application and feature set is typically provided with your unit.

Power Input

The TDAS PLUS LTD does not contain an internal power source but has a dedicated connector on the interface cable for primary input power. An interface cable with the appropriate connector for your application is typically provided with your unit.

Event Outputs

Two opto-isolated, contact-closure event outputs are available via the INTERFACE connector. The first event output is always used with the G Level switch so that when the acceleration threshold is exceeded, a contact-closure event signal is sent to any attached equipment that can receive such a signal. The duration of the signal depends upon the length of time that the acceleration threshold is exceeded (i.e., as long as the T=0 LED is on). Depending on the requirements of your test environment, the second event output may also be included in the interface cable provided with your unit.

External Arm Input

An external arm input is available via the INTERFACE connector. Depending on the requirements of your test environment, this input may be included in the interface cable provided with your unit.

Accelerometer Data

Filtered and unfiltered accelerometer data are available for recording via the INTERFACE connector. (Filtered data is accomplished via a 2-pole Bessel filter.) Depending on the requirements of your test environment, one or both of these outputs may be included in the interface cable provided with your unit.

G SENSOR Connector

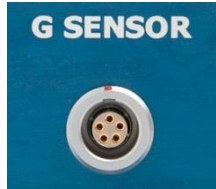

This connector is dedicated for use with the accelerometer provided with the unit. (See Appendix A for connector specifics and pin assignments.) If your unit has an internal accelerometer, you will not have this connector.

External Accelerometer

A mounting block is provided with your unit and is used to attach the accelerometer to the test fixture. Please see page 8 for information on the correct mounting orientation. A simple bench-top check-out procedure is included on page 9.

If the accelerometer becomes damaged, it can be replaced by the user or purchased from DTS. See Appendix C for accelerometer specifics and sourcing information.



Basic Care and Handling

The TDAS PLUS LTD is a precision device designed to operate reliably in dynamic testing environments. Though resistant to many environmental conditions, care should be taken not to subject the unit to harsh chemicals, submerge it in water, or drop it onto any hard surface.

WARNING:

Electronic equipment dropped from desk height onto a solid floor may experience as much as 10,000 g. Under these conditions, damage to the unit is likely.

When transporting the unit, treat it as you might a laptop computer and you should have no problems. When not in use or if shipping is required, we suggest that you always place the unit in the padded carrying case originally provided with your system.

The TDAS PLUS LTD is not user-serviceable and should be returned to the factory for service or repair. The external accelerometer, however, can be purchased separately and replaced by the user. See Appendix C for accelerometer specifics and sourcing information.

Shock Rating

The TDAS PLUS LTD is rated for and fully tested to 100 g, 12 ms duration, in all axes.

Mounting Considerations

The unit should be securely bolted to the vehicle, sled or other dynamic testing device to provide the best shock protection and facilitate proper grounding. Mounting methods and mounting bolt selection should be carefully calculated so as to withstand expected shock loading. (See Appendix B for the unit's mechanical specifications.)

The external accelerometer should be mounted on the test fixture in the sensitive axis as shown below.

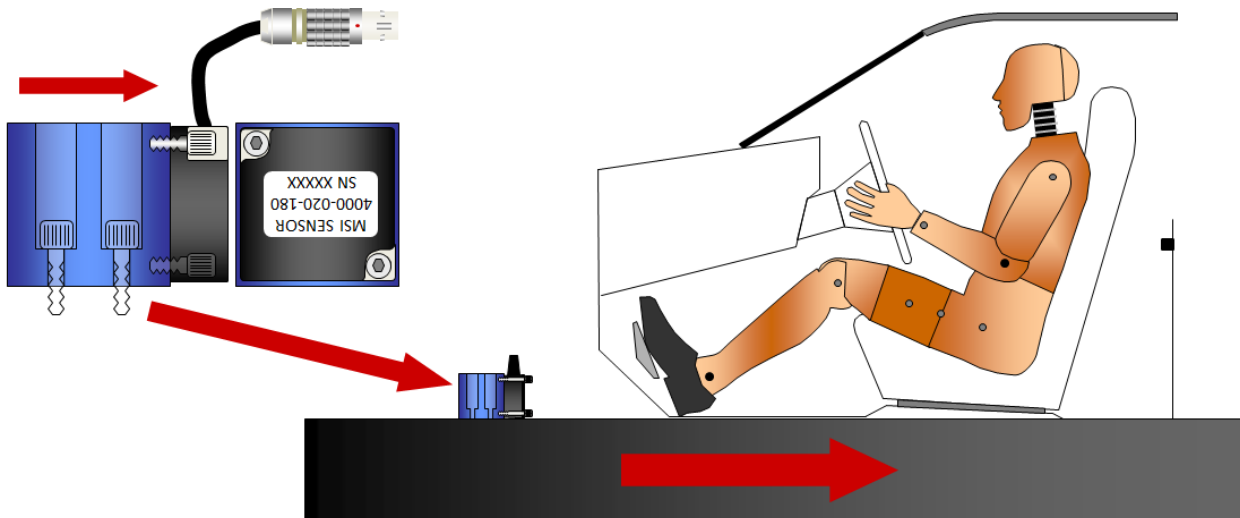

The LTD control box may be mounted in any orientation. If your unit contains an internal accelerometer, mount the unit with the IMPACT arrow in the proper orientation.

Thermal Considerations

It is extremely unlikely that excessive heating will ever be an issue in real-world testing applications using the TDAS PLUS LTD. Should you have any questions about its use in your environment, please contact DTS.

Power Management

The TDAS PLUS LTD does not contain an internal power source but has a dedicated primary power input on the interface cable. Power up and power down is immediate upon application or removal of the power source.

A good power source is of great importance. Each TDAS PLUS LTD should be powered from a fully-charged 12 V battery or high-quality power supply with a nominal output voltage of 12 V (10-15 V range) and a capacity of ≥ 50 mA. When assessing power requirements, please consider any voltage drops that may occur due to cables, connectors, etc.

A DAS channel from TDAS PRO SIM that supports 10 V excitation can also be used to operate the TDAS PLUS LTD. Contact DTS if you have any questions about using a TDAS PRO SIM to power your TDAS PLUS LTD.

Accelerometer Trigger Check

Use the following procedure to perform a bench-top check-out of the unit.

1. Set switches.
 - FILTER: Place in any position. (50 Hz will provide most stable setting for bench checks.)
 - G LEVEL: Perform test at 0.5 and 1.0 g.
 - ARM MODE: LED will indicate regardless of setting. Set to Gs to verify trigger to rack.
2. Rotate block >30 deg at 0.5 g setting.
 - LED will indicate when level is exceeded.
3. Rotate block 90 deg at 1.0 g setting.
 - LED will indicate when level is exceeded.
 - LED may not indicate a trigger at 90 deg (1 g) without additional stimulus in the sensitive axis.

Appendix A: Connector Information

12-pin INTERFACE connector
(EGG.2B.312.CLL)

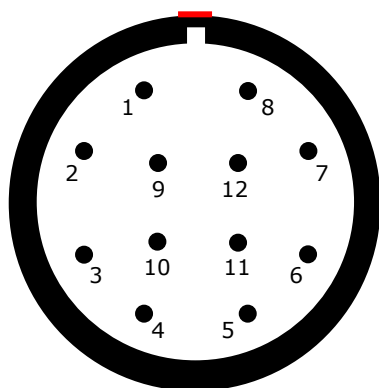

(panel view)

Suggested cable connector P/N:
FGG.2B.312.CLADxx*

| Pin | Function |
|--------|--|
| 1 | + Power in (10-15 VDC) |
| 2 | - Power in |
| 3 | + Event out 1 |
| 4 | - Event out 1 |
| 5 | + Event out 2 |
| 6 | - Event out 2 |
| 7 | External arm input (+5 VDC) |
| 8 | Common |
| 9 | + Sensor output, unfiltered (100 mV/g) |
| 10 | + Sensor output, filtered (100 mV/g) |
| 11, 12 | Reserved |

5-pin G SENSOR connector
(EGG.1B.305.CLL)

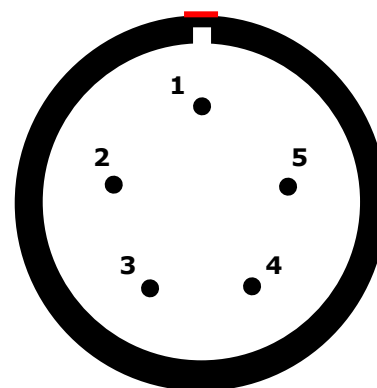

(panel view)

Suggested cable connector P/N:
FGG.1B.305.CLADxx*

| Pin | Function |
|-----|--------------------------|
| 1 | + Power out (VDC) |
| 2 | - Power out (VDC) |
| 3 | Sensor input (100 mV/g) |
| 4 | Sensor reference (2.5 V) |
| 5 | Shield (case) |

* xx denotes diameter of cable to be used; e.g., 52 = 5.2 mm. See www.lemo.com for more information.

Suggested Connector Sources

DTS uses LEMO connectors on the TDAS PLUS LTD. If you need to purchase connectors, we suggest first going to LEMO directly (<http://www.lemo.com/index.html>). Their web site and worldwide sales team are very helpful. Should you have difficulty obtaining a specific part number, they can suggest connector variations or alternates and explain options that may be useful for your particular application. Another U.S. source is Alpine Electronics (www.alpine-electronics.com) in San Jose, California. They are a stocking distributor for LEMO and LEMO-compatible connectors.

Appendix B: Mechanical Specifications

Weight: ~278 grams (without accelerometer assembly and cable)

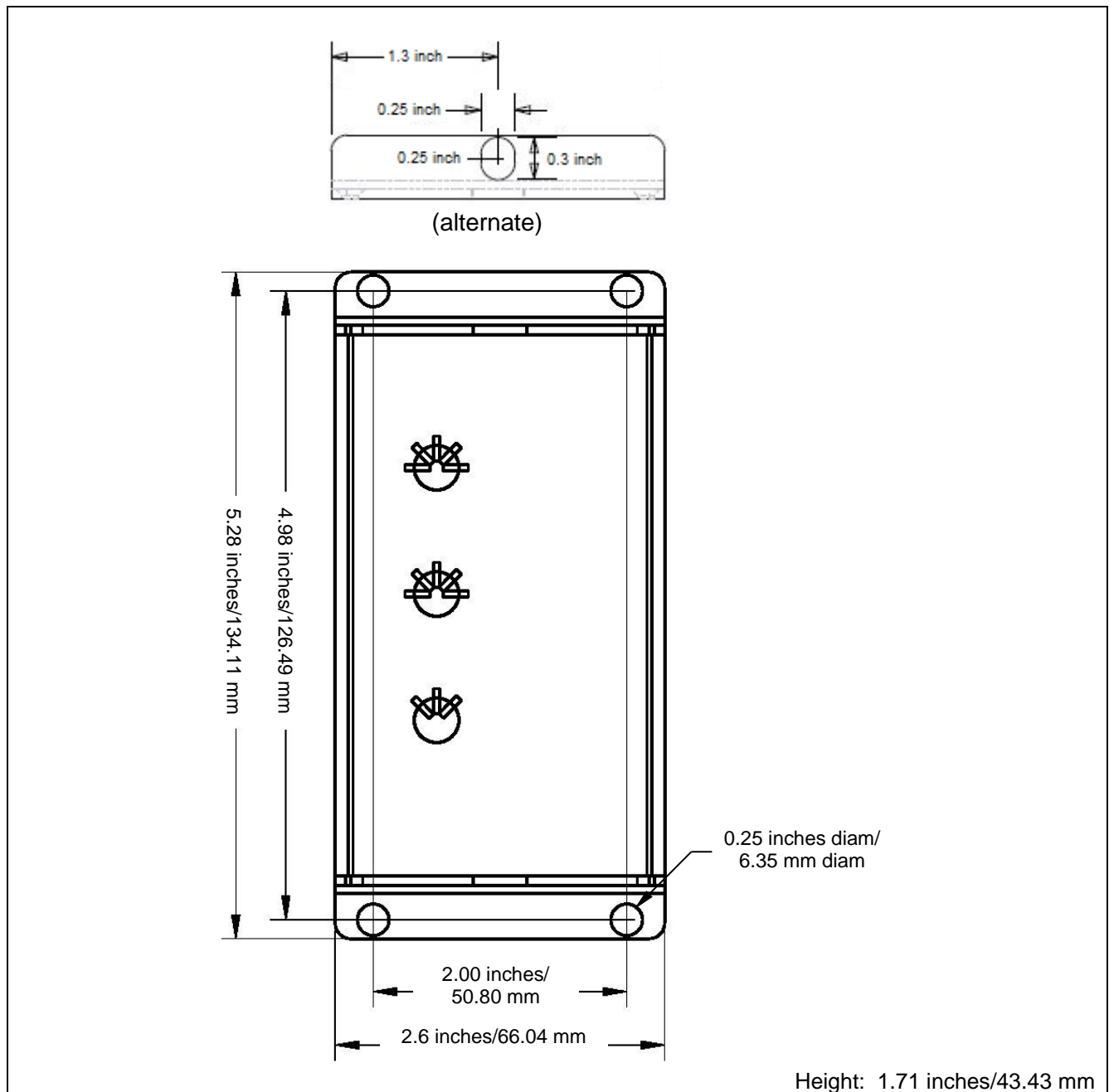

Accessories/support equipment:

- 10100-00030: TDAS PLUS LTD External Accel (15 ft, pigtail termination)
- 10100-00040: TDAS PLUS LTD External Accel (15 ft, LEMO termination)
- 10100-00050: Cable, TDAS LTD interface (3 m, pigtail termination)
- 89100-11240: TDAS LTD accelerometer mounting block

Model 4000A Accelerometer



Silicone MEMS Accelerometer
Signal Conditioned Output
Temperature Calibrated
Low Cost, Lightweight



The **Model 4000A** is an economical signal conditioned accelerometer with integral temperature compensation. The accelerometer incorporates a 3rd generation silicon MEMS sensor providing outstanding performance. The accelerometer is packaged in a rugged aluminum housing ideal for transportation and instrumentation testing. The signal conditioned output incorporates a 2.5V reference that offers the user a differential or single-ended output.

dimensions

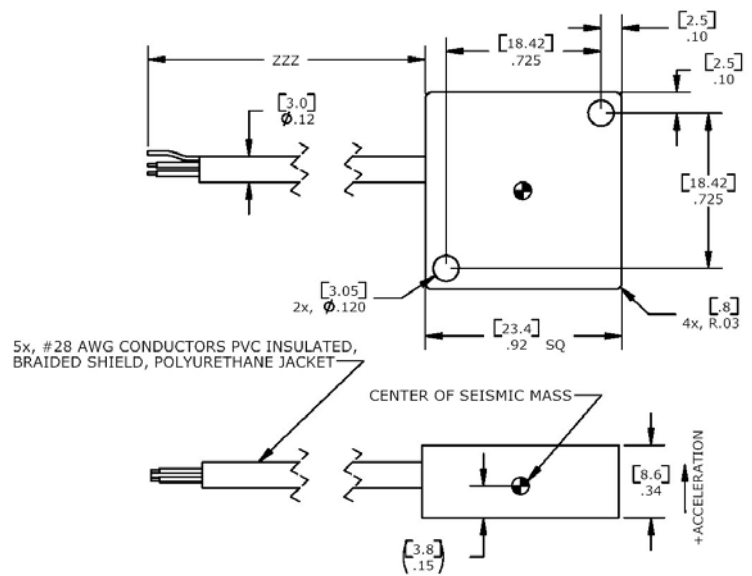

FEATURES

- $\pm 2g$ to $\pm 200g$ Dynamic Range
- High Over-Range Protection
- Signal Conditioned Output
- Low Power Consumption
- Lightweight
- Gas Damping
- 8 to 36Vdc Excitation Voltage

APPLICATIONS

- Low Frequency Monitoring
- Transportation
- Vibration Sensing
- Test & Instrumentation
- Machine Control
- Motion Analysis
- Tilt

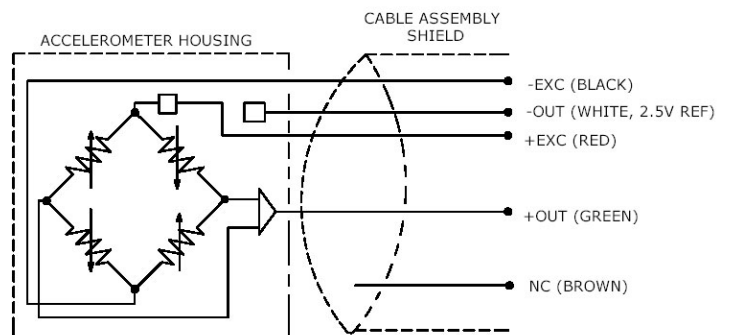

Model 4000A Accelerometer

performance specifications

All values are typical at +24°C, 100Hz and 12Vdc excitation unless otherwise stated. Measurement Specialties reserves the right to update and change these specifications without notice.

| Parameters | | | | | | | | Notes |
|----------------------------------|---|---|---------|---------|---------|---------|---------|--------------|
| DYNAMIC | | | | | | | | |
| Range (g) | ±2 | ±5 | ±10 | ±20 | ±50 | ±100 | ±200 | |
| Sensitivity (mV/g) | 1000 | 400 | 200 | 100 | 40 | 20 | 10 | |
| Frequency Response (Hz) | 0-200 | 0-300 | 0-350 | 0-600 | 0-800 | 0-1300 | 0-1500 | ±5% |
| Natural Frequency (Hz) | 700 | 800 | 1000 | 1500 | 4000 | 6000 | 8000 | |
| Non-Linearity (%FSO) | ±0.5 | ±0.5 | ±0.5 | ±0.5 | ±0.5 | ±0.5 | ±0.5 | |
| Transverse Sensitivity (%) | <3 | <3 | <3 | <3 | <3 | <3 | <3 | <1 Typical |
| Damping Ratio | 0.7 | 0.7 | 0.7 | 0.7 | 0.7 | 0.7 | 0.6 | |
| Shock Limit (g) | 5000 | 5000 | 5000 | 5000 | 5000 | 5000 | 5000 | |
| ELECTRICAL | | | | | | | | |
| Zero Acceleration Output (mV) | ±100 | ±100 | ±100 | ±100 | ±100 | ±100 | ±100 | Differential |
| Excitation Voltage (Vdc) | 8 to 36 | 8 to 36 | 8 to 36 | 8 to 36 | 8 to 36 | 8 to 36 | 8 to 36 | |
| Excitation Current (mA) | <5 | <5 | <5 | <5 | <5 | <5 | <5 | |
| Bias Voltage (Vdc) | 2.5 | 2.5 | 2.5 | 2.5 | 2.5 | 2.5 | 2.5 | |
| Output Resistance (Ω) | <100 | <100 | <100 | <100 | <100 | <100 | <100 | |
| Insulation Resistance (MΩ) | >100 | >100 | >100 | >100 | >100 | >100 | >100 | @100Vdc |
| Turn On Time (msec) | <100 | <100 | <100 | <100 | <100 | <100 | <100 | |
| Residual Noise (µV RMS) | 500 | 300 | 300 | 350 | 400 | 350 | 400 | Passband |
| Ground Isolation | Isolated from Mounting Surface | | | | | | | |
| ENVIRONMENTAL | | | | | | | | |
| Thermal Zero Shift (%FSO/°C) | ±0.014 | ±0.014 | ±0.014 | ±0.014 | ±0.014 | ±0.014 | ±0.014 | Typical |
| Thermal Sensitivity Shift (%/°C) | ±0.028 | ±0.028 | ±0.028 | ±0.028 | ±0.028 | ±0.028 | ±0.028 | Typical |
| Operating Temperature (°C) | -20 to 85 | | | | | | | |
| Compensated Temperature (°C) | -20 to 85 | | | | | | | |
| Storage Temperature (°C) | -40 to 90 | | | | | | | |
| PHYSICAL | | | | | | | | |
| Case Material | Anodized Aluminum | | | | | | | |
| Cable | PVC Insulated Leads, Braided Shield, PU Jacket | | | | | | | |
| Weight (grams) | 7 | | | | | | | |
| Mounting | 2x #4 or M3 Screws | | | | | | | |
| Mounting Torque | 3 lb-in (0.3 N-m) | | | | | | | |
| AWG | #28 | | | | | | | |
| Wiring color code: | +Excitation = Red; -Excitation = Black; +Output = Green; -Output = White; Programming = Brown (brown wire is used for programming and is not to be connected) | | | | | | | |
| Optional accessories: | AC-D02652 | Triaxial Mounting Block | | | | | | |
| | 101 | Three Channel DC Signal Conditioner Amplifier | | | | | | |

The information in this sheet has been carefully reviewed and is believed to be accurate; however, no responsibility is assumed for inaccuracies. Furthermore, this information does not convey to the purchaser of such devices any license under the patent rights to the manufacturer. Measurement Specialties, Inc. reserves the right to make changes without further notice to any product herein. Measurement Specialties, Inc. makes no warranty, representation or guarantee regarding the suitability of its product for any particular purpose, nor does Measurement Specialties, Inc. assume any liability arising out of the application or use of any product or circuit and specifically disclaims any and all liability, including without limitation consequential or incidental damages. Typical parameters can and do vary in different applications. All operating parameters must be validated for each customer application by customer's technical experts. Measurement Specialties, Inc. does not convey any license under its patent rights nor the rights of others.

ordering info

PART NUMBERING Model Number+Range+ Cable Length

4000A-GGG-CCC
 | |
 | | Cable (060 is 60 inches)
 | Range (020 is 20g)

Example: 4000A-020-060
 Model 4000A, 20g, 60" (5ft) Cable

Model 4000 Accelerometer

Piezoresistive MEMS Accelerometer

Signal Conditioned Output

Temperature Calibrated

Low Cost, Light Weight

DESCRIPTION

The **Model 4000** is an economical signal conditioned accelerometer with integral temperature compensation. The accelerometer incorporates a 2nd generation piezoresistive MEMS sensor providing outstanding performance. The accelerometer is packaged in a light weight thermoplastic housing ideal for transportation and instrumentation testing. The signal conditioned output incorporates a 2.5V reference that offers the user a differential or single-ended output.

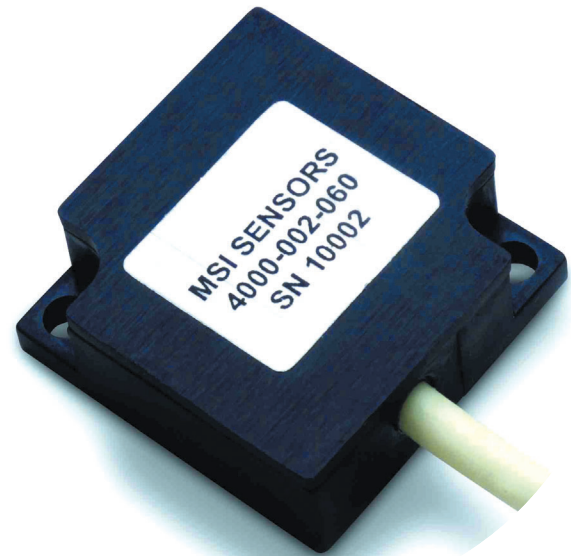

FEATURES

- ◆ $\pm 2g$ to $\pm 200g$ Dynamic Range
- ◆ High Over-Range Protection
- ◆ Signal Conditioned Output
- ◆ Low Power Consumption
- ◆ Light Weight Plastic Housing
- ◆ Gas Damping
- ◆ Integral Cable – Connector Options

APPLICATIONS

- ◆ Low Frequency Monitoring
- ◆ Transportation
- ◆ Vibration Sensing
- ◆ Test & Instrumentation

dimensions

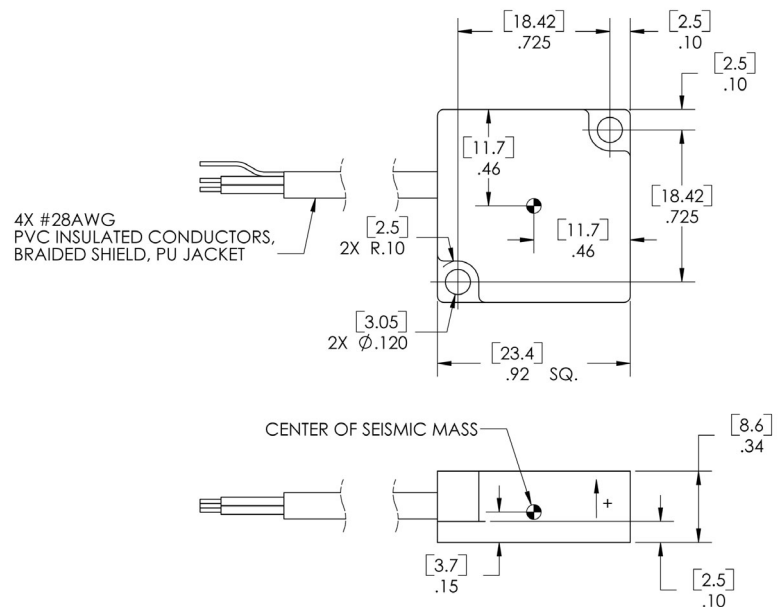

Measurement Specialties, Inc.
1000 Lucas Way
Hampton, VA 23666 USA
www.meas-spec.com

Customer Service:
Tel: 1-757-766-1500 (Toll Free:
1-800-745-8008)
Fax: 1-757-766-4297

Vibration Sensors Technical
Support:
Tel: 1- 949-716-5377
Fax: 1- 949-916-5677
Email: vibration@meas-spec.com
RevA 1/19/06

measurement
SPECIALTIES

Model 4000 Accelerometer

performance specifications

All values are typical at 25°C, 100Hz and 12Vdc excitation unless otherwise stated. Measurement Specialties reserves the right to update and change these specifications without notice.

Parameters

| DYNAMIC | | | | | | |
|--|--------|--------|--------------------------------|-------|----------|-------------------------|
| Range | ±2 | ±5 | ±10 | ±20 | Units | Notes |
| Sensitivity | 1000 | 400 | 200 | 100 | mV/g | |
| Frequency Response | 0-250 | 0-400 | 0-500 | 0-800 | Hz | ±5% |
| | | | | | | |
| Range | ±50 | ±100 | ±200 | | Units | Notes |
| Sensitivity | 40 | 20 | 10 | | mV/g | |
| Frequency Response | 0-1000 | 0-1500 | 0-1500 | | Hz | ±5% |
| Non-Linearity | | | ±1 | | % FSO | Maximum |
| Transverse Sensitivity (Max) | | | ±3 | | % | ±1% Typical |
| Zero Acceleration Output | | | 2.50±.05 | | V | |
| Thermal Zero Shift (-20 to +85°C) | | | ±.028 | | % FSO/°C | Maximum |
| Thermal Sensitivity Shift (-20 to +85°C) | | | ±.028 | | %/°C | Maximum |
| ELECTRICAL | | | | | | |
| Excitation Voltage | | | 10 to 24 | | Vdc | |
| Excitation Current | | | 5.0 | | mA | Typical |
| Reference Voltage | | | 2.5 | | Vdc | |
| Output Impedance | | | 100 | | Ω | Maximum |
| Insulation Resistance (@ 50Vdc) | | | 100 | | MΩ | Minimum |
| Ground Isolation | | | Isolated | | | |
| PHYSICAL | | | | | | |
| Housing | | | High Performance Thermoplastic | | | |
| Weight (cable not included) | | | 8 | | grams | Maximum |
| Mounting | | | 2x #4 or M3 Screws | | | 3 lb-in mounting torque |
| ENVIRONMENTAL | | | | | | |
| Shock Limit | | | 5,000 | | g's | |
| Operating Temperature | | | -20 to +85 | | °C | |
| Humidity | | | Epoxy Sealed | | | |

Contact factory for custom temperature compensation options.

electrical schematic

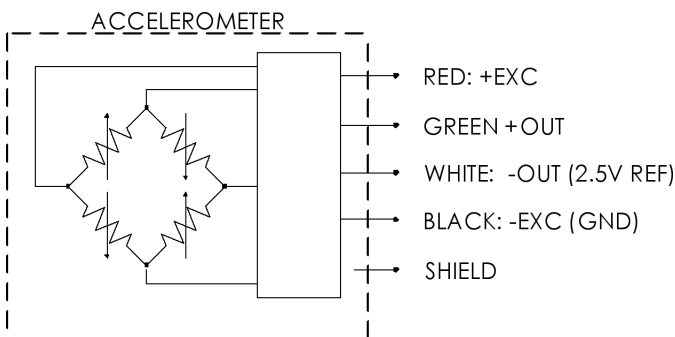

ordering information

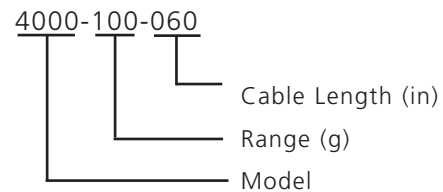

Measurement Specialties, Inc.
1000 Lucas Way
Hampton, VA 23666 USA
www.meas-spec.com

Vibration Sensors Technical
Support:
Tel: 1- 949-716-5377
Fax: 1- 949-916-5677
Email: vibration@meas-spec.com

Customer Service:
Tel: 1-757-766-1500 (Toll Free:
1-800-745-8008)
Fax: 1-757-766-4297

Revision History

| Date | By | Description |
|-------------|----|---|
| 9 Jan 2015 | EK | Corrected 5-pin G SENSOR pin assignments (Appendix A). Moved section on LED Indicators. Added TDAS PRO SIM to External Power Provisions. Added Accelerometer Trigger Check section. Added photos. Added alternate mounting hole information. Added Accessories/Support Equipment. Revised DTS Support boilerplate. Revised doc format. Other minor updates. (Rev 1) |
| 31 Jan 2006 | EK | Initial release. (Rev 0) |