

**V3
FINAL
FOR PRINT**

NS-R5111_14-0824_MAN_V3_ENG.fm Page 1 Thursday, August 14, 2014 6:33 PM

USER GUIDE

INSIGNIA™ Armband Radio NS-R5111



Before using your new product, please read these instructions to prevent any damage.

INSIGNIA™ NS-R5111 Arm Band Radio

NS-R5111 Arm Band Radio

Welcome

Congratulations on your purchase of a high-quality Insignia product. Your NS-R5111 arm band radio represents the state of the art in design and reliable, trouble-free performance.

Contents

Features	2
Using your arm band radio	4
Specifications	11
Troubleshooting	11
Legal notices	13
ONE-YEAR LIMITED WARRANTY - INSIGNIA	15

Features

The NS-R5111 Arm Band Radio features:

- AM/FM digital radio
- Stereo or Mono listening modes
- Easy preset digital tuning and up to 10 FM and 10 AM memory presets
- Wearable oval design for arm band and belt-holder use
- Stereo headphones



NS-R5111 Arm Band Radio

INSIGNIA™



Package contents:

- Arm band radio
- Headphones
- AAA batteries (2)
- Belt clip
- *User Manual*

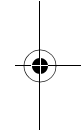
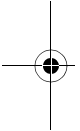

www.insigniaproducts.com

3

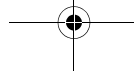

INSIGNIA™ NS-R5111 Arm Band Radio

Using your arm band radio

Controls

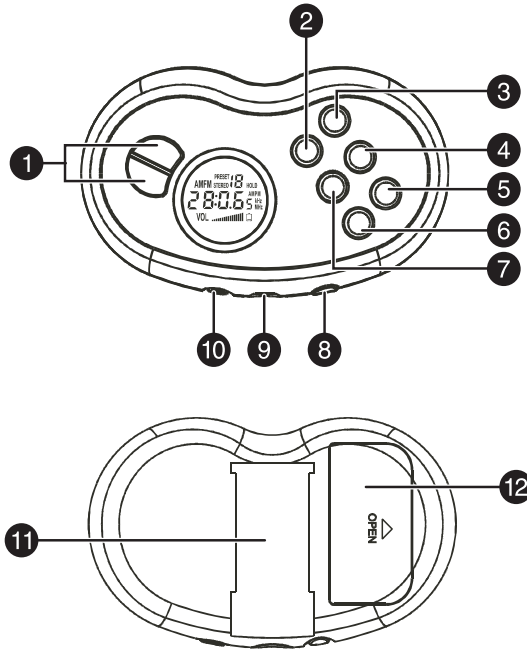

NS-R5111 Arm Band Radio

INSIGNIA™

#	Item
1	Volume control button
2	STEREO/TIME SET button
3	BAND (AM/FM) button
4	MEMORY button
5	TUN UP (hour) button
6	TUN DN (minute) button
7	PRESET button
8	ON/OFF button
9	Phone jack
10	HOLD switch
11	Belt clip
12	Battery compartment

INSIGNIA™ NS-R5111 Arm Band Radio

Display

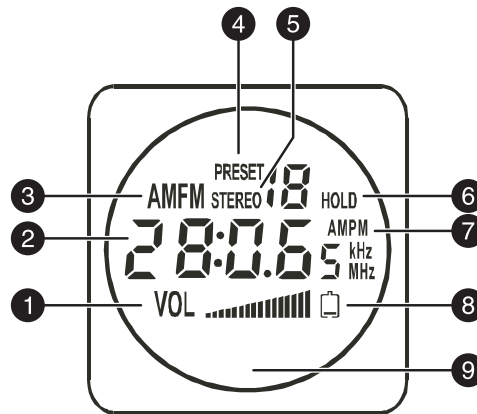

#	Item
1	Volume level indicator
2	Radio frequency
3	AM/FM indicator
4	Preset indicator
5	FM stereo indicator
6	Hold indicator
7	AM/PM indicator
8	Low battery indicator
9	LCD display

NS-R5111 Arm Band Radio

INSIGNIA™

Installing the batteries

To install the batteries:

- 1 Open the battery compartment door located on the back of your radio.
- 2 Insert two AAA batteries, making sure that the + and – on the batteries match the + and – inside the battery compartment.
- 3 Replace the battery compartment door.

Flashing low battery alert

If the low battery indicator on the LCD starts flashing, the batteries should be replaced. Replace batteries when required. When not using your radio for an extended period of time, remove the batteries.

- Do not mix old and new batteries.
- Do not mix alkaline, standard (carbon-zinc), or rechargeable (nickel-cadmium) batteries.
- Dispose of batteries according to local environmental laws.

Operating your radio

To operate your arm band radio:

- 1 Press the **ON/OFF** button to turn on the radio.
- 2 Press the **BAND** button to select **AM** or **FM**.
- 3 Insert the headphone plug into the Phone Jack.

Note

Your earphone soft wire works as the antenna for FM reception. You may need to extend the wire to obtain the best reception.

INSIGNIA™

NS-R5111 Arm Band Radio

To listen to your radio:

- 1 Press and release the **TUN UP** or **TUN DN** button to go to the next radio station.
- 2 Press and hold the **TUN UP** or **TUN DN** button to scan for the next radio station with clear reception.
- 3 Press the volume control button **+** or **-** to adjust the volume.
- 4 Press and release the **STEREO/TIME SET** button to select **Stereo** or **Mono** mode.

Note

Stereo mode is only available when listening to FM radio stations.

To manually store stations:

- 1 Press the **BAND** button to select **AM** or **FM**.
- 2 Press the **TUN UP** or **TUN DN** button to select the radio station you want.
- 3 Press the **MEMORY** button. The PRESET Indicator on the LCD flashes.
- 4 Press the **PRESET** button to select the preset channel you want.
- 5 Press the **MEMORY** button again to store the station as a preset.
- 6 Repeat Steps 1 to 5 to store additional stations.

Note

You can store up to 10 AM and 10 FM radio stations into preset numbers (erasing any preset stations).

NS-R5111 Arm Band Radio

INSIGNIA™

To recall preset stations within the selected band:

- 1 Press the **PRESET** button.
- 2 Press the **TUN UP** or **TUN DN** button to change to a different stored station.

When the batteries are low, the LCD will start flashing and eventually shut off.

- Press the **ON/OFF** button to turn off the radio, then replace the batteries.

Note

Time must be reset after you change the batteries.

Using Hold

To use the Hold feature:

- 1 Set the **HOLD** switch to **ON** and all buttons will be disabled. The Hold indicator appears on the LCD.
- 2 Set the **HOLD** switch to **OFF** to enable all buttons.

Setting the time

To set the time during power off mode:

- 1 Press and hold the **STEREO/TIME SET** button.
- 2 Press the **TUN UP** button (hour) to set the hour, then press the **TUN DN** button (minute) to set the minute.

INSIGNIA™ NS-R5111 Arm Band Radio

- 3 Press and hold the **STEREO/TIME SET** button to exit Time Set mode.

Note

You cannot set the time during power on mode.

Using the belt clip

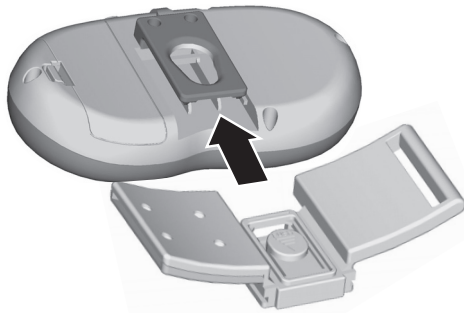

To release the belt clip:

- Pull the top end of the belt clip outward, then hold it and slide it down gently.

NS-R5111 Arm Band Radio



Specifications

Frequency range	AM 530-1710 kHz FM 87.5-107.9 MHz
Antenna	AM ferrite bar antenna FM headphones' Cord
10% THD	Headphones 15 mW +15 mW
Battery	3V DC (1.5V x 2) AAA
Accessories	Headphones Strap AAA (2) Alkaline mercury-free battery

Note: Design and specifications are subject to change without notice.

Troubleshooting

Problem	Solution
The sound is weak or interrupted, or poor reception.	Batteries may be weak. Sound/reception may be affected if you are in a vehicle or in a building. Move closer to a window to improve reception.
Display is dim.	Batteries may be weak. Also, your radio may be affected by extremely high or low temperatures or excessive moisture.
There is no power.	The batteries are dead. Replace the batteries.

INSIGNIA™ NS-R5111 Arm Band Radio

Safe sound levels*

To establish a safe sound level:

- Start with the volume control at a low setting.
- Slowly increase the sound until you can hear it comfortably and clearly, without distortion.
- Avoid prolonged exposure to excessive noise.

Level Example

30	Quiet Library, soft whispers
40	Living room, refrigerator, bedroom away from traffic
50	Light traffic, normal conversation, quiet office
60	Air conditioner at 20 feet, sewing machine
70	Vacuum cleaner, hair dryer, noisy restaurant
80	Average city traffic, garbage disposals, alarm clock at two feet



The following noise levels can be dangerous with constant exposure:

90	Subway, motorcycle, truck traffic, lawn mower
100	Garbage truck, chain saw, pneumatic drill
120	Rock band concert in front of speakers, thunderclap
140	Gunshot blast, jet engine
180	Rocket launching pad



**Information courtesy of the Deafness Research Foundation.*

NS-R5111 Arm Band Radio

INSIGNIA™

Legal notices

Modifications not authorized by the manufacturer may void users authority to operate this device.

This equipment has been tested and found to comply with the limits for a Class B digital device, pursuant to Part 15 of the FCC Rules. These limits are designed to provide reasonable protection against harmful interference in a residential installation. This equipment generates, uses and can radiate radio frequency energy and, if not installed and used in accordance with the instructions, may cause harmful interference to radio communications. However, there is no guarantee that interference will not occur in a particular installation. If this equipment does cause harmful interference to radio or television reception, which can be determined by turning the equipment off and on, the user is encouraged to try to correct the interference by one or more of the following measures:

- Reorient or relocate the receiving antenna.
- Increase the separation between the equipment and receiver.
- Connect the equipment into an outlet on a circuit different from that to which the receiver is connected.
- Consult the dealer or an experienced radio/TV technician for help.
- Place the unit on a stable surface. Avoid installing the unit in locations described below:
 - Direct sunlight or close to appliances that radiate heat, such as electric heaters.
 - On top of other stereo equipment that radiates heat.
 - Unventilated or dusty places.
 - Places subject to constant vibration.
 - Humid or moist places.



INSIGNIA™

NS-R5111 Arm Band Radio



FCC Statement

This device complies with Part 15 of the FCC Rules. Operation is subject to the following two conditions:

- 1) This device may not cause harmful interference, and
- 2) This device must accept any interference received, including interference that may cause undesirable operation.

This Class B digital apparatus complies with Canadian ICES-003.

Copyright

Insignia is a trademark of Best Buy and its affiliated companies. Registered in some countries. Distributed by Best Buy Purchasing, LLC.

7601 Penn Ave South, Richfield, MN 55423 U.S.A.

©2014 Best Buy. All rights reserved.

Made in China

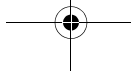
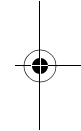
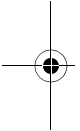

NS-R5111 Arm Band Radio

INSIGNIA™

ONE-YEAR LIMITED WARRANTY - INSIGNIA

Definitions:

The Distributor* of Insignia branded products warrants to you, the original purchaser of this new Insignia-branded product ("Product"), that the Product shall be free of defects in the original manufacturer of the material or workmanship for a period of one (1) year from the date of your purchase of the Product ("Warranty Period").

For this warranty to apply, your Product must be purchased in the United States or Canada from a Best Buy branded or Future Shop branded retail store or online at www.bestbuy.com, www.bestbuy.ca, or www.futureshop.ca and is packaged with this warranty statement.

How long does the coverage last?

The Warranty Period lasts for 1 year (365 days) from the date you purchased the Product. Your purchase date is printed on the receipt you received with the Product.

What does this warranty cover?

During the Warranty Period, if the original manufacture of the material or workmanship of the Product is determined to be defective by an authorized Insignia repair center or store personnel, Insignia will (at its sole option): (1) repair the Product with new or rebuilt parts; or (2) replace the Product at no charge with new or rebuilt comparable products or parts. Products and parts replaced under this warranty become the property of Insignia and are not returned to you. If service of Products or parts are required after the Warranty Period expires, you must pay all labor and parts charges. This warranty lasts as long as you own your Insignia Product during the Warranty Period. Warranty coverage terminates if you sell or otherwise transfer the Product.

www.insigniaproducts.com

15

INSIGNIA™ NS-R5111 Arm Band Radio

How to obtain warranty service?

If you purchased the Product at a Best Buy or Future Shop retail store location, please take your original receipt and the Product to any Best Buy or Future Shop store. Make sure that you place the Product in its original packaging or packaging that provides the same amount of protection as the original packaging. If you purchased the Product from a Best Buy or Future Shop online web site (www.bestbuy.com, www.bestbuy.ca, or www.futureshop.ca), mail your original receipt and the Product to the address listed on the web site. Make sure that you put the Product in its original packaging or packaging that provides the same amount of protection as the original packaging. To obtain warranty service, in the United States call 1-888-BESTBUY, Canada call 1-866-BESTBUY for Future Shop call 1-800-663-2275. Call agents may diagnose and correct the issue over the phone.

Where is the warranty valid?

This warranty is valid only in the United States and Canada at Best Buy or Future Shop branded retail stores or websites to the original purchaser of the product in the county where the original purchase was made.

What does the warranty not cover?

This warranty does not cover:

- Customer instruction/education
- Installation
- Set up adjustments
- Cosmetic damage
- Damage due to weather, lightning, and other acts of God, such as power surges
- Accidental damage
- Misuse
- Abuse
- Negligence
- Commercial purposes/use, including but not limited to use in a place of business or in communal areas of a multiple dwelling condominium or apartment complex, or otherwise used in a place of other than a private home.

NS-R5111 Arm Band Radio

INSIGNIA™

- Modification of any part of the Product, including the antenna
- Display panel damaged by static (non-moving) images applied for lengthy periods (burn-in).
- Damage due to incorrect operation or maintenance
- Connection to an incorrect voltage or power supply
- Attempted repair by any person not authorized by Insignia to service the Product
- Products sold "as is" or "with all faults"
- Consumables, including but not limited to batteries (i.e. AA, AAA, C etc.)
- Products where the factory applied serial number has been altered or removed
- Loss or Theft of this product or any part of the product
- Display panels containing up to three (3) pixel failures (dots that are dark or incorrectly illuminated) grouped in an area smaller than one tenth (1/10) of the display size or up to five (5) pixel failures throughout the display. (Pixel based displays may contain a limited number of pixels that may not function normally.)
- Failures or Damage caused by any contact including but not limited to liquids, gels or pastes.

REPAIR REPLACEMENT AS PROVIDED UNDER THIS WARRANTY IS YOUR EXCLUSIVE REMEDY FOR BREACH OF WARRANTY. INSIGNIA SHALL NOT BE LIABLE FOR ANY INCIDENTAL OR CONSEQUENTIAL DAMAGES FOR THE BREACH OF ANY EXPRESS OR IMPLIED WARRANTY ON THIS PRODUCT, INCLUDING, BUT NOT LIMITED TO, LOST DATA, LOSS OF USE OF YOUR PRODUCT, LOST BUSINESS OR LOST PROFITS. INSIGNIA PRODUCTS MAKES NO OTHER EXPRESS WARRANTIES WITH RESPECT TO THE PRODUCT, ALL EXPRESS AND IMPLIED WARRANTIES FOR THE PRODUCT, INCLUDING, BUT NOT LIMITED TO, ANY IMPLIED WARRANTIES OF AND CONDITIONS OF MERCHANTABILITY AND FITNESS FOR A PARTICULAR PURPOSE, ARE LIMITED IN DURATION TO THE WARRANTY PERIOD SET FORTH ABOVE AND NO WARRANTIES, WHETHER EXPRESS OR IMPLIED, WILL APPLY AFTER THE WARRANTY PERIOD. SOME STATES, PROVINCES AND JURISDICTIONS DO NOT ALLOW LIMITATIONS ON HOW LONG AN IMPLIED WARRANTY LASTS, SO THE ABOVE LIMITATION MAY NOT APPLY TO YOU. THIS WARRANTY GIVES YOU SPECIFIC LEGAL RIGHTS, AND YOU MAY ALSO HAVE OTHER RIGHTS, WHICH VARY FROM STATE TO STATE OR PROVINCE TO PROVINCE.

Contact Insignia:

www.insigniaproducts.com



INSIGNIA™

NS-R5111 Arm Band Radio



For customer service please call 1-877-467-4289
www.insigniaproducts.com
INSIGNIA is a trademark of Best Buy and its affiliated companies.
Registered in some countries.
Distributed by Best Buy Purchasing, LLC
7601 Penn Ave South, Richfield, MN 55423 U.S.A.
©2014 Best Buy. All rights reserved.
Made in China

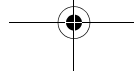
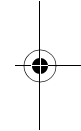
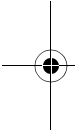



NS-R5111 Arm Band Radio

INSIGNIA™

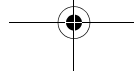
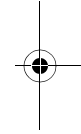
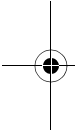

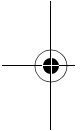

INSIGNIA™

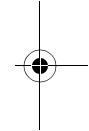

www.insigniaproducts.com
1-877-467-4289 (U.S. and Canada) or 01-800-926-3000 (Mexico)

INSIGNIA is a trademark of Best Buy and its affiliated companies.
Registered in some countries.
Distributed by Best Buy Purchasing, LLC
7601 Penn Ave South, Richfield, MN 55423 U.S.A.
©2014 Best Buy. All rights reserved.
Made in China.

V3 ENGLISH
14-0824

